

# A revision of *Asperula* and *Galium* (Rubiaceae: Rubiaceae) in Australia

Ian R. Thompson

School of Botany, The University of Melbourne, Victoria 3010, Australia;  
Royal Botanic Gardens, Melbourne, South Yarra, 3181, Australia; e-mail: I.Thompson@unimelb.edu.au

## Abstract

Descriptions, keys and distribution maps are presented for 21 native species in *Asperula* sect. *Dioicae*, 19 native and eight introduced species in *Galium*, and for the introduced species *Sherardia arvensis*. In *Asperula* sect. *Dioicae* four new species, *A. acuminata* I.Thomps., *A. hoskingii* I.Thomps., *A. oblanceolata* I.Thomps., and *A. polymera* I.Thomps., and one new subspecies, *A. scoparia* subsp. *subglabra* I.Thomps., are described. *Asperula euryphylla* var. *tetraphylla* Airy Shaw & Turrill is elevated to the rank of species and becomes *A. tetraphylla* (Airy Shaw & Turrill) I.Thomps. In *Galium* seven new species, *G. bulliformis* I.Thomps., *G. bungoniensis* I.Thomps., *G. leiocarpum* I.Thomps., *G. leptogonium* I.Thomps., *G. microlobum* I.Thomps., *G. polyanthum* I.Thomps., and *G. spathulatum* I.Thomps., and five new subspecies, *G. binifolium* subsp. *conforme* I.Thomps., *G. ciliare* subsp. *terminale* I.Thomps., *G. migrans* subsp. *inversum* I.Thomps., *G. migrans* subsp. *trichogynum* I.Thomps., and *G. gaudichaudii* subsp. *parviflorum* I.Thomps., are described. *Galium albescens* Hook.f. and *G. densum* Hook.f. are resurrected as species. New Zealand's species of *Asperula* and *Galium* are compared to Australian species, and *Galium perpusillum* (Hook.f.) Allan from New Zealand is returned to *Asperula*.

Muelleria 27(1): 36-112 (2009)



## Introduction

*Galium* and *Asperula* are the two largest genera in tribe Rubieae of the Rubiaceae. Both comprise a few hundred species and are distributed in both hemispheres, predominantly in temperate regions. In Australia before this revision commenced, there were 16 native species recognised in *Asperula* and 11 native species in *Galium*. All of these were considered endemic except for *G. propinquum* A.Cunn. which also occurs in New Zealand. The two genera in Australia are quite similar and, generally speaking, species are delicate, often rhizomatous herbs with quadrangular stems and with leaves and leafy interpetiolar stipules that form pseudowhorls. Flowers are ecalyculate with a 4-lobed corolla and 2-carpellate inferior ovary. In general, species have always been placed in *Asperula* if the corolla-tube is well developed, and into *Galium* if the corolla tube is rudimentary.

In Australia *Asperula* is dioecious, but the apparently unique combination of a well-developed corolla-tube and dioecy did not prompt any early botanists to segregate the Australian *Asperula* into a new genus. As it stands today, corolla-tube morphology has proven to be an imperfect means of segregating taxa into natural groups, and neither *Asperula* nor *Galium* are likely to be monophyletic genera. This idea was reinforced by preliminary molecular work carried out in the mid-1990s. The phylogenetic analysis of Natali *et al.* (1995, 1996) placed an Australian species of *Galium*, named as *G. migrans*, in a robust clade called the *Cruciata* clade comprising widely distributed taxa including some species of *Galium*, but not the type species *G. mollugo*, as well as species of *Valantia*, *Cruciata* and *Rebunium*. Molecular data from an Australian *Asperula* has not yet been obtained. Much further work needs to be done to clarify relationships within the tribe, including the relationships of Australian *Galium* and *Asperula* to their congeners around the world and to each other.

There is evidence of a Gondwanan ancestry for Australia's Rubieae. Australian species of *Galium* are very similar to two New Zealand species, *G. trilobum* Colenso and *G. propinquum* A.Cunn., the South American species *Galium obovatum* Kunth. also appears to be similar based on the description and figures in Dempster (1981), and New Zealand's

*Asperula perpusilla* Hook.f. is very similar to Australian *Asperula*. Several workers, e.g. Mueller (1875) and Airy Shaw and Turrell (1928) have also suggested over the years, quite reasonably in the view of the author, that Australian species of *Asperula* are perhaps closer to *Galium* than to *Asperula sensu stricto*. Airy Shaw and Turrell considered that Australian *Asperula* were at least worthy of separation from European *Asperula* and erected *Asperula* sect. *Dioicae* Airy Shaw & Turrill to accommodate them.

### **Australian taxonomic history**

The taxonomic history of *Asperula* has been relatively straightforward. The earliest descriptions came from Joseph Hooker (1847) who described six species based on Tasmanian material: *Asperula subsimplex* Hook.f., *A. gunnii* Hook.f., *A. scoparia* Hook.f., *A. conferta* Hook.f., *A. pusilla* Hook.f., and *A. minima* Hook.f. Soon after, Mueller described *A. geminifolia* F.Muell. and *Galium geminifolium* F.Muell. (now *A. gemella* Airy Shaw & Turrill), while Miquel described *Rubia syrticola* Miq. (now *A. syrticola* (Miq.) Toelken). Bentham (1867), in *Flora Australiensis*, reduced *A. pusilla* to a variety of *A. gunnii*, described *A. conferta* var. *elongata*, and synonymised *R. syrticola* under *A. scoparia*. In 1875, Mueller proposed a remarkably conservative classification that incorporated all Australian forms with the exception of *A. geminifolia* under the one name, the illegitimate *Asperula oligantha* F.Muell.

In 1928 Airy Shaw and Turrill produced the first detailed revision of the genus and reversed Mueller's conservative approach. As well as resurrecting all of Hooker's species, they described seven new species: *A. ambleia* Airy Shaw & Turrill, *A. asthenes* Airy Shaw & Turrill, *A. cunninghamii* Airy Shaw & Turrill, *A. euryphylla* Airy Shaw & Turrill, *A. subulifolia* Airy Shaw & Turrill, *A. wimmerana* Airy Shaw & Turrill, and *A. lissocarpa* Airy Shaw & Turrill. In addition, *Galium geminifolium* was renamed as *A. gemella* and *A. conferta* var. *elongata* was elevated to species rank as *A. charophyton*. Eight infraspecific taxa were also described; however, with the exception of *A. euryphylla* var. *tetraphylla*, these names were not subsequently utilised by Australian workers. *Asperula lissocarpa* proved to be the same taxon as *Rubia syrticola* Miq., and was renamed in 1986 as *A. syrticola* (Miq.) Toelken.

The taxonomic history of *Galium* has been more complex. The first Australian species described were *G. gaudichaudii* DC. and *G. australe* DC. by Augustin de Candolle in 1840. Joseph Hooker contributed six species in 1847 based on Tasmanian material: *G. vagans* Hook.f., *G. ciliare* Hook.f., *G. densum* Hook.f., *G. squalidum* Hook.f., *G. albescens* Hook.f., and *G. curtum* Hook.f. In contrast to the species of *Asperula* he described in the same journal, all of which are now accepted, only one species of *Galium*, *G. ciliare*, became adopted through the 20<sup>th</sup> century and even it was sunk into synonymy for a period. *Galium curtum* and Mueller's *G. geminifolium* were transferred to *Asperula*. In the 1850s Miquel described *G. erythrorrhizum* F.Muell. ex Miq. and *G. axiflorum* F.Muell. ex Miq. Bentham (1867) in *Flora Australiensis* recognised five species, described two new varieties, *G. gaudichaudii* var. *glabrescens* Benth. and *G. gaudichaudii* var. *muriculatum* Benth., and reduced *G. squalidum* to varietal rank as *G. australe* var. *piloso-hispidum* Benth.

Mueller (1875), as he did for *Asperula*, proposed a highly conservative classification, and included all Australian native forms under the one name *G. umbrosum* G.Forst. ex Hook.f., a species described from New Zealand and illegitimately named. Although Mueller's classification was largely followed in subsequent years, *G. australe* was generally maintained as distinct, while Ewart (1931) maintained *G. gaudichaudii*. The next significant publication was by Wakefield (1955) who described two new species, *G. binifolium* N.A.Wakef. and *G. liratum* N.A.Wakef. Also in this paper, which was essentially based on Victorian material, the name *G. propinquum* A.Cunn. was introduced into Australian taxonomic literature to replace the illegitimate *G. umbrosum*. *Galium ciliare* was treated as a synonym of *G. propinquum* by Wakefield. The introduced species *G. divaricatum* Lam. enjoyed a period of recognition as a native taxon under the name *G. parisiense* var. *australe* Ewart & Jean White. In her treatment of Tasmania's Flora, Curtis (1966) resurrected *G. albescens*.

The first detailed revision of Australian *Galium* was undertaken by McGillivray in 1983, in which 11 species were recognised. The four new species were *G. terrae-reginae* Ehrend. & McGill., *G. compactum* Ehrend. &

McGill., *G. roddii* Ehrend. & McGill., and *G. curvihirtum* Ehrend. & McGill. *Galium ciliare* was resurrected as was *G. erythrorrhizum* but with a new name, *G. migrans* Ehrend. & McGill. *Galium albescens* was treated as synonymous with *G. australe*.

In this paper, *Asperula* sect. *Dioicae* and Australian species of *Galium* are further revised, with comparisons made to related New Zealand taxa. Additionally, descriptions, keys and maps for introduced species of *Galium* and *Sherardia* in Australia are presented.

## Materials and Methods

Herbarium specimens from AD, BRI, CANB, HO, MEL, and NSW were examined. Field observations and collections made in Victoria and New South Wales supplemented this data. Morphological assessment of these collections led to the development of a revised taxonomy presented below.

## Tribe Rubieae: a circumscription based on Australian taxa

Erect, sprawling or prostrate, *annual or perennial herbs*, or occasionally subshrubs, sometimes dioecious, often rhizomatous. *Indumentum* of simple hairs or scabrosities. *Stems* quadrangular with angles slender or broadened. Whorls 4–8(–9)-partite\*, or occasionally 2-partite (stipules absent); stipules interpetiolar, more or less identical to leaves or of similar shape but smaller. *Leaves and stipules* simple, entire, mostly 1–25 mm long. *Inflorescences* predominantly with cymose partial inflorescences showing monochasial and dichasial branching in varying degrees. *Flowers* bisexual or functionally unisexual; subsessile to pedunculate; calyx absent except in *Sherardia*; corolla valvate, predominantly 4-lobed, but often a small proportion of flowers 5-lobed, with tube very short to very long; stamens 4, with anthers dorsifixed on short fine filaments; ovary inferior, 2-locular; ovules 1 per loculus; style bifid, with arms generally shorter than unbranched portion; stigmata more or less capitate. *Fruit* comprising 2 mericarps, or 1 if only one carpel fertilised, with mericarps separating from each other or not, dry to moderately fleshy.

\*In this treatment, the term whorl is used to describe the two opposite leaves plus the leaf-like interpetiolar stipules. Thus a 5-partite whorl has a

single stipule between the leaves on one side and two stipules between the leaves on the other. It is probably technically correct to describe these whorls as pseudowhorls; however, Bremekamp (1966) considers all the parts of whorls in tribe Rubieae to be leaves.

Tribe Rubieae is placed in subfamily Rubioideae and, based on several molecular synapomorphies including a 50-bp deletion, the tribe as currently circumscribed is likely to be monophyletic (Natali *et al.* 1996). It currently comprises 12 genera including *Asperula*, *Callipeltis*, *Crucianella*, *Cruciata*, *Didymaea*, *Galium*, *Phuopsis*, *Relbunium*, *Rubia*, *Sherardia*, and *Valantia*. In Australia there are three genera, *Galium*, *Asperula* and *Sherardia*. *Galium* is represented by both native and introduced species, with all native species endemic and morphologically well separated from the introduced species. *Asperula* is represented by native species only and all are members of sect. *Dioicae*. *Sherardia* is represented by a single introduced species, *S. arvensis* L.

A key to identifying species in the Rubieae in Australia commences below with a key to groups. For the two major groups, *Asperula* sect. *Dioicae* and native *Galium*, in addition to couplet 3 below, a summary of distinctions is presented in Table 1.

### 1. *Asperula* L., *Sp. Pl.* 1: 103 (1753)

*Asperula* sect. *Dioicae* Airy Shaw & Turrill, *Bull. Misc. Inform. Kew* 1928(3): 82 (1928).

*Dioecious perennial herbs*, sometimes becoming woody towards base, generally extensively rhizomatous; rhizomes slender with a papery bark, sometimes thickening and becoming woody. *Indumentum* of stems and leaves comprising hairs, scabrosities or rarely papillae, predominantly uniform within species. *Aerial stems* slender with first year growth to 1.2 mm diam., sometimes subsequently thickening and developing a corky fissuring bark; angles mostly slender, occasionally moderately to very broad; whorls 2–8-partite, with a slight tendency to increase in numbers upwards; stipules mostly equal to leaves, occasionally shorter, with relative size not changing significantly upwards. *Leaves* sometimes with a prominent terminal hair; upper surface often with a pale patch at or near apex, with midrib generally not or hardly defined; lower surface lacking glandular cells, with midrib variably conspicuous, glabrous or with hairs confined to midrib.

## Key to genera

\* designates introduced. *Asperula arvensis* is not considered naturalised (see notes under *Asperula* sect. *Dioicae*).

1	Corolla-lobes blue or pink adaxially and less than half of length of tube .....	2
1:	Corolla-lobes white, pale yellow, cream, greenish-cream or purplish adaxially and c. equal to or longer than tube .....	3
2	Calyx absent; corolla-lobes blue adaxially; bract margins with hairs 1–2 mm long .....	* <i>Asperula</i> ( <i>A. arvensis</i> )
2:	Calyx present; corolla-lobes pink adaxially; bract margins lacking hairs 1–2 mm long .....	3.* <i>Sherardia</i> ( <i>S. arvensis</i> )
3	Plants dioecious (but reduced organs of non-functional sex present in all flowers); corolla-tube mostly > 0.5 mm long, and if not then style ≥ 0.8 mm long .....	1. <i>Asperula</i> sect. <i>Dioicae</i>
3:	Plants hermaphrodite; corolla-tube < 0.5 mm long .....	4
4	Whorls of stems predominantly 5 or more-partite .....	2b. * <i>Galium</i>
4:	Whorls of stems maximally 4-partite (very rarely 1 or 2 whorls with more parts) .....	5
5	Corolla snow-white adaxially, with lobes ≥ twice length of ovary .....	2b. * <i>Galium</i> ( <i>G. palustre</i> )
5:	Corolla pale yellow, cream, dull-white, greenish or purplish adaxially, with lobes < twice length of ovary .....	6
6	Cymes not subtended by a leaf; corolla-lobes < 1/2 length of ovary; mericarps > twice as long as broad .....	2b. * <i>Galium</i> ( <i>G. murale</i> )
6:	Cymes subtended by a leaf; corolla-lobes > 1/2 length of ovary; mericarps < twice as long as broad .....	2a. <i>Galium</i>

*Inflorescences* short, terminating after 1 or 2 nodes, but often growing-on from terminal cymes producing pseudoaxillary cymes; cymes with flowers few to many, with overtopping generally absent or slight; bracts usually forming a whorl at primary node. *Flowers* functionally unisexual, with structures of non-functional sex present but reduced in size; corolla mostly with a distinct tube, white; ovary glabrous or rarely with short-lived minute hairs. *Male flowers*: corolla 1.5–6 mm long, with tube a little shorter to a little longer than lobes; anthers 0.2–0.9 mm long. *Female flowers*: corolla 0.8–3 mm long, with tube slightly to much shorter than lobes; ovary glabrous, smooth or with epidermal cells producing a bulliform appearance; style 0.8–3 mm long; stigmata generally 3–5 times broader than style-arms. *Fruit* on straight peduncles, with mericarps not separating from one another; mericarps c. broad-ellipsoid, 1.5–3 mm long, c. 1–1.5 mm wide, pericarp generally fleshy, broadly rugose on drying.

**Distribution:** *Asperula* sect. *Dioicae* occurs predominantly in the south-eastern quarter of Australia, with a few species occurring as far north as Rockhampton in central-eastern Queensland. The section is represented in New Zealand by *A. perpusilla*.

**Notes:** *Asperula arvensis* L. (sect. *Asperulae*), native to Europe, has been recorded for Australia in the past, but

there is no indication that it is or ever was naturalised. It differs greatly from species in sect. *Dioicae* and more closely resembles *Sherardia arvensis* L.

*Asperula* sect. *Dioicae* forms a moderately uniform group. It is quite uniform in terms of its dioecy, general floral structure, and mericarp size and fleshiness. The most useful characters taxonomically include the numbers of parts per whorl, development of woodiness in lower stems and rhizomes, indumentum type and density, and corolla length. Useful foliar characters include shape, orientation, arching and apex morphology.

Table 1 (p. 40) provides a summary of those characters that can help to distinguish this group from native species of *Galium*.

#### Notes on morphology

**INDUMENTUM** (Fig. 1): Much of the variation in stem-angle indumentum is presented in Fig. 1b. Appreciation of the nature of this variation is critical to being able to identify species of *Asperula*.

**LEAVES** (Fig. 2): The shape of the leaf-apex and presence and length of terminal hairs at the apex can be important taxonomically, particularly in discriminating *A. conferta* from *A. scoparia*. A small pale patch is often present at the apex on the upper surface; it has limited taxonomic value within *Asperula* but will help to

**Table 1.** Points of distinction between *Asperula* sect. *Dioicae* and Australian *Galium*.

<i>Asperula</i> sect. <i>Dioicae</i>	Australian <i>Galium</i>
1. Indumentum often relatively constant in density and type within a species	1. Indumentum variable in density and often of two types in a species or even on one plant
2. Whorls (2–)4–6(–8)-partite (often with some variation within species and within plants)	2. Whorls 4-partite (rarely a few whorls 5 or 6-partite; sometimes towards termini 2-partite)
3. Whorl parts not reducing in number and sometimes increasing upwards	3. Whorls occasionally reducing to 2-partite towards inflorescence termini
4. Size of stipules relative to leaves generally constant	4. Stipules sometimes becoming proportionately smaller upwards
5. Leaves commonly with a small pale subapical patch on upper surface (variably conspicuous)	5. Leaves lacking pale subapical patch on upper surface
6. Leaves lacking glandular cells on lower surface	6. Leaves with glandular cells on lower surface ( <i>G. liratum</i> and <i>G. spathulatum</i> are exceptions)
7. Inflorescences always short, but sometimes with growing on from terminal cymes to produce pseudoaxillary arrangement	7. Inflorescences extended or occasionally only a few nodes long; growing on from terminal cymes not seen
8. Cymes or partial cymes generally somewhat congested	8. Cymes congested to rather lax
9. Plants dioecious. Flowers functionally unisexual but structures of non-functional sex evident	9. Plants hermaphrodite. Flowers functionally bisexual
10. Whorl of bracts generally developed at primary node of cymes	10. Whorl of bracts not developed or developed in only a small proportion of cymes at primary node
11. Corolla-tube mostly well-developed, longer in male flowers. Mostly 1/3 to 1/2 of total length	11. Corolla-tube hardly developed. Less than 1/4 of total length
12. Corolla snow white on both sides	12. Corolla pale yellow, cream, greenish-cream or green, or purplish, the same or purplish-red abaxially
13. Style $\geq 0.8$ mm long; stigmata and anthers relatively robust	13. Style $< 0.8$ mm long; stigmata and anthers relatively small
14. Fruit mostly 2–3 mm long	14. Fruit mostly 0.8–2 mm long, but up to 2.4 mm long
15. Mericarps apparently not separating from one another. Often only one carpel fertilised	15. Mericarps separating from one another. Common for both carpels to be fertilised (if inbreeding species)
16. Mericarps moderately fleshy	16. Mericarps mostly not or only slightly fleshy
17. Ovaries and fruit glabrous and without ornamentation (rarely a few minute hairs present)	17. Ovaries and fruit often with hairs or pustules

identify sterile specimens as being *Asperula* rather than *Galium*. The prominence of the abaxial midrib (Fig. 2b) can also help to discriminate some species.

**INFLORESCENCES** (Fig. 3): Inflorescences are fundamentally terminal cymes; however, one or both lateral branches of these cymes may grow on vegetatively to varying degrees and overtop the terminus (see example in Fig. 3 xi). This results in pseudoaxillary cymes. Such cymes may appear sporadically to regularly along a stem. In some species terminal cymes also arise from short lateral branches along stems. This appears to be more likely in species developing sprawling stems.

**FLOWERS** (Fig. 4): Male and female flower

morphology is shown in Fig. 4a. A sometimes subtle but useful character for distinguishing species is the shape of the ovary. In a few species the ovary is markedly broader than long. The non-functional ovary of the male flower shown in Fig. 4a i is relatively larger than that seen in species such as *A. geminifolia*.

**1. *Asperula gemella*** Airy Shaw & Turrill, *Bull. Misc. Inform. Kew* 1928(3): 102 (1928)

*Galium geminifolium* F.Muell., *Trans. and Proc. Vict. Inst. Adv. Sci.* 1: 127 (1855); *Galium umbrosum* var. *geminifolium* (F.Muell.) C.Moore & Betche, *Handb. Fl. New South Wales* 253 (1893).

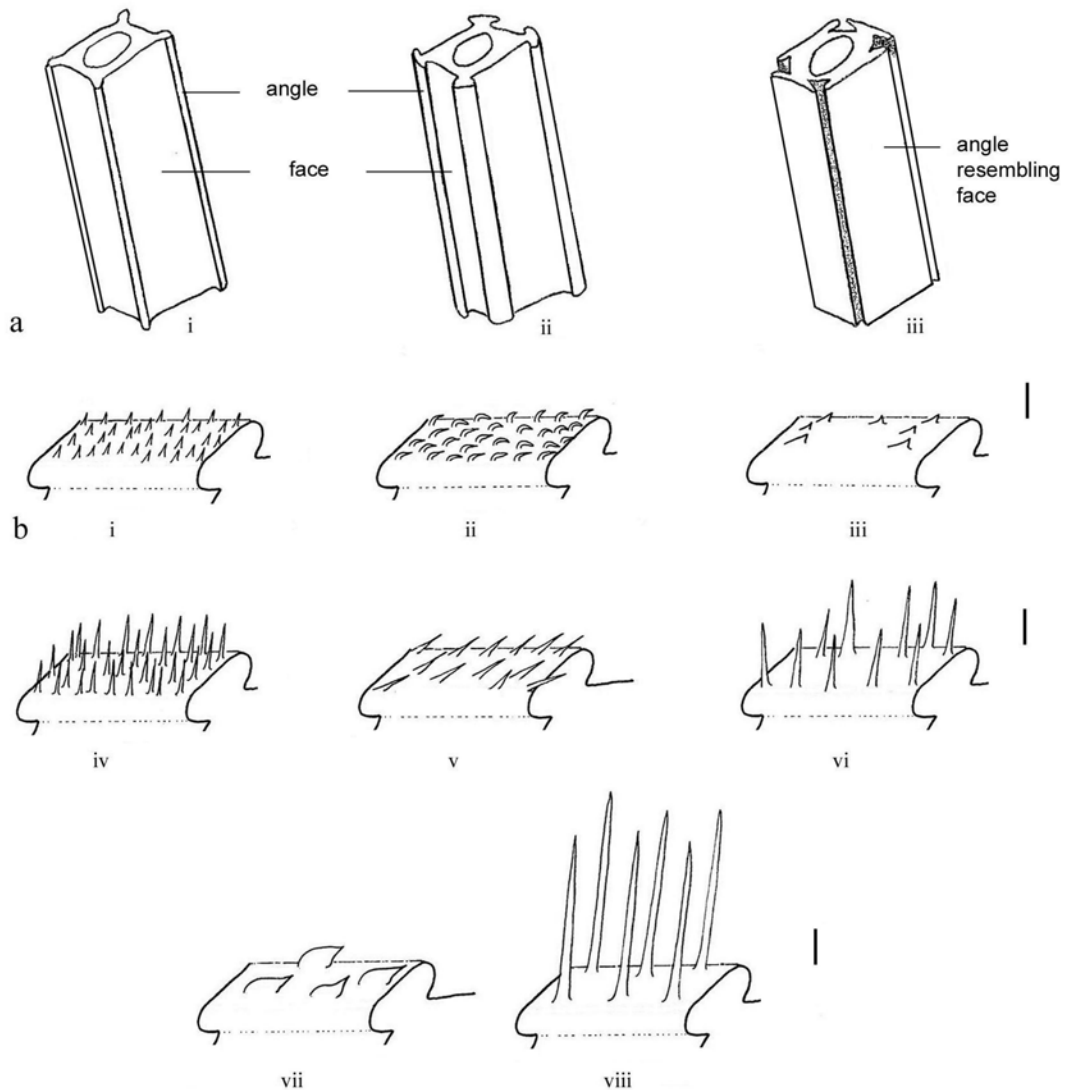

**Figure 1. Stem-angles and indumentum.** a. Stem-angles: i slender; ii. moderately broadened; iii. extremely broadened.

b. Stem indumentum (stem-angle width not necessarily representative): i short fine straight hairs, moderately dense (e.g. *A. euryphylla*); ii. short fine retrorse and recurved hairs, moderately dense (e.g. *A. gunnii*); iii. retrorse scabrosities, scattered (e.g. *A. conferta*, *G. leiocarpum*); iv. long fine spreading hairs, moderately dense (e.g. *A. hoskingii*); v. retrorse straight hairs (e.g. *A. wimmerana*); vi. moderately long spreading hairs (e.g. *G. gaudichaudii*); vii. robust retrorse scabrosities (e.g. *G. liratum*, *G. bulliformis*); viii. very long fine spreading hairs (e.g. *G. leptogonium*). Scale bar for b = 0.1 mm.

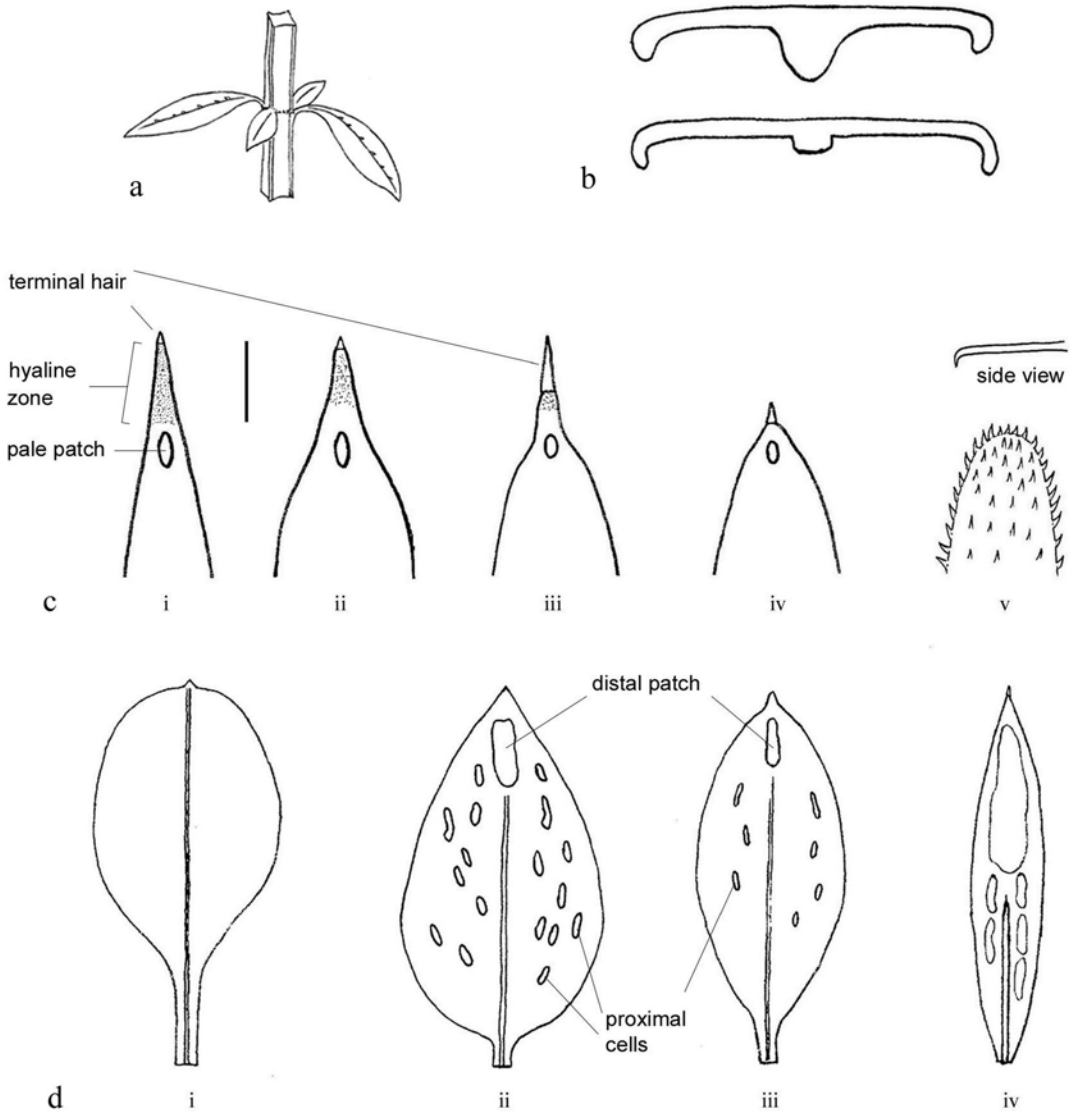
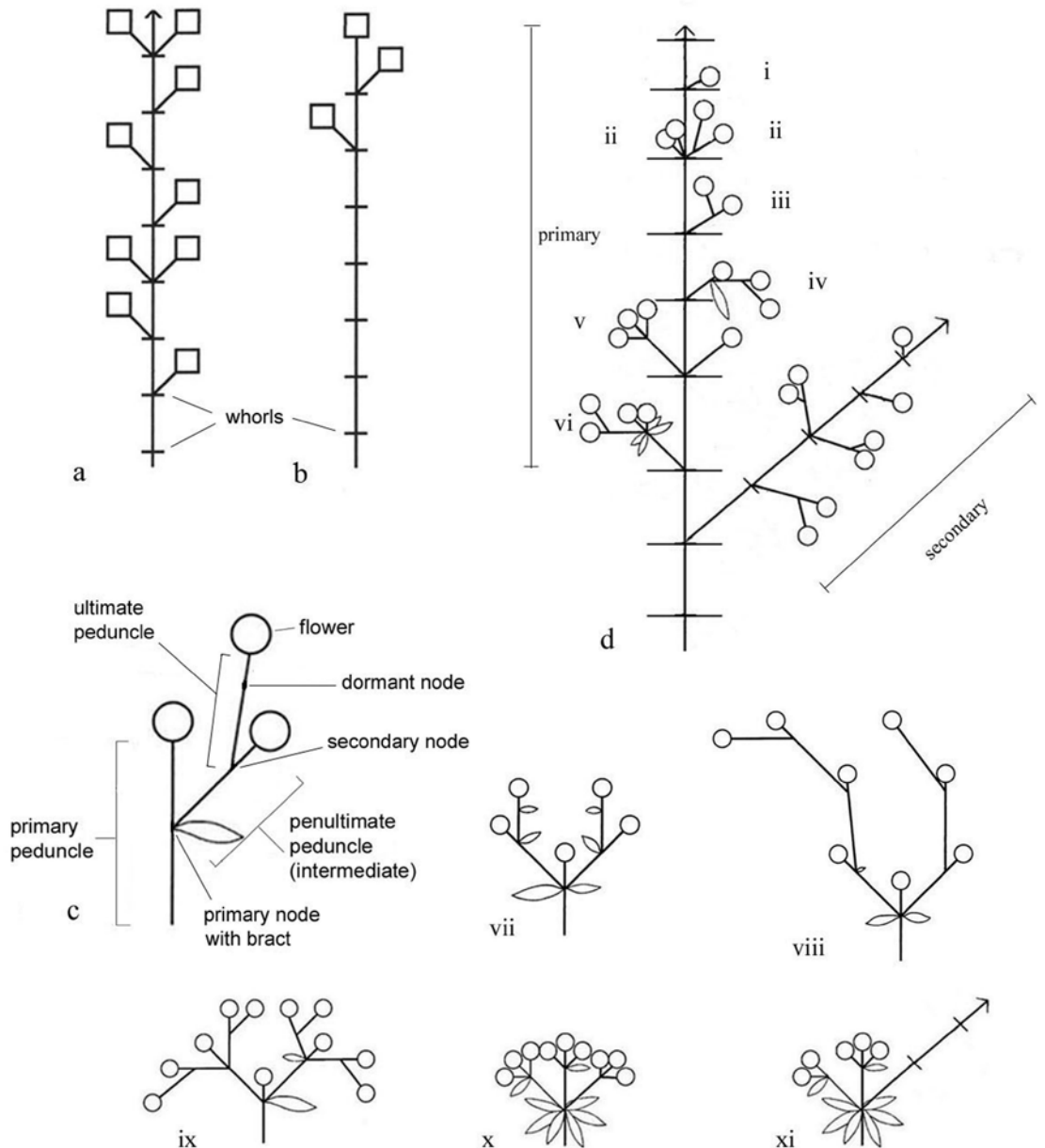

**Figure 2. Leaves.** a. 4-partite whorl (e.g. *Galium binifolium* subsp. *binifolium*; stipules unusually short in this taxon).

b. Transverse section: i. abaxial midrib protruding relative to margins (e.g. in *A. conferta*); ii. abaxial midrib recessed

(e.g. in *A. pusilla*). c. Apex in *Asperula* (adaxial view; hyaline portion shaded) i. *A. scoparia* subsp. *scoparia*, ii. *A. scoparia* subsp. *subglabra*; iii. and iv. *A. conferta* showing extremes of variation; v. *A. pusilla* (nb: hairs and recurved tip). d. Leaf shape and glandular cell pattern in *Galium* (abaxial surface): i. spatulate; glandular cells absent (e.g. *G. spathulatum*); ii. ovate with broad-cuneate base, proximal glandular cells conspicuous (e.g. *G. ciliare*); iii. narrow-elliptic; glandular cells inconspicuous (e.g. *G. leiocarpum* and many other species); iv. very narrow oblong-elliptic, glandular cells extensive (e.g. *G. gaudichaudii*).

Scale bar for c = 0.2 mm.



**Figure 3. Inflorescences and cymes (schematic).** a. Extended type, indeterminate. b. Soon terminating (each box represents a cyme). c. A complex cyme with monocasial branching in *Galium*, displaying cyme terminology. d. Stem bearing a primary and secondary inflorescence. Flowers represented by circles. Cyme variation (i–vi drawn in d.; vii–xi drawn separately): i. Solitary flower; ii. Simple, monocasial, with ultimate peduncle inserted in proximal half or at base (e.g. *G. leiocarpum*); iii. Simple monocasium with ultimate peduncle inserted distally; iv. Complex monocasium with bract at primary node subtending penultimate peduncle (e.g. common in *G. curvihirtum*); v. Simple dichasium (e.g. commonly seen in *G. ciliare* subsp. *ciliare* & *G. australe*); vi. Complex: dichasial then monocasial branching; whorl at first node; vii. Complex: bract at each node including at quiescent nodes on ultimate peduncle (e.g. *G. bulliformis*); viii. Extended monocasial branching (e.g. *G. migrans* subsp. *inversum*); ix. Two dichasial orders of branching (e.g. *G. polyanthum*); x. Whorl at first node, dichasial branching, corymbiform arrangement (typical of *Asperula*); xi. Similar to x. but a shoot growing on from terminal cyme (e.g. *A. pusilla*).



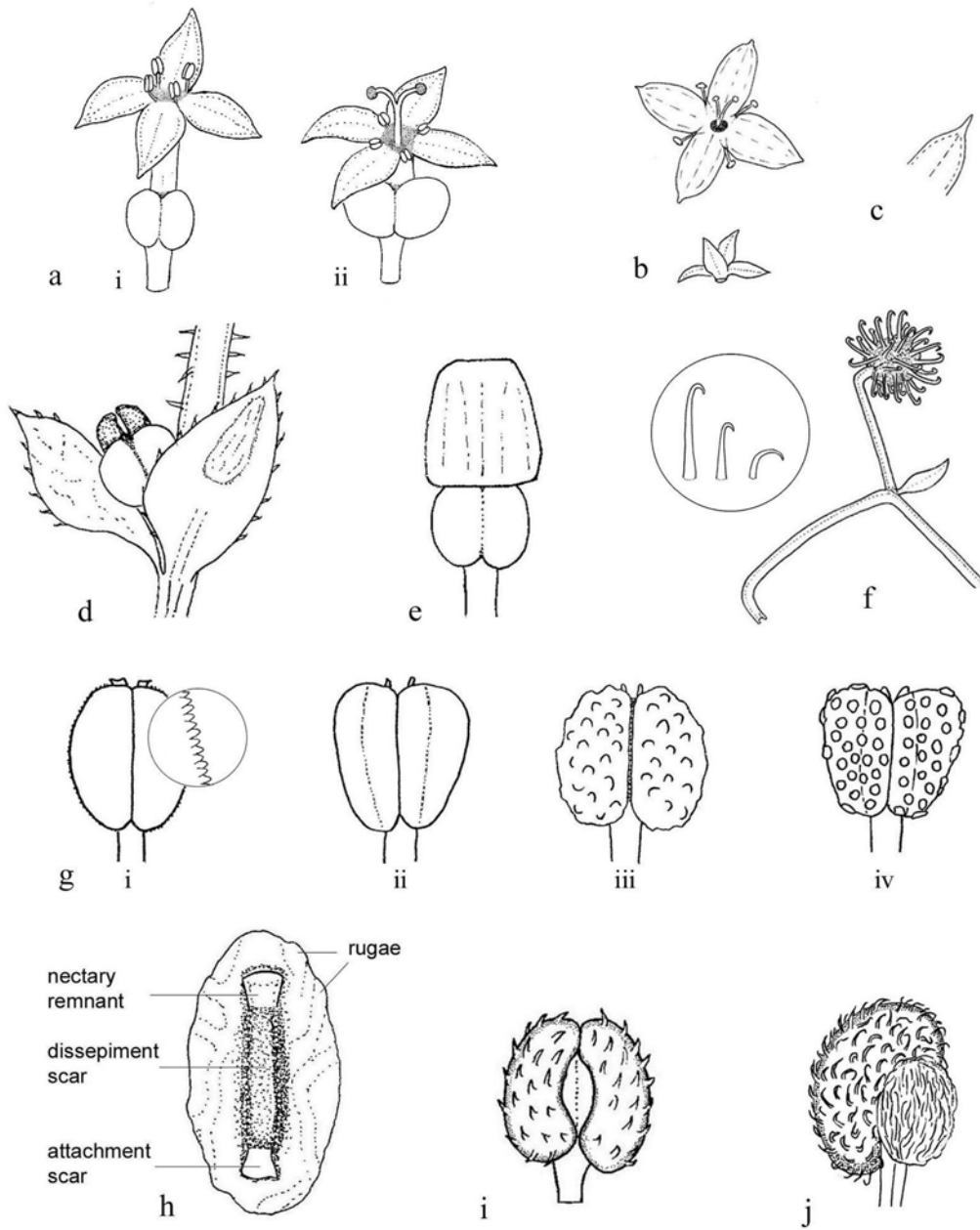

**Figure 4. Flowers and fruit.** a. Flowers in *Asperula* (face view of ovary): i. male flower; ii. female flower, showing a relatively broad ovary with a deep sinus as seen in *A. wimmerana*. b. Flower in *Galium* (view from above and side view of corolla). Note relatively small anthers and stigmata compared to *Asperula*. c. Apiculate corolla-lobe apex (*G. migrans*); d. Flower in axil of *G. microlobum*; corolla full-sized but unopened. e. Flower in late bud (*G. gaudichaudii* subsp. *gaudichaudii*); drawn from pressed specimen so corolla squashed over top of ovary). f. Portion of cyme of *Galium densum*; inset shows close-up of a mericarp hair of *G. densum* (l), and for comparison hairs of *G. australe* (middle) and *G. curvihirtum* (r). g. Ovary/developing fruit (face view): i. taller than broad & papillose (e.g. *G. migrans* subsp. *migrans*) including close-up of edge view of surface; ii. obovoid (e.g. *G. ciliare*); iii. pustular (*G. leptogonium*); iv. pustular (*G. roddii*). h. Mericarp, medial view (*G. compactum*). i. Pair of mericarps (*G. leiocarpum*). j. Mericarp with associated unfertilised carpel (*G. curvihirtum*).

**Type: VICTORIA.** "Rivers Murray and Avoca", F.Mueller, date unknown; lecto: K n.v., *vide* Airy Shaw & Turrill *op. cit.* 103 (1928), image MEL.

*Herbs* with stems to 1 m or more long, sometimes climbing. *Stems* 0.6–1.2 mm diam., dull to sublustrous; internodes to c. 100 mm long, mostly 30–70 mm long; angles narrower than faces, glabrous or with scattered elevations or scabrosities (up to c. 5 per mm of angle); scabrosities retrorse; whorls 2-partite, or 4-partite and then with stipules generally < 30% of leaf length. *Leaves* spreading to pendent, very narrow-elliptic, linear or narrow-linear, mostly 10–60 mm long, 0.7–3(–5) mm wide, with l:w ratio 6–20, tapering gradually basally to be 1/3 to 1/2 of leaf-width at base, tapering gradually distally, generally unarched, thin to slightly fleshy; margin flat, recurved or narrowly revolute, glabrous or with scattered scabrosities; apex acute to very acute, usually without a hyaline extension; terminal hair or hairs < 0.05 mm long; upper surface dull to sublustrous, more or less smooth on drying, with midrib not defined, without acute epidermal projections, glabrous; pale patch absent or obscure; abaxial midrib slender, variably raised, recessed relative to margins, glabrous or with a few hairs. *Cymes* of several or more often numerous flowers, often with 3 or more orders of branching; primary and intermediate peduncles commonly quite elongate; ultimate peduncles mostly subsessile to c. 0.5 mm long. *Flowers*: corolla glabrous; ovary oblate in face view, with sinus deep; male flowers: corolla c. 1.5–2 mm long, with tube c. 0.5–0.7 mm long; filament c. 0.4–0.7 mm long; anthers 0.2–0.3 mm long, c. 2/5–3/4 of filament length; ovary 0.1–0.2 mm long; female flowers: corolla c. 1 mm long, with tube c. 0.2–0.3 mm long; ovary 0.6 mm long; style 0.8–1.2 mm long, with arms vestigial or to c. 0.2 mm long. *Fruit* 2–3 mm long.

*Flowers* mainly spring.

**Selected specimens:** **SOUTH AUSTRALIA.** Cooper Creek toward Coongie, R.J.Bates 47347, 8.vii.1997 (AD); Chowilla region, Murray River, J.Roberts 515, 3.x.1988 (CANB). **QUEENSLAND.** Waterhole at Welford National Park headquarters, D.Hanger 39, 5.ix.2000 (BRI). **NEW SOUTH WALES.** Tom's Lake Station, Marrowie Ck, near shearers' quarters, I.Crawford 339, 29.ix.1985 (CANB, MEL, NSW); Warrego River, Bourke–Wanaaring Road, A.Rodd 1904, 5.xi.1971 (NSW); Peak Hill, Tibooburra, L.R.Richley 1318, 4.x.1973 (NSW). **VICTORIA.** 9 km N of Boundary Bend, A.R.Begg, 20.ix.1963 (AD, CANB, MEL); Cemetery Swamp

Wildlife Reserve, A.C.Beaglehole 80135, 6.ix.1985 (CANB, HO, MEL, NSW); Liparoo State Forest, c. 0.5 km E of Hattah-Kulkyne National Park boundary, N.G.Walsh 2577, 13.ix.1986 (BRI, CANB, MEL).

**Distribution and habitat:** Occurs in arid and semiarid regions of eastern Australia including south-western Queensland, eastern South Australia, western New South Wales and north-western Victoria. Occurs in parts of the Lake Eyre and Murray–Darling basins, and follows the Murray River to its mouth (Fig. 5). Grows in clay soils, in shrubland and woodland, usually near water.

**Notes:** *Asperula gemella* typically becomes extensively branched, more so than in other herbaceous species of *Asperula* sect. *Dioicae*, and often becomes tangled among plants of *Muehlenbeckia florulenta* Meisn. (Tangled Lignum). Compared to other species in *Asperula* sect. *Dioicae*, cymes of *A. gemella* are complex and corolla-tubes are short, the latter feature prompting its original placement in *Galium* by Mueller. It develops a stout rhizome (to c. 2 mm diam. in Eichler 18374 AD) and tends to lose leaves with age. The surface of mericarps are conspicuously bulliform, a feature it shares with *A. geminifolia* and *A. asthenes*. These three species are also similar in having rather long leaves, relatively few and reduced stipules, very short ultimate peduncles, ovaries much broader than long, and male plants having flowers with relatively small ovaries.

A specimen from Cooper Creek in the Lake Eyre region of South Australia (R.J.Bates 47347 AD) has exceptionally large leaves but otherwise is typical of the species. It is possible that such large leaves represent first season's growth and that, although they occur frequently, they are often lost early and so not seen in most collections.

## 2. *Asperula geminifolia* F.Muell., *Fragm.* 5: 147 (1866)

**Type: QUEENSLAND.** Mt Brisbane, L.Leichhardt, 28 October 1843; lecto (here designated): MEL. [Locality determined by reference to Blake (1954)]

*Herbs* with stems to c. 1 m long, sometimes climbing. *Stems* 0.3–0.8 mm diam., sublustrous; internodes to 90 mm long, mostly 15–60 mm long on branches; angles much narrower than faces, with scattered scabrosities (up to c. 10 per mm of angle); scabrosities strongly retrorse; whorls 2-partite or less often 4-partite, and

Key to species of *Asperula*

1	Whorls all or a majority 2-partite or 4-partite .....	2
1:	Whorls all or a majority 5- or more partite .....	9
2	Stipules < 3/4 of leaf length or absent .....	3
2:	Stipules > 3/4 of leaf length .....	6
3	Stipules absent or < 10% of length of leaves .....	4
3:	Stipules > 20% of length of leaves .....	5
4	Corolla-tube c. 1/3–1/5 of length of lobes (west of longitude 146°) .....	1. <i>A. gemella</i>
4:	Corolla-tube equal to or longer than lobes (east of longitude 149°) .....	2. <i>A. geminifolia</i>
5	Trailing herbs; leaves spreading, narrow-spathulate (north coast of New South Wales).....	3. <i>A. asthenes</i>
5:	Subshrubs (becoming woody basally); leaves erect, narrow-oblong to linear .....	7. <i>A. ambleia</i>
6	Leaves with l:w ratio < 2.5 (Kangaroo Is., South Australia) .....	17. <i>A. tetraphylla</i>
6:	Leaves with l:w ratio > 2.5 .....	7
7	Stem-angles with recurved hairs, with indumentum moderately dense or occasionally sparser and restricted to near nodes; apical pale patch on upper surface of leaves conspicuous .....	18. <i>A. gunnii</i>
7:	Stem-angles glabrous or with a sparse indumentum of non-recurved hairs; apical pale patch on upper surface of leaves absent or obscure .....	8
8	Leaves with l:w ratio 3–10, dull, terminal hair solitary, < 0.1 mm long .....	4. <i>A. subsimplex</i>
8:	Leaves with l:w ratio 2.5–4, sublustrous, terminal hair often with 1–3 adjacent hairs and these hairs usually > 0.1 mm long (New Zealand) .....	<i>A. perpusilla</i> (see 4.)
9	Leaves with an almost pungent hyaline tip 0.2–0.5 mm long <u>and</u> with a terminal hair, if present, only adding c. 0.05 mm to this (magnification needed to identify the apex-hair articulation) .....	13. <i>A. scoparia</i>
9:	Leaves with hyaline tip absent or < 0.2 mm long, or if rarely slightly longer then a terminal hair present that is 0.1–0.3 mm long .....	10
10	Leaves of stems and major branches > 10 mm long <u>and</u> with a l:w ratio > 10.....	5. <i>A. charophyton</i>
10:	Leaves < 10 mm long or, if longer, with a l:w ratio < 10 .....	11
11	Stem indumentum both moderately dense (generally > 30 fine hairs per mm of angle) and short (hairs not extending more than 0.1 mm out from surface) .....	12
11:	Stem indumentum absent or sparser than above, or if somewhat dense then hairs coarse (broad-based) and/or extending more than 0.1 mm out from surface .....	18
12	Leaves and stipules sub-erect to erect, ≤ 1 mm wide; plants becoming woody at base with spongy fissuring bark ...	13
12:	Leaves and stipules generally spreading, usually largest ones > 1 mm wide; plants not becoming woody at base or developing spongy fissuring bark .....	14
13	Stem hairs straight; faces of stems generally much narrower than angles; apex of leaves narrowly acute to filiform.....	8. <i>A. subulifolia</i>
13:	Stem hairs generally curving retrorsely; faces of stems generally as broad as or broader than angles; apex of leaves rounded to acute.....	6. <i>A. cunninghamii</i>
14	Leaves acuminate (far north-eastern New South Wales) .....	16. <i>A. acuminata</i>
14:	Leaves not acuminate .....	15

15 Stem-hairs retrorsely curved.....	18. <i>A. gunnii</i>
15: Stem-hairs ± straight.....	16
16 Leaves to 1.8 mm wide, plants typically drying very dark brown; hairs needle-like in profile.....	19. <i>A. pusilla</i>
16: Largest leaves mostly > 2 mm wide; plants drying green; hairs generally narrow-triangular in profile .....	17
17 Leaves narrow-cuneate, < 1.5 mm wide 3 mm from base, with l:w ratio 4–10; larger stems usually with at least one whorl 7- or 8-partite; anthers > 0.5 mm long (male plants); style 2–2.2 mm long (female plants) .....	14. <i>A. polymera</i>
17: Leaves cuneate, > 1.5 mm wide 3 mm from base, with l:w ratio 2–5; stems usually with all whorls 6-partite; anthers ≤ 0.5 mm long (male plants); style 1.2–1.8 mm long (female plants) .....	15. <i>A. euryphylla</i>
18 Stem-angles with a moderately dense indumentum of ± spreading hairs > 0.2 mm long; upper surface of leaves with hairs > 0.2 mm long .....	19
18: Stem-angles with indumentum either sparse, or hairs not spreading, or hairs < 0.2 mm long; upper surface of leaves glabrous or with hairs to c. 0.1 mm long .....	20
19 Leaves and stipules ascending (serpentinite, north-eastern New South Wales) .....	9. <i>A. hoskingii</i>
19: Leaves and stipules generally spreading.....	19. <i>A. pusilla</i>
20 Leaves tapering mildly basally (base ≥ 1/2 of maximum width), with abaxial midrib robust and tending to protrude relative to margins; upper surface of leaves glabrous or rarely with hairs in proximal half; ovary commonly broader than long (face view) .....	21
20: Leaves tapering moderately to strongly basally (base < 1/2 of maximum width), with abaxial midrib generally slender and recessed relative to margins; upper surface of leaves often with scattered minute hairs, particularly distally; ovary commonly slightly longer than broad (face view) .....	23
21 Leaves and stipules weakly angled forwards, spreading or pendent, not arching towards stem; upper surface usually with a smooth medial glossy strip .....	12. <i>A. conferta</i>
21: Leaves and stipules strongly angled forwards and arching towards stem (more so in dried specimens); upper surface lacking a glossy strip .....	22
22 Whorls usually maximally 7- or 8-partite; ovary of female plants < 1.5 times broader than long; mericarps < 2 mm long (Flinders Ranges, South Australia).....	10. <i>A. syrticola</i>
22: Whorls maximally 6-partite; ovary of female plants > 1.5 times broader than long; mericarps > 2 mm long.....	11. <i>A. wimmerana</i>
23 A proportion of leaves with apex recurved or rolled under or obtuse to rounded; leaves generally nearly parallel-sided; abaxial midrib, if hairy, with narrow-based hairs; cymes congested with ultimate peduncles generally < 1 mm long .....	19. <i>A. pusilla</i>
23: Leaves with apex not recurved, subacute to acute; leaves usually distinctly narrow-elliptic or oblanceolate; abaxial midrib, if hairy, with broad-based hairs; cymes slightly lax with ultimate peduncles commonly > 1 mm long .....	24
24 Upper surface of leaves with scattered minute hairs; leaves predominantly < 0.7 mm wide; corolla-tube of female flowers < 0.5 mm long .....	21. <i>A. minima</i>
24: Upper surface of leaves glabrous or with only a few hairs; leaves predominantly > 0.7 mm wide; corolla-tube of female flowers > 0.5 mm long.....	25
25 Minute retrorsely curved hairs not present at nodes; leaves thin, usually at least some with a prominent terminal hair 0.1–0.3 mm long.....	20. <i>A. oblanceolata</i>
25: Minute retrorsely curved hairs usually present at nodes; leaves slightly thickened, with terminal hair absent or < 0.1 mm long .....	18. <i>A. gunnii</i>

then with stipules < 10% of leaf length. *Leaves* on stems and long branches, spreading to pendent, very narrow-elliptic, linear or narrow-linear, 10–50 mm long, 0.7–3 mm wide, with l:w ratio 6–20, tapering gradually basally to be 1/3 to 1/2 of leaf-width at base, tapering gradually distally, generally unarched, thin; margin flat, recurved or narrowly revolute, glabrous; apex very acute, terminal hair or hairs c. 0.05 mm long; upper surface sublustrous, more or less smooth on drying, with midrib not defined, without acute epidermal projections, glabrous or with a few to numerous antrorse hairs or scabrosities; pale patch absent or obscure; abaxial midrib slender, raised for much of length, recessed relative to margins, glabrous; leaves on short inflorescence branches erect, 1–10 mm long. *Cymes* of several to numerous flowers; primary and sometimes intermediate peduncles quite elongate; ultimate peduncles subsessile to c. 0.5 mm long. *Flowers*: corolla glabrous; ovary markedly oblate in face view, with sinus moderately deep; male flowers: corolla c. 3–4 mm long, with tube 2–2.5 mm long; anthers c. 0.6 mm long, longer than the filament; ovary c. 0.3 mm long; female flowers: corolla c. 1–2 mm long, with tube 0.4–1.0 mm long; ovary c. 0.7 mm long; style 1.0–2.0 mm long, with arms 0.2–0.7 mm long. *Fruit* c. 2 mm long.

*Flowers* spring.

**Selected specimens:** **QUEENSLAND.** Dawson River crossing, 2.4 km W of Theodore-Cracow Rd along Isla Delusion Rd, *D.A.Halford Q8692 & G.N.Batianoff*, 2.xi.2004 (BRI, MEL); Dundas area, N of Ferndale, *A.R.Bean 15540*, 2.x.1999 (BRI, MEL); 12.6 km along Boondandilla Rd, W of Milmeran, *A.R.Bean 13910*, 4.x.1998 (BRI, MEL, NSW); Indooroopilly, Brisbane, *L.Pedley 4165*, 25.x.1974 (BRI, CANB). **NEW SOUTH WALES.** Just to the E of the junction of Whitemans Creek and Whitemans Creek bridge on Copmanhurst Road, c. 25 km NE of Grafton, *G.Patrick*, 30.ix.1999 (NSW).

**Distribution and habitat:** Occurs in south-eastern Queensland and north-eastern New South Wales (Fig. 5). Grows in clay soils and in sedimentary rock in woodland and forest. Often associated with *Geijera parviflora* Lindl.

**Notes:** Often noted as scrambling among grasses or trailing down rock faces. Apart from its floral morphology *A. geminifolia* is very similar to *A. gemella* q.v.

**3. *Asperula asthenes*** Airy Shaw & Turrill, *Bull. Misc. Inform. Kew* 1928(3): 99 (1928)

**Type:** **NEW SOUTH WALES.** Bulladelah, *H.M.R.Rupp*, October 1923; holo: K, images MEL; iso: NSW.

*Herbs* with stem to c. 1 m long, often climbing. *Stems* 0.5–1.2 mm diam., sublustrous; internodes to 70 mm long, mostly 15–40 mm long on branches; angles much narrower than faces, glabrous or with scattered scabrosities (up to c. 6 per mm of angle); scabrosities plump, strongly retrorse; whorls 4-partite, with stipules mostly 25–70% of leaf length. *Leaves* spreading to pendent, very narrowly spatulate, mostly 8–35 mm long, 1–5(–8) mm wide, with l:w ratio 3–7, tapering gradually and strongly basally to be petiole-like (1/5–1/10 of leaf-width) at base, tapering gradually distally, unarched, thin; margin flat, recurved or narrowly revolute, glabrous or with a few hairs proximally; apex acute to obtuse; terminal hair or hairs c. 0.05 mm long if present; upper surface generally more or less dull, more or less smooth on drying, with midrib weakly defined, without acute epidermal projections, glabrous or with several to numerous very short antrorse hairs; pale patch elliptic, c. 0.2 mm long, not rimmed by purple pigment, often obscure; abaxial midrib slender, raised for much of length, recessed relative to margins, with a few broad-based hairs mostly proximally. *Cymes* of several to numerous flowers; primary and sometimes intermediate peduncles quite elongate; ultimate peduncles of complex cymes subsessile to c. 0.5 mm long. *Flowers*: corolla glabrous; ovary slightly oblate in face view, with sinus moderately deep; male flowers: corolla 2–2.5 mm long, with tube c. 1–1.2 mm long; anthers 0.4–0.5 mm long, c. equal to the filament; ovary c. 0.3 mm long; female flowers: corolla c. 1 mm long, with tube 0.5 mm long; ovary 0.5 mm long; style 1.0–1.2 mm long, with arms c. 0.2 mm long. *Fruit* c. 2 mm long.

*Flowers* spring.

**Selected specimens:** **NEW SOUTH WALES.** Along banks of Kellys Creek, Girvan Area, 21 km SW of Bulahdelah, *G.Patrick s.n.*, 1997 (NSW); Wilson River Picnic Area, Mount Boss State Forest, *W.Chapman*, s.d. (NSW); Manning River, *C.Moore*, s.d. (NSW); Hasting River, *H.Beckler*, s.d. (1800s) (MEL); Newcastle, *L.Leichhardt*, 1842–48 (MEL); Wallis Island, *L.Gilbert*, 19.x.1947 (AD).

**Distribution and habitat:** Occurs in north-eastern New South Wales between Bulahdelah and Port Macquarie (Fig. 5). Grows in moist sites such as river banks, intermittently flooded lowlying sites, in

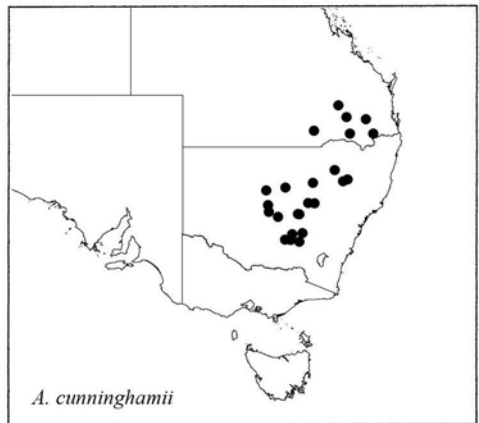
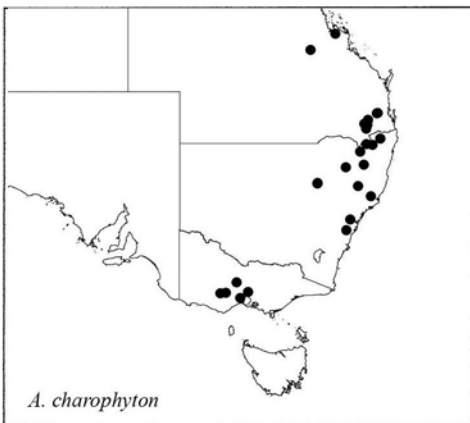
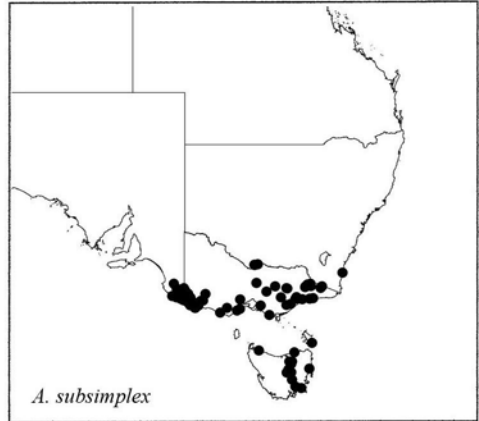
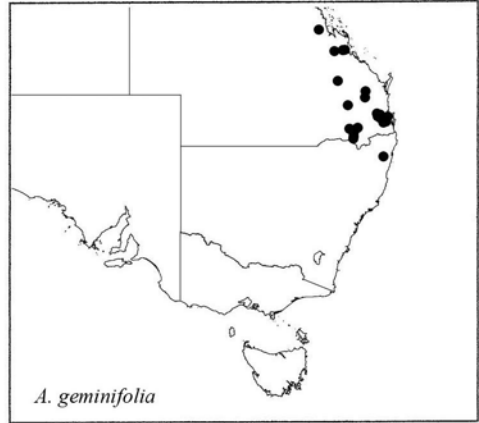
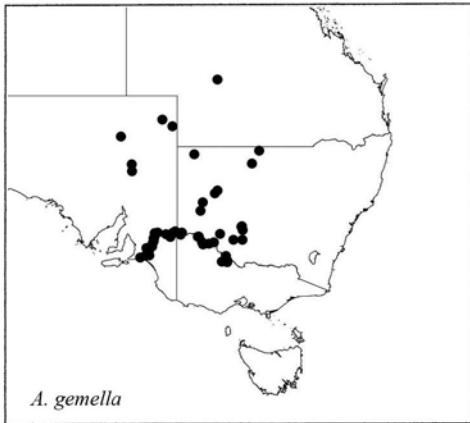

**Figure 5.** Distributions of *Asperula gemella*, *A. geminifolia*, *A. asthenes*, *A. subsimplex*, *A. charophyton*, *A. cunninghamii*.

rainforest and *Melaleuca quinquenervia* (Cav.) S.T.Blake forest, near the coast.

**Notes:** A weak, lax herb of moist sites. Hairs of stems and the abaxial midrib of leaves are characteristically very broad-based. Closely related to *A. gemella* and *A. geminifolia* q.v. Listed as a ROTAP species with Risk Code 3VC- (Briggs & Leigh 1996).

**4. *Asperula subsimplex* Hook.f., in W.J.Hooker, London J. Bot. 6: 463 bis (1847)**

**Type:** TASMANIA. Circular Head, R.C.Gunn 407, 25 December 1837; holotype: K, images MEL.

*A. subsimplex* f. *aquatica* Airy Shaw & Turrill, Bull. Misc. Inform. Kew 1928(3): 93 (1928). Type: Victoria: Wendee (Wandoo) River, [near Casterton], Robertson 694, 1844 [?1 Dec.]; holotype: K, images MEL.

*Herbs* with stems to c. 30 cm long. *Stems* 0.2–0.6 mm diam., dull to sublustrous; often sparingly branched; internodes to 50 mm long, mostly 3–20 mm long on branches; angles much narrower than faces, glabrous or with few hairs (usually no more than a few per mm of angle); hairs spreading, 0.05–0.1 mm long, straight or slightly recurved; whorls 4-partite, with stipules c. equal to leaf length but reducing slightly to moderately upwards to be shorter than leaf-length. *Leaves* spreading or at first angled upwards, narrow-elliptic, oblanceolate or linear, 2–10 mm long, 0.4–1.2 mm wide, with l:w ratio 3–10, tapering gradually to base to be 1/2–3/4 of leaf-width at base; gradually tapering distally, fairly thin; margin flat, recurved or narrowly revolute, glabrous or hairs few; apex acute, sometimes with a minute apiculum; terminal hair to 0.1 mm long; upper surface dull, smooth, with midrib not defined, without acute epidermal projections, glabrous or with a few to several minute hairs near margins; pale patch c. 0.1 mm wide, with l:w ratio 1–2, sometimes indistinct; abaxial midrib slender, raised for much of length approximately to level of margins, glabrous or with hairs few. *Cymes* of 1–3(–5) flowers; primary and intermediate peduncles sometimes mildly elongate; ultimate peduncles of complex cymes 0.5–2 mm long. *Flowers:* corolla glabrous; ovary broad-obovate to slightly oblate in face view, with sinus moderate; male flowers: corolla c. 1.5–2.5 mm long, with tube 0.4–1 mm long; anthers c. 0.3 mm long, c. 2/3 of length of filaments; ovary 0.2–0.5 mm long; female flowers:

corolla c. 1–2 mm long, with tube 0.3–0.6 mm long; ovary 0.8–1 mm long; style 0.8–1.5 mm long, with arms 0.1–0.5 mm long. *Fruit* c. 2 mm long.

*Flowers* summer.

**Selected specimens:** SOUTH AUSTRALIA. Western waterhole, Honans Scrub, R.J.Bates 30896, 18.i.1984 (AD). **NEW SOUTH WALES.** Tilba, Reader, ?1880 (MEL); Tumberumba, W.P.Ball, date unknown [c. 19] (MEL). **VICTORIA.** Morass Creek, Benambra Valley, R.Bates 27262, 7.ii.1991 (AD, MEL); near Dargo Track, Wonnangatta Valley, E.A.Chesterfield 3633, 5.i.1993 (CANB, MEL, NSW); Barmah Regional Park, A.C.Beaglehole 82283, 19.xi.1985 (CANB, HO, MEL, NSW); Angahook-Lorne State Park, A.C.Beaglehole 72966 & M.D.White, 15.i.1983 (MEL); c. 3 km NW of Drumborg, S side of Heywood–Dartmoor Hwy, H.I.Aston, 22.ii.1989 (AD, BRI, CANB, MEL). **TASMANIA.** Woods Lake, E side near entrance to Lake River, C.J.Bourke, 17.i.1982 (HO); Robinsons Marsh, Lake Sorell, A.Moscal 19341, 20.iii.1990 (HO).

**Distribution and habitat:** Occurs in far south-eastern South Australia, Victoria, mostly in the south and east, and Tasmania. There are a few old records from south-eastern New South Wales (Fig. 5). Grows in swamps at lowland to montane altitudes.

**Notes:** Readily identifiable by its near glabrous state, maximally 4-partite whorls, small dull leaves, few-flowered cymes and female ovary with nectary recessed after corolla-fall. There is relatively little difference in corolla morphology between female and male flowers, and this, plus the relatively short corolla-tubes, and the 4-partite whorls indicates an approach to Australian and New Zealand species of *Galium*. The overtopping of terminal cymes by sympodial growth appears to be very well developed in this species and axes can appear like the extended inflorescences of Australian species of *Galium*.

Forma *aquatica* appears to be an environmental variant. Associated with an aquatic habitat, herbarium collections of *A. subsimplex* often display long, fine roots.

***Asperula perpusilla* Hook.f., Fl. New Zealand 1: 114 (1853)**

*Galium perpusillum* (Hook.f.) Allan, Fl. New Zealand 1: 592 (1961).

**Type:** NEW ZEALAND. Locality uncertain, W.Colenso 1951; holotype: K n.v., fide H.H.Allan, op. cit. 593.

**Notes:** This species is endemic in New Zealand. It is dioecious and is morphologically close to *A. subsimplex*,

and for this reason is here returned to *Asperula* and placed in sect. *Dioicae*. The taxonomic history of this species suggests that, apart from its dioecy, there is no sharp demarcation between *Asperula* sect. *Dioicae* and Australian and New Zealand group of *Galium*.

**5. *Asperula charophyton*** Airy Shaw & Turrill,  
*Bull. Misc. Inform. Kew* 1928(3): 101 (1928)

*Asperula conferta* var. *elongata* Benth., *Fl. Austral.* 3: 444 (1867); *A. oligantha* var. *conferta-elongata* Maiden & Betche, in J.H.Maiden & E.Betche, *Census New South Wales Pl.* 188 (1916), *nom. illeg.*

**Type:** QUEENSLAND. Mackenzie River & Suttor River, *F.Mueller*, date unknown; lecto: *K n.v.*, *fide* Airy Shaw & Turrill, *loc. cit.*; remaining syntypes: New South Wales: New England, *C.Stuart*; syn: *K*; Victoria: Smythes Ranges, *Whan*; syn: *K*; State unknown: Forest Creek, *F.Mueller*; syn: *K*.

*Herbs* to c. 40 cm high. *Stems* 0.8–1.5 mm diam., sublustrous, near basally increasing to c. 2 mm diam. with age; internodes to c. 60 mm long, mostly 15–40 mm long on branches; angles much narrower than faces, glabrous, with minute papillae or with a variably dense indumentum of hairs (up to c. 50 per mm of angle); hairs spreading, 0.5–0.1 mm long, narrow-based, straight or recurved; whorls 6-partite, with stipules c. equal to leaf length. *Leaves* spreading or angled forwards, narrow-linear, mostly 10–30 mm long, 0.8–2 mm wide, with l:w ratio 10–30, tapering only slightly basally to be c. 1/2 of leaf-width at base, tapering somewhat abruptly distally, not arching, slightly fleshy; margin recurved or revolute, glabrous or with minute spreading hairs or papillae; apex subacute to rounded, with neither an apiculate extension nor a terminal hair; upper surface sublustrous, smooth on drying, with midrib not or weakly defined, without acute epidermal projections; glabrous or with a few to numerous minute antrorse scabrosities; pale patch obscure; abaxial midrib well-developed proximally, sometimes raised for much of length, recessed or to level of margins, glabrous. *Cymes* of several to numerous flowers; primary and intermediate peduncles sometimes elongate; ultimate peduncles of complex cymes 0.5–2 mm long. *Flowers*: corolla glabrous; ovary oblate in face view, with sinus moderately deep; male flowers: corolla c. 2–3 mm long, with tube 1–1.5 mm long; anthers 0.4–0.5 mm long,

c. equal to length of filament; ovary c. 0.2 mm long; female flowers: corolla c. 1–1.5 mm long, with tube c. 0.3–0.6 mm long; ovary 0.5–0.8 mm long; style 1–1.5 mm long, with arms 0.2–0.5 mm long. *Fruit* 2.5–3 mm long.

*Flowers* late winter to spring.

**Selected specimens:** QUEENSLAND. Hodgson Ck, S of Pittsworth, *A.R.Bean* 15638, 24.x.1999 (BRI, MEL); Smith's Creek, near Cambooya, *S.R.Close*, 8.xi.1965 (BRI); King's Creek, 4.5 km W of Clifton, *A.R.Bean* 15570, 2.x.1999 (BRI, MEL); Brisbane River near Esk, *L.Leichhardt*, 10.xi.1843 (NSW). **NEW SOUTH WALES.** Mother of Ducks Lagoon, Guyra, *T.A.James* 1350 & *S.McCune*, 24.xi.1992 (AD, BRI, NSW); New England, *C.Stuart* 222, no date (MEL); Barbie–Mt Wambelong Track, Warrumbungle Ranges, *H.Streimann* 556, 5.xii.1973 (BRI, CANB, NSW); Hawkesbury near Richmond, *R.Brown*, 1803 (CANB). **VICTORIA.** Little River, *Fullager*, no date (MEL).

**Distribution and habitat:** Occurs predominantly between far south-eastern Queensland and central-eastern New South Wales; also recorded as far north as Rockhampton in south-eastern Queensland, and recorded from south-central Victoria in the 19<sup>th</sup> century (Fig. 5). Grows in forest and woodland.

**Notes:** Similar to *A. geminifolia* and *A. gemella* in having flowers commonly drying yellow as opposed to those species in which the corolla tends to dry brown. The inflorescences are generally lax due to long intermediate peduncles, but the flowers are clustered closely on short ultimate peduncles. A form occurring in more southern areas, i.e., the Warrumbungle Ranges, Sydney area and in Victoria has a denser indumentum with fine short somewhat retrorse or recurved hairs rather than minute spreading papillae, and fewer-flowered inflorescences, although further collections are needed to confirm this. All Victorian collections were collected in the late 1800s and are sterile except for a collection from Skipton (*Whan* NSW670938). Listed as a ROTAP species with Risk Code 3RCa (Briggs & Leigh 1996).

A specimen from Nive River in central-eastern Queensland (*R.W.Purdie* 4398 BRI *n.v.*, CANB) is possibly a hybrid between *A. charophyton* and *A. conferta*, although the former has not been recorded this far north. It resembles *A. charophyton* in leaf dimensions, but in most other respects it is closer to *A. conferta*. Further collections from this area are desirable.



**6. *Asperula cunninghamii*** Airy Shaw & Turrill, *Bull. Misc. Inform. Kew* 1928(3): 97 (1928), as *Cunninghamii*.

**Type:** NEW SOUTH WALES. Fields Plains, A.Cunningham 46, [10] May 1817; holotype: K, images MEL; probable isotype: K, images MEL.

*Subshrubs* to c. 30 cm high. *Stems* and older branches becoming woody and developing a spongy fissuring bark basally with age, to c. 2 mm diam., becoming much-branched; internodes to 40 mm long, mostly 5–30 mm long on branches; angles narrower than faces, sometimes nearly as broad, with a dense indumentum (mostly c. 50–80 hairs per mm of angle); hairs spreading to retrorse, sometimes arising from faces, narrow-based, 0.1–0.2 mm long, variably retrorsely curved or curled; whorls 6-partite, rarely a few 7-partite, occasionally a proportion 4-partite on smaller branches, with stipules mostly 70–90% of leaf length. *Leaves* suberect, narrow-oblong to narrow-linear, or sometimes broadest near apex, 1–10 mm long, 0.4–1 mm wide, with l:w ratio 5–20, not or hardly tapering basally to be > 2/3 of leaf-width at base, abruptly tapering distally, often arched upwards, slightly to moderately fleshy; margin flat, recurved or revolute, glabrous or with scattered curved hairs; apex acute to rounded, with neither an apiculate extension nor a terminal hair; upper surface sublustrous, often wrinkled on drying, with midrib obscure or slightly raised, glabrous or occasionally with scattered hairs; without acute epidermal projections (but papillae often present); pale patch obscure; abaxial midrib robust, terete,  $\leq$  width of lamina on each side, raised throughout length, especially proximally, projecting beyond margins at least proximally, glabrous or with scattered hairs. *Cymes* of several to numerous flowers; primary and intermediate peduncles variably elongate; ultimate peduncles of complex cymes subsessile to c. 0.5 mm long. *Flowers*: corolla glabrous; ovary circular to oblate in face view, with sinus moderately deep; male flowers: corolla c. 2–4 mm long, with tube 1–2 mm long; anthers c. 0.5 mm long, c. as long as filament; ovary 0.2–0.3 mm long; female flowers: corolla 0.7–1.2 mm long, with tube c. 0.3–0.5 mm long; ovary 0.5 mm long; style c. 0.8–1.3 mm long, with arms 0.1–0.2 mm long. *Fruit* not seen fully mature, c. 2–3 mm long (probably mature length).

*Flowers* spring to early summer.

**Selected specimens:** QUEENSLAND. Rutledge Road 1 km S of Jondaryn, A.R.Bean 13821, 25.ix.1998 (BRI); 8.8 km N of Drillham, A.R.Bean 18204, 13.xii.2001 (AD, BRI). **NEW SOUTH WALES.** Ardlethan to Temora, 5 km from Ardlethan, J.W.Wrigley 71/295, 16.xii.1971 (CANB); 30 km NW of Nyngan on Mitchell Hwy, B.Wiecek 387, R.G.Coveny & M.Savio, 8.ix.1989 (AD, BRI, CANB, MEL, NSW); 2.5 km ESE of Lake Keepit Sport & Recreation Centre, c. 30 km SW of Manilla, L.M.Copeland 4018, 30.xi.2005 (BRI, CANB, MEL, NSW); Western approaches to Springdale, 15 km W of Stockinbingal, P.C.Jobson 5585 & E.A.Brown, 18.ix.1998 (AD, NSW).

**Distribution and habitat:** Occurs on inland slopes and plains of south-eastern Queensland and north-central to south-central New South Wales (Fig. 5). Grows in loam soils in woodland.

**Notes:** *Asperula cunninghamii* is characterised by its woody rootstock, well-developed branching, and short, erect parallel-sided leaves. The corolla has been described as cream-coloured (Purdie 5692 CANB). In Jobson 5585 (NSW) the plant has a massive rhizome from which only weakly woody stems arise.

**7. *Asperula ambleia*** Airy Shaw & Turrill, *Bull. Misc. Inform. Kew* 1928(3): 99 (1928)

**Type:** QUEENSLAND. Stanthorpe, J.L.Boorman, November 1904; holotype: K; isotype: NSW.

*Subshrubs*, mostly 10–30 cm high. *Stems* and older branches becoming woody and developing a spongy fissuring bark basally with age, to c. 2 mm diam., much branched; current season's branches subglabrous; internodes 1–5 mm long, with angles narrower than or c. equal in width to faces, with indumentum variably dense (up to c. 50 or so hairs per mm of angle); hairs spreading, sometimes arising from faces, to c. 0.1 mm long, narrow-based, straight or often slightly to moderately antrorsely curved; whorls predominantly 4-partite, sometimes a proportion 5- or 6-partite, with stipules 20–80% of leaf length. *Leaves* erect, narrow-oblong to narrow-linear, 2–6 mm long, 0.2–0.5 mm wide, with l:w ratio 8–20, not tapering and sometimes slightly expanding basally, fusing shortly with adjacent stipules, tapering abruptly distally, straight or arched away from stem and/or downcurved distally, somewhat fleshy; margin flat or recurved, glabrous or with spreading to slightly antrorse hairs; apex acute to obtuse without a hyaline extension; terminal hair not developed or minute (0.05 mm long), but an apical

fringe of hairs sometimes present; upper surface sublustrous, smooth or wrinkled on drying, sometimes channelled medially on drying, with midrib obscure, glabrous or with spreading hairs near margins, without acute epidermal projections; pale patch indistinct; abaxial midrib robust, broad and compressed, mostly broader than lamina on each side, raised throughout length, projecting beyond margins, usually glabrous. Cymes of few to several flowers, congested; primary and intermediate peduncles generally short; ultimate peduncles of complex cymes subsessile to 0.3 mm long. *Flowers*: corolla sometimes hairy abaxially; ovary circular or oblate in face view, with sinus moderately deep, sometimes with minute hairs; male flowers: corolla 2–3.5 mm long, with tube 1–1.5 mm long; anthers 0.4–0.5 mm long, c. equal to filament; ovary 0.3 mm long; female flowers: corolla 1.5–2.7 mm long, with tube 0.5–1.2 mm long; ovary 0.8–1 mm long; style 2–2.5 mm long, with arms 0.3–1 mm long. *Fruit* 1.5–2 mm long.

*Flowers* spring.

**Selected specimens:** **QUEENSLAND.** Stanthorpe (see Typification). **NEW SOUTH WALES.** Gara River, 9 m (14 km) E of Armidale, *G.L.Davis*, 2.x.1955 (NSW); Wollomombi Falls, c. 40 km E of Armidale, *J.B.Williams*, 20.xi.1966 (NSW); Crown Creek, 8 km by road S of Capertee-Glen Davis Rd, *V.Klaphake 1230*, 18.ix.1995 (NSW); Braidwood District, *W.Bauerlen 353*, Jan. 1885 (MEL); Snowy River, 4 km WSW of summit of Mt Rix, *S.J.Forbes 659*, 27.ix.1981 (MEL); “Murrunga” 8 km S of A.C.T. border, on Murrumbidgee River at confluence with Gossoon Creek, *I.Crawford 3160*, 12.x.1995 (CANB, NSW); Shoalhaven River, 10 km NW of Braidwood, *W.Hartley & A.V.Hill*, 23.x.1943 (AD, CANB). **AUSTRALIAN CAPITAL TERRITORY.** Molonglo River, 2.5 km upstream from junction with Murrumbidgee River, *P.Barrer*, Oct. 1990 (CANB). **VICTORIA.** Snowy River near Upper Bete Bolong, *N.A.Wakefield*, 26.x.1946 (MEL).

**Distribution and habitat:** Occurs predominantly on the tablelands in eastern New South Wales and in the Australian Capital Territory, but also extends into south-eastern Queensland at Stanthorpe and into far eastern Victoria at Bete Bolong (Fig. 6). Grows on rocky riverbanks in riparian scrub and woodland.

**8. *Asperula subulifolia*** Airy Shaw & Turrill, *Bull. Misc. Inform. Kew* 1928(3): 98 (1928)

**Type:** **QUEENSLAND.** Texas, *J.L.Boorman*, September 1910; holo: K, images MEL; iso: NSW.

*Subshrubs* to c. 30 cm high. *Stems* and older branches becoming woody and developing a spongy fissuring bark basally with age, to c. 2 mm diam., becoming much branched; current season’s branches sublustrous; internodes to 25 mm long, mostly 5–10 mm long on branches; angles much broader than faces, with a dense indumentum (mostly c. 50–100 hairs per mm of angle); hairs spreading, c. 0.1 mm long, narrow-based, straight; whorls 6- or 7-partite, or a proportion 4- or 5-partite on short branches, with stipules 70–90% of leaf length. *Leaves* erect, linear-lanceolate, 2–10 mm long, 0.2–0.4 mm wide, with l:w ratio 5–20, not or hardly tapering basally to be > 2/3 of leaf-width at base, very gradually tapering distally, sometimes gently arched upwards, slightly fleshy; margin flat, glabrous or with scattered hairs; apex peracute or sometimes filiform; a terminal hair not generally developed, but short hairs clustered around apex; upper surface sublustrous, often wrinkled on drying, with midrib obscure, glabrous or with scattered hairs; without acute epidermal projections; pale patch not evident; abaxial midrib robust and broad (c. 1/2–7/8 of total width), raised throughout length, projecting beyond margins, glabrous or with scattered hairs. *Cymes* of several flowers; primary peduncle usually elongate; intermediate peduncles generally short; ultimate peduncles of complex cymes subsessile. *Flowers*: corolla sometimes hairy abaxially; ovary slightly oblate in face view, with sinus moderately deep; male flowers: corolla c. 2–2.5 mm long, with tube c. 1 mm long; anthers c. 0.5 mm long, c. as long as filament; ovary 0.2–0.3 mm long, female flowers: corolla c. 1 mm long, with tube c. 0.5 mm long; ovary 0.5 mm long; style c. 0.8–1 mm long, with arms 0.1–0.2 mm long. *Fruit* c. 2–3 mm long.

*Flowers* spring to early summer.

**Selected specimens:** **NEW SOUTH WALES.** Near Batterham lookout, Bingara, *P.I.Forster 18240*, 16.xii.1995 (BRI, MEL, NSW); presbytery in Ashford, *P.Barrett*, 1.xi.1993 (NSW); Vickery State Forest, c. 24 km N of Gunnedah, *D.Binns*, 21.xi.2001 (NSW).

**Distribution and habitat:** Occurs on the Northern Tablelands region in north-eastern New South Wales (Fig. 6). Grows in woodland.

**Notes:** Based on the very few specimens collected, *A. subulifolia* shows considerable variation in leaf dimensions, hairiness and stem-angle thickness.

### 9. *Asperula hoskingii* I.Thomps., sp. nov.

Ab *A. cunninghamii* Airy Shaw & Turrill plantis non lignosis, pilis longioribus, stylis longioribus, tubo corollarum masculino longioribus differt; ab *A. wimmerana* Airy Shaw & Turrill foliis ellipticis magis decrescentibus basin versus, pilis patentibus differt.

**Type:** NEW SOUTH WALES. Eastern side of Woods Reef Mine, *J.R.Hosking* 517, 27 August 1992; holo: MEL; iso: CANB, NSW, NE.

*Herbs* mostly to c. 10 cm high. *Stems* 0.5–0.8 mm diam., sublustrous to lustrous; branching generally simple; internodes to 15 mm long, mostly 3–8 mm long; angles narrower than to slightly broader than faces, with a moderately dense indumentum (c. 50 or more hairs per mm of angle); hairs spreading or slightly retrorse, sometimes arising from faces, mostly 0.2–0.4 mm long fairly narrow-based, straight; whorls 6-partite, with stipules c. equal to leaf length. *Leaves* moderately ascending to suberect, narrow-elliptic, 3–5 mm long, 0.7–1.2 mm wide, with l:w ratio 3–5, tapering gradually basally and distally, often mildly arching forward distally, coriaceous; base 1/3–2/5 of maximum width; margin revolute, less often recurved, thickened, with numerous spreading hairs, 0.2–0.4 mm long, ± evenly distributed; apex acute, sometimes minutely extended (excl. terminal hair); terminal hair(s) 0.2–0.3 mm long; upper surface sublustrous to lustrous, drying green, weakly wrinkled without concavity, with midrib not or weakly defined, with several to numerous spreading hairs, without acute epidermal projections; pale patch generally indistinct, c. circular, often purple-tinged; abaxial midrib moderately robust, typically raised for most of length, usually slightly recessed relative to margins, with spreading hairs. *Cymes* of 1 or few to several flowers, congested; primary and intermediate peduncles short; ultimate peduncles of complex cymes sessile. *Flowers:* corolla often hairy abaxially; ovary circular in face view, with sinus shallow; male flowers: corolla 3–3.5 mm long, with tube 2–2.2 mm long; anthers 0.7 mm long, c. as long as filament; ovary 0.4–0.6 mm long; female flowers: corolla 1.0–1.5 mm long, with tube 0.4–0.6 mm long; ovary 0.6 mm long; style 1.5–2 mm long including style-arms 0.3–0.5 mm long; stigma with l:w ratio 2. *Fruit* c. 2 mm long.

*Flowers* late winter to spring.

**Selected specimens:** NEW SOUTH WALES. East of Woodsreef mine, *J.R.Hosking* 632, 25.xi.1992 (CANB, MEL, NSW); 600 m W of Perpendicular Rock, Warialda State Forest, *L.M.Copeland* 3225, 25.x.2001 (NSW); Nandewar Range sign on Dawsons Spring Road, Mt Kaputar National Park, *R.Coveny* 8905 & *S.K.Roy*, 21.xi.1976 (NSW).

**Distribution and habitat:** Occurs in far north-eastern New South Wales (Fig. 6). Grows on serpentinite soils in woodland.

**Notes:** *Asperula hoskingii* has a distinctive bristly indumentum and ascending, narrow-elliptic leaves. Male flowers have a relatively long corolla-tube and long anthers relative to the length of the filaments. The discrepancy in size between corollas of male and female flowers is more marked than in most other species.

**Etymology:** The epithet recognises John Hosking from Tamworth, New South Wales who collected and recognised this species as a probable new entity, and who has been a valuable contributor to knowledge of the Australian flora.

### 10. *Asperula syrticola* (Miq.) Toelken, in J.P.Jessop & H.R.Toelken, *Fl. S. Australia* edn. 4, 2: 1063 (1986)

*Rubia syrticola* Miq., *Ned. Kruidk. Arch.* 4: 111 (1856).

**Type:** SOUTH AUSTRALIA. Wallindunga [Woollundunga], *F.Mueller*, October 1847; holo: U n.v.; iso: MEL.

*Asperula lissocarpa* Airy Shaw & Turrill, *Bull. Misc. Inform. Kew* 1928(3): 96 (1928), *nom. illeg.* Type: New South Wales: Darling River, *Dallachy*; holo K, images MEL.

*Herbs* to c. 20 cm high, sometimes weakly subshrubby. *Stems* sometimes persisting into second season developing spongy bark basally; current season's stems 0.5–1 mm diam., sublustrous; branching sparing to moderate; internodes to 20 mm long, mostly 2–10 mm long on branches, angles often c. as broad as faces, with a moderately dense to dense indumentum (up to c. 60 hairs per mm of angle); hairs retrorse, (0.1–)0.2–0.4 mm long, narrow to broad-based, straight; hairs sometimes arising from faces also; whorls 6–8-partite, usually at least some 7- or 8-partite, with stipules c. equal to leaf length. *Leaves* commonly angled strongly upwards, linear, mostly 3–10 mm long, 0.3–0.7 mm

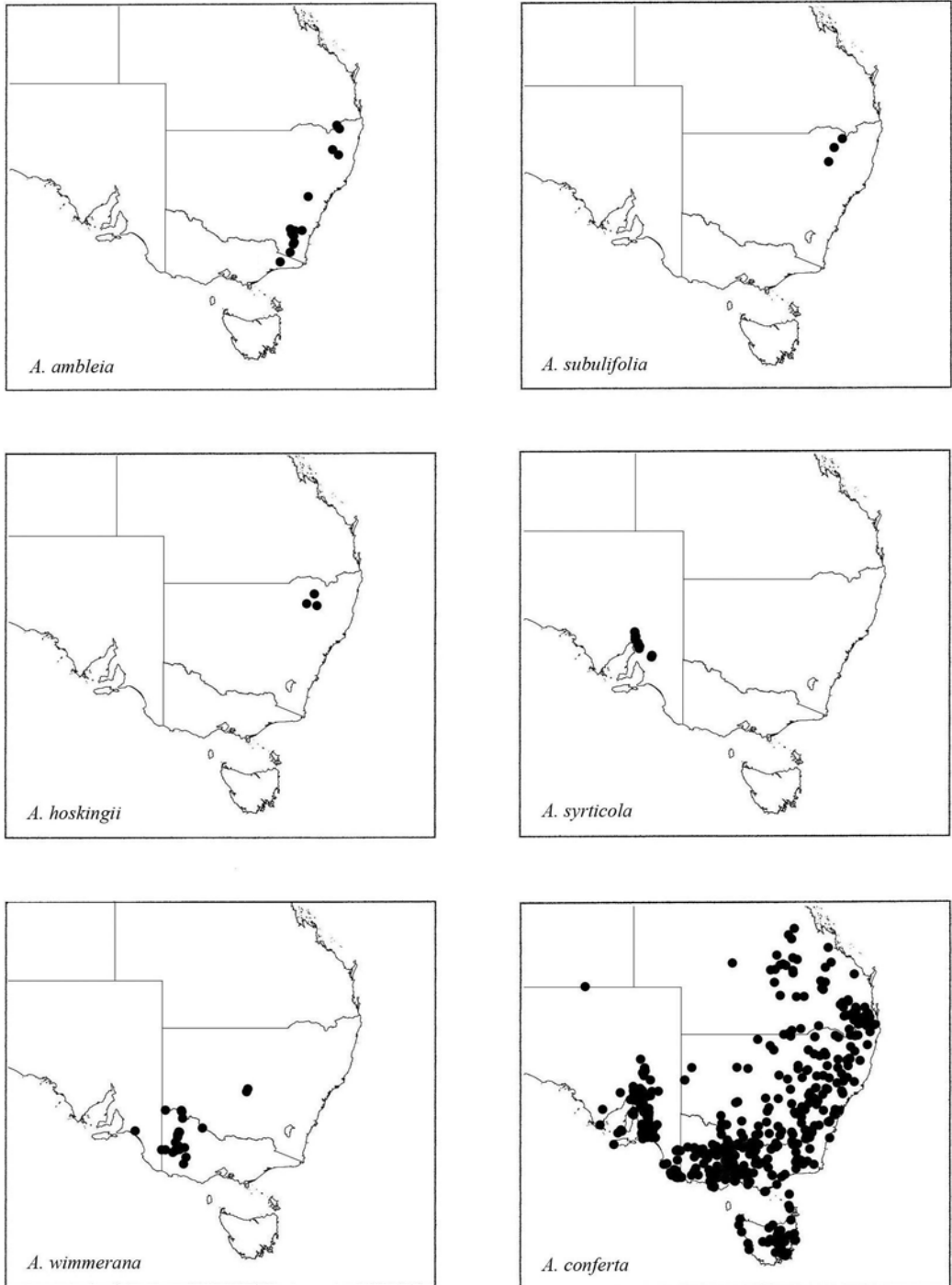

**Figure 6.** Distributions of *Asperula ambleia*, *A. subulifolia*, *A. hoskingii*, *A. syrticola*, *A. wimmerana*, *A. conferta*.

wide, with l:w ratio 10–15, hardly tapering basally to be  $> 1/2$  of leaf-width at base, gradually tapering distally, often arching upwards, slightly fleshy; margin mostly recurved, with spreading hairs; apex acute, with hyaline  $\pm$  purple-tinged extension to 0.5 mm long; terminal hair 0.2–0.4 mm long, often with 1 or a few hairs immediately adjacent; upper surface sublustrous to lustrous, smooth or creased on drying, with midrib not defined, without acute epidermal projections, glabrous or uncommonly with scattered hairs; pale patch obscure; abaxial midrib robust, raised for entire length, projecting beyond margin, with spreading hairs. *Cymes* of few to several flowers, congested; primary and intermediate peduncles short; ultimate peduncles of complex cymes subsessile to c. 0.5 mm long. *Flowers*: corolla occasionally hairy abaxially; ovary circular to slightly oblate in face view, with sinus moderately deep; male flowers: corolla c. 2–4.5 mm long, with tube 1–2.5 mm long; anthers c. 0.4–0.5 mm long, equal to a slightly shorter than filament; ovary c. 0.2 mm long; female flowers: corolla 1.5–2.5 mm long, with tube c. 0.5–1 mm long; ovary c. 0.5 mm long; style 1.5–3 mm long with arms c. 0.3 mm long. *Fruit* 1.5–2 mm long.

*Flowers* late winter to spring.

**Selected specimens:** **SOUTH AUSTRALIA.** Nectar Brook, Eyre Peninsula, *T.Hall* 270, 19.viii.1988 (AD); Bowman Park Hills, crystal Brook, Northern Lofty Ranges, *A.G.Spooner* 6623, 9.x.1979 (AD); World's End Creek, S of Burra Creek, *R.Bates* 35346, 21.xi.1993 (AD); Deep Creek, Speer Creek Station, Flinders Ranges, *A.Stefanovic*, Oct. 1993 (AD).

**Distribution and habitat:** Occurs in south-eastern South Australia on and adjacent to the Flinders Ranges and Northern Lofty Ranges (Fig. 6). Grows often amongst rocks commonly on limestone in hilly country, in woodland.

**Notes:** A bristly plant mostly, with short internodes, moderately erect usually arching leaves and stipules, and whorls maximally 7- or 8-partite. Short, leafy axillary branches are typically formed early and are present at many nodes. The ovary is deeply cleft and mericarps are relatively small and lustrous. Persisting dead branches are bleached white. Listed as a ROTAP species with Risk Code 3RC- (Briggs and Leigh 1996).

**11. *Asperula wimmerana*** Airy Shaw & Turrill, *Bull. Misc. Inform. Kew* 1928(3): 94 (1928).

**Type:** VICTORIA. Wimmera, *F.M.Reader*, 1900; holotype: K, images MEL.

*A. wimmerana f. glaberrima* Airy Shaw & Turrill, *Bull. Misc. Inform. Kew* 1928(3): 94–95 (1928). Type: Victoria: near Melbourne, *F.M.Adamson* 486, 7 September 1856; holotype: K, images MEL.

*Herbs* to c. 12 cm high. *Stems* 0.5–0.9 mm diam., sublustrous; sparingly branched; internodes to 30 mm long, mostly 4–15 mm long on branches; angles narrower than, as broad as, or broader than faces, with a sparse or more often moderately dense indumentum (typically 10–30 hairs or scabrosities per mm of angle); hairs or scabrosities strongly retrorse, 0.1–0.3 mm long, fairly broad-based, straight; whorls 6-partite, with stipules c. equal to leaf length. *Leaves* commonly angled forwards, sometimes spreading, narrow-oblong to narrow-linear, mostly 3–14 mm long, 0.5–1 mm wide, with l:w ratio 6–15, slightly tapering basally to be  $> 1/2$  of leaf-width at base, gradually tapering distally, commonly arching upwards especially distally, slightly fleshy; margin recurved or revolute, glabrous or more often with several to numerous spreading hairs, usually less frequent distally; apex acute, mostly without a hyaline apiculate extension or extension to c. 0.5 mm long; terminal hair 0.5–0.1 mm long; upper surface dull to sublustrous, often slightly wrinkled on drying with midrib not defined, without acute epidermal projections, glabrous or with a few hairs submarginally; pale patch obscure; abaxial midrib fairly robust, raised in proximal 2/3 or throughout, projecting beyond margin or not, with a few to numerous hairs. *Cymes* of few to several flowers, congested; primary and intermediate peduncles short; ultimate peduncles of complex cymes subsessile to 0.5 mm long. *Flowers*: corolla glabrous; ovary markedly oblate in face view, with sinus moderately deep; male flowers: corolla c. 2–4.5 mm long, with tube 1–2.5 mm long; anthers c. 0.4–0.6 mm long, c. 1/2–2/3 as long as filament; ovary c. 0.2 mm long; female flowers: corolla c. 1.5–2.5 mm long, with tube 0.4–1.2 mm long; ovary 0.6–0.8 mm long; style 1.5 mm long, with arms c. 0.3 mm long. *Fruit* 2.5–3 mm long.

*Flowers* late winter to spring.

**Selected specimens:** **SOUTH AUSTRALIA.** Frances, c. 25 km N of Naracoorte, *D.Hunt 1609*, 20.ix.1963 (AD); Poltalloch Homestead, *Ranger Coy 3578*, s.d. (AD). **NEW SOUTH WALES.** Near pipeline trench 7 km E of Euabalong W towards Gilgunnia Rd, *G.M.Cunningham & P.L.Milthorpe 3237*, Sept. 1974 (NSW). **VICTORIA.** Mt Arapiles near W boundary, *A.C.Beauglehole 29800*, 25.xi.1968 (AD, MEL); Yarriambiack Creek, *F.M.Reader*, 9.ix.1903 (MEL); Kings Billabong, 8 km SE of Mildura PO, *A.Paget 2684*, 16.x.1996 (MEL); E shore of Lake Albacutya, *T.B.Muir 887*, 10.x.1959 (MEL).

**Distribution and habitat:** Occurs predominantly in western Victoria including the far north-west, but also occurs in far south-eastern South Australia and considerably disjunctly in central New South Wales (Fig. 6). Grows on lowland plains, in seasonally wet often subsaline habitats, in grassland and woodland.

**Notes:** Most similar to *A. conferta* with which it is sympatric. Apart from features given in the key, *A. wimmerana* commonly has broader angles on stems with more numerous and longer hairs, a more obscure pale patch on the upper surface of the leaf, and shorter staminal filaments. The corolla-tube of female flowers is longer than that of the form of *A. conferta* with which it is sympatric.

In leaf size, orientation and arching, *A. wimmerana* resembles *A. cunninghamii*; however, the latter develops a corky fissuring bark, has finer stem-hairs, stipules that are more distinctly shorter than the leaves, leaf-apices that are not acute and without a terminal hair, and ovaries that are less oblate and with a shallower sinus.

**12. *Asperula conferta* Hook.f., in W.J.Hooker, London J. Bot. 6: 464 bis (1847)**

*A. oligantha* var. *conferta* (Hook.f.) Maiden & Betche, in J.H.Maiden & E.Betche, *Census New South Wales Pl*: 188 (1916), *nom. illeg.*

**Type:** **TASMANIA.** Location unknown, *Lawrence 115*, 1831; lecto: K (Herb. Hookerianum), *vide* Airy Shaw & Turrill (1928), images MEL. Remaining syn: Tasmania: allotment of Gunn, Launceston, *R.C.Gunn 159*, 14 October 1843; syn: HO. [Given as var. alpha].

*A. conferta* var. *scoparioides* Airy Shaw & Turrill, *Bull. Misc. Inform. Kew* 1928(3): 87 (1928). **Type:** Queensland: locality unknown, Camp 29 of Mitchell expedition, *T.L.Mitchell 515*, August 1846; holo: K, images MEL.

*A. conferta* var. *abbreviata* Airy Shaw & Turrill, *Bull. Misc. Inform. Kew* 1928(3): 87 (1928). **Type:** Tasmania:

Woolnorth, *R.C.Gunn 890*, 16 October 1836 and 21 September 1837; holo: K (2 sheets), images MEL; iso: HO.

*Herbs* mostly to c. 30 cm high, but occasionally climbing and with stems to 2 m long. *Stems* 0.5–1 mm diam., sublustrous to lustrous; degree of branching variable; internodes to c. 30 mm long, mostly 2–10 mm long on branches; angles narrower than faces, glabrous or with a sparse to moderately dense indumentum (up to c. 30 hairs or scabrosities per mm of angle); hairs and scabrosities slightly to strongly retrorse or less often spreading, 0.05–0.2 mm long, rarely to c. 0.4 mm long, usually broad-based, more or less straight; whorls 6-partite, occasionally a small proportion 5-, 7- or 8-partite, rarely 4-partite on lower-branches, with stipules c. equal to leaf length. *Leaves* spreading or angled upwards, often becoming pendent, mostly narrow-oblong to narrow-linear, sometimes narrowly oblong-elliptic or lanceolate, 1.5–16 mm long, 0.3–1.5 mm wide, with l:w ratio 2–12(–20), not or slightly tapering basally to be mostly > 1/2 leaf-width at base, gradually to somewhat abruptly tapering distally, often a little downcurved distally, usually slightly fleshy; margin flat, recurved or less often revolute, glabrous or more often with a few to several spreading to slightly antrorse hairs, more or less evenly distributed; apex obtuse to acute, sometimes with a hyaline apiculate extension up to 0.2 mm long; terminal hair(s) 0.05–0.3 mm long, mostly at least as long as hyaline extension; upper surface sublustrous to lustrous, occasionally more or less dull, with lustrous zone sometimes not quite extending to margin, smooth, (glossy strip may produce a relatively dark, sometimes concave surface on drying), with midrib not defined, with acute epidermal projections usually evident on distal margin, glabrous or uncommonly with a few short hairs near margins and towards base; pale patch generally evident, circular to elliptic, sometimes purple-tinged or ringed; abaxial midrib robust, generally raised throughout length and equalling or projecting beyond margins, usually bearing scattered hairs. *Cymes* of few to several flowers; primary and intermediate peduncles short or occasionally mildly elongate; ultimate peduncles of complex cymes 0.3–1 mm long, occasionally to 2 mm long. *Flowers:* corolla glabrous; ovary circular, broad-obovate or slightly oblate in face view, with sinus shallow; male flowers: corolla 1.5–5 mm long, with tube

0.5–2.5 mm long; anthers 0.3–0.6 mm long, 1/3–2/3 length of filament; ovary 0.2–0.6 mm long; female flowers: corolla 1–2.5 mm long, with tube 0.2–1.0(–1.2) mm long; ovary 0.5–1 mm long; style 0.8–4 mm long, with arms 0.4–1.5 mm long. *Fruit* 1.5–2 mm long.

*Flowers* spring to early summer, occasionally other times.

**Selected specimens:** **SOUTH AUSTRALIA.** The Bluff, section 455 hd of Hindmarsh, 4 km SW of Glencoe, *D.N.Kraehenbuehl* 3151, 8.i.1965 (AD); S boundary of Honans Scrub, *R.Bates* 32231, 17.iv.1993 (AD); Below "The Bluff" Tantanoola, *R.J.Bates* 26374, no date (AD); c. 1.5 km inland from Port Stanvac, *T.Smith* 577, 4.x.1967 (AD). **QUEENSLAND.** Peak Downs, *S.L.Everist* 4403, 23.vi.1951 (BRI, CANB); Barwon Hwy, 65 km W of Goondiwindi, *A.R.Bean* 17808, 9.ix.2001 (BRI); 30 km W of Carnarvon Hwy along Thallon–Dirranbandi Road, 15 km E of Noondoo Railway Siding, *D.Halford & G.N.Batianoff*, 10.xii.2001 (BRI, NSW); 8 km W of Muckadilla on roadside of Warrego Hwy, *D.E.Boyland* 136, 17.ix.1966 (BRI, CANB); Killarney, *G.N.Batianoff* 2010332 & *C.Appelman*, 2.x.2000 (BRI, DNA, NSW). **NEW SOUTH WALES.** 35 km from Balranald towards Hay, *E.J.Carroll*, 15.ix.1965 (CANB). Woodstock Cemetery, c. 1.5 km S of Woodstock on the road to Wyangala Dam, *A.E.Orme* 148 & *L.Orme*, 16.x.2000 (MEL, NSW); Narrabri Creek, Narrabri, *J.M.Dalby* 86/65 & *R.G.Coveny*, 8.ix.1986 (BRI, CANB, MEL, NSW); Bombala River, c. 17 km NE of Bibbenluke, *I.Crawford* 741, 21.xii.1987 (AD, CANB); On Gwydir Hwy, 52.5 km E of Barwon River bridge at Collarenebri, *B.Wiecek* 119, *R.Coveny*, & *P.Cuneo*, 22.viii.1987 (AD, BRI, NSW); Rules Pt Rd, c. 2 km from Blue Waterholes turnoff towards Snowy Mountains Hwy, Kosciuszko National Park, *T.James* 533 & *M.Taylor*, 1.ii.1984 (NSW). **AUSTRALIAN CAPITAL TERRITORY.** NE base of Black Mountain, *H.S.McKee* 11662, 10.x.1964 (CANB, NSW). **VICTORIA.** W side of Eildon reservoir, Fraser National Park, *T.B.Muir* 3584, 29.x.1964 (MEL); E side of Oxbow Lake, Nelson, *N.H.Scarlett* 86-482, 19.xii.1986 (MEL); Baillieu Lagoon Wildlife reserve, *A.C.Beaglehole* 80233, 9.ix.1985 (MEL). **TASMANIA.** Tunbridge Tiers Road, 3 km W of Midlands Hwy, *A.M.Buchanan* 7590, 22.xii.1985 (BRI, HO); Jericho to Lower Marshes, *A.C.Rozefelds* 2074, 11.x.2001 (HO); Howrah, *P.Collier* 3449, 2.x.1988 (HO); Conical Rocks, *A.E.Orchard* 5710, 5.xii.1981 (HO); near Hobart Airport, Holyman Drive/Tasman Hwy junction, *A.J.North*, 13.x.2000 (HO); Hobart Airport, *H. & A.Wapstra*, 29.xii.2001 (HO).

**Distribution and habitat:** Occurs in south-eastern Queensland, almost throughout New South Wales and Victoria, in the Australian Capital Territory, in south-eastern South Australia, and Tasmania (Fig. 6). Grows in a variety of soils, predominantly on lowland plains

and in hilly country but also extending into higher altitudes, in forest, woodland, scrubland, coastal heath and grassland.

**Notes:** *Asperula conferta* is the most widely distributed and variable species in the genus. Flower size is variable, with populations in more mesic environments generally having larger flowers. The stigma is relatively long compared to other species in the genus, and is often more than twice as long as broad. A useful spotting character for *A. conferta* is the glossy strip on the upper surface of leaves. Sometimes the glossy strip covers the entire upper surface, but often, particularly in inland forms, the strip does not extend to the margins. In this situation leaves in dried specimens often have a broad concavity corresponding to the darkened glossy zone, and there is a distinct visual contrast between the pale dull margin and darker, often brownish, glossy upper surface. In a smaller proportion of specimens the glossy strip is not or only weakly developed. Other features of *A. conferta* include the relatively long staminal filaments and styles in the flowers.

A form of *A. conferta* with a relatively elongate habit and more basal whorls of branches often 4-partite has been recorded from swamps of south-eastern South Australia and from near Hobart. South Australian specimens have been recorded as climbing up to 2 m high over shrubs. In all other respects it is typical of *A. conferta* of coastal parts of Victoria and South Australia. Small-flowered forms occur in inland plains regions, particularly in Queensland. Although it is tempting to consider them a variety, they appear to be connected to large-flowered forms by a range of intermediates.

*Asperula conferta* has been confused with *A. scoparia* subsp. *scoparia*. Occasional specimens have an indumentum of similarly density to the latter; however, the hairs in *A. conferta* are generally coarser and generally more retrorsely oriented. *Asperula conferta* can always be distinguished from *A. scoparia* by the relative shortness of the hyaline leaf-tip, especially relative to the terminal hair length, and in most instances by the length of the corolla tube in both male and female flowers and by the relatively long staminal filaments in male flowers.

*Asperula pusilla* can also be confused with *A. conferta* particularly when its leaves are glabrous on the upper

## Key to subspecies

- 1 Leaves of flowering branches  $\leq 1$  mm wide, not acuminate into hyaline tip; indumentum of stem-angles generally dense, of hairs 0.1–0.2 mm long ..... **13a.** subsp. *scoparia*
- 1: Leaves of flowering branches generally  $> 1$  mm wide, acuminate into hyaline tip; indumentum of stem-angles absent or variably dense, of papillae c. 0.05 mm long ..... **13b.** subsp. *subglabra*

surface. It can be distinguished from *A. conferta* by the lack of a neat glossy strip on the upper surface, as described below, and by the finer abaxial midrib. *Asperula conferta* rarely develops hairs on the upper surface but these occur proximally in contrast to those in *A. pusilla*. *Asperula pusilla* typically has a proportion of leaves with a rounded apex and or with the apex rolled under, and the upper surface is somewhat uneven and irregularly darkened in dried specimens. These features further distinguish it from *A. conferta*.

One specimen that is vegetatively typical of *A. conferta*, *A. Cunningham* 47 CANB, collected near Bathurst on Oxley's first expedition in 1817, has bisexual flowers, with both stamens and style fully developed. This is the only case of bisexual flowers seen in *Asperula* sect. *Dioicae*. A specimen from East Gippsland Victoria (*A.C. Beauglehole* 37211 & *K.C. Rogers* MEL 1506074, dupl. NSW) has atypically long hairs but is otherwise quite typical of *A. conferta*.

*Asperula conferta* occasionally resembles *A. oblanceolata* in leaf shape and in having glabrous stems. However, in the former, the stigma is elongate rather than globose, the pale patch is more conspicuous, leaves are fleshier and not wrinkling above, the abaxial midrib is more robust, anthers are larger, and leaves dry greener.

*Hybrids*: There is evidence of hybridisation between *A. conferta* and *A. scoparia* subsp. *scoparia* at St Patricks Plain, Tasmania (*A.C. Rozefelds* 2236 HO). A specimen from the Warrego district, Queensland is possibly a hybrid between *A. conferta* and *A. charophyton* q.v. although the latter has not been recorded in this district. Further investigation of this entity is required.

**13. *Asperula scoparia*** Hook.f., in W.J. Hooker, *London J. Bot.* 6: 463 bis (1847)

*A. oligantha* var. *scoparia* (Hook.f.) Maiden & Betche, in J.H. Maiden & E. Betche, *Census New South Wales Pl.*: 188 (1916), *nom. illeg.*

**Type: TASMANIA.** “?Lawrenny”, *J.D. Hooker* 1007, date unknown; holo: K [excluding 2 pieces marked as “stem glab” *vide* Airy Shaw & Turrill (1928)], images MEL.

*Herbs* to c. 30 cm high. *Stems* 0.5–1 mm diam., sublustrous; sometimes much-branched; internodes to 30 mm long, mostly 2–10 mm long on branches; angles narrower than equal to or slightly broader than faces, with a moderately dense indumentum (c. 50 hairs per mm of angle); hairs spreading or occasionally slightly retrorse, 0.05–0.2 mm long, narrow-based, straight; whorls consistently and maximally 6-partite, with stipules c. equal to leaves. *Leaves* spreading or variously angled forwards, narrow-elliptic, lanceolate to narrow-lanceolate, or narrow-oblong to narrow-linear, mostly 3–12 mm long, 0.3–2 mm wide, with l:w ratio 5–20, slightly to moderately tapering basally to be 1/3–2/3 of leaf-width at base, gradually to very gradually tapering distally, generally not arching; subcoriaceous, occasionally slightly fleshy; margin flat, recurved or less often revolute, usually with a few to numerous spreading hairs but generally not in distal 1/5 of leaf; apex narrowly acute, with hyaline extension maintaining angle of apex, 0.2–0.7 mm long; terminal hair(s) c. 0.05 mm long when present; upper surface lustrous, smooth or occasionally wrinkled on drying, with midrib not defined, without acute epidermal projections, glabrous; pale patch distinct, fusiform to sublinear; abaxial midrib robust, raised throughout length, normally projecting beyond level of margins, glabrous or with a few to several hairs. *Cymes* of few to several flowers; primary and intermediate peduncles short or occasionally mildly elongate; ultimate peduncles of complex cymes subsessile to 1 mm long, occasionally to 2 mm long. *Flowers*: corolla glabrous; ovary circular to slightly oblate in face view, with sinus shallow; male flowers: corolla c. 3–6 mm long, with tube 1.5–3.5 mm long; anthers 0.6–0.9 mm long, nearly as long as filament; ovary 0.3–0.5 mm long; female



flowers: corolla 2–4 mm long, with tube 0.8–2 mm long; ovary 0.8–1 mm long; style 1.6–4 mm long with arms 0.3–1.2 mm long. *Fruit* 1.7–2.5 mm long.

*Flowers* spring to early summer.

### 13a. *Asperula scoparia* Hook.f. subsp. *scoparia*

*Asperula scoparia* var. *ulicina* Airy Shaw & Turrill, *Bull. Misc. Inform. Kew* 1928(3): 89 (1928). Type: NEW SOUTH WALES. Monga, *W.Bauerlen*, October 1926 [date presumably is in error]; syn: K; New South Wales: Riedsdale, Braidwood, *W. B[auerlen?]*, October 1890; syn: K; New South Wales: Yarrogobilly Caves, *E.Betche*, February 1897; syn: K, images MEL.

*Stem-angles* with a dense indumentum of hairs 0.1–0.2 mm long. *Leaves* in flowering branches mostly 0.4–1.0 mm wide, with upper surface drying smooth, with apex narrowly acute.

**Selected specimens:** NEW SOUTH WALES. Ben Halls Gap State Forest, *J.R.Hosking* 236, 27.xi.1990 (NSW); Tallaganda State Forest, road to Parkers Gap from Captains Flat, *A.M.Lyne* 1608, 29.x.1995 (CANB); W of Slaughteryard Trail, Burrinjuck Nature Reserve, *J.A.Matarczyk* 24, 13.x.1996 (CANB); Hoskinstown–Braidwood Road, 10 km direct ESE from Hoskinstown, *M.J.Taylor* 404, 11.xii.1984 (MEL, NSW); Jenolan State Forest, *D.Benson* 1684 & *D.Keith*, 30.iii.1984 (NSW). AUSTRALIAN CAPITAL TERRITORY. Orroral, *E.D'Arnay*, Jul. 1963 (CANB, MEL); just S of Batlow on the Tumbarumba Road, *T.B.Muir* 2403, 25.x.1961 (MEL); E slope of Mt Gingera, Brindabella Ranges, *R.Schodde* 5165, 29.xi.1966 (CANB, NSW). VICTORIA. Near summit of Mt Seldom Seen, c. 10 km SW of Wulgulmerang, *A.E.Orchard* 2746, 6.xii.1970 (AD); Darbyshire, 25 km E of Tallangatta, *T.B.Muir* 2378, 25.x.1961 (AD, MEL). TASMANIA. Knocklofty, Hobart, *A.M.Olsen*, 27.x.1937 (HO); near Murderers Marsh, Mt Dromedary, *T.A.Halliday* 550, 20.i.1981 (HO).

**Distribution and habitat:** Occurs in eastern New South Wales south from Ben Halls Gap State Forest in the Northern Tablelands, in the Australian Capital Territory, in eastern and southern Victoria, and in central and southern Tasmania (Fig. 7). Grows in various soils, often in hilly and rocky sites, in forest at low to subalpine altitudes.

**Notes:** In this subspecies a distinctive longitudinal striping effect on the upper leaf surface is usually evident with magnification. This appears to be due to the alignment and shape of epidermal cells. The lustrous upper surface of the leaves does not dry dark as it generally does in *A. conferta*.

A moderate percentage of specimens are compact plants with crowded whorls (internodes often 1 mm or less long) and relatively narrow leaves. These are considered variants induced by harsh environments, and there are numerous intermediate specimens connecting them to laxer forms. Airy Shaw & Turrill (1928) referred this form to var. *ulicina*, but recognition of this taxon is not considered warranted.

**Hybrids:** A possible hybrid between *A. scoparia* subsp. *scoparia* and *A. pusilla* has been collected from Mount Buffalo, Victoria (*D.Verdon* 288 CANB). Hairs are longer than normally occurs in *A. scoparia* and the hyaline tip is shorter than usual.

### 13b. *Asperula scoparia* subsp. *subglabra*

I.Thomps., *subsp. nov.*

*A subspecie typica foliis latioribus acuminatis carnosioribus, pilis caulium parvioribus differt.*

**Type:** NEW SOUTH WALES. Summit of Coricudgy Road, Rylstone, Wollemi National Park, *B.Rimes* 5, *F.Davies* & *T.Mulcahy*, 1 December 1987; holotype: NSW; isotype: CANB.

*Stem-angles* glabrous or with a mostly sparse indumentum of minute papillae < 0.1 mm long. *Leaves* in flowering branches mostly 1–2 mm wide, with upper surface commonly drying wrinkled, with apex acuminate.

**Selected specimens:** NEW SOUTH WALES. Illawarra Hwy, 5 km W of Robertson, *P.G.Kodala* 184, *T.A.James*, *R.G.Coveny* & *P.D.Hind*, 27.ix.1992 (AD, BRI, CANB, MEL, NSW); Sassafras, c. 48 km SW of Nowra, *F.A.Rodway* 2593, 10.x.1937 (NSW); Mt Coricudgy, *A.Rodd* 2374, 30.ix.1973 (NSW).

**Distribution and habitat:** Occurs in far eastern New South Wales from Mt Coricudgy south to Clyde Mountain (Fig. 7). Grows in dark sandy loam and clay loam on sandstone and basalt in forests with a grassy or herb-rich understorey.

**Notes:** Distinguished from subsp. *scoparia* by the inconspicuous stem indumentum and broader, slightly fleshier and slightly acuminate leaves.

**Etymology:** The subspecific epithet refers to the stems which are glabrous or indistinctly papillose (From *L. sub*, almost; *glabra*, hairless)

**14. *Asperula polymera*** I.Thomps., *sp. nov.*

*Ab. A. euryphylla* Airy Shaw & Turrill *verticillis 7- vel 8-partitis ut maximum, foliis attenuatis basin versus, antheris longioribus, stylis longioribus differt.*

**Type: VICTORIA.** Eastern Highlands, just south-east of summit of Mt Vinegar, *T.B.Muir 2519*, 19 November 1961; holo: MEL.

*A. euryphylla* var. *octophylla* Airy Shaw & Turrill, *Bull. Misc. Inform. Kew* 1928(3): 100 (1928). Type: Location unknown, Victoria (probably), collector and date unknown; holo: K, images MEL; iso: MEL.

*A. euryphylla sensu* T.A.James & W.K.Allen, *Fl. New South Wales* 3: 488 (1992).

*Herbs* to c. 40 cm high. *Stems* 0.6–1.0 mm diam.; sparingly branched; internodes to c. 70 mm long, mostly 5–50 mm long on branches; angles narrower than faces, with a moderately dense indumentum (generally 50 or more hairs per mm of angle); hairs moderately retrorse, 0.05–0.1(–0.2) mm long, narrow to fairly broad-based, straight; whorls 6–8-partite, commonly at least one 7- or 8-partite, with stipules c. equal to leaf length. *Leaves* spreading or angled upwards, narrow to very narrow-elliptic, oblanceolate to narrow-oblanceolate or spatulate, (3–)6–20 mm long, 1.5–5 mm wide, with l:w ratio 4–10, moderately to strongly and very gradually tapering basally to be (1/2–) 1/3–1/4 of leaf-width at base, gradually tapering distally, not arching, thin; margin flat, recurved or narrowly revolute, densely hairy throughout or absent proximally; apex mostly acute, occasionally subacute to obtuse, without a hyaline apiculate extension; terminal hair generally not present, but several short hairs continuous with marginal hairs usually present; upper surface dull to sublustrous, usually not wrinkled on drying, with midrib weakly defined, without acute epidermal projections; usually with scattered antrorse hairs; pale patch distinct, 0.1–0.3 mm long, occasionally purple-rimmed; abaxial midrib slender, raised for most of length, usually recessed relative to margin, with scattered fairly broad-based hairs. *Cymes* of several to numerous flowers; primary peduncle usually moderately elongate; intermediate peduncles often elongate; ultimate peduncles of complex cymes mostly 0.2–2 mm long. *Flowers*: corolla glabrous; ovary c. circular in face view, with sinus shallow; male flowers: corolla c. 3–4.5 mm long, with tube 1.5–2.5 mm long;

anthers 0.6–0.7 mm long, c. equal to or slightly longer than filament; ovary c. 0.5 mm long; female flowers: corolla c. 1–2 mm long, with tube 0.5–1 mm long; ovary 0.8–1.2 mm long; style 2.0–2.2 mm long, with arms 0.5–1 mm long. *Fruit* (based on very limited material) 2–3 mm long.

*Flowers* summer.

**Selected specimens: NEW SOUTH WALES.** Claymore Creek aqueduct intake, Watsons Crag Spur, Snowy Mountains, *J.I.Raine ANU10320*, 28.xi.1970 (CANB, NSW); W side of Geehi Dam, 2.5 km N of dam wall, *A.Rodd 764*, 31.xii.1968 (NSW). **VICTORIA.** Roadside c. 0.8 km short of Gerraty's Car Park, Lake Mountain, *I.R.Thompson 888*, 19.i.2006 (AD, CANB, HO, MEL); Between Howmans Gap and Falls Creek, *H.I.Aston 220*, 29.xii.1958 (MEL); North Nelse Creek, S of Spion Kopje, *A.C.Beauglehole 22332*, 23.i.1967 (MEL); Mt Buffalo National park, 22.4 km from Porepunkah, *E.M.Canning 3352*, 9.xii.1972 (CANB, MEL); Duane Track between Big River and Mt Nelse summit, *M.U.M.C.*, 30.xii.1964 (CANB); Eskdale Spur, c. 2.5 km N of Mt Bogong, *A.Rodd 407*, 31.xii.1966 (NSW); NW edge of Mt Baw Baw plateau, *J.H.Willis*, 3.xi.1940 (MEL: reference collection); Bright, *K.J.Simpfendorfer*, Oct. 1943 (MEL: reference collection).

**Distribution and habitat:** Occurs in mountains of south-central and eastern Victoria, including the Healesville–Lake Mountain area, Mt Baw Baw, Mt Buffalo and the Bogong High Plains, and in far south-eastern New South Wales in the Snowy Mountains (Fig. 7).

**Notes:** Similar to *A. euryphylla* and also approaches *A. gunnii* in some respects. Curiously, approximately 80% of collections are of male plants. In other species of *Asperula*, the majority of collections are of female plants.

**Etymology:** The epithet refers to the whorls which tend to have more parts than in other species in sect. *Dioicae* (From Gk. *poly*, many; *mero*, part).

**15. *Asperula euryphylla*** Airy Shaw & Turrill, *Bull. Misc. Inform. Kew* 1928(3): 100 (1928)

**Type: VICTORIA.** Dandenong Ranges, *C.Walter*, 1893; holo: K; iso: NSW.

*Herbs* to c. 40 cm high. *Stems* 0.6–1.0 mm diam., sublustrous; sparingly branched; internodes to 60 mm long, mostly 10–50 mm long on branches; angles narrower than faces, with a moderately dense indumentum (mostly 50 or more hairs per mm of angle); hairs slightly to moderately retrorse, 0.05–0.1

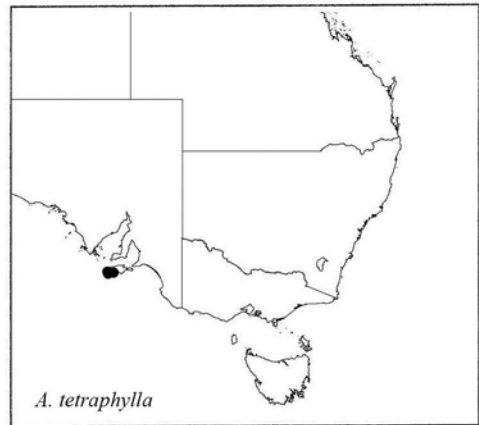
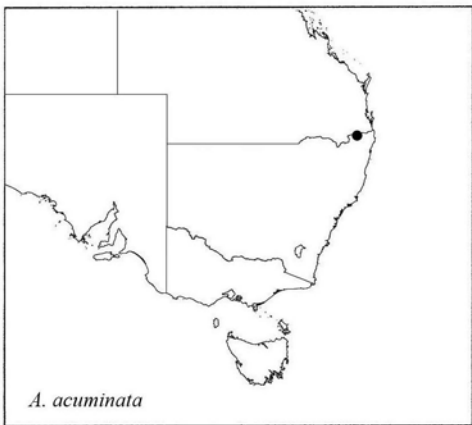
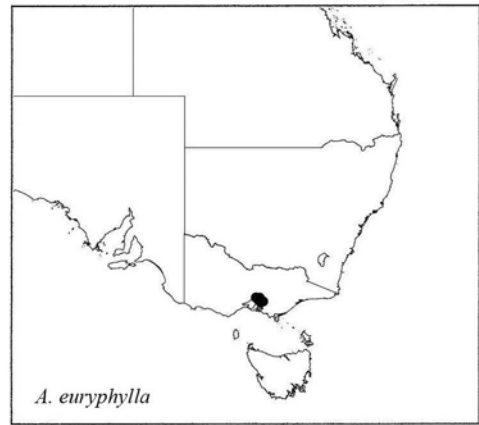
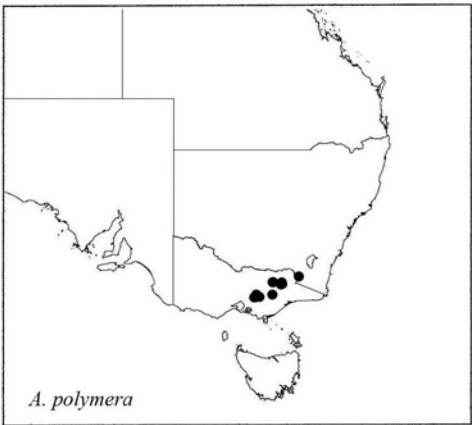
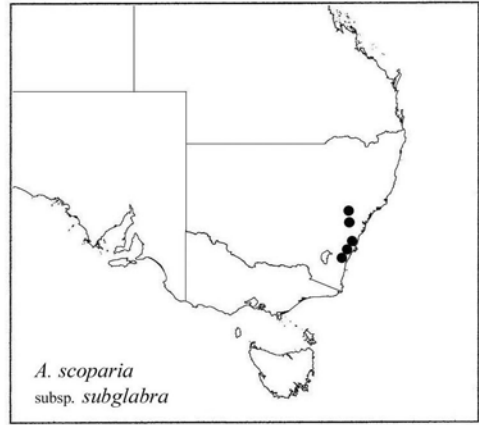
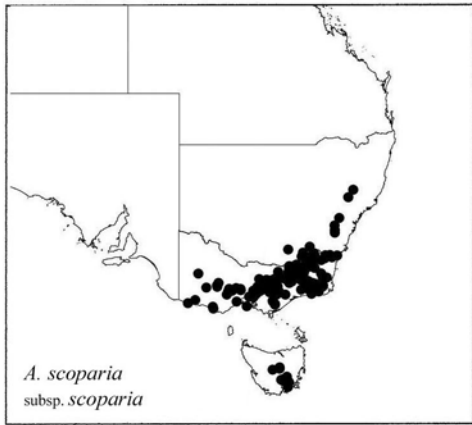

**Figure 7.** Distributions of *Asperula scoparia* subsp. *scoparia*, *A. scoparia* subsp. *subglabra*, *A. polymera*, *A. euryphylla*, *A. acuminata*, *A. tetraphylla*.

mm long, narrow- to fairly broad-based, straight; whorls all 6-partite, or rarely 1 or 2 whorls 7-partite, with stipules c. equal to leaf length. *Leaves* spreading or angled forwards, narrow-elliptic, narrow-obovate, oblanceolate or spatulate, 4–15 mm long, 1.5–6 mm wide, with l:w ratio 2–4, tapering strongly and gradually basally to be mostly 1/4–1/8 of leaf-width at base, gradually tapering distally, generally unarched, thin; margin flat, recurved or narrowly revolute, densely hairy except proximally; apex acute to obtuse, occasionally rounded, without a hyaline apiculate extension; terminal hair usually not present, but numerous short hairs continuous with marginal hairs usually present; upper surface dull to sublustrous, not wrinkled on drying, with midrib weakly defined, without acute epidermal projections, glabrous or more often with scattered antrorse hairs especially distally; pale patch distinct, narrow-elliptic to obovate, without purple coloration; abaxial midrib slender, raised for most of length, usually recessed relative to margin, with scattered moderately broad-based hairs. *Cymes* of several to numerous flowers; primary and intermediate peduncles commonly moderately elongate; ultimate peduncles of complex cymes mostly 0.2–2 mm long. *Flowers*: corolla glabrous or occasionally with a few hairs; ovary c. circular in face view, with sinus shallow, rarely with a few hairs; male flowers: corolla c. 2.5–4 mm long, with tube 1.0–2.0 mm long; anthers 0.4–0.5 mm long, slightly shorter than filament; ovary c. 0.5 mm long; female flowers: corolla c. 1–2 mm long, with tube 0.5–0.7 mm long; ovary c. 0.8 mm long; style 1.5–2 mm long, with arms 0.2–1 mm long. *Fruit* 1.8–2 mm long.

*Flowers* mid-spring to early summer.

**Selected specimens:** VICTORIA. Dandenong Regional Park, *A.C.Beauglehole* 71586 & *D.V.Beardsell*, 19.xi.1982 (MEL, NSW); Lyrebird Track, Ferntree Gully National Park, *I.R.Thompson* 862, 18.xi.2005 (MEL); Dandenong Ranges, Belgrave, *J.C.Kissane*, 29.ix.1984 (CANB, HO, MEL); Lilydale, *A.H.S.Lucas*, Nov. 1885 (NSW).

**Distribution and habitat:** Occurs on or near the Dandenong Ranges in south-central Victoria (Fig. 7). Grows in wet sclerophyll forest.

**Notes:** One of four species of *Asperula* sect. *Dioicae* with relatively broad leaves and stipules and dense indumentum of fine hairs on stem-angles and leaf margins. The other three, *A. acuminata*, *A. polymera*

and *A. tetraphylla* can be distinguished by differences in whorl number, leaf shape and indumentum.

## 16. *Asperula acuminata* I.Thomps., sp. nov.

*Ab A. euryphylla* *Airy Shaw & Turrill pilis caulium retrocurvis, foliis acuminatis, area pallenti folii indistincta, pilis costarum abaxialium longioribus differt.*

**Type:** NEW SOUTH WALES. North Obelisk, 2 km W of Urbenville, *A.R.Bean* 2468, 13 October 1990; holotype: NSW; iso: BRI.

*Herbs* to c. 20 cm high. *Stems* 0.6–1.0 mm diam., sublustrous; sparingly branched; internodes to 60 mm long, mostly 10–50 mm long on branches; angles narrower than faces, with a dense indumentum (50 or more hairs per mm of angle); hairs slightly to moderately retrorse, 0.05–0.1 mm long, narrow- to fairly broad-based, recurved; whorls 6-partite, with stipules c. equal to leaf length. *Leaves* spreading or angled forwards, narrow-elliptic to elliptic, or slightly obovate, 10–14 mm long, 3–6 mm wide, with l:w ratio 2–3, tapering strongly and gradually basally to be mostly 1/4–1/8 of leaf-width at base, tapering moderately distally, not arching, thin; margin recurved or narrowly revolute, densely hairy except in distal 1 mm; apex acuminate but not hyaline; a terminal hair or hairs present; upper surface dull to sublustrous, not wrinkled on drying, with midrib well-defined, without acute epidermal projections, with scattered to dense minute antrorse hairs mostly restricted to midrib and nearer margin; pale patch absent or indistinct, without purple coloration; abaxial midrib slender, raised for most of length, usually recessed relative to margin, with c. 10–20 hairs c. 0.2–0.3 mm long. *Cymes* of several to numerous flowers; primary and intermediate peduncles commonly moderately elongate; ultimate peduncles of complex cymes mostly 0.2–2 mm long. *Flowers*: corolla glabrous; ovary c. circular in face view, with sinus shallow; male flowers: corolla c. 2.0–2.5 mm long, with tube 1.0–1.2 mm long; anthers 0.3–0.4 mm long, c. as long as filament; ovary c. 0.5 mm long; female flowers: corolla c. 1–1.5 mm long, with tube 0.5–0.7 mm long; ovary 0.6–0.8 mm long; style 1.0–1.5 mm long, with arms 0.2–0.4 mm long. *Fruit* not seen.

*Flowers* mid-spring.

**Distribution and habitat:** Occurs in far north-eastern New South Wales near Urbenville (Fig. 7).

Grows in *Eucalyptus propinqua* H.Deane & Maiden and *E. microcorys* F.Muell. forest.

**Notes:** Known only from the type collection. The holotype collection has pieces of both female and male plants, whereas the isotype collection has only male plants. It appears to be most closely related to *A. euryphylla* based on overall leaf shape and in having whorls maximally 6-partite.

**Etymology:** The epithet refers to the shape of the leaf apex (from *L. acuminatus*, acuminate).

### 17. *Asperula tetraphylla* (Airy Shaw & Turrill)

I.Thomps., *stat. nov.*

*Asperula euryphylla* var. *tetraphylla* Airy Shaw & Turrill, *Bull. Misc. Inform. Kew* 1928(3): 100 (1928)

**Type:** SOUTH AUSTRALIA. Kangaroo Island, O.Tepper, 1886; holo: K, images MEL.

*Herbs* 5–20 cm high. *Stems* c. 0.5 mm diam.; sparingly branched; internodes to 20 mm long, mostly 5–10 mm long on branches; angles narrower than faces, with a variably dense indumentum (mostly 20–50 hairs per mm of angle); hairs slightly to moderately retrorse, 0.1–0.2 mm long, medium to broad-based, straight or slightly to moderately recurved; whorls 4-partite. *Leaves* spreading or at first angled upwards, broad-elliptic, broad-ovate or rotund, 2–6 mm long, 1.5–6 mm wide, with l:w ratio 1–2, tapering strongly basally to be 1/10–1/4 of leaf-width at base, tapering strongly distally, not arching, thin to slightly fleshy; margin flat, recurved or narrowly revolute, with several to numerous spreading to slightly antrorse, straight or weakly curved hairs, generally absent or few in distal 1/5; apex subacute to rounded, without a hyaline apiculate extension; terminal hair not developed; upper surface dull, not wrinkled on drying, with midrib weakly defined, with acute epidermal projections evident on distal margin, usually with short antrorse hairs near margins; pale patch mostly inconspicuous, to 0.1 mm wide and with l:w ratio 1–2; lower surface slightly paler than upper; abaxial midrib slender, slightly raised proximally to be c. at level of margin, with few to numerous hairs. *Cymes* of several flowers; primary and intermediate peduncles short or occasionally mildly elongate; ultimate peduncles of complex cymes subsessile to c. 1.5 mm long. *Flowers:* corolla glabrous; ovary c. circular or broad-elliptic in face view, with sinus shallow to

moderate; male flowers: corolla c. 2–3.5 mm long, with tube 1–2 mm long; anthers 0.4–0.6 mm long, c. as long as filaments; ovary 0.8–1.0 mm long; female flowers: corolla c. 1.5–2.5 mm long, with tube 0.5–0.9 mm long; ovary c. 1 mm long; style 1.2–2 mm long, with arms 0.2–0.4 mm long. *Fruit* 1.8–2 mm long.

*Flowers* spring.

**Selected specimens:** SOUTH AUSTRALIA. Stun'sail Boom River, c. 68 km SW of Kingscote, Kangaroo Island, P.G.Wilson 881, 12.xi.1958 (AD); 12 km E of Karatta, Kangaroo Island, P.Copley, C.Baxter & R.Furner NPKE 20444, 12.xi.1989 (AD); Rocky River, Kangaroo Island, J.B.Cleland, 18.xi.1924 (MEL).

**Distribution and habitat:** Occurs in the eastern half of Kangaroo Island in south-eastern South Australia (Fig. 7). Grows in riparian forest.

**Notes:** A distinctive species in habit and leaf morphology. In leaf and whorl morphology it resembles *Galium ciliare*, but the leaves lack glandular cells. Compared to other species of *Asperula* sect. *Dioicae* with moderately long corollas, the flowers of this species are less dimorphic and the corolla-tube is relatively long. The pistil in male flowers is relatively large.

### 18. *Asperula gunnii* Hook.f., in W.J.Hooker, *London J. Bot.* 6: 464 bis (1847)

*A. oligantha* var. *gunnii* (Hook.f.) Maiden & Betche, in J.H.Maiden & E.Betche, *Census New South Wales Pl.*: 188 (1916), *nom. illeg.*

**Type:** TASMANIA. Nive R., R.C.Gunn s.n., Oct. 1840; holo: K, images MEL.

*Galium curtum* Hook.f., in W.J.Hooker, *London J. Bot.* 6: 462 bis (1847); *Asperula gunnii* var. *curta* (Hook.f.) Airy Shaw & Turrill, *Bull. Misc. Inform. Kew* 1928(3): 89 (1928). *Type:* Tasmania: Hampshire Hills, R.C.Gunn 892, 1837; holo: K, images MEL.

*Herbs* to c. 20 cm high. *Stems* c. 0.5 mm diam.; usually sparingly branched; internodes to 40 mm long, mostly 2–15 mm long on branches; angles narrower than faces, sometimes only slightly so, with indumentum usually moderately dense, occasionally somewhat sparsely indumented and rarely largely glabrescent (up to c. 50 per mm of angle, mostly > 20); hairs slightly retrorse, 0.05–0.1(–0.15) mm long, usually narrow-based, weakly to strongly recurved; whorls 4–6 partite, rarely one or two 7-partite, with stipules c. equal to leaf length. *Leaves* spreading or ascending, narrow to very narrow-

elliptic, narrow-obovate, or oblanceolate, occasionally narrow-oblong, occasionally spatulate, 2–9 mm long, 0.8–3 mm wide, with l:w ratio (1.5–)2–6(–9), tapering gradually basally to be 1/4–2/5 of leaf-width at base, tapering gradually distally, not arching, slightly fleshy; margin recurved to narrowly revolute, glabrous or with a few to several or occasionally numerous, spreading, straight to incurved hairs generally confined to middle 3/5; apex acute, obtuse or rounded, occasionally with an acuminate hyaline extension to c. 0.1 mm long; terminal hair usually not developed, to c. 0.1 mm long when present; upper surface sublustrous to lustrous, more or less smooth on drying, with midrib weakly defined, with acute epidermal projections usually evident along margin distally; glabrous or uncommonly with a few hairs submarginally; pale patch distinct, circular to elliptic, often purple-rimmed; abaxial midrib slender, not raised or not raised throughout, recessed below margins, glabrous. *Cymes* of few to several flowers, generally congested; primary and intermediate peduncles generally short; ultimate peduncles of complex cymes mostly sessile to c. 1.5 mm long. *Flowers*: corolla glabrous; ovary circular, broad-obovate or slightly oblate in face view, with sinus shallow; male flowers: corolla c. 2–3.5 mm long, with tube 1–1.5 mm long; anthers 0.25–0.35 mm long, mostly 2/5–1/2 of length of filament; ovary 0.4–0.7 mm long; female flowers: corolla c. 1–2 mm long, with tube 0.3–0.8 mm long; ovary 0.8–1 mm long; style 1.2–2.0 mm long, with arms 0.1–0.6 mm long. *Fruit* 1.8–2 mm long.

*Flowers* late spring, summer and early autumn.

**Selected specimens:** **NEW SOUTH WALES.** SW end of Polblue Swamp, Barrington Tops Plateau, Stewarts Brook State Forest, *P.G.Kodala 301*, 24.iv.1994 (AD, NSW); East Barrington Tops, c. 64 km N of Singleton, *R.Schodde 3220*, 3.ii.1963 (CANB); Junction Pools, Barrington Tops National Park, *J.R.Hosking 2684*, 20.ii.2006 (CANB, MEL, NSW); Wingecarribee Swamp, *L.A.Craven 1984*, 26.x.1971 (CANB); E end of McPherson Plain, Bago SF, 42.4 km SE of Tumbarumba, *P.C.Jobson 6433 & G.T.Chandler*, 28.i.2000 (CANB, NSW); Swamp S of Big Badja Mountain, c. 35 km NE of Cooma, *R.Pullen 8563*, 31.x.1973 (CANB); Head of Bung Harris Ck, Gurrangorambla Ra., Kosciuszko National Park, *F.E.Davies 1750*, 12.i.1994 (CANB, NSW); Yaoul Creek, Scabby Range Nature Reserve, 5.3 km SW of Gudgenby trig, 1110 m, *I.Crawford 7275*, 8.i.2003 (CANB); 3 miles (5 km) E of Round Mountain, WSW of Ebor, *J.B.Williams*, 19.xii.1972 (NSW). **AUSTRALIAN CAPITAL TERRITORY.** Ginini

Swamp, *N.T.Burbidge 7733*, Feb. 1969 (CANB); Cotter Flats, Namadji National Park, 1030 m, *P.Gilmour 6283*, 18.xi.1987 (CANB). **VICTORIA.** Bidwill, Delegate R., *W.Hunter*, Feb. 1942 (MEL); Wonangatta R., Alpine National Park, *E.A.Chesterfield 2584*, 1.xii.1989 (AD, MEL); 26 km N of Mansfield, Mt Samaria State Park, *A.D.J.Piessie 547*, 26.xi.1986 (MEL); Licola-Jamieson Rd, near Mt Skene, *P.Geary*, 9.xii.1990 (MEL); Mt Buffalo, track to Eagle Point, *M.A.Todd 188*, 18.xii.1973 (MEL); near Wilkinson Lodge, Bogong High Plains, c. 1700 m, *T.B.Muir 2808*, 26.ii.1963 (MEL); The Bluff, c. 12 km SE of Mt Buller, *T.B.Muir 959*, 28.xii.1959 (MEL); Reedy creek, *N.A.Wakefield 3129*, Nov. 1947 (MEL); East Wingan Rd, c. midway between Princes Hwy and Wingan Link track, *A.C.Beauglehole 32703*, 22.xii.1969 (MEL); Mt Loch, *N.C.Ford*, 12.i.1959 (NSW). **TASMANIA.** Northern end of Picketts Plain, *A.Moscal 4063*, 15.xi.1983 (AD, HO, MEL); Summit of Table Mountain, *F.E.Davies 936 & P.Ollerenshaw*, 17.i.1992 (CANB, MEL).

**Distribution and habitat:** Occurs in eastern New South Wales, mostly in the southern half but extending as far north as Ebor, the Australian Capital Territory, eastern Victoria, and Tasmania (Fig. 8). Grows in woodland, grasslands, sedgeland and herbfields, often in or near swamps, mostly sub-alpine to alpine, but also at low elevations near coasts.

**Notes:** *Asperula gunnii* often grows among grasses and sedges in which case the stems are widely separated. Apparently sweet smelling according to label information in *W.Curtis*, HO 52213. Forms of *A. gunnii* that are relatively elongate, with predominantly 4-partite whorls and leaves with a relatively high length:width ratio and with a narrower pale patch, and sometimes with a sparse stem indumentum have been recorded from lower altitudes, e.g. Picketts Plains, far north-eastern Tasmania and Genoa in East Gippsland, Victoria, or from lower latitudes, e.g. Ebor, Barrington Tops, Blue Mountains, Wingecarribee Swamp in central eastern New South Wales. Plants from these more northern New South Wales localities also tend to have leaves with more hairs on the margins and sometimes a minutely acuminate apex. These forms are not considered worthy of taxonomic recognition, however, as they are connected through many intermediates to the typical alpine or subalpine forms from Tasmania, the eastern Highlands of Victoria, the Brindabella Ranges and the southern tablelands of New South Wales and the Australian Capital Territory.

*Asperula gunnii* var. *curta* also does not warrant taxonomic recognition. Occasional plants of *A. gunnii*

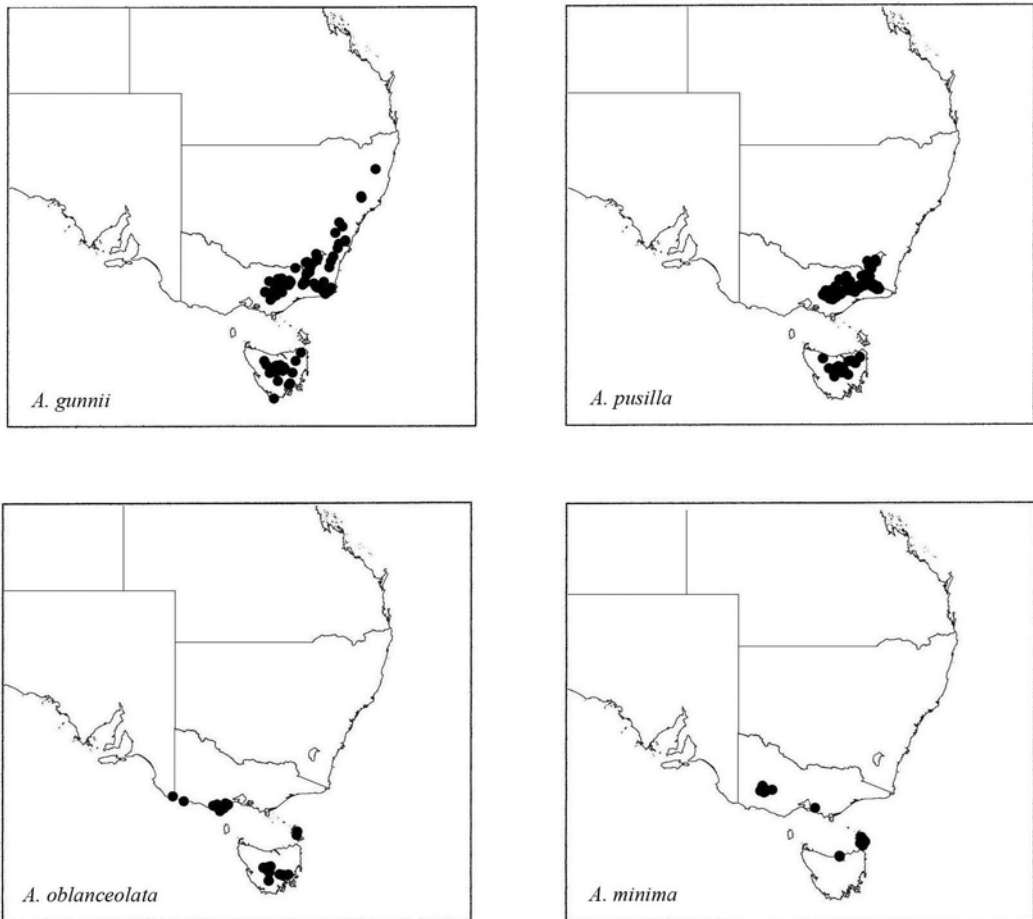

**Figure 8.** Distributions of *Asperula gunnii*, *A. pusilla*, *A. oblanceolata*, *A. minima*.

develop hairs on the upper surface of leaves near margins and fairly commonly on the margins, as mentioned above, but this feature, which is evident in var. *curta*, does not correlate with any other unusual feature in these plants.

*Asperula gunnii* and *A. pusilla* occupy similar habitats and can grow together in montane to alpine areas. *Asperula gunnii* can be distinguished from *A. pusilla* by its retrorsely curved stem hairs and by its more elliptic leaves that do not curve downwards. Mostly *A. gunnii* has leaves with a glabrous upper surface in contrast to *A. pusilla*. Also, close inspection generally shows that the distalmost 0.5 mm of the margin of leaves in *A. gunnii* is hairless, whereas there are generally a few hairs in the same region in *A. pusilla* even when the upper surface is glabrous.

*Hybrids:* Although occupying similar habitats, hybrids between *A. gunnii* and *A. pusilla* appear to be rare. The only example recorded is from Mt Stirling in Victoria (*M.G. Corrick 8007 MEL*).

**19. *Asperula pusilla*** Hook.f., in W.J. Hooker, *London J. Bot.* 6: 463 bis (1847)

*A. gunnii* var. *pusilla* (Hook.f.) Benth., *Fl. Austral.* 3: 445 (1867).

**Type: TASMANIA.** Hampshire Hills, *R.C. Gunn 557*, 891, February 1837; holo: K, images MEL; iso: HO.

*Herbs* mostly 5–20 cm high. *Stems* 0.3–0.8 mm diam., commonly much-branched; internodes to 20 mm long, mostly 1–10 mm long on branches; angles narrower than faces, glabrous or with a variably dense indumentum

(often up to 10 per mm of angle, sometimes to c. 30); hairs 0.05–0.3 mm long, spreading to slightly retrorse, 0.05–0.2 (–0.3) mm long narrow-based, or sometimes broad-based but narrow for most of length, straight, or longer hairs curved; whorls usually all 6-partite, occasionally a small proportion 5-, 7- or 8-partite, with stipules c. equal to leaf length. *Leaves* spreading or somewhat pendent, narrow- to very narrow-oblong, sometimes weakly narrow oblong-oblancheolate or narrow oblong-elliptic, 1–9 mm long, 0.3–1.8 mm wide, with l:w ratio 3–8(–10), tapering gradually basally to be 1/3–3/5 of leaf-width at base, tapering somewhat abruptly distally, commonly a proportion downcurved to rolled under distally, fairly thin; margin recurved or narrowly revolute, with several to numerous spreading hairs extending throughout, rarely nearly glabrous; apex acute to rounded, occasionally with an acuminate hyaline extension to c. 0.1 mm long; terminal hair(s) 0.05–0.2 (–0.3) mm long; upper surface sublustrous to lustrous, usually shallowly and irregularly wrinkled on drying, with midrib weakly defined, with acute epidermal projections not developed; with scattered to crowded generally somewhat antrorse hairs mostly 0.05–1 mm long, occasionally longer, generally more abundant distally, rarely near-glabrous; pale patch sometimes obscure, c. circular, to c. 0.2 mm wide at very tip, sometimes purplish; abaxial midrib slender, not raised or raised proximally, recessed below margins, usually hairy. *Cymes* of (1–)few to several flowers; primary and intermediate peduncles short or sometimes mildly elongate; ultimate peduncles of complex cymes 0.5–1(–2) mm long. *Flowers*: corolla glabrous or hairy abaxially; ovary broad-elliptic to sub-circular in face view, with sinus shallow; male flowers: corolla 2–3 mm long, with tube 1–1.5 mm long; anthers 0.3–0.5 mm long, mostly 2/3–c. equal to length of filament; ovary c. 0.6 mm long; female flowers: corolla c. 1–2 mm long, with tube 0.4–0.7 mm long; ovary 0.6–1.2 mm long, sometimes with a few minute hairs; style 1.3–2.5 mm long, with arms 0.2–0.5 mm long. *Fruit* c. 2 mm long.

*Flowers* summer to early autumn.

**Selected specimens:** **NEW SOUTH WALES.** near Rawson Pass, Mt Kosciuszko area, *M.Gray* 6747 & *C.Totterdell*, 30.i.1974 (CANB, MEL, NSW). **VICTORIA.** Mt Torbreck, *D.E.Albrecht* 106, 6.i.1984 (MEL); Wild Dog Plains, Mt Buffalo National Park,

*P.S.Short* 1365, 26.xii.1982 (MEL); near Wallace's Hut, Bogong High Plains, *T.B.Muir* 665, 19.i.1959 (MEL); Cobberas No. 1, *A.C.Beauglehole* 36462 & *E.W.Finck*, 25.i.1971 (MEL, NSW); Mt Kernot, Baw Baw plateau, *S.J.Forbes* 2991, 25.i.1986 (MEL); Bonang-Bendoc forest road, near junction with playground road, *J.H.Willis*, 1.xii.1962 (MEL). **TASMANIA.** Weld Hill near Weld River, *W.M.Curtis*, 20.xi.1952 (HO, MEL); Waddamanna Rd, near Shannon River, *A.M.Buchanan* 15591, 1.xii.1999 (CANB, HO, MEL, NSW).

**Distribution and habitat:** Occurs in far south-eastern New South Wales, eastern Victoria, and central and northern Tasmania (Fig. 8). Grows in woodland, forest and grassland at altitudes between 500 m and 1700 m.

**Notes:** *Asperula pusilla* is commonly much branched and relatively densely leaved. It often dries very dark and has a somewhat glossy appearance under low magnification. Under magnification, the upper surface of leaves appears slightly mottled with the blackish pigment unevenly distributed. This is in contrast to the more evenly distributed dark colour seen in *A. gunnii*.

In East Gippsland a few specimens have been collected with unusually strongly oblanceolate leaves resembling those of *A. oblanceolata*, and one, Willis MEL 697269, has three consecutive 8-partite whorls. Prostrate, densely branched plants with crowded whorls of very small leaves, as in the type specimens, occur not uncommonly in Tasmania. Unusually for *Asperula* sect. *Dioicae* there are sometimes minute hairs on the ovaries of this species.

*Asperula pusilla*, *A. oblanceolata* and *A. minima* appear to form a group united by their thin leaves with a slender abaxial midrib and minute hairs on the upper surface, glabrous or generally sparsely indumented stems, and ovaries slightly longer than broad. *Asperula pusilla*, when compared to *A. minima*, has larger corollas and leaves that are narrower, more parallel-sided, with a more obtuse to rounded and/or recurved apex, and with more numerous and narrower-based hairs on the abaxial midrib. Inflorescences of *A. pusilla* are more congested than in *A. oblanceolata* and *A. minima*.

*Asperula conferta* has been confused with *A. pusilla*, and there is a small degree of overlap in their distributions. The upper surface of leaves of *A. conferta* never develop hairs distally, and they have a smoother glossy appearance down the middle of the leaf at least, the leaves have a more acute apex and the abaxial



midrib is more robust. Furthermore, the filaments of stamens of *A. conferta* are longer and styles, at least of forms potentially sympatric with *A. pusilla*, are longer. The ovaries of *A. conferta* are a little broader than long in face view, unlike in *A. pusilla*.

For differences between *A. pusilla* and the sometimes co-extensive *A. gunnii* see under notes for the latter.

**Hybrids:** Although occupying similar habitats, hybrids between *A. pusilla* and *A. gunnii* q.v. appear to be rare. A specimen from Butlers Gorge, Tasmania (G.C.Wade 3 HO) is a possible hybrid between *A. pusilla* and *A. conferta*.

## 20. *Asperula oblanceolata* I.Thomps., sp. nov.

*Ab A. pusilla* Hook.f. *foliis oblanceolatis, pilis sparsioribus et crassioribus basi, pilo terminali longiore differt; ab A. gunnii* Hook.f. *pilis caulium sparsioribus non retrocurvis, foliis tenuioribus, pilo terminali plerumque conspicuo differt; ab A. minima* Hook.f. *foliis latioribus, oblanceolatis, corolla longiore differt.*

**Type:** VICTORIA. Sheepwash Track, to E of Simpson-Lavers Hill Rd, c. 5 km S of Simpson, I.R.Thompson 918, 24 November 2006; holo: MEL; iso: AD, CANB, HO, NSW.

*A. gunnii sensu* J.A.Jeanes, *Fl. Victoria* 4: 619 (1999), p.p.  
**Herbs** to c. 20 cm high. **Stems** 0.3–0.7 mm diam., subglabrous to lustrous; sparingly branched; internodes to 40 mm long, mostly 3–20 mm long on branches; angles much narrower than faces, glabrous or with few hairs (up to c. 5 per mm of angle); hairs spreading to slightly retrorse, 0.1–0.3(–0.5) mm long, usually broad-based, straight; whorls all 6-partite, or sometimes a proportion 4- or 5-partite, rarely with a few whorls 7- or 8-partite, with stipules c. equal to leaf length. **Leaves** typically spreading, oblanceolate, 3–12 mm long, (0.5–)0.7–2 mm wide, with l:w ratio 3–7, tapering gradually to very gradually basally to be 1/4–1/3 of leaf-width at base, tapering somewhat abruptly distally, not arching, thin; margin recurved or narrowly revolute, glabrous or with a few to several spreading or antrorse hairs; apex acute to subacute, or occasional leaves obtuse, with acuminate extension usually pigmented, to c. 0.1 mm long; terminal hair(s) 0.1–0.4 mm long, commonly present; upper surface dull to subglabrous, not wrinkled but minutely and evenly granular, with midrib not or hardly defined, with acute epidermal projections not

developed, glabrous or with distal and near-marginal hairs c. 0.1 mm long; pale patch absent or c. 0.1 mm wide, a little longer than broad; abaxial midrib slender, not raised throughout length, recessed below margins, glabrous or with a few to several hairs. **Cymes** of few to several flowers; primary and intermediate peduncles often mildly to moderately elongate; ultimate peduncles of complex cymes mostly 1–2 mm long. **Flowers:** corolla usually glabrous; ovary broad-elliptic or broad-obovate in face view, with sinus shallow; male flowers: corolla c. 2.5–3.5 mm long, with tube 1–1.8 mm long; anthers 0.4–0.5 mm long, mostly 1/2–3/4 of length of filament; ovary 0.6–0.8 mm long; female flowers: corolla c. 1.5–2.5 mm long, with tube 0.5–1.0 mm long; ovary c. 1 mm long, glabrous; style 1.5–2 mm long with arms 0.3–0.8 mm long. **Fruit** c. 1.7–2 mm long.

**Flowers** spring.

**Selected specimens:** SOUTH AUSTRALIA. Port MacDonnell Swamp, R.J.Bates 26373, Nov. 1991 (AD, MEL). VICTORIA. 3 km NW of Kennett River and c. 20 km NE of Apollo Bay, Otway Ranges, T.B.Muir 4496, 9.xii.1966 (MEL); Bushland Reserve, 14 km SSW of Winchelsea PO, A.C.Beauglehole 63695, 22.i.1979 (MEL); 3.2 km S of Forrest, toward Apollo Bay, D.Verdon 381, 14.xi.1970 (CANB); Ironbark Basin reserve, near Point Addis, I.R.Thompson 850, 11.xi.2005 (MEL, NSW). TASMANIA. Memana summer camp, central Flinders Island, J.H.Willis, 13.iv.1954 (MEL); 1.4 km SW of Strzelecki Peaks, Flinders Island, I.Crawford 1139, 9.xii.1988 (BRI, CANB, HO); Tarraleah, W.M.Curtis, 7.ii.1945 (HO); Alpha Pinnacle RAP, A.North, 11.i.1996 (HO); Quoin Mountain, near summit, A.Moscal 12941, 25.v.1986 (CANB, HO); Bronte Lagoon, A.J.North, 23.xi.2004 (HO); Top Marshes, 5 km S of Little Pine Lagoon, A.Moscal 6429, 22.ii.1984 (HO); Weld River, c. 5 km E of Mt Bowes, A.Moscal 11427, 23.xi.1985 (CANB, HO); End of Florentine Rd, Florentine Valley, M.E.Phillips 954, 3.xii.1965 (CANB).

**Distribution and habitat:** Occurs in the Otway region of south-western Victoria, near Portland in far south-western Victoria, Port MacDonnell in far south-eastern South Australia, Flinders Island off the north-east coast of Tasmania, and in central to central-eastern Tasmania (Fig. 8). Grows in forest, shrubland and grassland, sometimes at lake margins.

**Notes:** Some Tasmanian collections of *A. oblanceolata* have only very slightly oblanceolate leaves and in general Tasmanian plants have a higher proportion of 4- and 5-partite whorls and more often have succulent

leaves. *Asperula oblanceolata* is closely related to *A. pusilla* q.v. and *A. minima* but can be distinguished from each of these species by a combination of features. It differs from both species by having a more sparsely indumented upper leaf surface. It differs from *A. pusilla* by having broader-based hairs, elliptic or oblanceolate leaves with a straight apex and with relatively longer terminal hairs. It differs from *A. minima* by having larger leaves, that are often oblanceolate, and by having a larger corolla.

*Asperula oblanceolata* has a similar leaf shape to *A. gunnii*. However, the stem indumentum of *A. gunnii* is markedly different in hair type and usually in density, its leaves are more conspicuously discolorous and generally firmer with a more conspicuous and often purple-rimmed pale patch, and terminal hairs are absent or minute. Cymes in *A. gunnii* are generally more congested.

*Hybrids*: An old specimen from Marlborough (Gunn HO 514089) may be a hybrid between *A. oblanceolata* and either *A. pusilla* or *A. gunnii*.

**Etymology**: The epithet refers to the typical leaf-shape of this species (from L: *oblanceolatus*, oblanceolate).

**21. *Asperula minima* Hook.f., in W.J.Hooker, London J. Bot. 6: 464 bis (1847)**

**Type**: TASMANIA. George Town, *R.C.Gunn 1251*, 20 November 1842; holo: K, images MEL; iso: HO.

*Herbs* to c. 10 cm high. *Stems* c. 0.3 mm diam., lustrous; usually moderately branched; internodes to 15 mm long on stems, mostly 1–8 mm long on branches; angles slender, much narrower than faces, glabrous or with few hairs (up to c. 5 per mm of angle); hairs spreading, 0.1–0.3 mm long, usually broad-based, mostly straight; whorls 6-partite, or sometimes a small proportion 5-partite, with stipules c. equal to leaf length. *Leaves* spreading or angled slightly upwards, sometimes becoming pendent, narrow-elliptic to slightly oblanceolate, sometimes narrow oblong-elliptic to narrow-oblong due to rolling of margins, 1–5 mm long, mostly 0.2–0.7 mm wide, occasional leaves to 1.0 mm wide, with l:w ratio 3–8, gradually tapering basally to be 1/3–1/2 of leaf-width at base, gradually tapering distally, not arching, thin; margin flat, recurved or revolute, glabrous or with a few spreading hairs; apex acute, sometimes with a hyaline acuminate

extension to c. 0.1 mm long; terminal hair(s) 0.05–0.2(–0.3) mm long or not developed; upper surface dull to sublustrous, a little wrinkled on drying, with midrib not defined, with acute epidermal projections not developed, with scattered hairs c. 0.1 mm long; pale patch minute, often not discernible; abaxial midrib slender, not raised throughout length, recessed below margins, commonly bearing a few to several robust hairs. *Cymes* of few to several flowers; primary and intermediate peduncles sometimes mildly elongate; ultimate peduncles of complex cymes 0.5–2 mm long, occasionally to 3 mm long. *Flowers*: corolla often bearing hairs abaxially; ovary broad-elliptic to circular in face view, with sinus hardly developed; male flowers: corolla c. 2–2.5 mm long, with tube 0.8–1.2 mm long; anthers 0.3–0.4 mm long, mostly 3/4–1 times length of filament; ovary 0.3–0.5 mm long; female flowers: corolla 0.8–1.5 mm long, with tube 0.2–0.5 mm long; ovary 0.5–0.7 mm long; style 1–2 mm long, with arms 0.1–0.5 mm long. *Fruit* 1.5–2 mm long.

*Flowers* spring to early summer

**Selected specimens**: VICTORIA. Camp 2, 12 km S of Halls Gap, *J.Carrick 2564*, 25.x.1969 (AD, MEL); gully N of Strachan's Tree Fern area, E Victoria Ra., Grampians, *A.C.Beaglehole 16120 & J.H.Willis*, 10.xii.1966 (MEL, NSW); 150 m S of East-West arm of Causeway Rd, French Island, *P.Gullan and S. van Berkel*, 1.xii.1980 (MEL); McDonald Park, Ararat, *A.C.Beaglehole 21851*, 15.xi.1966 (MEL); Mt Cassell, Mt William Ranges, Grampians, 11 km SE of Halls Gap, *H.Streimann*, 18.xii.1975 (CANB); Angahook-Lorne State Park, *A.C.Beaglehole 70204 & E.G.Errey*, 17.iii.1982 (MEL); c. 3 km along Redmans track, c. 5 km direct SSW of Pomonal, Grampians National Park, *I.R.Thompson 1019*, 18.xii.2007 (AD, BRI, CANB, HO, MEL, NSW, PERTH). TASMANIA. "Effingham" property E of Low Head, *M.Wapstra*, 2.xi.2006 (HO, MEL); S of Brougham Sugarloaf, Flinders Island, *P.Collier 810*, 20.x.1985 (HO); Vansittart Island, *S.Harris*, 6.xii.1986 (HO); Cape Barren Island, *J.S.Whinray 196*, 5.xi.1973 (AD).

**Distribution and habitat**: Occurs in and near the Grampians, in south-western Victoria, French Island in south-central Victoria, in far northern Tasmania, and on several islands off the north-eastern coast of Tasmania in Bass Strait (Fig. 8). [An 1853 record at MEL cites the Buffalo Ranges (presumably Mt Buffalo in the eastern highlands of Victoria), and a few 1840s records at HO cite Arthurs Lake in the Central Highlands of Tasmania. These localities are not accepted as genuine.] Grows in forest.

**Notes:** A distinctive feature of *A. minima* is the contrast of numerous minute hairs on the adaxial surface of leaves with the few, robust hairs on the abaxial midrib. It is perhaps most similar to *A. oblancoolata* but has smaller flowers and leaves that are narrower, more commonly narrow-elliptic with a moderately hairy upper surface.

## 2. *Galium* L., *Sp. Pl.* 1: 105 (1753)

### 2a. Species of *Galium* native to Australia

*Hermaphroditic perennial herbs*, rarely growing as annuals, variably rhizomatous; rhizomes slender with a papery bark. *Indumentum* of stems and leaves comprising hairs or scabrosities, often with two types of indumentum within a species. *Aerial stems*: remaining slender, angles slender to extremely broad; whorls all 4-partite, or rarely a few 5- or 6-partite, and occasionally more distal whorls 2-partite; stipules mostly subequal to or slightly shorter than leaves below inflorescences, sometimes becoming relatively shorter upwards. *Leaves* generally lacking a prominent terminal hair; upper surface without a pale patch near apex, with midrib often well-defined; lower surface mostly with glandular cells; glabrous, or with hairs on midrib only, or occasionally with scattered hairs. *Inflorescences* mostly elongate, extending for 5 or more nodes long, sometimes apparently indeterminate, occasionally terminating after only 1–4 nodes; cymes with flowers few to many, with overtopping sometimes marked; bracts predominantly absent or single at primary node. *Flowers*: corolla with tube hardly developed, pale yellow, cream, or greenish, often purple-red abaxially; anthers c. 0.2 mm long; ovary glabrous or hairy, sometimes with pustules, with epidermal cells producing a smooth, or a minutely areolate, bulliform or papillose appearance; hairs antrorse to spreading, short to long, narrow-based to broad-based, straight, curved apically or hooked apically, clear to whitish or sometimes with brownish pigment; style 0.2–0.5 mm long; stigmata c. 2 times as broad as style-arms. *Fruit*: peduncles straight or gently curved, or in *G. densum* markedly curved near apex; mericarps separating from one another, ellipsoid or reniform, 0.9–2.4 mm long, c. 0.5–1.3 mm wide with dissepiment scar 1/3–2/3 of length, pericarp mostly dry or only slightly fleshy, often shallowly rugose on drying.

**Breeding system:** A majority of species apparently inbreeding, but some outbreeding, as judged by the percentage fruit-set.

**Distribution:** Occurs mostly in the south-eastern quarter of Australia, with a few species extending further north to central-eastern and north-eastern Queensland, and with *G. leptogonium* extending much further west across far southern Western Australia.

**Notes:** Australian species of *Galium* form a rather uniform group. Native species of *Galium* from New Zealand can comfortably be accommodated within this group. Taxonomically reliable characters come predominantly from ovary and fruit morphology, including size, shape, fleshiness, dissepiment length, epidermal cell pattern, ornamentation and indumentum. Other characters that are useful taxonomically include stem-angle thickness, corolla size and pigmentation, hair-type, stipule length, inflorescence type, cyme length relative to whorls, and peduncle length and insertion position. It is not unusual for two or more species to occur together and in these circumstances hybridisation or introgression is likely. A small proportion of specimens seen in this study (see listings under each species) were intermediate in morphology between two species known to be sympatric, and these have been determined as likely hybrids. Specific investigations to clarify the extent of hybridisation in *Galium* are much needed.

Table 1 (p. 40) provides a summary of those characters that can help to distinguish this group from *Asperula* sect. *Dioicae*.

#### **Notes on morphology:**

**HABIT:** All or most species appear to be potentially rhizomatous given the right environmental conditions. Species of moister habitats like *G. leiocarpum* and *G. ciliare* normally develop extensive rhizomes, whereas those of drier sites usually become multistemmed from a stout rootstock, e.g. *G. migrans* and *G. gaudichaudii*.

**STEMS** (Fig. 1): Angles of stems and branches are of varying breadth, and this character is useful taxonomically. However, there is some within-plant variation depending on age of the axis and whether the angles are on stem or branch. In species with very broad angles such as *G. migrans* subsp. *inversum*, the faces are obliterated or reduced to narrow grooves and the angles themselves appear like faces.

INDUMENTUM (Fig. 1): Indumentum of stem and leaves is difficult to interpret in *Galium*. Density varies greatly within and between plants and the hair morphology often varies within a single plant. A typical pattern is for a species to develop either hairs that are generally spreading or nearly so or shorter, broader-based and more retrorse hairs or scabrosities. Both forms often appear on the same plant. There does appear to be limits on maximal hair length and in the broadness of the base of scabrosities, and so the indumentum does have limited taxonomic value.

LEAVES (Fig. 2.): Major trends in leaf shape are shown in figure 2. The most common general shape is shown in 2d, iii. – an elliptic-type lamina tapering gradually into a short petiolar region. The other three illustrations indicate less common shapes occurring in only one or a few species. The main trends in the pattern of glandular cells are also shown in these illustrations. Glandular cells are evident on the abaxial surface of leaves, stipules and cyme-bracts of all species except *G. liratum* and *G. spathulatum*. Generally the cells are less conspicuous in leaves at lower nodes. The same cells are also developed on the abaxial surface of petals in most species. Glandular cells are filled with a whitish material which becomes clear to honey coloured or occasionally pinkish on drying. Although termed secretory cells by McGillivray (1981), they do not appear to secrete this material. Several to many glandular cells coalesce to form a patch toward the apex of leaves in all species that have glandular cells. In many cases this results in the leaves of dried specimens being puckered at the apex. Further from the apex, scattered glandular cells are sometimes present and variably conspicuous. In a few species, notably *G. gaudichaudii* and *G. compactum*, glandular cells can cover most of the abaxial surface of leaves. Opaque pale streaks of similar dimensions to glandular cells are often also seen on the abaxial surface of leaves and stipules. These should not be confused with glandular cells.

INFLORESCENCES AND CYMES (Fig. 3): Inflorescences are a raceme of cymes. Primary inflorescences develop on the axis of current year's stems or long branches. Secondary inflorescences arise from branches at nodes below a primary inflorescence. In this paper a secondary inflorescence is distinguished from a cyme by the presence of a sequence of two or more nodes with

normal whorl development. Primary inflorescences comprising terminal cymes and up to 4 axillary cymes below are described as soon-terminating. More common is for primary inflorescences to be 5 or more nodes long and tending to be indeterminate; these inflorescences are described as extended. Secondary inflorescences follow the same pattern but are shorter.

At any node cymes may arise from axils of one or both leaves, and sometimes, and usually some time later, a third cyme can develop. Solitary-flowered cymes occur, but more often cymes are multi-flowered. The branching pattern in cymes is commonly initially dichasial giving way to monochasial distally, but may be monochasial throughout. All branch elements are termed peduncles (See fig. 3c for more terminology). Insertion points on a peduncle are mostly in the distal half but in *G. leiocarpum* it is mostly in the proximal half and in 2-flowered cymes the ultimate peduncle often inserts at the base of the primary peduncle. The degree of overtopping of flowers in a cyme is often a function of how distal the insertion point is. In some cymes all flowers open at more or less the same time, whereas in others there is a progression of development. This progression is generally most conspicuous in *G. migrans* and *G. curvihirtum*.

Bracts are variably developed at cyme-nodes. Their frequency of appearance and their size is of some value in discriminating species. In *G. bulliformis*, bracts may arise from otherwise dormant nodes along ultimate peduncles (fig. 3vii).

FLOWERS AND FRUIT (Fig. 4): There are two layers of complexity in the surface texture of ovaries and fruit. It is important to distinguish ornamentation such as pustules and tubercles from the underlying epidermal cell pattern. For pustular and tubercular surfaces, approximately 20 to 50 can be seen in a view of one face of a carpel or mericarp, and generally space is evident between individual structures. The term pustule is used here simply to indicate a low domed structure; nothing is implied about its content. Epidermal cells are variably raised and the surface pattern varies from smooth, to areolate, to bulliform to papillose depending on degree of convexity. In many species the mericarps develop rugae as they dry. These vary in depth and thickness depending on the species and may partly obscure the pattern of epidermal cells

**Key to native species of *Galium***

Notes for key:

- identification will normally require magnification
- all measurements are based on herbarium specimens
- surface features of ovaries are generally best assessed when corolla has withered or fallen
- for terminology refer to notes above and figures 1–4 (pp. 41–44)

<b>1</b>	Fruit with spreading hairs regularly hooked at the very tip <u>and</u> extending 0.3 mm or more out from surface (hairs somewhat antrorse-appressed early in flowering) .....	<b>2</b>
<b>1:</b>	Fruit glabrous or hairs not entirely as above .....	<b>4</b>
<b>2</b>	Corolla $\geq$ 4 mm diam., with lobes hairy abaxially; erect corolla 1.8–3.0 mm long; mericarps 1.6–2.4 mm long; stems, leaves and peduncles densely hairy with fine spreading hairs generally $>$ 0.5 mm long .....	<b>4. <i>G. albescens</i></b>
<b>2:</b>	Corolla $<$ 4 mm diam., glabrous; erect corolla 0.7–1.5 mm long; mericarps 1.0–1.4 mm long; stems, leaves and peduncles with indumentum various, uncommonly both densely hairy and with hairs $>$ 0.5 mm long .....	<b>3</b>
<b>3</b>	Longest intermediate or ultimate peduncles in an inflorescence $>$ 5 mm long, becoming curved to hooked c. 1 mm below summit post-flowering; inflorescences soon terminating; fruit with hairs $\geq$ 0.5 mm long .....	<b>5. <i>G. densum</i></b>
<b>3:</b>	Longest intermediate or ultimate peduncle in an inflorescence $<$ 5 mm long, remaining straight; inflorescences mostly extended; fruit with hairs $\leq$ 0.5 mm long .....	<b>3. <i>G. australe</i></b>
<b>4</b>	Leaves, stipules and bracts lacking glandular cells; mericarps longitudinally rugose (leaves large and tending to spathulate with conspicuous petiole-like portions; far eastern forests) .....	<b>5</b>
<b>4:</b>	Leaves, stipules and bracts in inflorescences developing glandular cells; mericarps not rugose or rugae reticulate .....	<b>8</b>
<b>5</b>	Cymes much shorter than whorls .....	<b>1. <i>G. liratum</i></b>
<b>5:</b>	Cymes c. equal to or longer than whorls .....	<b>6</b>
<b>6</b>	Leaves with l:w ratio $>$ 3.5 (narrow-elliptic or oblanceolate, sometimes slightly spathulate); developing and mature fruit with a more or less smooth surface (New Zealand) .....	<b><i>G. trilobum</i></b> (see 1.)
<b>6:</b>	Leaves with l:w ratio $<$ 3.5 (narrowly to broadly spathulate); developing fruit bulliform .....	<b>7</b>
<b>7</b>	Leaves to 20 mm long, broad-spathulate with apex mostly obtuse to rounded except for a minute acuminate point; cymes mostly $>$ 4-flowered; fruit acutely bulliform .....	<b>2. <i>G. spathulatum</i></b>
<b>7:</b>	Leaves to 10 mm long, mostly narrow-spathulate with apex acuminate; cymes 1–4-flowered; fruit rounded bulliform (New Zealand) .....	<b><i>G. sp.</i></b> (see 1.)
<b>8</b>	Stem-angles broader than faces (examine axis of primary inflorescences) .....	<b>9</b>
<b>8:</b>	Stem-angles narrower than faces (examine axis of primary inflorescences) .....	<b>12</b>
<b>9</b>	Longest ultimate peduncle $<$ 2 mm long .....	<b>10</b>
<b>9:</b>	Longest ultimate peduncle $>$ 2 mm long .....	<b>11</b>
<b>10</b>	Ovaries dull, smooth except for scattered pustules (south-eastern New South Wales) .....	<b>8. <i>G. roddii</i></b>
<b>10:</b>	Ovaries without pustules but with a glistening minutely papillose surface (South Australia and southern Victoria) .....	<b>16. <i>G. compactum</i></b>
<b>11</b>	Ovaries with hairs 0.3–0.6 mm long (Central Tablelands of New South Wales) .....	<b>14. <i>G. bungoniensis</i></b>
<b>11:</b>	Ovaries glabrous or with hairs 0.1–0.2 mm long (Flinders Ranges of South Australia) .....	<b>15. <i>G. migrans</i></b>
<b>12</b>	Whorls below primary inflorescences with stipules less than half length of leaves; corolla to 1.6 mm diam. ....	<b>12a. <i>G. binifolium</i></b> subsp. <b><i>binifolium</i></b>
<b>12:</b>	Whorls below primary inflorescences with stipules more than half length of leaves; corolla diameter various, up to 4 mm diam. ....	<b>13</b>
<b>13</b>	Corolla c. 1 mm diam.; cymes mostly 4- or more-flowered and exceeding whorls; mericarps slightly bulliform, c. 1 mm diam.; bracts present at all cyme-nodes and often developed on ultimate peduncles (arid South Australia) .....	<b>11. <i>G. bulliformis</i></b>
<b>13:</b>	Corolla $>$ 1 mm diam. or if not then not with the above combination of characters .....	<b>14</b>

14	Fruit with scattered pustules or stubby antrorsely curved hairs or spinules to c. 0.1 mm long .....	15
14:	Ovaries glabrous and without pustules (but surface may be uniformly papillose or bulliform) or with hairs not as above .....	17
15	Ultimate peduncles inserted on average markedly proximally, often basally; mericarps < 1.1 mm long, with surface, excluding hairs, more or less smooth; indumentum rather sparse, of fine scabrosities or hairs to 0.2 mm long .....	<b>6. G. leiocarpum</b>
15:	Ultimate peduncles inserted on average in distal half; mericarps > 1.1 mm long, with surface uneven; stems and leaves variably densely indumented, with long hairs or robust retrorse scabrosities .....	16
16	Ultimate peduncles < 0.5 mm long; stem-angles c. equal to faces; ovaries and fruit pustular (Cave Creek area in far south-eastern New South Wales) .....	<b>8. G. roddii</b>
16:	Ultimate peduncles > 0.5 mm long; stem-angles much narrower than faces; ovaries and fruit pustular, tubercular or with tubercle-based hairs .....	<b>10. G. leptogonium</b>
17	Primary inflorescences terminating after 1–4(–6) nodes, with terminal cymes much exceeding whorl .....	18
17:	Primary inflorescences extending beyond 6 nodes and/or the terminal cymes not or hardly exceeding whorl .....	20
18	Leaves narrowing fairly abruptly into petiole-like portion; stipules remaining more than 2/3 of leaf length in inflorescences; ovaries and developing fruit often obovate in face view, often drying light to mid green .....	<b>7a. G. ciliare</b> subsp. <b>terminale</b>
18:	Leaves narrowing gradually into petiole-like portion; stipules reducing to ≤ 1/2 of leaf length (sometimes absent) in inflorescences; ovaries and developing fruit not obovate in face view, mostly drying olive-brown, brown or reddish-brown .....	19
19	Ovary and developing fruit smooth, generally broader than long; mericarps 1–1.1 mm long, with dissepiment scar 0.2–0.4 mm long (Victoria and New South Wales) .....	<b>13. G. polyanthum</b>
19:	Ovary and developing fruit minutely papillose, generally longer than broad; mericarps 1.2–1.7 mm long, with dissepiment scar 0.7–1 mm long (South Australia) .....	<b>15a. G. migrans</b> subsp. <b>migrans</b>
20	Ovaries and fruit hairy .....	21
20:	Ovaries and fruit glabrous .....	22
21	Fruit with hairs tubercle-based (Queensland) .....	<b>9. G. terrae-reginae</b>
21:	Fruit with hairs not tubercle-based (Victoria and South Australia) .....	<b>18. G. curvihirtum</b>
22	Corolla 0.8–1 mm diam.; ultimate peduncles all < 1 mm long (annuals of drier inland regions) .....	<b>19. G. microlobum</b>
22:	Corolla 1.2–4 mm diam., or if ever c. 1 mm diam. then at least some ultimate peduncles > 1 mm long .....	23
23	Ultimate peduncles on average inserted strongly proximally (often inserted at base in 2-flowered cymes) .....	24
23:	Ultimate peduncles on average inserted c. midway or in distal half (or cyme too congested to determine this) .....	25
24	Mericarps c. 1.2 mm long, rugose; leaves with l:w ratio commonly < 2 (New Zealand) .....	<b>G. propinquum</b> (see 6.)
24:	Mericarps 0.8–1.1 mm long, more or less smooth; leaves with l:w ratio commonly > 2.5 .....	<b>6. G. leiocarpum</b>
25	Leaves cuneate to broad-cuneate, narrowing fairly abruptly into petiole-like region; ovaries commonly obovate in face view, mostly drying light to mid green .....	<b>7b. G. ciliare</b> subsp. <b>ciliare</b>
25:	Leaves narrow-cuneate or attenuate, narrowing gradually into petiole-like region, sometimes leaves hardly narrowing; ovary not obovate in face view, drying olive-brown, brown or reddish-brown .....	26
26	Ovaries/developing fruit glistening and minutely papillose; most cymes in an inflorescence 1- or 2-flowered and not exceeding whorls (limestone areas of South Australia and coastal Victoria) .....	<b>16. G. compactum</b>
26:	Ovaries/developing fruit not both glistening and papillose, or if ever so then cymes mostly more than 2-flowered and/or exceeding whorls.....	27
27	Corolla-lobes 0.8–1.8 mm long, clearly longer than ovary (before post-fertilisation enlargement of ovary) .....	28
27:	Corolla-lobes 0.5–0.8 mm long, not or hardly longer than ovary .....	29

Key continues over the page

Key to native species of *Galium* ... continued

- 28** Dissepiment scar of mericarps 0.7–1 mm long; ovary generally slightly longer than broad, minutely papillose; apiculum of corolla-lobes 0.1–0.3 mm long; cyme-bracts generally equal to or shorter than the peduncle it subtends (South Australia only) ..... **15a. *G. migrans* subsp. *migrans***
- 28:** Dissepiment scar of mericarps 0.3–0.5 mm long; ovary slightly broader than long, papillose or not; apiculum of corolla-lobes to 0.1 mm long; cyme-bracts generally much longer than the peduncle it subtends (widespread) ..... **17a. *G. gaudichaudii* subsp. *gaudichaudii***
- 29** Stem-angles moderately broadened; leaves slightly fleshy, lower surface with an extensive glandular cell patch and with hairs on midrib; cymes with flowers generally closely bunched ..... **17b. *G. gaudichaudii* subsp. *parviflorum***
- 29:** Stem-angles slender to slightly broadened; leaves thin, lower surface with a small glandular cell patch and with midrib glabrous; at least lower cymes with flowers somewhat separated ..... **12b. *G. binifolium* subsp. *conforme***

or of pustules. Hairs and pustules appear to be always located on the crests of these rugae.

Hairs on ovaries and fruit are important taxonomically. Hair length and the degree and nature of curving or hooking are the two most important aspects.

**1. *Galium liratum*** N.A.Wakef., *Victorian Naturalist* 72: 70 (1955)

**Type:** VICTORIA. Turnback Road, above Little River, near Snowy River, 20 January 1953, N.A.Wakefield 4800; holo: MEL; iso: K, NSW.

**Herbs**, generally sparsely indumented, with very coarse hairs to c. 0.3 mm long, sometimes pigmented brown; rootstock or rhizomes not seen. **Stems** to c. 1.5 mm diam., with angles slender, with hairs spreading to retrorse; whorls 4-partite, rarely 5- or 6-partite at a few nodes, with stipules c. 2/3–4/5 of leaf length below inflorescences reducing upwards to be < 2/3 of leaf length and sometimes absent. **Leaves** narrow-spathulate, 6–25 mm long, 2–8 mm wide, with l:w ratio mostly 1.5–4, with petiole-like portion 1–4 mm long, often drying rather dark; margin mostly flat or narrowly recurved; apex acute, without a terminal hair; adaxial surface with midrib usually distinct; abaxial surface with midrib distinct throughout length, lacking glandular cells. **Inflorescences** extended; cymes 1–4-flowered, often 2-flowered, all not exceeding whorls or lowermost cymes sometimes exceeding whorls when mature; primary peduncle to 15 mm long, but most often < 2 mm long, glabrous; bracts longer than the peduncle they subtend; ultimate peduncles generally inserted proximally, 0.3–2 mm long. **Flowers:** corolla 1.5–2 mm diam., with lobes 0.7–0.9 mm long, not apiculate, cream, glabrous; ovary circular, broad-elliptic or obovate in

face view, c. 0.5–0.8 mm long, glabrous. **Fruit:** fruit-set percentage high; developing fruit dull, bulliform to coarsely papillose; mericarps reniform, 1.3–1.8 mm long, c. 1 mm wide, dark-brown to blackish, longitudinally rugose; dissepiment scar c. 0.8 mm long.

**Flowers** spring–summer.

**Selected specimens:** NEW SOUTH WALES. Goulburn River Valley, 0.4 km S of Mt Kerrabee, M.D.Crisp 2271 & I.R.Telford, 28.x.1976 (CANB); Side of Jingera Rock, Egan Peaks Nature reserve, D.E.Albrecht 863, 21.ix.1984 (MEL); The Clyde, W.Bauerlen, 42, Sept. 1884 (MEL). VICTORIA. Catchment N of New Guinea Bend, Snowy River Gorge, 20.5 km NE of Buchan, D.Cameron 7768, 18.xii.1976 (AD, BRI, CANB, HO, MEL, NSW); Suggan Buggan, W.Hunter, Jan. 1940 (MEL); Thousand-pound Bend, Omeo Hwy in Tambo Valley, J.H.Willis, 10.xii.1974 (MEL); Mt Wheeler, A.C.Beauglehole 35167, 5.xii.1970 (MEL); Little River Gorge lookout, N.G.Walsh 5919, 1.xii.2003 (MEL); Bald Hill Creek, Mitchell River Gorge, 26.5 km NW of Bairnsdale, D.Cameron 7467, 4.xii.1976 (MEL); Track to summit of Mt Ellery, D.E.Albrecht 210 & B.J.Conn, 22.ii.1984 (CANB, MEL, NSW).

**Distribution and habitat:** Occurs in eastern New South Wales and far eastern Victoria (Fig. 9). Grows in forests.

**Notes:** *Galium liratum* is one of the most easily recognised native species. It has plump hairs that are sometimes pigmented brown, large spatulate leaves which lack glandular cells, mostly few-flowered short cymes, and large fruits that have a bulliform surface during development and become longitudinally rugose at maturity. Specimens generally dry rather dark. *Galium spathulatum* q.v. is closely related, as are two species from New Zealand, *G. trilobum* and an undescribed species (see below). *Galium liratum* is one of only two species in this study in which few 5- or 6-partite whorls have been detected, the other being *G. bulliformis*.

*Galium trilobum* Colenso has fruit of similar size to *G. liratum* but the surface is smooth or only minutely wrinkled at maturity. Its leaves are narrow-elliptic to oblanceolate or sometimes slightly narrow-spathulate unlike the markedly spathulate leaves of *G. liratum*, *G. spathulatum* and an unnamed New Zealand taxon. This last entity is similar to *G. liratum* in terms of its bulliform ovary/fruit surface and in the number of flowers per cyme but it has much longer primary peduncles. Specimens recorded of this entity are: Cape Palliser, Wellington (*D.Bowen* 14787, AD; dupl. in NZFRI Rotorua *n.v.*), Canterbury, (*Haast*, MEL), Cape Palliser lighthouse, Wairarapa, Wellington Land District (*P.J. de Lange* 1789 MEL, dupl in CHR *n.v.*), and Worryline Stream, Mount Cook, (*A.M.Buchanan s.n.* HO).

*Hybrids*: A specimen from Bega, New South Wales (*S.J.Forbes* 891 MEL) appears to be a hybrid: *G. liratum* × *G. binifolium* subsp. *binifolium*.

## 2. *Galium spathulatum* I.Thomps., *sp. nov.*

A *G. lirato* N.A.Wakef. *apicibus foliorum obtusioribus, cymis longioribus, floribus pluribus, ovario minute muriculato differt.*

**Type: QUEENSLAND.** West of Beta Creek, Eungella National Park, *A.R.Bean* 4488, 27 May 1992; holo: BRI.

*Herbs*, generally sparsely haired, with moderately coarse hairs to c. 0.5 mm long; rhizomes and rootstock not seen. *Stems* to c. 1 mm diam., with slender angles, with hairs retrorse; whorls 4-partite, with stipules slightly shorter than or similar to leaves throughout. *Leaves* spathulate, 6–25 mm long, 3–10 mm wide, with l:w ratio mostly 1.5–3, with petiole-like portion mostly 3–6 mm long; margin flat or narrowly recurved; apex rounded but also with a minute apiculation, without a terminal hair; adaxial surface with midrib variably distinct; abaxial surface with midrib distinct throughout length, lacking glandular cells. *Inflorescences* extended; cymes mostly 4–10-flowered, occasionally fewer, usually equal to or exceeding whorls when mature; primary peduncle 5–35 mm long, glabrous or hairy; secondary peduncles inserted strongly distally; bracts longer than the peduncle they subtend; ultimate peduncles inserted variably, 0.5–3 mm long, glabrous. *Flowers*: corolla 1.5–2 mm diam., with lobes c. 1 mm long, not apiculate, cream or white (uncertain), glabrous; ovary c. circular in face view, c. 0.2 mm long, glabrous. *Fruit*:

fruit-set percentage low, with unfertilised ovaries enlarging to c. 0.7 mm long; developing fruit dull, acutely and coarsely papillose; mericarps reniform, 1.5–1.8 mm long, c. 1 mm wide, dark-brown to blackish, longitudinally rugose; dissepiment scar c. 0.8 mm long. (Fig. 2d-i)

*Flowers* autumn.

**Selected specimens: QUEENSLAND.** Swampy Ridge, west of Eungella National Park, *A.R.Bean* 4461, 24.v.1992 (BRI); Mt Aberdeen National Park, W of Bowen, *P.I.Forster* 9969, *M.C.Tucker & G.Kenning*, 29.v.1992 (BRI).

**Distribution and habitat:** Occurs in north-eastern Queensland near Bowen (Fig. 9). Grows on rainforest margins at altitudes between 900 and 1100 m.

**Notes:** Similar to *G. liratum* in having spathulate leaves that lack glandular cells. All collections of this species were made within a few days of each other and further collections are desirable to better characterise it. Only one of the three collections has flowering material and information from this is limited. It is unclear whether the corolla is bright white as in species of *Asperula* or more a dull cream as in *G. liratum*. The cyme architecture is unusual in consisting of a long primary peduncle with the remainder rather complexly branched with short peduncles, reminiscent of the branching pattern in *Asperula* sect. *Dioicae*. The scaly appearance of the mericarps is also distinctive for Australian *Galium*.

**Etymology:** The epithet refers to the shape of the leaves (from L: *spathulatus*, spatula-shaped).

## 3. *Galium australe* DC., *Prodr.* 4: 608 (1830)

**Type: VICTORIA.** Western Port, Bass Strait, *A.Lesson*, 1829; holo: *G. n.v.*, *fide* D.J.McGillivray, *Telopea* 2: 360 (1983).

*G. squalidum* Hook.f, in W.J.Hooker, *London J. Bot.* 6: 462 bis (1847); *G. australe* var. *piloso-hispidum* Benth., *Fl. Austral.* 3: 447 (1867). Type: New Norfolk, *R.C.Gunn* 1129, 6 Nov. 1840; lecto: K, *fide* D.J.McGillivray *loc. cit.*, image seen MEL; iso: HO, NSW. Remaining syntypes: Glen Leith, *R.C.Gunn s.n.*, 14 Sept. 1840; syn: K; Lawrenny, *R.C.Gunn* 1009, Oct. 1840; syn: K.

*Herbs*, sparsely to somewhat densely indumented, with slender to somewhat coarse hairs to c. 0.5 mm long or scabrosities; rhizomes not seen. *Stems* to c. 1 mm diam., with angles slender to somewhat



broadened, with hairs and scabrosities spreading to retrorse; whorls 4-partite, with stipules mostly 2/3 or more of leaf length below inflorescences, decreasing upwards to be finally < 1/2 of leaf length or occasionally not developed. *Leaves* oblong-elliptic, elliptic, narrow-elliptic or narrow-ovate, 2–12 mm long, 1.5–5 mm wide, with l:w ratio mostly 2–6, with petiole-like portion 0.5–1.5 mm long; margin usually recurved or revolute, sometimes strongly so; apex acute, sometimes with a terminal hair; adaxial surface with midrib variably distinct; abaxial surface with midrib only conspicuous proximally, distal glandular cell patch small to moderate, proximal glandular cells variably present, sometimes conspicuous. *Inflorescences* mostly extended, rarely soon terminating; cymes 2–10-flowered, often 3-flowered, commonly exceeding whorls when mature; primary peduncle to 20 mm long, often hairy; intermediate and ultimate peduncles 0.5–5 mm long, with insertion position variable, glabrous or hairy; bracts c. equal to or more often shorter than peduncle, developed at most nodes. *Flowers*: corolla 1.5–3 mm diam., with lobes 0.7–1.3 mm long, not apiculate, cream or greenish-cream, occasionally tinged purplish-red abaxially, glabrous; ovary circular to slightly oblate in face view, c. 0.5 mm long, covered with antrorse-appressed, but later spreading, robust hairs 0.3–0.5 mm long, hooked, sometimes pigmented orangish to brown throughout or distally. *Fruit*: fruit-set percentage generally high; developing fruit dull, more or less smooth between hairs; mature peduncles stout, straight, mericarps reniform, 1.0–1.3 mm long, c. 0.8 mm wide, dark brown, reticulately rugose; hairs weakly tubercle-based; dissepiment scar c. 0.5 mm long.

*Flowers* spring–summer.

**Selected specimens:** **SOUTH AUSTRALIA.** Near Pink Bay, Kangaroo Island, *coll. unknown*, ?1847 (MEL); Limestone cliffs near Dry Creek, Glenelg river, *R.J.Bates* 41837, 3.i.1996 (AD); Honans Scrub, *R.J.Bates* 26322, 23.xi.1991 (AD). **NEW SOUTH WALES.** Nowra-Yalwal Rd, c. 11 km W of Nowra, *D.F.Blaxell* 1350, 21.iv.1974 (NSW); Mt Dromedary, *E.Reader*, Nov. 1894 (MEL); W side, Lake Windemere, ANBG annexe, *G.Singh & E.A.Geissler*, 24.iii.1981 (CANB). **VICTORIA.** Point Addis Coastal Reserve, c. 6 km ENE of Anglesea PO, *A.C.Beauglehole* 63495, 19.i.1979 (MEL, NSW); Queenscliff, *A.J.Tadgell*, Oct. 1904 (MEL); Sorrento Ocean Beach, *I.R.Thompson* 1038, 2.i.2008 (MEL); Shallow Inlet, NW of Wilsons Promontory, *P.C.Heyligers* 93023, 16.xi.1993 (CANB, MEL); Wilsons Promontory, *E.Chesterfield* 2134, 11.i.1989 (MEL);

Wingan Inlet, *J.H.Willis & N.A.Wakefield*, 30.xii.1951 (MEL); Dunes, Betka River, *N.A.Wakefield* 4802, 31.xii.1952 (MEL). **TASMANIA.** Mt Killiekrankie, Flinders Island, *S.Harris* 236, Sept. 1980 (HO); South Patriarch Trig, Flinders Island, c. 20 km NE of Whitemark, *I.Crawford* 1111, 8.xii.1988 (BRI, HO, MEL); Hogans Island, Furneaux group, *J.S.Whinray* 9317, s.d. (AD, CANB, HO, MEL, NSW); Low Head, *W.M.Curtis*, 7.xii.1955 (HO); Deal Island, Kent Group, *J.S.Whinray* 276, 29.xii.1968 (HO); Croppies Point, *A.M.Buchanan* 1649, 22.xi.1983 (HO); Swansea, *A.Simson* 2166, Oct. 1881 (HO); Ouse River near Remarkable Rock, c. 8 km NE of Lake Echo, *A.M.Gray* 521, 14.xii.1980 (HO); Wilson Bight, *A.M.Buchanan* 9472, 14.i.1987 (HO); Fluted Cape, South Bruny Island, *A.M.Buchanan* 8370 (HO); near Derwent River, *R.Brown*, 1804 (CANB).

**Distribution and habitat:** Occurs in southern New South Wales, southern Victoria, far south-eastern South Australia, and Tasmania (Fig. 9). Grows mostly on or near coasts, often in sandy soils, in shrubland and forest.

**Notes:** *Galium australe*, like *G. albescens* and *G. densum*, has hooked spreading hairs on ovary and fruit; they are shorter in *G. australe*. Also, compared to *G. densum*, *G. australe* has a less marked size difference between leaves and stipules, often firmer leaves with evenly revolute margins, extended inflorescences, and cymes with shorter and always straight peduncles. *Galium australe* has smaller flowers and fruit than *G. albescens* and the stem and leaf indumentum is not as dense and hairs not as long. Uncommonly for Australian *Galium*, in more complex cymes a third peduncle sometimes arises from the primary peduncle. This pattern is more typical of species in *Asperula* sect. *Dioicae*.

Specimens from Deal Island in Bass Strait, Tasmania (*J.S.Whinray* 276 HO and *D.A.Reynolds* 97 HO) are atypical in having inflorescences terminating after only 2 or 3 nodes.

**Hybrids:** The following collections appear to be hybrids: **1.** Clyde River, south-eastern Tasmania (*P.Collier* 1649 HO): *G. australe* × *G. densum*. **2.** Hogans Island, Bass Strait (*N.P.Brothers* 191 & 251 HO) and St Margaret Island, Victoria (*A.C.Beauglehole* 62333 MEL): *G. australe* × *G. gaudichaudii*. **3.** Lower Glenelg River, far south-western Victoria and far south-eastern South Australia (e.g. *R.J.Bates* 41316 AD): *G. australe* × *G. compactum*.

**4. *Galium albescens*** Hook.f., in W.J.Hooker, *London J. Bot.* 6: 462 bis (1847).

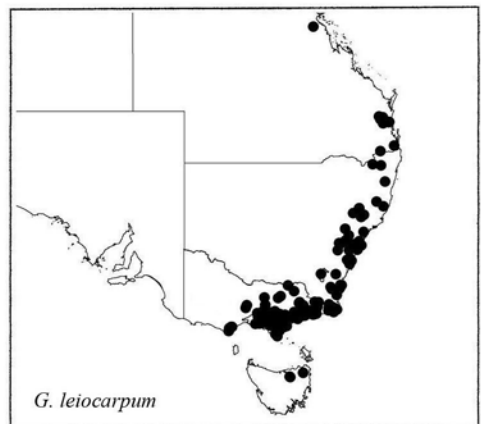
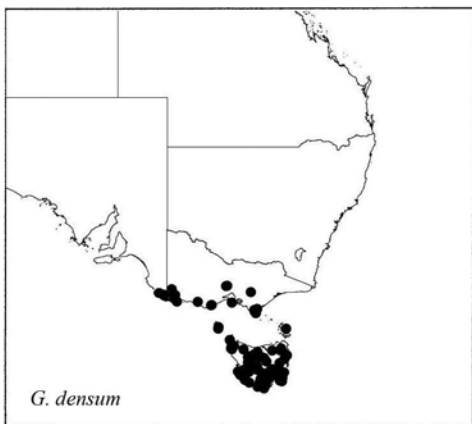
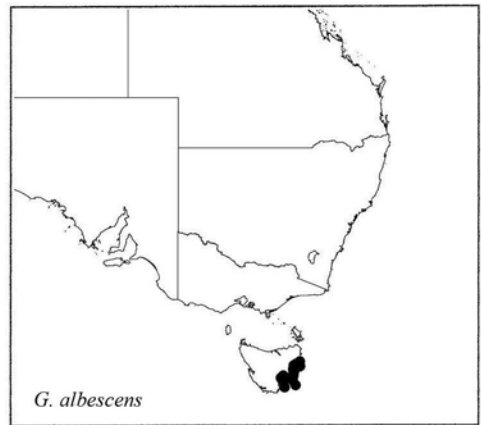
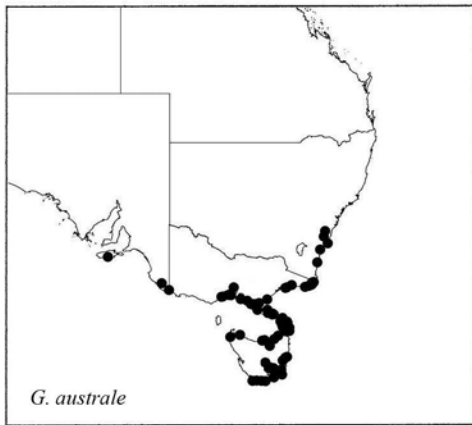
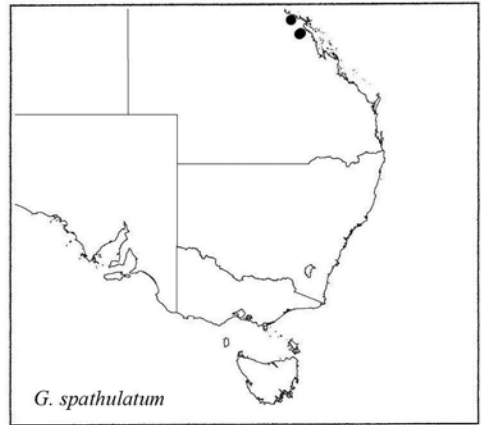
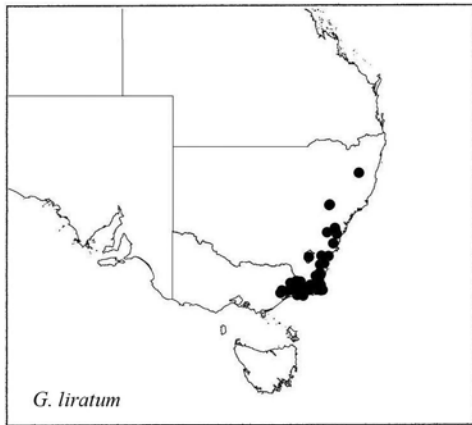

**Figure 9.** Distributions of *Galium liratum*, *G. spathulatum*, *G. australe*, *G. albescens*, *G. densum*, *G. leiocarpum*.

**Type: TASMANIA.** Mt Wellington, *R.C.Gunn s.n.*, May 1839; holotype: K, image MEL; isotype: NSW.

*Herbs*, densely indumented with slender hairs to 1.0 mm long, mostly > 0.5 mm long; rhizomes not seen. *Stems* to c. 1 mm diam., with angles moderately broad, sometimes as wide as the faces, with hairs spreading; whorls 4-partite, with stipules similar to leaf length below inflorescences, decreasing upwards to be finally c. 2/3 of leaf length. *Leaves* narrow-elliptic to ovate, 3–12 mm long, 1.5–5 mm wide, with l:w ratio mostly 1.5–4, with petiole-like portion 0.5–2 mm long; margin recurved to revolute; apex acute to acuminate, with a terminal hair commonly present; adaxial surface with midrib indistinct; abaxial surface with midrib distinct for much of length, distal glandular cell patch small, proximal glandular cells generally not evident. *Inflorescences* soon terminating; cymes 1–8-flowered, with all peduncles hairy, usually much exceeding whorls when mature; primary peduncle to 15 mm long; intermediate and ultimate peduncles 1–10 mm long, inserted distally and mostly strongly so; bracts shorter or longer than the peduncle they subtend, developed at all nodes. *Flowers*: corolla 4–6.5 mm diam., with lobes 1.8–3.0 mm long, usually short-apiculate, cream, hairy abaxially; ovary slightly oblate in face view, 0.8–1.0 mm long, covered with antrorse-appressed, but later spreading, robust hairs 0.7–1.0 mm long, hooked, sometimes pigmented orange or brown. *Fruit*: fruit-set percentage generally high; developing fruit dull, with epidermal pattern unclear due to hair density; mature peduncles stout, often moderately curved near apex, sometimes overall downcurved; mericarps ellipsoid, 1.6–2.4 mm long, c. 1.2 mm wide, reticulately rugose, dark brown; hairs tuberculate at base, sometimes prominently so; dissepiment scar 0.6–0.8 mm long.

*Flowers* spring–summer.

**Selected specimens: TASMANIA.** Prosser River, *W.M.Curtis*, Nov. 1971 (HO); NW slope of Devils Backbone, *A.M.Buchanan* 3879, 3.xi.1984 (HO); Hardings Falls, *P.Collier* 1915, 22.xi.1986 (HO); Cygnet River, *P.Collier* 1946, 23.xi.1986 (HO); E ridge of Mt Peter, *A.M.Buchanan* 7616, 29.xii.1985 (HO); Lost Falls, 5 km SE of Lake Leake, *A.Moscal* 22065, 9.xii.1991 (HO); Mt Dromedary, *L.Rodway*, s.d. (MEL); Dunolly, *J.Buften*, 1893 (MEL).

**Distribution and habitat:** Occurs in south-eastern Tasmania (Fig. 9). Grows in forest, often on rocky slopes.

**Notes:** This species is one of a group of three species (see *G. australe* above) with similar hooked spreading

hairs. *Galium albescens* is readily distinguished from the other two species by its much larger corolla with hairy petals, and larger fruit, and usually also by its dense indumentum of long and very fine hairs.

**5. *Galium densum* Hook.f.**, in W.J.Hooker, *London J. Bot.* 6: 461 bis (1847).

**Type: TASMANIA.** Side of Western Mountains, *R.C.Gunn* 549, 16 January 1845; lectotype: K, *vide* D.J.McGillivray, *Telopea* 2: 360 (1983); isolectotype: HO, NSW n.v. Remaining syntypes: Tasmania: Hampshire Hills, *R.C.Gunn* 549 (not same collection as lectotype), 1837; syn: K; Tasmania: on road to Macquarie Harbour from Lake St Clair, *R.C.Gunn* 549, 10 February 1845; syn: K.

*G. australe* var. *laeve* F.Muell. ex Hook.f., *Fl. Tasmaniae* 1: 171 (1856), *nom. nud.*

*Herbs*, mostly sparsely indumented with short hairs or scabrosities, less often with long fine spreading hairs; probably weakly rhizomatous. *Stems* to c. 0.8 mm diam., with angles slender to mildly broadened; whorls 4-partite, with stipules c. 1/2–3/4 of leaf length below inflorescences decreasing upwards to be finally < 1/2 of leaf length or not developed. *Leaves* narrow-elliptic or spatulate, 6–20 mm long, 2–5 mm wide, with l:w ratio mostly 2–6, with petiole-like portion 1–4 mm long; margin flat or narrowly recurved; apex acute or acuminate, without a terminal hair; adaxial surface with midrib generally distinct for most of length; abaxial surface with midrib distinct for most of length, distal glandular cell patch small, proximal cells not evident. *Inflorescences* a single terminal cyme or usually terminating within 3 nodes; cymes 2–8-flowered, exceeding whorls when mature; primary peduncle 10–20 mm long, glabrous or hairy; intermediate and ultimate peduncles 3–25 mm long, inserted distally; bracts generally shorter than the peduncle they subtend, developed at all or most nodes. *Flowers*: corolla 2.0–3.8 mm diam., with lobes 0.8–1.5 mm long, short-apiculate, greenish-cream, sometimes tinged pinkish or purple-red abaxially, glabrous; ovary c. circular in face view, 0.6–0.8 mm long, covered with antrorse-appressed, but later spreading, robust hairs 0.5–1.0 mm long, hooked, often pigmented yellow, brown or blackish. *Fruit*: fruit-set percentage generally high; developing fruit dull, smooth or areolate; mature peduncles stout, curved to gently hooked close to

summit, with curve developing soon after corolla-fall; mericarps reniform, 1.0–1.4 mm long, 0.8–1 mm wide, blackish-brown, reticulately rugose; hairs tubercle-based; dissepiment scar 0.5–0.7 mm long. (Fig. 4f)

Flowers summer.

**Selected specimens:** **SOUTH AUSTRALIA.** Caroline Forest, *R.J.Bates* 35786, 7.i.1994 (AD); by the boardwalk, Germein Reserve, Port McDonnell, *R.J.Bates* 55577, 3.i.2000 (AD). **VICTORIA.** Glenelg River near Georges Rest, Lower Glenelg National Park, *D.E.Albrecht* 4725, 15.ii.1991 (MEL); Barramunga Creek Education Area, c. 25 km SSE of Colac PO, *A.C.Beaglehole* 63726, 23.i.1979 (MEL, NSW); Clyde Track c. 200 m N of intersection with Francis Rd, c. 2.5 km direct NNW of Mt Macedon township, *I.R.Thompson* 1047, 7.i.2008 (AD, CANB, MEL); Tooronga Rd at crossing of Tooronga River, Noojee, *N.G.Walsh* 172, 22.x.1978 (MEL); Darby River, Wilsons Promontory, *F.Mueller*, 25.v.1853 (MEL). **TASMANIA.** Above Lake Rodway, Cradle Mountain, *A.M.Buchanan* 878, 30.i.1982 (HO); 0.4 km E of Franklin River on Lyell Highway, 4 km WSW of Mt Arrowsmith, *J.R.Busby* 44, 4.iv.1978 (HO); Russell Falls, Mt Field National Park, *W.M.Curtis*, 18.i.1959 (HO); Grass Tree Hill, near Hobart, *W.M.Curtis*, 29.xi.1951 (HO); Nye Bay, *A.M.Buchanan* 7705, 8.i.1986 (HO); The Clump, west coast, *A.Moscal* 4694, 9.xii.1983 (HO); Fraser River, King Island, *E.A.Griffin* 54, 7.i.1973 (HO); Mount Koonya, *A.Moscal* 5228, 1.i.1984 (HO, MEL); coast between Welcome Inlet and Swan Bat, *A.M.Buchanan* 9091, 28.xii.1986 (HO); Kermadie Divide, *A.Moscal* 10865, 11.v.1993 (CANB, HO, MEL).

**Distribution and habitat:** Occurs in far south-eastern South Australia as far west as Cape Banks, in southern Victoria and in Tasmania (Fig. 9). An old record (MEL 2267275) is labelled as coming from NSW but must be treated as uncertain. Grows mostly in open forest and rainforest, often amongst mosses, less often found in more exposed rocky sites or in swamps.

**Notes:** *Galium densum* is a generally lax plant mostly of moist shady forests, characterised by relatively short stipules, very lax terminal or subterminal cymes, and distally hooked peduncles. Peduncles are sometimes also curved at the insertion point of a more distal peduncle. Stems of *G. densum* are usually glabrous or with small retrorse scabrosities, but can develop long spreading hairs like those of *G. albescens*, possibly in response to exposure. Also like *G. albescens* bracts subtend all or nearly all peduncles and occasionally a bract forms on an ultimate peduncle where there is no apparent node. Leaves are similar in size to those of *G. australe* but are often thinner and the abaxial surface generally only has

glandular cells in a small subapical patch. Its distribution can overlap that of both *G. albescens* and *G. australe*.

**Hybrids:** The following collections appear to be hybrids: **1.** Dover Island, Bass Strait (*S.Murray-Smith* MEL): *G. densum* × *G. binifolium*. **2.** Mt Wellington (*M.Wapstra* 13 Jan. 2007 HO, MEL); Grass Tree Hill (*W.M.Curtis* Nov. 1951 HO); Ouse River (*A.M.Gray* 521 HO), all in Tasmania: *G. densum* × *G. gaudichaudii* subsp. *parviflorum*.

## 6. *Galium leiocarpum* I.Thomps., sp. nov.

A *G. propinquo* *A.Cunn. ovariis et fructibus minoribus piliferis minus carnosis differt.*

**Type:** **VICTORIA.** Mullungdung Flora and Fauna Reserve, *A.C.Beaglehole* 75789 & *O. & B.Thompson*, 8 December 1983; holotype: MEL; isotype: NSW.

*G. propinquum sensu auctt. australiensis* post-1983.

**Herbs,** sparsely indumented with hairs to 0.3 mm long or retrorse scabrosities; often extensively rhizomatous. **Stems** to c. 0.5 mm diam., with angles slender; whorls 4-partite, with stipules similar in length to leaves throughout or decreasing upwards to be finally 3/5–4/5 of leaf length. **Leaves** elliptic, narrow-obovate to oblanceolate, or weakly spatulate, 2–15 mm long, 1–5 mm wide, with l:w ratio mostly 2.5–4, with petiole-like portion 0.5–1.5 mm long, generally drying green; margin flat or narrowly recurved; apex acute or slightly acuminate, without a terminal hair; adaxial surface with midrib usually distinct; abaxial surface with midrib usually distinct, distal glandular cell patch small, proximal cells often evident. **Inflorescences** extended; cymes predominantly 1–3-flowered, less often a few 4–6-flowered, mostly not exceeding whorls when mature; primary peduncle 2–5 mm long, to 12 mm in complex lower cymes, glabrous; intermediate and ultimate peduncles inserted proximally and often at or near base, 2–7 mm long; bracts generally shorter than the peduncle they subtend, often not developed. **Flowers:** corolla 1–1.5 mm diam., with lobes 0.5–0.7 mm long, not apiculate, greenish or greenish-cream, glabrous; ovary c. circular in face view, 0.4–0.5 mm long, partly covered by antrorsely curved hairs 0.1–0.2 mm long with curled or weakly hooked tips, or rarely glabrous. **Fruit:** fruit-set percentage high; developing fruit dull or sublustrous, smooth; mericarps reniform, 0.8–1.1 mm

long, c. 0.6 mm wide, dark brown, not or hardly rugose; dissepiment scar c. 0.4 mm long. (Fig. 4i)

*Flowers* spring–summer.

**Selected specimens:** **QUEENSLAND.** Council Reserve, Kureelpa, c. 7 km WNW of Nambour, *P.R.Sharpe 4955 & A.Moran*, 5.vii.1990 (BRI, MEL); Stanton Road, Conondale Ranges, SW of Kenilworth, *A.R.Bean 18566*, 30.iii.2002 (BRI, MEL). **NEW SOUTH WALES.** Clouds Creek, 29 km NNW of Dorrigo, *D.Cameron 6499*, 29.viii.1976 (MEL); plateau on W side of the Upper Wadbilliga Gorge, c. 3.5 km S of Conways Gap, Wadbilliga National Park, *D.E.Albrecht 1686*, 27.iii.1985 (MEL, NSW). **VICTORIA.** Tyers Regional Park, *A.C.Beauglehole 72679*, 13.xii.1982 (MEL, NSW); 14.5 km ENE of Yarram, *A.C.Beauglehole 62500*, 13.xii.1978 (HO, MEL, NSW); Thompson State Forest, *A.C.Beauglehole 72545*, 9.xii.1982 (MEL, NSW); Martin Creek, 32 km NNE of Orbost, *D.Cameron 8218*, 28.ii.1977 (MEL); Maramingo creek, NED of Genoa, *N.A.Wakefield 4799*, 7.i.1953 (MEL); Wilsons Promontory National Park, *A.C.Beauglehole 75981*, 15.xii.1983 (MEL). **TASMANIA.** Launceston, *A.M.Olsen*, 28.xii.1937 (HO); Thomas Plain (Weldborough), *A.Simson 1445*, Apr. 1879 (HO).

**Distribution and habitat:** Occurs in south-eastern Queensland, eastern New South Wales, eastern and south-western Victoria, and northern Tasmania. A single specimen recorded from Dalrymple Heights in the South Kennedy district in Queensland (*M.S.Clemens* BRI) is markedly disjunct from the next most northern collection (Fig. 9). Grows in damp to wet forests.

**Notes:** *Galium leiocarpum* is a relatively common species growing in relatively shady and moist environments. The mericarps are small with a thin pericarp that dries more or less smooth, and they tend to remain attached to the peduncle for some time after separating from each other. Close examination of ovaries and developing fruits usually reveals distinctive short, antrorsely curved hairs scattered on the surface. Rarely, ovaries are glabrous, e.g. specimens from the Tamborine Mtns in Queensland, from Launceston, Tasmania, and from Barrington Tops in New South Wales.

After 1983 (McGillivray 1983) it was treated by Australian authors as a form of *G. propinquum* A.Cunn. which occurs in New Zealand and is now considered endemic to that country. The latter differs from *G. leiocarpum* in having a larger, slightly obovoid, glabrous ovary with a pericarp that is rugose on drying, longer peduncles, and leaves that are more spatulate and relatively broader and often with more prominent glandular cells. In *G. leiocarpum* 2-flowered cymes

typically are only 1/3–2/3 of the length of the leaves, whereas in *G. propinquum* they are often of similar length or exceed the leaves. *Galium ciliare* is perhaps more closely related to *G. propinquum* based on ovary and fruit morphology and leaf shape, but differs in having more erect aerial stems, leaves with a shorter petiole-like portion, and cymes that are more floriferous and with more distal insertion of peduncles. Forms of *G. leptogonium* from north-eastern New South Wales and south-eastern Queensland are also similar but have longer peduncles, less fleshy ovaries and fruit with pustules, stubby hairs or tubercle-based hairs, and leaves with gel patches restricted to the subapical region. *Galium propinquum* has been recorded once for Australia (Mount Lofty Ranges, *O.E.Menzel*, Nov. 1897 AD). If the locality is genuine, it is presumed to have been a transient introduction.

**Hybrids:** The following collections appear to be hybrids: **1.** Emu Vale, South-east Queensland (*A.R.Bean 1536* BRI, CANB): *G. leiocarpum* × *G. leptogonium*. **2.** Wilsons Promontory (*E.A.Chesterfield 2342* MEL); Buckland (*J.Strudwick 751* MEL); Gippsland Lakes (*A.C.Beauglehole 79064* MEL), all Victoria; all *G. leiocarpum* × *G. ciliare* subsp. *ciliare*.

**Etymology:** The epithet refers to the fruit surface which, apart from the hairs, is more or less smooth rather than rugose (From Gk: *leios*, smooth and *carpos*, fruit)

**7. *Galium ciliare*** Hook.f., in W.J.Hooker, *London J. Bot.* 6: 461 bis (1847)

**Type:** **TASMANIA.** Circular Head, *R.C.Gunn 237*, 15 November 1836; lecto: K (here selected as 4<sup>th</sup> and 5<sup>th</sup> pieces from left on part sheet K000349209).

**Herbs,** sparsely to moderately indumented with slender hairs to 0.8 mm long or occasionally with fine scabrosities; often extensively rhizomatous. **Stems** 0.4–0.8 mm diam., with angles slender or less often moderately broadened; whorls 4-partite, with stipules similar in length to leaves throughout. **Leaves** elliptic to subrotund, 2–10 mm long, 1.5–5 mm wide, with l:w ratio mostly 1.2–4, with petiole-like portion 0.3–1.5 mm long; margin recurved to revolute; apex obtuse to acute, without a terminal hair; adaxial surface with midrib usually distinct; abaxial surface with midrib distinct for much of length, distal glandular cell patch small, proximal cells often evident and conspicuous.

## Key to subspecies

- 1 Inflorescences mostly extending for more than 4 nodes; upper cymes not or hardly exceeding whorls and 2- or 3-flowered ..... **7a. subsp. *ciliare***
- 1: Inflorescences terminating after 1–4 nodes; all cymes exceeding whorls, mostly 4 or more-flowered ..... **7b. subsp. *terminale***

*Inflorescences* soon terminating or extended, occasionally with vegetative growing on from terminal cyme; cymes (2–)3–30-flowered, variably exceeding whorls when mature; primary peduncle 2–20 mm long, glabrous; intermediate and ultimate peduncles 0.6–10 mm long, inserted c. midway or more often moderately distally; bracts shorter or longer than the peduncle they subtend, variably present. *Flowers*: corolla 1.5–3 mm diam., with lobes 0.7–1.3 mm long, not apiculate, pale yellow or cream, glabrous; ovary broad-obovate or less often subcircular in face view, c. 0.5–0.8 mm long, glabrous. *Fruit*: fruit-set percentage commonly low; developing fruit often drying midgreen and with shoulders appearing gelatinous, dull, smooth; mericarps flattened ellipsoid to broad obovoid, 1.3–1.5 mm long, c. 0.8 mm wide, honey-brown, reticulately rugose; dissepiment scar c. 0.6 mm long. (Fig. 4g-ii)

**Notes:** The ovaries of this species are distinctive in that they are usually obovate in face view, gelatinous on the shoulders, usually green after drying rather than brown, and often have a longitudinal line running down each carpel. To varying degrees these features are also seen in *G. roddii* and in New Zealand's *G. propinquum*, which suggests they may be related species. The corolla of *G. ciliare* is possibly yellower than other species as it has historically been suggested. However, field observations indicate that any colour difference between *G. ciliare* and other species is not sufficiently marked to be useful taxonomically. *Galium ciliare* appears to be an outbreeding species, and it is usual for a high percentage of flowers to be unfertilised. The ovaries of such flowers persist on plants for some time. No evidence of mericarps separating from each other has been seen in this species.

Joseph Hooker when describing this species did not cite any particular specimens, but indicated that the description was based on collections of Gunn's. Gunn collected forms both with extended inflorescences and forms with inflorescences soon terminating (treated

in this paper as *G. ciliare* subsp. *terminale* below). Although Hooker appears to have included both forms in his concept of *G. ciliare*, his original description is based more specifically on the form with extended inflorescences as he stated: "peduncles about as long as the leaves, mostly 3-flowered". For this reason, from Gunn's collections at Hooker's disposal, pieces 4 and 5 from the left on the third row from part sheet K000349209 are chosen as the lectotype of *Galium ciliare*. These were collected from Circular Head in far north-western Tasmania. Ehrendorfer and McGillivray were going to lectotypify the same entity and labelled the sheet accordingly; however, in McGillivray (1983) the author chose not to lectotypify.

**7a. *Galium ciliare* Hook.f. subsp. *ciliare***

*G. gaudichaudii* var. *glabrescens* Benth., *Fl. Austral.* 3: 446 (1867); *G. umbrosum* var. *gaudichaudi-glabrescens* Maiden & Betche, in J.H.Maiden & E.Betche, *Census New South Wales Pl.*: 188 (1916), *nom. illeg.* Type: NEW SOUTH WALES. Clarence River, *Beckler*, date unknown; holo: K; iso: MEL.

*Stems* 0.4–0.8 mm diam., with angles slender or moderately broadened. *Leaves* with l:w ratio mostly 1.2–3. *Inflorescences* extended, with upper cymes not or hardly exceeding whorls; cymes 2- or 3-flowered, or sometimes a few lower cymes 4–7-flowered; primary peduncle 2–15 mm long.

*Flowers* late spring–summer.

**Selected specimens:** SOUTH AUSTRALIA. Caroline & Myora State Forest, *R.J.Bates s.n.*, 7.i.1994 (AD). NEW SOUTH WALES. Dumaresq Dam, c. 10 km NW of Armidale, 150 m NW of boat ramp, *L.M.Copeland 3511*, 22.xii.2002 (BRI, CANB, MEL, NSW); alongside Sheba Dam, Hanging Rock, *J.R.Hosking 1998*, 4.ii.2001 (CANB, MEL, NSW); 5.6 km from Capertee, towards Glen Davis, *A.R.Bean 17208*, 27.xii.2000 (BRI); 500 m W of Blue Waterholes camping area, Kosciuszko National Park, *N.M.Taws 929*, 17.ii.1999 (CANB); Alpine Way just S of Youngal Saddle, Snowy Mountains, *T.B.Muir 3251*, 13.ii.1964 (MEL); Maragle

State Forest, *D.Binns* 5373, 6.ii.1996 (CANB). **VICTORIA.** Mt Cobberas, *J.H.Willis*, 22.ii.1974 (MEL); 7 km along Dawson track from intersection with Glenmore Rd, N of Buchan, *D.E.Albrecht* 330, 19.iii.1984 (MEL); Blue Shirt creek, Nunniong Region, *N.A.Wakefield* 4801, s.d. (MEL); Bat Ridges Faunal Reserve, 10 km W of Portland PO, *A.C.Beauglehole* 55357, 12.xii.1976 (MEL); Eastern Highlands, Top Flat, Wonnangatta Station, *E.A.Chesterfield* 3578, 7.i.1993 (MEL); Bentley Plains, c. 20 km W of Swifts Creek, *I.R.Thompson* 950, 13.xii.2006 (CANB, MEL).

**TASMANIA.** Circular Head, *R.C.Gunn* 237, 17.xi.1837 (HO).

**Distribution and habitat:** Occurs on the tablelands of northern, central and far southern New South Wales, in eastern Victoria, far western Victoria, far south-eastern South Australia, and northern Tasmania (no collections since 1837) (Fig. 10).

**Notes:** Plants from northern New South Wales are more commonly nearly glabrous and sometimes develop moderately broad stem-angles. In occasional specimens an inflorescence gives way to vegetative growth along an axis. This has not been noted for other species of *Galium*, except in the other subspecies of *G. ciliare*. However, in the latter case the growing-on is of a lateral branch from a terminal cyme as is commonly seen in *Asperula* sect. *Dioicae*.

**Hybrids:** The following collections appear to be hybrids: **1.** Plum Creek, East Gippsland (*D.E.Albrecht* 347 MEL) and Mt Clear (*A.C.Beauglehole* 41248 MEL), both in Victoria: both *G. ciliare* subsp. *ciliare* × *G. polyanthum*. **2.** Mount Buller, Victoria (*T.B.Muir* 2760 MEL): *G. ciliare* subsp. *ciliare* × *G. gaudichaudii*. **3.** Wilsons Promontory (*E.A.Chesterfield* 2342 MEL); Buckland (*J.Strudwick* 751 MEL); Gippsland Lakes, (*A.C.Beauglehole* 79064 MEL) all in Victoria: *G. ciliare* subsp. *ciliare* × *G. leiocarpum*.

### **7b. *Galium ciliare* subsp. *terminale* I.Thomps., subsp. nov.**

*A subspecies typica inflorescentiis brevioribus, cymis terminalibus elongatioribus floridis differt.*

**Type: VICTORIA.** Bushland Reserve, 28 km ESE of Colac PO, *A.C.Beauglehole* 63706, 22 January 1979; holo: MEL; iso: NSW *n.v.*

**Stems** 0.3–0.6 mm diam., with angles slender. **Leaves** with l:w ratio mostly 2–4. **Inflorescences** soon terminating, with terminal cymes generally exceeding the whorl; cymes 4–30-flowered; primary peduncle 3–20 mm long.

**Flowers** late spring–summer.

**Selected specimens: VICTORIA.** Charley Creek, Otways region, *G.E.Earl* 105, 19.i.1984 (MEL); Flora and Fauna Reserve, c. 30 km E of Warrnambool PO, *A.C.Beauglehole* 63834, 29.i.1979 (MEL); Ralph Illidge Sanctuary, Naringal E, c. 30 km E of Warrnambool on Cobden-Warrnambool Rd, *I.R.Thompson* 1027, 18.xii.2007 (CANB, HO, MEL); Bambra–Aireys Inlet Rd, c. 1 km W of Pinchgut Junction, c. 10 km ESE of Bambra, *I.R.Thompson* 1056, 8.ii.2008 (AD, BRI, CANB, HO, MEL, NSW). **TASMANIA.** Florentine River, *A.Moscal* 10156, 16.iii.1985 (HO); Big Den, Lake River, 35 km W of Campbelltown, *P.Collier* 5045, 9.xii.1990 (HO); Mersey River, *C.Stuart* 475, s.d. (MEL); Hampshire Hills, *Milligan*, s.d. (MEL); Mt Barrow, *H.M.R.Rupp*, Jan. 1922 (MEL); Tarraleah, *W.M.Curtis*, 7.ii.1945 (HO, MEL)

**Distribution and habitat:** Occurs in the Otway region of south-western Victoria and in Tasmania (Fig. 10).

**Notes:** Populations in the Otway region of Victoria tend to be laxer plants with more flowers per cyme, and with stem hairs tending to be more retrorse compared to the Tasmanian material.

**Etymology:** The subspecific epithet refers to the inflorescences (from L: *terminalis*, terminal).

### **8. *Galium roddii* Ehrend. & McGill., *Telopea* 2: 371 (1983)**

**Type: NEW SOUTH WALES.** C. 0.5 mile [0.8 km] below Blue Waterhole, Cave Creek, Cooleman Caves, east of Yarrangobilly, *A.N.Rodd* 87, 18 April 1965; holo: NSW; iso: E, K, US, WU [Isotypes not seen. Herbaria as indicated by McGillivray (1983)]

**Herbs**, sparsely to moderately indumented with slender hairs to 0.7 mm long; rhizomes not seen. **Stems** to c. 0.5 mm diam., with angles strongly broadened to be broader than or obliterating faces; whorls 4-partite, with stipules similar to leaf length below inflorescences, decreasing upwards to be finally 3/5–4/5 of leaf length. **Leaves** narrow-elliptic, 3–5 mm long, 0.8–1.2 mm wide, with l:w ratio mostly 2–5, with petiole-like portion obscure; margin flat, recurved or slightly revolute; apex acute or more often obtuse to rounded, sometimes with terminal hairs; adaxial surface with midrib indistinct; abaxial surface with midrib generally indistinct, distal glandular cell patch large, proximal cells variably evident. **Inflorescences** extended; cymes 1–10-flowered, mostly not exceeding whorls when mature; primary peduncle 0.5–1 mm long, or occasionally to 5 mm long, glabrous; intermediate peduncles inserted slightly proximally; bracts much longer than the peduncle

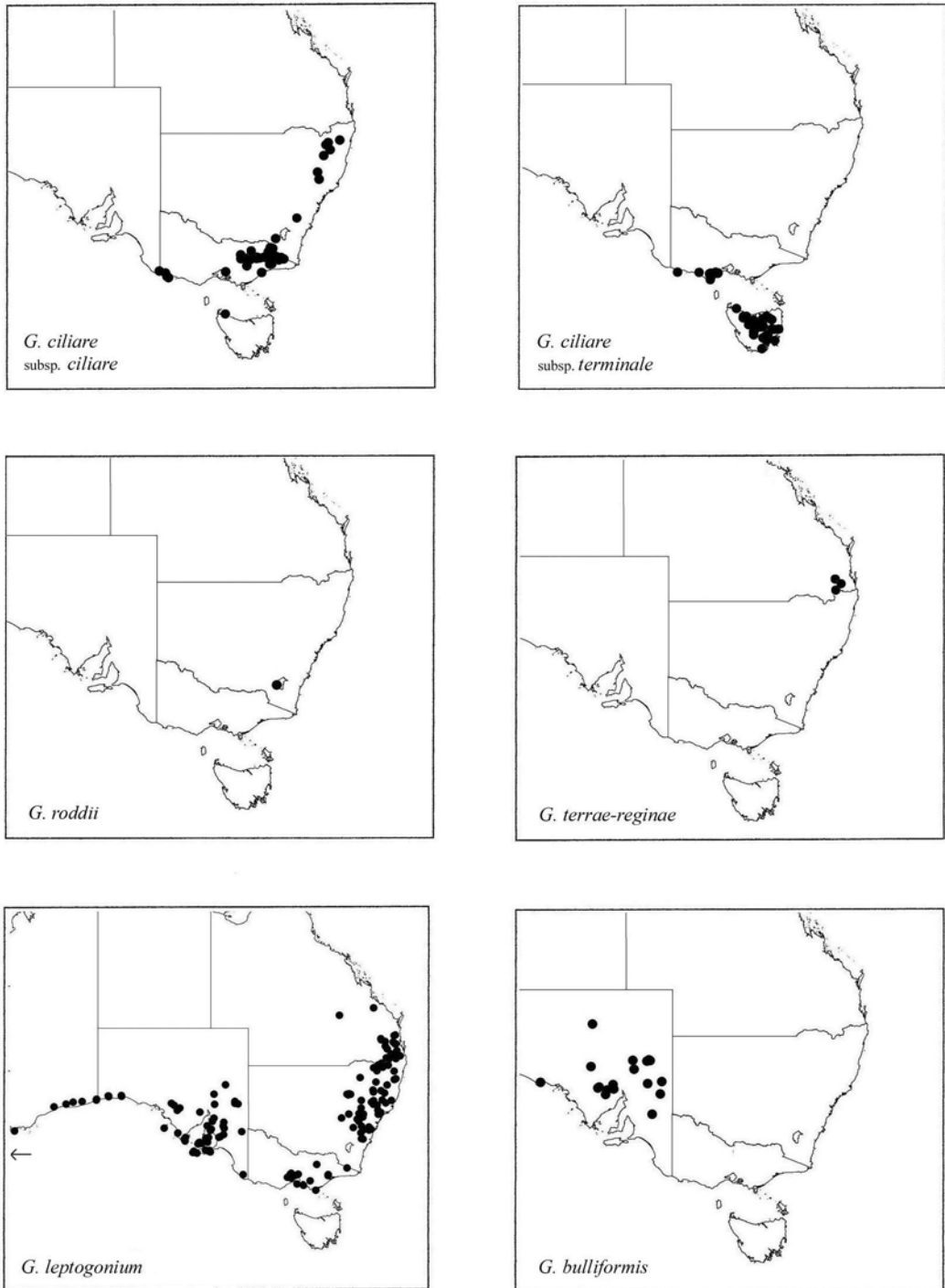

**Figure 10.** Distributions of *Galium ciliare* subsp. *ciliare*, *G. ciliare* subsp. *terminale*, *G. roddii*, *G. terrae-reginae*, *G. leptogonium* (a few locations further west are not shown), *G. bulliformis*.



they subtend; ultimate peduncles inserted proximally, 0.2–0.5 mm long. *Flowers*: corolla c. 1.8–2.5 mm diam., with lobes c. 0.7 mm long, sometimes short-apiculate, cream or greenish-cream, glabrous; ovary slightly broad-obovate in face view, c. 0.5 mm long, moderately covered in pustules, with pustules appearing disc-like when dried. *Fruit*: fruit-set percentage sometimes low; developing fruit with shoulders often appearing gelatinous, dull, smooth apart from pustules (non-fertilised ovaries with conspicuous pustules); mericarps reniform, 1.2–1.4 mm long, 0.8 mm wide, light to dark-brown, reticulately rugose; dissepiment scar c. 0.4 mm long. (Fig. 4g-iv)

*Flowers* summer.

**Selected specimens: NEW SOUTH WALES.** Cave Creek Gorge, 0.5 km E of Blue Waterholes, Cooleman Mountains, Kosciuszko National Park, *F.E.Davies 1581, H.Streimann & J.A.Curnow*, 20.ii.1991 (BRI, CANB, MEL, NSW, PERTH); Cave Creek, c. 3.5 km above junction with Goodradigbee River, *A.Rodd 476, 27.iii.1967* (CANB).

**Distribution and habitat:** Occurs in mountains of far south-eastern New South Wales (Fig. 10). Grows in limestone rock crevices at c. 1200 m a.s.l.

**Notes:** *Galium roddii* is superficially similar to forms of *G. gaudichaudii* in terms of its congested cymes and large amount of glandular cells in leaves. It is most obviously different in having prominent pustules on ovary and fruit and in having broader stem-angles. The pustules are more pronounced than those formed in *G. leptogonium*, the only other *Galium* in Australia with similar ornamentation. Ovary morphology resembles that of *G. ciliare* in being relatively broad and gelatinous distally and in developing into mericarps that appear a little fleshier than in other species. Stem internodes are typically short, and leaves are small, thickened, and with a more rounded apex than in other species. Listed as a ROTAP species with Risk Code 2RCi (Briggs and Leigh 1996).

### 9. *Galium terrae-reginae* Ehrend. & McGill., *Telopea* 2: 361 (1983)

**Type:** QUEENSLAND. One Tree Hill, Gowrie, *F.M.Bailey*, date unknown [late 19<sup>th</sup> century]; holotype: BRI.

*Herbs*, moderately to densely indumented with hairs 0.2–0.7 mm long; rhizomes not seen. *Stems* to c. 1 mm diam., with angles slender to mildly broadened; whorls 4-partite, with stipules similar in length to

leaves below inflorescences, decreasing upwards to be finally c. 2/3 of leaf length. *Leaves* elliptic ovate to broad-ovate or c. circular, 2–7 mm long, 1–3 mm wide, with l:w ratio 1–6, with petiole-like portion not or hardly developed, generally drying pale; margin mostly revolute; apex acute, often with a terminal hair; upper surface sometimes distorted on drying, with midrib variably distinct; abaxial surface with midrib distinct, distal glandular cell patch small, proximal cells not evident. *Inflorescences* extended; cymes 1–3-flowered, with lower cymes exceeding whorls when mature; primary peduncle to c. 15 mm long, hairy, ultimate and intermediate peduncles 0.5–3 mm long, inserted distally, usually hairy; bracts shorter or longer than the peduncle. *Flowers*: corolla 2–2.5 mm diam., with lobes 1–1.2 mm long, not apiculate, cream, often purple-red abaxially, glabrous; ovary c. circular in face view, 0.5–0.7 mm long, with slender curved or weakly hooked hairs arising from a robust tubercular base. *Fruit*: fruit-set percentage generally high; developing fruit dull, areolate; peduncles stout, usually gently curved especially in distal half; mericarps ellipsoid to sub-globose but flattened medially, c. 1.2 mm long, 0.8 mm wide, dark brown, tuberculate; dissepiment scar c. 0.5 mm long.

*Flowers* spring–autumn.

**Selected specimens: QUEENSLAND.** Prior's Station, *L.Leichhardt*, 1.xi.1843 (NSW); Warwick, *Beckler*, 1857 (MEL).

**Distribution and habitat:** Occurs in south-eastern Queensland (Fig. 10). Habitat preferences unknown.

**Notes:** *Galium terrae-reginae* is an enigmatic species due to the paucity of collections. There have been no records since the late 19<sup>th</sup> century. Its affinities are uncertain; it is perhaps closest to *G. leptogonium* with which it is sympatric. The hairs on the ovaries and fruit are distinctive. Species such as *G. australe* also have tubercle-based hairs but otherwise the hairs are dissimilar. Occasionally ovaries of *G. leptogonium* develop similar hairs to those in *G. terrae-reginae*. Listed as a ROTAP species with Risk Code 3K (Briggs and Leigh 1996).

### 10. *Galium leptogonium* I.Thomps., *sp. nov.*

A *G. migranti* Ehrend. & McGill. *angulis caulium gracilioribus, pilis caulium et foliorum longioribus, pedunculis insertis magis proximalibus, fructibus*

*ornatis*, corolla parviore differt; a *G. ciliari* Hook.f. non rhizomatosis, fructibus *ornatis* differt; a *G. leiocarpum* I.Thomps. pilis longioribus, pedunculis insertis magis distalibus differt.

**Type: VICTORIA.** Track to Anakie Gorge, c. 100 m from Stony Creek Picnic Ground, Brisbane Ranges National Park, I.R.Thompson 854, 11 November 2005; holo: MEL; iso: AD, BRI, CANB, HO, NSW.

*G. gaudichaudii* var. *muriculatum* Benth., *Fl. Austral.* 3: 446 (1867); *G. umbrosum* var. *muriculatum* (Benth.) Ewart & Rees, *Proc. Roy. Soc. Victoria* 26: 4 (1913); *G. umbrosum* var. *gaudichaudi-muriculatum* (Benth.) Maiden & Betche, in J.H.Maiden & E.Betche, *Census New South Wales Pl.*: 188 (1916), *nom. illeg.* Type: New South Wales: New England, C.Stuart; lecto: K, n.v., *fide* D.J.McGillivray, *Telopea* 2: 362 (1983); probable isolecto: MEL.

*G. erythrorrhizum* F.Muell. ex Miq., *Ned. Kruidk. Arch.* 4: 113 (1856), *nom. illeg. non Boiss.* & Reut. (1852), *p.p. excl. lectotype.* Type: South Australia, locality unknown, Behr; syn: U n.v.; isosyn: MEL.

*G. migrans sensu* D.J.McGillivray, *Telopea* 2(4): 362 (1983), *p.p. excl. lectotype*; E.M.Ross, *Fl. SE Queensland* 2: 333 (1986), *p.p.*; T.A.James & W.K.Allen, *Fl. New South Wales* 3: 486 (1992), *p.p.*; J.A.Jeanes, *Fl. Victoria* 4: 625 (1999), *p.p.*

*Herbs*, sparsely to densely indumented with long slender hairs to c. 1 mm long, sometimes with broad-based retrorse scabrosities, or more or less glabrous; rhizomes not seen. *Stems* to c. 1 mm diam., with angles slender; whorls 4-partite, with stipules similar in length to leaves below inflorescences, decreasing upwards to be finally c. 2/3 of leaf length. *Leaves* spatulate, elliptic, narrow-elliptic, or narrow-obovate to oblanceolate, 3–15 mm long, 1.5–6 mm wide, with l:w ratio 2–7, mostly 2.5–4, with petiole-like portion to 1.5 mm long, generally drying green; margin mostly flat to recurved; apex obtuse to acute or acuminate, often puckered on drying, sometimes with a terminal hair; adaxial surface with midrib mostly distinct; abaxial surface with midrib variably distinct, distal glandular cell patch moderate, proximal cells variably evident. *Inflorescences* extended; cymes (1–)2–6-flowered, occasionally to 10-flowered, mostly exceeding whorls when mature; primary peduncle 1–30 mm long, often hairy or scabridulous, ultimate and intermediate peduncles 0.5–10 mm long, inserted slightly to moderately distally, often glabrous; bracts variably present at nodes, shorter or

longer than the peduncle it subtends. *Flowers*: corolla 1.5–2.5 mm diam., with lobes 0.7–1.2 mm long, not apiculate, cream or greenish-cream, sometimes tinged purple-red abaxially, rarely hairy; ovary circular to slightly broad-obovate in face view, 0.5–0.7 mm long, with scattered pustules or antrorse spine-like or short conical hairs, uncommonly with fine hair extensions from a tubercular base, rarely smooth and hairless. *Fruit*: fruit-set percentage generally high; developing fruit dull or sublustrous, more or less smooth apart from ornamentation; mature peduncles slender (ultimate peduncles 0.1–0.2 mm diam.), straight, angled forwards; mericarps ellipsoid to sub-globose but flattened medially or reniform, often more tapered at proximal end, 1.0–1.2 mm long, 0.5–0.7 mm wide, dark reddish-brown, reticulately rugose; dissepiment scar 0.4–0.5 mm long. (Fig. 4g-iii)

*Flowers* spring–autumn.

**Selected specimens: WESTERN AUSTRALIA.** Madura, J.H.Willis, 17.x.1961 (MEL); Eucla, J.Oliver, 1881 (MEL); 3 km N of old Eucla, P.Wilson 1645, 14.ix.1960 (AD); 11.6 km S of Caiguna via Baxter's Memorial Track, M.J.Fitzgerald, 23.viii.1983 (PERTH); side of Pink Lake, Middle Island, Recherche Archipelago, A.S.Weston 9848, 10.xi.1974 (PERTH); 34 km E of Cocklebiddy, K.R.Newbey 11453, 11.xii.1986 (PERTH); 3 km E of Eucla, G.J.Keighery 1563 & J.J.Alford, 16.x.1987 (PERTH); Turners Spring, Cape Leeuwin, G.J.Keighery 12069, 28.xii.1990 (PERTH). **SOUTH AUSTRALIA. Pustular fruit form:** Gammon Ranges, R.J.Bates 34351, 29.ix.1993 (AD); around Marion Bay, Yorke Peninsula, R.J.Bates 38532, 21.ix.1994 (AD); Near Logan Creek, Northern Lofty region, R.J.Bates 41551, 10.xi.1995 (AD, MEL); Yorke Peninsula, Tepper 1133, s.d. (MEL); Property of Mr Brown just N of Maitland, D.E.Symon 2922, 14.viii.1964 (AD); W end of Yalata, c. 10 km W of Fowlers Bay, J.B.Cleland, 12.xi.1955 (AD). **Spinulose fruit form:** Hill on southern side of valley, Yandinga Gorge, Gawler Ranges, Eyre Peninsula, H.Eichler 20641, 13 Oct. 1969 (AD, CANB); Summit of Mt Greenly, D.E.Symon 11759, 1.x.1979 (AD); Sink hole, Koonalda, D.E.Symon 4524, 17.ii.1967 (AD); Cape Donington, c. 15 km SE of Port Lincoln, C.R.Alcock 760, 3.x.1965 (AD); Breakneck River, Kangaroo Island, R.J.Bates 30224, 21.xii.1992 (AD); 3.0 km W of Karatta, Kangaroo Island, P.Copley, C.Baxter & R.Furner NPK120374, 11.xi.1989 (AD); Coffin Bay National Park, S.Williams CBP233 & M.Savage, 17.ix.2000 (AD); Western Cove, Kangaroo Island, R.Tate, Dec. 1881 (MEL); 4 km N of the Koonalda homestead, Nullarbor Plain, J.C.Anway 346, 5.ix.1965 (MEL). **QUEENSLAND.** Dingo Flat, Bunya Mtns, R.Fairfax 111, 10.ii.1995 (BRI); State Forest 735, c. 30 km WSW of Rathdowney, D.Halford Q7014, 8.iv.2001 (BRI); State Forest 135, S of Imbil, A.R.Bean 5994, 21.iv.1993

(BRI); adjacent to Mt Binga State Forest, 11 km SE of Cooyar, *A.R.Bean 16070*, 21.ii.2000 (BRI, CANB); Mt Glorious, c. 30 km NW of Brisbane, *R.J.Henderson 2166*, 28.ii.1974 (BRI, CANB); C. 60 km SW of Gladstone, Kroombit Tableland, 3.2 km SSW of Amys Peak, *M.D.Crisp 2772*, 4.vi.1977 (CANB). **NEW SOUTH WALES.** Wollomombi Falls, c. 40 km E of Armidale, *J.B.Williams*, 20.xi.1966 (NSW); Maryland River, 41 km WSW of Woodenbong, *M.D.Crisp 2536*, 24.v.1977 (CANB); below Poppet Head Park, Kitchener, *J.R.Hosking 2519*, *R.H.Holtkamp & P.J.Christian*, 3.xi.2004 (CANB, MEL, NE, NSW); W side of Wingen Maid, Wingen Maid Nature Reserve, *J.R.Hosking 2151*, 1.xii.2001 (CANB, MEL, NE, NSW); near Nubrigyn Creek, c. 1 km WSW of "Merrimount" homestead, c. 8 km (direct) SW of Stuart Town, *R.O.Makinson 1200*, 20.x.1992 (CANB, MEL, NSW); Burbie Track to Mt Exmouth, Warrumbungle National Park, *J.H.Willis*, 13.v.1969 (MEL); Moona Plains, Walcha, *A.R.Crawford*, Jan. 1885 (MEL); Nortons Basin near Wallacia, *R.Coveny s.n.*, Oct. 1966 (NSW). **VICTORIA.** Bendoc district, *L.Cunning*, 1930 (MEL); Billygoat Bend, Mitchell River Gorge, *D.Cameron 7504*, 5.xii.1976 (MEL); Nerowie Road, Exford, c. 6 km from Melton, *V.Stajsic 463 & P.Wlodarczyk*, 26.xii.1991 (MEL); Boneo, c. 5 km S of Rosebud, *R.Melville 2252 & N.Wakefield*, 6.xii.1952 (MEL); You Yangs, *J.H.Willis*, 18.xi.1962 (MEL); Paradise Falls, c. 40 km SW of Myrtleford, *A.C.Beauglehole 43747*, 5.xii.1973 (MEL).

**Distribution and habitat:** Occurs in southern Western Australia, southern and central-eastern South Australia, southern Queensland, eastern New South Wales, and eastern and south-central Victoria (Fig. 10). Grows in forest, woodland and grassland, often growing from rock crevices.

**Notes:** *Galium leptogonium* is characterised by the presence of pustules or short antrorsely curved spinules on ovaries and fruit, slender stem-angles, and the development of long fine hairs on stems and leaves. Pustules appear like flattened blisters in dried specimens. The type of ornamentation or indumentum is consistent within plants. Populations with antrorsely curved spinules tend to occur at the northern and western extremes of the range being common west from Kangaroo Island and north from the Queensland–New South Wales border. Populations with pustular ovaries extend from the Eyre Peninsula in South Australia eastwards into New South Wales and Victoria. Hairs and pustules persist in fruit either as scabrosities or as rounded protuberances, although the latter are often not easily seen without very close inspection.

*Galium leptogonium* is similar to *Galium ciliare* and *G. leiocarpum* in leaf shape, slenderness of stem-angles, cyme architecture, and stipule length relative to leaves.

Its long hairs resemble those of *G. ciliare*. However, unlike *G. leptogonium*, *G. ciliare* and *G. leiocarpum* tend to be extensively rhizomatous. Both indumentum types of *G. leptogonium*, the exceptionally long slender hairs and the rather broad-based and strongly retrorse scabrosities, are useful identifying features.

**Hybrids:** The following collections appear to be hybrids: **1.** Kangaroo Island, South Australia (*P.Canty et al.* NPKI 40519 AD; and *B.M.Overton 692* AD): *G. leptogonium* × *G. migrans* subsp. *migrans*. **2.** Gap Gorge, Eyre Peninsula (*D.J.Michael 454* AD) and Yalata (*J.B.Cleland* AD), both South Australia: *G. leptogonium* × *G. bulliformis*. **3.** Waterloo Bay, South Australia (*P.C.Heyligers 80117* AD, CANB): *G. leptogonium* × *G. compactum*. **4.** Murrumbidgee River between the A.C.T. and Cooma, New South Wales (*S.J.Forbes 701* MEL; *I.Crawford 3166* CANB): *G. leptogonium* × *G. polyanthum* (also see under *G. polyanthum*).

**Etymology:** The epithet refers to the stem-angles (from Gk: *lepto*, slender; *gonia*, angle).

### 11. *Galium bulliformis* I.Thomps., sp. nov.

A *G. leptogonium* I.Thomps. *foliis longioribus, ovariis et fructibus vix ornatis sed minute bulliformis, mericarpiis latioribus, caulibus scabridulosis, cymis recurvis, pedunculis plerumque brevioribus, floribus minoribus differt.*

**Type:** SOUTH AUSTRALIA. Reid Lookout, Eyre Peninsula, *J.Z.Weber 7962*, 14 October 1983; holotype: AD; iso: CANB, HO.

**Herbs,** sparsely to moderately indumented with broad-based strongly retrorse scabrosities, occasionally with some long slender hairs to c. 0.6 mm long; rhizomes not seen. **Stems** to c. 1 mm diam., with angles slender; whorls 4-partite or rarely a few 5-partite, with stipules subequal to leaves below inflorescences decreasing slightly upwards to be finally c. 2/3 of leaf length. **Leaves** narrow-elliptic, 3–25 mm long, 1.5–7 mm wide, with l:w ratio mostly 3–7, with petiole-like portion not developed, generally drying dark, usually thin and with reticulate venation discernible on lower leaves; margin mostly recurved or narrowly-revolute; apex acute, commonly with a long terminal hair; adaxial surface with midrib distinct; abaxial surface with midrib distinct, distal glandular cell patch small to moderate, proximal cells not evident. **Inflorescences** extended; cymes (1–)2–6-flowered, often recurved, mostly exceeding whorls

when mature but finally cymes not exceeding whorls; primary peduncle to 20 mm long, glabrous or sparsely scabridulous, ultimate and intermediate peduncles 0.5–6 mm long, inserted moderately to very strongly distally, glabrous; bracts present at all nodes and sometimes developed on ultimate peduncles, shorter or longer than the peduncle it subtends. *Flowers*: corolla 1.0–1.5 mm diam., with lobes 0.4–0.7 mm long, not apiculate, greenish-cream, sometimes tinged purple-red abaxially, glabrous; ovary circular in face view, 0.5–0.7 mm long, glabrous or occasionally with scattered pustules. *Fruit*: fruit-set percentage generally high; developing fruit sublustrous, moderately areolate to bulliform; mature peduncles stout, straight, curved or strongly recurved; mericarps ellipsoid (but flattened medially) or reniform, 1.1–1.6 mm long, 0.8–1.1 mm wide, brown, sometimes rugose with rugae tending to be longitudinally disposed; dissepiment scar 0.4–0.5 mm long.

*Flowers* mostly spring and summer.

**Selected specimens: SOUTH AUSTRALIA.** Kalabity Station, *R.J.Bates* 46751, 29.iii.1997 (AD); W of Glendambo, *R.Bates* 50056, 14.iv.1998 (AD); Kolendo Station, Gawler Ranges, *Gawler Ranges Survey* 8982, 19.x.1985 (AD); c. 8 km E of Nepabunna Station, c. 50 km E of Copley, *T.R.N.Loathian* 3220, 11.xi.1964 (AD); Balcanoona, *R.J.Bates* 34307, 29.ix.1993 (AD); Parachilna Gap, c. 160 km NNE of Port Augusta, *E.H.Ising*, 8.x.1918 (AD); Anabama Hills, 21 km S of W of Great Eastern Dam, *L.D.Williams* 7857, 3.iii.1976 (AD); Canegrass Station, c. 60 km NNE of Morgan, *E.H.Ising*, 22.ix.1937 (AD); Warrina, *Mrs Richards*, 1890 (MEL).

**Distribution and habitat:** Occurs in arid regions of eastern South Australia north of latitude 34° S (Fig. 10). A specimen from Tatura in northern Victoria (*E.Gaubia* CANB) appears to be this species and is presumed to be a transient introduction.

**Notes:** A distinctive species that is probably closest to *G. leptogonium*. Some specimens have very strongly developed glandular cells on the abaxial surface of leaves and the contents are frequently tinged pink to purple. This coloration is not often seen in other species of Australian *Galium*. The occasional 5-partite whorls seen in this species have only otherwise been seen in *G. liratum* a possibly related species by virtue of its large-leaves drying dark, broad-based hairs, bulliform and relatively large fruits. The corolla is nearly the smallest in the group, with only *G. microlobum* having slightly smaller corollas.

**Hybrids:** The following collections appear to be hybrids: **1.** Eyre Peninsula (*D.J.Michael* 454 AD) and Yalata (*J.B.Cleland* AD), both South Australia: *G. bulliformis* × *G. leptogonium*. **2.** Mooloo Hills, Northern Lofty Ranges, South Australia (*R.J.Bates* 64609 AD): *G. bulliformis* × *G. migrans*.

**Etymology:** The epithet refers to the surface of the developing fruit (from L: *bulliformis*, bubble-like).

**12. *Galium binifolium*** N.A.Wakef., *Victorian Naturalist* 72: 69 (1955)

**Type: VICTORIA.** Sand-dunes near Betka River, Mallacoota, *N.A.Wakefield* 4794, 6 January 1953; holo: MEL; iso: NSW.

*Herbs*, sparsely indumented with scabrosities, or less often of hairs to c. 0.3 mm long; occasionally weakly rhizomatous. *Stems* to c. 0.7 mm diam., with angles slender; whorls 4-partite, with stipules 1/4–3/4 of leaf length below inflorescences, generally decreasing upwards to be finally < 1/3 of leaf length or absent. *Leaves* narrow-elliptic, narrow oblong-elliptic or narrow-oblong-elliptic, 3–15 mm long, 1–4 mm wide, with l:w ratio mostly 3–8, with petiole-like portion 0.5–2 mm long, usually thin; margin narrowly recurved or narrowly revolute; apex acute or minutely acuminate, without a terminal hair; adaxial surface with midrib mostly quite distinct; abaxial surface with midrib distinct for most of length, glabrous or occasionally with a few hairs, distal glandular cell patch small, proximal cells variably evident. *Inflorescences* extended; cymes 1–6-flowered, less often up to 10-flowered, exceeding whorls or not, more distal ones often not exceeding whorls; primary peduncle 3–30 mm long, glabrous, scabridulous or hairy; intermediate and ultimate peduncles (1–) 2–15 mm long, inserted strongly distally, sometimes scabridulous; bracts much shorter than to a little longer than peduncle, variably present. *Flowers*: corolla 1.3–2 mm diam., with lobes 0.5–0.8 mm long, not apiculate, greenish to greenish-cream, occasionally tinged purple abaxially, glabrous; ovary c. circular in face view, 0.5–0.6 mm long, glabrous, or rarely with antrorse sub-appressed hairs or scales. *Fruit*: fruit-set percentage generally high; developing fruit often pink-tinged, dull, smooth or areolate; mericarps broad-ellipsoid but compressed medially or slightly reniform, 1.0–1.2 mm long, 0.6–0.9 mm wide, brown, reticulately rugose, with rugae rather slender; dissepiment scar c. 0.4 mm long.

*Flowers* spring–summer.

## Key to subspecies

- 1 Stipules < 1/2 length of leaves in whorls below inflorescences ..... **12a.** subsp. **binifolium**  
 1: Stipules > 1/2 length of leaves in whorls below inflorescences ..... **12b.** subsp. **conforme**

**Notes:** A species with lax, slender stems, thin leaves, relatively short stipules, relatively long inflorescences, small greenish flowers, relatively lax cymes, and mericarps with a thin pericarp forming slender rugae. Hairs and scabrosities are predominantly relatively sparse and short.

**12a. *Galium binifolium* subsp. *binifolium***

?*G. umbrosum* var. *bifolium* F.Muell., *Fragm.* 9: 188 (1875). Type: NEW SOUTH WALES. Hastings-River, Beckler.

[?*G. geminifolium* auct. non F.Muell. (1855): K.Domin, *Biblioth. Bot.* 89: 1184 (1929)]

*Stipules* 1/4–2/5 of length of leaves below inflorescences. Bracts of *cymes* mostly much shorter than peduncle. *Ovary* glabrous or rarely with antrorse-appressed hairs or scales. (Fig. 2a)

**Selected specimens: QUEENSLAND.** Gas Bottle Flat, Little Daintree River, Daintree National Park, *P.I.Forster* 22929 & *R.Jago*, 24.v.1998 (BRI); Western summit ridge of Mount Elliot, S of Townsville, *A.R.Bean* 3580, 9.viii.1991 (BRI); Mt Gillies, c. 20 km SW of Rathdowney, on Lindsay Hwy, *P.R.Sharpe* 2463, 18.x.1978 (BRI); Mt Barney, *D.Halford* Q2276, 4.ix.1994 (BRI). **NEW SOUTH WALES.** Edinburgh Castle, 8 km SSE of Woodenbong, *D.Halford* Q1578, 5.xii.1992 (BRI); Kioloa State Forest, NE of Batemans Bay, *L.G.Adams* 1590, 11.x.1966 (CANB, NSW); Wingello State Forest, c. 2.5 km E along Gulp Road from junction with Nyes Creek Road, *N.M.Taws* 864, 25.i.1999 (CANB, NSW); Merricks Inlet Track, Nadgee Nature Reserve, *M.Parris* 8900, 11.ii.1984 (CANB); Tantawangalo State Forest, 12 km S of Tantawangalo, *I.Crawford* 2259, 24.iv.1993 (CANB); Dalrymple Hay Nature reserve, Pymble, *M.J.Taylor* 121, 9.xi.1983 (MEL, NSW); Clyde River, *W.Bauerlen*, Nov. 1884 (MEL); Hawkesbury River, near Sydney, *J.B.Cleland*, Dec. 1912 (AD). **VICTORIA.** Mt Drummer, *R.Melville* 2819, 12.i.1953 (AD); Little River area, Mallacoota Inlet National Park, *A.C.Beauglehole* 31772, 16.i.1969 (MEL, NSW); Wilsons Promontory, *A.C.Beauglehole* 75270 & *J.G.Eichler*, 8.xi.1983 (MEL); N side of Mt Elizabeth II, *A.C.Beauglehole* 37130, 28.ii.1971 (MEL, NSW); Fairy Dell, Deep Creek catchment, 5.5 km WNW of Bruthen, *D.Cameron* 3057, 18.ii.1975 (MEL); Mouth of Betka River, *R.Melville* 2782, 9.i.1953 (AD, MEL); Brodribb Forest, near Orbost, *E.A.Chesterfield* 932,

15.iii.1986 (MEL); Princes Hwy, W of Toorloo Arm, Lake Tyers, 9 km NE of Lakes Entrance, *D.Cameron* 7579, 8.xii.1976 (MEL).

**Distribution and habitat:** Occurs in eastern New South Wales, in far eastern Victoria, and eastern Queensland where it occurs in three widely separated localities: Daintree National Park, near Townsville, and just north of the Queensland–New South Wales border (Fig. 11). Grows in open and closed forest.

**Notes:** Distinguishable from all other native species by its short stipules. Plants are typically lax, sprawling, with stems glabrous or with scabrosities. Most cymes greatly exceed the whorls and the primary peduncle is generally much longer than intermediate peduncles. A few specimens have curved short antrorse-appressed hairs on the ovaries, e.g. Lakes Entrance, Victoria (*D.G.Cameron* 7579 MEL) and Townsville, north Queensland (*A.R.Bean* 3580 BRI). Sometimes the structures appear more like crescentic scales. No such specimens have been collected at fruiting.

**Hybrids:** The following collections appear to be hybrids: **1.** Dover Island, Bass Strait (*S.Murray-Smith* MEL): *G. binifolium* subsp. *binifolium* × *G. densum*. **2.** Wyong (*H.Salasoo* 1619 NSW); Wallangra (*F.A.Rodway*, 1929 NSW); Maralya (*D.Benson* 1623 NSW), and others from New South Wales, plus Mallacoota, Victoria (*A.C.Beauglehole* 31772 MEL): *G. binifolium* subsp. *binifolium* × *G. gaudichaudii*. **3.** Bega, New South Wales (*S.J.Forbes* 891 MEL): *G. binifolium* subsp. *binifolium* × *G. liratum*.

**12b. *Galium binifolium* subsp. *conforme***

*I.Thompson., subsp. nov.*

*A subspecies typica foliis stipulis < 2-plo longioribus sub inflorescentiam primariam differt.*

**Type: VICTORIA.** Chambers Flora Reserve, c. 200 m S of Bourkes Rd, Upper Beaconsfield, *I.R.Thompson* 857, 18 November 2005; holotype: MEL; isotype: AD, BRI, CANB, HO.

*G. vagans* Hook.f., in *W.J.Hooker, London J. Bot.* 6: 461 bis (1847). Type: Tasmania: locality unknown, *R.C.Gunn* 548; holotype: K n.v., photo MEL, NSW. [Synonymised with some uncertainty, see notes below.]

*Stipules* 1/2–3/4 of length of leaves below inflorescences. Bracts of cymes much shorter than to c. twice as long as peduncle, rarely longer. *Ovary* glabrous.

**Selected specimens:** **NEW SOUTH WALES.** Dubbo, *J.B.Cleland*, 29.ix.1911 (AD); Saltwater Creek camping ground, *D.E.Albrecht 404*, 22.iv.1984 (MEL); Woomargama National Park, Cockatoo Creek catchment, 3.8 km directly SW of Tipperary, *I.Crawford 7082*, 13.xii.2001 (CANB). **VICTORIA.** Bright, *R.J.Bates 3594*, 22.i.1984 (AD); Seaton Education Area, *A.C.Beauglehole 78257*, 10.x.1984 (MEL); Rotamah Island, The Lakes National Park, *I.Crawford 509*, 10.x.1986 (MEL); 1300 m from Big Hill Fire Tower, Clover Forest Block, *A.Pyrke 41*, 8.i.1987 (MEL); Waterfall Creek, Kings Falls circuit walk, Arthurs Seat State Park, *I.R.Thompson 1040*, 3.i.2008 (AD, CANB, HO, MEL); Currawong Falls Walking Track, c. 6 km WSW of Anglesea PO, *A.C.Beauglehole 63556*, 19.i.1979 (MEL, NSW); Wombelano Falls, Kinglake National Park, *J.H.Willis*, 16.ii.1984 (MEL); Toorloo Arm, *N.A.Wakefield 4572*, Dec. 1950 (MEL). **TASMANIA.** Cape Barren Island, *J.S.Whinray 474*, 23.xii.1968 (MEL); above Pipers River near Karoola, *A.M.Buchanan 4894*, 13.xii.1984 (HO); Bridport, *W.M.Curtis*, 10.xi.1952 (HO).

**Distribution and habitat:** Occurs in southern New South Wales, eastern and south-central Victoria, and northern Tasmania. There is also one record from Dubbo, in central-eastern New South Wales; however, there must be some doubt about this locality. Grows in damp to wet forests.

**Notes:** Not readily distinguishable from the type subspecies apart from the difference in stipule length, although more commonly it has shorter, more congested cymes. Not infrequently, the maximum number of flowers in a cyme in subsp. *conforme* is two. In such plants the primary peduncle of the lower cymes is generally 3 mm long or more.

This subspecies may be difficult to distinguish from *G. gaudichaudii* subsp. *parviflorum* which has similar-sized corollas and similar ovary and fruit morphology. Identification is also complicated by the possibility of hybridisation since their distributions overlap considerably. *G. binifolium* subsp. *conforme* is a more delicate plant, generally with fewer, laxer stems, more slender and less hairy stem-angles, and laxer cymes. Leaves are thinner and more oblanceolate, dry mid to dark green rather than olive-green, and have a glabrous abaxial midrib and a less conspicuous glandular cell patch. The corolla of *G. binifolium* subsp. *conforme* is usually not pigmented purple-red abaxially. The

pericarp is relatively thin, as it is in the type variety, and so mericarps are more narrowly rugose. Laxer-cymed forms of *Galium gaudichaudii* subsp. *gaudichaudii* are also similar to *G. binifolium* subsp. *conforme* but they always have flowers with conspicuously larger corollas. In many specimens of *G. binifolium* subsp. *conforme* the primary peduncles have spreading hairs in contrast to the stems which are scabridulous.

Remarkably almost all collections of subsp. *conforme* have been collected in the past 30 years and from localities west of the Snowy River in Victoria. This post-dates Wakefield's naming of *G. binifolium* in 1955. In the protologue Wakefield described *G. binifolium* as occurring east and north of the Snowy river extending well into New South Wales. These recent collections, although having relatively long stipules, have been predominantly referred to *G. binifolium* by herbaria. A few have been determined as *G. gaudichaudii*.

*Galium vagans* appears likely to be synonymous with *G. binifolium* subsp. *conforme*, although it possibly could be *G. gaudichaudii* var. *parviflorum*. The specimen at K has not been seen. Hooker changed (?inadvertently) his original description of *G. vagans* when he described it later in *Fl. Tasmaniae* so that it translated to "peduncles longer than leaves" rather than "peduncles shorter than leaves".

**Hybrids:** The following collections appear to be hybrids: **1.** Mt Buffalo (*A.C.Beauglehole 92291* MEL); Murrindal (*D.E.Albrecht 4612* MEL); and Pine Mountain (*J.H.Willis* MEL) and Mt Tingaringy (*A.C.Beauglehole 35737* MEL), all in eastern Victoria: all *G. binifolium* subsp. *conforme* × *G. polyanthum*. **2.** Mt Porepunkah, near Bright, Victoria (*A.C.Beauglehole 43672* MEL): *G. binifolium* subsp. *conforme* × *G. gaudichaudii* subsp. *parviflorum*. This a mixed sheet containing the two parents, and possibly a hybrid piece.

**Etymology:** The subspecific epithet refers to the whorls in this subspecies conforming with most other species of *Galium* in terms of leaf to stipule length ratio (from L: *conformis*, to agree with).

### **13. *Galium polyanthum* I.Thomps., sp. nov.**

*A. G. gaudichaudii* DC. *foliis latioribus, cymis verticillos superantibus multum omnino, pedunculis longioribus, costis inferne dense hirtis, cellulis glandulosis minus conspicuis differt; a G. migranti Ehrend. & McGill.*

*ovariis latioribus quam longioribus laevibus, mericarpiis longioribus et cicatrice dissepimentorum longiore differt.*

**Type:** NEW SOUTH WALES. Woomargama National Park, Jingellic trig., 9 km directly west of Jingellic village, *I.Crawford 7075*, 12 December 2001; holo: CANB; iso: MEL.

*G. migrans sensu* D.J.McGillivray, *Teloepa* 2(4): 362 (1983), *p.p.* excl. lectotype; T.A.James & W.K.Allen, *Fl. New South Wales* 3: 486 (1992), *p.p.*; J.A.Jeanes, *Fl. Victoria* 4: 625 (1999), *p.p.*

**Herbs**, mostly densely indumented with slender hairs to 0.8 mm long; rhizomes not seen. **Stems** to c. 0.8 mm diam., with angles slightly to moderately broadened, sometimes as wide as faces; whorls 4-partite, with stipules c. 3/5 to subequal to length of leaves below inflorescences, decreasing upwards to be finally < 1/3 of leaf length or absent. **Leaves** narrow-elliptic or linear-elliptic, 3–25 mm long, 1–6 mm wide, with l:w ratio mostly 3–9, with petiole-like portion 0.5–3 mm long; margin recurved or revolute; apex acute or slightly obtuse, sometimes with a terminal hair; adaxial surface with midrib generally indistinct; abaxial surface with midrib distinct for much of length and usually moderately hairy, with hairs sometimes also arising from lamina, distal glandular cell patch small, proximal cells not evident. **Inflorescences** extended or soon terminating; cymes (2–)3–30-flowered, exceeding whorls when mature, generally markedly so; primary peduncle 3–50 mm long, usually hairy; intermediate and ultimate peduncles 1–10 mm long, generally inserted distally, often hairy; bracts generally shorter than peduncle, often absent at some nodes. **Flowers**: corolla 1.8–2.5(–3) mm diam., with lobes 0.7–1.3 mm long, sometimes short-apiculate, greenish-cream or cream, sometimes purplish-red abaxially, occasionally hairy abaxially; ovary circular or more often slightly oblate in face view, 0.2–0.4 mm long, most often glabrous, but also hairy; hairs 0.3–0.6 mm long, spreading, straight or weakly curled to hooked, or c. 0.1 mm long, subappressed, curved. **Fruit**: fruit-set percentage generally high; developing fruit dull, smooth; mericarps reniform, 1.0–1.1 mm long, 0.6–0.8 mm wide, dark brown, reticulately rugose; dissepiment scar 0.2–0.4 mm long.

**Flowers** mid-spring–summer.

**Selected specimens:** NEW SOUTH WALES. Head of Macleay River, *L.Leichhardt*, 1843 (NSW); “Innstable” Cave entrance, 3.5 km SE of Yarrangobilly River Crossing on Snowy Mountains Hwy, Kosciuszko National Park, *P.Hind 5568*, 19.iv.1988 (NSW); Braidwood district, *W.Bauerlen 223*, Dec. 1884 (MEL); Wee Jasper Caves, *T. & J.Whaite 2834*, 24.x.1964 (NSW); Booroomba Rocks, *I.R.Telford 7244*, 18.xii.1978 (CANB, NSW); Geehi River track below Pinnacle track, W of Mt Townsend, *N.C.Ford*, 9.i.1959 (NSW). AUSTRALIAN CAPITAL TERRITORY. Glendale, Gudgenby River, *N.Burbidge 6173 & M.Gray*, 23.xii.1958 (CANB, MEL); summit of Deadman’s Hill, 3 km NE of Honeysuckle Creek Tracking Station, *B.J.Lepschi 256*, 23 December 1989 (CANB, NSW); Near Mt Coree, *M.Gray 4970*, May 1961 (CANB); Near Big Hole, c. 9 km NE of Krawarree, *L.G.Adams 1527*, 28.xi.1965 (CANB). VICTORIA. 71 km from Corryong toward Omeo, *E.M.Canning 1457*, 4.i.1969 (CANB); Walking track W side of Toorloo Arm of Lake Tyers, *I.R.Thompson 956*, 14.xii.2006 (AD, BRI, CANB, HO, MEL, NSW, PERTH); Upper Ovens River, *E.M.Nye*, Nov. 1885 (MEL); Cattleyard Track, Ellery Forest Block, *G.E.Earl 330*, 11.i.1987 (MEL); near Razor Track, West Buffalo River, *E.A.Chesterfield 2769*, 10.xii.1990 (BRI, MEL, NSW); Banks of Boundary Creek below the “Bare Rock”, Wulgulmerang, *J.H.Willis*, 28.xi.1962 (MEL); Limestone Creek, E of Benambra, *J.H.Willis*, 1.ii.1946 (MEL); Mitta Mitta Reference Area, *A.C.Beauglehole 91372*, 10.xi.1987 (MEL).

**Distribution and habitat:** Occurs in south-eastern New South Wales, the Australian Capital Territory, and eastern Victoria (Fig. 11). There is also an 1843 record from the Macleay River in far north-eastern New South Wales (*L.Leichhardt* NSW). Grows in forest often among rocks, particularly on limestone and granite, at low altitudes or more often montane.

**Notes:** A species characterised by mostly soon-terminating inflorescences with generally lax cymes that are long relative to the whorls, and flowers with small ovaries. Leaves are relatively large and the indumentum is commonly dense and composed of moderately long, narrow-based hairs. The developing fruit has a more or less smooth surface. Particularly in Victoria, a proportion of specimens are less hairy, with fewer-flowered cymes and smaller corollas and in these respects they resemble *Galium binifolium*. *Galium binifolium* subsp. *binifolium* is distinguishable by its very short stipules, while subsp. *conforme* is distinguishable by the shorter, narrower leaves that have no long hairs present. Apart from these features, mature cymes ultimately become shorter than whorls in *G. binifolium* but not in *G. polyanthum*.

Compared to *G. migrans* the ovary and fruit are shorter, different in shape, and do not have a papillose epidermis, and the inflorescences are typically soon terminating with terminal cymes much exceeding the terminal node.

Compared to *G. gaudichaudii*, leaves are generally broader and a little longer, hairier along the abaxial midrib, with a more sharply defined abaxial midrib, and with much less development of glandular cells. Inflorescences are shorter in terms of node number, cymes are laxer and more floriferous and usually with hairier branchlets, and ovaries are smaller. The flowers are overall smaller than in *G. gaudichaudii* subsp. *gaudichaudii* but they have a similar corolla:ovary size ratio.

*Galium leptogonium* can resemble *G. polyanthum*, but the latter has broader stem-angles, ovaries lacking pustules, often more floriferous cymes, and the stem and leaf hairs tend to be both more crowded and shorter.

Some specimens, all from New South Wales and the A.C.T., have hairs on the ovaries and fruit, and there is a perplexing diversity of types. Sometimes hairs are long, spreading and straight, e.g. Head of Macleay River (*L. Leichhardt* NSW; locality uncertain) and Cleatmore Caves (*I.R. Telford 6865* CANB), sometimes moderately long and spreading, curled to weakly hooked close to those in *G. australe*, e.g. Clyde district (*W. Bauerlen 135* MEL) and Krawarree (*L.G. Adams 1527* CANB), and sometimes short antrorsely curved sub-appressed and rather sparse, Yarrangobilly River (*P. Hind 5568* NSW; *R. Jackson 102* CANB). Further investigations of these forms are desirable.

**Hybrids:** The following collections appear to be hybrids: **1.** Mt Buffalo (*A.C. Beaglehole 92291* MEL); Murrindal (*D.E. Albrecht 4612* MEL); and Pine Mountain (*J.H. Willis* MEL) all in eastern Victoria: all *G. polyanthum* × *G. binifolium* subsp. *conforme*. **2.** Jingallala River, eastern Victoria (*A.C. Beaglehole 35735B* MEL), Tubbut, eastern Victoria (*A.C. Beaglehole 68001* MEL) and Geehi Dam, Snowy mountains, New South Wales (*J. Miles s.n.* NSW709911): all *G. polyanthum* × *G. gaudichaudii* subsp. *parviflorum*. **3.** Plum Creek, East Gippsland (*D.E. Albrecht 347* MEL) and Mt Clear (*A.C. Beaglehole 41248* MEL), both in Victoria: both *G. polyanthum* × *G. ciliare* subsp. *ciliare*.

**Etymology:** The epithet refers to the relatively floriferous cymes (from Gk: *poly*, many and *anthos*, flower)

#### 14. *Galium bungoniensis* I.Thomps., sp. nov.

A *G. polyanthum* I.Thomps. *angulis caulium latioribus, cymis foliis non superantibus apicem versus differt.*

**Type: NEW SOUTH WALES.** Bungonia Gorge south of Marulan, *L.G. Adams 1623*, 10 November 1966; holotype: CANB sheet 1; isotype: CANB sheet 2.

*Herbs*, densely indumented with slender spreading hairs mostly 0.2–0.4 mm long; rootstock becoming stout; rhizomes not seen. *Stems* to c. 1 mm diam., with angles broader than the faces; whorls 4-partite, with stipules c. 3/5 to subequal to length of leaves below inflorescences, decreasing upwards to be finally  $\leq 1/2$  of leaf length. *Leaves* elliptic, narrow-elliptic, ovate or lanceolate, 3–14 mm long, 1–4 mm wide, with l:w ratio mostly 1.5–4 with petiole-like portion obscure; margin recurved to strongly revolute; apex acute to very acute, sometimes with a terminal hair; adaxial surface with midrib indistinct; abaxial surface with midrib distinct proximally and moderately hairy, with hairs sometimes arising from lamina, distal glandular cell patch small, proximal cells not evident. *Inflorescences* extended; cymes 3–20-flowered, exceeding whorls when mature or most distal cymes hardly exceeding whorl; primary peduncle to 15 mm long, hairy; intermediate and ultimate peduncles 0.5–8 mm long, inserted distally, mostly hairy; bracts shorter than peduncle, variably present. *Flowers:* corolla 2–3.5 mm diam., with lobes 0.8–1.4 mm long, apiculate, cream or greenish-cream, sometimes tinged purplish-red abaxially, sometimes hairy; ovary c. circular in face view, 0.4–0.5 mm long, with spreading hairs 0.3–0.7 mm long, straight or irregularly wavy or curled apically. *Fruit:* fruit-set percentage generally high; developing fruit dull, smooth; mature mericarps not seen, 1.0–1.2 mm long, probably reticulately rugose; dissepiment scar not measured.

*Flowers* spring–summer.

**Selected specimens: NEW SOUTH WALES.** Bungonia Lookdown, Bungonia State Recreation Reserve, 30 km ESE of Goulburn, *P. Beesley 434 & E.M. Canning*, 24.ix.1985 (CANB); Mass Cave, Bungonia State Conservation Area, *K. McDougall 979*, 20.ix.2001 (MEL).



## Key to subspecies

1 Stem-angles narrower than faces .....	15a. subsp. <i>migrans</i>
1: Stem-angles broader than faces (faces reduced to grooves) .....	2
2 Ovary and fruit glabrous .....	15b. subsp. <i>inversum</i>
2: Ovary and fruit hairy .....	15c. subsp. <i>trichogynum</i>

**Distribution and habitat:** Occurs near Goulburn in central-eastern New South Wales (Fig. 11). Grows in crevices in limestone rocks in forest at an altitude of c. 600 m.

**Notes:** *Galium bungoniensis* is characterised by its stout rootstock, multistemmed habit with relatively robust stems, broad bristly stem-angles, floriferous cymes, and hairy ovaries. Unusually in Australian *Galium*, the hairs at the margin of the stem-angles are oriented transversely across the stem faces. The long hairs on the fruit, although sometimes nearly hooked, are not regularly and minutely hooked as in *G. australe*, *G. densum* and *G. albescens* (see fig. 4f).

**Etymology:** The epithet refers to the only known location of this species.

**15. *Galium migrans*** Ehrend. & McGill., *Telopea* 2: 362 (1983)

*G. erythrorrhizum* F.Muell. ex Miq., *Ned. Kruidk. Arch.* 4:113 (1856), *nom. illeg. non* Boiss. & Reut. (1852).

**Type:** SOUTH AUSTRALIA. Kangaroo Island, F.Mueller; lecto: U, *fide* D.J.McGillivray, *Telopea* 2: 360 (1983). Remaining syntype; South Australia: in valle Schlanken, Behr; syn: U; isosyn: MEL.

**Herbs,** sparsely to moderately indumented with slender or slightly coarse hairs to 0.4 mm long or scabrosities; rhizomes not seen. **Stems** to c. 0.8 mm diam., with angles slender, mildly broadened or extremely broad with faces reduced to narrow grooves; whorls 4-partite, with stipules nearly equal to leaf length below inflorescences, decreasing upwards to be finally c. 1/2 of leaf length, occasionally less. **Leaves** elliptic or narrow-elliptic, 5–12 mm long, 1–5 mm wide, with l:w ratio mostly 1.5–10, with petiole-like portion to c. 1 mm long or obscure; margin recurved to revolute; apex acute, often with a terminal hair; adaxial surface with midrib usually weakly defined; abaxial surface with midrib distinct in proximal half and variably hairy, with hairs occasionally arising from the lamina, distal glandular cell

patch small to moderate, proximal cells variably evident. **Inflorescences** usually extended, sometimes only 3 or 4 nodes long; cymes 2–12-flowered, mostly exceeding leaves; primary peduncle 2–25 mm long, sometimes hairy or scabridulous; intermediate and ultimate peduncles (1.5–)2–10 mm long, inserted distally often strongly so, sometimes scabridulous or hairy; bracts mostly shorter than peduncle, variably present. **Flowers:** corolla (2–)2.5–4 mm diam., with lobes (0.8–)1.0–1.8 mm long, short- to long-apiculate, cream or tinged purplish abaxially or completely suffused purple, often hairy abaxially; ovary mostly broad-elliptic in face view, 0.4–0.6 mm long, glabrous or rarely covered with short spreading hairs. **Fruit:** fruit-set percentage sometimes low; developing fruit dull to sublustrous, usually finely papillose, sometimes acutely; mericarps reniform, 1.2–1.7 mm long, 0.6–0.8 mm wide, dark red-purple, reticulately rugose, but rugae often poorly formed; dissepiment scar 0.7–1 mm long.

**Flowers** spring–summer.

**Distribution and habitat:** Occurs in south-eastern South Australia from the northern Flinders Ranges south to Kangaroo Island (Fig. 11).

**Notes:** Leaves below inflorescences are generally relatively broad (2–4 mm wide) but are much narrower within inflorescences. The ovaries have a higher l:w ratio compared with *G. gaudichaudii* and this higher ratio persists as they develop post-fertilisation. Although similar to forms of *G. gaudichaudii* with lax cymes, this species is perhaps more closely related to *G. compactum* q.v. based on similarities in floral and fruit morphology. Corolla-lobes have a more pronounced acuminate apex than in other species, are sometimes suffused purple-red abaxially and also adaxially (at least in pressed specimens), and are often hairy abaxially. Stamen-filaments are often purple. Cyme branchlets are sometimes almost filiform.

**15a. *Galium migrans*** Ehrend. & McGill. subsp. *migrans*

*Stems and leaves* with a sparse to dense indumentum of most slightly retrorse hairs or of scabrosities. *Stem-angles* in primary and secondary inflorescences narrower than the faces. *Leaves* 4–12 mm long, with l:w ratio 3–6, with hairs occasionally scattered over lower surface. *Inflorescences*: cymes sometimes with dichasial branching at second node, with peduncles slender to filamentous; primary peduncles 6–25 mm long; intermediate and ultimate peduncles mostly 2–8 mm long, glabrous or minutely scabrous. *Flowers*: corolla 2–3.5 mm diam., pale yellow throughout or suffused purple abaxially or purplish throughout, sometimes hairy abaxially; ovary glabrous. (Fig. 4c, 4g-i)

**Selected specimens:** SOUTH AUSTRALIA. Hallett Cove, S of Adelaide, *H.Eichler* 16353, 7.xi.1959 (AD, CANB, HO); Hopkins Creek, Northern Lofty Ranges, *R.J.Bates* 63639, 23.ix.2004 (AD); Deep Creek Conservation Park, *D.E.Murfet s.n.*, 12.x.1988 (AD); c. 2 km S of Spring Mount trig, which is c. 8 km SE of Myponga, *E.A.Shaw* 732, 23.ix.1966 (AD); Willowie East Forest Reserve, Flinders Ranges, *C.O'Malley* 414, 7.xii.1984 (AD); 6.8 km NE of Birchmore Lagoon, Kangaroo Island, *P.J.Lang* & *A.Maguire* NPK130883, 19.xi.1989 (AD); overlooking Kangaroo Creek Reservoir, Torrens Gorge Central, *A.G.Spooner* 10507, 27.xi.1986 (AD); Montacute Conservation Park, *D.E.Murfet* 3423 & *R.L.Taplin*, 27.xi.1998 (AD); Worlds End Creek, Burra Gorge, *R.J.Bates* 35333, 20.xi.1993 (AD); Alligator Creek, Wilmington, *E.H.Ising*, 23.x.1928 (AD); Mt Bryan, Flinders Ranges, *R.J.Bates* 34648, 22.x.1993 (AD, MEL); Mooloo Hills, N of Hallett, *R.J.Bates* 64609, Jan. 2005 (AD, MEL); Red Hill Reserve, c. 160 km NNW of Adelaide, *J.B.Cleland*, 6.ix.1963 (AD); Mt Remarkable, c. 50 km SE of Port Augusta, *E.H.Ising*, 25.x.1928 (AD).

**Distribution and habitat:** Occurs in south-eastern South Australia from the southern Flinders Ranges south to Kangaroo Island (Fig. 11). Its distribution overlaps that of subsp. *inversum* in the southern Flinders Ranges. Grows in forest and woodland.

**Notes:** Forms from Alligator Gorge in the Flinders Ranges (*R.J.Bates* 45462 AD) and nearby Mt Remarkable (*R.J.Bates* 26147 AD) are unusual in having stems, leaves and cyme-branchlets with relatively long spreading hairs and in the former having green petals and ovaries (green on drying). Ovary shape is typical of *G. migrans* but is not as papillose as usual. Further collections from this locality are desirable. A specimen from near Parndana on Kangaroo Island (*P.J.Lang* D8205 AD) is unusual in having

relatively small flowers. In all other respects it is typical of the *G. migrans* subsp. *migrans*. There is no likely alternative parent to account for this specimen being a hybrid.

**Hybrids:** The following collections appear to be hybrids: **1.** Yorke Peninsula (*T.R.N.Lothian* 1145 AD); Torrens Gorge (*A.G.Spooner* 1138 AD); Encounter Bay, (*J.B.Cleland* Jan. 1929 AD): *G. migrans* subsp. *migrans* × *G. compactum*. **2.** Mt Lofty Ranges (*T.J.Smith* 877 AD): *G. migrans* subsp. *migrans* × *G. gaudichaudii* subsp. *gaudichaudii*. **3.** Pelican Lagoon section 490, Dudley Peninsula, Kangaroo Island (*B.M.Overton* 692 AD): *G. migrans* subsp. *migrans* × *G. leptogonium*.

**15b. *Galium migrans*** subsp. *inversum* I.Thomps. subsp. nov.

*A subspecies typica angulis caulium insigniter latioribus differt.*

**Type:** SOUTH AUSTRALIA. C. 20 km east of Parachilna, Northern Flinders Ranges, *T.R.N.Lothian* 948, 6 October 1960; holotype: AD; isotype: K, BM, both *n.v.*

*Stems and leaves* with a sparse to dense indumentum of most slightly retrorse hairs or of scabrosities. *Stem-angles* in primary and secondary inflorescences broader than the faces, the latter reduced to a narrow groove. *Leaves* 3–12 mm long, with l:w ratio 2–4, with hairs occasionally scattered over abaxial surface. *Inflorescences*: cymes with only monochasial branching after primary node, with peduncles usually filamentous; primary peduncles to 25 mm long; intermediate and ultimate peduncles mostly 3–12 mm long, glabrous or scabrous. *Flowers*: corolla 2.5–3.5 mm diam., pale yellow throughout, or suffused purple abaxially, usually hairy abaxially; ovary glabrous. (Fig. 1a-iii)

**Selected specimens:** SOUTH AUSTRALIA. Baratta Hills, *R.Bates* 7143, 11.ix.1986 (AD); Radium Creek on Arkaroola Station, 95 km E of Leigh Creek, *T.R.N.Lothian* 5047, 1.x.1969 (AD); Between Hawker and Moolooloo Station, c. 100 km N of Hawker, *B.B.Carrodus*, Sept. 1956 (AD); west edge on the NE border of Kanyaka Creek, *F.Mollemans* 1307, 11.x.1981 (AD); Near Italowie, Gammon National Park, *R.J.Bates* 34092, 27.ix.1993 (AD); Bolla Bollana Creek, *L.D.Williams* 11574, 28.x.1980 (AD).

**Distribution and habitat:** Occurs in the Flinders Ranges and Gammon Ranges of south-eastern South Australia (Fig. 11). Grows in rocky crevices on slopes down to streams.

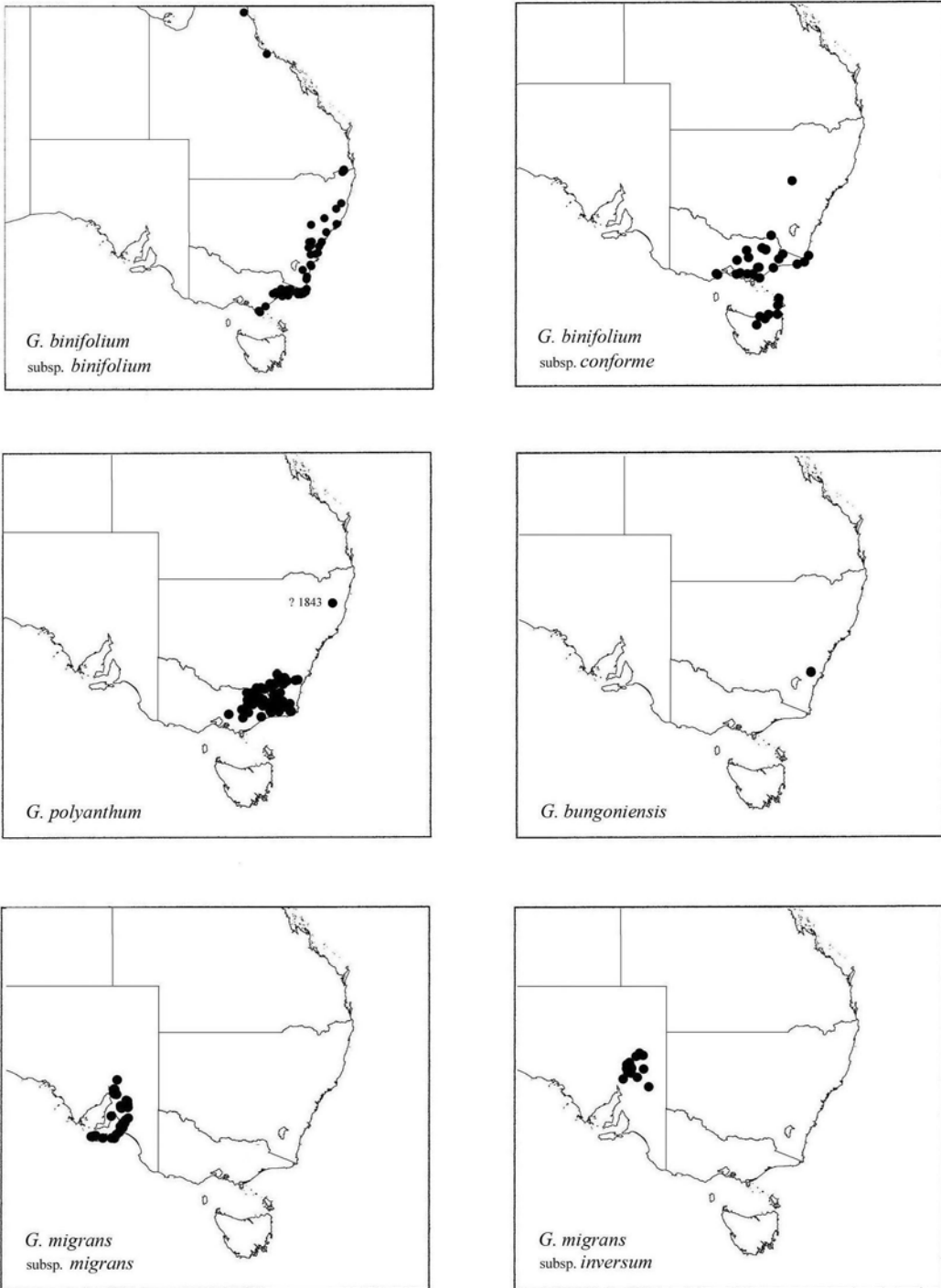

**Figure 11.** Distributions of *Galium binifolium* subsp. *binifolium*, *G. binifolium* subsp. *conforme*, *G. polyanthum*, *G. bungoniensis*, *G. migrans* subsp. *migrans*, *G. migrans* subsp. *inversum*.

**Notes:** This subspecies generally has longer, more slender and more distally inserted peduncles than the other two subspecies. The stem-angles more completely cover the faces than in subsp. *trichogynum*.

**Etymology:** The subspecific epithet refers to the reversal of the ratio of stem-angle width to face width in this subspecies compared to the type subspecies (from L: *inversus*, the other way round).

### 15c. *Galium migrans* subsp. *trichogynum*

I. Thomps., *subsp. nov.*

*A subspecies typica angulis caulium insigniter latioribus, ovariiis hirtis differt.*

**Type:** SOUTH AUSTRALIA. Below Mount Chambers, Mount Chambers Gorge, c. 65 km east of Blinman, northern Flinders Ranges, *R. Schodde 834*, 2 September 1958; holo: AD; iso: CANB.

*Stems and leaves* with a moderately dense indumentum of spreading hairs. *Stem-angles* in primary inflorescences broader than the faces, the latter mostly reduced to a fine groove, those in secondary inflorescences sometimes with face more exposed. *Leaves* 3–8 mm long, with l:w ratio 1.5–3, with hairs scattered over abaxial surface. *Inflorescences:* cymes with only monochasial branching after primary node, with peduncles slender; primary peduncles 4–12 mm long; intermediate and ultimate peduncles mostly 2–6 mm long, hairy. *Flowers:* corolla 2.5–4 mm diam., pale yellow or greenish-yellow, usually hairy abaxially; ovary with short straight spreading hairs. Mature *mericarps* not seen.

**Selected specimens:** SOUTH AUSTRALIA. Mt Chambers Gorge, Flinders Ranges, *R. Filson 3463*, 6.x.1960 (AD, MEL); Mt Chambers Creek, 1 km N of Mt Chambers, *A.J.A. Sikkes 931* & *P. Ollerenshaw*, 24.ix.1973 (CANB).

**Distribution and habitat:** Occurs on Mount Chambers in the northern Flinders Ranges in south-eastern South Australia (Fig. 12). Grows in rock crevices in woodland.

**Notes:** This subspecies is characterised by its distinctively bristly ovaries and fruit. It is like subsp. *inversum* in having broad stem-angles although the angles do not as consistently obscure the faces. As well as the ovaries being bristly, a similar indumentum occurs over the whole plant, and this indumentum type is different to that of the other subspecies. Subsp. *trichogynum* also differs in having generally thicker peduncles which insert less strongly distally.

**Etymology:** The subspecific epithet refers to the hairs on the ovary (from Gk: *trich-*, hairy and *gyne*, female).

### 16. *Galium compactum* Ehrend. & McGill., *Telopea* 2: 370 (1983)

**Type:** SOUTH AUSTRALIA. Road to Cape du Couedic, c. 1.5 km S of Rocky River Homestead, Kangaroo Island, *Hj. Eichler 15376*, 11 November 1958; holo: AD.

*Herbs*, sparsely to densely indumented with slender hairs to 0.8 mm long; rootstock becoming stout, sometimes rhizomatous. *Stems* to c. 0.5 mm diam., with angles mildly to strongly broadened and sometimes broader than faces. *Whorls* commonly closely spaced; stipules similar to leaf length below inflorescences, hardly or only slightly decreasing in length upwards. *Leaves* narrow-elliptic to broad-elliptic, ovate or lanceolate, 1–8 mm long, 0.5–1.5 mm wide, with l:w ratio mostly 1–8, with petiole-like region short or obscure; margin flat, recurved or less often revolute; apex acute, often with 1 or more terminal hairs; adaxial surface with midrib hardly evident; abaxial surface: midrib distinct proximally, glabrous or with a few hairs, distal glandular cell patch large, proximal cells usually evident, often coalescing and extensive. *Inflorescences* extended; cymes 1- or 2-flowered, occasionally a few 3-flowered, not exceeding whorls when mature, or occasionally lowermost 1 or 2 exceeding whorls; primary peduncle 0–4 mm long, glabrous or hairy; ultimate peduncles up to c. 1 mm long, with insertion point variable, glabrous; bracts longer than peduncle, mostly present. *Flowers:* corolla 2–3 mm diam., with lobes 0.8–1.4 mm long, sometimes short-apiculate, cream or greenish-cream or tinged or completely suffused purple, sometimes purplish abaxially only, usually glabrous; ovary broad-elliptic in face view, 0.6–0.8 mm long, glabrous. *Fruit:* fruit-set percentage generally high; developing fruit lustrous, finely papillose, often acutely; *mericarps* reniform 1.2–1.6 mm long, 0.6–0.8 mm wide, dark brown or often becoming purple-red, reticulately rugose; dissepiment scar 0.7–1 mm long.

*Flowers* spring–summer.

**Selected specimens:** SOUTH AUSTRALIA. 10 km NW of Bordertown, *R.J. Bates 40102*, 27.xi.1994 (AD); Dry Creek Landing N of Donovan, *R.J. Bates 41316*, 3.i.1996 (AD); Canunda National Park, *P.C. Heyligers 83030*, 9.x.1983 (AD, CANB); Newland Head

Conservation Park, *D.E.Murfet* 566, 6.x.1987 (AD); Between Pandalowie Bay and Shell Beach, Innes National Park, *J.Z.Weber* 4324, 11.x.1974 (AD); Lenger National Trust Reserve, N of Mannum, *A.G.Spooner* 12720, 14.ix.1991 (AD); Black Hill, c. 80 km ENE of Adelaide, *J.B.Cleland*, 15.x.1966 (AD); Rocky Gully Creek, c. 15 km W of Murray Bridge, *J.Carrick* 3697, 1.x.1974 (AD); West Bay, Kangaroo Island, *R.J.Bates* 30270, 21.xii.1992 (AD); Port Lincoln, *J.Browne*, 1875 (MEL); Tailern Bend, *I.R.Thompson s.n.*, 29.ix.1995 (MEL). **VICTORIA.** W side of Cape Nelson, 11.5 km SSW of Portland, *A.C.Beauglehole* 50388, 3.i.1976 (MEL, NSW); SE of Aire River bridge on Hordern Vale Rd, c. 6 km NNW of Cape Otway Lighthouse, *A.C.Beauglehole* 49607, 11.xi.1974 (MEL, NSW); Beach Gully, Bridgewater Bay, *R.Melville, C.Beauglehole, P.Finck & E.Finck*, 11.x.1952 (MEL); Wilsons Promontory National Park, *A.C.Beauglehole* 75970, 15.xii.1983 (MEL); Cape Nelson, *I.R.Thompson* 925, 25.xi.2006 (CANB, MEL). **TASMANIA.** Marshall Bay, Flinders Island, *J.S.Whinray* 1621 (CANB).

**Distribution and habitat:** Occurs in southern South Australia, mostly in the far south-east, in southern Victoria as far east as Wilsons Promontory, and on Flinders Island, Tasmania (Fig. 12). Grows almost exclusively on limestone in forest, woodland and shrubland and heath, predominantly near the coast.

**Notes:** This species is similar to forms of *G. gaudichaudii* subsp. *gaudichaudii* in having congested cymes and extensive glandular cells on the abaxial leaf surface, but can be distinguished by its translucent, glistening, minutely papillose ovaries that are mostly slightly longer than broad, its generally smaller, narrow-elliptic leaves, and its tendency to have fewer flowers per cyme. The relatively long ovaries with a longer dissepiment (and hence longer scar) and minutely papillose surface are the same shape and texture as those of *G. migrans* but are translucent and glistening. A sometimes entirely purple-red corolla and a prominent nectary (evident after corolla-fall) are further floral features it shares with *G. migrans*. *Galium compactum* often occurs in harsh coastal environments and this to some degree contributes to short internodes.

On the Yorke Peninsula a form of *G. compactum* consistently develops stem-angles much broader than the faces and the ovary is relatively broad. A few collections consist of several plants all in their first season of growth, e.g. from Innes National Park (*J.Carrick* 3888 AD). This raises the possibility that the species behaves as an annual in this region; however, it is more likely that they are perennials that have germinated en masse following a disturbance.

**Hybrids:** The following collections appear to be hybrids: **1.** Lower Glenelg River, far south-western Victoria and far south-eastern South Australia (e.g. *R.J.Bates* 41316 AD): *G. compactum* × *G. australe*. **2.** Warrain Parish, south-western Victoria (*J.H.Willis* MEL); Donovan's landing, far south-eastern South Australia (*B.Copley* 2856 AD; *R.J.Bates* 35922 AD): *G. compactum* × *G. curvihirtum*. **3.** Waterloo Bay (*P.C.Heyligers* 80117 AD, CANB); Lincoln National Park (*J.D.Briggs* 1218 CANB), both South Australia: *G. compactum* × *G. leptogonium*.

### 17. *Galium gaudichaudii* DC., *Prodr.* 4: 607 (1830)

*Galium umbrosum* var. *gaudichaudii* (DC.) Maiden & Betche, in J.H.Maiden & E.Betche, *Census New South Wales Pl.*: 188 (1916).

**Type:** NEW SOUTH WALES. Locality unknown [given as Port Jackson; probably between Blue Mountains and Bathurst], *C.Gaudichaud-Beaupré*; holotype: G; ?iso: E n.v., K n.v., image MEL.

**Herbs,** sparsely to densely indumented with hairs to 0.7 mm long or scabrosities; rootstock sometimes becoming stout, sometimes rhizomatous. **Stems** to c. 1 mm diam., with angles slender to moderately broadened; whorls 4-partite, with stipules 2/3 to subequal to leaf length below inflorescences, decreasing upwards to be finally 1/3–2/3 of leaf length or absent. **Leaves** narrow-lanceolate, narrow-oblong, narrow-elliptic or linear-elliptic, sometimes much distorted on drying, 1–15 mm long, 0.5–2 mm occasionally to 3 mm wide, with l:w ratio 2–15, with petiole-like portion hardly evident or up to 1.5 mm long, drying pale or dark; margin recurved to revolute; apex obtuse to acute, often with a small terminal hair or 2; adaxial surface with midrib distinct or not; abaxial surface: midrib indistinct or distinct proximally, distal glandular cell patch moderate to large, proximal cells often evident, sometimes coalescing and extensive. **Inflorescences** extended; cymes 1–12-flowered, not or hardly exceeding whorl or the lowermost one or two markedly exceeding whorl; primary peduncle 0.5–30 mm long, intermediate and ultimate peduncles 0.2–3 mm long, generally inserted distally, mostly glabrous; bracts generally markedly longer than peduncle, developed at all or most nodes. **Flowers:** corolla 1.2–3.8 mm diam., with lobes 0.5–1.8 mm long, sometimes short-apiculate, greenish-cream or cream, sometimes

## Key to subspecies

- |  |  |
|--|--|
| 1 Corolla-lobes 0.8–1.8 mm long, clearly longer than ovary (before post-fertilisation enlargement) ..... | <b>17a.</b> subsp. <i>gaudichaudii</i> |
| <b>1:</b> Corolla-lobes 0.5–0.8 mm long, not or hardly longer than ovary .....                           | <b>17b.</b> subsp. <i>parviflorum</i>  |

tinged or entirely purplish-red abaxially, usually glabrous; ovary circular to slightly oblate in face view, 0.3–0.7 mm long, glabrous. *Fruit*: fruit-set percentage variable; developing fruit dull to lustrous, smooth, areolate or sub-papillose; mericarps reniform, 1.0–1.4 mm long, 0.6–0.8 mm wide, dark brown or reddish-brown, reticulately rugose; dissepiment scar 0.3–0.5 mm long.

*Flowers* spring.

**Notes:** A widespread and variable species. Much of the variation in laxness, hairiness, leaf texture and orientation, internode length and petal pigmentation are thought to be at least partly environmental. Variation in flower and fruit size and shape are more likely largely genetic, and there may be some genetic basis for variation in cyme laxness. For discrimination of subspecies, careful inspection of pressed specimens is necessary to identify those flowers with both full-sized corollas and with ovaries not yet enlarged due to fertilisation.

*Hybrids*: Collections from several localities, mostly in northern New South Wales, appear to be hybrids between *G. gaudichaudii* and *G. binifolium* subsp. *binifolium*. See under the latter for details.

### **17a. *Galium gaudichaudii* DC. subsp. *gaudichaudii***

*G. axiflorum* f. *minor* Miq., *Ned. Kruidk. Arch.* 4: 113 (1856). Type: SOUTH AUSTRALIA. Mt Lofty Ranges, *F.Mueller*; holo: U; iso: MEL.

*G. axiflorum* f. *laxe-ramosum* Miq., *Ned. Kruidk. Arch.* 4: 113 (1856). Type: SOUTH AUSTRALIA. Barossa Ranges, *F.Mueller*; holo: U; iso: MEL.

*Rootstock* to c. 5 mm diam. *Stem-angles* slightly to moderately broadened (1/5–1/2 of width of faces). *Leaves* (in inflorescences) often angled upwards, slightly elliptic or more often c. narrow-oblong to linear, with length:width ratio c. 3–10; tapering into base slight, with base mostly > 1/2 of leaf-width; apex strongly acute to obtuse, often with a terminal hair, mostly light

green above, drying pale to medium yellow-green and more or less concolorous. *Inflorescences* with cymes congested to lax, with longest ultimate or penultimate peduncles in an inflorescence 0.5–3(–5) mm long. *Flowers*: corolla 1.8–3.8 mm diam., with lobes 0.8–1.8 mm long, greenish-cream to pale yellowish adaxially, similar abaxially or sometimes tinged purple-red distally; ovary 0.3–0.5 mm long, often unfertilised but persisting on plant.

*Flowers* spring to early summer.

**Selected specimens:** **SOUTH AUSTRALIA.** Mt Bryan, *R.J.Bates 34605*, 22.x.1993 (AD); Melrose, Mt Remarkable National Park, *K.Czornij 670*, 10.x.1973 (AD); Port Germein Gorge, *R.J.Bates 29069*, 27.ix.1992(AD); Onkaparinga Recreation Park, *R.J.Bates 26596*, 1991 (AD); Mitcham, Adelaide, *A.Distasio 45*, 25.x.1992 (AD); Menglers Hill Scrub, c. 8 km E of Tanunda, *D.N.Kraehenbuehl 2858*, 29.x.1978 (AD); Mount Lofty Botanic Garden, c. 15 km SE of Adelaide, *J.R.Wheeler 104*, 2.xi.1966 (AD); Hindmarsh Falls, 17 km N of Victor Harbour, *P.C.Jobson 2797*, 30.x.1993 (MEL); Frankton Hills, *R.J.Bates 41552*, 10.xi.1995 (AD); Malinong, c. 45 km SE of Murray Bridge, *M.C.R.Sharrad 194*, 4.x.1959 (AD); Karatta, Kangaroo Island, *R.J.Bates 30459*, 21.xii.1992 (AD). **NEW SOUTH WALES.** Green Gully, Glen Davis, c. 40 km N of Lithgow, *E.F.Constable 7193*, 27.x.1966 (NSW); Old Frogmore Cemetery, *W.Semple*, 12.x.2000 (NSW); 1 km N of confluence of Snowy River and Paupong Creek, *S.J.Forbes 678*, 1.x.1981 (MEL); Cocopara Nature Reserve, c. 225 km NW of Albury, *J.H.Willis*, 1.x.1969 (MEL); Travelling Stock reserve, 8 km S of Rye Park, *N.Taws 257*, 12.xi.1993 (CANB); Snowy Mountains Highway near Rhine Falls, 18 km from Cooma, *T.B.Muir 2422*, 26.x.1961 (MEL); Monument Hill, Albury, *E.J.McBarron 3748 bis*, 12.x.1949 (NSW). **AUSTRALIAN CAPITAL TERRITORY.** C. 2 km W of Kowen Forestry Settlement, *B.J.Lepschi 616*, 3.xi.1991 (CANB); Murrumbidgee River downstream from Kambah Pool, *F.Davies 57 & I.R.Telford*, 20.ix.1983 (CANB, MEL). **VICTORIA.** Dookie College Timber Reserve, *J.E.Strudwick 854*, 14.x.1992 (CANB, MEL); Jeparit, *W.R.A.Baker*, 15.x.1912 (MEL); Pendyk Pendyk State forest, 44 km NE of Coleraine PO, *A.C.Beaglehole 50372*, 4.xi.1975 (MEL, NSW); N of junction of Black Range Rd & Rocklands Track, Black Range, *A.C.Beaglehole 30014*, 11.xii.1968 (MEL); Big Billy Bore, 33 km S of Murrayville on Nhill Rd, Big Desert, *M.G.Corrick 6743*, *P.S.Short & B.A.Fuhrer*, 3.x.1980 (MEL); Daisy Hill Forest Block, 2 km S of Maryborough

PO, *A.C.Beaglehole* 55225, 15.x.1976 (MEL); Mitre Rock near Mt Arapiles, c. 15 km WSW of Horsham, *A.J.Hicks*, 22.ix.1960 (AD); c. 3 km SSW of Mt Big Ben, c. 25 km NE of Myrtleford, *A.C.Beaglehole* 43529, 20.xi.1973 (MEL); Mt Erip, 32 km SW of Ballarat PO, *A.C.Beaglehole* 61173, 27.x.1978 (MEL); South Golton Gorge, Mt Zero Rd, W of Mt Stapleton, *B.M.Overton* 1042, 18.x.1988 (MEL); Wail State Forest, *A.C.Beaglehole* 86023, 15.x.1986 (MEL); Baranduda Regional Park, 21 km S from Wodonga, *N.T.Rossiter* 96 & *A.D.J.Plesse*, 25.xi.1987 (MEL); Cheltenham, *A.Morrison*, 1.xi.1894 (AD).

**Distribution and habitat:** Occurs in south-eastern South Australia, Victoria, south-eastern to central-eastern New South Wales, and the Australian Capital Territory (Fig. 12). Grows in a range of soil types, often in shallower soils or from rock crevices, in woodland and forest.

**Notes:** Forms in more exposed sites and on poorer soils are generally more compact, becoming many-stemmed and developing a thick rootstock. Their leaves are usually sub-erect and light green and become pale and much contorted on pressing. Cymes of these forms are generally congested. In central-eastern New South Wales, specimens tend to have smaller flowers than those collected further south, making them difficult to discriminate on the basis of corolla-lobe length from subsp. *parviflorum*. See *G. gaudichaudii* subsp. *parviflorum* for a discussion of differences between subspecies.

**Hybrids:** The following collections appear to be hybrids: **1.** Mt Lofty Ranges, South Australia (*T.J.Smith* 877 AD): *G. gaudichaudii* subsp. *gaudichaudii* × *Galium migrans* subsp. *migrans*. **2.** Black Range, south-western Victoria (*A.C.Beaglehole* 30044 MEL); Golton Gorge northern Grampians, south-western Victoria (*A.C.Beaglehole* 30096 AD, MEL): *G. gaudichaudii* subsp. *gaudichaudii* × *G. curvihirtum*. (See under *G. curvihirtum*).

### 17b. *Galium gaudichaudii* subsp. *parviflorum*

I.Thomps., *subsp. nov.*

*A subspecies typica corolla parviore, foliis latoribus differt.*

**Type: TASMANIA.** Virginstow Forest, Smith & Others Rd, *A.M.Buchanan* 4285, 12 November 1984; holo: HO.

?*G. axiflorum* f. *procerum* Miq., *Ned. Kruidk. Arch.* 4: 113 (1856), as *procera*. Type: Tasmania: locality

unknown, *C.Stuart*; holo: U *n.v.*, image MEL; iso: ?MEL (parts of sheet 17717 and 17740).

?*G. gaudichaudii* var. *typicum* Domin, *Biblioth. Bot.* 89: 1184 (1929), *nom. inval.* [material cited by Domin probably referable to this subspecies based on localities]

**Rootstock** to c. 2 mm diam. **Stem-angles** mostly moderately broadened (1/3 of width to c. equal to width of faces). **Leaves** (in inflorescences) generally spreading to slightly pendent, sometimes angled upwards, somewhat elliptic, with length:width ratio c. 2–6; tapering into base moderate, with base mostly < 1/2 leaf-width; apex mostly subacute to rounded, with terminal hair variably present, mid to dark green above, generally drying mid to dark olive-green and slightly discoloured. **Inflorescences** with cymes congested, with longest ultimate or penultimate peduncle in an inflorescence 0.5–1.5(–2) mm long. **Flowers:** corolla 1.0–1.8 mm diam., with lobes 0.5–0.8 mm long, greenish-cream adaxially, commonly purple-red abaxially; ovary 0.4–0.7 mm long, c. equal to corolla-lobes as flowers open, with all or most being fertilised.

**Flowers** mid-spring to summer.

**Selected specimens: SOUTH AUSTRALIA.** Wilpena Pound, c. 40 km NNE of Hawker, *E.H.Ising*, Oct. 1924 (AD); Montefiore Hill, Adelaide Plains, *T.J.Smith* 937, 23.x.1967 & *T.J.Smith* 1015, 17.xi.1967 (both AD); Torrens Gorge, *A.G.Spooner* 491, 22.x.1969 (AD). **QUEENSLAND.** Granite Hill just W of Glen Aplin, *S.L.Everist* & *L.J.Webb* 1371, 23.xi.1946 (BRI, CANB); Mt Bullaganang, c. 40 km NE of Texas, *D.A.Halford* Q8033, 6.xi.2003 (BRI, MEL). **NEW SOUTH WALES.** C. 8 km NW of Armidale, *G.L.Davis*, 22.xii.1940 (NSW); 2.4 km along Queens Pinch Rd, S of Mudgee, *A.R.Bean* 17125, 18.xii.2000 (BRI); N of Wellington Rd, c. 18 km NE of Tenterfield, *A.R.Bean* 21323, 9.xii.2003 (BRI); Bombala River, c. 17 km NE of Bibbenluke, N of confluence with Back Creek, *I.Crawford* 773, 22.xii.1987 (CANB). **VICTORIA.** Trapyard Hill track, c. 2.2 km SSW of Trapyard Hill, *D.E.Albrecht* 3201 & *D.G.Cameron*, 11.i.1987 (MEL); Buldah Forest Block, 1.7 km ENE of Buldah, *G.W.Carr* 10082, 23.x.1984 (MEL); Deddick Trail, Snowy River National Park, 16 km WSW of Tubbut PO, *A.C.Beaglehole* 67447, 20.i.1980 (MEL, NSW); Mt Dawson, *D.E.Albrecht* 359, 22.iii.1984 (MEL); Mt Wheeler, c. 10 km E of Wulgulmerang, *A.E.Orchard* 2675, 5.xii.1970 (AD); Wilsons Promontory, *A.C.Beaglehole* 75353 & *J.Eichler*, 10.xi.1983 (MEL). **TASMANIA.** Wedgetail Peak, *A.Moscal* 3960, 11.xi.1983 (HO); East Beach, Low Head, *W.M.Curtis*, 7.xii.1955 (HO); Valley Rivulet N of Broadmarsh, *P.Collier* 3493, 15.x.1988 (HO); NW slopes of Cape Bernier, *M.J.Brown* 579, 3.xi.1979 (HO);

Tunbridge Tier Rd, *A.Moscal* 9039, 15.xii.1984 (HO); Kempton, N of Quoin Mountain, *M.J.Brown* 69, 23.xii.1980 (HO); Mt Direction, *R.A.Black*, 19.x.1921 (MEL); Clarkes Island, *J.Whinray*, 26.xii.1966 (MEL); East Tamar area, *M.Wapstra*, 1.xi.2006 (MEL); 3 km N of Barnes Bay, North Bruny Island, *P.Collier* 4933, 11.xi.1990 (HO).

**Distribution and habitat:** Occurs in eastern South Australia, far south-eastern Queensland, eastern New South Wales, eastern Victoria, and eastern Tasmania (Fig. 12). Grows in forest and woodland.

**Notes:** Compared to the type subspecies, subsp. *parviflorum* has flowers with corolla-lobes that are shorter and more often intensely pigmented purple-red abaxially. Stem-angles tend to be broader and leaves are generally broader, more elliptic, and with a lower length to width ratio, and tend to dry more olive-coloured. It is likely to be an inbreeding taxon based on the high fruit-set percentage. Nevertheless, the two subspecies may be difficult to distinguish unless good flowering material is available. It is important to examine flowers just before or at time of opening for comparing ovary and corolla-lobe lengths because fertilised ovaries soon enlarge. *Galium gaudichaudii* subsp. *parviflorum* may also be difficult to distinguish from the small-flowered and self-fertilising *G. binifolium* subsp. *conforme* (see notes under that taxon for differences).

**Etymology:** The subspecific epithet refers to the flower size compared to the type subspecies (from *L. parvus*, small and *flos*, flower).

### 18. *Galium curvihirtum* Ehrend. & McGill., *Telopea* 2: 373 (1981).

**Type:** VICTORIA. Mt Arapiles, c. 20 miles [32 km] east of Horsham, *H.I.Aston* 1075, 3 October 1963; holo: MEL.

**Herbs,** sparsely to densely indumented with slender to slightly coarse hairs to 0.5 mm long or scabrosities; sometimes rhizomatous. **Stems** to c. 1 mm diam., with angles only slightly broadened; whorls 4-partite, with stipules 2/3 to subequal to leaf length below inflorescences, decreasing upwards to be finally 1/3–2/3 of leaf length or absent. **Leaves** lanceolate, narrow-oblong or linear-elliptic, 2–10 mm long, to c. 3 mm wide, 1–4 mm wide below inflorescences, with l: w ratio mostly 3–10, with petiole-like portion 0.5–1.5 mm long, drying pale; margin recurved to revolute;

apex obtuse to acute, mostly without a terminal hair; adaxial surface with midrib distinct; abaxial surface with midrib distinct proximally, glabrous or with few to several hairs, distal glandular cell patch small to moderate, proximal cells variably evident. **Inflorescences** extended; cymes 1–12-flowered, with lower cymes often exceeding whorl, reducing to become c. equal to or shorter than whorl upwards; primary peduncle 1–30 mm long; intermediate and ultimate peduncles 1–4 mm long, generally inserted distally, usually strongly so, mostly glabrous; bracts shorter or longer than peduncle, variably present. **Flowers:** corolla 1.5–2.6 mm diam., with lobes 0.7–1.2 mm long, sometimes short-apiculate, greenish-cream or cream, occasionally purplish-red abaxially, glabrous; ovary circular to slightly oblate in face view, 0.4–0.6 mm long, moderately to completely covered by hairs; hairs slender, 0.1–0.3 mm long, sub-appressed but becoming erect, antrorsely curved to weakly hooked so extending only 0.1–0.2 mm beyond surface. **Fruit:** fruit-set percentage variable; developing fruit smooth; mericarps reniform or hemispherical (1.1–)1.3–1.8 mm long, 0.7–1.2 mm wide; light to dark brown, reticulately rugose; dissepiment scar c. 0.5–0.8 mm long. (Fig. 4j.)

**Flowers** spring to early summer.

**Selected specimens:** SOUTH AUSTRALIA. Padthaway, c. 40 km SSW of Bordertown, *P.Canty*, 5.xi.1981 (AD); McIntyre Swamps, *B.Bates* 3561, 26.xii.1983 (AD); c. 3 km S of Mt Burr township, c. 35 km NW of Mt Gambier, *I.B.Wilson* 616, 25.x.1966 (AD, CANB); Honan's Scrub, *R.J.Bates* 26374, Nov. 1991 (AD); Deadmans Swamp, Comaum Forest reserve, *C.Dickson* 199, 11.x.1984 (AD); Penola Forest Reserve, c. 15 km NE of Penola, *J.Z.Weber* 7591, 16.x.1982 (AD). NEW SOUTH WALES. Intersection of Tubrabucca Rd and Omdale brook Rd, Stewarts Brook State Forest, *S.Griffith* 6061.3, 2.iii.1993 (NSW). VICTORIA. Buangor Forest Park, 27 km E of Ararat PO, *A.C.Beauglehole* 61508, 10.xi.1978 (MEL, NSW n.v.); Mt Abrupt, *H.B.Williamson*, Oct. 1893 (MEL); Mitre Rock, *I.R.Thompson* 981, 13.x.2007 (AD, BRI, CANB, HO, MEL); Jilpanger Reference Area, *A.C.Beauglehole* 75595, 2.xii.1983 (MEL); Redmans track, c. 3 km W of intersection with Long Gully Rd, c. 5 km direct SSW of Pomonal, *I.R.Thompson* 1020, 18.xii.2007 (AD, BRI, CANB, HO, MEL, NSW); Mt William Rd, *A.C.Beauglehole* 22215, 14.xi.1966 (MEL, NSW n.v.); Dundas Range, S end, N of Gap Road, 25 km NE of Coleraine PO, *A.C.Beauglehole* 50355, 3.xi.1975 (MEL, NSW); Road to Swan Lake, Mt Richmond area, W of Portland, *I.R.Thompson* 928, 26.xi.2006 (AD, BRI, CANB, HO, MEL); Coonewirrecoo Block, c. 18 km SE of Edenhope



PO, *A.C.Beauglehole* 49759, 22.iii.1975 (MEL; NSW); E side of Oxbow Lake, Nelson, *N.H.Scarlett* 86-483, 19.xii.1986 (AD).

**Distribution and habitat:** Occurs in south-western Victoria and far south-eastern South Australia (Fig. 12). Collections from north-eastern New South Wales and eastern Victoria are thought to be introductions. Grows predominantly in sandy soils in forest and woodland.

**Notes:** A common feature of *G. curvihirtum* is a tendency towards monochasial branching, progressive development of flowers, and a strongly distal peduncular insertion. It is similar to *G. migrans* in this respect. Some specimens from South Australia, e.g. *Bates* 3561 AD, have relatively small corollas and the ovary is slightly longer than broad. A moderate proportion of fertilised flowers in this species have only one carpel fertilised, resulting in fruit with a lop-sided appearance (fig. 4j). Mericarps are usually significantly larger than in *G. gaudichaudii*; however, more records are needed to determine how consistent this character is.

*Galium curvihirtum* is most similar to *G. gaudichaudii*. It differs from this species in having hairy ovaries and fruit, generally larger fruit, and generally broader and/or more elliptic leaves below inflorescences. Compared to *G. gaudichaudii* subsp. *gaudichaudii* the subspecies that slightly overlaps its distribution, *G. curvihirtum* has smaller corollas and its leaves are more elliptic, more tapered basally, generally lack a terminal hair, and have less glandular cell development.

**Hybrids:** The following collections appear to be hybrids: **1.** Warrain Parish, south-western Victoria (*J.H.Willis* MEL); Donovan's landing, far south-eastern South Australia (*B.Copley* 2856 AD; *R.J.Bates* 35922 AD): *G. curvihirtum* × *G. compactum*. **2.** Black Range, south-western Victoria (*A.C.Beauglehole* 30044 MEL); Golton Gorge northern Grampians, south-western Victoria (*A.C.Beauglehole* 30096 MEL): *G. curvihirtum* × *G. gaudichaudii* subsp. *gaudichaudii*. In the former locality pieces have either glabrous ovaries or hairs that are shorter than is typical for *G. curvihirtum*. In the latter, ovaries are all glabrous. Corolla diameter is within the range for *G. curvihirtum* and is too small for *G. gaudichaudii* subsp. *gaudichaudii*.

## 19. *Galium microlobum* I.Thomps., *sp. nov.*

*A. G. gaudichaudii* DC. *plantis annuis, corolla parviore, mericarpiis parvioribus differt.*

**Type: SOUTH AUSTRALIA.** Near Loch Ness Well, Gammon Ranges, *R.J.Bates* 34345, 29 September 1993; holo: AD; iso: MEL.

**Herbs,** usually growing as annuals, generally sparsely indumented with hairs to 0.6 mm long, or scabrosities; rhizomes not seen. **Stems** to c. 0.5 mm diam., with angles slender to slightly broadened; whorls 4-partite, with stipules similar to leaf length below inflorescences, decreasing upwards to be finally 1/3–2/3 of leaf length. **Leaves** oblanceolate, narrow-elliptic, narrow-lanceolate or narrow-oblong-elliptic, 1–10 mm long, 0.5–2 mm wide, with l:w ratio mostly 2.5–8, with petiole-like portion to c. 1 mm long; margin recurved to revolute; apex acute, sometimes with a terminal hair or 2; adaxial surface with midrib variably distinct; abaxial surface: midrib variably distinct, distal glandular cell patch small to moderate, proximal cells usually evident. **Inflorescences** extended; cymes 1–3-flowered, shorter than whorl; primary peduncle to 1.5 mm long, generally glabrous; ultimate peduncles to 1 mm long, inserted variably; bracts variably present, much longer than peduncles. **Flowers:** corolla 0.8–1.0 mm diam., with lobes 0.3–0.4 mm long, not apiculate, greenish-cream adaxially and usually intensely purplish-red abaxially, glabrous; ovary c. circular in face view, c. 0.4 mm long, glabrous. **Fruit:** fruit-set percentage high; developing fruit dull or sub-lustrous, smooth to areolate; mericarps reniform, 0.8–1.0 mm long, 0.4–0.6 mm wide, dark-brown or more often dark purple, smooth or obscurely reticulately rugose; dissepiment scar 0.3–0.4 mm long. (Fig. 4d)

**Flowers** late winter to spring.

**Selected specimens: SOUTH AUSTRALIA.** Mt Wallaby, Kondoolka, Gawler Ras, *R.J.Bates* 57455A, 20.ix.2000 (AD); South-eastern Hills, Winninowie Ras, *A.G.Spooner* 8960, 8.x.1983 (AD); 7.6 km SW of "new" Paney homestead on S side of Mt Allalone, *R.J.Chinnock* 7715, 28.ix.1987 (AD, MEL); 15 km N of Plumbago Homestead, *R.J.Chinnock* 1289, 30.ix.1973 (AD); outcrop WNW of 4 mile creek, northern Flinders Ras, *F.Mollenmans* 1090, 6.x.1981 (AD); 1 km S of gorge, Telowie Gorge Conservation Park, *R.J.Bates* 63503, 4.ix.2004 (AD); Near Yorke Peninsula, *Tepper*, no date (MEL). **NEW SOUTH WALES.** Old Mootwingee Gorge, Mootwingee National Park, 113 km NE of Broken Hill, *I.Crawford* 1083, 24.x.1988 (BRI, CANB, NSW); N slopes of Mt Binya, Cocopara Ras, c. 25 km ENE of Griffith, *M.D.Crisp* 1469, 1.ix.1975 (AD, CANB, NSW); Tarella, *W.Bauerlen*, Aug. 1887 (MEL); Girilambone, *E.Betche*, 6.x.1886 (MEL, NSW); N of middle bore, "Iona", c. 29 km S of Louth, *C.W.E.Moore* 8161, 20.ix.1982 (CANB); Yathong NR via Mt

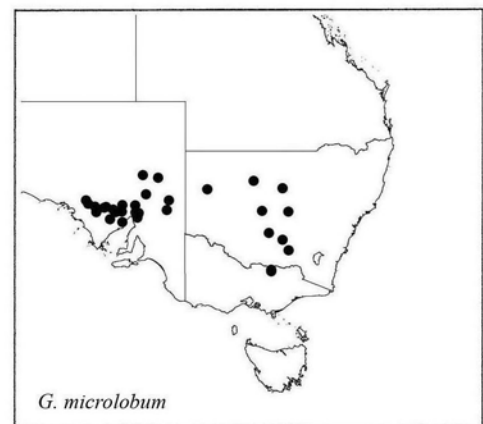
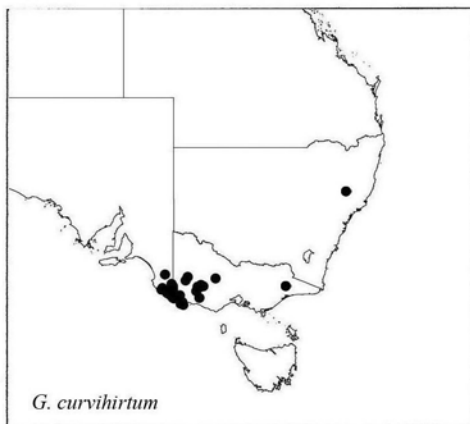
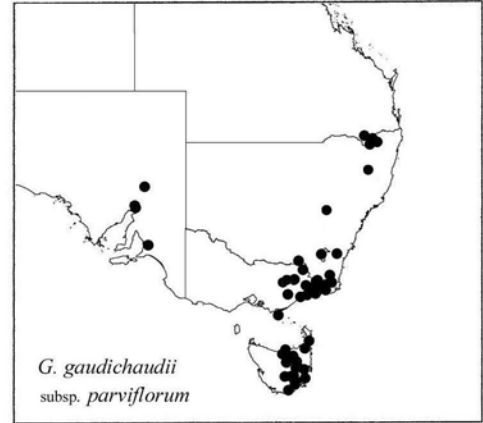
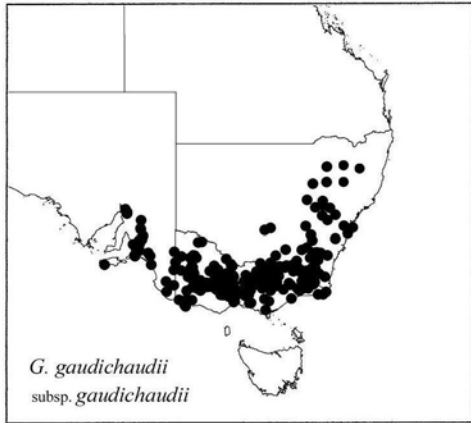
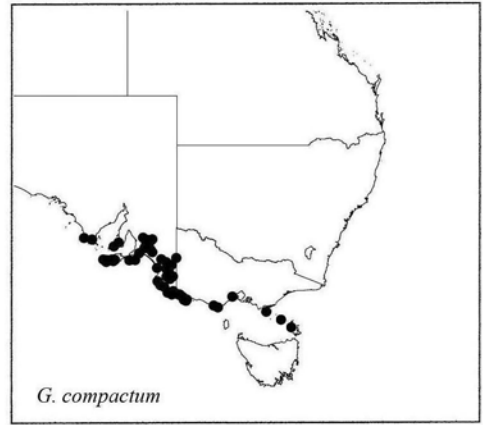
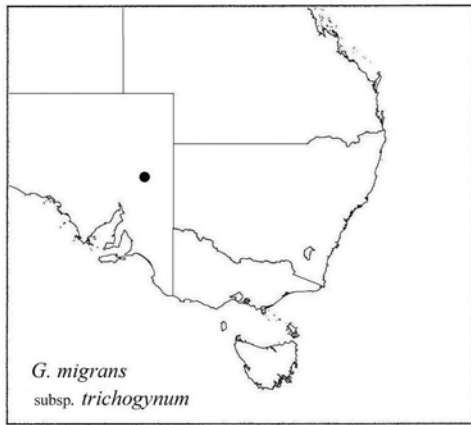

**Figure 12.** Distributions of *Galium migrans* subsp. *trichogynum*, *G. compactum*, *G. gaudichaudii* subsp. *gaudichaudii*, *G. gaudichaudii* subsp. *parviflorum*, *G. curvihirtum*, *G. microlobum*.

Key to naturalised *Galium* species

- 1 Mericarps cylindrical; corolla-lobes < 1/2 length of ovary; inflorescences with few-flowered cymes arising from primary axis and not subtended by a leaf ..... **2. *G. murale***
- 1: Mericarps somewhat ellipsoid, globose or obovoid; corolla-lobes > 1/2 length of ovary; inflorescence not of few-flowered cymes arising from primary axis, or if so then cymes subtended by a leaf ..... **2**
- 2 Corolla-lobes > 1 mm long, longer than the ovary; stem-angles and leaf-margin lacking robust retrorsely curved hairs .... **3**
- 2: Corolla-lobes ≤ 1 mm long and/or shorter than the ovary; if ever more than 1 mm long then stem-angles and leaf-margin bearing a line of robust retrorsely curved hairs ..... **5**
- 3 Leaves obtuse to rounded; petals white ..... **1. *G. palustre***
- 3: Leaves acute to acuminate with a hyaline apiculum; petals golden-yellow or white ..... **4**
- 4 Corolla white; leaves narrow-elliptic or oblanceolate ..... **3. *G. album***
- 4: Corolla golden-yellow; leaves narrow-linear ..... **4. *G. verum***
- 5 Mericarps < 1 mm long; margin of leaves with antrorse-appressed hairs; panicles arising from stems, with primary axis 0.1–0.2 mm diam., commonly bearing more than 10 flowers ..... **5. *G. divaricatum***
- 5: Mericarps > 1 mm long; margin of leaves with robust retrorsely curved spine-like hairs; cymes arising from stems, with primary peduncle 0.4–0.6 mm diam., bearing 1–6(–10) flowers ..... **6**
- 6 Ovaries and fruit tuberculate, with hairs absent or minute, not hooked; upper surface of leaves with a line of antrorse hairs in distal third near the margin but otherwise glabrous ..... **8. *G. tricornutum***
- 6: Ovaries and fruit with tubercle-based hairs > 0.3 mm long, apically hooked; upper surface of leaves glabrous or if hairy then hairs not distributed as above ..... **7**
- 7 Corolla-lobes c. 0.8 mm long, cream to white; cyme-bracts commonly 2 or more at primary node; mericarps 2–4 mm long; whorls usually maximally 7- or 8-partite ..... **6. *G. aparine***
- 7: Corolla-lobes c. 0.5 mm long, greenish-cream; cyme-bracts commonly 0 or 1 at primary node; mericarps 1.2–2.3 mm long; whorls usually maximally 6-partite ..... **7. *G. spurium***

Hope, Merrimerriva Ra, *Slee SLE310 & Holgate*, 4.ix.1982 (CANB).

**VICTORIA.** Mt Hope, c. 38 km SE of Kerang, *A.C. Beaglehole 55626 & J.N. McFarlane*, 24.iv.1977 (MEL, NSW); Wallaby Hill Education Area, *A.C. Beaglehole 55626 & W.S. Wilson*, 24.ix.1985 (MEL); Warby Ranges State Park, *A.C. Beaglehole 80798*, 23.ix.1985 (MEL).

**Distribution and habitat:** Occurs in eastern South Australia, central to western New South Wales and northern Victoria (Fig. 12). Grows in rocky outcrops of various geology including granites and sandstones in arid to semiarid environments in woodland and grassland. Often associated with *Triodia* sp.

**Notes:** This subspecies has the smallest flowers of any Australian species and its mericarps are equal to the smallest (those of *G. leiocarpum* are of similar size). It is similar to *G. compactum* and forms of *G. gaudichaudii* in terms of the congested cymes not exceeding the leaves.

**Etymology:** The epithet refers to the corolla-lobes (from Gk: *micro-*, small and *lobos*, lobe).

## Unplaced names

*Galium australe* var. *typicum* Hochr., *Candollea* 5: 285 (1934), *nom. inval.*

The author identified his specimen collected from Jenolan Caves, New South Wales as the typical variety of *G. australe* as distinct from *G. australe* var. *pilosohispidum* and invalidly assigned it the epithet *typicum*. *Galium australe* is unlikely to occur at this locality and it probable that Hochreutiner misidentified *Galium spurium*, an introduced species which superficially resembles *G. australe* and which has been collected a few times from this locality. I have not seen the specimen (*Hochreutiner 3079*).

*Galium gaudichaudii* var. *latifolia* Miq., *Ned. Kruidk. Arch.* 4: 113 (1856), *nomen nudum*.

*Galium subalatum* F.Muell. ex Miq., *Ned. Kruidk. Arch.* 4: 113 (1856), *nomen nudum*.

These invalid names were placed in synonymy by McGillivray (1983), the first under *G. ciliare* and the second under *G. australe*. As both species were split

into multiple taxa in this paper, it is unclear to which taxon they should be referred.

## 2b. Species of *Galium* naturalised in Australia

No particular affinity is apparent between the eight introduced species described below and the Australian and New Zealand species of *Galium*. Seven of the eight introduced species have leaves with a distinct hyaline apiculum, a feature not evident in Australian *Galium*, and these species were all placed in *Galium* sect. *Galium* in a molecular phylogenetic study presented by Natali *et al.* (1996). *Galium palustre* lacks this feature and was placed by Natali *et al.* in *Asperula* sect. *Glabella* along with *Asperula tinctoria* and *A. laevigata*. All eight introduced species have whorls maximally 6 or more-partite, in contrast to the native species where 4 is usually the maximal number (rarely 5 or 6 in occasional specimens of *G. liratium* and *G. bulliformis*).

Among the seven species in sect. *Galium* there is a group of three annuals, namely *G. aparine*, *G. spurium* and *G. tricornutum*, characterised by robust tubercle-based and retrorsely curved hairs on stems and leaf margins, tubercle-based and apically hooked hairs on ovaries and fruit (hair portion lost in *G. tricornutum*), inflorescences of few-flowered cymes predominantly arising directly from stems, lateral flowers not reaching to medial flowers, and mericarps with relatively short dissepiment scars. Three further species, *Galium album*, *G. divaricatum* and *G. murale* have in common the presence of strongly antrorse hairs on leaf-margins, but otherwise have numerous differences.

Excellent illustrations of some of these species are presented in Jafri (1979).

### 1. *Galium palustre* L., *Sp. Pl.* 1: 105 (1753)

**Type:** not designated [protologue: "Habitat in Europae rivulis limosis"].

**Annuals** to c. 50 cm high. **Stems** c. 1 mm diam.; angles slender, slightly raised, glabrous or with few to scattered slightly retrorse scabrosities; whorls 4–6-partite, often reducing in number upwards; stipules becoming conspicuously smaller than leaves upwards through inflorescences. **Leaves** narrow-spathulate, or oblanceolate to narrow-oblanceolate, 7–20 mm long, 1–4 mm wide, with l:w ratio 3–8, thin; margin flat recurved

or revolute, usually with a few antrorse scabrosities; apex obtuse to rounded, without a hyaline apiculum; a minute terminal hair occasionally present; upper surface dull, with midrib weakly defined, glabrous except for minute antrorse scabrosities sub-marginally, with an obovate pale patch at apex; lower surface glabrous or with a few to numerous spreading to slightly retrorse hairs c. 0.1 mm long along midrib. **Inflorescences** a panicle, with elongate many-flowered partial inflorescences, with arrangement becoming cymose; cymes mostly 5–15-flowered; primary peduncle 10–20 mm long; bracts usually 1 or 2 at primary node, variably present at secondary nodes, much shorter than the peduncle they subtend; penultimate and ultimate peduncles 2–8 mm long, 0.1–0.2 mm diam., inserted commonly in middle-third, not or hardly overtopping. **Flowers:** corolla 2–4.5 mm diam., with lobes 1–2.2 mm long, acute, snow white throughout or tinged pink; ovary slightly oblate in outline, slightly broader than long, 0.3–0.5 mm long, glabrous, smooth. **Peduncles** of fruit straight, patent; mericarps globose, 0.8–1.3 mm long and wide, blackish brown or purplish-brown, slightly rugose; dissepiment scar mildly recessed, c. 0.2 mm long. **Marsh Bedstraw.**

**Flowers** summer–early autumn.

**Selected specimens: SOUTH AUSTRALIA.** Willowburn, 4 km E of Mt Compass, *D.E.Murfet 1749a & R.L.Taplin*, 12.iii.1993 (AD, MEL). **NEW SOUTH WALES.** Wingecarribee Swamp, c. 5 km due WNW of Robertson, *P.G.Kodala 260 & T.A.James*, 9.i.1993 (AD, NSW); Little Llangothlin Lake Nature Reserve, NNE of Guyra, *A.R.Bean 8286*, 29.i.1995 (AD, BRI, MEL, NSW). **VICTORIA.** Swamp beside Surry River, W side of Fish Holes Rd, Cobboboonee State Forest, Gorae West, *I.R.Thompson 1024*, 18.xii.2007 (MEL). **TASMANIA.** Shantys Lagoon, *R.Glazik*, 22.iii.2000 (HO); spillway of pump pond, Tarraleah, *A.North*, 6.iii.1996 (HO); bank of Georges River, *A.M.Buchanan 11772*, 16.iv.1990 (HO, MEL, NSW).

**Distribution and habitat:** Occurs predominantly in central and eastern Tasmania, but with mainland records from the Northern Tablelands and Central Tablelands of New South Wales, from the Fleurieu Peninsula in south-eastern South Australia, and from Gorae West near Portland in far south-western Victoria (Fig. 13). Native to Europe. Grows in or near swamps and lakes, sometimes in forest.

**Notes:** Several fairly recent records at widely separated localities suggest that this species may expand its range considerably in years to come.

**2. *Galium murale* (L.) All., *Fl. Pedem.* 1: 8, t. 77, f. 1 (1785)**

*Sherardia muralis* L., *Sp. Pl.* 1: 103 (1753).

**Type: ITALY.** Herb. Linn. 126.2; lecto: LINN *n.v.*, *fide* A.Natali & D.Jeanmonod in D.Jeanmonod, *Compl. Prodr. Fl. Corse, Rubiaceae* 105 (2000).

*Annuals* to c. 20 cm high, commonly 1–5 cm high. *Stems* 0.3–0.6 mm diam.; angles slender, hardly raised, glabrous or with sparse spreading to slightly retrorse hairs c. 0.1 mm long, or rarely with a moderately dense indumentum of hooked hairs c. 0.3 mm long; whorls variable in number of parts, 4–6-partite below inflorescences reducing to 1–3-partite in inflorescences as cymes replace the leaf and stipule(s) on one side; stipules remaining c. equal to leaves throughout. *Leaves* narrow-oblongate, narrow-elliptic, narrow oblong-elliptic, or spathulate, 2–7(–10) mm long, 0.5–1.5(–2.5) mm wide, with l:w ratio (1.5–)2–6, tapering gradually and moderately basally, thin; margin recurved or revolute, with a line of antrorse to subappressed hairs; hairs plump, not curved apically, not tubercle based; apex acuminate or narrowly acute, with hyaline apiculum to c. 0.3 mm long; terminal hair to c. 0.2 mm long; upper surface dull, with midrib weakly defined, glabrous or usually with few to several hairs along midline and near-marginally; lower surface glabrous or with a few hairs on midrib. *Inflorescences* a raceme of cymes; cymes predominantly 2-flowered, sometimes solitary, less often 3-flowered, rarely to 6-flowered, lax, not subtended by a leaf, equal to or exceeding leaf on opposite side; primary peduncle 1–2 mm long; bracts rarely developed; ultimate peduncles 1–2 mm long, 0.15–0.3 mm diam, inserted basally, proximally or midway, not overtopping. *Flowers*: corolla c. 0.8 mm diam., with lobes c. 0.3 mm long, acute, pale cream or greenish, sometimes tinged pink; ovary broad-oblong in outline, c. 2 times as long as broad, c. 0.8 mm long, rarely glabrous, with hooked hairs 0.2–0.5 mm long at summit and mostly also laterally on one of the two carpels, rarely glabrous except for minute hairs at summit, smooth. *Peduncles* of fruit moderately downcurved; mericarps narrow-cylindrical, often mildly arched, 1.2–1.5 mm long, 0.4–0.5 mm wide, blackish-brown or with a whitish coat, not rugose; dissepiment scar c. 1 mm long. *Small Goosegrass, Small Bedstraw.*

*Flowers* mostly spring.

**Selected specimens: WESTERN AUSTRALIA.** Monks well Gully, Wongan Hills, c. 194 km NE of Perth, *K.F.Kenneally 6875*, 27.ix.1978 (PERTH); 11 km W of Roes Rock, near Twertup Creek (FRNP), *K.Newbey 11029*, 10.x.1985 (PERTH); Thomas River, c. 8 km SSW of Boyatup Hill, c. 100 km E of Esperance, *A.E.Orchard 1388*, 5.x.1968 (AD). **SOUTH AUSTRALIA.** Butchers Gap Conservation Park, 6 km S of Kingston, *P.Gibbons 568*, 30.x.1986 (AD, HO); 5.0 km E of Black Hill (Marne), Murray region, *A.G.Spooner 10439*, 16.x.1986 (AD); Finniss Conservation Park, Southern Lofty, *A.G.Spooner 9077*, 20.xi.1983 (AD); Innes National Park, Yorke Peninsula, *E.N.S.Jackson 2550*, 6.x.1974 (AD); Coorong, Younghusband Peninsula, *C.R.Alcock 5032*, 5.x.1975 (AD); S slope of Mt Dutton, Marble Range, *J.Z.Weber 6058*, 30.ix.1979 (AD). **NEW SOUTH WALES.** Jerrabomberra Lookout near Queanbeyan, *M.Gray*, May 1960 (AD, CANB); Bungonia Lookdown, Bungonia State Recreation Reserve, *E.M.Canning 4381*, 13.ix.1978 (CANB). **AUSTRALIAN CAPITAL TERRITORY.** C. 2 km WNW of Kowen Forestry Settlement, *B.J.Lepschi 612*, 3.xi.1991 (CANB, MEL); Uriarra creek, near crossing, *L.G.Adams 745*, 22.x.1963 (CANB). **VICTORIA.** 1.5 km N of Tallarook, *T.B.Muir 6187*, 12.x.1978 (MEL); Stratford Highway Park, *I.D.Lunt 91/92*, 4.x.1991 (MEL); Spencer Street Railway Station, Melbourne, *V.Stajsic 1049*, 31.x.1994 (MEL). **TASMANIA.** Bridport, *W.M.Curtis*, 10.xi.1952 (HO); Deal Island, Kent Group, *J.S.Whinray 278*, 29.xii.1968 (HO); Point NE of Croppies Point, *A.M.Buchanan 1695*, 23.xi.1983 (HO); Swan River, 6 km S of Cranbrook, *P.Collier 5246*, 4.ix.1991 (HO).

**Distribution and habitat:** Occurs in southern Australia, including southern Western Australia, south-eastern South Australia, New South Wales, the Australian Capital Territory, Victoria, and eastern Tasmania (Fig. 13). Native to southern Europe. Widely naturalised around the world. Grows in many types of vegetation as well as in urban environments, particularly pavement cracks.

**Notes:** A very common weed in southern mainland Australia, readily distinguished by its cyme development and flower and fruit morphology. It often forms rather dense small mats. A widespread form on Kangaroo Island, South Australia has ovaries and fruit that are glabrous except for a few inconspicuous hairs at the summit. A specimen from Fish Creek in South Gippsland (*A.Paget 1147* MEL 2027524) is unusual in that it has a moderately dense indumentum of straight to hooked hairs on stems and leaves.

**3. *Galium album* Mill., Gard. Dict. 8<sup>th</sup> edn, 7 (1768)****Type:** not known.

*Perennials* to c. 100 cm high. *Stems* c. 1 mm diam.; angles slender, mildly raised, glabrous; whorls mostly 6–8-partite in inflorescences, reducing in number towards summit; stipules remaining subequal to leaves. *Leaves* oblanceolate, 5–10 mm long, 1–3 mm wide, with l:w ratio 3–5; margin recurved or revolute with antrorse sub-appressed hairs; apex acuminate with a hyaline apiculum c. 0.3 mm long; terminal hair not evident; upper surface dull, with midrib weakly defined, glabrous; lower surface glabrous. *Inflorescences* paniculate, with elongate many-flowered partial inflorescences from main axis, with arrangement becoming cymose after a few orders of branching; cymes several to many-flowered with 2–4 orders of branching, greatly exceeding whorls, slightly congested to lax; bracts absent or single at primary node, shorter than the branchlets they subtend; penultimate and ultimate peduncles 1–5 mm long, 0.2 mm diam., inserted mostly in middle third, not or mildly overtopping. *Flowers:* corolla 3–4 mm diam., with lobes 1.4–1.8 mm long, acuminate, white; ovary c. broad-elliptic in outline, c. 0.5 mm long, glabrous, smooth. *Peduncles* in fruit straight; mericarps not seen.

*Flowers* spring (based on single Australian record).

**Selected specimens:** SOUTH AUSTRALIA. Millicent–Mt Burr Rd, 1 km NW of Mt Burr shop, R.J.Bates 61285, Nov. 2003 (AD).

**Distribution and habitat:** Known from a single collection north of Millicent in far south-eastern South Australia (Fig. 13). Native to Europe.

**Notes:** *Galium album* is a member of a complex of European species known as the *Galium mollugo* complex (Ehrendorfer 1976). The sole Australian specimen is identified as *G. album* based on size of the corolla and the plant's lack of stem hairs. In the Australian material, the anthers are relatively large, drying dark brown, and the stigmata are also relatively large compared to other introduced species of *Galium*.

**4. *Galium verum* L., Sp. Pl. 1: 107 (1753)**

**Type:** EUROPE. Herb. Linn. 129.13; lecto: LINN *n.v.*, fide S.Nazimuddin & M.Qaiser, in E.Nasir & S.I.Ali, *Fl. Pakistan* 190: 66 (1989).

*Stoloniferous perennials* to c. 100 cm high. *Stems* 1–2 mm diam.; angles slender, slightly raised, with

abundant weak tangled hairs 0.1–0.3 mm long extending over faces also (stems becoming terete and glabrescent with age and developing a smooth brown bark); whorls commonly 8-partite, reducing in number towards summit of inflorescences. *Leaves* narrow-linear, 10–20 mm long, c. 0.4–1 mm wide, with l:w ratio 20–50, strongly revolute so none of lower surface or only the midrib is visible; apex narrowly acute, with a minute hyaline extension and a smaller terminal hair; upper surface sublustrous, with midrib weakly defined, with scattered minute antrorse scabrosities; abaxial surface with midrib pubescent at sides. *Inflorescences* paniculate; with elongate many-flowered partial inflorescences from main axis, congested, with ultimate branching cymose; penultimate and ultimate peduncles c. 1 mm long, c. 0.15–0.2 mm diam., inserted c. midway; not overtopping. *Flowers:* corolla 3–4 mm diam., with lobes 1–1.8 mm long, acute, golden-yellow; ovary c. circular in outline, c. 0.3 mm long, glabrous, smooth. *Peduncles* of fruit straight; mericarps broad-ellipsoid, 1–1.2 mm long, c. 0.8 mm wide, shallowly rugose; dissepiment scar slightly recessed, c. 0.4 mm long. *Lady's Bedstraw*.

*Flowers* summer (based on Australian record).

**Selected specimens:** TASMANIA. Corner of Dairy Plains Road and Cheshunt Road, A.M.Buchanan 15656, 10.i.2000 (HO).

**Distribution and habitat:** Known from a single locality in northern Tasmania, where several colonies had become established on a roadside (Fig. 13). Native to Europe.

**Notes:** Similar to *G. album* in having inflorescences with 100s of flowers. Corolla-lobes become mildly deflexed based on evidence from a few specimens.

**5. *Galium divaricatum* Pourret ex Lam., Encycl. 2: 580–581 (1788)**

**Type:** none cited [protologue: France]

*G. parisiense* var. *australe* Ewart & Jean White, *Proc. Roy. Soc. Victoria*, new ser., 21: 541 (1909). **Type:** Victoria: Goroke, *St. Eloy D'Alton* 7; syn: MEL; Victoria: Goulburn River, *W.Gates*, 1892; syn: MEL; Victoria: Wannon River, *H.B.Williamson*, 1898; syn: MEL, NSW; Victoria, Wannon River below Hamilton, *H.B.Williamson* 622, no date; syn: MEL; Western Australia: Woorlooloo, *M.Koch* 1646, October 1906; syn: MEL.

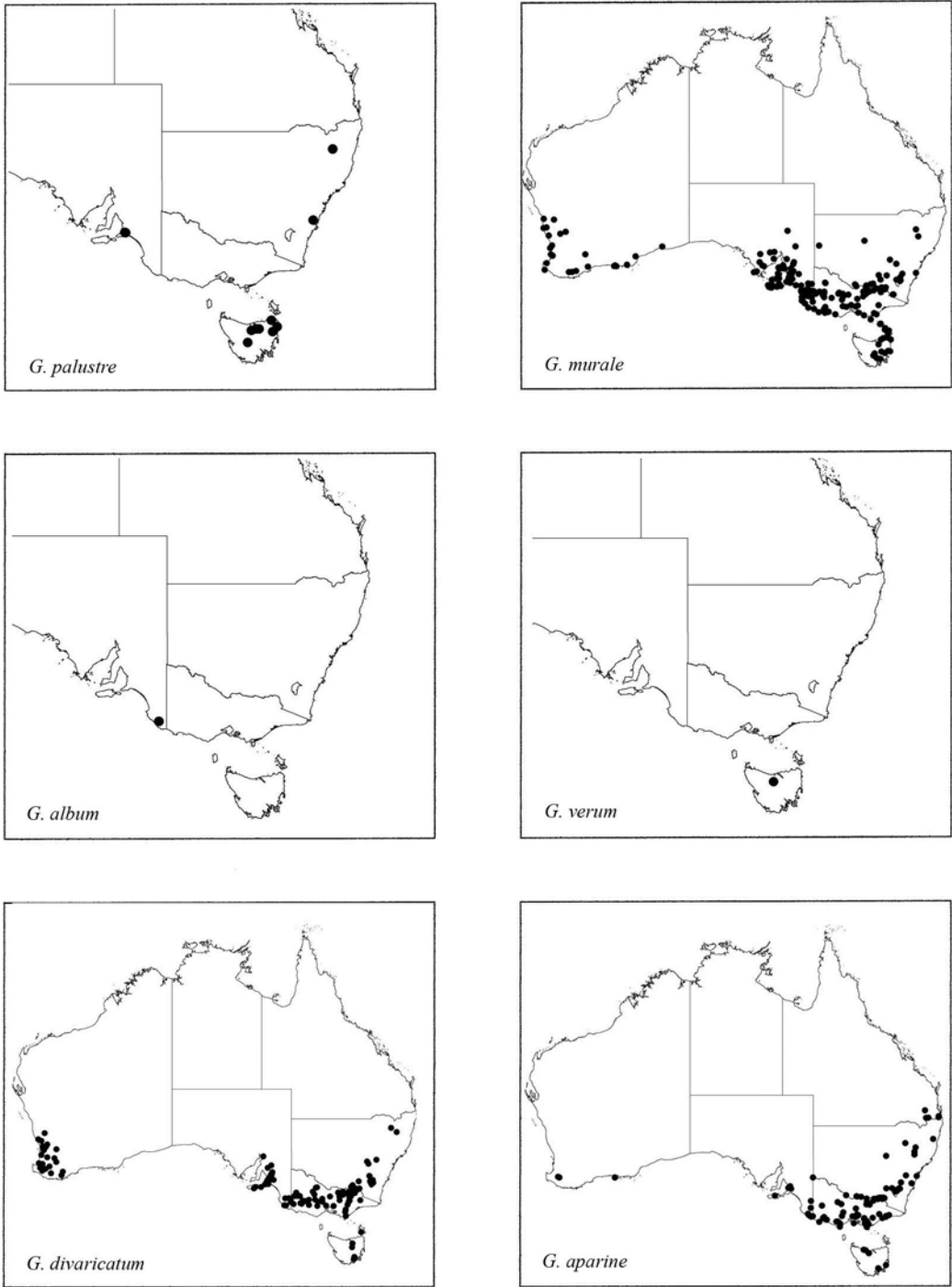

**Figure 13.** Distributions of *Galium palustre*, *G. murale*, *G. album*, *G. verum*, *G. divaricatum*, *G. aparine* (incomplete for Western Australia).

[*G. parisiense auct. non* L. (1753): J.H.Willis, *Handb. Fl. Victoria* 2: 616 (1972)]

*Annuals* to c. 30 cm high. *Stems* 0.2–0.6 mm diam.; angles very slender, hardly raised, glabrous or with sparse to scattered scabrosities; whorls mostly 4–6-partite, up to 8-partite sometimes along main axis of inflorescence, reducing in number upwards along flowering axes. *Leaves* narrow-oblongate, very narrow-elliptic or linear, 2–7 (–15) mm long, 0.5–1.0 (–2) mm wide, with l:w ratio 5–15, tapering very gradually basally, thin; margin usually revolute, with a line of antrorse to sub-appressed hairs; hairs plump, not curved apically, not tubercle-based; apex acute usually with a minute hyaline apiculum; terminal hair present, 0.1–0.5 mm long; upper surface dull to sublustrous, with midrib weakly defined, glabrous or with a few antrorse hairs mainly near marginal or along midrib; lower surface glabrous or with a few hairs on midrib. *Inflorescences* paniculate, with elongate several- or more often many-flowered partial inflorescences from main axis, becoming cymose after 1 or 2 orders of branching; cymes mostly 2–5-flowered; bracts present at all nodes or absent from ultimate nodes, equal to or shorter than peduncles they subtend; penultimate and ultimate peduncles 0.5–3 mm long, 0.05–0.1 mm diam., inserted distally, generally not overtopping. *Flowers*: corolla 0.4–0.7 mm diam., with lobes c. 0.3 mm long, acute, yellowish and usually somewhat purplish-red abaxially; ovary c. circular in outline, c. 0.4 mm long, glabrous, minutely papillose. *Peduncles* in fruit straight; mericarps reniform, 0.4–0.8 mm long, with surface papillose but not rugose; dissepiment scar deeply recessed, c. 0.2–0.4 mm long. *Slender Bedstraw*.

*Flowers* late winter–spring.

**Selected specimens:** **WESTERN AUSTRALIA.** Between Lancelin and Regans Ford, c. 2km N of Moore R. bridge, *R.Pullen* 9739, 30.xi.1974 (AD, CANB, PERTH n.v.). **SOUTH AUSTRALIA.** N of Lyndoch, *R.J.Bates* 29525, 25.x.1992 (AD); Mintaro Hills, *R.Bates* 55427, 27.xii.1999 (AD). **NEW SOUTH WALES.** C. 1.5 km from Tarcutta on Westbrooke Rd, *C.W.E.Moore* 1455, 18.xi.1950 (CANB). **AUSTRALIAN CAPITAL TERRITORY.** Paddy's River, *E.Gauba*, 30.xii.1952 (CANB, NSW). **VICTORIA.** C. 3 km S of Mt Big Ben, c. 25 km NE of Myrtleford, *A.C.Beauglehole* 43535, 21.xi.1973 (MEL, NSW); Nurcoun Flora Reserve, *A.C.Beauglehole* 86813, 13.xi.1986 (MEL); N side of railway line, Parwan, *V.Stajsic* 2567, 6.xii.1997 (AD, CANB, MEL). **TASMANIA.** Boomers Bottom, Lake River, 30 km W of

Campbell Town, *P.Collier* 5042, 9.xii.1990 (HO); Coningham State Recreation Area, *A.North*, 1.iv.1996 (HO); car park at Mt Pleasant Labs, *D.I.Morris* 8310, 14.i.1983 (AD, HO, MEL).

**Distribution and habitat:** Occurs in southern Australia, including south-western Western Australia, south-eastern South Australia, eastern New South Wales, the Australian Capital Territory, Victoria, and eastern Tasmania (Fig. 13). Native to southern Europe and Asia. Grows in woodland and grassland.

**Notes:** Similar in leaf morphology to *G. murale* but easily distinguished by inflorescence and floral characters. Well-developed specimens present numerous capillary inflorescence branchlets. Although these inflorescence branchlets are generally long, the ultimate peduncles are typically only c. 1 mm long. *Galium divaricatum* has a similar distribution to *G. murale* but does not extend as far into low rainfall zones and is generally not an urban weed. Interpretation of what constitutes a single cyme is difficult in this species due to the complexity of branching of the inflorescences and the gradual reduction in bract size and number with successive nodes. A cyme here is defined as the part of an inflorescence where there is a significant reduction in bract parts from one whorl to the next and then continued reduction thereafter.

## 6. *Galium aparine* L., *Sp. Pl.* 1: 108 (1753)

**Type:** EUROPE. Herb. Linn. 129.33; lecto: LINN *n.v.*, *vide* S.M.H.Jafri, in S.M.H.Jafri & A.El-Gadi, *Fl. Libya* 65: 15 (1979).

*Annuals* to c. 1 m high (with support). *Stems* 1–3 mm diam.; angles slender, strongly raised, with a scattered line of robust tubercle-based retrorsely curved hairs 0.3–0.5 mm long, and often with fine hairs c. 1 mm long at and about nodes; whorls predominantly 6–8-partite below and at lower nodes of inflorescences, with usually at least 1 whorl 7 or more-partite, often reducing to 6-partite from upper nodes; stipules subequal to leaves throughout. *Leaves* oblanceolate to narrow-oblongate, rarely almost linear, 8–50 mm long, 1–10 mm wide, with l:w ratio 3–10 (–15), thin; margin flat or recurved, with a line of robust tubercle-based retrorsely curved hairs; apex narrowly acute to acuminate with hyaline apiculum 0.5–2 mm long; terminal hair not developed or minute; upper surface dull to sublustrous, with midrib distinct and sometimes recessed, with hairs scattered but not arising from



midrib; hairs 0.3–0.5 mm long, spreading to slightly antrorse, moderately antrorsely curved to weakly hooked; lower surface glabrous except for robust midrib hairs. *Inflorescences* comprising an elongate raceme of cymes; cymes 2–6(–10)-flowered, with 1–3 orders of mostly monochasial branching, c. equal to or more often exceeding whorls; primary peduncle 10–70 mm long; bracts present at all nodes, usually in whorls of 2–6 at primary node, longer or shorter than the peduncle they subtend; penultimate and ultimate peduncles 3–40 mm long, 0.3–0.5 mm diam., inserted moderately distally, not overtopping. *Flowers*: corolla 1.5–2 mm diam., with lobes c. 0.8 mm long, acuminate, cream or white; ovary c. circular in outline, 0.5–0.7 mm long, covered with tubercle-based hooked hairs 0.5–0.8 mm long, finally spreading. *Peduncles* in fruit curved near summit; mericarps plump reniform to subglobose, 2–4 mm long, 1–3 mm wide, blackish, with tuberculate hairs persisting; dissepiment scar deeply recessed, c. 0.5 mm long. *Cleavers, Large Goosegrass.*

*Flowers* late winter–summer.

**Selected specimens:** **SOUTH AUSTRALIA.** Sturt Gorge Recreation Park, Magpie Creek, *B.J.Blalock* 3175, 8.vii.2001 (AD); Lower reaches of Torrens Gorge, *D.Symon* 14839, 21.xi.1988 (AD, CANB, HO, MEL); c. 3 km E of Echunga, at road junction on Mount Barker–Macclesfield Rd, *P.J.Lang* 1881, 26.x.1990 (AD). **NEW SOUTH WALES.** C. 50 m downstream of Gin Gin bridge, Macquarie River, *S.Johnson* 43, 7.xi.2000 (BRI, CANB, NSW); Oak Creek Nature Reserve, 7.1 km N of Wee Jasper, *I.Crawford* 7118, 29.x.2002 (CANB); Murrurundi, park on W side of New England Hwy, *R.G.Coveny* 16554 & *A.J.Whalen*, 12.x.1993 (AD, BRI, CANB, HO, MEL, NSW). **AUSTRALIAN CAPITAL TERRITORY.** E slope of Black Mountain, Canberra, *B.J.Lepschi* 3925, 19.xi.1998 (AD, BRI, CANB, MEL). **VICTORIA.** 3 km W of Portland PO, S of Bridgewater Road, *A.C.Beaglehole* 79136, 8.ii.1985 (MEL); Seymour, beside Goulburn River, *T.B.Muir* 6903, 6.xi.1981 (MEL); Anson Rd, c. 5 km SW of Pomborneit, *I.C.Clark* 2124, 30.xi.1992 (CANB, MEL). **TASMANIA.** Stoodley Plantation, 41°23', 146°23', *W.F.Pataczek*, 11.i.1984 (AD, HO).

**Distribution and habitat:** Occurs mostly in south-eastern Australia, with a few records from south-western Western Australia. In south-eastern Australia it occurs in south-eastern South Australia, south-eastern Queensland, eastern New South Wales, the Australian Capital Territory, Victoria, and Tasmania (Fig. 13). Native to the Mediterranean region and Asia as far east as Pakistan. Widely naturalised around the world.

Grows in disturbed, usually moderately well-watered environments, particularly in urban environments and/or near sites of human habitation. [*G. tenerum auct. non* Schleicher (1821): J.M.Black, *Fl. S. Australia*, 2<sup>nd</sup> edn, 4:800 (1957); J.H.Willis, *Handb. Fl. Victoria* 2: 617 (1973)].

**Notes:** *Galium aparine* is similar to *G. spurium* and careful examination is required to distinguish between them. *Galium spurium* occurs in drier environments and has not become established in urban environments. Care needs to be taken with these two species when interpreting the leaf indumentum. The retrorse robust hairs on the margin need to be distinguished from the more slender and antrorsely curving near-marginal hairs. Particularly if the margin has rolled somewhat, these near-marginal hairs could be mistakenly interpreted as marginal hairs.

### 7. *Galium spurium* L., *Sp. Pl.* 1: 106 (1753)

**Type:** EUROPE. Herb. Linn 55.17; lecto: LINN *n.v.*, *vide* A.Natali & D.Jeanmonod in D.Jeanmonod, *Compl. Prodr. Fl. Corse* 53 (2000).

*G. ibicinum* Boiss. & Hausskn. ex Boiss., *Fl. Orient.* 3: 70 (1875); *G. spurium* subsp. *ibicinum* (Boiss. & Hausskn. ex Boiss.) Ehrend., *Pl. Syst. Evol.* 127: 305 (1977). Type: Persia (Iran): Luristan: “Ad nives M. Sawers 12000 ped.” [alt. 3500 m], *H.C.Haussknecht*, no date; lecto: W, *vide* F.Ehrendorfer *loc. cit.*

*G. aparine* var. *minor* Benth., *Fl. Austral.* 3: 447 (1867). Type: ?Victoria: Murray River, *F.Mueller*; syn: MEL; Victoria: Wendu Valley, Glenelg River, *R.Robertson*; syn: ?K *n.v.*; South Australia: Mt Gambier, *F.Mueller*, January 1857; syn: MEL; Western Australia: Swan River, *J.Drummond* 727; syn: MEL; Western Australia: Swan River, *Oldfield*; syn: MEL.

*G. aparine sensu* J.A.Jeanes, *Fl. Victoria* 4: 619 (1999), *p.p.*

[*G. tenerum auct. non* Schleicher (1821): J.M. Black, *Fl. S. Australia*, 2<sup>nd</sup> edn, 4: 800 (1957); J.H.Willis, *Handb. Fl. Victoria* 2: 617 (1973)]

*Annuals* to c. 30 cm high. *Stems* 0.5–1 mm diam.; angles slender, strongly raised, with a scattered line of robust tubercle-based retrorsely curved hairs, 0.1–0.4 mm long; whorls predominantly 4–6-partite, with 1 or more lower nodes of inflorescences usually with 5- or 6-partite whorls, rarely 7 or 8-partite whorls present.

*Leaves* oblanceolate or spatulate, (4–)8–30(–60) mm long, 1–5(–8) mm wide, with l:w ratio 3–10, thin; margin flat or recurved, with robust tubercle-based retrorsely curved hairs; apex acuminate or acute, with hyaline apiculum 0.3–0.6 mm long; terminal hair sometimes developed, to 0.2 mm long; upper surface dull, with midrib weakly defined; glabrous or with sparse to scattered hairs arising from midrib, hairs 0.1–0.3 mm long, antrorse, straight to curved apically; lower surface glabrous except for robust midrib hairs. *Inflorescences* comprising an elongate raceme of cymes; cymes 1–3(–5)-flowered, with 0–1(–2) orders of monochasial branching, lax, mostly not exceeding whorls; primary peduncle 5–25 mm long; bracts 0 or 1, or rarely a whorl of 2–5 developed at primary node, shorter than the peduncle they subtend; penultimate and ultimate peduncles 2–10 mm long, 0.2–0.3 mm diam., mostly inserted in distal third, occasionally overtopping. *Flowers*: corolla c. 1.2 mm diam., with lobes c. 0.5 mm long, acute, cream or greenish; ovary c. circular in outline, c. 0.8 mm long, covered with tubercle-based hooked hairs 0.3–0.5 mm long finally spreading. *Peduncles* in fruit straight; mericarps plump reniform to subglobose, (1.2–)1.5–2.3 mm long, 0.8–1.5 mm wide, blackish-brown or reddish-brown, with tuberculate hairs persisting; dissepiment scar deeply recessed, c. 0.5 mm long.

*Flowers* mostly spring.

**Selected specimens:** **WESTERN AUSTRALIA.** Charles Darwin Reserve, c. 57 km direct NNE of Wubin, *I.C.Clark* 3435, 2.viii.2005 (MEL); Kularin Dam, c. 24 km ESE of Burakin, *B.J.Lepschi* 2928 & *T.R.Lally*, 7.viii.1996 (CANB, PERTH). **SOUTH AUSTRALIA.** E side of Coronna Hill South, Eyre Peninsula, *R.J.Chinnock* 1881 & *B.Copley*, 7.ix.1974 (AD); Oulnina Park Station, *R.J.Bates* 41094, 2.x.1995; Gammon Ranges National Park, *T.R.N.Loathian* 5345, 20.ix.1978 (AD); Mt Sam, c. 10 km NE of Lake Everard Station, *J.Z.Weber* 3262, 1.x.1972 (AD, CANB); Near Burra North Mines, *R.J.Bates* 34154, 26.ix.1993 (AD, MEL). **NEW SOUTH WALES.** "Iona" on Mt Glass, c. 28 km S of Louth, *C.W.E.Moore* 8061, 4.ix.1980 (CANB). **VICTORIA.** Bank of Murray River, Boundary Point, *J.H.Willis*, 30.viii.1948 (MEL); NE side of Mt Arapiles, *A.C.Beauglehole* 28583, 21.ix.1968 (MEL); Mt Egbert Education Area, *A.C.Beauglehole* 69307, 21.x.1981 (MEL).

**Distribution and habitat:** Occurs in south-western Western Australia, eastern South Australia, mainly western New South Wales, and western Victoria (Fig.

14). Native to Northern Africa, Europe and Asia. Widely naturalised elsewhere. Grows in woodlands.

**Notes:** Compared to the similar *G. aparine*, and apart from differences given in the key, *G. spurium* has more slender stems, no long hairs near nodes, whorls 4- or 5-partite below inflorescences, shorter leaves with upper surface glabrous or sparsely hairy or if as dense then with hairs shorter and more antrorse and more likely to arise from the midrib, shorter cymes that are fewer flowered, with peduncles not curving apically as fruit develops, and mericarps with shorter hairs.

Plants collected from Byaduk caves in south-western Victoria (*Willis* MEL) represent an extreme shade form. *Galium spurium* is predominantly a diploid species according to Ehrendorfer (2005) in contrast to *G. aparine* which is tetraploid to octoploid or variously aneuploid. A specimen from the Northern Lofty Ranges in South Australia (*R.J.Bates* 34154 AD) is unusual. Features which link this specimen to *G. aparine* include the presence of 7- and 8-partite whorls and the development of whorls of bracts at cyme nodes. However, the mericarps appear almost mature yet are only 1.2 mm long. Further investigation of this entity is desirable.

## 8. *Galium tricornutum* Dandy, *Watsonia* 4: 47 (1957)

**Type:** UNITED KINGDOM. Isle of Wight, *D.Turner & W.Borrer*, June 1806; holo: BM.

*Galium tricorne* Stokes, in *W.Withering*, *Bot. Arr. Brit. Pl.* edn 2, 1: 153 (1787), *nom. illeg.*

*Annuals* to c. 1 m high (when climbing). *Stems* 1–2 mm diam.; angles slender, strongly raised, with a line of robust tubercle-based retrorsely curved hairs, 0.1–0.4 mm long; whorls predominantly 7–10-partite, at least in inflorescences. *Leaves* narrow-oblanceolate, linear-elliptic or almost linear, 10–30 mm long, 1–6 mm wide, with l:w ratio generally 8–12, thin; margin flat or recurved, with tubercle-based retrorsely curved hairs; apex narrowly acute or acuminate with hyaline apiculum 0.5–1 mm long; terminal hair absent or minute; upper surface dull, with midrib weakly defined, with robust antrorsely curved hairs restricted to distal third and sub-marginal, otherwise glabrous; lower surface glabrous or with robust midrib hairs. *Inflorescences* comprising an elongate raceme of cymes; cymes mostly 2- or 3-flowered, sometimes to

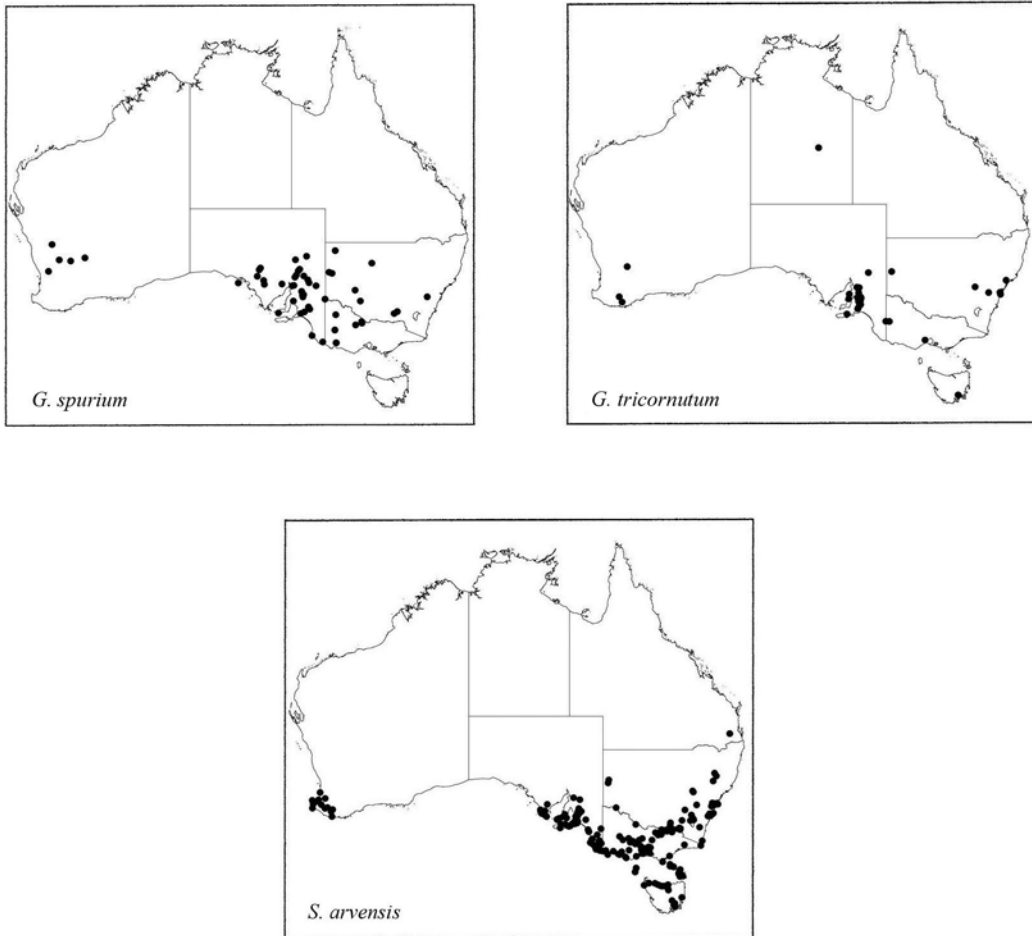

**Figure 14.** Distributions of *Galium spurium* (incomplete for Western Australia), *G. tricoratum*, *Sherardia arvensis*.

6-flowered, mostly with 1 or 2 orders of branching, not exceeding whorls; primary peduncle 10–30 mm long; bracts not developed or 1 or occasionally 2 bracts at primary node, longer than the peduncle it subtends; penultimate and ultimate peduncles 1–10 mm long, c. 0.5 mm diam., inserted midway to moderately distally, not overtopping. *Flowers*: corolla 1.5–2.5 mm diam., with lobes 0.7–1.2 mm long, acute, white; ovary c. circular in outline, c. 1 mm long, tuberculate with hair suppressed or reduced to scabrosities to c. 0.1 mm long, otherwise smooth. *Peduncles* in fruit markedly curved in distal third; mericarps subglobose, 3–4 mm long, brown or tan, with surface not rugose; dissepiment scar deeply recessed, c. 0.5 mm long. *Rough Corn Bedstraw*, *Three-horned Bedstraw*.

*Flowers* late winter–spring.

**Selected specimens:** **WESTERN AUSTRALIA.** Mount Barker, *coll. unknown*, 2001 (PERTH); Farmland, c. 3.5 km NE of Hines Hill, *D.Jolly*, 28.viii.2005 (PERTH). **SOUTH AUSTRALIA.** Two Wells, c. 22 km W of Gawler, *C.R.Alcock* 6216, 29.ix.1973 (AD, CANB); Between Kadina and Moonta, Northern Yorke Peninsula, *B.Copley* 1076, 19.i.1967 (AD); Antares Way, Athelstone, *A.G.Spooner* 1983, 30.viii.1972 (AD); Wolseley–Serviceton rail corridor, *R.J.Bates* 66314, Oct. 2005 (AD); 1 km W of Birchmore Rd, Kangaroo Island, *B.M.Overton* 2816 & *C.Graham*, 25.x.2000 (AD). **NEW SOUTH WALES:** Tramway Dam, Broken Hill, *M.Harding*, 25.viii.1931 (AD); Jenolan Caves, *W.F.Blakely*, Dec. 1899 (NSW). **VICTORIA:** Kaniva, *A.J.Hicks*, 19.xi.1953 (MEL).

**Distribution and habitat:** Occurs in south-western Western Australia, south-eastern South Australia, far western New South Wales, and far western Victoria (Fig. 14). There are also very old records from eastern New

South Wales, Hobart in Tasmania (*L.Rodway* HO) and from central Australia, *Carruthers*, ?1890 (AD). Native to Europe and temperate parts of western to central Asia. Predominantly an agricultural weed in Australia.

**Notes:** A species that seems to make appearances mostly on farmland, but then fails to persist. There is a relatively high proportion of old records for this species. Care must be taken when interpreting leaf hairs in this species. True marginal hairs are retrorsely curved throughout length; however, in the distal third there is a series of antrorsely curved near-marginal hairs on the upper surface which could be misinterpreted as marginal.

### 3. *Sherardia* L., *Sp. Pl.* 1: 102 (1753)

**Type:** *S. arvensis* L.; lecto, *fide* A.P. de Candolle, *Prodr.* 4: 581 (1830)

*Annual hermaphrodite herbs. Stems* quadrangular; unbranched. *Leaves and stipules* similar, with margin pale, thickened; whorls 4-partite increasing to 6-partite upwards. *Inflorescences* terminal and axillary, capitulate or subcapitulate on long peduncles; bracts 6 or 8, involucrate, fused basally. *Flowers:* calyx 6-merous, persisting in fruit; corolla pink, with a narrow tube much longer than lobes; filaments of stamens shortly free; anther without terminal appendages. *Mericarps* not fleshy.

#### *Sherardia arvensis* L., *Sp. Pl.* 1: 102 (1753)

**Type:** [protologue: SWEDEN, GERMANY, ENGLAND], *Sherard*, Herb. Clifford: 33, *Sherardia* No 1; lecto: BM, *fide* A.Natali, *Reg. Veg.* 127: 88 (1993).

*Annuals* to c. 30 cm high, few- to many-stemmed. *Hairs* moderately broad-based mostly c. 0.1 mm long. *Stems* 0.5–1 mm diam., sublustrous; unbranched; internodes mostly 4–70 mm long, with face drying brown, with angles narrow, glabrous or with sparse to frequent short retrorse hairs or long spreading hairs; whorls 4-partite increasing to 6-partite, excluding inflorescence whorl. *Leaves* angled slightly forwards or spreading, elliptic, narrow-elliptic or lanceolate, mostly 3–10 mm long, 1–4 mm wide, with l:w ratio 1.5–6, tapering moderately basally, tapering gradually and strongly distally, mildly coriaceous; base 1/3–1/2 of maximum width; margin flat to recurved, firm, pale sometimes purple-tinged, usually bearing numerous short, strongly antrorse triangular hairs, extending to

apex; apex narrowly acute, not arched, usually with a few to several short terminal hairs; upper surface sublustrous, drying green, usually slightly wrinkled on drying, with midrib usually defined, recessed, glabrous or with scattered long spreading hairs curving antrorsely; lower surface similar in colour and lustre to upper, with midrib slender, clearly raised in proximal 2/3, and equal to or projecting beyond the concavity formed by curved margins, glabrous or with a few antrorse hairs on midrib. *Inflorescences* terminal and axillary, with a single cyme per node; cymes simple, 2–7-flowered, crowded; primary peduncles up to 30 mm long, usually exceeding leaves, with primary bracts 8 (6 in depauperate plants) similar to leaves but a little broader and fused and/or imbricate in basal 1/4 to form an involucre; flowers sessile or on a short stout peduncle; flowers exceeded by bracts or corolla-lobes exceeding bracts. *Flowers:* calyx fused for c. half of length, c. 0.3–1.0 mm long, 6-lobed, pale with greenish midribs, sometimes with hairs as for leaf margin; corolla pink, drying pink or very pale yellow; 2.5–4.5 mm long; tube c. 1.8–3.3 mm long, c. 0.1 mm diam in basal third, flaring distally; lobes 1–1.5 mm long; anthers drying dark brown, c. 0.3 mm long, free filaments c. shorter than corolla lobes; ovary c. globose, c. 1 mm long, drying brown; style c. level with corolla, style-arms suberect, arms c. 0.3 mm long, stigma only slightly broader than arms. *Mericarps* broadly obovoid to ellipsoid, flattened on medial face, 1.6–2.2 mm long (excluding the persistent 3-lobed half-calyx), c. 1 mm wide and deep, glabrous or with hairs; pericarp thin, smooth, brown to blackish, 3-nerved. *Field Madder.*

*Flowers* spring to summer.

**Selected specimens:** **WESTERN AUSTRALIA.** Kingston Forest Block, *E.D.Middleton* K286, 20.xi.1998 (PERTH). **SOUTH AUSTRALIA.** Meadows, c. 30 km SSE of Adelaide, *J.R.Wheeler* 83, 27.x.1966 (AD); Marble Range, Eyre Peninsula, *E.N.S.Jackson* 3726, 4.x.1979 (AD, HO). **NEW SOUTH WALES.** Abercrombie Caves, *K.Mair*, 21.x.1951 (NSW). **AUSTRALIAN CAPITAL TERRITORY.** SE base of Black Mountain, *H.S.McKee* 11622, 25.ix.1964 (NSW). **VICTORIA.** W of the Warby Ranges, c. 6.5 km S of Boweya, *T.B.Muir* 1722, 2.xi.1960 (MEL); Nichols Point Oval, Mildura, *J.H.Browne*, 24.x.1978 (MEL). **TASMANIA.** Near Cape Wickham, King Island, *R.Warman*, 12.xi.2002 (HO); Low Head, *W.Curtis*, Dec. 1955 (HO, MEL); near "Kelvedon", *H.D.Gordon*, 19.xi.1942 (HO).

**Distribution and habitat:** Occurs in far south-western Western Australia, southern South Australia, south-eastern Queensland, New South Wales, the Australian Capital Territory, Victoria, and Tasmania (Fig. 14). Native to Europe and temperate parts of Asia. Naturalised elsewhere. Grows in a range of soils, often sandy, and tolerates subsaline conditions.

**Notes:** Floral structure and colour and bract morphology readily distinguish this species from other Australian species in tribe Rubieae. Sterile specimens can also be distinguished by examination of the leaf margins which have a distinctive hyaline trim.

## Acknowledgements

I am grateful to the School of Botany in The University of Melbourne for the management of my grant funding, to the Royal Botanic Gardens, Melbourne for the use of their facilities, collections staff at MEL, especially Alison Vaughan and Wayne Gebert, for their assistance with mapping and loan processing, the directors of AD, BRI, CANB, HO, NSW and PERTH for providing loans, and to Neville Walsh for his helpful comments on the manuscript. This study was funded by a three year ABRS grant (Grant no: 205-44).

## References

- Allan, H.H. (1961). *Galium*. *Flora of New Zealand* **1**, 591–593.
- Bentham, G. (1867). Order LXI. Rubiaceae. *Flora Australiensis* **3**, 399–447.
- Blake, S.T. (1954). Some pioneers in plant exploration and classification. *Proceedings of the Royal Society of Queensland* **66**, 1–19.
- Bremekamp, C.E.B. (1966). Remarks on the position, the delimitation and the subdivision of the Rubiaceae. *Acta Botanica Neerlandica* **15**, 1–33.
- Briggs, J.D. and Leigh, J.H. (1996). *Rare or Threatened Australian Plants*. CSIRO Publishing: Collingwood.
- Curtis, W. (1966). 49. Rubiaceae. *The Student's Flora of Tasmania* **2**, 266–277.
- Dempster, L.T. (1981). The genus *Galium* in South America. II. *Allertonia* **2**, 393–426.
- Ehrendorfer, F. (1976). *Galium*. *Flora Europaea* **4**, 14–36.
- Ehrendorfer, F. (2005). *Galium* 8. sect. *Kolgyda*. *Flora Iranica* **176**, 233–254.
- Ewart, A.J. (1931). 129. Rubiaceae. *Flora of Victoria*, 1040–1052.
- Ewart, A.J. and Rees, B. (1913). Contributions to the Flora of Australia, no. 20. *Proceedings of the Royal Society of Victoria*, new series, **26**, 1–11.
- Hooker, J.D. (1847) 'Flora Tasmaniae Spicilegium', in W.J.Hooker (ed.), *London Journal of Botany* **6**: 464 bis.
- Jafri, S.M.H. (1979). Rubiaceae. *Fl. Libya* **65**, 1–41.
- Maiden, J.H. and Betche, E. (1916). *A Census of New South Wales Plants*. W.A.Gullick, Govt. Printer: Sydney.
- McGillivray, D.J. (1983). A revision of *Galium* (Rubiaceae) in Australia and New Zealand. *Telopea* **2(4)**, 355–377.
- Mueller, F. (1875). Rubiaceae. *Fragmenta Phytographiae Australiae* **9**, 179–188.
- Natali, A, Manen, J.F., and Ehrendorfer, F. (1996). Tribal, generic and specific relationships in the Rubioideae-Rubieae (Rubiaceae) based on sequence data of a cpDNA intergene region, in E.Robbrecht, C.Puff & E.Smets (eds), Second International Rubiaceae Conference Proceedings. *Opera Botanica Belgica* **7**, 193–203.
- Rodway, L. (1903). Order XXXIX. - Rubiaceae. *The Tasmanian Flora*, 68–71.
- Shaw, H.K.A. and Turrill, W.B. (1928). XV. - *Asperulula Australiensis*. *Bulletin of Miscellaneous Information* **3**, 81–105.
- Wakefield, N.A. (1955). Flora of Victoria: New species and other additions – 4. *Victorian Naturalist* **72**, 69–72.
- Walsh, N.G. and Stajsic, V. (2007). *A Census of the Vascular Plants of Victoria*, 8th edn. National Herbarium of Victoria, Royal Botanic Gardens Melbourne: Melbourne.

## Index of Scientific Names

Epithets of accepted names are in roman (with type bolded if the taxon is new, has new status, or has been resurrected); epithets of synonyms are in italics. Informal epithets given in Walsh & Stajsic (2007) are linked to taxa here via the number reference.

Name	Number ref.	Page no.
<b>Asperula sect. Dioicae</b>		<b>38–70</b>
<b>acuminata</b> I.Thomps.	16	63
<i>ambleia</i> Airy Shaw & Turrill	7	52
<i>arvensis</i> L.		39
<i>asthenes</i> Airy Shaw & Turrill	3	48
<i>charophyton</i> Airy Shaw & Turrill	5	51
<i>conferta</i> Hook.f.	12	57
<i>conferta</i> var. <i>abbreviata</i> Airy Shaw & Turrill	12	57
<i>conferta</i> var. <i>elongata</i> Benth.	5	51
<i>conferta</i> var. <i>scoparioides</i> Airy Shaw & Turrill	12	57
<i>cunninghamii</i> Airy Shaw & Turrill	6	52
<i>euryphylla</i> Airy Shaw & Turrill	15	61
<i>euryphylla</i> var. <i>octophylla</i> Airy Shaw & Turrill	14	61
<i>euryphylla</i> var. <i>tetraphylla</i> Airy Shaw & Turrill	17	64
<i>gemella</i> Airy Shaw & Turrill	1	40
<i>geminifolia</i> F.Muell.	2	45
<i>gunnii</i> Hook.f.	18	64
<i>gunnii</i> var. <i>curta</i> (Hook.f.) Airy Shaw & Turrill	18	64
<i>gunnii</i> var. <i>pusilla</i> (Hook.f.) Benth.	19	66
<b>hoskingii</b> I. Thomps.	9	54
<i>lissocarpa</i> Airy Shaw & Turrill	10	54
<i>minima</i> Hook.f.	21	69
<b>oblanceolata</b> I.Thomps.	20	68
<i>oligantha</i> F.Muell.	Introduction	37
<i>oligantha</i> var. <i>conferta</i> (Hook.f.) Maiden & Betche	12	57
<i>oligantha</i> var. <i>conferta-elongata</i> Maiden & Betche	5	51
<i>oligantha</i> var. <i>gunnii</i> (Hook.f.) Maiden & Betche	18	64
<i>oligantha</i> var. <i>scoparia</i> (Hook.f.) Maiden & Betche	13	59
<i>perpusilla</i> Hook.f.	4 (Notes)	50
<b>polymera</b> I.Thomps.	14	61
<i>pusilla</i> Hook.f.	19	66
<i>scoparia</i> Hook.f.	13	59
<i>scoparia</i> Hook.f. subsp. <i>scoparia</i>	13a	60
<i>scoparia</i> subsp. <b>subglabra</b> I.Thomps.	13b	60
<i>scoparia</i> var. <i>ulicina</i> Airy Shaw & Turrill	13a	60
<i>subsimplex</i> Hook.f.	4	50
<i>subsimplex</i> f. <i>aquatica</i> Airy Shaw & Turrill	4	50
<i>subulifolia</i> Airy Shaw & Turrill	8	53
<i>syrticola</i> (Miq.) Toelken	10	54
<b>tetraphylla</b> (Airy Shaw & Turrill) I.Thomps.	17	61

wimmerana Airy Shaw & Turrill	11	56
<i>wimmerana</i> f. <i>glaberrima</i> Airy Shaw & Turrill	11	56
<b>Galium (Native species, including New Zealand)</b>		<b>70–102</b>
<i>aff. ciliare</i> (Otways) <i>sensu</i> Walsh & Stajsic (2007)	7b	
<i>aff. ciliare</i> (Portland & Eastern) <i>sensu</i> Walsh & Stajsic (2007)	7a	
<b>albescens</b> Hook.f.	4	76
australe DC.	3	75
<i>australe</i> var. <i>piloso-hispidum</i> Benth.	3	75
<i>australe</i> var. <i>typicum</i> Hochr.	Unplaced	102
<i>axiflorum</i> f. <i>laxe-ramosum</i>	17a	97
<i>axiflorum</i> f. <i>minor</i>	17a	97
<i>axiflorum</i> f. <i>procerum</i>	17b	98
binifolium N.A.Wakef.	12	87
binifolium subsp. binifolium	12a	88
binifolium subsp. <b>conforme</b> I.Thomps.	12b	88
<b>bulliformis</b> I.Thomps.	11	86
<b>bungoniensis</b> I.Thomps.	14	91
ciliare Hook.f.	7	80
ciliare Hook.f. subsp. ciliare	7a	81
ciliare Hook.f. subsp. <b>terminale</b> I.Thomps.	7b	82
compactum Ehrend. & McGill.	16	95
<i>curtum</i> Hook.f.	<i>Asperula</i> 18	64
curvihirtum Ehrend. & McGill.	18	99
<b>densum</b> Hook.f.	5	78
<i>erythrorrhizum</i> Miq.	10, 15	85, 92
gaudichaudii DC.	17	96
gaudichaudii DC. subsp. gaudichaudii	17a	97
<i>gaudichaudii</i> var. <i>glabrescens</i> Benth.	7a	81
<i>gaudichaudii</i> var. <i>muriculatum</i> Benth.	10	85
gaudichaudii subsp. <b>parviflorum</b> I.Thomps.	17b	98
<i>gaudichaudii</i> var. <i>latifolia</i> Miq.	Unplaced	102
<i>gaudichaudii</i> DC. var. <i>typicum</i> Domin.	17b	98
<i>geminifolium</i> F.Muell.	<i>Asperula</i> 1	40
<b>leiocarpum</b> I.Thomps.	6	79
<b>leptogonium</b> I.Thomps.	10	84
liratum N.A.Wakef.	1	74
<b>microlobum</b> I.Thomps.	19	100
migrans Ehrend. & McGill.	15	92
migrans subsp. migrans	15a	93
migrans subsp. <b>inversum</b> I.Thomps.	15b	93
migrans subsp. <b>trichogynum</b> I.Thomps.	15c	95
<i>perpusillum</i> (Hook.f.) Allan	<i>Asperula</i> 4 (Notes)	50
<b>polyanthum</b> I.Thomps.	13	89
<i>propinquum</i> A.Cunn.	6 (Notes)	80
roddii Ehrend. & McGill.	8	82

<i>sp. aff. migrans</i> (tuberculate fruits) <i>sensu</i> Walsh & Stajsic (2007)	10	
<i>sp. aff. migrans</i> (smooth fruits) <i>sensu</i> Walsh & Stajsic (2007)	13	
<b>spathulatum</b> I.Thomps.	2	75
<i>squalidum</i> Hook.f.	3	75
<i>subalatum</i> F.Muell. ex Miq.	Unplaced	102
terrae-reginae Ehrend. & McGill.	9	84
trilobum Colenso	1 (Notes)	74
<i>umbrosum</i> G.Forst.	Introduction	37
<i>umbrosum</i> var. <i>bifolium</i> F.Muell.	12a	88
<i>umbrosum</i> var. <i>gaudichaudi-glabrescens</i> Maiden & Betche	7a	81
<i>umbrosum</i> var. <i>gaudichaudi-muriculatum</i> Maiden & Betche	10	85
<i>umbrosum</i> var. <i>gaudichaudii</i> (DC.) Maiden & Betche	17	96
<i>umbrosum</i> var. <i>geminifolium</i> (F.Muell.) Maiden & Betche	<i>Asperula</i> 1	40
<i>umbrosum</i> var. <i>muriculatum</i> (Benth.) Ewart & Rees	10	85
<i>vagans</i> Hook.f.	12b	88
<b>Galium (Introduced species)</b>		<b>103–111</b>
album Mill.	3	104
aparine L.	6	107
<i>aparine</i> var. <i>minor</i> Benth.	7	108
divaricatum Lam.	5	105
<i>ibicinum</i> Boiss. & Hausskn. ex Boiss.	7	108
<i>mollugo</i> L.	3	105
murale (L.) All.	2	104
palustre L.	1	103
<i>parisiense</i> var. <i>australe</i> Ewart & Jean White	5	105
spurium L.	7	108
<i>spurium</i> subsp. <i>ibicinum</i> (Boiss. & Hausskn. ex Boiss.) Ehrend.	7	108
<i>tenerum</i> Schleich. ex Gaudin	7	108
<i>tricornae</i> With.	8	109
tricornutum Dandy	8	109
verum L.	4	105
<b>Rubia</b>		
<i>syrticola</i> Miq.	<i>Asperula</i> 10	54
<b>Sherardia</b>		
arvensis L.		111
<i>muralis</i> L.	<i>*Galium</i> 2	104