

Haier

Ductless Multi-Split Heat Pump

Service Manual

Outdoor

2U20EH2VHA
3U24EH2VHA
4U36EH2VHA

Indoor

Wall Mount - Highwall

AW07EH2VHA
AW09EH2VHA
AW12EH2VHA
AW18EH2VHA
AW07LC2VHB
AW09LC2VHB
AW12LC2VHB
AW18LC2VHB
AW24LP2VHA

2'x2' Compact Cassette

AB09SC2VHA
AB12SC2VHA
AB18SC2VHA

3'x3' Large Cassette

AL24LP2VHA

Slim Duct

AD07SL2VHB
AD09SL2VHB
AD12SL2VHB
AD18SL2VHB

Mid-Static Ducted

USYM09UCDSA
USYM12UCDSA
USYM18UCDSA
USYM24UCDSA

Medium Static Ducted

AM24LP2VHA

Console

USYF09UCDWA
USYF12UCDWA
USYF18UCDWA



Design may vary by model number.

- Please read this manual before using the heat pump.
- Keep this user manual for future reference.
- Before troubleshooting or servicing equipment, review equipment installation guides and confirm ALL installation requirements & specifications have been met. Including, but not limited to: wiring, clearance, ducting (where applicable), power, and line set requirements. Correct any installation issues before continuing.

Table of Contents

Introduction.....	A-1
Outdoor Technical Overview	B-1
Wall Mount Technical Overview	C-1
Compact Cassette Technical Overview	D-1
Large Cassette Technical Overview.....	E-1
Slim Duct Technical Overview	F-1
Mid-Static Ducted Technical Overview.....	G-1
Medium Static Ducted (Pro Series) Technical Overview	H-1
Console Technical Overview.....	I-1
Troubleshooting & Reference	J-1

Revision History

Aug. 2020 - *Manual release.*

Table of Contents

Safety & Precautions..... **A-2**

Specifications **A-3**

 Outdoor Units A-3

 Highwall Indoor A-4

 Ducted Indoor A-4

 Cassette Indoor A-5

 Console Indoor A-5

 Mid-Static Ducted Indoor A-5

Functions and Control..... **A-6**

 Auto Mode..... A-6

 Cooling Operation Mode A-6

 Dry Mode (Dehumidifying Mode) A-6

 Heat Mode..... A-7

 Indoor Fan Control..... A-7

 Cold Air-Proof Operation A-7

 Timing A-7

 Indoor System Mode Conflict A-7

 Abnormality Confirmation Approaches A-8

 Low Load Protection Control A-8

 High Load Protection Control A-8

 When the Compressor First Starts A-8

 The Outdoor Fan Control (Exchange Fan)..... A-8

 The Outdoor Fan Control When In Cooling or Dehumidifying Mode A-8

 The Control of the Outdoor Unit Expansion Valve A-8

 Four-Way Valve Control A-8

 Antifreezing Protection..... A-8

 Over-Temperature Heat Mode Indoor Coil..... A-9

Safety & Precautions

- Read these Safety Precautions carefully to ensure correct installation.
- This manual classifies the precautions by WARNING and CAUTION.
- Follow all precautions below. They are all important for ensuring safety and preventing property/equipment damage.
- ⚠ **WARNING:** Failure to follow any of **WARNING** is likely to result in grave consequences such as death or serious injury.
- ⚠ **CAUTION:** Failure to follow any of **CAUTION** may, in some cases, result in grave consequences.
- The following safety symbols are used throughout this manual:



Observe this instruction



Establish an earth connection



Never attempt

- After completing installation, test the unit to check for installation errors. Give the user adequate instructions concerning the use and cleaning of the unit according to the Operation Manual.

⚠ WARNING

- Installation should be performed by the dealer or another professional. Improper installation may cause water leakage, electrical shock, or fire.
- Install the heat pump according to the instructions given in this manual. Incomplete installation may cause water leakage, electrical shock, or fire.
- Use only the supplied or specified installation parts. Use of other parts may cause the unit to come loose, water leakage, electrical shock, or fire.
- Install the heat pump on a solid base that can support the unit's weight. An inadequate base or incomplete installation may cause injury in the event the unit falls off the base.
- Electrical work should be carried out in accordance with the installation manual and national/local electrical wiring codes and rules of practice. Insufficient capacity or incomplete electrical work may cause electrical shock or fire.
- Use a dedicated power circuit. Never use a power supply shared by another appliance.
- For wiring, use a cable long enough to cover the entire distance with no splices. Do not use an extension cord. Do not put other loads on the power supply, use a dedicated power circuit. (Failure to do so may cause abnormal heat, electric shock or fire.)
- Use only the specified wire types for electrical connections between the indoor and outdoor units. Firmly clamp the interconnecting wires so they receive no external stresses. Incomplete connections or clamping may cause terminal overheating or fire.
- After completing interconnecting and supply wiring connections, shape the cables so that they do not put undue force on the electrical covers or panels. Install covers over the wires. Incomplete cover installation may cause terminal overheating, electrical shock, or fire.
- If any refrigerant has leaked out during the installation work, ventilate the room. (The refrigerant produces a toxic gas if exposed to flame.)
- After all installation is complete, check for and repair any system refrigerant leaks. (The refrigerant produces a toxic gas if exposed to flames.)
- When installing or relocating the system, keep the refrigerant circuit free from substances other than the specified refrigerant (R410A), such as air. (The presence of air or other foreign substance in the refrigerant circuit causes an abnormal pressure rise or rupture, resulting in injury.)
- During pump-down, stop the compressor before removing the refrigerant piping. If the compressor is still running, and the stop valve is open during pump-down, air will be sucked into the system while the compressor is running. This will cause abnormal pressure and noncondensables added to the system.
- Be sure to establish a ground. Do not ground the unit to a utility pipe, arrester, or telephone earth. An complete earth may cause electrical shock, or fire. A high surge current from lightning or other sources may cause damage to the heat pump.



⚠ CAUTION

- Do not install the heat pump in a place where there is danger of exposure to flammable gas. If the gas builds up around the unit, it may catch fire.
- Install drain piping according to the instructions of this manual. Inadequate piping may cause flooding.
- Tighten the flare nut according to the specified torque using a torque wrench. If the flare nut is overtightened, the flare nut may eventually crack and cause refrigerant leakage.
- Provide adequate measures to prevent the outdoor unit from being used as a shelter by rodents. Rodents making contact with electrical parts can cause malfunctions, smoke or fire. Please instruct the customer to keep the area around the unit clean.



Specifications

Outdoor Units

Compressor Type:
DC Inverter Driven Rotary

Voltage/Cycle/Phase:
208-230/60/1

Operating Range (°F):

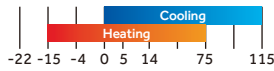

2 Zones



3 Zones











4 Zones













		2U20EH2VHA	3U24EH2VHA	4U36EH2VHA
Cooling Non-Ducted	Rated Capacity Btu/hr	18,100	22,000	34,000
	Capacity Range Btu/hr	7000-20000	6000-23600	6000-38000
	Rated Power Input W	1448	1760	2,740
	SEER/EER	17/12.5	18.5/12.5	20/12.5
Cooling Ducted	Rated Capacity Btu/hr	18,100	21,000	34,400
	Capacity Range Btu/hr	6000-19000	6000-22300	6000-37000
	Rated Power Input W	1724	2000	2,740
	SEER/EER	15/10.5	15/10.5	17.00/10.00
Heating Non-Ducted	Rated Heating Capacity 47°F Btu/hr	20,000	24,000	36,000
	Heating Capacity Range Btu/hr	8000-23000	8000-30600	8000-39000
	Rated Power Input W	1504	1572	2,710
	HSPF	10.5	10.5	10.5
	COP @ 5°F	2.0	2.0	2.0
	Max. Heating Capacity 5°F Btu/hr	23000	24000	36,000
	Max. Heating Capacity -15°F Btu/hr	17000	18000	25,000
Heating Ducted	Rated Heating Capacity 47°F Btu/hr	20,000	22,000	35,000
	Heating Capacity Range Btu/hr	8000-21000	8000-28600	8000-39000
	Rated Power Input W	2255	2230	2710
	COP/ COP @ 5°F	2.94/1.9	3/1.9	2.64/1.9
	HSPF	9.6	9.3	10.5
	Max. Heating Capacity 5°F Btu/hr	19000	20000	35,000
	Max. Heating Capacity -15°F Btu/hr	15000	16000	25,200
Power Supply	Voltage, Cycle, Phase V/Hz/-	208-230/60/1	208-230/60/1	208-230/60/1
	Wire Size between ID and OD	14/4 AWG Stranded	14/4 AWG Stranded	14/4 AWG Stranded
	Compressor Type	DC Inverter Driven Rotary	DC Inverter Driven Rotary	DC Inverter Driven Rotary
	Maximum Fuse Size A	25	25	40
	Minimum Circuit Amp A	15	16	30
	Outdoor Unit	Outdoor Fan Speed RPM	300-900	300-900
Outdoor Noise Level dB		56	56	55
Dimension: Height in (mm)		33.1(840)	33.1(840)	38.0(965)
Dimension: Width in (mm)		37.3(948)	37.3(948)	37.4(950)
Dimension: Depth in (mm)		13.4(340)	13.4(340)	14.6(370)
Weight (Ship/Net)- lbs (kg)		202.3/185.6 (91.7/84.2)	205.9/189.5 (93.4/85.9)	241/221 (109.7/100.6)
Connectable Indoor unit quantity		2	2 or 3	2 3 or 4
Refrigerant Lines		Connections	Flare	Flare
	Liquid O.D. in	1/4 1/4	1/4 1/4 1/4	1/4 1/4 1/4
	Suction O.D. in	3/8 3/8	3/8 3/8 1/2	3/8 3/8 3/8 1/2
	Factory Charge Oz	99	99	113
	Maximum Line Length Ft / m	164/50	196/60	230/70
	Maximum Height Ft / m	50/15	50/15	50/15
	Maximum Line Length for each individual indoor unit Ft / m	82/25	82/25	82/25





Specifications

Highwall Indoor

	 AW07EH2VHA 	 AW09EH2VHA 	 AW12EH2VHA 	 AW18EH2VHA 
Rated Cooling Capacity Btu/hr	7,000	9,000	12,000	19,000
Rated Heating Capacity Btu/hr	10,000	12,000	16,500	20,400
Voltage, Cycle, Phase V/Hz/-	208-230/60/1	208-230/60/1	208-230/60/1	208-230/60/1
Airflow CFM (Turbo/H/M/L/Quiet)	420/360/300/240/180	470/410/350/290/230	440/410/380/311/260	710/650/560/440/410
Indoor Sound dB (Turbo/H/M/L/Quiet)	42/39/37/28/23	42/39/37/28/23	42/39/37/28/23	49/47/42/36/34
Dimension: H x W x D in (mm)	12 1/4 x 35 3/8 x 8 1/4 (310 x 900 x 210)	12 1/4 x 35 3/8 x 8 1/4 (310 x 900 x 210)	12 1/4 x 35 3/8 x 8 1/4 (310 x 900 x 210)	14 3/8 x 43 7/8 x 9 5/8 (336 x 1115 x 243)
Weight (Ship/Net)- lbs (kg)	30.9/25.3 (14/11.5)	30.9/25.3 (14/11.5)	30.9/25.3 (14/11.5)	45.4/37.5 (20.6/17)
Liquid /Suction O.D. in	1/4 3/8	1/4 3/8	1/4 3/8	1/4 1/2

	 AW07LC2VH(-) 	 AW09LC2VH(-) 	 AW12LC2VH(-) 	 AW18LC2VH(-) 	 AW24LP2VH(-) 
Rated Cooling Capacity Btu/hr	7,000	9,000	12,000	18,000	22,000
Rated Heating Capacity Btu/hr	8,000	10,000	13,000	19,000	24,000
Voltage, Cycle, Phase V/Hz/-	208-230/60/1	208-230/60/1	208-230/60/1	208-230/60/1	208-230/60/1
Airflow CFM (Turbo/H/M/L/Quiet)	410/350/295/235/205	410/350/295/235/205	440/380/320/265/215	636/530/483/430/383	710/650/560/440/410
Indoor Sound dB (Turbo/H/M/L/Quiet)	43/38/33/26/22	43/38/33/26/22	44/39/34/27/23	48/45/40/35/30	49/47/42/36/34
Dimension: H x W x D in (mm)	11 x 33 5/8 x 8 1/16 (280 x 855 x 204)	11 x 33 5/8 x 8 1/16 (280 x 855 x 204)	11 x 33 5/8 x 8 1/16 (280 x 855 x 204)	12 3/4 x 39 1/4 x 9 1/4 (332 x 997 x 235)	13 1/4 x 43 7/8 x 9 9/16 (336 x 1115 x 243)
Weight (Ship/Net)- lbs (kg)	26.8/22 (12.2/10)	26.8/22 (12.2/10)	26.8/22 (12.2/10)	35.3/28.6 (16/13)	45.4/37.5 (20.6/17)
Liquid /Suction O.D. in	1/4 3/8	1/4 3/8	1/4 3/8	1/4 1/2	3/8 5/8

Ducted Indoor

	 AD07SL2VH(-)	 AD09SL2VH(-)	 AD12SL2VH(-)	 AD18SL2VH(-)	 AM24LP2VH(-)
Rated Cooling Capacity Btu/hr	7,000	9,000	12,000	18,000	24000
Rated Heating Capacity Btu/hr	8,000	10,000	13,000	19,000	27000
Voltage, Cycle, Phase V/Hz/-	208-230/60/1	208-230/60/1	208-230/60/1	208-230/60/1	208-230/60/1
Airflow CFM (Turbo/H/M/L/Quiet)	353/312/270/230/188	353/312/270/230/188	400/353/282/247/218	540/500/447/365/306	845/670/530/470
Max. Ext. Static Pressure in.W.G (Pa)	0.16 (40)	0.16 (40)	0.16 (40)	0.16 (40)	0.6 (150)
Indoor Sound dB (Turbo/H/M/L/Quiet)	35/33/29/26/21	35/33/29/26/22	38/35/29/26/23	31/29/23/29/25	38/35/32/29
Dimension: HxWxD in (mm)	7 5/16 x 33 7/16 x 16 9/16 (185x850x420)	7 5/16 x 33 7/16 x 16 9/16 (185x850x420)	7 5/16 x 33 7/16 x 16 9/16 (185x850x420)	7 5/16 x 46 1/16 x 16 9/16 (185x1170x420)	9 7/8 x 37 5/8 x 25 3/4 (250x957x655)
Weight (Ship/Net)- lbs (kg)	47.2/36.8 (21.4/16.7)	47.2/36.8 (21.4/16.7)	47.2/36.8 (21.4/16.7)	61.8/48.5 (28/22)	68.8/81.1 (31.2/36.8)
Liquid / Suction O.D. in	1/4 3/8	1/4 3/8	1/4 3/8	1/4 1/2	3/8 5/8
Drainpipe Size O.D. in	1 1/4	1 1/4	1 1/4	1 1/4	1 1/4
Condensate Pump	Standard	Standard	Standard	Standard	Standard
Max. Drain-Lift height in(mm)	27 9/16 (700)	27 9/16 (700)	27 9/16 (700)	27 9/16 (700)	27 9/16 (700)

Specifications

Cassette Indoor



	AB09SC2VH(-)	AB12SC2VH(-)	AB18SC2VH(-)	AL24LP2VH(-)
Rated Cooling Capacity Btu/hr	9,000	12,000	18,000	24200
Rated Heating Capacity Btu/hr	10,000	13,000	19,000	27300
Voltage, Cycle, Phase V/Hz/-	208-230/60/1	208-230/60/1	208-230/60/1	208-230/60/1
Airflow CFM (Turbo/H/M/L/Quiet)	410/365/305/265/205	410/365/305/265/205	470/410/365/295/252	740/630/480/400
Indoor Sound dB (Turbo/H/M/L/Quiet)	42/40/36/32/25	42/40/36/32/25	45/42/40/36/32	38/35/32/29
Grille Model	PB-700KB	PB-700KB	PB-700KB	PB-950KB
Chassis Dimension: HxWxD in (mm)	10 1/4 x 22 7/16 x 2 3/8 (260 x 570 x 570)	10 1/4 x 22 7/16 x 2 3/8 (260 x 570 x 570)	10 1/4 x 22 7/16 x 2 3/8 (260 x 570 x 570)	9 5/8 x 33 1/8 x 33 1/8 (246 x 840 x 840)
Grille Dimension: HxWxDin (mm)	2 3/8 x 27 9/16 x 27 9/16 (60 x 700 x 700)	2 3/8 x 27 9/16 x 27 9/16 (60 x 700 x 700)	2 3/8 x 27 9/16 x 27 9/16 (60 x 700 x 700)	2 x 3 1/8 x 3 1/8 (50 x 950 x 950)
Weight (Ship/Net)- lbs (kg)	46.3/37.5 (21/17)	46.3/37.5 (21/17)	46.3/37.5 (21/17)	68.4/79.4 (31/36)
Liquid / Suction O.D. in	1/4 3/8	1/4 3/8	1/4 1/2	3/8 5/8
Drainpipe Size O.D. in	1 1/4	1 1/4	1 1/4	1
Condensate Pump	Standard	Standard	Standard	Standard
Max. Drain-Lift height in(mm)	27 9/16 (700)	27 9/16 (700)	27 9/16 (700)	47 1/4(1200)

Console Indoor

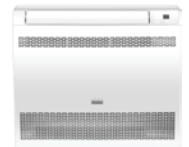
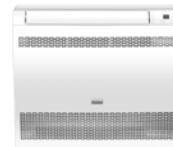
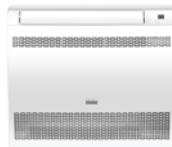

	USYF09UCDWA	USYF12UCDWA	USYF18UCDWA
Rated Cooling Capacity Btu/hr	9,000	12,000	15,000
Rated Heating Capacity Btu/hr	10,000	13,000	18,000
Voltage, Cycle, Phase V/Hz/-	208-230/60/1	208-230/60/1	208-230/60/1
Airflow (Turbo/High/Med/Low/Quiet) CFM	264/235/205/176/147	294/264/205/176/147	341/311/282/252/223
Indoor Sound Level dB (Turbo/High/Med/Low/Quiet)	40/32/25/20	42/34/26/21	46/37/33/28
Chassis Dimension: HxWxD in (mm)	23.6/27.5/8.3 (600/700/210)		
Weight (Ship/Net)- lbs (kg)	36/40 (16.5/18.5)		
Liquid / Suction O.D. in	1/4 3/8	1/4 3/8	1/4 1/2
Drainpipe Size O.D. in	1 1/4	1 1/4	1 1/4

Mid-Static Ducted Indoor



	USYM09UCDSA	USYM12UCDSA	USYM18UCDSA	USYM24UCDSA
Rated Cooling Capacity Btu/hr	9,000	12,000	18,000	24000
Rated Heating Capacity Btu/hr	10,000	13,000	19,000	25000
Voltage, Cycle, Phase V/Hz/-	208-230/60/1	208-230/60/1	208-230/60/1	208-230/60/1
Airflow (Turbo/High/Med/Low/Quiet) CFM	494/423/352/264	494/423/352/264	635/529/458/388	845/670/530/470
Max. External Static Pressure in.W.G (Pa)	0.6(150)	0.6(150)	0.6(150)	0.6(150)
Indoor Sound Level dB (Turbo/High/Med/Low/Quiet)	35/32/29/26	35/32/29/26	37/34/32/29	39/36/33/30
Chassis Dimension: HxWxD in (mm)	27.5/27.5/9.7(700/700/248)	27.5/27.5/9.7(700/700/248)	43.3/27.5/9.7(1100/700/248)	43.3/27.5/9.7(1100/700/248)
Weight (Ship/Net)- lbs (kg)	57/66(26/30)	57/66(26/30)	70/77 (32/35)	70/77 (32/35)
Liquid / Suction O.D. in	1/4 3/8	1/4 3/8	1/4 1/2	3/8 5/8
Drainpipe Size O.D. in	1 1/4	1 1/4	1 1/4	1 1/4
Condensate Pump	Standard	Standard	Standard	Standard
Max. Drain-Lift height in(mm)	39(1000)	39(1000)	39(1000)	39(1000)

Auto Mode

When the running mode is turned to auto after starting the system, the system will first determine the running mode according to the current room temperature and then will run according to the determined mode: Tr means room temperature; Ts means temperature setting; Tp means temperature of indoor coil pipe

Tr ≥ 73°F Choose Cooling Mode

Tr < 73°F Choose Heating Mode

After turning to the auto mode, the running mode will be switched between cooling mode, fan mode, and heating mode according to the change of the indoor ambient temperature. There is a 15 minute delay between mode changes.

Cooling Operation Mode

Temperature control range: 60°F---86°F

Temperature difference: ±2°F

- Control features: When Tr (input airflow) > Ts (set temperature) °F, the indoor fan will operate at the set speed, the mode signal will be sent to the outdoor system, and the compressor will start. When Tr (input airflow) < Ts (set temperature) °F, the indoor fan will operate at the set speed, and the mode signal will be sent to the outdoor system, and the compressor will stop. The system will keep the original status if Tr = Ts.

Airflow speed control: (temperature difference ±2°F)
Automatic:

When Tr ≤ Ts + 4°F high speed.

When Ts + 2°F ≤ Tr < Ts + 5°F, medium speed

When Tr < Ts + 2°F, low speed

When the sensor is off, low speed

When the airflow speed has no delay from the high to low switching, the speed should be delayed for 3 minutes (remain at high speed for 3 minutes.) before the next switch.

When the system is operating, you can set the high, medium or low speed manually. (When the sensor is on or off, the system will change the speed 2 seconds after receiving the signal.)

- Louver control: the location for the louver can be set according to your needs.
- Defrosting function: preventing the frosting on the indoor heat exchanger (when cooling or dehumidifying). When the compressor works continuously for 1 to 6 minutes (adaptable in EEPROM) and the temperature of the indoor coils has been below 32°F for 10 seconds, the compressor will be stopped and the malfunction will be recorded in the malfunction list. The indoor system will continue to run. When the temperature of the indoor coil is raised to 45°F, the compressor will be restarted again (the requirement of 3 minutes' delay should be satisfied.)

Dry Mode (Dehumidifying Mode)

- Temperature control range: 60-86°F
- Temperature difference: ±2°F

Control feature: Send the dehumidifying signal to the outdoor system.

When Tr > Ts + 4°F, the compressor will be turned on, the indoor fan will operate at the set speed. When Tr is between the Ts and Ts + 4°F, the outdoor system will operate at the high dehumidifying frequency for 10 minutes and then at the low dehumidifying mode for six minutes. The indoor fan will operate at low speed.

When Tr < Ts, the outdoor system will be stopped, the indoor fan will be stopped for 3 minutes and then turned to the low speed option.

All the frequency conversions have a ±2°F difference.

- Wind speed control: Automatic:

When Tr ≥ Ts + 9°F, high speed.

When Ts + 5°F ≤ Tr < Ts + 9°F, medium speed.

When Ts + 4°F ≤ Tr < Ts + 5°F, low speed.

When Tr < Ts + 4°F, light speed.

If the outdoor fan is stopped, the indoor fan will be paused for 3 minutes.

If the outdoor fan is stopped for more than 3 minutes and the outdoor system still operates, the system will be changed into light speed mode.

When the airflow speed has no delay from the high to low switching, the speed should be delayed for 3 minutes (remain at high speed for 3 minutes) before the next switch.

When the sensor is off or Tr < Ts + 5°F, the manual operation can not be made (obligatory automatic operation).

- Louver location control: the location for the louver can be set according to your needs.
- Defrosting function: preventing the frosting on the indoor heat exchanger (when cooling or dehumidifying). When the compressor works continuously for 16 minutes (adaptable in EEPROM) and the temperature of the indoor coils has been below 32°F for 10 second, the compressor will be stopped and the malfunction will be recorded in the malfunction list. The indoor system will continue to run. When the temperature of the indoor coil is raised to 45°F, the compressor will be restarted again (the requirement of 3 minutes' delay should be satisfied.)

Heat Mode

- Temperature control range: 60-86°F
- Temperature difference: $\pm 2^\circ\text{F}$

Control feature: the temperature compensation is automatically added and the system will send the heating signals to the outdoor system.

If $T_r \leq T_s$, the outdoor compressor is turned on, the indoor fan will be at the cold air proof mode.

If $T_r > T_s +$, the outdoor system is turned off, the indoor fan will be at the heat residue sending mode.

If $T_r < T_s +$, the outdoor system will be turned on again, the indoor fan will be in the cold air proof mode.

Indoor Fan Control

Manual Control: You can choose high, medium, low and automatic speed control. Automatic:

When $T_r < T_s$, high speed.

When $T_s \leq T_r \leq T_s + 4^\circ\text{F}$, medium speed.

When $T_r > T_s + 4^\circ\text{F}$, low speed.

When the airflow speed has no delay from the high to low switching, the speed should be delayed for 3 minutes (remain at high speed for 3 minutes.) before the next switch.

- Louver location control: the location for the louver can be set according to your needs.

Cold Air-Proof Operation

1. The indoor operation within 4 minutes after the start up is as the following diagram, the air speed can be raised only after the speed has reached a certain level.

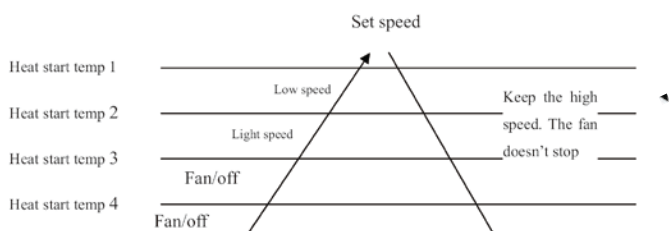

2. 4 minutes after the start up of the indoor fan, the light airflow and the low airflow will be turned to the set speed airflow.
3. In the cold air proof operation, the fan won't stop after the start up.
4. During the cold air proof operation, the indoor system will continuously send 'indoor high speed' signals to the outdoor system.

- Residue heat sending. The indoor fan will send the residue heat at a low speed for 12 seconds.
- If other conditions are satisfied, when the compressor stops, the indoor system will operate at a light speed. The indoor fan will stop when the coil temperature is below the heat start temp 4'.
- Defrosting. When the system receives the defrosting signal from outdoors, the indoor fan will stop and the indoor temperature display won't change. At this time, any indoor coil malfunctions will be neglected. When the outdoor defrosting finishes, the coil malfunction will still be neglected until the compressor has been started up for 30 seconds. The indoor temperature display will not change and the system operates at the cold air proof mode.
- Automatic heating temperature compensation: when the system enters the heating mode, the temperature compensation (4) will be added. When the status is switched off, the compensation will be erased.

Timing

You can set 24 hours on/off timing. After setting, the timing indicator will be displayed. Also, the light will turn off after the timing is set. The followings are several timing methods:

1. System ON timing: The timing indicator will be displayed and the indoor system is under the waiting mode. The light will be turned off when the timing is finished and the rest of the system will operate under a normal condition. The timing starts since the last reception of the timing signal.
2. System /OFF timing: When the system is turned on, the timing indicator will be displayed; the rest of the system will operate under normal conditions. When the set time expires, the indicator display will turn off and the system will turn off. If you have set the dormant functions, the order of your settings will be operated according to the timing settings.
3. System ON/OFF timing: The settings will be completed according to the settings.

Indoor System Mode Conflict

The indoor unit is trying to operate in a mode that is opposite of the mode the outdoor unit is currently operating in. Change the operating mode to either heat or cool, or the indoor unit will shut off.

Outdoor system mode	Indoor system mode	Conflicts
cooling	heating	yes
cooling	cooling	no
cooling	airflow	no
heating	heating	no
heating	airflow	yes
heating	cooling	yes

Abnormality Confirmation Approaches

1. Indoor temperature sensor abnormality:

Under the operation, the normal temperature ranges from 120°F to -30°F. When the temperature goes beyond this range, the abnormality can be confirmed. If the temperature goes back into the range, the system will automatically resume.

2. Indoor heat interaction sensor abnormality:

Under the operation, the normal temperature ranges from 120°F to -30°F. When the temperature goes beyond this range, the abnormality can be confirmed. If the temperature goes back into the range, the system will automatically resume.

3. Indoor/Out door malfunction:

When the indoor system receives the outdoor malfunction codes, it will store the code into E2 for the malfunction list resume. The indoor system will continue to operate according to the original status, the malfunction code will not be revealed or processed.

4. Transmission abnormality:

If the indoor system can't receive the outdoor system for 8 minutes, the communication abnormality can be confirmed and reported and the outdoor system will be stopped.

Low Load Protection Control

In order to prevent the frosting of the indoor heat interaction device, the outdoor system will be stopped if the indoor heat interaction temperature is 32°F for 5 minutes, but the fan will continue to operate. The outdoor system will be started again when the heat interaction temperature is above 108°F, and the system has been stopped for 3 minutes. The malfunction will be stored in the malfunction resume and will not be revealed.

High Load Protection Control

The outdoor system will be stopped if the coil temperature is above 149°F for 2 minutes. The indoor fan will be controlled by the thermostat. The outdoor system can be restarted when the coil temperature is below 108°F and the system has been stopped for 3 minutes. The malfunction will be stored in the malfunction resume and will not be revealed.

When the Compressor First Starts

The compressor will start in low frequency. After a brief time delay, the compressor will come up to operating speed to meet the demand requirement for capacity.

The Outdoor Fan Control (Exchange Fan)

When adjusting the fan speed, the unit should remain at each speed for 30+ seconds to avoid speed-change malfunctions. In Cooling Mode, the wait time between speed levels should be 15 seconds.

The Outdoor Fan Control When In Cooling or Dehumidifying Mode

Five seconds after compressor starts, the outdoor fan will start running at medium speed. After 30 seconds, it begins to control the fans speed according to the temperature conditions of the outdoor environment.

The Control of the Outdoor Unit Expansion Valve

When unit starts, the EEV valves will energize and change to a standard opening. When operation starts, the EEV will change position to keep the suction vapor superheat level at around 10°F.

When the unit is shut off the opening size of the expansion valve of the indoor unit is 5 steps;

Four-Way Valve Control

For the details of defrosting four-way valve control, see the defrosting process.

Under heating mode, the four-way valve opens. If the compressor does not start or changes to a non-heating mode, the compressor will be stopped for 2 minutes, and then the four-way valve will shift.

Antifreezing Protection (Highwall Only)

Prevents freeze-up of the indoor coil

The indoor unit coil temperature sensor will shut off the outdoor unit and begin a defrosting routine if the indoor coil is below 32°F for more than 2 minutes. The indoor unit will not report this operation. Once the indoor coil warms up, the system will re-enter cooling mode and operate normally. This protection cycle prevents the indoor coil from developing ice coating during low heat load operation.

Over-Temperature Heat Mode Indoor Coil

The over-temperature routine will protect the system from excessive high indoor coil temperature during heat mode operation. The routine will initiate if the indoor coil temperature sensor reads temperatures in excess of 131F. Conditions that cause high indoor coil temperature include indoor fan failure, dirty indoor coil and operating the system in heat mode when outdoor air temperatures exceed operating limit. (Too warm outside)

Should this routine be initiated, the system will reduce compressor frequency until the indoor coil temperature reaches 117F. Once this is achieved, the system will return to normal operation.

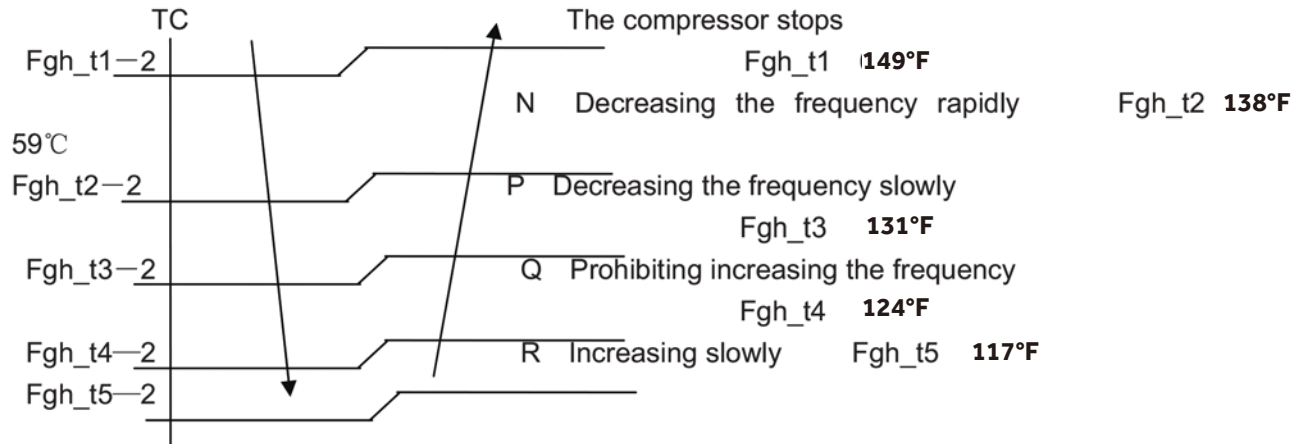



2U20EH2VHA
3U24EH2VHA
4U36EH2VHA

Table of Contents

Components..... B-2

- Component Overview B-2
- Service Monitor Board (SMB) B-3
- Inverter Power Module (IPM) B-3
- PCB B-4
- Power Filter Board (PFB) B-5

Operations..... B-6

- Cooling Mode Sequence of Operation B-6
- Heating Mode Sequence of Operation B-8
- Defrost Cycle Sequence of Operation B-10
- Electronic Expansion Valve (EEV) Control B-11
- 4-Way Valve Heating Control B-11
- Compressor Sump Heater B-11
- Defrost Control B-12
- Base Pan Heater Control Logic B-12
- Troubleshooting the Base Pan Heater Error B-12
- Discharge Sensor Protection B-12
- High Current Protection B-13
- High Pressure Protection in Cooling B-13
- High Pressure Protection In Heating B-13
- Low Pressure Protection B-14
- Oil Return Cycle B-15

Testing..... B-16

- Outdoor Fan Motor B-16
- Temperature Sensor B-16
- 4-Way Valve B-17
- Electronic Expansion Valve (EEV) B-17
- Variable Speed Compressor B-18
- Wiring Error Check B-18

Wiring Diagrams B-19

DIP Switch Settings B-22

Error Codes..... B-24

Components

The outdoor unit features a variable speed, rotary type compressor that delivers refrigerant flow to up to 4 individual indoor units. The system uses R-410A refrigerant mixed with PVE oil, and is 208/230 VAC, 60 Hz, single phase.

Compatible indoor units are High wall, Cassette, Ducted, and Console with remote control, cassette with either remote or wired control, and ducted with wired control only.

The indoor units will maintain individualized room temperatures as set on each controller, provided all units are in the same mode. If the first unit to be turned on is set to the heating mode, all units will heat. If the first unit to be turned on is set to the cooling mode, all units will cool.

Component Overview

- 1 4-Way Valve
- 2 Accumulator
- 3 Compressor
- 4 Defrost Temperature Sensor
- 5 Discharge Temperature Sensor
- 6 Electronic Expansion Valves
- 7 Outdoor Ambient Temperature Sensor
- 8 Outdoor Fan Motor
- 9 Power Factor Reactor
- 10 Suction Line Temperature Sensors
- 11 Terminal Block
- 12 Main Control Board
- 13 Module Control Board
- 14 Fan Blade
- 15 Base Pan Heater

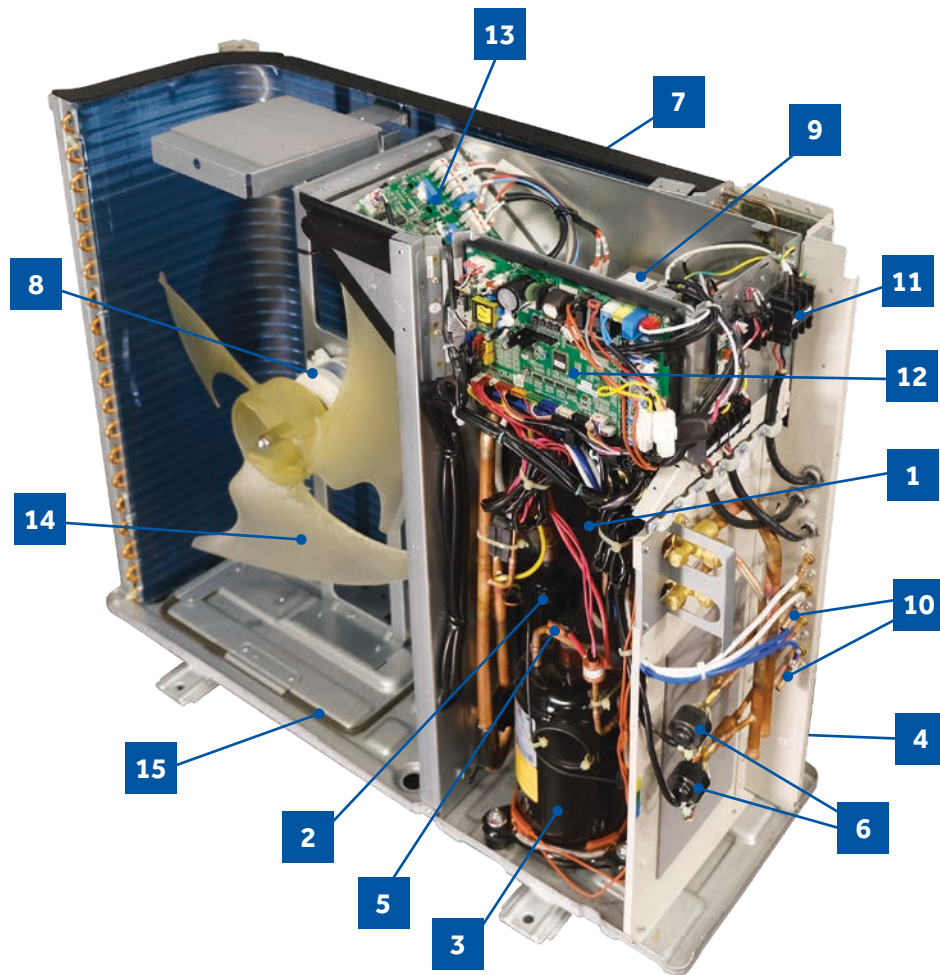

Service Monitor Board (SMB)

The SMB has important features including operational DIP switches, error code display, compressor speed, and diagnostic capabilities.

- 1 The SMB is connected to the PCB via connections CN-2 and CN-3.
- 2 The SW1 DIP switches are OFF (default position for normal operation).
- 3 The digital display will indicate operating frequency of the compressor when no error code is present, or will flash an error code if present.
- 4 A solid green LED indicates that the A, B, C, D or E unit is successfully communicating with the outdoor unit.



Inverter Power Module (IPM)

2U & 3U

- 1 The Inverter Power Module generates 3-phase VDC power to operate the variable speed compressor. The compressor is connected to the IPM via terminals U, V and W.
- 2 A Reactor Coil is connected to the IPM at terminals RI and RO. The Reactor Coil will filter electrical noise generated at high frequency operation that could cause damage to the compressor windings.
- 3 IPM generates a large amount of heat during operation. This heat is transferred to a heat sink behind the board, then mixed with the outdoor air. The Tm temperature sensor protects the IPM from excessive temperatures.

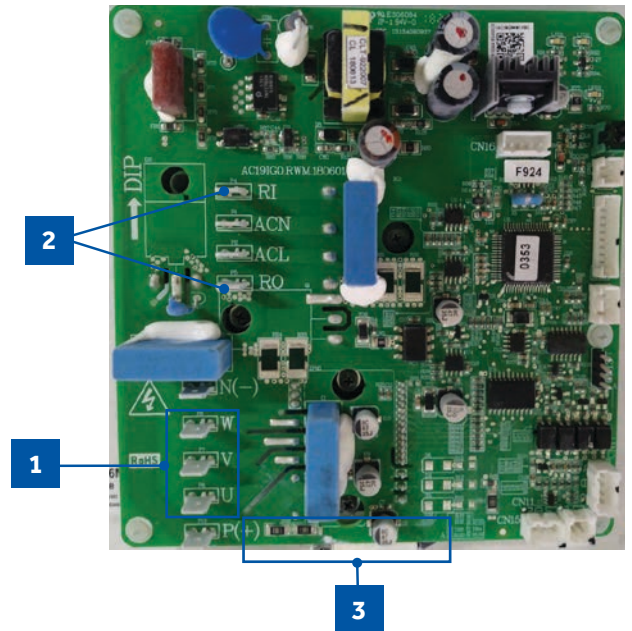

4U

- 1 The Inverter Power Module generates 3-phase variable VDC power(60V-230V) to operate the variable speed compressor. The compressor is connected to the IPM via terminals U, V and W.
- 2 A Reactor Coil is connected to the IPM at terminals LI and LO. The Reactor (spec is 5mH,25A/5mH); the reactor is one part of the PFC(power factor chopper circuit). Its main function is to boost the DC bus voltage with the PFC switches IGBT. The PFC circuit will improve the power factor and reduce electromagnetic noise caused by harmonics.
- 3 IPM generates a large amount of heat during operation. This heat is transferred to a heat sink behind the board, then mixed with the outdoor air.
- 4 The Tfin temperature sensor is used to protect the IPM from excessive temperatures.

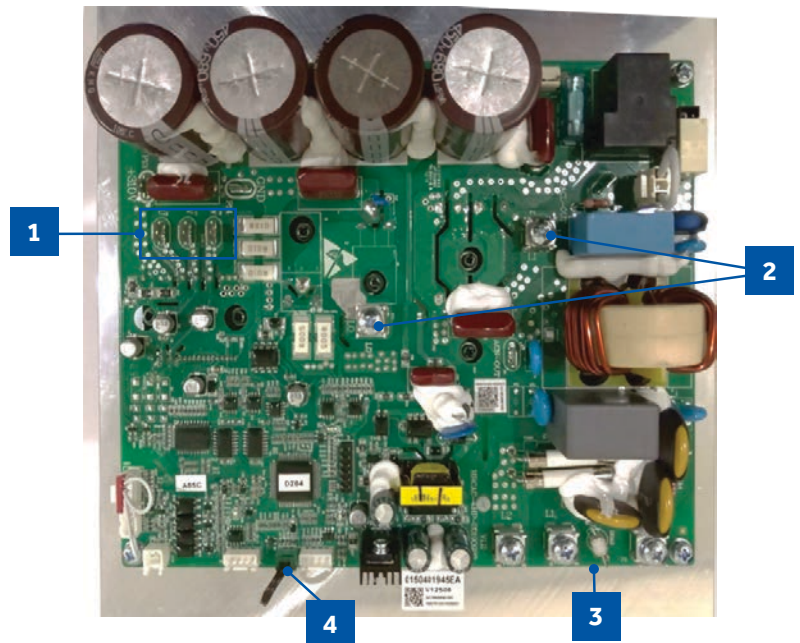

PCB

The PCB is connected via communication cables to the Inverter Power Module, Filter Board, and the Service Monitor Board.

1 Voltage to operate the PCB is provided by the Power Filter Board on terminals ACN and ACL.

2 When power is present, the Green LED will light.

3 The communication cables to the PCB from the Power Filter Board connect to CN6 and CN34.

4 The Service Monitor Board connects to plugs CN-23 and CN-8. When these cables are connected to the Service Monitor Board, the SMB digital display should be illuminated.

5 Plug CN-21 connects the data path between each indoor unit and the PCB. The connections from this plug terminate at the Number 3/C terminal at the indoor unit voltage connection terminal strips.

6 The Outdoor Fan Motor is a DC voltage, variable speed type that connects to the PCB at terminal Plug CN-11.

7 The 4-Way Valve is energized by line voltage from a connection via Plug CN-5. This valve is energized in HEAT MODE.

8 The Crankcase Heater is energized via a connection at terminals CON-9 and CON-8 on the PCB.

9 The EEV coils for the outdoor unit and each indoor unit are connected at terminals CN-15 through CN-18. These EEV coils include the connection for the HEAT MODE EEV coil.

10 There are a set of temperature sensors that monitor the temperature of the refrigerant entering and leaving each circuit. These sensors are mounted in a group near the center of the circuit board.

11 There are system temperature sensors that monitor refrigerant line temperature and outdoor air temperatures. These sensors plug into the PCB via Plugs CN-14, CN-1, CN-7, and CN-24.

12 The system has two refrigerant pressure switches, a Low Pressure Switch and a High Pressure Switch. These switches are connected to the PCB via Plugs CN-12(HP) and CN-13(LP).

13 There are three sets of DIP switches. SW5 and SW7 affect the operational parameters of the unit. Refer to the wiring diagram for the correct settings. SW6 positions are changed only when a Central Controller is used.

14 There are 4 surface mounted buttons located next to SW-5 and SW-6. These buttons are for factory use only.

15 The PCB has a Green LED and a Red LED. When power is present, the Red LED is on. When two or three indoor units are connected, the Green LED is on.

16 T5A 250V rated ceramic fuse is located on the PCB. This fuse will open if excessive current occurs or if a power surge is present. This fuse is field replaceable.

17 Base pan heater connection (150W).

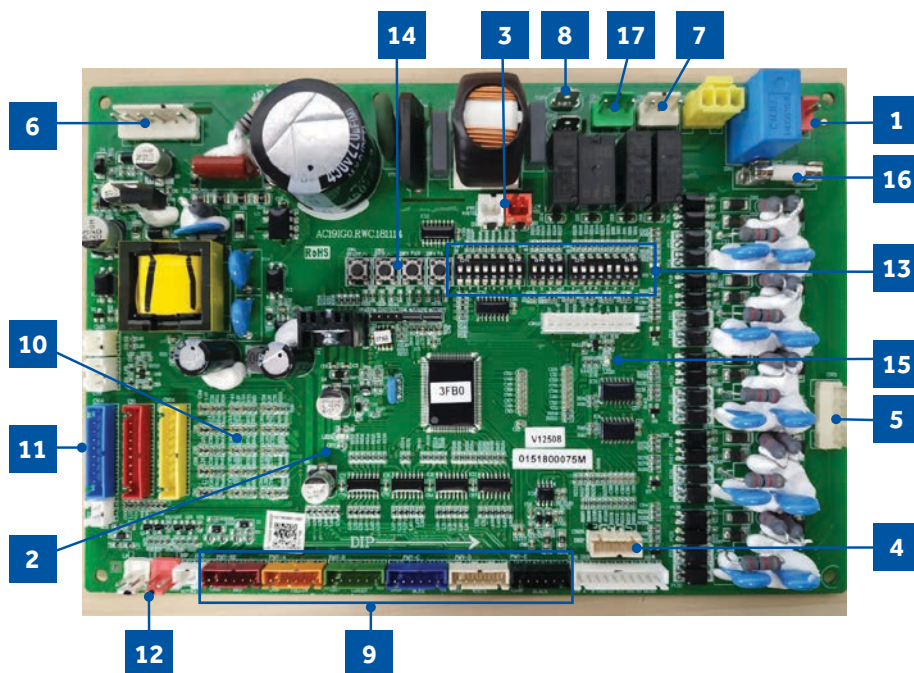

Power Filter Board (PFB)

2U & 3U

The purpose of the PFB is to filter out potential electrical noise before it reaches the outdoor unit electronic circuits. All voltage to operate the outdoor unit circuits must pass through the PFB.

- 1 A replaceable, 30A, 250V rated ceramic fuse protects the outdoor unit electronics. The fuse will open if a power surge or internal short in the outdoor unit has occurred.
- 2 The PFB receives line voltage at terminals P1 and P2 from the outdoor unit high voltage terminal block 1/N and 2/L.
- 3 The voltage that powers the indoor units connects to terminals P3 and P4.
- 4 The PCB receives power to operate via connections at terminals P5 and P6.

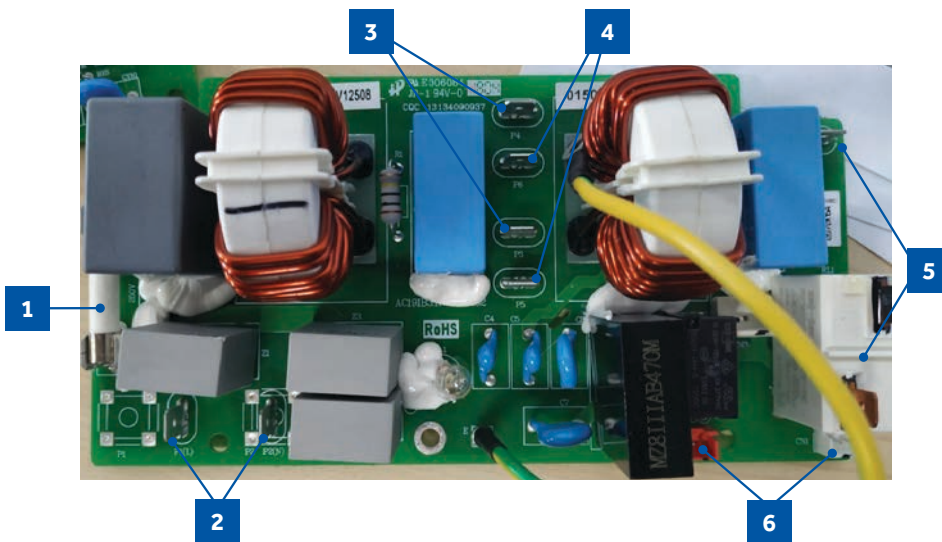

- 5 The IPM receives power via connections at terminals P7 and terminal 3.
- 6 There is a communication plug labeled CN-1 on the PFB. This plug connects from the PFB to the PCB. If this cable is disconnected or loose, the system will generate a Code 6 module low or high voltage error. This error will not be displayed in memory on the indoor unit wired controller. CN-1 and CN-2 connect to the PCB at terminals CN-6 and CN-34. CN-6 is the low stand-by power connection. When power has been turned off at the controller for 5 minutes, CN-6 will remove the 12 VDC signal and open relay RL-1 on the PFB. This saves energy by shutting off power to the IPM. The capacitors must have current flow before the compressor can start. CN-34 is the capacitor charging circuit. When the capacitors are fully charged, the circuit opens to stop the charging process via the RL-2 relay. The voltage between the two pins of CN-1 and the two pins of CN-2 is 12 VDC.

4U

- 1 L1 & L2 is the input port of Filter Board, they will provide 208/230Vac, 60Hz power to the whole unit group(outdoor unit & indoor unit),as is shown in the wiring diagram, these two terminal connect to the OUD main power supply terminal block.
- 2 P1 & P3 is the one of the first stage filtered output of the Filter Board, they will provide 208/230Vac, 60Hz power to all the indoor units which connect to the outdoor unit. As is shown in the wiring diagram, these two terminals connect to one of the IDU & OUD connection terminal block.
- 3 P2 & P4 is the other one of the first stage filtered output of the Filter Board, they will provide 208/230Vac, 60Hz power to the main control board. As is shown in the wiring diagram, these two terminals connect to the ODU main control board CN2
- 4 L1 & L2 is the 2nd stage filtered output of the Filter Board, they will provide 208/230Vac, 60Hz power to the compressor drive module (inverter board). As is shown in the wiring diagram, these two terminals compressor drive module's power input L1 & L2.

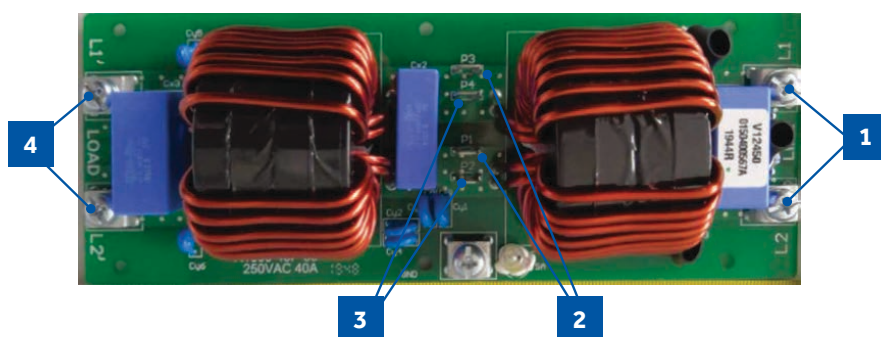

Cooling Mode Sequence of Operation

On a call for cooling, the indoor unit will send the room temperature and set-point requirement to the outdoor unit PCB via the data signal wire path. The data travels from the indoor unit to the outdoor unit via the wire located on terminal 3/C. The indoor louvers will open and the indoor fan motor will start.

The outdoor unit will energize the EEVs that are controlling refrigerant flow to the calling indoor units. The position of the EEVs will be set to an initial position based upon the outdoor air temperature.

The 4-way valve is de-energized. After a 3-minute time delay, the outdoor fan motor will be energized. Shortly after the outdoor fan motor turns on, the compressor will start in low frequency. The operating frequency of the compressor will be displayed on the Service Monitor Board.

The refrigerant in the system will begin to flow, and the compressor will discharge hot gas into the oil separator. Oil will be trapped in the separator and returned to the suction inlet of the compressor via the capillary tube assembly low pressure path.

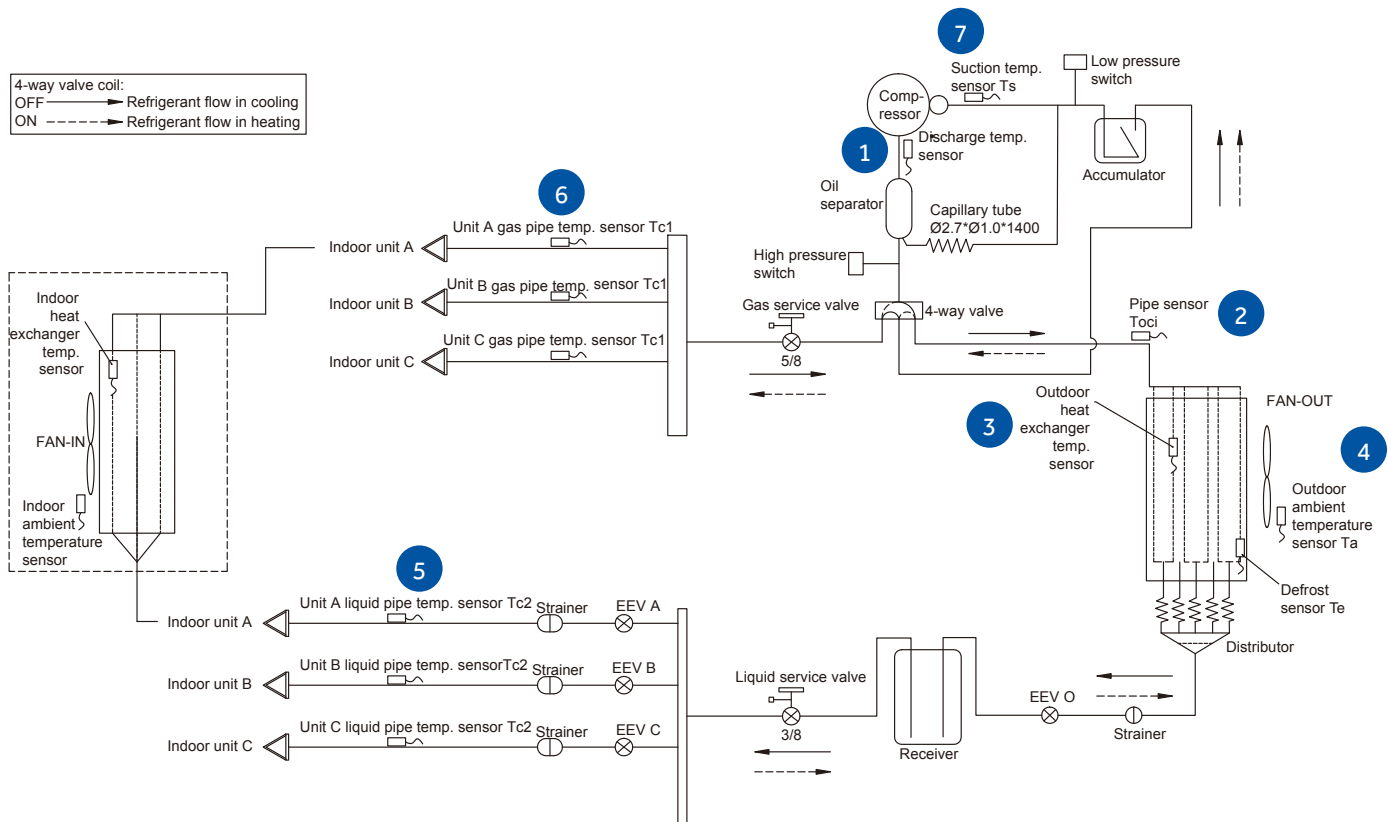

1 Temperature Sensor Td

The temperature of the compressor discharge hot gas will be monitored by the Discharge Temperature Sensor. If the sensor reads too hot or cool, the frequency/status of the operation will be adjusted accordingly.

The hot gas will leave the oil separator and enter the 4-way valve, which directs the hot gas to the outdoor coil. The refrigerant will condense in the outdoor coil and be subcooled. The refrigerant is now in a liquid state.

2 Temperature Sensor Toci

The temperature of the hot gas leaving the 4-way valve will be monitored by the Toci Temperature Sensor. This temperature should be near the temperature of the compressor discharge gas temperature. If it is not, there is a problem with the 4-way valve. The PCB will detect the temperature difference and generate an Error Code.

3 Temperature Sensor Tc

This sensor monitors the temperature of the outdoor coil during condensing operation. If abnormal condensing temperature is detected, the outdoor fan motor speed or compressor frequency may be adjusted.

4 Temperature Sensor Ta

The outdoor air temperature will be monitored by the PCB. If the outdoor air temperature rises or falls, the speed of the outdoor fan may be changed.

5 Temperature Sensor Tc2

The Liquid Pipe Sensor will monitor the temperature of the refrigerant leaving the EEV.

The low pressure low temperature refrigerant will enter the mixed phase liquid line and travel to the indoor unit. Heat from the indoor air passing across the evaporator coil will transfer to the cold refrigerant, sending cool air into the space and changing the liquid refrigerant into a cool vapor.

The cold vapor will travel down the vapor line and return to the outdoor unit via a path through the gas stop valve.

6 Temperature Sensor Tc1

The Gas Pipe Sensor will monitor the temperature of the gas pipe to calculate the difference between Liquid Pipe Temperature and Gas Pipe Temperature. If a change in EEV port opening size is needed, the EEV will make a small adjustment.

The vaporized refrigerant enters the 4-way valve and travels to the vapor line accumulator. The accumulator will trap any liquid refrigerant if present to prevent it from entering the compressor.

The vapor will exit the accumulator and enter the compressor. This cycle will repeat until the demand for cooling ends.

7 Temperature Sensor Ts

The temperature of the suction gas entering the compressor is monitored by the Suction Temperature Sensor. Before stopping operation, the EEV may open to feed more refrigerant or close to warm up the line.

The demand becomes less as the indoor temperature drops toward the desired temperature, so the compressor will reduce speed. When the set temperature is reached, the compressor and outdoor fan will shut off. The circulating fan of each indoor unit continues to run.

Heating Mode Sequence of Operation

On a call for heating, the indoor unit will send the room temperature and set-point requirement to the outdoor unit PCB via the data signal wire path. The data travels from the indoor unit to the outdoor unit via the wire located on terminal 3/C. The indoor unit louvers will open. The fan will not start until the coil has warmed sufficiently to avoid cold drafts.

EEVs serving indoor circuits will step to the standard opening. The outdoor EEV opens to a position based upon the outdoor air temperature.

The 4-way valve will energize and the outdoor fan will start. The compressor starts at a slow speed and will increase based upon demand. The indoor fan starts after the indoor coil is warm enough to avoid circulating cool air.

With the compressor operating, refrigerant will begin to flow throughout the refrigeration circuit.

The operating frequency of the compressor will be displayed on the Service Monitor Board.

When the compressor starts, hot gas will flow into the oil separator. Oil will be trapped in the separator and returned to the suction inlet of the compressor via the capillary tube assembly low pressure path.

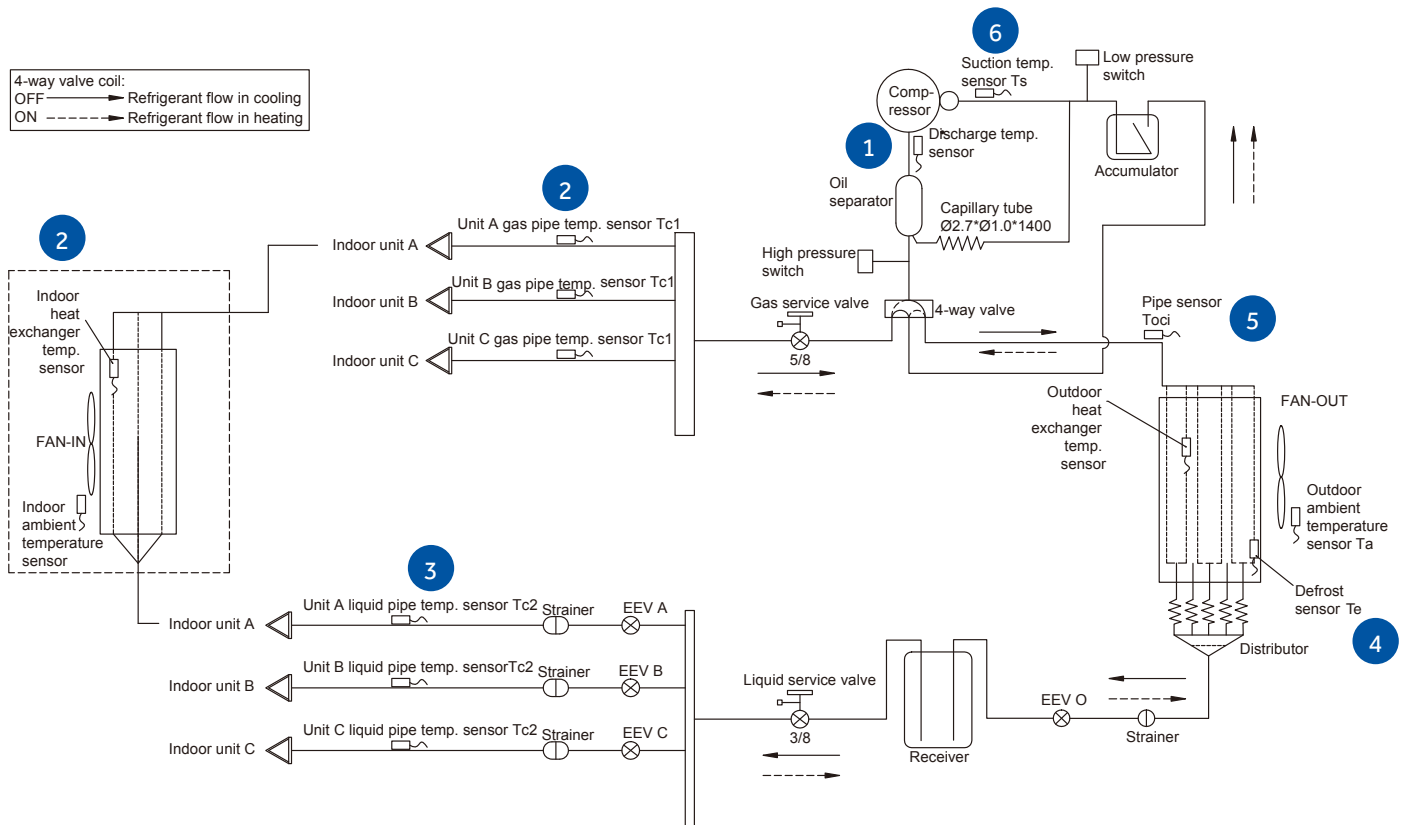

1 Temperature Sensor Td

The temperature of the compressor discharge hot gas will be monitored by the Discharge Temperature Sensor. If the sensor reads too hot or cool, the frequency/status of the operation will be adjusted as needed.

The hot gas will leave the oil separator and enter the 4-way valve. The 4-way valve will direct the hot gas to ALL of the indoor coils.

Note: Any indoor unit that is in heating mode will have its louver open and indoor fan running. Non-calling indoor units will receive hot gas but their fans will remain on very low speed with the louver open. When demand for heat increases, the indoor fan will speed up to meet the increased demand.

2 Temp. Sensor Tc1 & Indoor Heat Exchanger Temp. Sensor

The temperature of Tc1 should now be hot. This will indicate the 4-way valve is directing hot gas to the indoor coils. If it is not, there is a problem with the 4-way valve. The PCB will detect the temperature difference and generate an Error Code.

The indoor heat exchanger temperature sensor will monitor the temperature of the indoor coil to ensure it is hot enough to prevent blowing cold air. Once adequately warm temperature is sensed at the indoor coil, the PCB will increase the fan speed if needed to meet the demand.

The hot gas entering the indoor coil will condense into a saturated mix and then be subcooled. The refrigerant will return to the outdoor unit via the liquid line.

3 Temperature Sensor Tc2

This sensor monitors the temperature of the refrigerant liquid returning from the indoor coil. The indoor EEV opening angle is fixed.

The liquid will enter the Liquid Line Strainer and will pass through the OPEN EEV.

The refrigerant liquid now enters a receiver where excess refrigerant will store.

After the liquid leaves the Liquid Receiver, it will enter the restriction of the OUTDOOR UNIT's EEV, which changes the liquid refrigerant to a lower pressure and temperature as it enters the outdoor coil.

As the outdoor coil absorbs heat from the surrounding air, the very cold liquid refrigerant is changed to a cool vapor. This vapor travels through the 4-way valve to the accumulator.

4 Temperature Sensor Te

The outdoor coil temperature will be sensed by the Defrost Sensor. The sensor will use this temperature to adjust EEV open angle and to calculate when a defrost cycle is necessary.

5 Temperature Sensor Toci

This temperature sensor is now sensing the suction line temperature of the refrigerant vapor leaving the outdoor coil. This temperature is used to adjust the EEV open angle.

The vapor refrigerant will then enter the 4-way valve and be directed to the compressor suction accumulator. The accumulator will prevent any remaining liquid refrigerant from entering the compressor.

The vapor will exit the accumulator and enter the compressor. This cycle repeats until the demand for heating ends.

6 Temperature Sensor Ts

The temperature of the suction gas entering the compressor is monitored by the Suction Temperature Sensor.

As the demand becomes less while the indoor temperature rises toward the desired temperature, the compressor will reduce speed. When the set temperature is reached, the compressor and outdoor fan will shut off. The circulating fan of each indoor unit continues to run.

Defrost Cycle Sequence of Operation

ENGLISH

Multi:

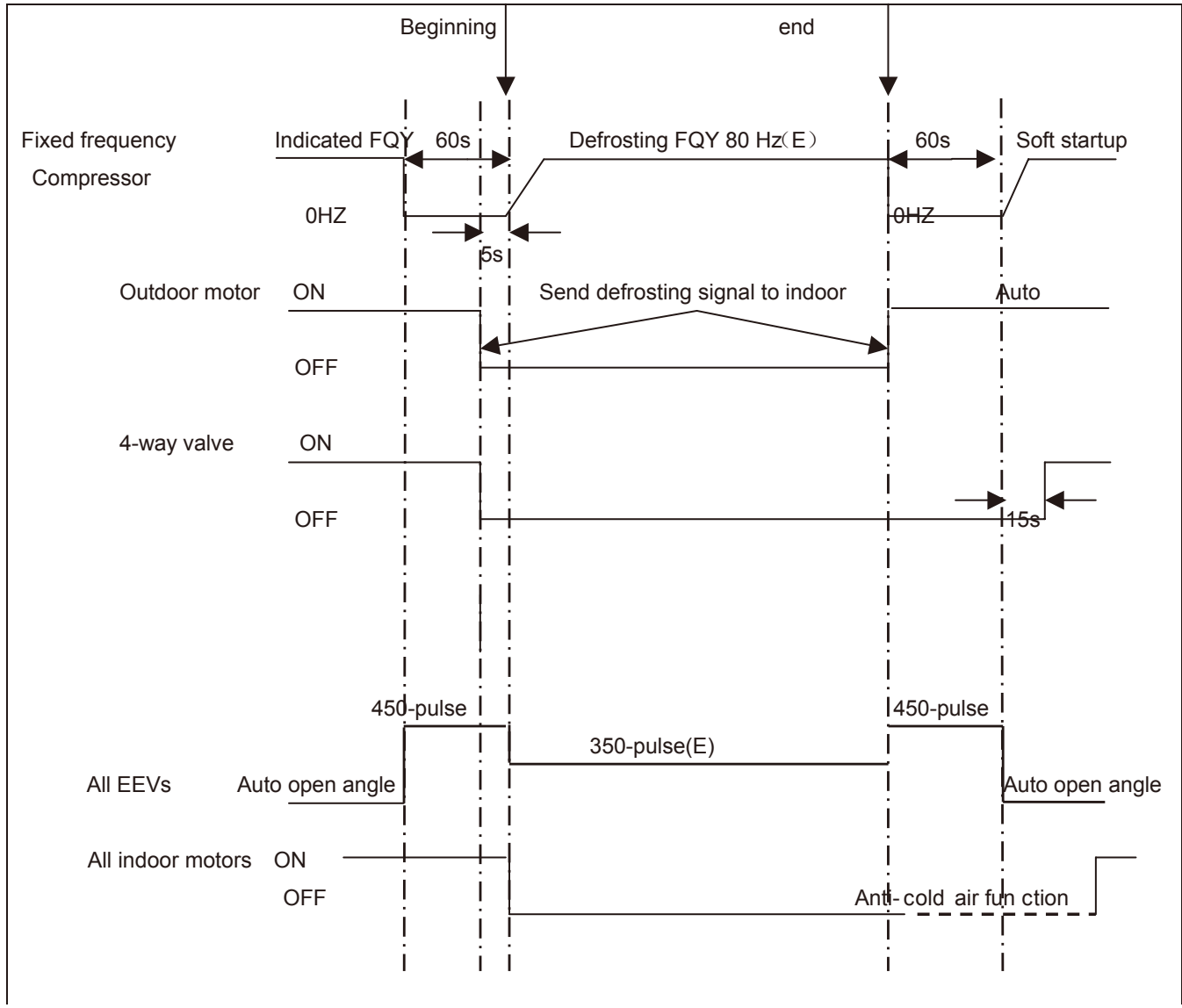

Electronic Expansion Valve (EEV) Control

Electronic characteristics

Max. open angle	480 pulses
Driving speed	PPS

Open angle limitation of EEV

	Unit stop	Max. open angle	Thermostat OFF	Min. open angle
Cool/ dry	5 pulses	480 pulses	5 pulses	80 pulses
Heat	5 pulses	480 pulses	50 pulses	80 pulses

The EEV routinely opens and closes to maintain the compressor discharge temperature within an acceptable range.

4-Way Valve Heating Control

When the compressor starts in the heating mode, there is a 1-minute delay before power is applied to the 4-way valve to switch the flow of hot refrigerant to the indoor coil. When the call for heat is satisfied and the compressor shuts off, a 3-minute delay will occur before the 4-way valve is powered down and switches back to the at-rest (cooling) position.

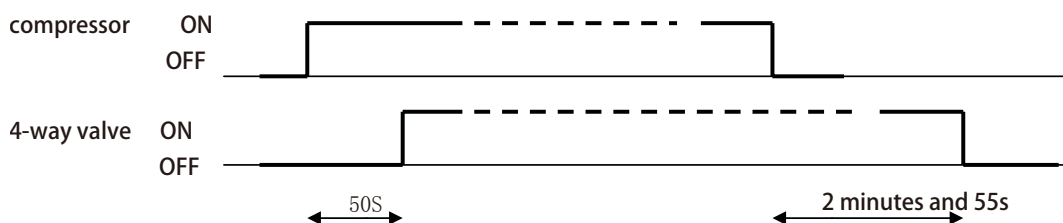

If the 4-way valve does not switch into the heating mode, after 15 minutes of compressor run time and the indoor coil temperature is below 41°F/5°C, the compressor will stop and the unit will display a 17-flash error code on the outdoor PCB.

Compressor Sump Heater

The sump (crankcase) heater keeps refrigerant at a higher temperature than the coldest part of the system. This prevents refrigerant from mixing with the compressor oil and also dries condensed refrigerant inside the sump. The sump heater will be energized when the ambient temperature is below 81°F/27°C and will be off when the ambient is 90°F/32°C.

	Heater OFF	Heater ON*min
$T_a > 50^\circ\text{F}(10^\circ\text{C})$ OR $T_d \geq 68^\circ\text{F}(20^\circ\text{C})$	0	0
$41^\circ\text{F}(5^\circ\text{C}) < T_a \leq 50^\circ\text{F}(10^\circ\text{C})$ and $T_d < 68^\circ\text{F}(20^\circ\text{C})$	50%*60min	50%*60min
$32^\circ\text{F}(0^\circ\text{C}) < T_a \leq 41^\circ\text{F}(5^\circ\text{C})$ and $T_d < 68^\circ\text{F}(20^\circ\text{C})$	33%*60min	66%*60min
$32^\circ\text{F}(0^\circ\text{C}) \geq T_a$ and $T_d < 68^\circ\text{F}(20^\circ\text{C})$	0	100%*60min

Defrost Control

In the heating mode and along with the ambient sensor, the defrost sensor monitors the temperature of the outdoor coil to determine if defrost is needed. If the compressor has been running for 10 minutes continuously and for 45 minutes overall, the difference between the ambient sensor (Ta) and the defrost sensor (Te) will be checked. The system will initiate the defrost cycle if the following conditions can be met for 5 continuous minutes:

$$Te \leq C \times Ta - A$$

Te: Defrost temperature sensor

Ta: Ambient temperature

C: 0.80 if Ta < 32°F/0°C, 0.60 if Ta ≥ 32°F/0°C

A: 8, moderate climate (factory setting). 6, severe climate (alternate setting)

End Defrosting:

If the defrost sensor (Te) detects the temperature of the outdoor coil is above 44°F(7°C) for 60 seconds or is above 54°F(12°C) for 30 seconds, the defrost cycle will terminate. If these temperatures cannot be reached, the defrost cycle will automatically terminate in 10 minutes.

Timed Defrost Option:

- When the outdoor ambient temperature sensor detects Ta is less than 32°F(0°C)
- In heating mode, compressor runs continuously for 60 minutes or for 240 minutes in all
- When the above conditions are met, the system will defrost. Defrosting frequency is 68 HZ, with a defrosting time of 8 minutes.

Base Pan Heater Control Logic

When the compressor starts in the heating mode, the following conditions will apply:

Outdoor Temperature	Pan Heater
>37°F(3°C)	OFF
28°F(-2°C) to 34°F(1°C)	OFF 20min. ON 10min.
10°F(-12°C) to 25°F(-4°C)	OFF 15min. ON 15min.
<10°F(-12°C)	ON

Troubleshooting the Base Pan Heater Error:

Step 1:

Check the pan heater for an open circuit or short circuit. Unplug the connector from main control PCB. Test the resistance between the two pins of the pan heater connector. It should be 0.28-0.379KΩ. If out of range, change the pan heater. If normal go step 2.

Step 2:

Check the main control board pan heater output port. Unplug the connector from main control PCB. Run the ODU with manually forced heating (Set the display board SW 1-1 as ON). Test the voltage between the two heater output pins, it should be 208-230Vac.

Discharge Sensor Protection

If the discharge temperature is higher than normal, the compressor will slow down to lower the temperature.

Multi:

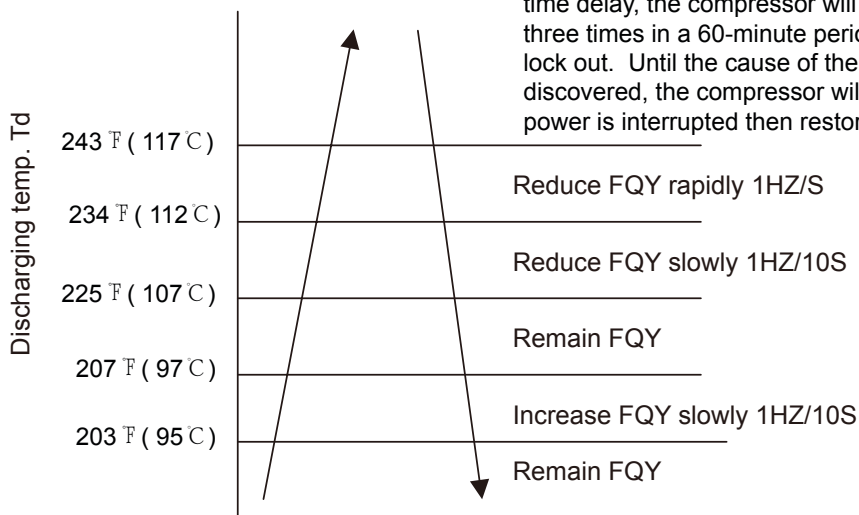

If the discharge temperature sensor reaches 243F for 10 seconds, the compressor will shut off. After the 3-minute time delay, the compressor will restart. If this occurs three times in a 60-minute period, the compressor will lock out. Until the cause of the high temperature is discovered, the compressor will not restart until the power is interrupted then restored.

High Current Protection

The below table is the outdoor unit protection current and compressor current.

Model	Maximum current (I)	Compressor current (CT)
2U20EH2VHA	12.5A	10A
3U24EH2VHA	13.5	14A
4U36EH2VHA	???	???

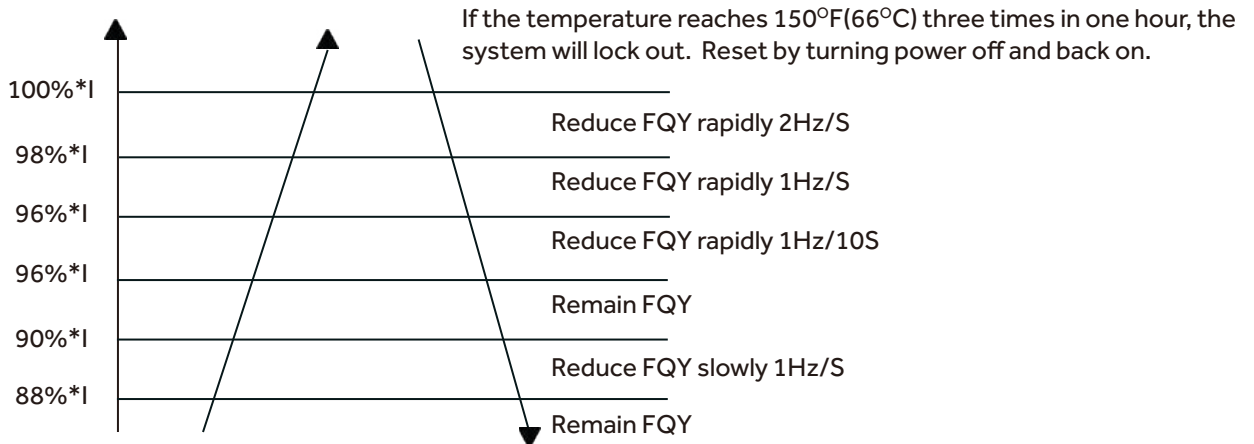

High Pressure Protection in Cooling

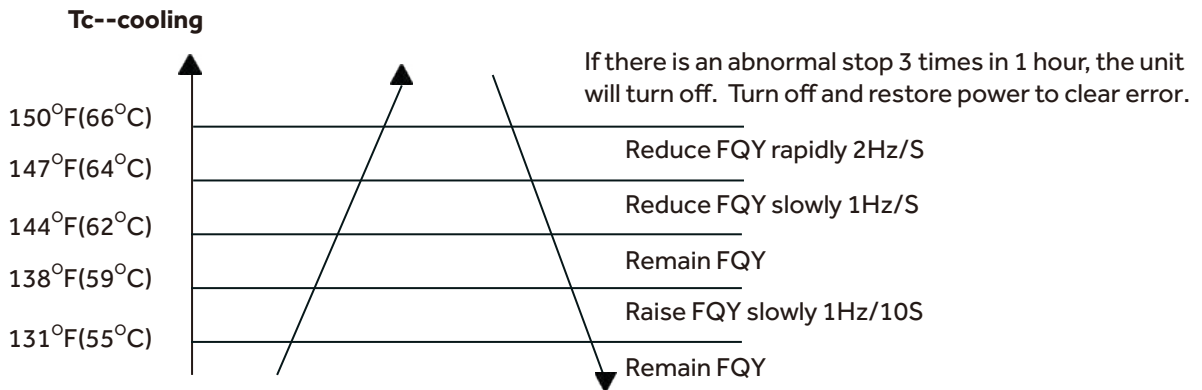

High Pressure Protection In Heating

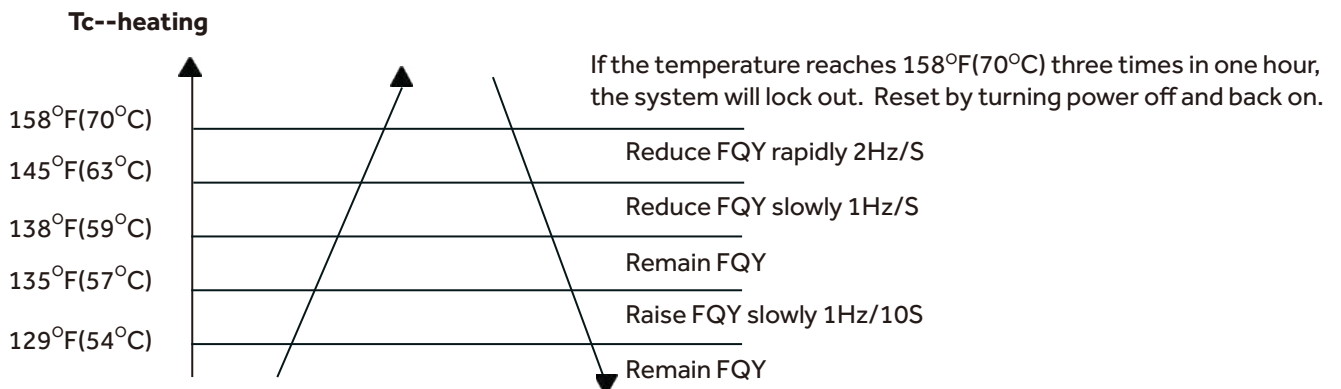

Low Pressure Protection

With the compressor running, if the low pressure switch opens for 1 minute, the compressor will stop.

If this condition occurs 3 times in an hour, the compressor will lock out and a low pressure error code will be displayed at the indoor unit.

If the compressor is not running and the switch opens for 30 seconds, a low pressure error code will be displayed.

The low pressure switch does not stop compressor operation or signal an error code during the following conditions:

- The first 8 minutes of run time when the compressor starts a new cycle
- During defrost
- When the ambient temperature is below 32°F/0°C
- Following the termination of an oil return cycle

When any of the above 4 conditions are present, low pressure protection is provided by the coil temperature sensors in both heating (Te) and cooling (Tc2) modes.

Low Pressure Protection in Cooling Mode:

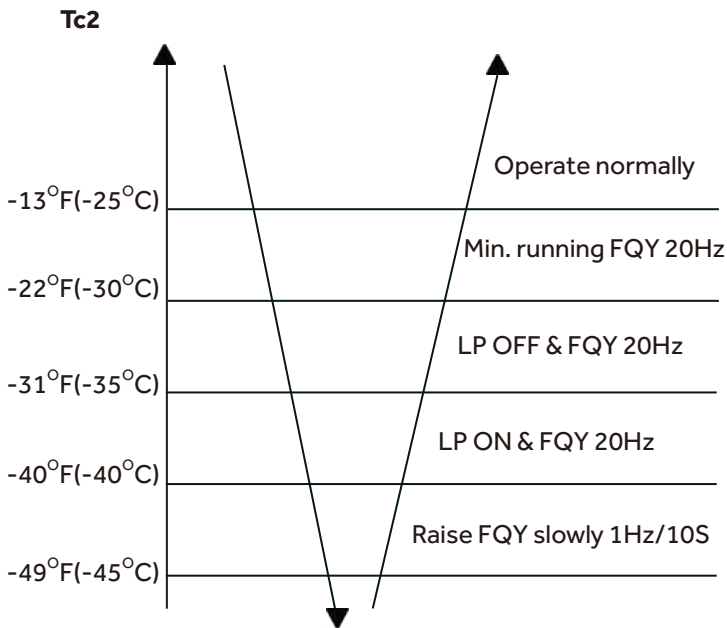

Low Pressure Protection in Heating Mode:

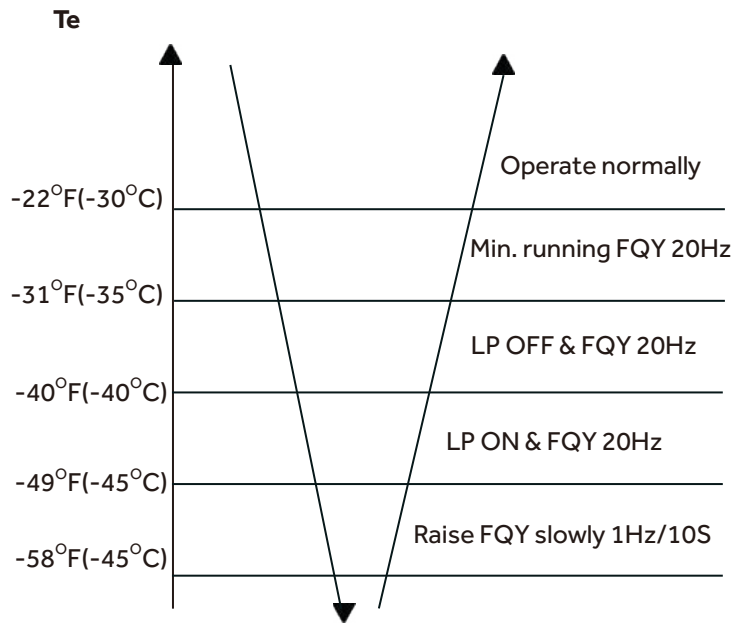

Oil Return Cycle

When the compressor is operating at low load conditions, or the operating frequency has been below 70Hz continuously for 4 hours, the system will enter the oil return cycle. This ensures that oil which may be trapped within the system at low loads will return to the compressor crankcase.

If a 4-hour low speed run time has occurred, the oil return procedure initiates by automatically ramping up the compressor speed to at least 85Hz for a pre-set time, up to a 9-minute maximum. The higher speed will wick hiding oil into the now faster-moving refrigerant and deposit it in the compressor crankcase. To avoid occupant discomfort when the oil return cycle is active, the indoor fan shuts off.

Should an error code result in a system shutdown, the oil return cycle timing will resume when the error code has been cleared.

Oil Return in Cooling Mode

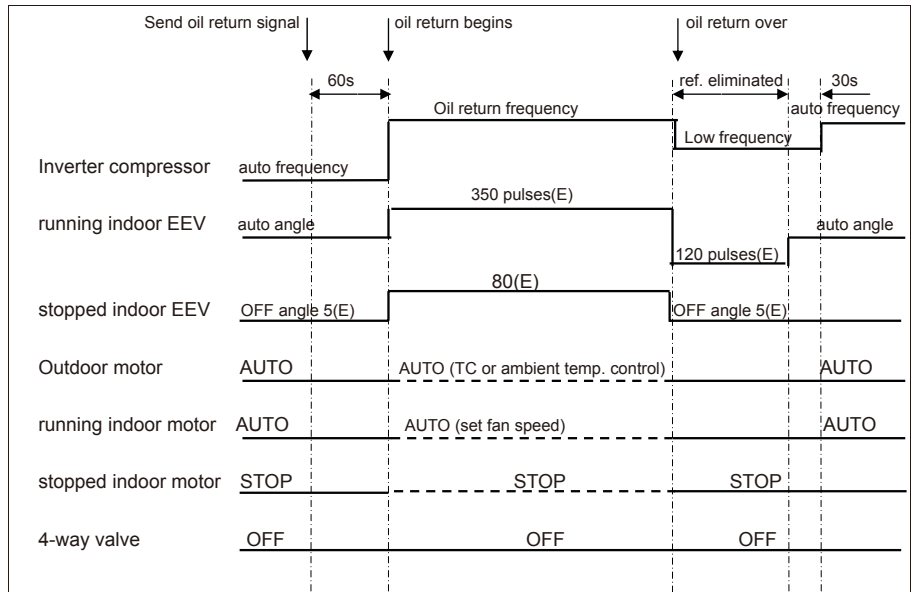

Oil Return Exit Conditions, Cooling:

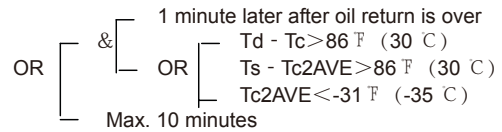

Oil Return in Heating Mode

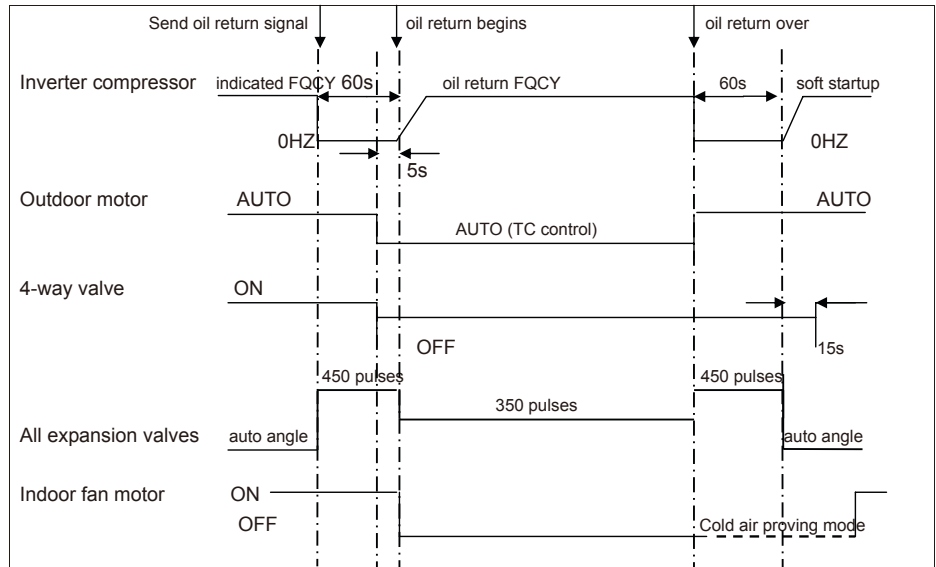

Oil Return Exit Conditions, Heating:

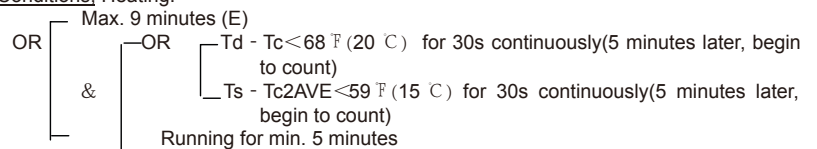

Outdoor Fan Motor

Check that the wiring and plug connections are in good condition.

If the outdoor unit fan motor does not run, or the Service Monitor Board indicates an error code of 09, check the following voltages at the motor connector on the outdoor unit PCB. Set the meter to read DC volts with a minimum voltage range of 350 volts. All voltage values are approximate. Initiate forced cooling.

1. DC voltage between the Red and Black wire connections should read 310 ~ 334 VDC. This is the main voltage for powering the fan motor.
2. DC voltage between the White and Black wire connections should read 15VDC. This is the voltage for powering the electronic circuit of the fan motor.
3. DC voltage between the Yellow and Black wire connections should read 4VDC. The voltage will read 0VDC when the fan is not being called to operate. This is the control voltage for regulating the speed of the fan motor.
4. DC voltage between the Blue and Black wire connections should read 8VDC. The voltage will read 14VDC when the fan is not being called to operate. (This is the feedback voltage to the PCB for determining the speed of the fan motor)

If the outdoor fan initially runs, increases speed then stops, and the Service Monitor Board indicates an error code of 09, the feedback circuit is not functioning. Check that the wiring and plug connections are in good condition.

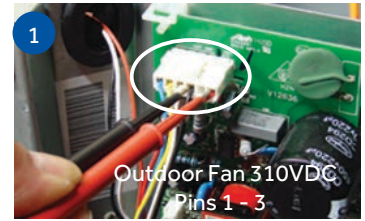
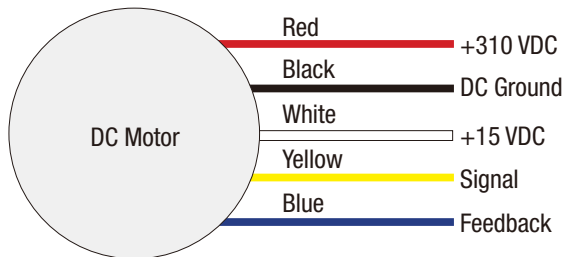

Temperature Sensor

The temperature sensors are negative coefficient thermistors, in which resistance decreases as temperature rises. Should the sensors fail, the PCB will generate an appropriate error code.

To check the calibration of the sensors:

1. Shut off power to the outdoor unit.
2. Disconnect the sensor at the circuit board plug.
3. Measure the temperature of the air surrounding the sensor.
4. Measure the electrical resistance of the sensor using needle probes. Do not force standard probes into the sensor plug.
5. Compare the measured resistance of the sensor against the resistance/temperature specifications (See chart in reference section)
6. If the sensor resistance is outside of the specification tolerances shown on the resistance/temperature table, replace the sensor.

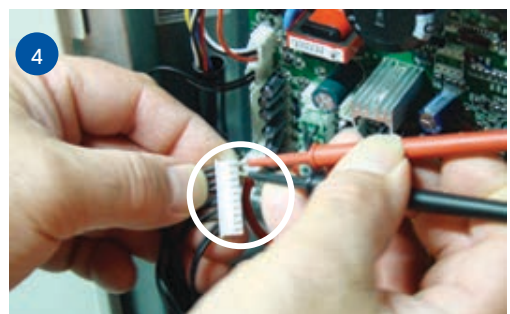
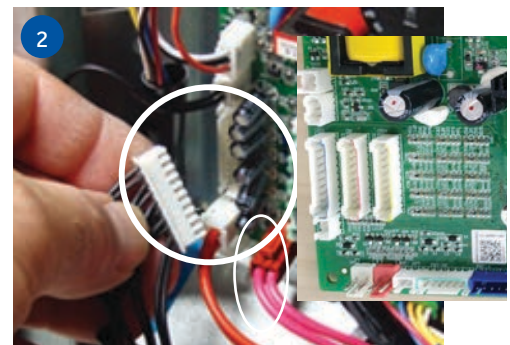

4-Way Valve

The 4-way valve will control the direction of hot gas discharge via an internal slide assembly. The valve has a line voltage solenoid that is energized in heat mode. The solenoid will direct the internal slide to send the hot gas to the indoor coil. During cooling mode de-energized operation, the internal slide will direct compressor hot gas to the outdoor coil.

4-way valves may have a failure of the electrical solenoid that prevents the valve from shifting, or they may become stuck due to debris lodging inside the valve body. If the valve fails to direct the hot gas in the proper direction, temperature sensors within the outdoor unit will detect the problem and generate an error code.



If the valve fails to shift the hot gas to the proper coil, or it only partially shifts, perform the following:

1. Check for correct refrigerant charge, and that all other operating parameters have been met.
2. In the heating mode, the solenoid will shift after a short time delay. Check for line voltage to the solenoid coil.
3. If the valve has voltage but fails to shift the hot gas to the indoor coil, shut the system down and unplug the 4-way valve from the PCB plug.
4. Use an ohmmeter to check continuity through the solenoid coil. The coil resistance should be 2.1k Ohms. If a winding shows open or shorted, the solenoid coil will have to be replaced.
5. If the coil resistance is within the tolerance, use a magnet along the valve body to determine the location of the piston. If one end of the piston is against the end of the valve body, it is stuck and the valve must be replaced.
6. Partial shifting of the valve can be detected by measuring the temperature of the suction gas where it enters the reversing valve and then comparing that temperature to the temperature of the suction gas exiting the 4-way valve. There should be no more than a 13°F difference. Excessive temperature rise through the suction gas path is an indication of a stuck piston. If the piston will not become free by switching from heating to cooling several times, a slight tapping on the valve body, or by using a powerful magnet, the valve will require replacement.

Electronic Expansion Valve (EEV)

1. Check to see if the Electronic expansion valve (EEV) connector is correctly and firmly inserted in the PCB.
2. Turn the power off and back on again,
3. Check to see whether the EEV have a reposition sound. This sound will start after approx 2 min. If the EEV doesn't have noise, please disconnect the connector and check the resistance (refer to resistance tables below).
4. If the resistance is OK, The PCB may be at fault.

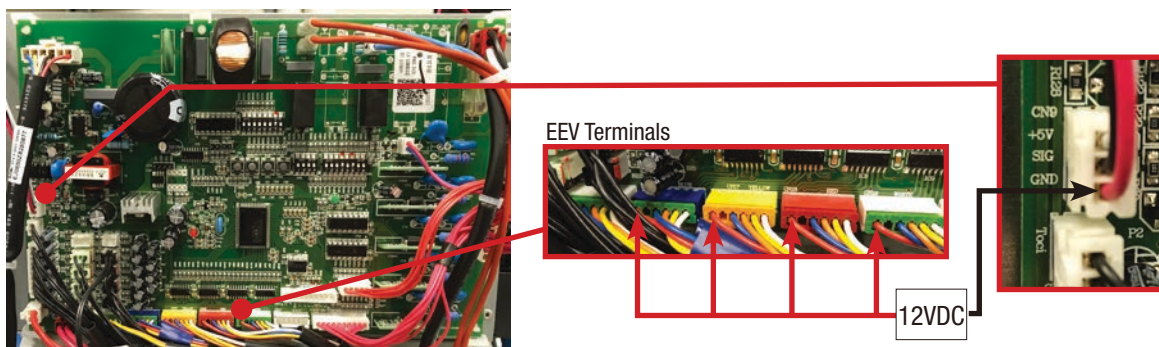

EEV (6-pin, 5 wire)

	White	Yellow	Orange	Blue	X	Red
White	-	92 Ω	92 Ω	92 Ω	-	46 Ω
Yellow	-	-	92 Ω	92 Ω	-	46 Ω
Orange	-	-	-	92 Ω	-	46 Ω
Blue	-	-	-	-	-	46 Ω
X	-	-	-	-	-	-
Red	-	-	-	-	-	-

EEV (6-pin, 6 wire)

	White	Yellow	Orange	Blue	Brown	Red
White	-	OL	92 Ω	OL	46 Ω	OL
Yellow	-	-	OL	92 Ω	OL	46 Ω
Orange	-	-	-	OL	46 Ω	OL
Blue	-	-	-	-	OL	46 Ω
Brown	-	-	-	-	-	OL
Red	-	-	-	-	-	-

Variable Speed Compressor

1. Begin by turning off power at the equipment disconnect switch. Adequate time must be given for capacitors on the circuit board to discharge. Wait a minimum of 12 minutes before handling the circuitry.
2. Locate the Inverter control module (IPM). The IPM is connected to the main circuit board by a wire harnesses, and has the compressor connections mounted on it.
3. Set your test meter to AC volts and test for voltage at the three compressor connections. Voltage should be zero before proceeding.
4. Remove the three compressor connections making note of the terminal letter and the wire colors.
5. Set your ohm meter to the lowest resistance setting that is available. Test all three connections terminals using the following sequence:

- U terminal to V terminal
- U terminal to W terminal
- V terminal to W terminal

All three resistance values should match the specification table below. Compressor windings are deemed bad if they are greater than 7% out of specification. Readings taken at the wire IPM module that are outside of factory tolerances require steps 6 through 9.

6. Remove the compressor blanket and set it aside. Remove the terminal block cover to expose the connections at the compressor terminals. Inspect for any visual damage. Remove all three wires from the terminals making note of the wire color and the terminal identifier.
7. Repeat process outlined in step 5. Repair or replace the wires if the compressor windings check properly.
8. Check each terminal to ground (suction line connection at compressor) to check for grounded windings if the resistance values are not correct.
9. Replace the compressor if the winding measurements are greater than 7% out of specification.

Wiring Error Check

1. Disconnect power to the outdoor unit.
2. Set Dip Switches SW1-1, SW1-2, SW1-3 & SW1-4 to the ON position. These dip switches are located on the Service Monitor Board.
3. Turn ON power to the outdoor unit.
4. All indoor fans will be set to HIGH fan speed.
5. EEV for Circuit A will open. All other EEV's will close.
6. After a 3 minute delay, the Compressor will start and ramp up to 55HZ.
7. The digital display will alternately display "CH" and "Compressor Frequency (HZ)" at 5 second intervals

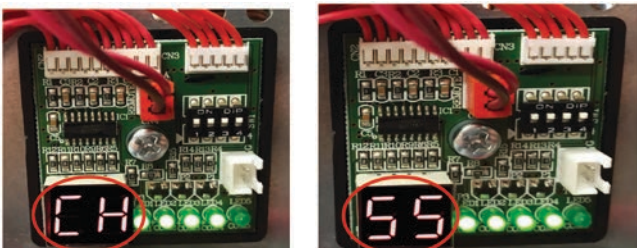
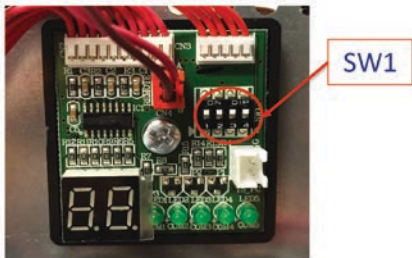

8. The system will circulate refrigerant through Circuit A for approximately 10 minutes.
9. Afterwards, Circuit A's EEV will close and Circuit B's EVV will open.
10. This process will be repeated for each indoor unit that is connected.

11. Once all indoor units have been checked, the digital display will display either "EC" or "0". "EC" indicates a communication error between the outdoor and indoor unit. The LED(s) will be flashing, indicating which circuit has the fault



12. Once the wiring is corrected, re-run this test to confirm everything is functional.
13. "0" indicates that all wiring is correct.

14. If all wiring is correct, the LED's remain solid lit.
15. Once the test is complete, make sure to change the dip switches back to the OFF position, and set each indoor unit to preferred set points.

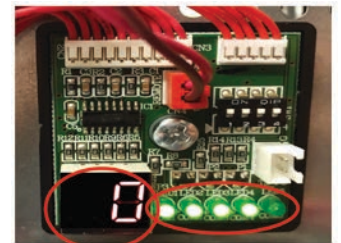

2U20EH2VHA

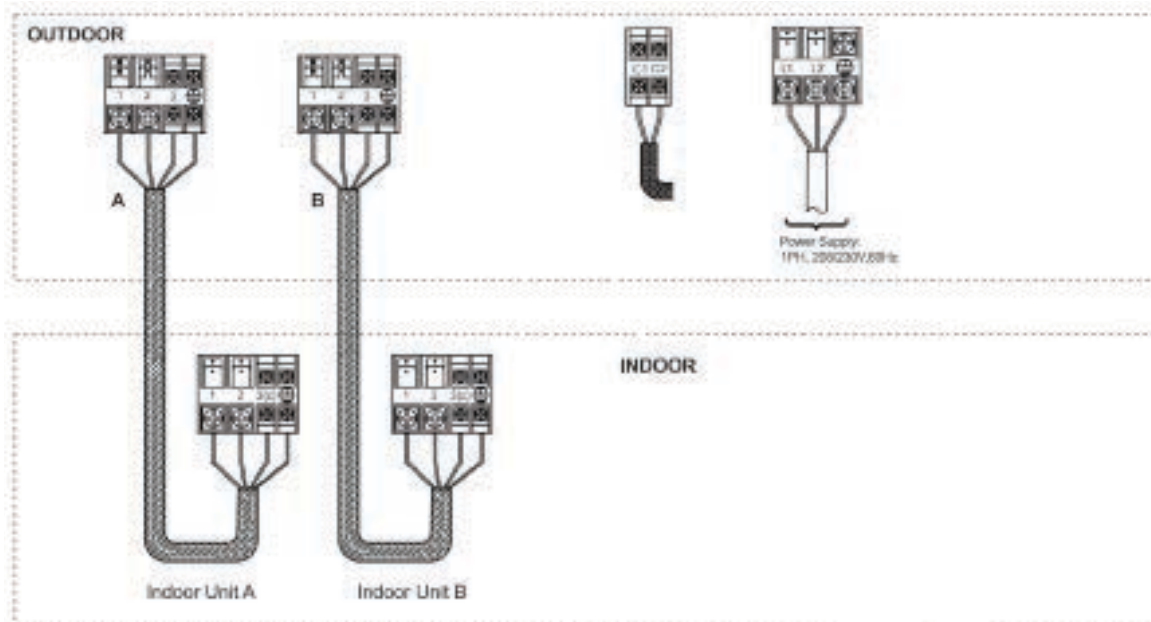
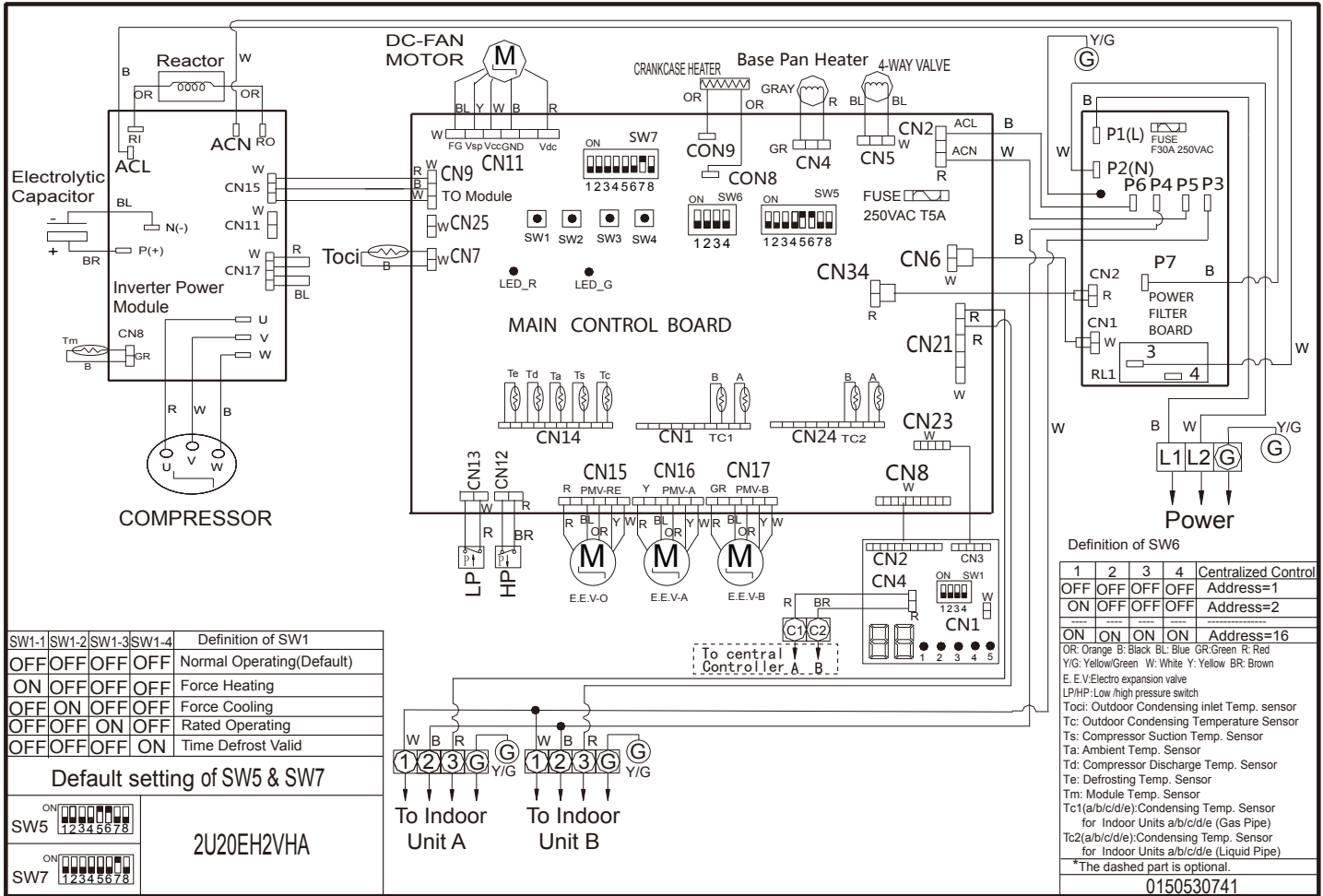

Power Supply Cable
 Connecting Cable: 14/4 AWG stranded copper

Connect the connecting wires between indoor and outdoor units and ensure the sequence numbers on terminals match with each other.

3U24EH2VHA

ENGLISH

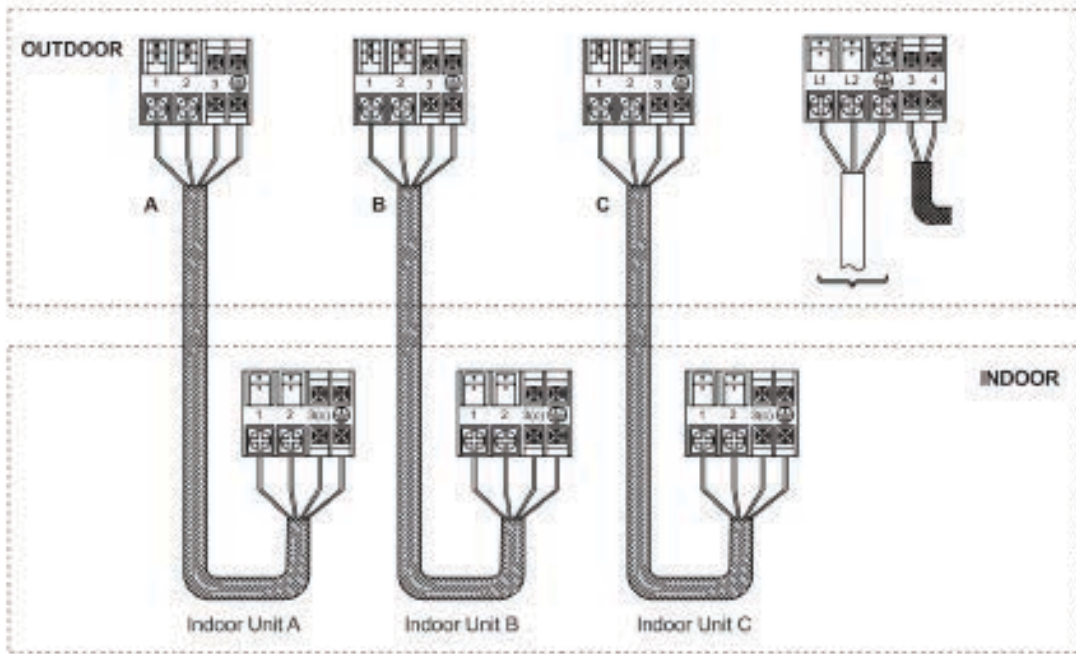
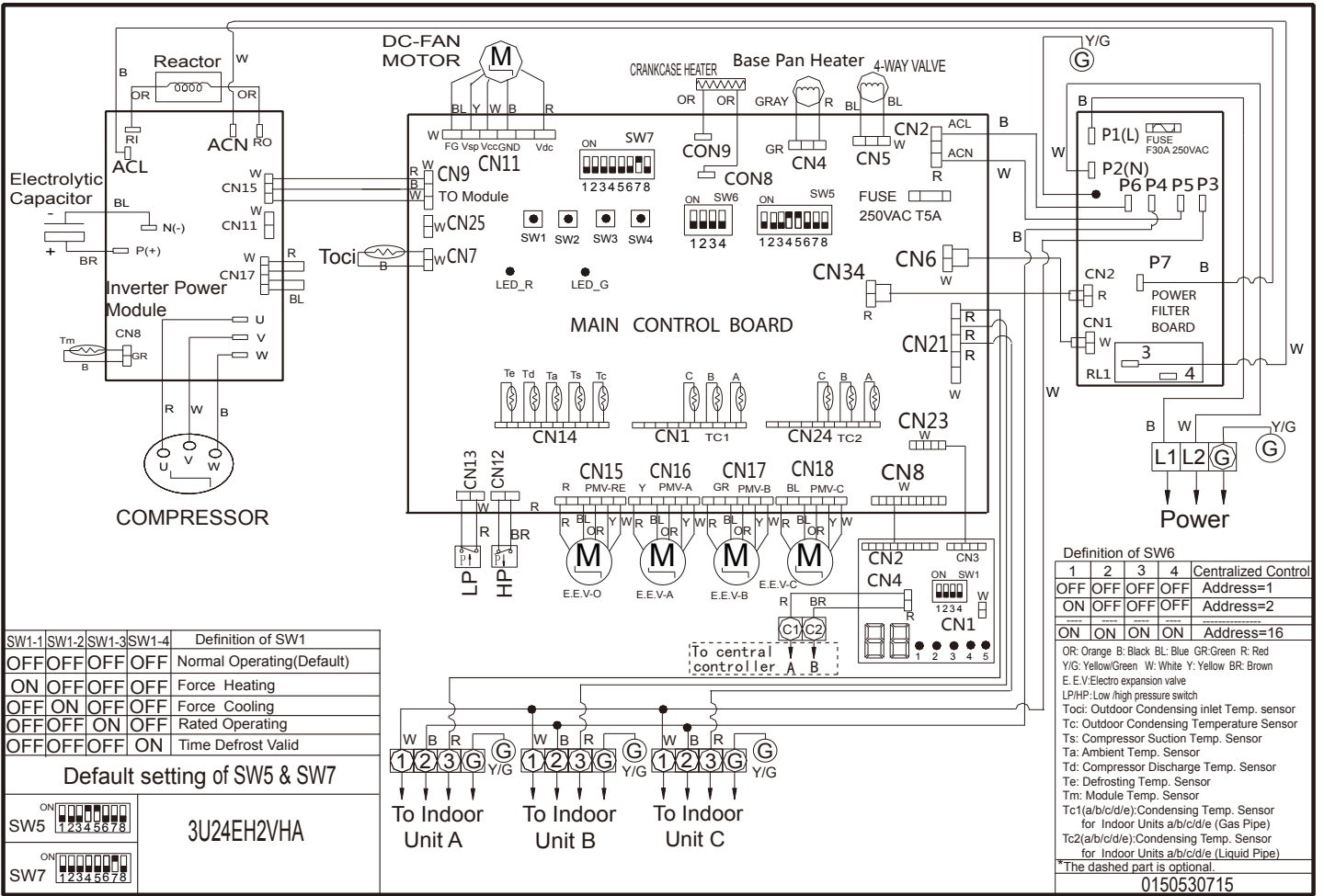

Power Supply Cable
 Connecting Cable: 14/4 AWG stranded copper

Connect the connecting wires between indoor and outdoor units and ensure the sequence numbers on terminals match with each other.

4U36EH2VHA

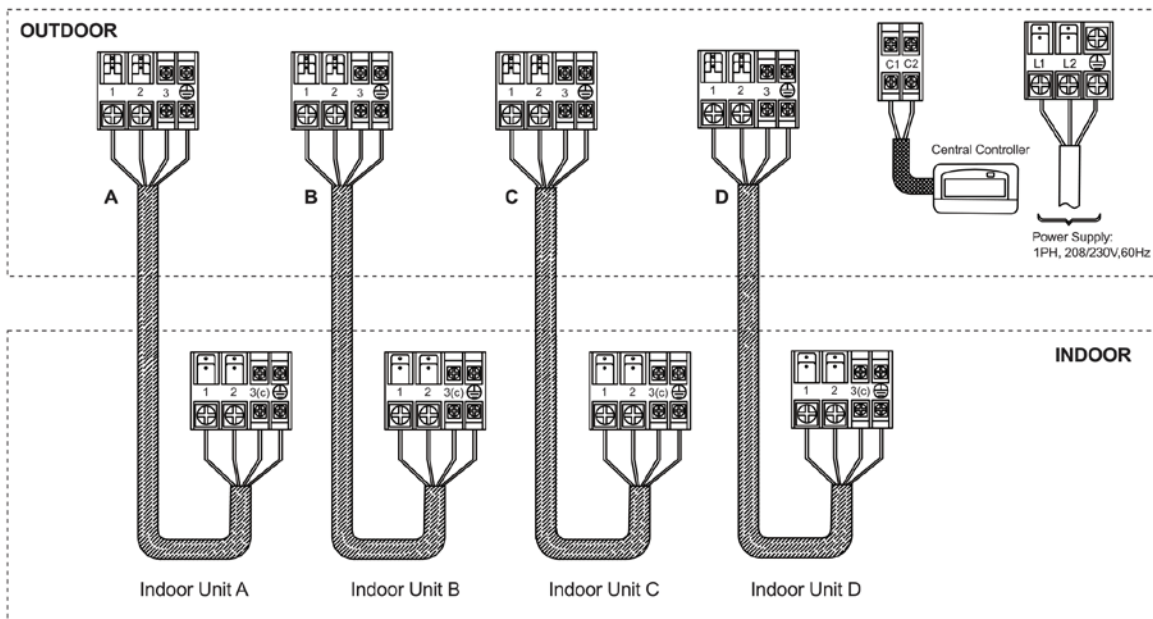
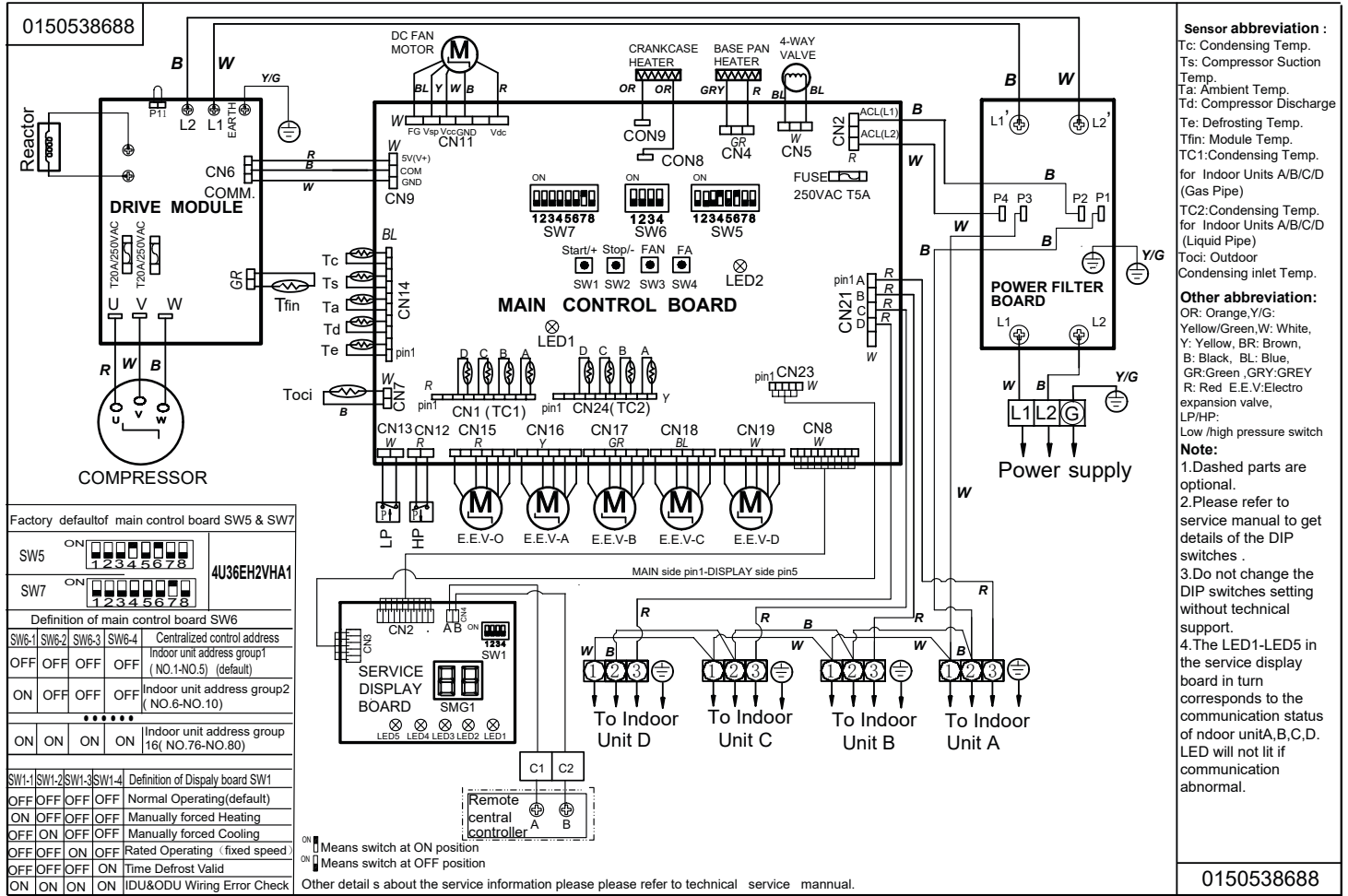

- Power Supply Cable: 10AWG
- Connecting Cable: 14AWG
- Connecting Cable: 14AWG

Connect the connecting wires between indoor and outdoor units and ensure the sequence numbers on terminals match with each other.

DIP Switch Settings

WJ26X25053 - Outdoor Power Control Board DIP Switch Settings

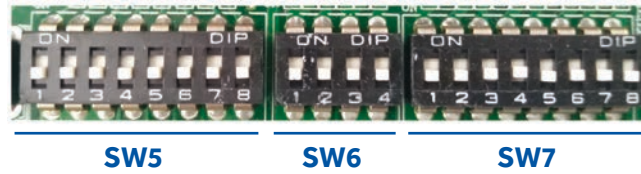
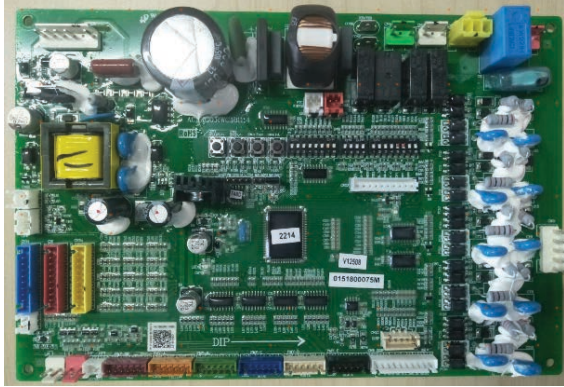

SW5 DIP Switch Settings

Description	SW5-1	SW5-2	SW5-3	SW5-4	SW5-5	SW5-6	SW5-7	SW5-8
Heat pump	OFF*	----	----	----	----	----	----	----
Cooling only	ON	----	----	----	----	----	----	----
Defrost temp. selection (used for mild weather defrost)	----	OFF*	----	----	----	----	----	----
Defrost temp. selection (used for severe weather defrost)	----	ON	----	----	----	----	----	----
Power input restrict invalid	----	----	OFF*	----	----	----	----	----
Power input restrict valid	----	----	ON	----	----	----	----	----
2U20EH2VHA	----	----	----	OFF	ON	ON	----	----
3U24EH2VHA	----	----	----	ON	ON	OFF	----	----
Factory use only	----	----	----	----	----	----	OFF*	----
Factory use only	----	----	----	----	----	----	ON	----
Quiet operation valid	----	----	----	----	----	----	----	OFF*
Quiet operation invalid	----	----	----	----	----	----	----	ON

*Factory Default Setting

Note:

1. Power input restrict selection: OFF-invalid; ON-valid($\leq 3500W$)
2. Quiet operation: If OFF, the outdoor unit will calculate and obtain the average ambient temperature of the unit within the last 24 hours, Tao_average_24. Then compare the current ambient temperature with the ambient temperature average Tao_average_24, and combine it with the previous ambient temperature trend to determine whether it can enter Quiet operation (low compressor speed and low O.D. fan speed).

DIP Switch Settings

SW6 DIP Switch Settings

Outdoor central control address settings

Outdoor Central Control Address	SW6-1	SW6-2	SW6-3	SW6-4
0	OFF	OFF	OFF	OFF
1	OFF	OFF	OFF	ON
2	OFF	OFF	ON	OFF
3	OFF	OFF	ON	ON
4	OFF	ON	OFF	OFF
5	OFF	ON	OFF	ON
6	OFF	ON	ON	OFF
7	OFF	ON	ON	ON
8	ON	OFF	OFF	OFF
9	ON	OFF	OFF	ON
10	ON	OFF	ON	OFF
11	ON	OFF	ON	ON
12	ON	ON	OFF	OFF
13	ON	ON	OFF	ON
14	ON	ON	ON	OFF
15	ON	ON	ON	ON

SW7 DIP Switch Settings

Description	SW7-1	SW7-2	SW7-3	SW7-4	SW7-5	SW7-6	SW7-7	SW7-8
USA energy efficiency test mode for High Wall unit	OFF*	OFF*	----	----	----	----	----	----
USA energy efficiency test mode for Duct unit	ON	OFF	----	----	----	----	----	----
Reserved	----		OFF*	----	----	----	----	----
Reserved	----	----	----	OFF*	----	----	----	----
Reserved	----	----	----	----	OFF*	----	----	----
Reserved	----	----	----	----	----	OFF*	----	----
North American region	----	----	----	----	----	----	ON*	----
Non-North American region	----	----	----	----	----	----	OFF	----
Quiet operation valid	----	----	----	----	----	----	----	OFF*

*Factory Default Setting

WJ26X25054 - Service Monitor Board DIP Switch Settings

SW1 DIP Switch Settings

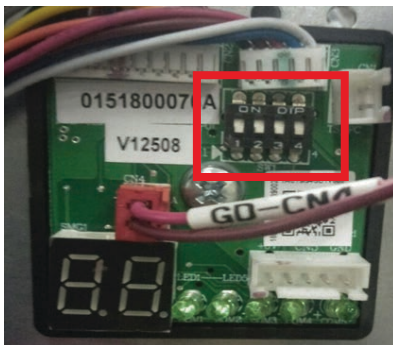

Definition	SW1-1	SW1-2	SW1-3	SW1-4
Factory default	OFF	OFF	OFF	OFF
Forced heating	ON	OFF	OFF	OFF
Forced cooling	OFF	ON	OFF	OFF
Rated operation	OFF	OFF	ON	OFF
Time defrost valid: Defrost initiates if needed when the compressor has been on for 10 minutes continuously and 50 minutes cumulative. Termination conditions are the same as demand defrost.	OFF	OFF	OFF	ON
Wiring check active*	ON	ON	ON	ON

*See page B-18 for Wiring Error Check.

LED Error Code	Diagnosis
1	Outdoor EEPROM failure
2	IPM overcurrent or short circuit
4	Communication failure between the IPM and outdoor PCB
5	Module operated overload (compressor overload protection)
6	Module low or high voltage
8	Overheat protection for discharge temperature
9	Malfunction of the DC fan motor
10	Malfunction of defrost temperature sensor
11	Suction temperature sensor failure
12	Ambient temperature sensor failure
13	Discharge temperature sensor failure
15	Communication failure between the indoor & outdoor unit
16	Lack of refrigerant or discharging
17	4-way valve switching failure
18	Loss of synchronism detection
20	Indoor thermal overload
21	Indoor unit overload protection, heating mode only.
21	Indoor coil frosted
23	Module thermal overload
24	Compressor start failure, over-current
25	Phase current protection (IPM)
26	MCU reset
27	Module current detect circuit malfunction
28	Liquid pipe sensor failure: Circuit A
29	Liquid pipe sensor failure: Circuit B
30	Liquid pipe sensor failure: Circuit C
31	Liquid pipe sensor failure: Circuit D
32	Gas pipe sensor failure: Circuit A
33	Gas pipe sensor failure: Circuit B
34	Gas pipe sensor failure: Circuit C
35	Gas pipe sensor failure: Circuit D
36	Gas pipe sensor failure: Circuit E
38	Malfunction of module temperature sensor momentary power failure detection
39	Malfunction of condensing temperature sensor
40	Liquid pipe sensor failure: Circuit E
41	Toci temperature sensor failure
42	High Pressure switch open
43	Low Pressure switch open
44	System high pressure protection: Overcharged, high condensing temperature or malfunction of fan motor.
45	System low pressure protection: Undercharged, low defrosting temperature, or malfunction of fan motor.
L0	OAT less than -22°F (-30°C)

Precautions For Adding Refrigerant

1. This system must use refrigerant R410A.
2. Add refrigerant 0.20 oz/ft per meter when the total piping length exceeds the standard value.
3. The total liquid piping length must be less than the max value.

Outdoor Unit	Std. Value	Max Value
2U20EH2VHA	30m/100ft.	50m/164ft.
3U24EH2VHA	30m/100ft.	60m/197ft.
4U36EH2VHA	40m/131ft.	70m/230ft.

Notes:

1. No addressing is necessary. All indoor wiring connections must match the outdoor connections, or a communication failure will result.
2. Set SW5-8 to ON for Quiet Operation if desired. Maximum capacity may be slightly reduced.
3. Do not change any switch settings unless directed to do so.

* PCB: Printed Circuit Board

* IPM: Inverter Power Module

* EEV: Electronic Expansion Valve



AW07EH2VHA
 AW09EH2VHA
 AW12EH2VHA
 AW18EH2VHA
 AW07LC2VHB
 AW09LC2VHB
 AW12LC2VHB
 AW18LC2VHB
 AW24LP2VHA

Table of Contents

Components **C-2**
 Component Overview C-2
 Indoor Wall Mount Unit Circuit Board C-3
Testing **C-5**
 Accessing Components/Removing Cover C-5
 Indoor Fan Motor Voltage Check C-6
 Replacing the Blower Motor C-6
 Testing Temperature Sensors C-8
 Testing Louver Motors C-8
 Testing Communication Circuit C-8
Wiring Diagram **C-9**
Error Codes **C-10**

The wall mounted units act as evaporator coils during cooling mode and condenser coils during heating mode. These units have gravity condensate drain systems. If a condensate pump is needed, it must be field provided and mounted external to the indoor unit.

Component Overview

The wall mount unit is shipped with a wireless controller.

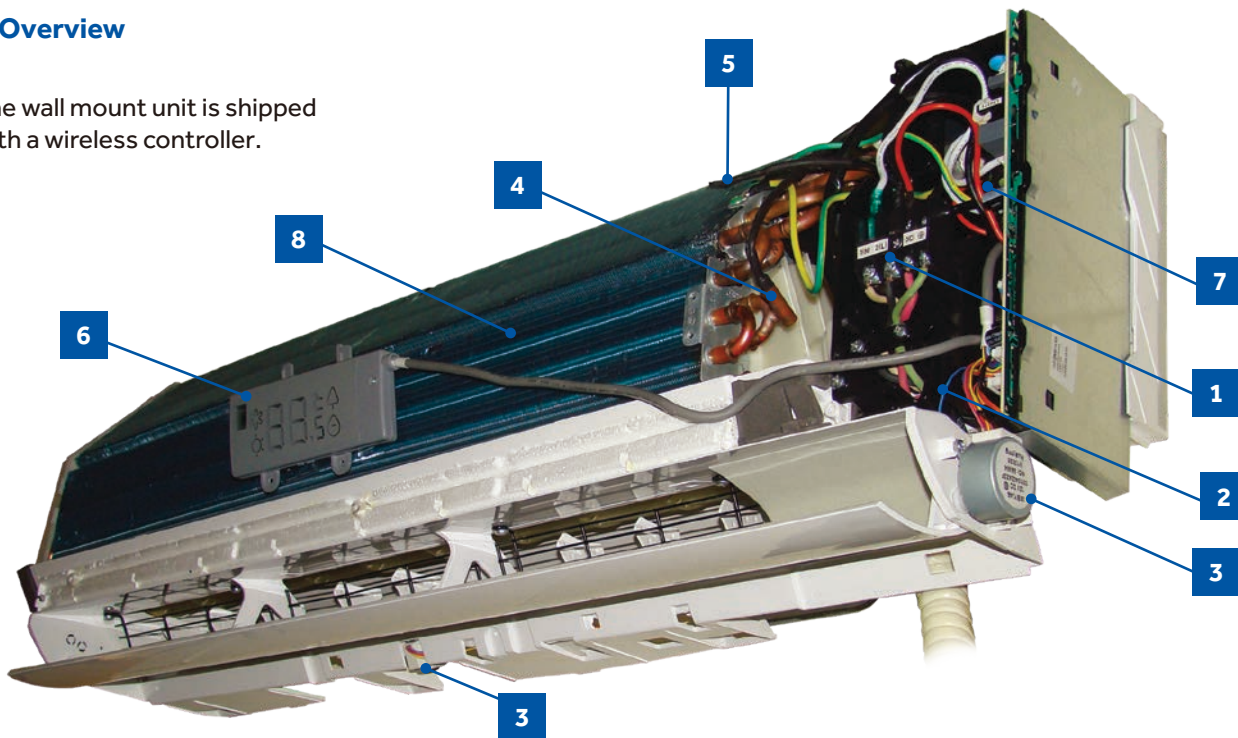

1 Terminal Block

Power to operate the indoor unit comes from the electrical line voltage terminal block at the outdoor unit. The wiring includes 4 wires: 1, 2, 3 and ground. Wires 1 and 3 complete the data path. These wires should always be 14 gauge AWG Stranded type wire. Splices in wires 1 or 3 may cause communication errors.

2 Blower Assembly

The blower assembly consists of a plastic blower wheel that is connected to a variable speed indoor blower motor. A set screw holds the blower wheel to the blower motor.

The indoor blower motor is a DC Fan Motor that is connected to the indoor unit control board. The wiring from the motor to indoor board consists of 5 wires connected to pins 1, 4, 5, 6 and 7. Pin 1 should have 310 VDC. Pin 4 is ground. Pin 5 +15VDC. Pin 6 is the feedback signal. Pin 7 is the speed control.

During normal operation, the indoor control board will energize the indoor blower motor and request proper speed. The indoor blower motor will control the speed via a command at the Pin 7 speed control. Proper fan speed is verified by the indoor control board via the voltage level at the feedback signal on Pin 6. Should the feedback signal not be present during a call for indoor blower, the indoor control board will indicate a Malfunction Code E14.

3 Louver Stepper Motors

Separate motors located in the indoor unit control the operation of the motorized louvers. All of the louver motors are controlled via commands received from the remote control. The blower motor is controlled by both the remote control and by commands from the outdoor unit ECU.

4 Pipe Temperature Sensor

The Piping Temperature Sensor senses indoor coil temperature in the cooling mode and in the heating mode. This sensor is used for Anti Freezing and Anti Cold Blow cycles. The sensor also provides critical temperature information to the ECU that may be used in frequency adjustments.

5 Ambient Temperature Sensor

The ambient air sensor senses the temperature of the air being drawn into the wall mounted unit from the conditioned space. This sensor provides room temperature information to the ECU for calculation of inverter capacity and temperature control.

6 Display

The indoor unit has a display that communicates system mode, room temperature and diagnostic code information. The diagnostic code information shown on the indoor unit will NOT be the same code that is displayed on the outdoor unit. When servicing a diagnostic error, compare the indoor unit code to the outdoor unit code to make diagnostic decisions. Codes that relate to outdoor unit problems should use the outdoor unit display information as priority.

7 Control Board

The indoor unit circuit board controls the switching functions of the indoor unit. All control decisions are made by the outdoor unit ECU. The indoor board has some limited diagnostic capability which will be covered in this manual.

8 Evaporator Coil

Indoor Wall Mount Unit Circuit Board

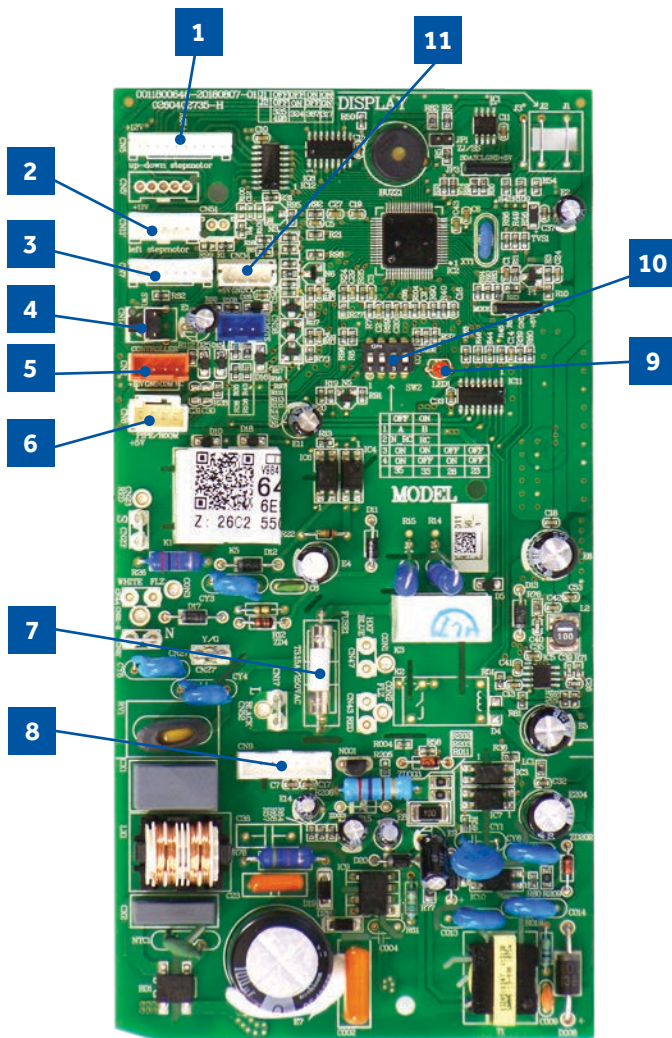

- | | |
|--------------------------------|-------------------------------|
| 1 Up/Down Stepper Motor | 7 15A/250VAC Fuse |
| 2 Left Stepper Motor | 8 DC Fan Motor |
| 3 Display Board | 9 LED |
| 4 Emergency Switch | 10 DIP Switch Bank SW2 |
| 5 Wired Controller | 11 WiFi |
| 6 Temperature Sensors | |

The Indoor Unit Circuit Board communicates with the outdoor unit ECU via a connection at Terminal Block screw 3.

The data pulse that sends the communication information can be measured with a voltmeter placed to DCV range. From the ground connection at the Terminal Block to the Number 3 screw connection, the voltage should pulse up and down when data is being transmitted.

This control board has control over the fan louver movement, manual fan blower control, indoor coil temperature and indoor air temperature sensing functions. All operational decisions are controlled by the OUTDOOR UNIT ECU. The connections on the indoor board are shown here in the schematic drawing.

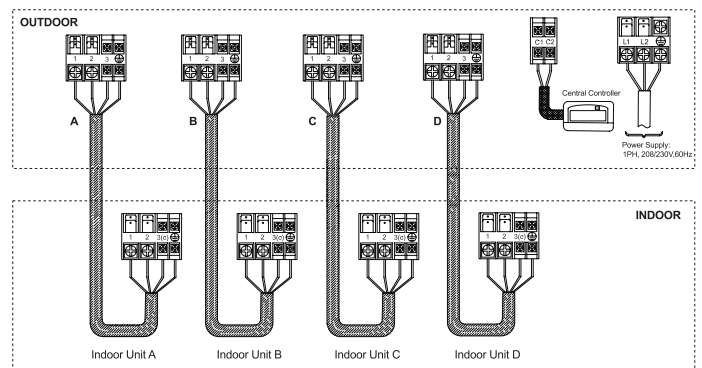

Line voltage to power the indoor unit comes in on Terminal Block connections 1 and 2. Power connects from these terminal connections on the circuit board. If the board does not respond to commands and has no display, check for line voltage at these connections. When power is present at the indoor board, the RED LED on the circuit board will blink a 2 flash code.

The control board has a replaceable 3.15A 250V fuse that protects against excessive current. If power is present at the board but the board does not work, check for continuity through the fuse. Replace if the fuse is open.

The indoor unit temperature sensors are connected to the control board. When testing the calibration of these sensors, the wires can be released from the plug by pressing on the tension tab on the side of the plug.

The receiver/display unit that is mounted to the front cover of the indoor unit plugs into the control board.

There are two to three motors connected to the control board that control the movement of the louvers right, left and up/down. Some units will use one motor to operate the right and left movement function.

The blower motor is connected to the circuit board.

There is an Emergency Run switch on the edge of the indoor board that will put the system into Auto Mode should the remote control break or be lost. When this switch is pressed and held for 5 seconds, the indoor unit display will beep twice and the system will enter TEST MODE.



Accessing Components/Removing Cover

1. To access components for service, first disconnect power to the outdoor unit. This will de-energize the indoor unit.
2. Lift the front cover by prying on the two indented finger holds at each end of the indoor unit.



3. Remove the three Phillips head screws located near the bottom of the indoor unit. These screws are located directly below the bottom of the air filter.



4. Remove the filters.

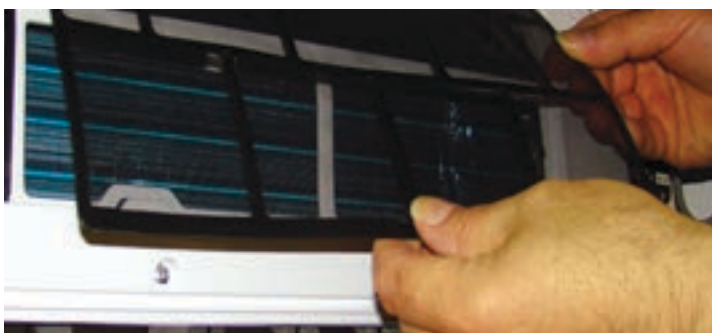

5. Manually open the louver.



6. Open the 3 caps that cover the screws located behind the bottom of the louver. These caps flip up.



7. Remove the three screws located behind the caps.

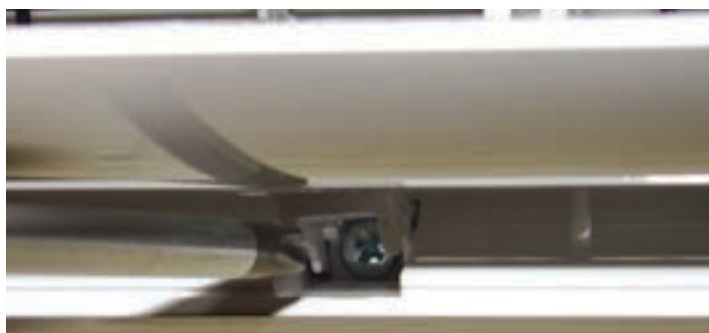

8. Remove the two screws that hold the digital display to the front cover. The display can hang free.



9. Release the air temperature sensor from the clip that holds it.



10. Pull upward on the top of the indoor unit cover to free it from the four retaining clips. The cover will pivot downward. The cover should now pull away from the indoor unit.

Indoor Fan Motor Voltage Check

If The Indoor Fan Motor Does Not Run:

1. Remove the front cover and access the circuit board fan motor connection.
2. Reset power and turn the remote control fan command to Fan On mode.

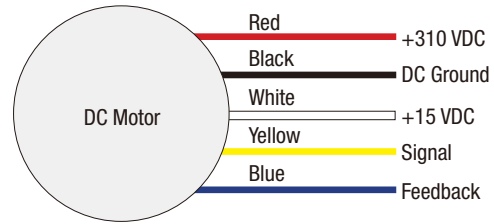

Motor Test:

1. If the motor doesn't run, check for 310VDC between Pins 1 and 3. If it is not present, the indoor board is bad. If voltage is present, continue on.
2. Check the voltage between Pins 3 and 4. The voltage should be +15VDC. If it is not present, the board is bad. If voltage is present, continue on.
3. Check for voltage between Pins 3 and 6. If no DC voltage is present, the board is bad. If voltage is present, change the motor.

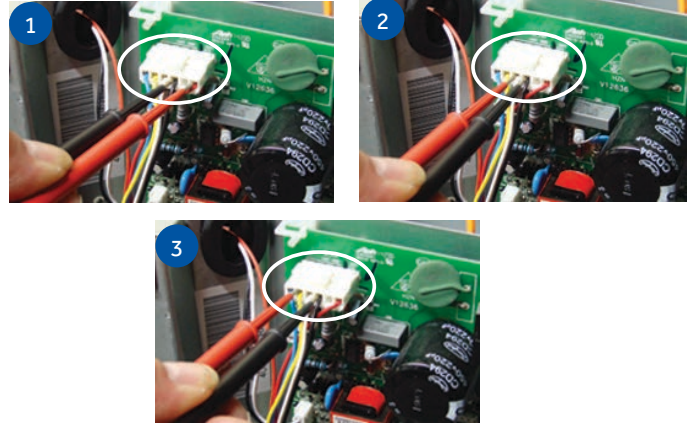

Replacing the Blower Motor

1. Disconnect the power.
2. With the indoor unit cover removed, remove the two screws on the left plastic evaporator coil bracket.



4. Remove the two screws that hold the electrical box in place.

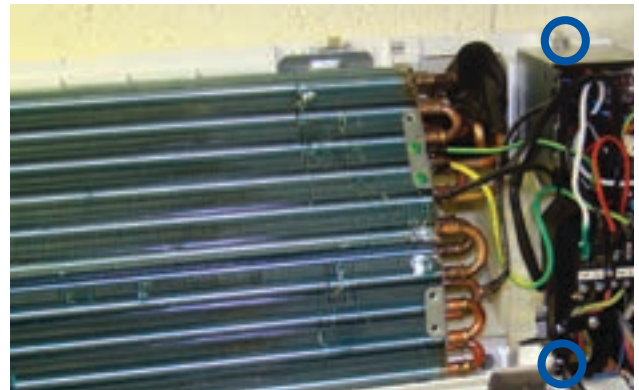

3. Remove the cover from the electrical box on the right side of the indoor unit.



5. Lift and swing the electrical box out of the way.

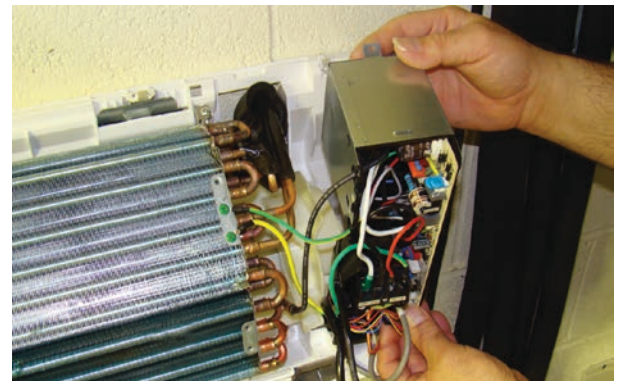

6. Remove 6 screws that hold the motor bracket and evaporator coil.

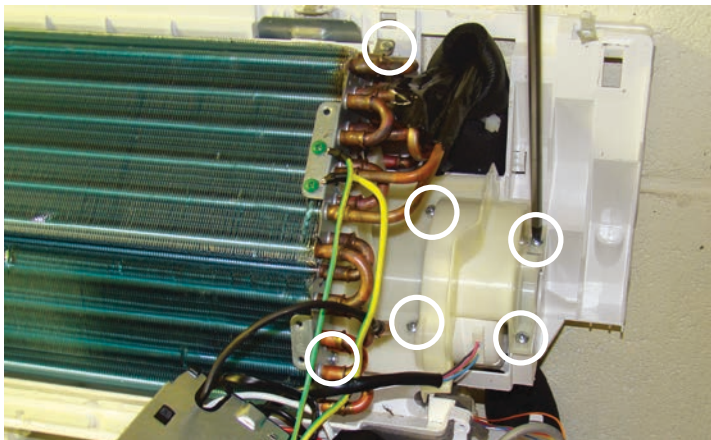

9. Unplug the motor from the circuit board.

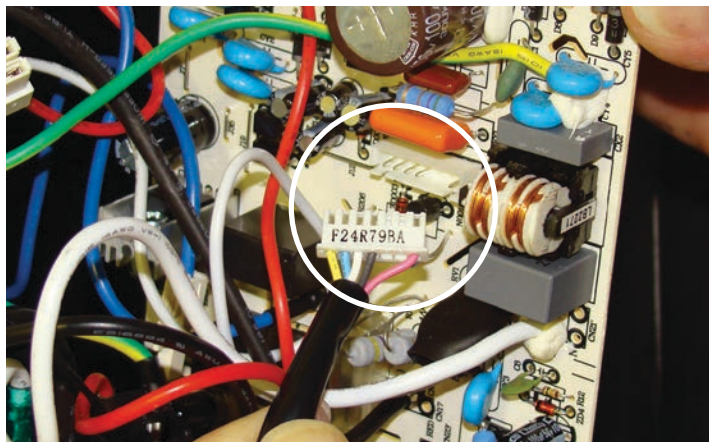

7. Lift the evaporator coil and remove the motor bracket.

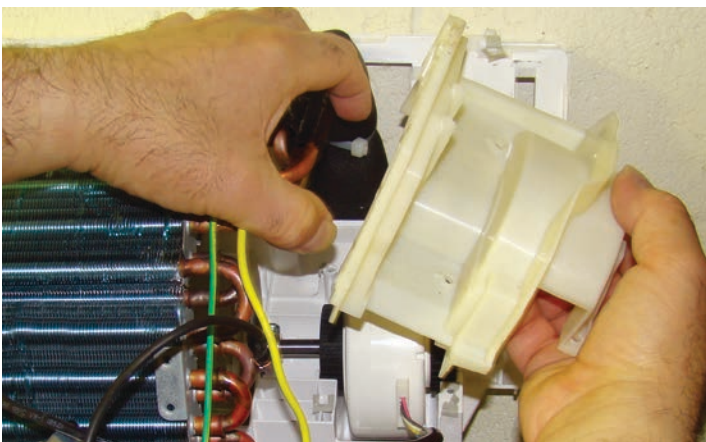

10. Lift and slide the motor away from the blower wheel.



8. Loosen the motor shaft set screw. Phillips head screw.



11. Remove the two black anti vibration mounts from the defective motor and place them on the new motor.



12. Install new motor in reverse order.

Testing Temperature Sensors

The easiest problems to solve will involve codes that are related to potential failure of temperature sensors. Common problems may include loose connections, open electrically, and out of calibration. Checking the condition of the sensors requires a temperature probe and an ohmmeter.

The Reference Section of this manual contains temperature resistance tables that can be used to check the calibration of the sensors. The measured resistance must be within the tolerances printed on the top of the tables.

To test the electrical condition of a temperature sensor perform the following:

1. Confirm the sensor is firmly attached to the circuit board connection plug.
2. Remove the sensor wires from the connection plug by releasing holding tension on the plugs tension tab.
3. Use an ohmmeter to test the electrical resistance of the sensor.
4. Measure the air temperature near the sensor and compare the required resistance against measured resistance. (See chart in reference section) If the sensor is within calibration, the sensor is good. If the sensor is out of calibration, replace the sensor. (Tube Sensors should be removed from socket and exposed to air temperature during test.)

Testing Louver Motors

If the louver does not operate with command from the remote control, either the indoor board is bad, or the louver motor is defective. It is more likely the motor is defective than the board. (Make sure the louver assembly is not binding and keeping the vanes from moving.)



1. Remove power from the unit and remove the indoor unit cover.
2. Access the circuit board.

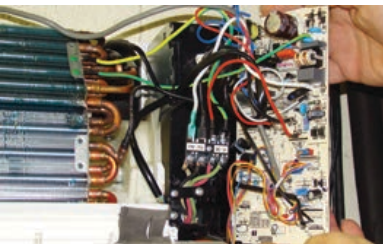

3. Identify on the schematic drawing the inoperable louver motor and disconnect the plug from the circuit board. (The up down louver motor is located on the right side of the indoor unit. The left right louver motor is located bottom center.)

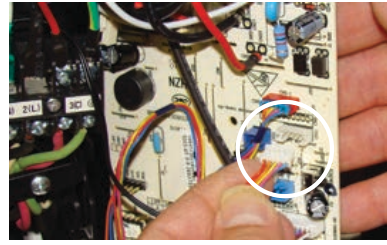

4. Use an Ohmmeter to test the electrical continuity of the louver motor windings. The proper resistance for each winding can be found in this table. If the motor winding resistance is erratic or shows open, the motor is defective. Replace the motor.

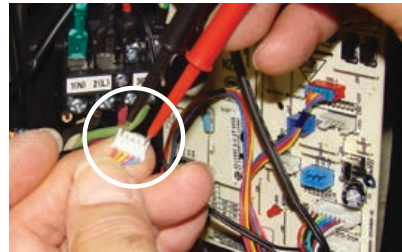

5. If the motor checks out good, replace the indoor control board.

Testing Communication Circuit

If an Error E7 occurs, perform the following test to determine if the indoor control board is functioning properly to send data to the outdoor unit.

Perform this test with the unit powered and all wiring connected between indoor and outdoor unit.

Make sure all wiring between the indoor and outdoor unit are correct. There should no splices between the indoor and outdoor unit wiring connecting terminals 1 or 3. Make sure wiring is correct, before performing this test.

1. Measure the DC voltage between terminals 1 and 3 on the indoor terminal block.
2. C and 23VDC. The fluctuating signal indicates a good communication path.
3. If the voltage does not fluctuate, and the wiring is good, the indoor board is defective.

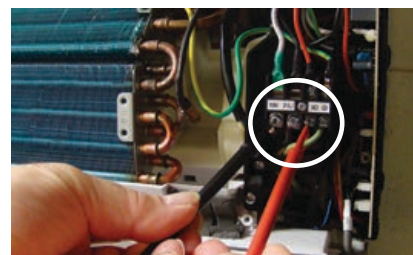

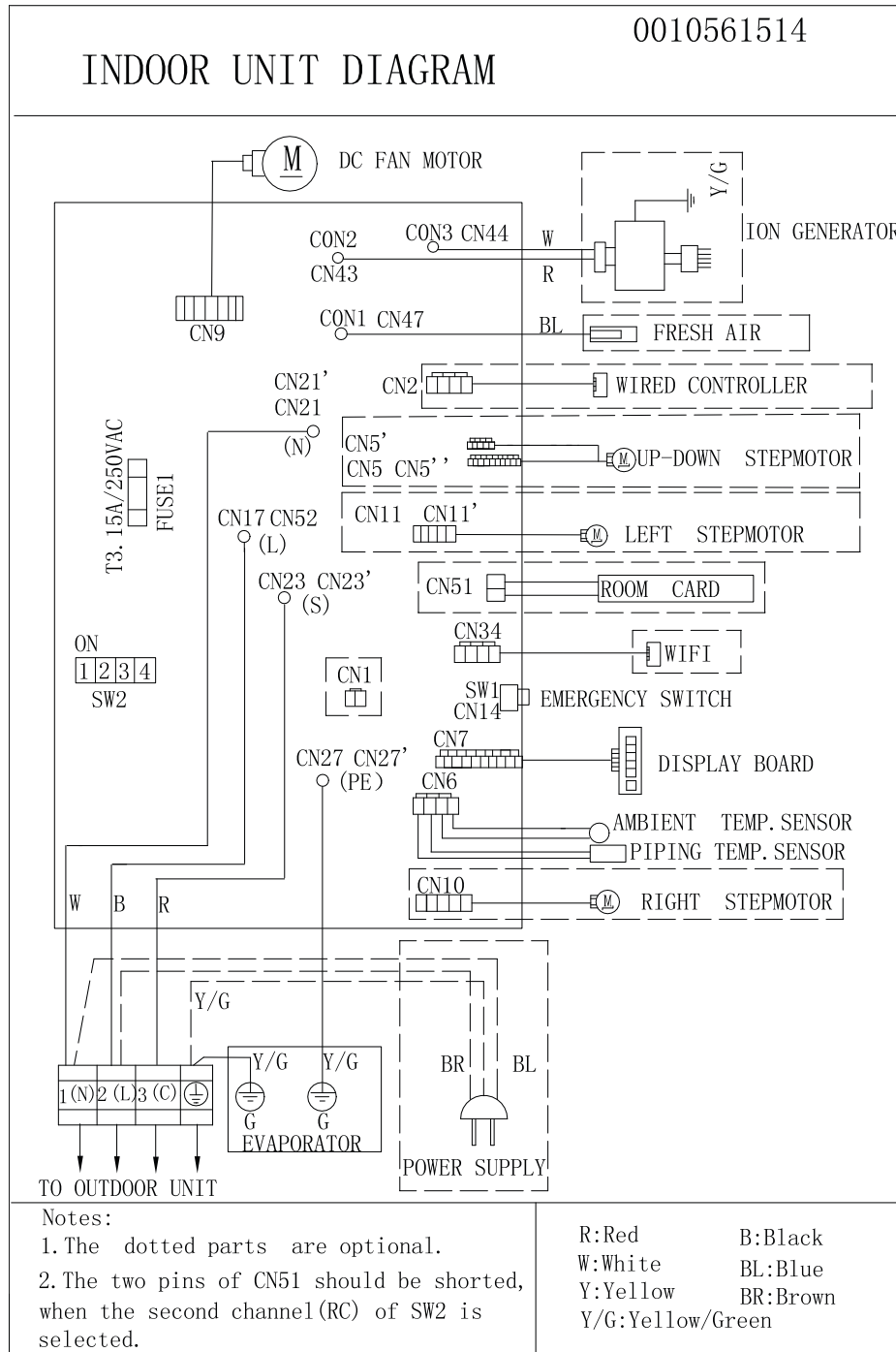

Error Codes

The error codes that are displayed on the indoor units may vary from the outdoor unit codes. The information communicated by the error code will be the SAME for both indoor and outdoor units even though the numbers may differ.

Indoor Display	Outdoor LED	Diagnosis
F12	1	Outdoor EEPROM failure
F1	2	IPM overcurrent or short circuit
F22	/	Outdoor alternating current, over current protection
F3	4	Communication failure between the IPM and outdoor PCB
F20*	5	Module operated overload (compressor overload protection)
F19*	6	Module low or high voltage
F27	/	Compressor current sampling circuit fault
F4	8	Overheat protection for discharge temperature
F8*	9	Malfunction of the DC fan motor
F21	10	Malfunction of defrost temperature sensor
F7	11	Suction temperature sensor failure
F6	12	Ambient temperature sensor failure
F25	13	Discharge temperature sensor failure
F30*	/	High outdoor suction temperature
E7	15	Communication failure between the indoor & outdoor unit
F13*	16	Lack of refrigerant or discharging
F14*	17	4-way valve switching failure
F11	18	Loss of synchronism detection
F28	/	Position detection circuit fault of compressor
F15*	/	Terminal block temp too high
E9	20	Indoor thermal overload
E9*	21	Indoor unit overload protection, heating mode only.
E5	21	Indoor coil frosted
E5*	/	Indoor anti-frosting protection
F5*	23	Module thermal overload
F2*	24	Compressor start failure, over-current
F23*	25	Phase current protection (IPM)
F9	26	MCU reset
F24	27	Module current detect circuit malfunction
F10	28	Liquid pipe sensor failure: Circuit A
F16	29	Liquid pipe sensor failure: Circuit B
F17	30	Liquid pipe sensor failure: Circuit C
F18	31	Liquid pipe sensor failure: Circuit D
F29	32	Gas pipe sensor failure: Circuit A
F30	33	Gas pipe sensor failure: Circuit B
F31	34	Gas pipe sensor failure: Circuit C
F32	35	Gas pipe sensor failure: Circuit D
F26	36	Gas pipe sensor failure: Circuit E
F34	/	Outdoor pipe temperature protection in cooling mode
F35	38	Malfunction of module temperature sensor momentary power failure detection
F36	39	Malfunction of condensing temperature sensor
F33	40	Liquid pipe sensor failure: Circuit E
F38	41	Toci temperature sensor failure
F39	42	High Pressure switch open
F40	43	Low Pressure switch open
F41	44	System high pressure protection: Overcharged, high condensing temperature or malfunction of fan motor.
F42	45	System low pressure protection: Undercharged, low defrosting temperature, or malfunction of fan motor.
F43	/	Incorrect match between indoor & outdoor
E1	/	Indoor ambient temperature sensor failure
E2	/	Indoor coil temperature sensor failure
E4	/	Indoor PCB EEPROM failure
E14*	/	Indoor fan motor malfunction

* Hidden indoor error code. LED1 will flash outdoors, but no error will appear on indoor unit display. To view error code on indoor display, press and hold the Emergency button for 15 seconds.



AB09SC2VHA
 AB12SC2VHA
 AB18SC2VHA

Table of Contents

Components..... **D-2**
 Component Overview D-2
 Cassette Unit Indoor Circuit Board..... D-4

Testing..... **D-5**
 Accessing the Blower Motor and Condensate Pump D-5
 Removing Fan Motor D-5
 Removing Condensate Pump D-5
 Indoor Fan Motor Test Procedure D-6
 Testing Temperature Sensors D-6
 Testing Louver Motors D-7
 Testing Communication Circuit D-7
 Test Condensate Pump and Associated Float Switch D-8

Wiring Diagram & DIP Switch Settings **D-9**
Error Codes..... **D-10**

Components

The indoor cassette type units act as evaporator coils during cooling mode and condenser coils during heating mode. These units have a built in condensate pump with an associated condensate level switch. The condensate pump is capable of lifting water out of the indoor unit. If high water lift is needed, the water from the cassette pump should be pumped into a field supplied condensate pump with high lift power.

Cassette type indoor units can be operated with a wired controller or a remote control.

Component Overview

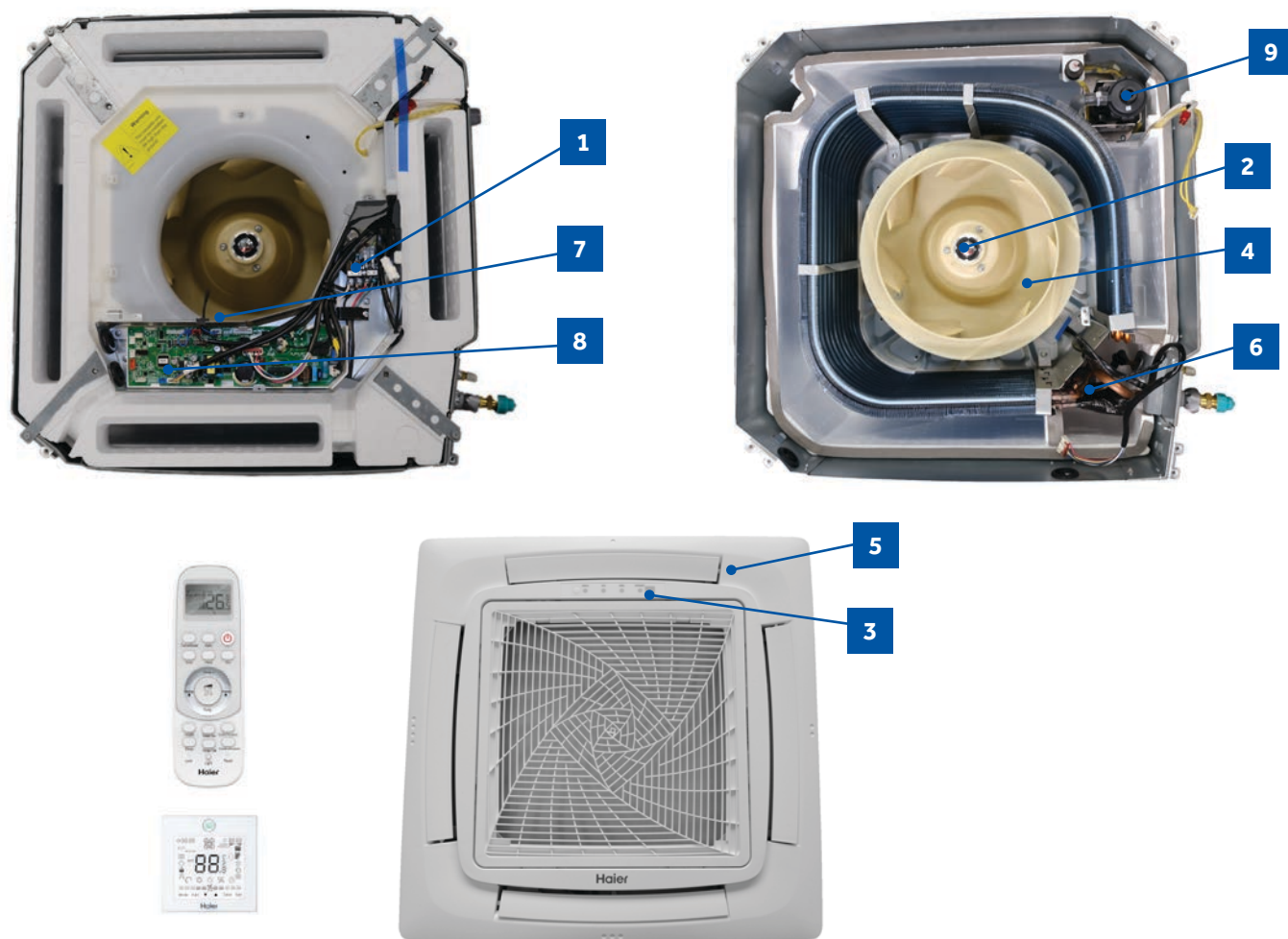

1 Terminal Block

Power to operate the indoor unit comes from the electrical line voltage terminal block at the outdoor unit. The wiring includes 4 wires, 1, 2, 3 and ground. Wires 1 and 3 complete the data path. These wires should always be 14 gauge AWG Stranded type wire. Splices in wires 1 or 3 may cause communication errors.

2 Motor Blower

The indoor unit features a multi speed blower motor that will change speed to match the capacity demand from the outdoor unit. Separate motors located in the indoor unit control the operation of the motorized louvers. All of the louver motors are controlled via commands received from the remote control. The blower motor is controlled by both the remote control and by commands from the outdoor unit ECU.

3 Display

The indoor unit has a display that communicates system mode. The indoor unit does not display temperatures or diagnostic codes. When a wired controller is used, this information is displayed on the wired controller. It is recommended to use a wired controller with the cassette unit.

When servicing a diagnostic error, ALWAYS refer to the outdoor unit code to make diagnostic decisions.

4 The Blower Assembly

The blower assembly consists of a plastic blower wheel that is connected to a PSC indoor blower motor. A set screw holds the blower wheel to the blower motor.

The indoor blower motor is a Multi Speed Fan Motor that is connected to the indoor unit control board. The wiring from the motor to indoor board consists of 4 wires connected to pins common, low , medium and high speeds.

During normal operation, the indoor control board will energize the indoor blower motor and request proper speed. The motor has a run capacitor that is located in the Cassette unit's control box. The run capacitor connects to the motor via two orange wires. This capacitor is field replaceable.

5 Louver Motors

The louver motors are stepper type motors that move the louvers up/down. The motors are controlled by pulsed voltage that cannot be measured. If the louver does not move when it should, check for a bind in the louvers.

6 Piping Temperature Sensor

The Piping Temperature Sensor senses indoor coil temperature in the cooling mode and in the heating mode. This sensor is used for Anti Freezing and Anti Cold Blow cycles. The sensor also provides critical temperature information to the ECU that may be used in frequency adjustments.

7 Ambient Temperature Sensor

The Ambient Temperature Sensor senses room temperature. This sensor provides room temperature information to the ECU for calculation of inverter capacity and temperature control.

Both sensors are negative temperature coefficient type that reduce electrical resistance as temperature rises.

8 Control Board

The indoor unit circuit board controls the switching functions of the indoor unit. All control decisions are made by the outdoor unit ECU. The indoor board has some limited diagnostic capability which will be covered in this manual.

9 Condensate Pump & Float Switch

Cassette Unit Indoor Circuit Board

ENGLISH

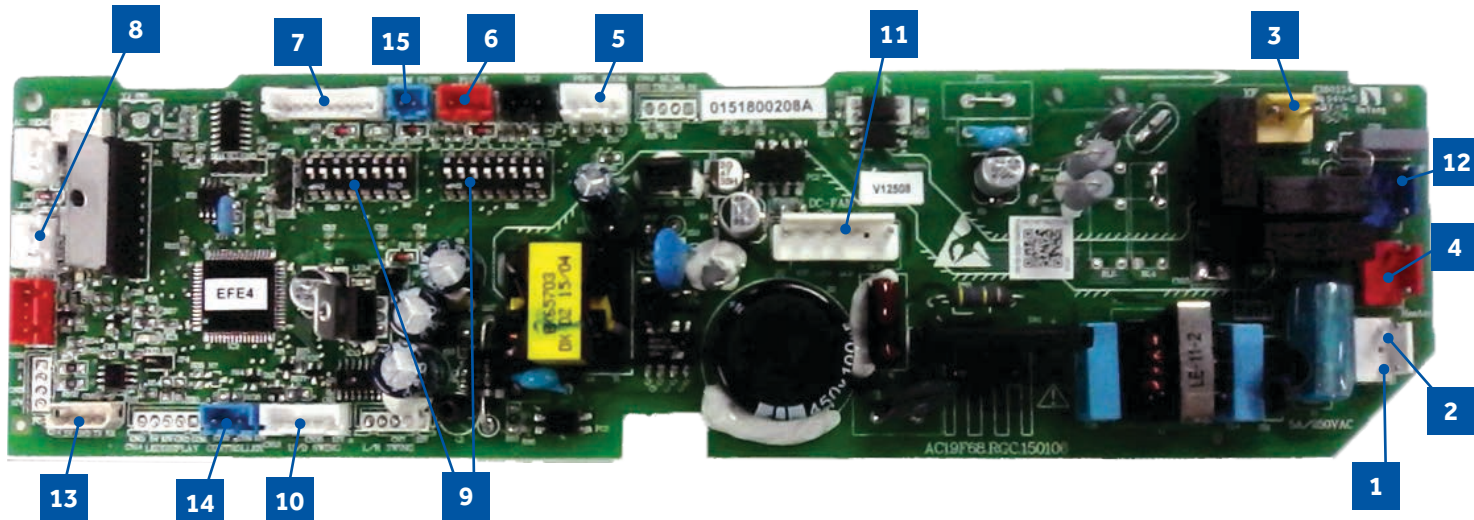

- | | | |
|-------------------------------------|------------------------------|-------------------------------|
| 1 N Terminal | 6 CN19 Float Switch | 11 CN6 Fan Motor |
| 2 L Terminal | 7 CN21 Louver Panel | 12 CN9 Condensate Pump |
| 3 Communication Terminal | 8 CN11 Wired Remote | 13 CN4 U-HOME |
| 4 3.15A 250V Fuse | 9 DIP Switches | 14 CN13 Remote Central |
| 5 CN3 Pipe/Room Temp Sensors | 10 CN35 Stepper Motor | 15 CN1 Room Card |

The indoor unit circuit board controls the switching functions of the indoor unit. All control decisions are made by the outdoor unit ECU. The indoor board has some limited diagnostic capability which will be covered in this manual.

The Indoor Unit Circuit Board communicates with the outdoor unit ECU via a connection at Terminal Block screw 3. The data pulse that sends the communication information can be measured with a voltmeter placed to DCV range. From the ground connection at the Terminal Block to the Number 3 screw connection, the voltage should pulse up and down when data is being transmitted.

This control board has control over the fan louver movement, manual fan blower control, indoor coil temperature and indoor air temperature sensing functions. All operational decisions are controlled by the OUTDOOR UNIT ECU.

The connections on the indoor board are shown here in the schematic drawing.

Line voltage to power the indoor unit comes in on Terminal Block connections 1 and 2. Power connects from these terminal connections to CH- 3 and CH-4 on the circuit board. If the board does not respond to commands and has no display, check for line voltage at these connections. When power is present at the indoor board, the Display Power Indicator will be lit.

The control board has a replaceable 3.15A 250V fuse that protects against excessive current. If power is present at the board but the board does not work, check for continuity through the fuse. Replace if the fuse is open.

The indoor unit temperature sensors are connected at Plug CN-13. When testing the calibration of these sensors, the wires can be released from the plug by pressing on the tension tab on the side of the plug.

The receiver/display unit that is mounted to the front cover of the indoor unit plugs into the circuit board via a connection at Plug CN-29.

There is one motor that controls the movement of the louvers. The motor connects to the circuit board at Plug CN-14. The motor is located in the over of the louver assembly.

The blower/fan motor is connected to the circuit board at plug CN-11.

The Cassette unit has a built in condensate pump. The pump is connected to the circuit board on Plug CN-9. The pump is energized whenever the Float Switch indicates that water needs to be pumped from the cassette. The float switch connects onto the circuit board via Plug CN-18.

Accessing the Blower Motor and Condensate Pump

1. Disconnect power to the outdoor unit.
2. Remove the louver assembly.



3. Disconnect the main power wire to the indoor unit.
4. Unplug the condensate pump and float switch from wiring harness.
5. Unplug fan motor from wiring harness.
6. Remove ground wire from ground screw on electrical box. Remove electrical box.
7. Remove 5 screws holding foam condensate pan bottom in place.



8. Slide condensate pan from cassette.

Removing Fan Motor

1. Remove holding nut from fan blade.



2. Fan blade will slide off motor shaft.
3. Remove Phillips head screw holding cover plate over motor wiring leads.
4. Remove 3 nuts that hold fan motor in place.



5. Fan motor will come loose.

Removing Condensate Pump

1. Remove screws holding condensate pump and float switch in position.
2. Disconnect condensate hose from condensate pump.
3. Remove assembly.

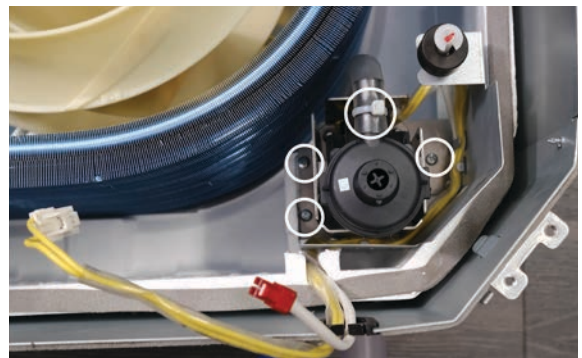

Indoor Fan Motor Test Procedure

If the indoor fan motor does not run:

1. Disconnect power to the system.
2. Remove the return air cover and access the circuit board connection.
3. Reset power and turn the remote control fan command to Fan On mode.

Motor Test:

1. If the motor doesn't run, check for 310VDC between Pins 1 and 3. If it is not present, the indoor board is bad. If voltage is present, continue on.
2. Check the voltage between Pins 3 and 4. The voltage should be +15VDC. If it is not present, the board is bad. If voltage is present, continue on.
3. Check for voltage between Pins 3 and 6. If no DC voltage is present, the board is bad. If voltage is present, change the motor.

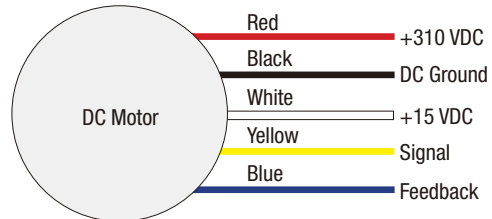

Testing Temperature Sensors

The easiest problems to solve will involve codes that are related to potential failure of temperature sensors. Common problems may include loose connections, open electrically, and out of calibration. Checking the condition of the sensors requires a temperature probe and an ohmmeter.

The Reference Section of this manual contains temperature resistance tables that can be used to check the calibration of the sensors. The measured resistance must be within the tolerances printed on the top of the tables.

To test the electrical condition of a temperature sensor perform the following:

1. Confirm the sensor is firmly attached to the circuit board connection plug.
2. Remove the sensor wires from the connection plug by releasing holding tension on the plugs tension tab.
3. Use an ohmmeter to test the electrical resistance of the sensor.
4. Measure the air temperature near the sensor and compare the required resistance against measured resistance. (See chart in reference section) If the sensor is within calibration, the sensor is good. If the sensor is out of calibration, replace the sensor. (Tube Sensors should be removed from socket and exposed to air temperature during test.)

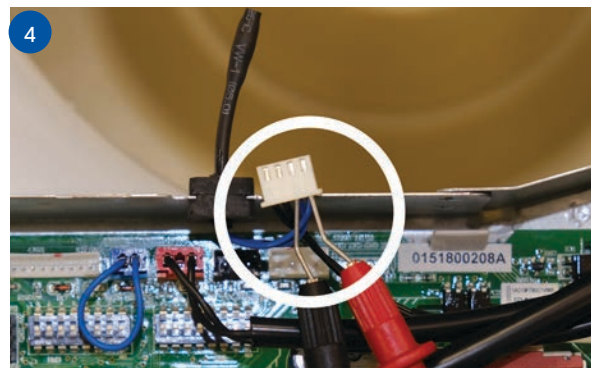

Testing Louver Motors

If the louver does not operate with command from the remote control, either the indoor board is bad, or the louver motor is defective. It is more likely the motor is defective than the board. (Make sure the louver assembly is not binding and keeping the vanes from moving.)

1. Remove power from the unit and remove the indoor unit cover.
2. Access the circuit board.



3. Identify the inoperable louver motor on the schematic drawing below and disconnect the plug from the circuit board.

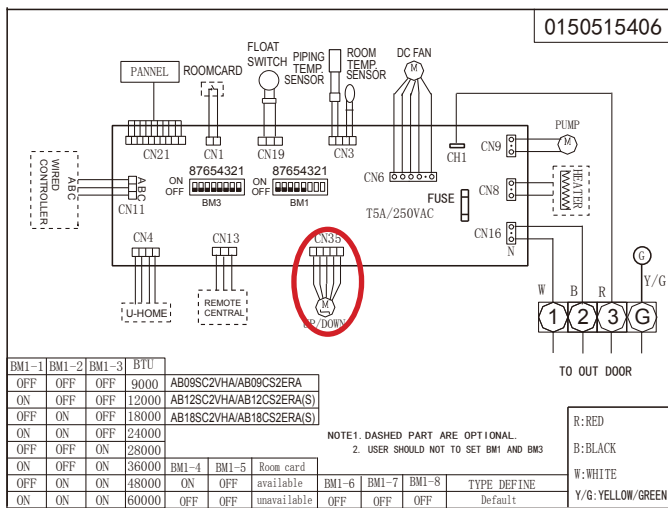

4. Use an Ohmmeter to test the electrical continuity of the louver motor windings. The proper resistance for each winding can be found in this table. If the motor winding resistance is erratic or shows open, the motor is defective. Replace the motor.



5. If the motor checks out good, replace the indoor control board.

Testing Communication Circuit

If an Error E7 occurs, perform the following test to determine if the indoor control board is functioning properly to send data to the outdoor unit.

Perform this test with the unit powered and all wiring connected between indoor and outdoor unit.

Make sure all wiring between the indoor and outdoor unit are correct. There should no splices between the indoor and outdoor unit wiring connecting terminals 1 or 3. Make sure wiring is correct, before performing this test.

1. Measure the DC voltage between terminals 1 and 3 on the indoor terminal block.



2. The voltage should fluctuate between 8VDC and 23VDC. The fluctuating signal indicates a good communication path.
3. If the voltage does not fluctuate, and the wiring is good, the indoor board is defective.

Test Condensate Pump and Associated Float Switch

If the internal condensate pump does not operate, the pump may be bad or the float switch may be defective. Perform the following test:

1. Access the electrical control box.
2. Unplug the float switch from the circuit board.
3. The pump should start.
4. If the pump does not start, check for voltage at the pump connector on the board. There should be 230 Volts AC to the pump. If there is not, the circuit board is defective. If there is proper voltage to the pump, either the pump or associated pump wiring is defective.

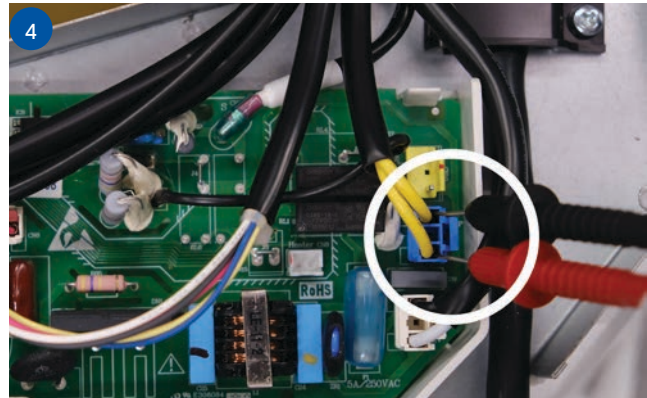

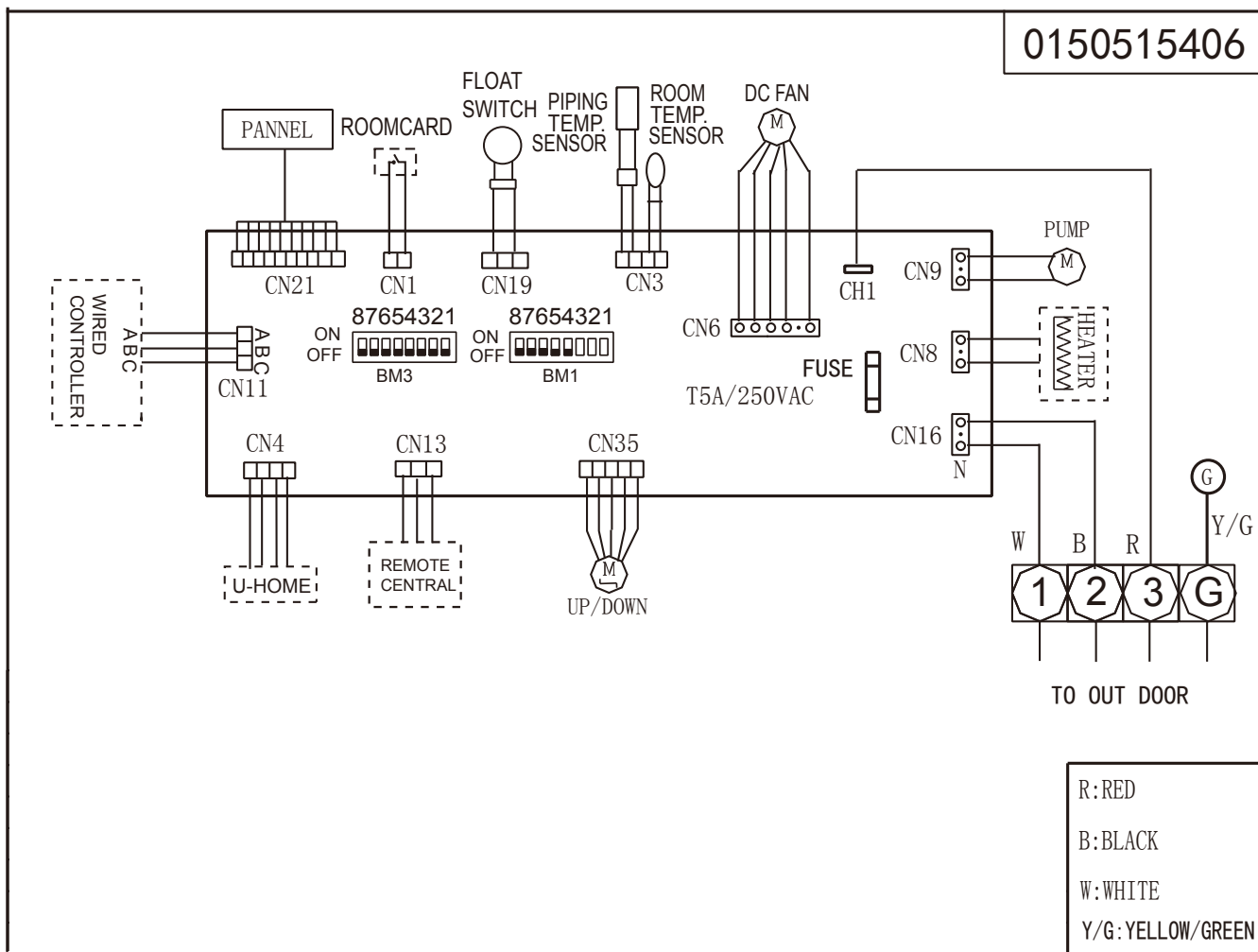

Cassette Unit DIP Switch Settings

BM1-1	BM1-2	BM1-3	BM1-4	BM1-5	BM1-6	BM1-7	BM1-8	Description
OFF	OFF	OFF	--	--	--	--	--	Unit capacity: 9000
ON	OFF	OFF	--	--	--	--	--	Unit capacity: 12000
OFF	ON	OFF	--	--	--	--	--	Unit capacity: 18000
--	--	--	OFF	--	--	--	--	Room card invalid(default)
--	--	--	ON	--	--	--	--	Room card valid
--	--	--	--	OFF	--	--	--	Heat pump(default)
--	--	--	--	ON	--	--	--	Cooling only
--	--	--	--	--	OFF	OFF	OFF	Cassette(American)

Error Codes

The error codes that are displayed on the indoor units may vary from the outdoor unit codes. The information communicated by the error code will be the SAME for both indoor and outdoor units even though the numbers may differ.

Indoor LED5	Indoor LED1	Outdoor LED	Diagnosis
2	1	1	Outdoor EEPROM failure
2	2	2	IPM overcurrent or short circuit
2	3	/	Outdoor alternating current, over current protection
2	4	4	Communication failure between the IPM and outdoor PCB
2	5	5	Module operated overload (compressor overload protection)
2	6	6	Module low or high voltage
2	7	/	Compressor current sampling circuit fault
2	8	8	Overheat protection for discharge temperature
2	9	9	Malfunction of the DC fan motor
3	0	10	Malfunction of defrost temperature sensor
3	1	11	Suction temperature sensor failure
3	2	12	Ambient temperature sensor failure
3	3	13	Discharge temperature sensor failure
3	4	/	High outdoor suction temperature
3	5	15	Communication failure between the indoor & outdoor unit
3	6	16	Lack of refrigerant or discharging
3	7	17	4-way valve switching failure
3	8	18	Loss of synchronism detection
3	9	/	Position detection circuit fault of compressor
4	0	/	Terminal block temp too high
4	0	20	Indoor thermal overload
4	1	21	Indoor unit overload protection, heating mode only.
4	1	21	Indoor coil frosted
4	2	/	Indoor anti-frosting protection
4	3	23	Module thermal overload
4	4	24	Compressor start failure, over-current
4	5	25	Phase current protection (IPM)
4	6	26	MCU reset
4	7	27	Module current detect circuit malfunction
4	8	28	Liquid pipe sensor failure: Circuit A
4	9	29	Liquid pipe sensor failure: Circuit B
5	0	30	Liquid pipe sensor failure: Circuit C
5	1	31	Liquid pipe sensor failure: Circuit D
5	2	32	Gas pipe sensor failure: Circuit A
5	3	33	Gas pipe sensor failure: Circuit B
5	4	34	Gas pipe sensor failure: Circuit C
5	5	35	Gas pipe sensor failure: Circuit D
5	6	36	Gas pipe sensor failure: Circuit E
5	7	/	Outdoor pipe temperature protection in cooling mode
5	8	38	Malfunction of module temperature sensor momentary power failure detection
5	9	39	Malfunction of condensing temperature sensor
6	0	40	Liquid pipe sensor failure: Circuit E
6	1	41	Toci temperature sensor failure
6	2	42	High Pressure switch open
6	3	43	Low Pressure switch open
6	4	44	System high pressure protection: Overcharged, high condensing temperature or malfunction of fan motor
6	5	45	System low pressure protection: Undercharged, low defrosting temperature, or malfunction of fan motor
6	6	/	Incorrect match between indoor & outdoor
0	1	/	Indoor ambient temperature sensor failure
0	2	/	Indoor coil temperature sensor failure
0	4	/	Indoor PCB EEPROM failure
0	7	/	Communication fault between the indoor and outdoor unit
0	8	/	Communication fault between the controller and Indoor unit
0	12	/	Drain system malfunction
0	13	/	Zero cross signal detected wrong
0	14	/	Indoor fan motor malfunction



AL24LP2VHA

Table of Contents

Components.....**E-2**
 Component Overview.....E-2
 Cassette Unit Indoor Circuit Board.....E-4

Testing.....**E-5**
 Accessing the Blower Motor and Condensate PumpE-5
 Removing Fan MotorE-5
 Removing Condensate PumpE-5
 Indoor Fan Motor Test ProcedureE-6
 Testing Temperature Sensors.....E-6
 Testing Louver MotorsE-7
 Testing Communication Circuit.....E-7
 Test Condensate Pump and Float Switch.....E-8

Wiring Diagram.....**E-9**
DIP Switch Settings**E-10**
Error Codes.....**E-11**

Components

The indoor cassette type units act as evaporator coils during cooling mode and condenser coils during heating mode. These units have a built in condensate pump with an associated condensate level switch. The condensate pump is capable of lifting water out of the indoor unit. If high water lift is needed, the water from the cassette pump should be pumped into a field supplied condensate pump with high lift power.

Cassette type indoor units can be operated with a wired controller or a remote control.

Component Overview

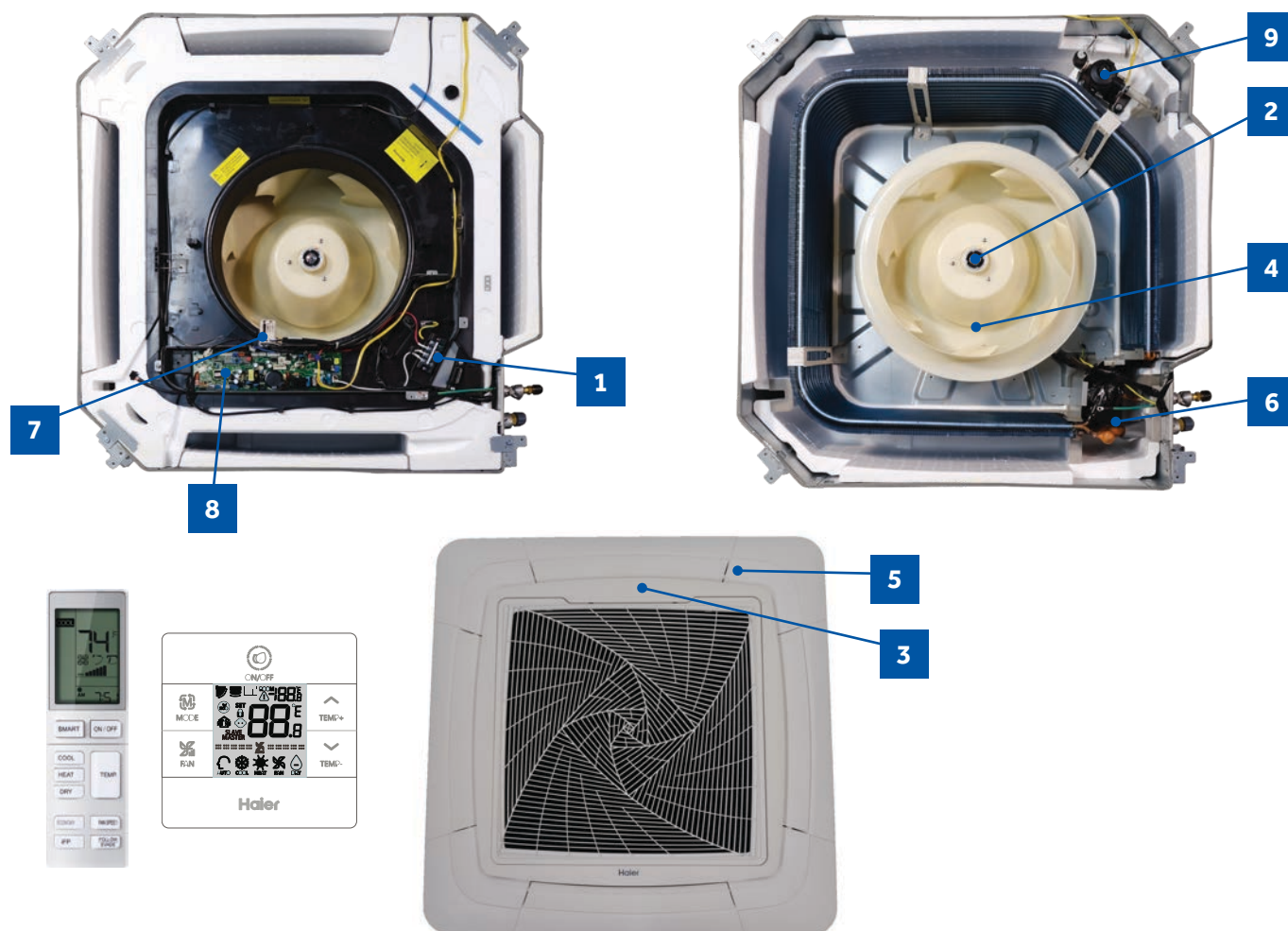

1 Terminal Block

Power to operate the indoor unit comes from the electrical line voltage terminal block at the outdoor unit. The wiring includes 4 wires, 1, 2, 3 and ground. Wires 1 and 3 complete the data path. These wires should always be 14 gauge AWG Stranded type wire. Splices in wires 1 or 3 may cause communication errors.

2 Motor Blower

The indoor unit features a multi speed blower motor that will change speed to match the capacity demand from the outdoor unit. Separate motors located in the indoor unit control the operation of the motorized louvers. All of the louver motors are controlled via commands received from the remote control. The blower motor is controlled by both the remote control and by commands from the outdoor unit ECU.

3 Display

The indoor unit has a display that communicates system mode. The indoor unit does not display temperatures or diagnostic codes. When a wired controller is used, this information is displayed on the wired controller. It is recommended to use a wired controller with the cassette unit.

When servicing a diagnostic error, ALWAYS refer to the outdoor unit code to make diagnostic decisions.

4 The Blower Assembly

The blower assembly consists of a plastic blower wheel that is connected to a PSC indoor blower motor. A set screw holds the blower wheel to the blower motor.

The indoor blower motor is a Multi Speed Fan Motor that is connected to the indoor unit control board. The wiring from the motor to indoor board consists of 4 wires connected to pins common, low , medium and high speeds.

During normal operation, the indoor control board will energize the indoor blower motor and request proper speed. The motor has a run capacitor that is located in the Cassette unit's control box. The run capacitor connects to the motor via two orange wires. This capacitor is field replaceable.

5 Louver Motors

The louver motors are stepper type motors that move the louvers up/down. The motors are controlled by pulsed voltage that cannot be measured. If the louver does not move when it should, check for a bind in the louvers.

6 Piping Temperature Sensor

The Piping Temperature Sensor senses indoor coil temperature in the cooling mode and in the heating mode. This sensor is used for Anti Freezing and Anti Cold Blow cycles. The sensor also provides critical temperature information to the ECU that may be used in frequency adjustments.

7 Ambient Temperature Sensor

The Ambient Temperature Sensor senses room temperature. This sensor provides room temperature information to the ECU for calculation of inverter capacity and temperature control.

Both sensors are negative temperature coefficient type that reduce electrical resistance as temperature rises.

8 Control Board

The indoor unit circuit board controls the switching functions of the indoor unit. All control decisions are made by the outdoor unit ECU. The indoor board has some limited diagnostic capability which will be covered in this manual.

9 Condensate Pump & Float Switch

Cassette Unit Indoor Circuit Board

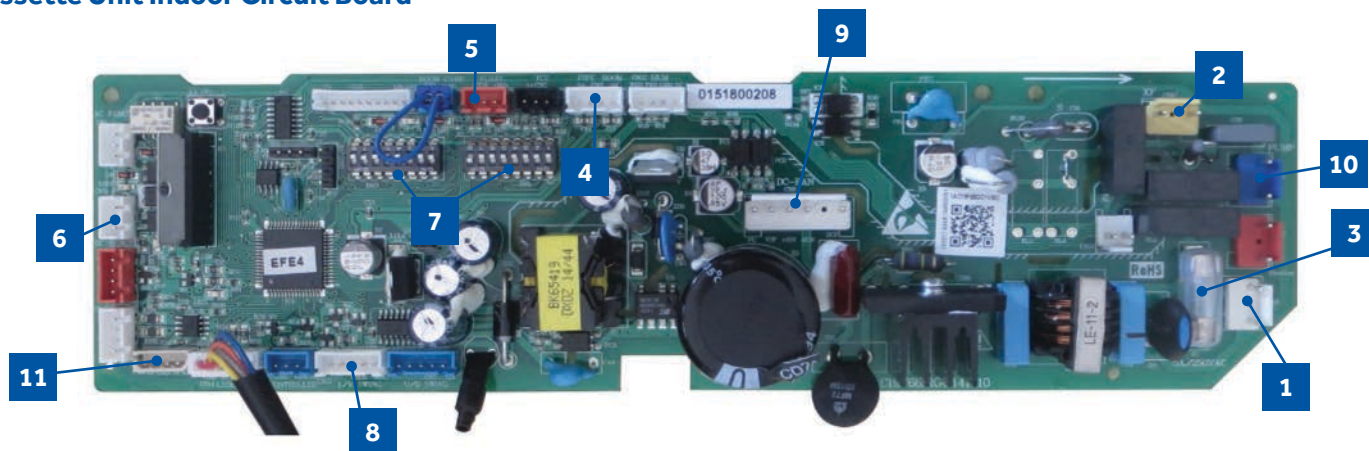

- | | | |
|-------------------------------------|-----------------------------|---------------------------------|
| 1 Power | 5 CN19 Float Switch | 9 CN6 Fan Motor |
| 2 Communication Terminal | 6 CN11 Wired Remote | 10 CN9 Condensate Pump |
| 3 3.15A 250V Fuse | 7 DIP Switches | 11 CN14 Panel Connection |
| 4 CN3 Pipe/Room Temp Sensors | 8 CN36 Stepper Motor | |

The indoor unit circuit board controls the switching functions of the indoor unit. All control decisions are made by the outdoor unit ECU. The indoor board has some limited diagnostic capability which will be covered in this manual.

The Indoor Unit Circuit Board communicates with the outdoor unit ECU via a connection at Terminal Block screw 3. The data pulse that sends the communication information can be measured with a voltmeter placed to DCV range. From the ground connection at the Terminal Block to the Number 3 screw connection, the voltage should pulse up and down when data is being transmitted.

This control board has control over the fan louver movement, manual fan blower control, indoor coil temperature and indoor air temperature sensing functions. All operational decisions are controlled by the OUTDOOR UNIT ECU.

The connections on the indoor board are shown here in the schematic drawing.

Line voltage to power the indoor unit comes in on Terminal Block connections 1 and 2. Power connects from these terminal connections to CH- 3 and CH-4 on the circuit board. If the board does not respond to commands and has no display, check for line voltage at these connections. When power is present at the indoor board, the Display Power Indicator will be lit.

The control board has a replaceable 3.15A 250V fuse that protects against excessive current. If power is present at the board but the board does not work, check for continuity through the fuse. Replace if the fuse is open.

The indoor unit temperature sensors are connected at Plug CN-13. When testing the calibration of these sensors, the wires can be released from the plug by pressing on the tension tab on the side of the plug.

The receiver/display unit that is mounted to the front cover of the indoor unit plugs into the circuit board via a connection at Plug CN-29.

There is one motor that controls the movement of the louvers. The motor connects to the circuit board at Plug CN-14. The motor is located in the over of the louver assembly.

The blower/fan motor is connected to the circuit board at plug CN-11.

The Cassette unit has a built in condensate pump. The pump is connected to the circuit board on Plug CN-9. The pump is energized whenever the Float Switch indicates that water needs to be pumped from the cassette. The float switch connects onto the circuit board via Plug CN-18.

Accessing the Blower Motor and Condensate Pump

1. Disconnect power to the outdoor unit.
2. Remove the louver assembly.



3. Disconnect the main power wire to the indoor unit.
4. Unplug the condensate pump and float switch from wiring harness.
5. Unplug fan motor from wiring harness.
6. Remove the float switch, piping temperature sensor, fan motor, and wired controller (if present) control board wire connections . Disconnect plug to the coil sensor.
7. Remove screws holding the control box.



8. Remove screws holding the air inlet cover.
9. Drain the condensate water from the pan by removing drain plug.
10. Remove the screws holding on the condensate pan

Removing Fan Motor

1. Remove holding nut from fan blade.

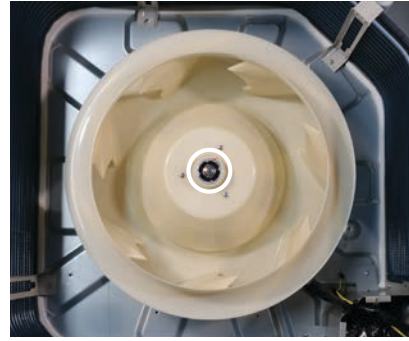

2. Fan blade will slide off motor shaft.
3. Remove Phillips head screw holding cover plate over motor wiring leads.
4. Remove 3 nuts that hold fan motor in place.



5. Fan motor will come loose.

Removing Condensate Pump

1. Remove screws holding condensate pump and float switch in position.
2. Disconnect condensate hose from condensate pump.
3. Remove assembly.



Indoor Fan Motor Test Procedure

If the indoor fan motor does not run:

1. Disconnect power to the system.
2. Remove the return air cover and access the circuit board fan motor connection.
3. Reset power and turn the remote control fan command to Fan On mode.

Motor Test:

1. If the motor doesn't run, check for 310VDC between Pins 1 and 3. If it is not present, the indoor board is bad. If voltage is present, continue on.
2. Check the voltage between Pins 3 and 4. The voltage should be +15VDC. If it is not present, the board is bad. If voltage is present, continue on.
3. Check for voltage between Pins 3 and 6. If no DC voltage is present, the board is bad. If voltage is present, change the motor.

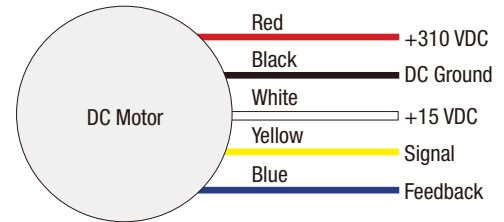

Testing Temperature Sensors

The easiest problems to solve will involve codes that are related to potential failure of temperature sensors. Common problems may include loose connections, open electrically, and out of calibration. Checking the condition of the sensors requires a temperature probe and an ohmmeter.

The Reference Section of this manual contains temperature resistance tables that can be used to check the calibration of the sensors. The measured resistance must be within the tolerances printed on the top of the tables.

To test the electrical condition of a temperature sensor perform the following:

1. Confirm the sensor is firmly attached to the circuit board connection plug.
2. Remove the sensor wires from the connection plug by releasing holding tension on the plug's tension tab.
3. Use an ohmmeter to test the electrical resistance of the sensor.
4. Measure the air temperature near the sensor and compare the required resistance against measured resistance. (See chart in reference section) If the sensor is within calibration, the sensor is good. If the sensor is out of calibration, replace the sensor. (Tube Sensors should be removed from socket and exposed to air temperature during test.)

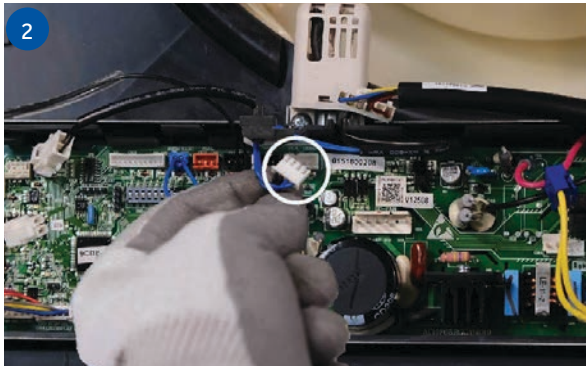

Testing Louver Motors

If the louver does not operate with command from the remote control, either the indoor board is bad, or the louver motor is defective. It is more likely the motor is defective than the board. (Make sure the louver assembly is not binding and keeping the vanes from moving.)

1. Remove power from the unit and remove the indoor unit cover.
2. Access the circuit board.
3. Identify the inoperable louver motor on the schematic drawing below and disconnect the plug from the circuit board.

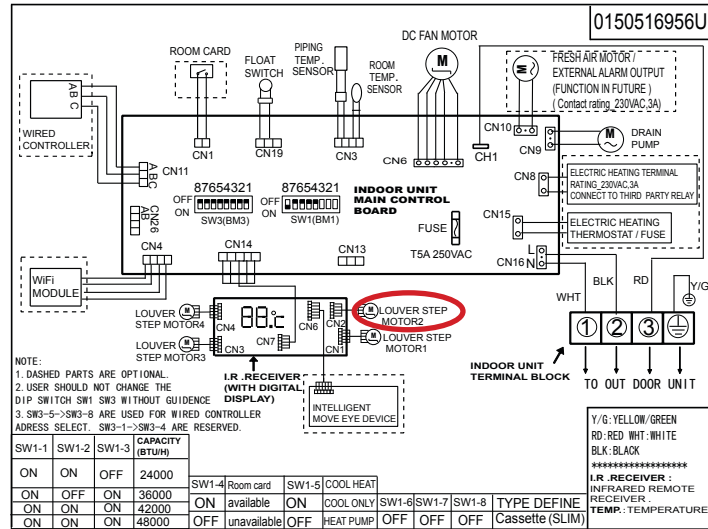

4. Use an Ohmmeter to test the electrical continuity of the louver motor windings. The proper resistance for each winding can be found in this table. If the motor winding resistance is erratic or shows open, the motor is defective. Replace the motor.

5. If the motor checks out good, replace the indoor control board.

Testing Communication Circuit

If an Error E7 occurs, perform the following test to determine if the indoor control board is functioning properly to send data to the outdoor unit.

Perform this test with the unit powered and all wiring connected between indoor and outdoor unit.

Make sure all wiring between the indoor and outdoor unit are correct. There should no splices between the indoor and outdoor unit wiring connecting terminals 1 or 3. Make sure wiring is correct, before performing this test.

1. Measure the DC voltage between terminals 1 and 3 on the indoor terminal block.

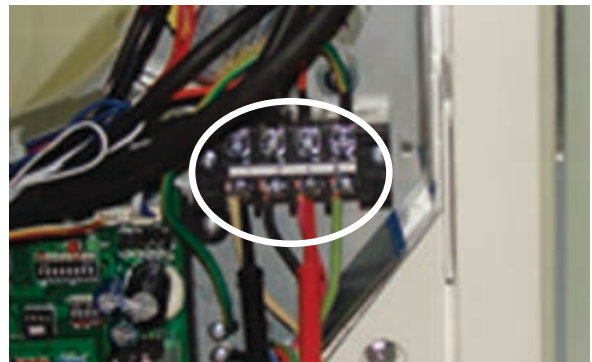
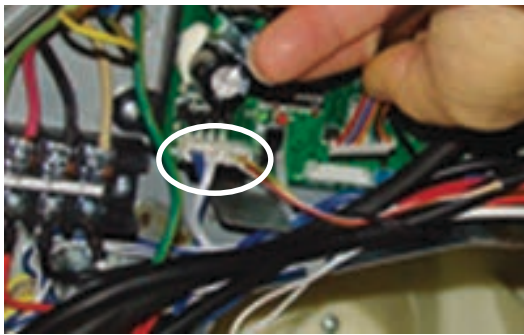

2. The voltage should fluctuate between 8VDC and 23VDC. The fluctuating signal indicates a good communication path.
3. If the voltage does not fluctuate, and the wiring is good, the indoor board is defective.

Test Condensate Pump and Float Switch

If the internal condensate pump does not operate, the pump may be bad or the float switch may be defective. Perform the following test:

1. Access the electrical control box.
2. Unplug the float switch from the circuit board.
3. The pump should start.
4. If the pump does not start, check for voltage at the pump connector on the board. There should be 230 Volts AC to the pump. If there is not, the circuit board is defective. If there is proper voltage to the pump, either the pump or associated pump wiring is defective.

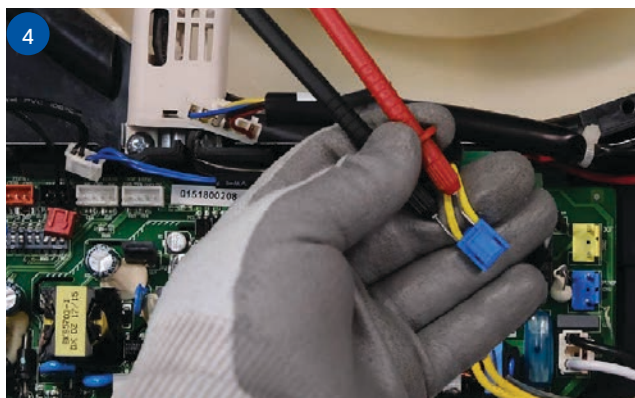

Wiring Diagram

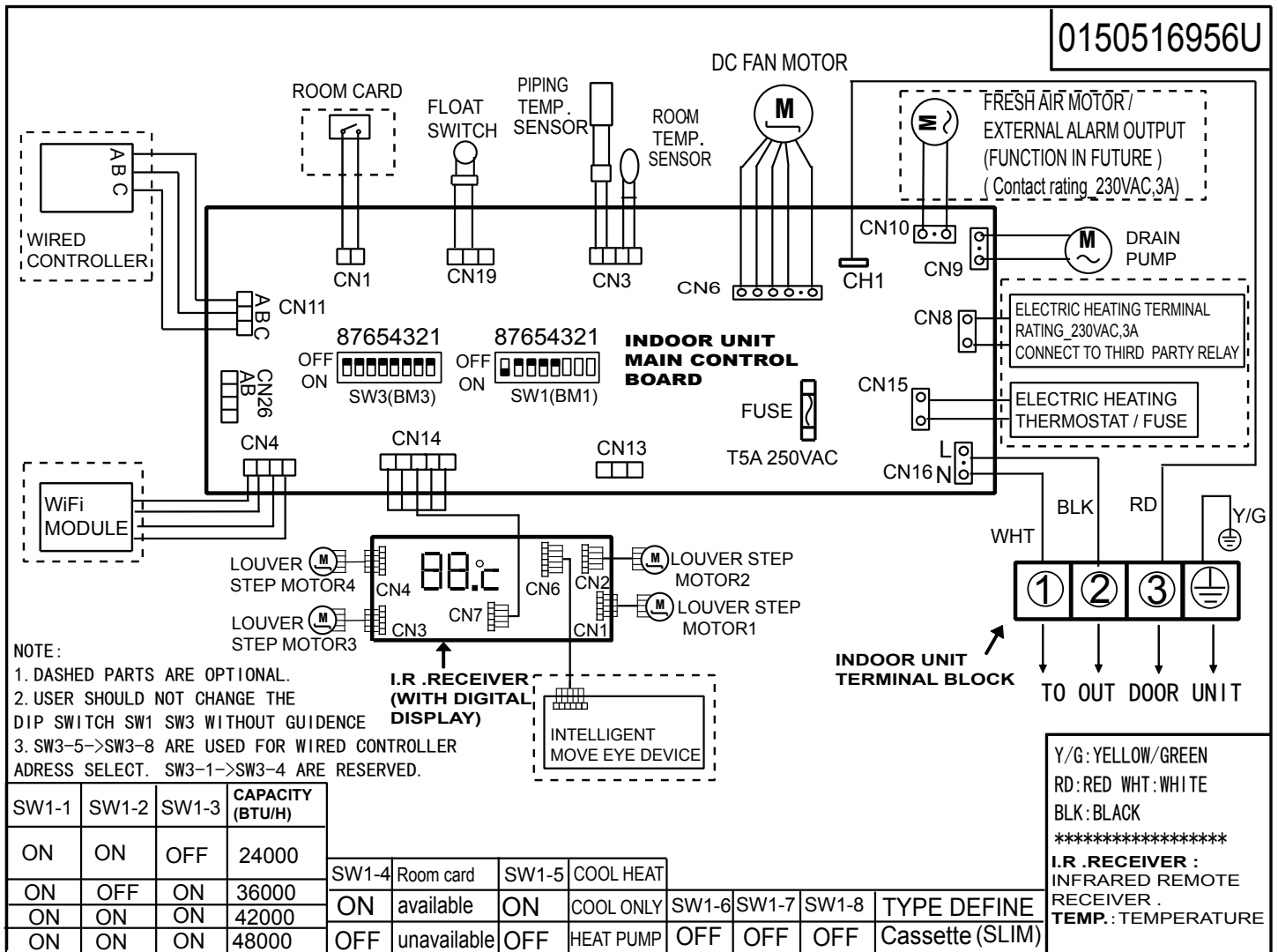

DIP Switch Settings

BM1 DIP Switch Settings

Description	Capacity			Room Card	Running Mode	Unit Type		
	SW1-1	SW1-2	SW1-3	SW1-4	SW1-5	SW1-6	SW1-7	SW1-8
Capacity: 24kBTU(7.1kW)	ON	ON	OFF	---	---	---	---	---
Capacity: 30kBTU(9.0kW)	OFF	OFF	ON	---	---	---	---	---
Capacity: 35kBTU(10.5kW)	ON	OFF	ON	---	---	---	---	---
Capacity: 42kBTU(12.5kW)	OFF	ON	ON	---	---	---	---	---
Capacity: 48kBTU(14.0kW)	ON	ON	ON	---	---	---	---	---
Room card invalid(default)	---	---	---	OFF	---	---	---	---
Room card valid	---	---	---	ON	---	---	---	---
Heat pump(default)	---	---	---	---	OFF	---	---	---
Cooling only	---	---	---	---	ON	---	---	---
High performance cassette	---	---	---	---	---	OFF	OFF	ON

Wired Controller Communication Address

Indoor unit Address (Indoor unit address for one wired controller control more than one unit)	BM3-5	BM3-6	BM3-7	BM3-8
0 (master)	OFF	OFF	OFF	OFF
1 (slave)	OFF	OFF	OFF	ON
2 (slave)	OFF	OFF	ON	OFF
3 (slave)	OFF	OFF	ON	ON
4 (slave)	OFF	ON	OFF	OFF
5 (slave)	OFF	ON	OFF	ON
6 (slave)	OFF	ON	ON	OFF
7 (slave)	OFF	ON	ON	ON
8 (slave)	ON	OFF	OFF	OFF
9 (slave)	ON	OFF	OFF	ON
10 (slave)	ON	OFF	ON	OFF
11 (slave)	ON	OFF	ON	ON
12 (slave)	ON	ON	OFF	OFF
13 (slave)	ON	ON	OFF	ON
14 (slave)	ON	ON	ON	OFF
15 (slave)	ON	ON	ON	ON

Error Codes

The error codes that are displayed on the indoor units may vary from the outdoor unit codes. The information communicated by the error code will be the SAME for both indoor and outdoor units even though the numbers may differ.

Indoor LED4	Indoor LED1	Panel Display	Outdoor LED	Diagnosis
2	1	15	1	Outdoor EEPROM failure
2	2	16	2	IPM overcurrent or short circuit
2	3	17	/	Compressor over current during deceleration
2	4	18	4	Communication failure between the IPM and outdoor PCB
2	5	19	5	Module operated overload (compressor overload protection)
2	6	1A	6	Module low or high voltage
2	7	1B	/	Compressor current sampling circuit fault
2	8	1C	8	Overheat protection for discharge temperature
2	9	1D	9	Malfunction of the DC fan motor
3	0	1E	10	Malfunction of defrost temperature sensor
3	1	1F	11	Suction temperature sensor failure
3	2	20	12	Ambient temperature sensor failure
3	3	21	13	Discharge temperature sensor failure
3	4	22	/	PFC circuit loop voltage
3	5	23	15	Communication failure between the indoor & outdoor unit
3	6	24	16	Lack of refrigerant or discharging
3	7	25	17	4-way valve switching failure
3	8	26	18	Loss of synchronism detection
3	9	27	/	Low DC or AC voltage
4	0	28	20	Indoor thermal overload
4	1	29	21	Indoor coil frosted
4	2	2A	/	PFC circuit loop overcurrent
4	3	2B	23	Module thermal overload
4	4	2C	24	Compressor start failure, over-current
4	5	2D	25	Phase current protection (IPM)
4	6	2E	26	MCU reset
4	7	2F	27	Module current detect circuit malfunction
4	8	30	28	Liquid pipe sensor failure: Circuit A
4	9	31	29	Liquid pipe sensor failure: Circuit B
5	0	32	30	Liquid pipe sensor failure: Circuit C
5	1	33	31	Liquid pipe sensor failure: Circuit D
5	2	34	32	Gas pipe sensor failure: Circuit A
5	3	35	33	Gas pipe sensor failure: Circuit B
5	4	36	34	Gas pipe sensor failure: Circuit C
5	5	37	35	Gas pipe sensor failure: Circuit D
5	6	38	36	Gas pipe sensor failure: Circuit E
5	7	39	/	Compressor overcurrent detected by IPM
5	8	3A	38	Malfunction of module temperature sensor momentary power failure detection
5	9	3B	39	Malfunction of condensing temperature sensor
6	0	3C	40	Liquid pipe sensor failure: Circuit E
6	1	3D	41	Toci temperature sensor failure
6	2	3E	42	High Pressure switch open
6	3	3F	43	Low Pressure switch open
6	4	40	44	System high pressure protection: Overcharged, high condensing temperature or malfunction of fan motor
6	5	41	45	System low pressure protection: Undercharged, low defrosting temperature, or malfunction of fan motor
0	1	01	/	Indoor ambient temperature sensor failure
0	2	02	/	Indoor coil temperature sensor failure
0	4	04	/	Indoor PCB EEPROM failure
0	7	07	/	Communication fault between the indoor and outdoor unit
0	8	08	/	Communication fault between the controller and Indoor unit
0	12	0C	/	Drain system malfunction
0	13	0D	/	Zero cross signal detected wrong
0	14	0E	/	Indoor fan motor malfunction



AD07SL2VHB
 AD09SL2VHB
 AD12SL2VHB
 AD18SL2VHB

Table of Contents

Components.....F-2

 Component Overview.....F-2

 Indoor Unit Circuit Board.....F-3

Ductwork/GrillesF-5

Testing.....F-6

 Test Condensate Pump and Float Switch.....F-6

 Testing Communication Circuit.....F-6

 Testing Temperature Sensors.....F-7

 Indoor Fan Motor Voltage Check.....F-7

Wiring Diagram & DIP Switch SettingsF-8

Error Codes.....F-9

Components

The Slim Duct Indoor Unit will act as evaporator coils during cooling mode and condenser coils during heating mode. This unit can operate with a motorized supply air louver or it can have a LIMITED amount of ducting added to the unit's return and supply air duct connection flanges. The return air ducting can be connected to the end of the cabinet or the bottom blank off plate can be removed for bottom return configuration.

DIP Switches on the unit's circuit board configure the fan power to match the ducting configuration.

These units have a built in condensate pump with an associated condensate level switch. The condensate pump is capable of lifting water out of the indoor unit. If high water lift is needed, the water from the cassette pump should be pumped into a field supplied condensate pump with high lift power.

The layout of the system is very straightforward and components are easily accessed should service be required. The blower assembly and room air temperature sensor is accessed at the rear of the evaporator coil, and the piping temperature sensor is located under the top cover. The condensate pump and float switch are accessed under the removable panel next to the electrical control box.

The wired controller can be configured to sense room air temperature. There is no option for use with remote control.

All operating status and information is displayed on the wired controller. The Slim Duct unit does not have a display.

Component Overview



Slim Duct units are controlled by a wired controller only.

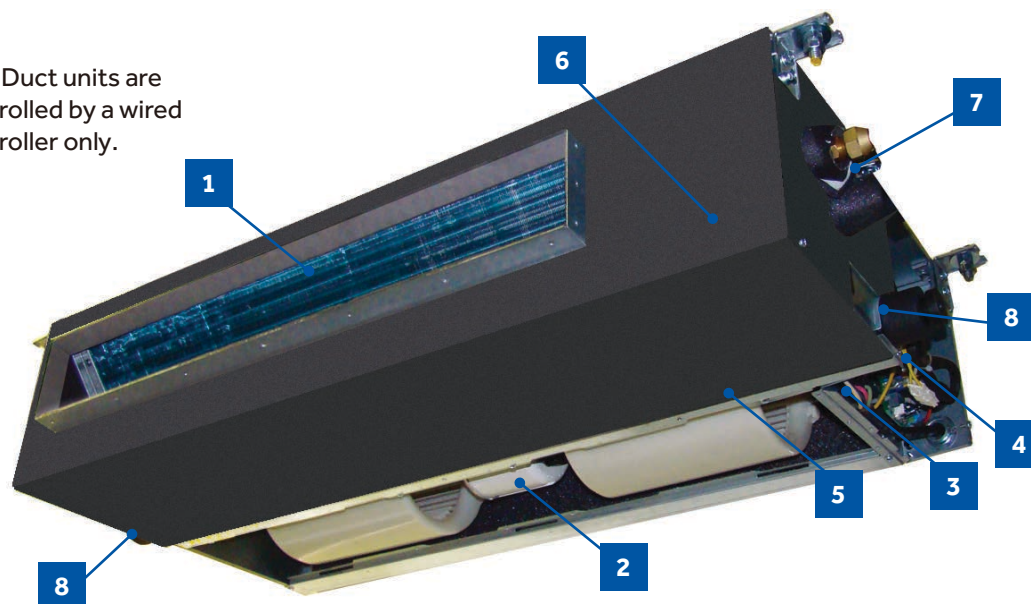

1 Evaporator Coil

2 Blower Assembly

The indoor unit features a DC variable speed dual shaft blower motor that will change speed to match the capacity demand from the outdoor unit. The motor is a dual shaft type that powers two individual blower assemblies.

The blower assembly consists of 2 plastic blowers. A set screw holds each blower wheel to the blower motor.

The indoor blower motor is connected to the indoor unit control board. The wiring from the motor to indoor board consists of 5 wires connected to pins that deliver line voltage, speed, and feedback information.

During normal operation, the indoor control board will energize the indoor blower motor and request proper speed. Fan power should be set using the DIP Switches SW1 settings.

3 Terminal Block

Power to operate the indoor unit comes from the electrical line voltage terminal block at the outdoor unit. The wiring includes 4 wires, 1, 2, 3 and ground. Wires 1 and 3 complete the data path. These wires should always be 14 gauge AWG Stranded type wire. Splices in wires 1 or 3 may cause communication errors.

4 Control Board

Located under the electrical control box cover.

5 Ambient Temperature Sensor

The Ambient Temperature Sensor senses room temperature. This sensor provides room temperature information to the ECU for calculation of inverter capacity and temperature control.

6 Piping Temperature Sensor

The Piping Temperature Sensor senses indoor coil temperature in the cooling mode and in the heating mode. This sensor is used for Anti Freezing and Anti Cold Blow cycles. The sensor also provides critical temperature information to the ECU that may be used in frequency adjustments.

7 Condensate Pump

The Slim Duct unit has a built in condensate pump. The pump is connected to the circuit board. The pump is energized whenever the Float Switch indicates that water needs to be pumped from the cassette. The float switch connects onto the circuit board.

The float switch and pump are located behind the removable insulated cover next to the electrical control box. The pump is hermetically sealed and requires no maintenance. The float switch is a normally closed switch, that opens as water rises. The float switch requires no maintenance.

8 Gravity Drain Ports

The indoor unit has the option for either gravity drain systems or the use of an internal condensate pump with float switch. The pump is capable of minimal lift. If high lift is required, the water from the Slim Duct unit should be pumped to a field supplied condensate pump that is capable of high lift.

Accessory Louver Motors (not shown)

Separate motors located in the accessory supply air louver control the operation of the motorized louvers. The louver motors are stepper type motors that move the louvers up/down. The motors are controlled by pulsed voltage that cannot be measured. If the louver does not move when it should, check for a bind in the louvers.

All of the louver motors are controlled via commands received from the remote control.

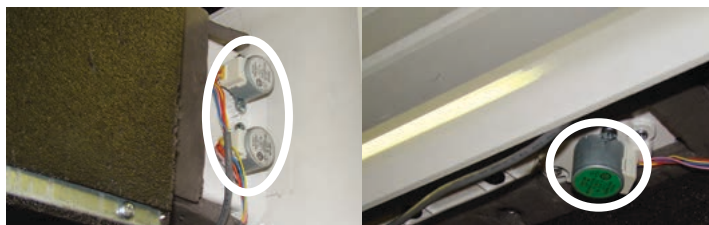

Indoor Unit Circuit Board

The indoor unit circuit board controls the switching functions of the indoor unit. All control decisions are made by the outdoor unit ECU. The indoor board has some limited diagnostic capability which will be covered in this manual.

- 1 L Terminal
- 2 N Terminal
- 3 Communication Terminal
- 4 5A 250V Fuse
- 5 CN13 Sensors
- 6 CN18 Float Switch
- 7 CN1 Wired Remote
- 8 DIP Switches
- 9 CN14 Stepper Motor
- 10 CN15 Stepper Motor
- 11 CN6 Fan Motor
- 12 CN9 Condensate Pump

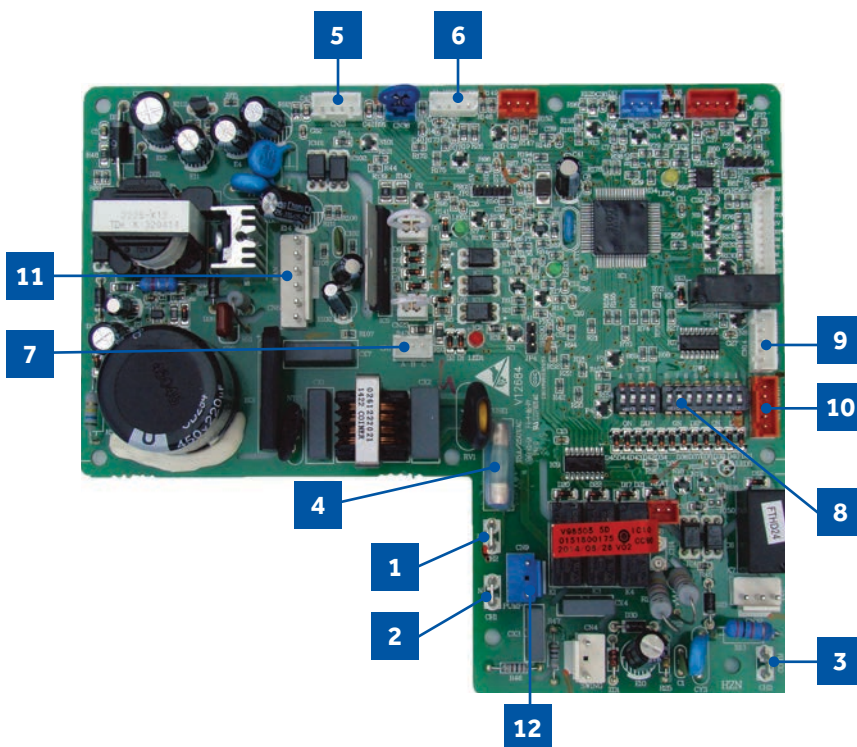

The Indoor Unit Circuit Board communicates with the outdoor unit ECU via a connection at Terminal Block screw 3. The data pulse that sends the communication information can be measured with a voltmeter placed to DCV range. From the ground connection at the Terminal Block to the Number 3 screw connection, the voltage should pulse up and down when data is being transmitted.

Line voltage to power the indoor unit comes in on Terminal Block connections 1 and 2. Power connects from these terminal connections to CH- 1 and CH-2 on the circuit board. If the board does not respond to commands and has no display, check for line voltage at these connections. When power is present at the indoor board, the wired controller will be energized.

The connections on the indoor board are shown here in the schematic drawing.

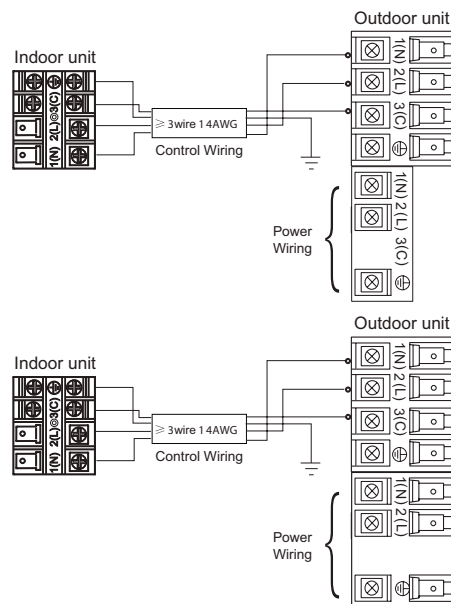

This control board has control over the fan louver movement, manual fan blower control, indoor coil temperature and indoor air temperature sensing functions. All operational decisions are controlled by the OUTDOOR UNIT ECU.

The control board has a replaceable 5A 250V fuse that protects against excessive current. If power is present at the board but the board does not work, check for continuity through the fuse. Replace if the fuse is open.

The indoor unit temperature sensors are connected at Plug CN-13. When testing the calibration of these sensors, the wires can be released from the plug by pressing on the tension tab on the side of the plug.

There 3 motors that control the directional movement of the accessory louver. The motor connects to the circuit board at Plug CN-14, CN-15 and CN-16. The motors are located in the louver assembly.

The blower motor is connected to the circuit board at plug CN-6.

SW1 DIP Switches

There are two sets of DIP switches on the Circuit Board. SW3 is for factory use only. SW1 is used to set the configuration of the indoor unit operation. The first three switches SW1-1, SW1-2 and SW1-3 select the indoor unit capacity.

Air Delivery Power is set with DIP Switches SW1-4 and SW1-5. The settings are shown in Hydrostatic Selection of 0Pa, up to 30Pa. SW1-7 and SW1-8 define the unit type. The conversions are as follows:

0Pa=0"w.c.

10Pa= .04"w.c.

20Pa=.08"w.c.

30Pa=.12"w.c.

- Recommended settings are for motorized Louver set to 10Pa.
- Ducting limited to a total of .12"w.c. External Static set to 30Pa.

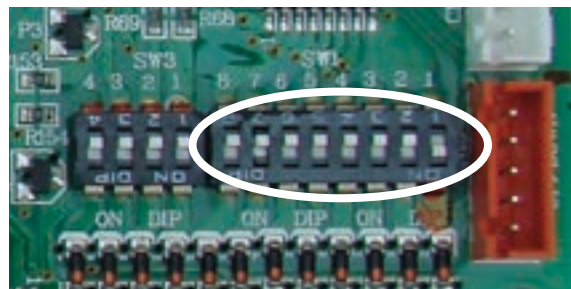

Basic Duct Configurations

Here are the typical duct configurations that can be used with the unit.

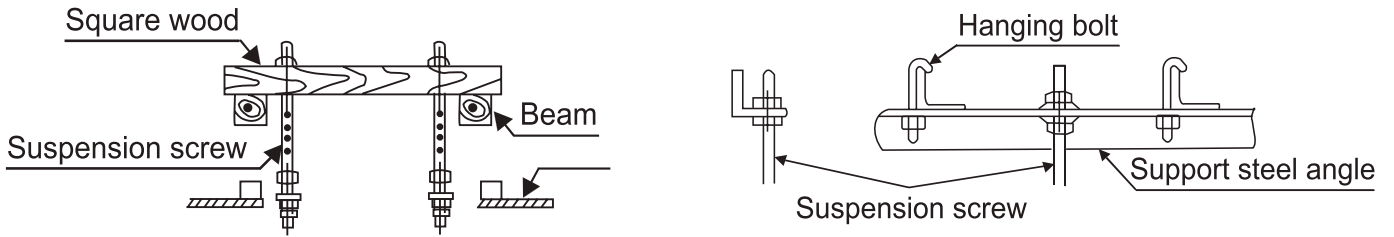

Ductwork Installation

Roof Installation

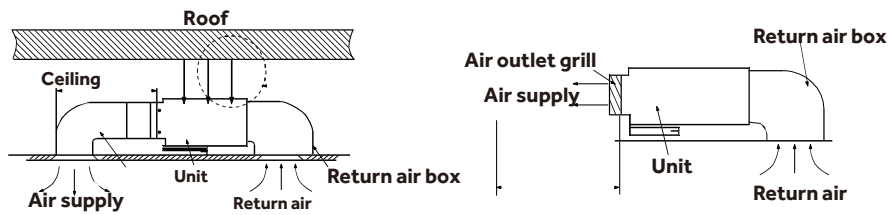

Long Duct

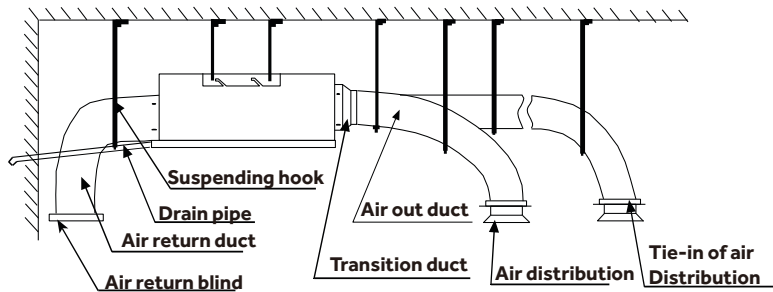

Use rivet to connect the air return duct on the air return inlet of the indoor unit, then connect the other end with the air return

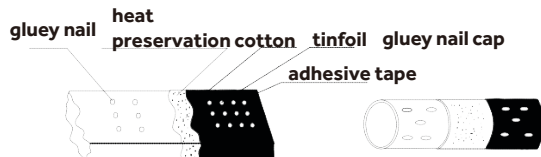
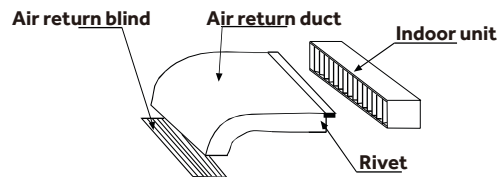
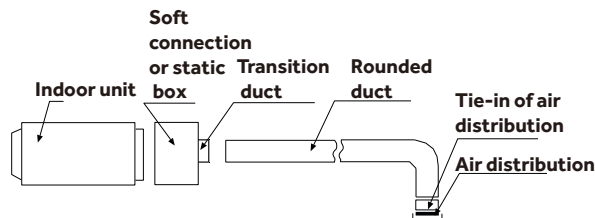

Test Condensate Pump and Float Switch

The unit has a built-in condensate pump and water level safety switch. There are also two optional ports for gravity drainage. The condensate pump is rated to lift water up to 27 9/16" from the point of discharge.

The unit comes with a grey connection hose with clamp. This hose is connected to the High ESP Duct unit condensate discharge hose port. The other end of the hose is sized to accept 3/4 inch PVC piping.

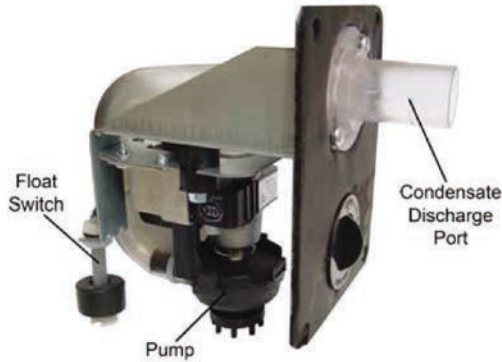

Recommended condensate piping configurations are shown here:

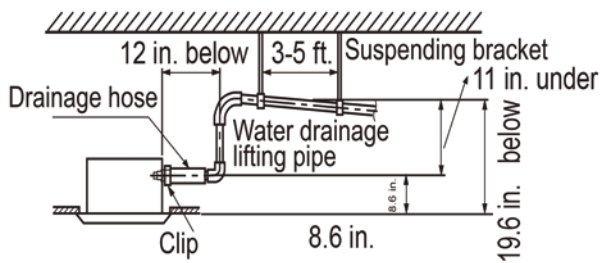

If the internal condensate pump does not operate, the pump may be bad or the float switch may be defective. Perform the following test:

1. Access the electrical control box.
2. Unplug the float switch from the circuit board.



3. The pump should start.
4. If the pump does not start, check for voltage at the control board pump connection. There should be 230 Volts AC to the pump. If there is not, the circuit board is defective. If there is proper voltage to the pump, either the pump or associated pump wiring is defective.

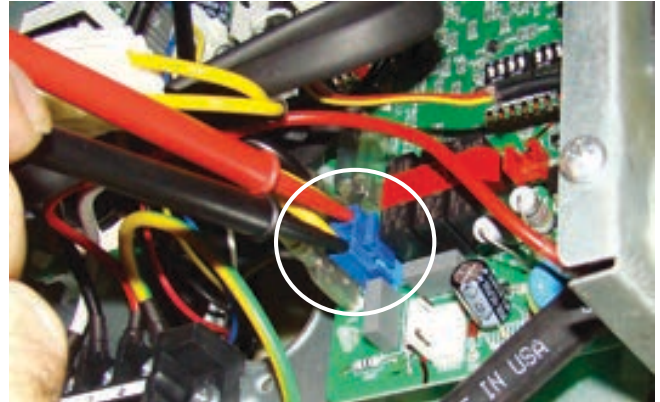

Testing Communication Circuit

If an Error E7 occurs, perform the following test to determine if the indoor control board is functioning properly to send data to the outdoor unit.

Perform this test with the unit powered and all wiring connected between indoor and outdoor unit.

Make sure all wiring between the indoor and outdoor unit are correct. There should no splices between the indoor and outdoor unit wiring connecting terminals 1 or 3. Make sure wiring is correct, before performing this test.

1. Measure the DC voltage between terminals 1 and 3 on the indoor terminal block.

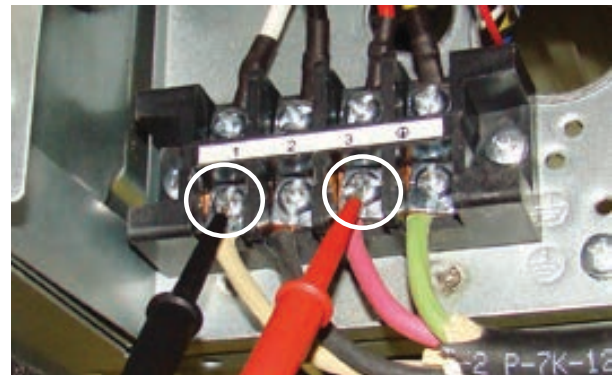

2. The voltage should fluctuate between 8VDC and 23VDC. The fluctuating signal indicates a good communication path.
3. If the voltage does not fluctuate, and the wiring is good, the indoor board is defective.

Testing Temperature Sensors

The easiest problems to solve will involve codes that are related to potential failure of temperature sensors. Common problems may include loose connections, open electrically, and out of calibration. Checking the condition of the sensors requires a temperature probe and an ohmmeter.

The Reference Section of this manual contains temperature resistance tables that can be used to check the calibration of the sensors. The measured resistance must be within the tolerances printed on the top of the tables.

1. Confirm the sensor is firmly attached to the circuit board connection plug.
2. Remove the sensor wires from the connection plug by releasing holding tension on the plugs tension tab.



3. Use an ohmmeter to test the electrical resistance of the sensor.

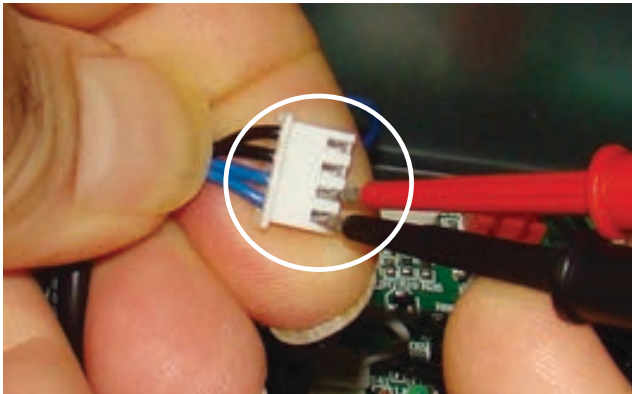

4. Measure the air temperature near the sensor and compare the required resistance against measured resistance. (refer to charts in reference section) If the sensor is within calibration, the sensor is good. If the sensor is out of calibration, replace the sensor. (Tube Sensors should be removed from socket and exposed to air temperature during test.)

Indoor Fan Motor Voltage Check

If The Indoor Fan Motor Does Not Run:

1. Remove the front cover and access the fan motor circuit board connection.
2. Reset power and turn the remote control fan command to Fan On mode.

Motor Test:

1. If the motor doesn't run, check for 310VDC between Pins 1 and 3. If it is not present, the indoor board is bad. If voltage is present, continue on.
2. Check the voltage between Pins 3 and 4. The voltage should be +15VDC. If it is not present, the board is bad. If voltage is present, continue on.
3. Check for voltage between Pins 3 and 6. If no DC voltage is present, the board is bad. If voltage is present, change the motor.

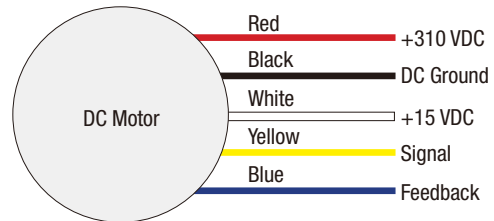
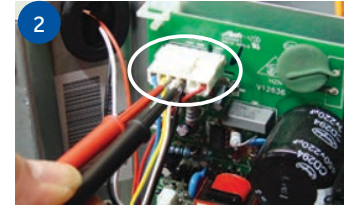
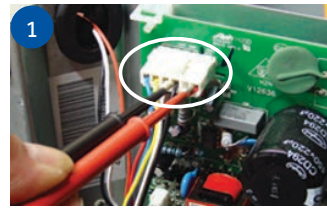

0150515412

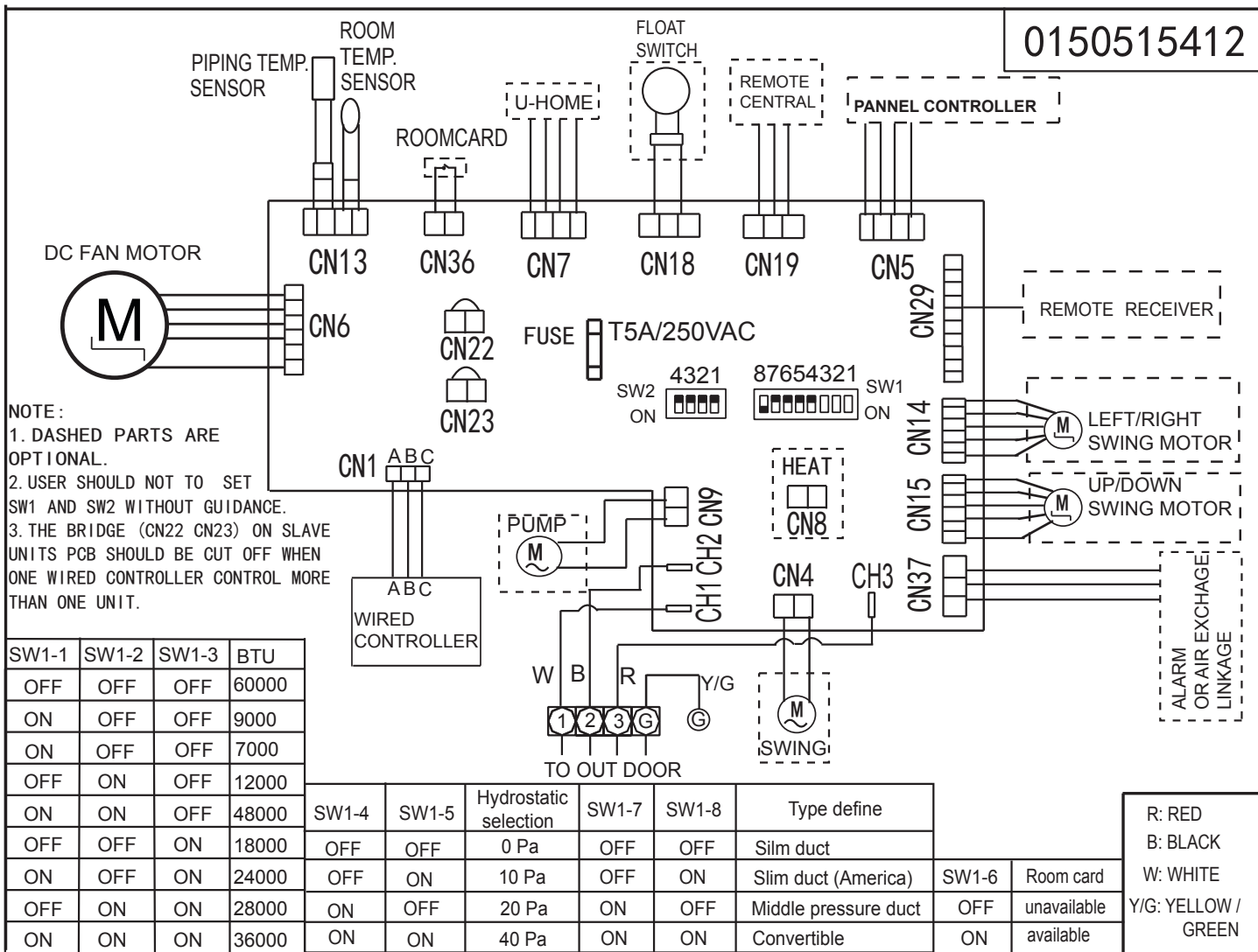

SW1-1	SW1-2	SW1-3	BTU
OFF	OFF	OFF	60000
ON	OFF	OFF	9000
ON	OFF	OFF	7000
OFF	ON	OFF	12000
ON	ON	OFF	48000
OFF	OFF	ON	18000
ON	OFF	ON	24000
OFF	ON	ON	28000
ON	ON	ON	36000

SW1-4	SW1-5	Hydrostatic selection	SW1-7	SW1-8	Type define
OFF	OFF	0 Pa	OFF	OFF	Silm duct
OFF	ON	10 Pa	OFF	ON	Slim duct (America)
ON	OFF	20 Pa	ON	OFF	Middle pressure duct
ON	ON	40 Pa	ON	ON	Convertible

SW1-6	Room card
OFF	unavailable
ON	available

R: RED
 B: BLACK
 W: WHITE
 Y/G: YELLOW / GREEN

Error Codes

The error codes that are displayed on the indoor units may vary from the outdoor unit codes. The information communicated by the error code will be the SAME for both indoor and outdoor units even though the numbers may differ.

Indoor LED4	Indoor LED3	Outdoor LED	Diagnosis
2	1	1	Outdoor EEPROM failure
2	2	2	IPM overcurrent or short circuit
2	3	/	Compressor over current during deceleration
2	4	4	Communication failure between the IPM and outdoor PCB
2	5	5	Module operated overload (compressor overload protection)
2	6	6	Module low or high voltage
2	7	/	Compressor current sampling circuit fault
2	8	8	Overheat protection for discharge temperature
2	9	9	Malfunction of the DC fan motor
3	0	10	Malfunction of defrost temperature sensor
3	1	11	Suction temperature sensor failure
3	2	12	Ambient temperature sensor failure
3	3	13	Discharge temperature sensor failure
3	4	/	PFC circuit loop voltage
3	5	15	Communication failure between the indoor & outdoor unit
3	6	16	Lack of refrigerant or discharging
3	7	17	4-way valve switching failure
3	8	18	Loss of synchronism detection
3	9	/	Low DC or AC voltage
4	0	20	Indoor thermal overload
4	1	21	Indoor coil frosted
4	2	/	PFC circuit loop overcurrent
4	3	23	Module thermal overload
4	4	24	Compressor start failure, over-current
4	5	25	Phase current protection (IPM)
4	6	26	MCU reset
4	7	27	Module current detect circuit malfunction
4	8	28	Liquid pipe sensor failure: Circuit A
4	9	29	Liquid pipe sensor failure: Circuit B
5	0	30	Liquid pipe sensor failure: Circuit C
5	1	31	Liquid pipe sensor failure: Circuit D
5	2	32	Gas pipe sensor failure: Circuit A
5	3	33	Gas pipe sensor failure: Circuit B
5	4	34	Gas pipe sensor failure: Circuit C
5	5	35	Gas pipe sensor failure: Circuit D
5	6	36	Gas pipe sensor failure: Circuit E
5	7	/	Compressor overcurrent detected by IPM
5	8	38	Malfunction of module temperature sensor momentary power failure detection
5	9	39	Malfunction of condensing temperature sensor
6	0	40	Liquid pipe sensor failure: Circuit E
6	1	41	Toci temperature sensor failure
6	2	42	High Pressure switch open
6	3	43	Low Pressure switch open
6	4	44	System high pressure protection: Overcharged, high condensing temperature or malfunction of fan motor
6	5	45	System low pressure protection: Undercharged, low defrosting temperature, or malfunction of fan motor
0	1	/	Indoor ambient temperature sensor failure
0	2	/	Indoor coil temperature sensor failure
0	4	/	Indoor PCB EEPROM failure
0	7	/	Communication fault between the indoor and outdoor unit
0	8	/	Communication fault between the controller and Indoor unit
0	17	/	DC voltage of the fan motor driver too high or too low
0	18	/	Fan motor driver over 95°F (35°C)
0	19	/	Indoor fan motor out of step
0	12	/	Drain system malfunction
0	13	/	Zero cross signal detected wrong
0	14	/	Indoor fan motor malfunction
0	15	/	Indoor fan motor overcurrent



USYM09UCDSA
 USYM12UCDSA
 USYM18UCDSA
 USYM24UCDSA

Table of Contents

Components..... **G-2**

 Component Overview..... G-2

 Indoor Unit Circuit Board..... G-4

 Fresh Air Function..... G-5

Ductwork/Grilles **G-6**

Testing..... **G-7**

 Test Condensate Pump and Associated Float Switch G-7

 Testing Temperature Sensors G-7

 Testing Communication Circuit G-8

 Indoor Fan Motor Voltage Check G-8

 Static Pressure Charts..... G-9

 Board Replacement G-10

 Removing the Condensate Pump G-10

 Removing Fan Motor G-10

 Replacing WiFi Module..... G-11

Wiring Diagram..... **G-12**

DIP Switch Settings **G-13**

Error Codes..... **G-14**

Components

The Mid-Static Ducted Indoor Unit will act as evaporator coils during cooling mode and condenser coils during heating mode. This unit can operate with a motorized supply air louver or it can have a LIMITED amount of ducting added to the unit's return and supply air duct connection flanges. The return air ducting can be connected to the end of the cabinet or the bottom blank off plate can be removed for bottom return configuration.

DIP Switches on the unit's circuit board configure the fan power to match the ducting configuration.

These units have a built in condensate pump with an associated condensate level switch. The condensate pump is capable of lifting water out of the indoor unit. If high water lift is needed, the water from the cassette pump should be pumped into a field supplied condensate pump with high lift power.

The layout of the system is very straightforward and components are easily accessed should service be required. The blower assembly and room air temperature sensor is accessed at the rear of the evaporator coil, and the piping temperature sensor is located under the top cover. The condensate pump and float switch are accessed under the removable panel next to the electrical control box.

The wired controller can be configured to sense room air temperature. There is no option for use with remote control.

All operating status and information is displayed on the wired controller. The Mid-Static Ducted unit does not have a display.

Component Overview

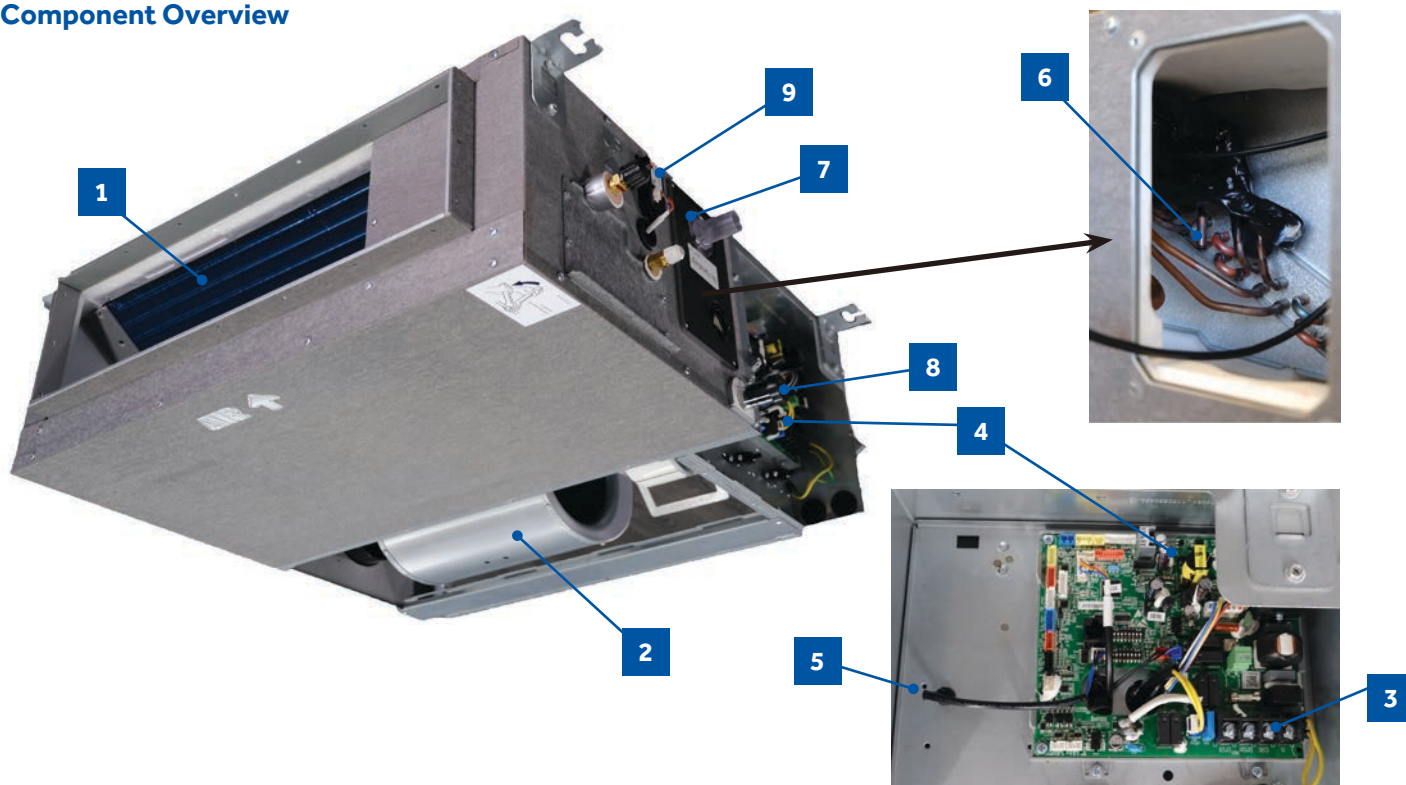

1 Evaporator Coil

2 Blower Assembly

The indoor unit features a DC variable speed dual shaft blower motor that will change speed to match the capacity demand from the outdoor unit. The motor is a dual shaft type that powers two individual blower assemblies.

The blower assembly consists of 2 plastic blowers. A set screw holds each blower wheel to the blower motor.

The indoor blower motor is connected to the indoor unit control board. The wiring from the motor to indoor board consists of 5 wires connected to pins that deliver line voltage, speed, and feedback information.

During normal operation, the indoor control board will energize the indoor blower motor and request proper speed. Fan power should be set using the DIP Switches SW1 settings.

3 Terminal Block

Power to operate the indoor unit comes from the electrical line voltage terminal block at the outdoor unit. The wiring includes 4 wires, 1, 2, 3 and ground. Wires 1 and 3 complete the data path. These wires should always be 14 gauge AWG Stranded type wire. Splices in wires 1 or 3 may cause communication errors.

4 Control Board

Located under the electrical control box cover.

5 Ambient Temperature Sensor

The Ambient Temperature Sensor senses room temperature. This sensor provides room temperature information to the ECU for calculation of inverter capacity and temperature control.

6 Piping Temperature Sensor

The Piping Temperature Sensor senses indoor coil temperature in the cooling mode and in the heating mode. This sensor is used for Anti Freezing and Anti Cold Blow cycles. The sensor also provides critical temperature information to the ECU that may be used in frequency adjustments.

7 Condensate Pump

The Mid-Static Ducted unit has a built in condensate pump. The pump is connected to the circuit board. The pump is energized whenever the Float Switch indicates that water needs to be pumped from the cassette. The float switch connects onto the circuit board.

The float switch and pump are located behind the removable insulated cover next to the electrical control box. The pump is hermetically sealed and requires no maintenance. The float switch is a normally closed switch, that opens as water rises. The float switch requires no maintenance.

8 Gravity Drain Ports

The indoor unit has the option for either gravity drain systems or the use of an internal condensate pump with float switch. The pump is capable of minimal lift. If high lift is required, the water from the Mid-Static Ducted unit should be pumped to a field supplied condensate pump that is capable of high lift.

WiFi

The unit comes shipped with a WiFi module that provides control via a smartphone app.

Indoor Unit Circuit Board

The indoor unit circuit board controls the switching functions of the indoor unit. All control decisions are made by the outdoor unit ECU. The indoor board has some limited diagnostic capability which will be covered in this manual.

- 1 CN17-GEA3 wifi module socket
- 2 CN6-DC fan motor socket
- 3 CN10-Fresh air link/E.A.O socket
- 4 CN-4-Frelay for auxiliary heater link (Dry contact, rating- 230VAC ,3A)
- 5 CN1- Power terminal block
- 6 CN19-Float switch socket
- 7 CN3-Temperature sensor socket (Tr:ROOM SENSOR, Tp:PIPE SENSOR)
- 8 CN22-1-Wired controller socket2
- 9 CN22-Wired controller socket 1

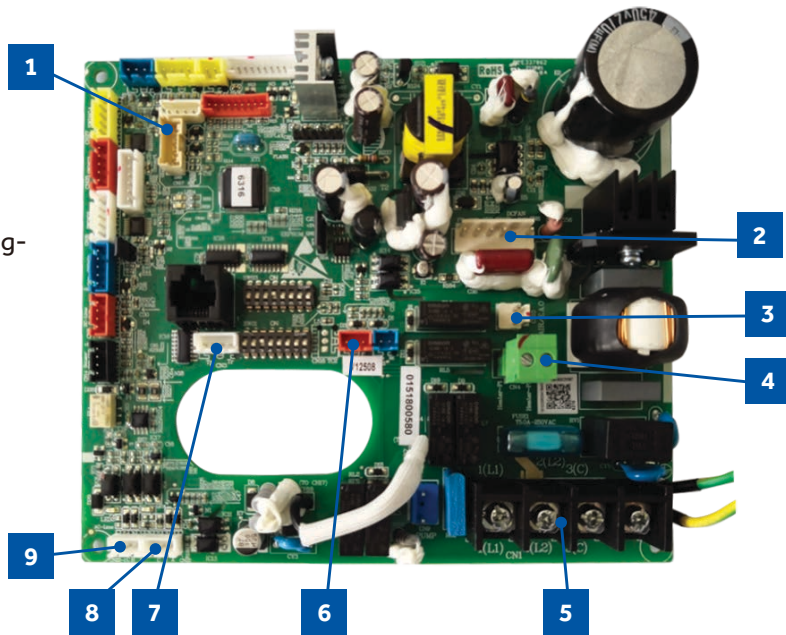

The Indoor Unit Circuit Board communicates with the outdoor unit ECU via a connection at Terminal Block screw 3. The data pulse that sends the communication information can be measured with a voltmeter placed to DCV range. From the ground connection at the Terminal Block to the Number 3 screw connection, the voltage should pulse up and down when data is being transmitted.

Line voltage to power the indoor unit comes in on Terminal Block connections 1 and 2. Power connects from these terminal connections to CH- 1 and CH-2 on the circuit board. If the board does not respond to commands and has no display, check for line voltage at these connections. When power is present at the indoor board, the wired controller will be energized.

The connections on the indoor board are shown here in the schematic drawing.

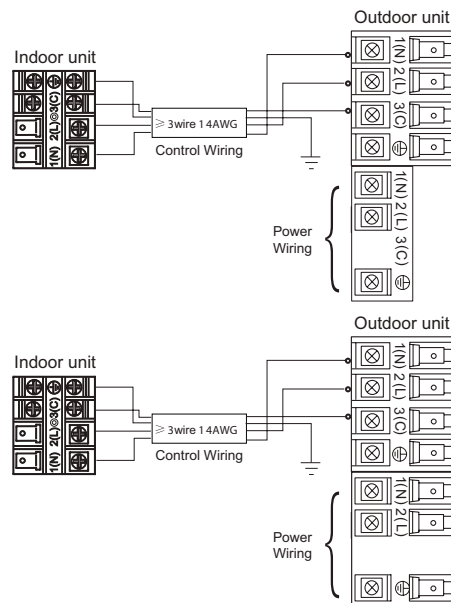

This control board has control over the fan louver movement, manual fan blower control, indoor coil temperature and indoor air temperature sensing functions. All operational decisions are controlled by the OUTDOOR UNIT ECU.

The control board has a replaceable 5A 250V fuse that protects against excessive current. If power is present at the board but the board does not work, check for continuity through the fuse. Replace if the fuse is open.

The indoor unit temperature sensors are connected at Plug CN-13. When testing the calibration of these sensors, the wires can be released from the plug by pressing on the tension tab on the side of the plug.

There 3 motors that control the directional movement of the accessory louver. The motor connects to the circuit board at Plug CN-14, CN-15 and CN-16. The motors are located in the louver assembly.

The blower motor is connected to the circuit board at plug CN-6.

Fresh Air Function

When there is fresh air signal received by the Indoor Unit PCB (the fresh air signal can be sent by infrared remote controller or wired controller), the Normal fresh air function is valid.

When a call for Fresh Air is received, via the wireless or wired controller, the unit will enable the standard fresh air function.

This function can be activated at any mode except defrost mode. When the IDU been turned off by controller, the fresh air function is invalid. This function can be activated in any mode, except for defrost mode. When the Indoor Unit has been turned off via the controller, the fresh air function will be disabled.

Call for Fresh Air is Received:

In Cooling / Dehumidification mode:

The fresh air output will maintain a 20 minutes ON, 20 minutes OFF cycle after the compressor starts.

This cycle will be active until one of the following occurs:

- Fresh air function is canceled via the controller (wired controller or wireless remote controller)
- Indoor unit has been via the controller
- The compressor stops.

In Fan Only mode:

The fresh air output will maintain a 20 minutes ON, 20 minutes OFF cycle

This cycle will be active until one of the following occurs:

- Fresh air function is canceled via the controller (wired controller or wireless remote controller)
- Indoor unit has been via the controller

In Heating mode

The fresh air output will maintain a 20 minutes ON, 20 minutes OFF cycle after the compressor starts.

This cycle will be active until one of the following occurs:

- Fresh air function is canceled via the controller (wired controller or wireless remote controller)
- Indoor unit has been via the controller
- The compressor stops.
- The system enters into Defrost Cycle.

Special Fresh Air Function (Canadian Ventilation Mode - Mid Static Ducted Only)

Special fresh air function (Canadian ventilation mode) is valid when DIP switch SW3_1 is set to the ON position, and invalid when DIP switch SW3_1 is set to OFF position.

When this function is enabled and the Indoor Unit is ON, the the unit will proceed Continuous Fresh Air, keeping the Indoor Fan Motor energized even if the compressor is stopped or the IDU reaches it's real setpoint temperature (real setpoint=customer set point + compensation point).

Notes:

- *During an active Call, the fan motor speed will be whatever setting the customer has set it to. Once the Call is satisfied, the fan motor speed will be set to a special Low setting that corresponds to the ESP setting.*
- *During a Defrost Cycle, the indoor fan is disabled, along with the Fresh Air Function*

Basic Duct Configurations

Here are the typical duct configurations that can be used with the unit.

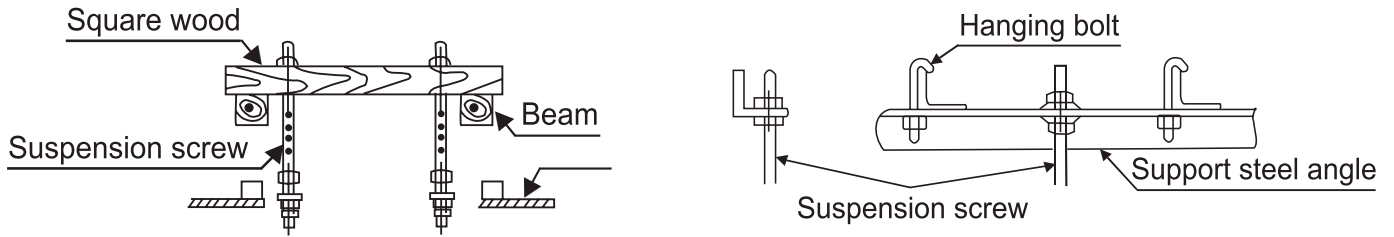

Ductwork Installation

Roof Installation

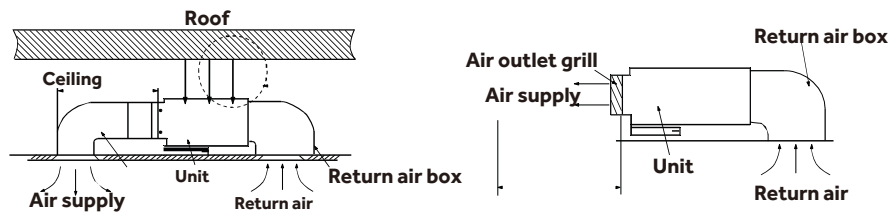

Long Duct

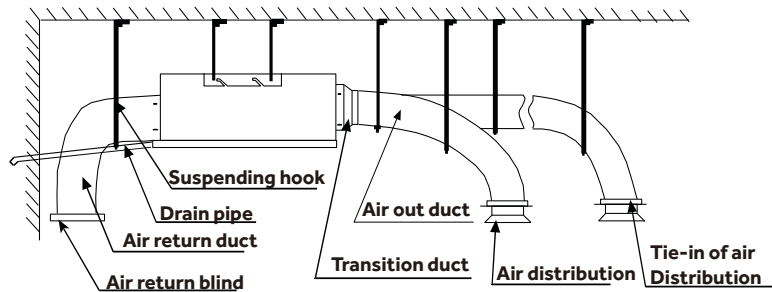

Use rivet to connect the air return duct on the air return inlet of the indoor unit, then connect the other end with the air return

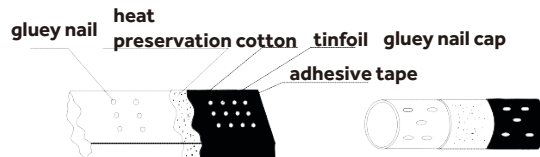
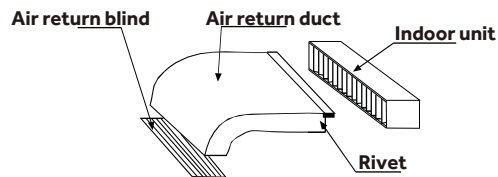
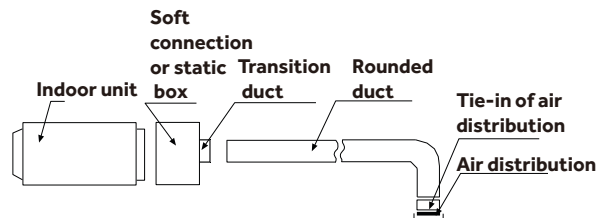

Test Condensate Pump and Associated Float Switch

If the internal condensate pump does not operate, the pump may be bad or the float switch may be defective. Perform the following test:

1. Access the electrical control box.
2. Unplug the float switch from the circuit board.

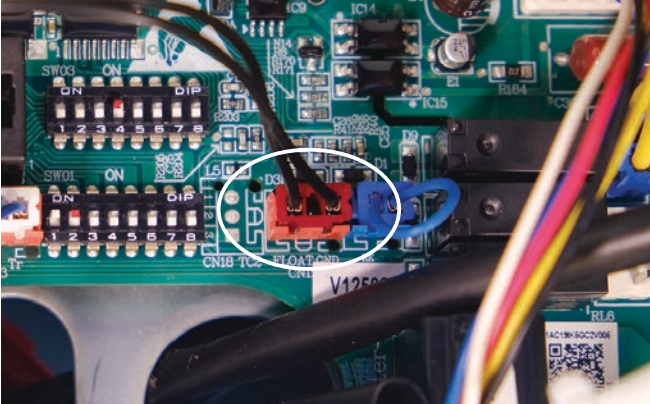

3. The pump should start.
4. If the pump does not start, check for voltage at the pump control board connection. There should be 230 Volts AC to the pump. If there is not, the circuit board is defective. If there is proper voltage to the pump, either the pump or associated pump wiring is defective.

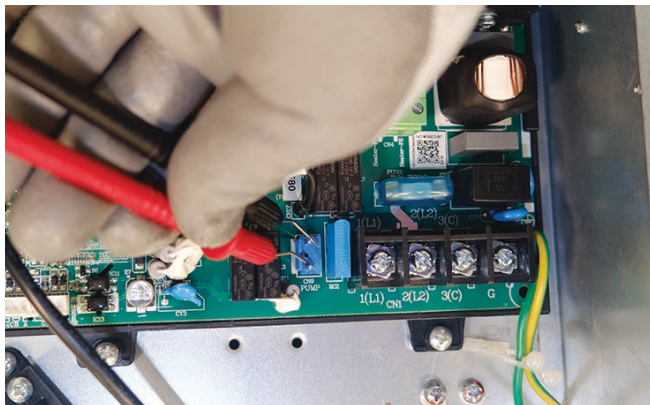

Testing Temperature Sensors

The easiest problems to solve will involve codes that are related to potential failure of temperature sensors. Common problems may include loose connections, open electrically, and out of calibration. Checking the condition of the sensors requires a temperature probe and an ohmmeter.

The Reference Section of this manual contains temperature resistance tables that can be used to check the calibration of the sensors. The measured resistance must be within the tolerances printed on the top of the tables.

1. Confirm the sensor is firmly attached to the circuit board connection plug.
2. Remove the sensor wires from the connection plug by releasing holding tension on the plugs tension tab.

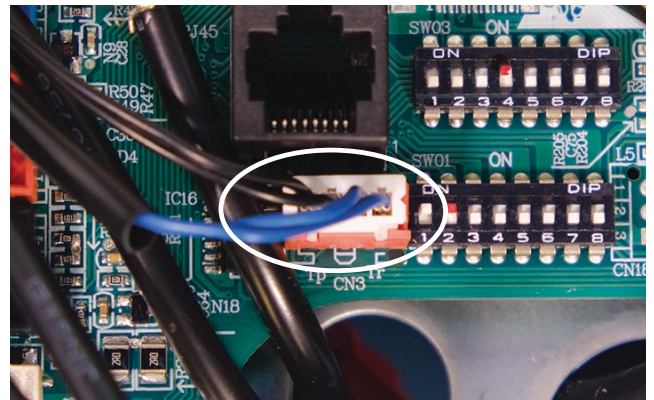

3. Use an ohmmeter to test the electrical resistance of the sensor.

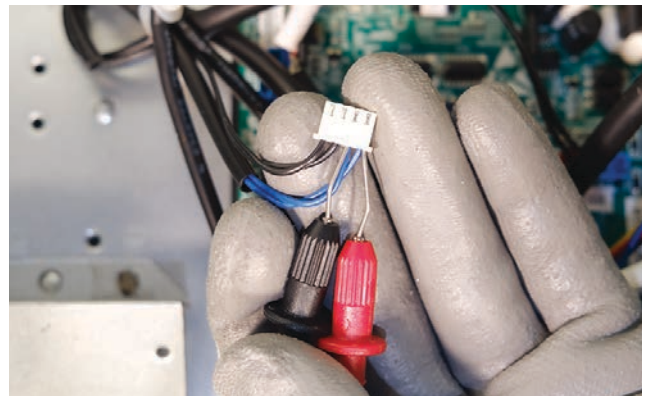

4. Measure the air temperature near the sensor and compare the required resistance against measured resistance. (refer to charts in reference section) If the sensor is within calibration, the sensor is good. If the sensor is out of calibration, replace the sensor. (Tube Sensors should be removed from socket and exposed to air temperature during test.)

Testing Communication Circuit

If an Error E7 occurs, perform the following test to determine if the indoor control board is functioning properly to send data to the outdoor unit.

Perform this test with the unit powered and all wiring connected between indoor and outdoor unit.

Make sure all wiring between the indoor and outdoor unit are correct. There should be no splices between the indoor and outdoor unit wiring connecting terminals 1 or 3. Make sure wiring is correct, before performing this test.

1. Measure the DC voltage between terminals 1 and 3 on the indoor terminal block.

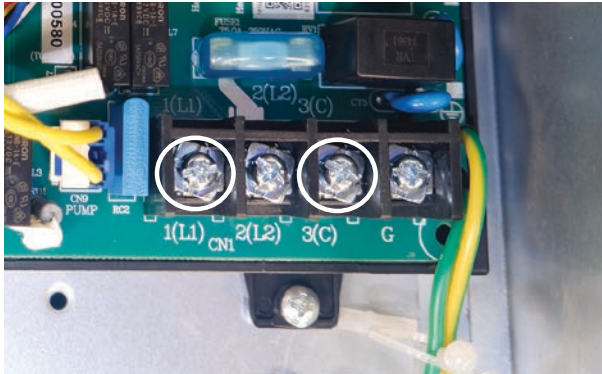

2. The voltage should fluctuate between 8VDC and 23VDC. The fluctuating signal indicates a good communication path.
3. If the voltage does not fluctuate, and the wiring is good, the indoor board is defective.

Indoor Fan Motor Voltage Check

If The Indoor Fan Motor Does Not Run:

1. Remove the front cover and access the fan motor circuit board connection.
2. Reset power and turn the remote control fan command to Fan On mode.

Motor Test:

1. If the motor doesn't run, check for 310VDC between Pins 1 and 3. If it is not present, the indoor board is bad. If voltage is present, continue on.
2. Check the voltage between Pins 3 and 4. The voltage should be +15VDC. If it is not present, the board is bad. If voltage is present, continue on.
3. Check for voltage between Pins 3 and 6. If no DC voltage is present, the board is bad. If voltage is present, change the motor.

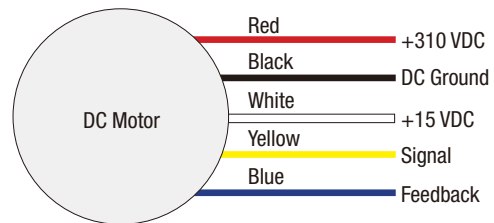
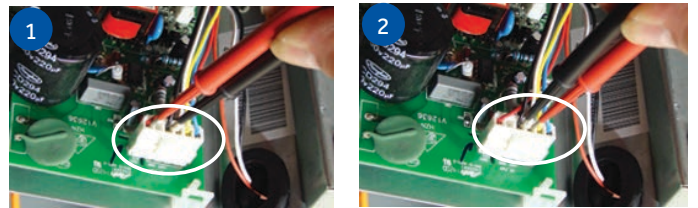

Static Pressure Charts

USYM09UCDSA

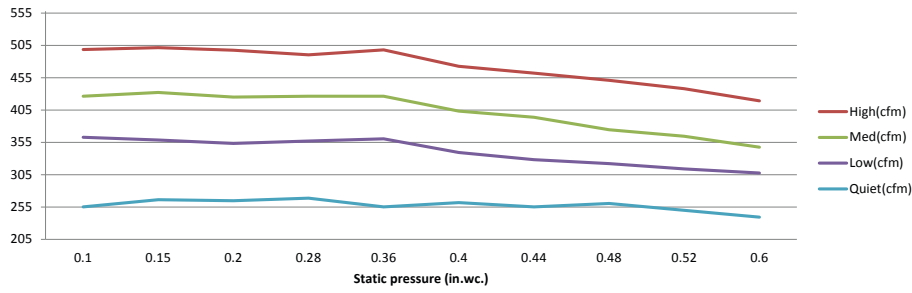

USYM12UCDSA

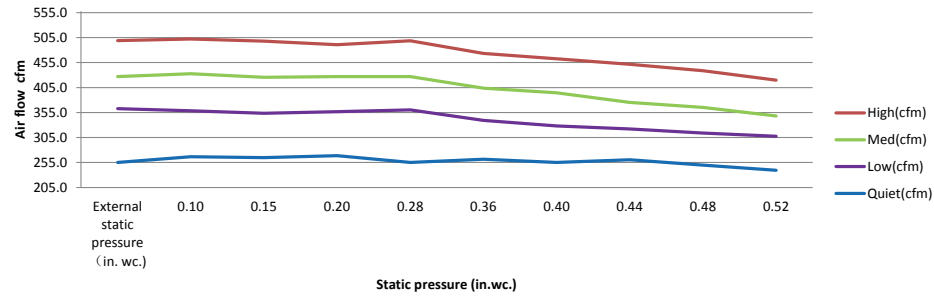

USYM18UCDSA

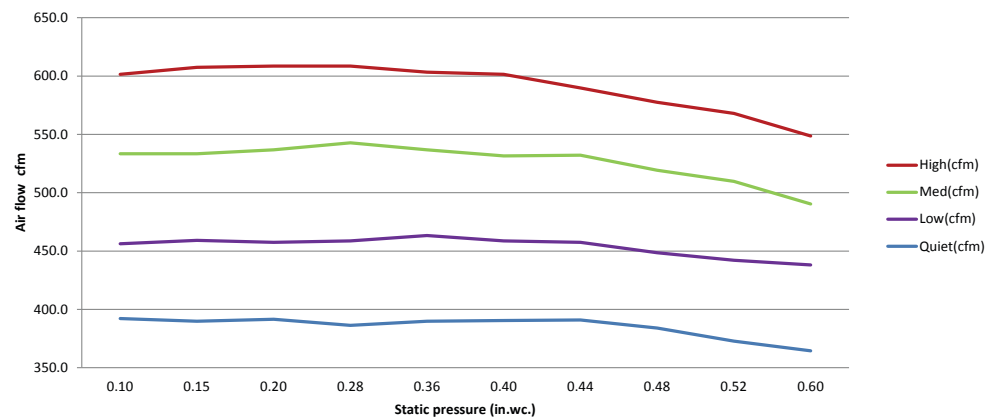

USYM24UCDSA

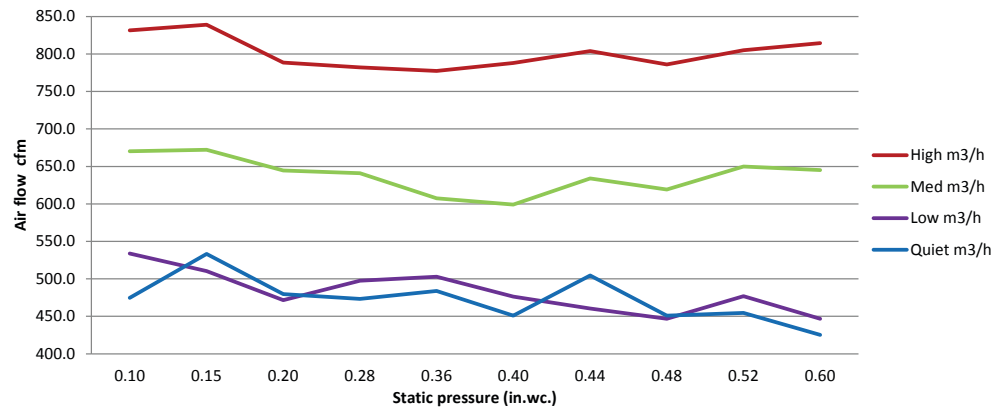

Board Replacement

1. Remove the ambient sensor.



2. Unplug all connectors from the board.
3. Remove the 2 board mounting screws and remove the board.

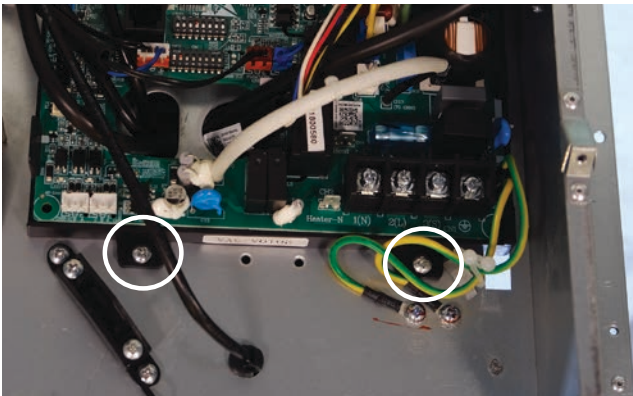

Removing the Condensate Pump

1. Remove the air inlet cover.

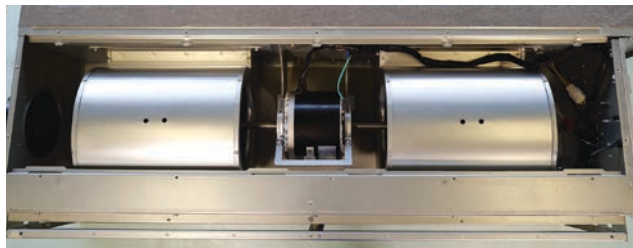

2. Unplug the pump motor and float switch wires from within the air inlet



3. Remove the 4 screws holding the pump in place.

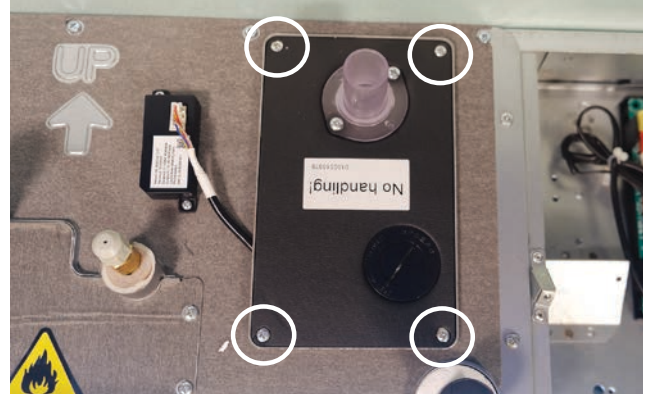

4. Tilt the pump out from the top and pull out

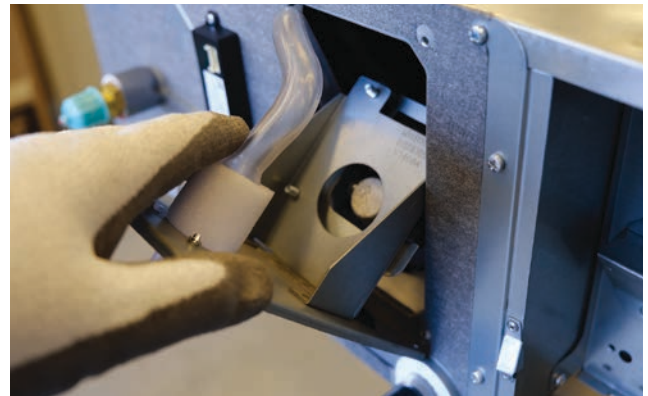

5. Pull wires through rubber grommets and remove pump assembly

Removing Fan Motor

1. Remove control board cover.
2. Unplug motor wires.



Testing

3. Feed motor wires into the air inlet box
4. Remove the air box cover.

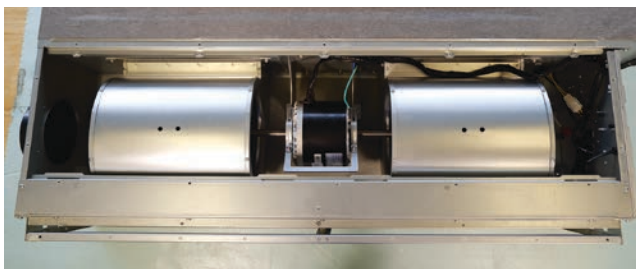

5. Remove the corner bracket.

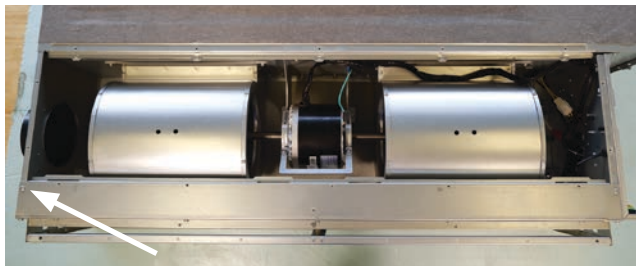

6. Remove the ground screw and free the motor wire harness.

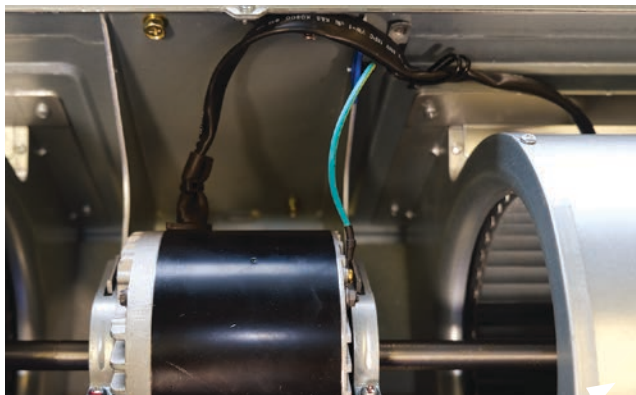

7. Remove the screws holding the blower housing to the unit, 4 on each housing.

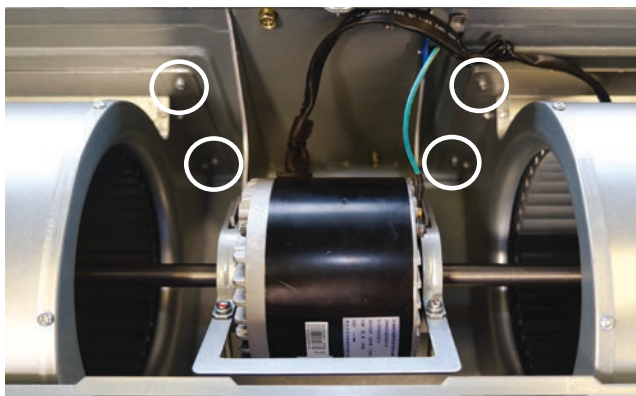

8. Support the motor (2 people may be required at this time). Loosen the 2 screws of the motor mount bracket and remove full assembly
9. Using a long 4mm hex wrench, loosen the set screws from the blower wheel and remove from motor shaft.

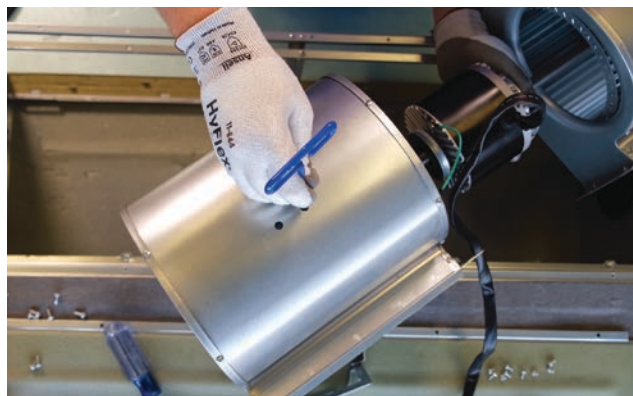

Replacing WiFi Module

1. Unplug existing WiFi module.

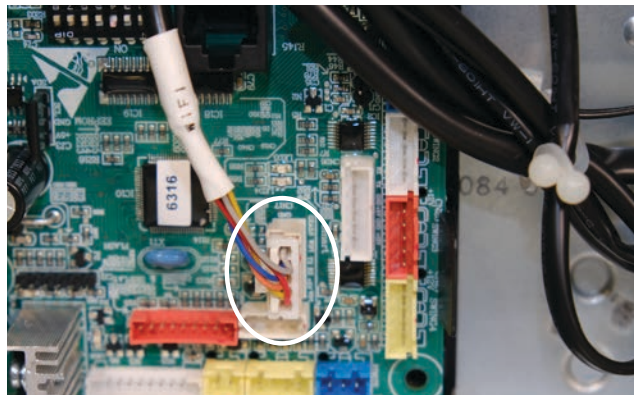

2. Insert new WiFi module.
3. Replace the wifi passcode sticker.
4. Pair the unit to account.

Wiring Diagram

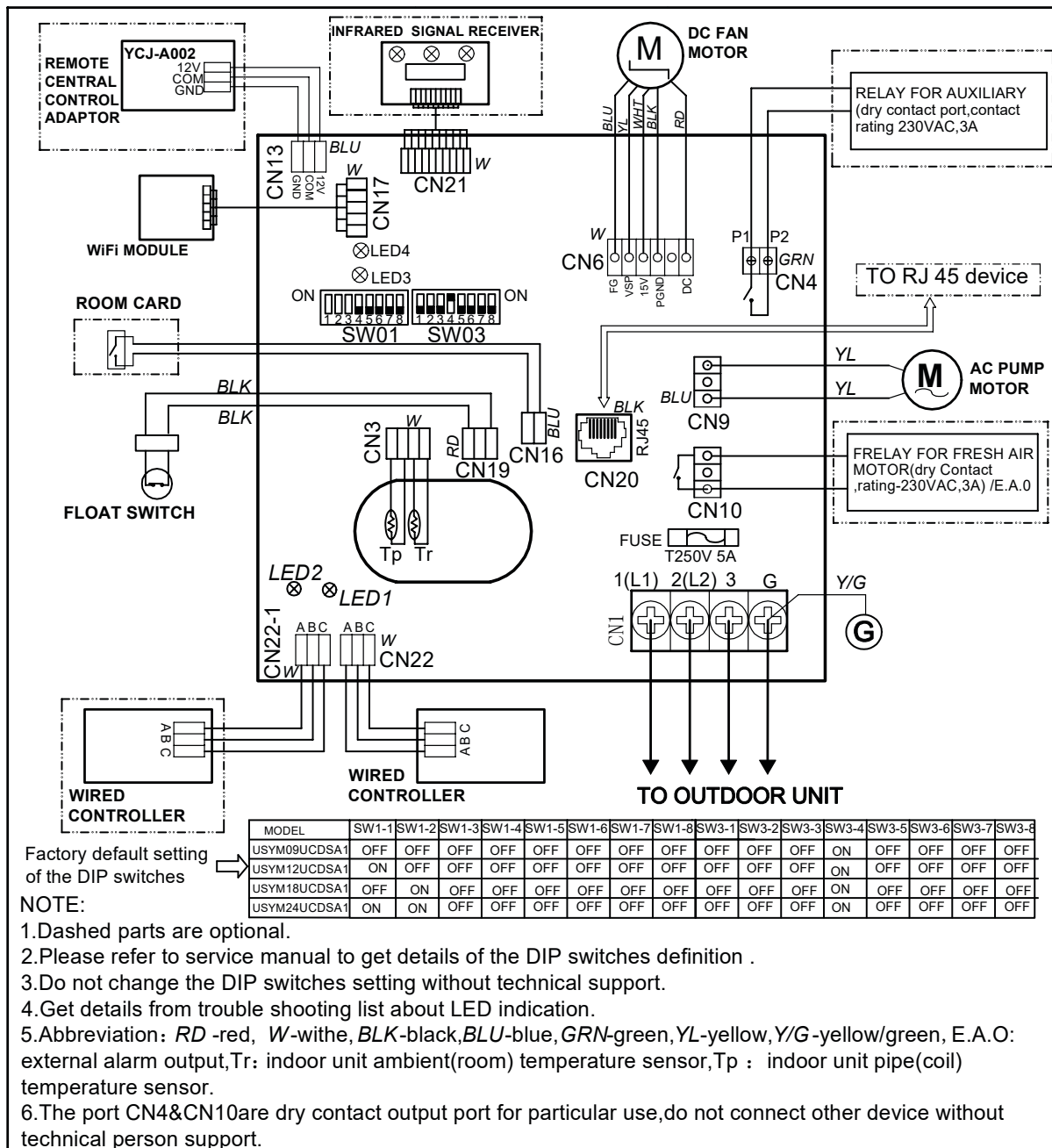

0151539442

DIP Switch Settings

SW1 DIP Switch Settings

Description	SW1-1	SW1-2	SW1-3	SW1-4	SW1-5	SW1-6	SW1-7	SW1-8
Capacity: 9000btu/h	OFF	OFF	OFF	---	---	---	---	---
Capacity: 12000btu/h	ON	OFF	OFF	---	---	---	---	---
Capacity: 18000btu/h	OFF	ON	OFF	---	---	---	---	---
Capacity: 24000btu/h	ON	ON	OFF	---	---	---	---	---
Room card invalid	---	---	---	OFF*	---	---	---	---
Room card valid	---	---	---	ON	---	---	---	---
Heat pump	---	---	---	---	OFF*	---	---	---
Cooling only	---	---	---	---	ON	---	---	---
Fresh air valid	---	---	---	---	---	OFF*	---	---
External alarm output	---	---	---	---	---	ON	---	---
Without filter clean warning	---	---	---	---	---	---	OFF*	---
With filter clean warning	---	---	---	---	---	---	ON	---
North America area	---	---	---	---	---	---	---	OFF*
Non-North America area	---	---	---	---	---	---	---	ON

*Factory Default Setting

SW3 DIP Switch Settings

Description	SW3-1	SW3-2	SW3-3	SW3-4
Special fresh air (Canadian ventilation mode, Canada particular Area) invalid	OFF*	---	---	---
Special fresh air (Canadian ventilation mode, Canada particular Area) valid	ON	---	---	---
Console/MESP Duct	---	OFF*	---	---
Cassette (Reserved)	---	ON	---	---
Auxiliary heater invalid	---	---	OFF*	---
Auxiliary heater valid	---	---	ON	---
ESP grade 0-4 level	---	---	---	OFF
ESP grade 0-10 level	---	---	---	ON*

*Factory Default Setting

Error Codes

The error codes that are displayed on the indoor units may vary from the outdoor unit codes. The information communicated by the error code will be the SAME for both indoor and outdoor units even though the numbers may differ.

Indoor LED4	Indoor LED3	Outdoor LED	Diagnosis
2	1	1	Outdoor EEPROM failure
2	2	2	IPM overcurrent or short circuit
2	3	/	Compressor over current during deceleration
2	4	4	Communication failure between the IPM and outdoor PCB
2	5	5	Module operated overload (compressor overload protection)
2	6	6	Module low or high voltage
2	7	/	Compressor current sampling circuit fault
2	8	8	Overheat protection for discharge temperature
2	9	9	Malfunction of the DC fan motor
3	0	10	Malfunction of defrost temperature sensor
3	1	11	Suction temperature sensor failure
3	2	12	Ambient temperature sensor failure
3	3	13	Discharge temperature sensor failure
3	4	/	PFC circuit loop voltage
3	5	15	Communication failure between the indoor & outdoor unit
3	6	16	Lack of refrigerant or discharging
3	7	17	4-way valve switching failure
3	8	18	Loss of synchronism detection
3	9	/	Low DC or AC voltage
4	0	20	Indoor thermal overload
4	1	21	Indoor coil frosted
4	2	/	PFC circuit loop overcurrent
4	3	23	Module thermal overload
4	4	24	Compressor start failure, over-current
4	5	25	Phase current protection (IPM)
4	6	26	MCU reset
4	7	27	Module current detect circuit malfunction
4	8	28	Liquid pipe sensor failure: Circuit A
4	9	29	Liquid pipe sensor failure: Circuit B
5	0	30	Liquid pipe sensor failure: Circuit C
5	1	31	Liquid pipe sensor failure: Circuit D
5	2	32	Gas pipe sensor failure: Circuit A
5	3	33	Gas pipe sensor failure: Circuit B
5	4	34	Gas pipe sensor failure: Circuit C
5	5	35	Gas pipe sensor failure: Circuit D
5	6	36	Gas pipe sensor failure: Circuit E
5	7	/	Compressor overcurrent detected by IPM
5	8	38	Malfunction of module temperature sensor momentary power failure detection
5	9	39	Malfunction of condensing temperature sensor
6	0	40	Liquid pipe sensor failure: Circuit E
6	1	41	Toci temperature sensor failure
6	2	42	High Pressure switch open
6	3	43	Low Pressure switch open
6	4	44	System high pressure protection: Overcharged, high condensing temperature or malfunction of fan motor
6	5	45	System low pressure protection: Undercharged, low defrosting temperature, or malfunction of fan motor
0	1	/	Indoor ambient temperature sensor failure
0	2	/	Indoor coil temperature sensor failure
0	4	/	Indoor PCB EEPROM failure
0	7	/	Communication fault between the indoor and outdoor unit
0	8	/	Communication fault between the controller and Indoor unit
0	12	/	Drain system malfunction
0	13	/	Zero cross signal detected wrong
0	14	/	Indoor fan motor malfunction



AM24LP2VHA

Table of Contents

Components **H-2**

 Component Overview H-2

 Indoor Unit Circuit Board H-3

Ductwork/Grilles **H-5**

Testing **H-6**

 Test Condensate Pump and Float Switch H-6

 Testing Communication Circuit H-6

 Testing Temperature Sensors H-7

 Indoor Fan Motor Voltage Check H-7

Wiring Diagram **H-8**

DIP Switch Settings **H-9**

Error Codes **H-10**

Components

The Medium Static Ducted Indoor Unit will act as evaporator coils during cooling mode and condenser coils during heating mode. This unit can operate with a motorized supply air louver or it can have a LIMITED amount of ducting added to the unit's return and supply air duct connection flanges. The return air ducting can be connected to the end of the cabinet or the bottom blank off plate can be removed for bottom return configuration.

DIP Switches on the unit's circuit board configure the fan power to match the ducting configuration.

These units have a built in condensate pump with an associated condensate level switch. The condensate pump is capable of lifting water out of the indoor unit. If high water lift is needed, the water from the cassette pump should be pumped into a field supplied condensate pump with high lift power.

The layout of the system is very straightforward and components are easily accessed should service be required. The blower assembly and room air temperature sensor is accessed at the rear of the evaporator coil, and the piping temperature sensor is located under the top cover. The condensate pump and float switch are accessed under the removable panel next to the electrical control box.

The wired controller can be configured to sense room air temperature. There is no option for use with remote control.

All operating status and information is displayed on the wired controller. The Medium Static Ducted unit does not have a display.

Component Overview



Medium Static Ducted units are controlled by a wired controller only.

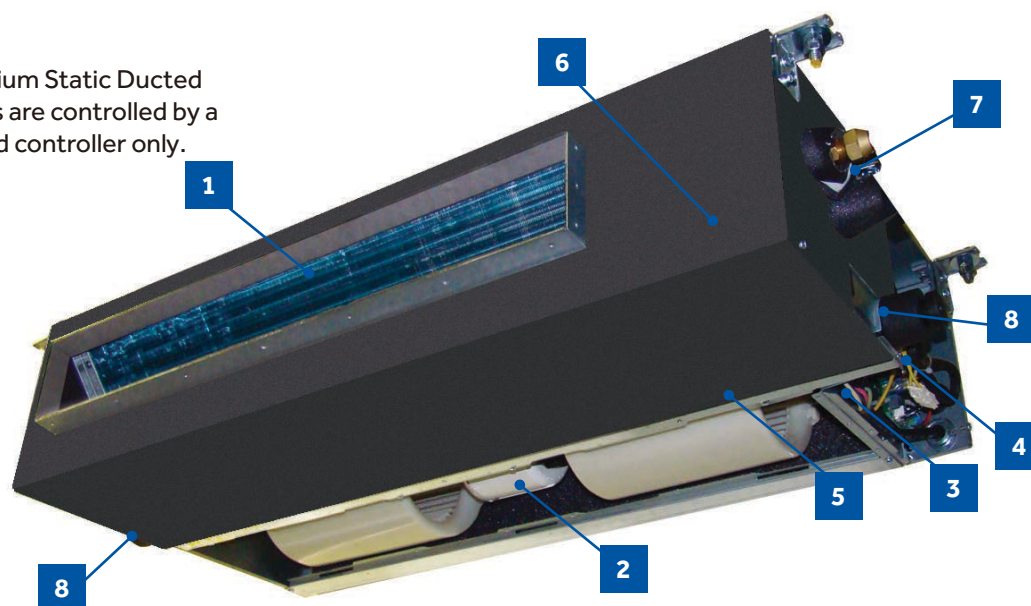

1 Evaporator Coil

2 Blower Assembly

The indoor unit features a DC variable speed dual shaft blower motor that will change speed to match the capacity demand from the outdoor unit. The motor is a dual shaft type that powers two individual blower assemblies.

The blower assembly consists of 2 plastic blowers. A set screw holds each blower wheel to the blower motor.

The indoor blower motor is connected to the indoor unit control board. The wiring from the motor to indoor board consists of 5 wires connected to pins that deliver line voltage, speed, and feedback information.

During normal operation, the indoor control board will energize the indoor blower motor and request proper speed. Fan power should be set using the DIP Switches SW1 settings.

3 Terminal Block

Power to operate the indoor unit comes from the electrical line voltage terminal block at the outdoor unit. The wiring includes 4 wires, 1, 2, 3 and ground. Wires 1 and 3 complete the data path. These wires should always be 14 gauge AWG Stranded type wire. Splices in wires 1 or 3 may cause communication errors.

4 Control Board

Located under the electrical control box cover.

5 Ambient Temperature Sensor

The Ambient Temperature Sensor senses room temperature. This sensor provides room temperature information to the ECU for calculation of inverter capacity and temperature control.

6 Piping Temperature Sensor

The Piping Temperature Sensor senses indoor coil temperature in the cooling mode and in the heating mode. This sensor is used for Anti Freezing and Anti Cold Blow cycles. The sensor also provides critical temperature information to the ECU that may be used in frequency adjustments.

7 Condensate Pump

The Medium Static Ducted unit has a built in condensate pump. The pump is connected to the circuit board. The pump is energized whenever the Float Switch indicates that water needs to be pumped from the cassette. The float switch connects onto the circuit board.

The float switch and pump are located behind the removable insulated cover next to the electrical control box. The pump is hermetically sealed and requires no maintenance. The float switch is a normally closed switch, that opens as water rises. The float switch requires no maintenance.

8 Gravity Drain Ports

The indoor unit has the option for either gravity drain systems or the use of an internal condensate pump with float switch. The pump is capable of minimal lift. If high lift is required, the water from the Medium Static Ducted unit should be pumped to a field supplied condensate pump that is capable of high lift.

Indoor Unit Circuit Board

The indoor unit circuit board controls the switching functions of the indoor unit. All control decisions are made by the outdoor unit ECU. The indoor board has some limited diagnostic capability which will be covered in this manual.

- 1 CN13 Float switch
- 2 CN22 Wired controller
- 3 CN41 Ambient and Coil sensors
- 4 CN4 Condensate pump
- 5 CN6 Blower motor
- 6 Terminal Block

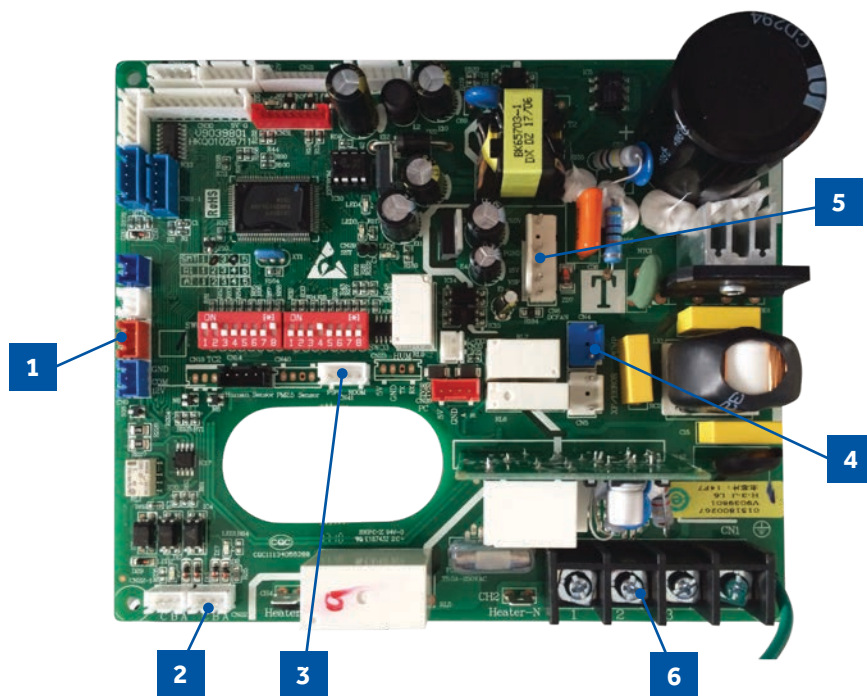

The Indoor Unit Circuit Board communicates with the outdoor unit ECU via a connection at Terminal Block screw 3. The data pulse that sends the communication information can be measured with a voltmeter placed to DCV range. From the ground connection at the Terminal Block to the Number 3 screw connection, the voltage should pulse up and down when data is being transmitted.

Line voltage to power the indoor unit comes in on Terminal Block connections 1 and 2. Power connects from these terminal connections to CH- 1 and CH-2 on the circuit board. If the board does not respond to commands and has no display, check for line voltage at these connections. When power is present at the indoor board, the wired controller will be energized.

The connections on the indoor board are shown here in the schematic drawing.

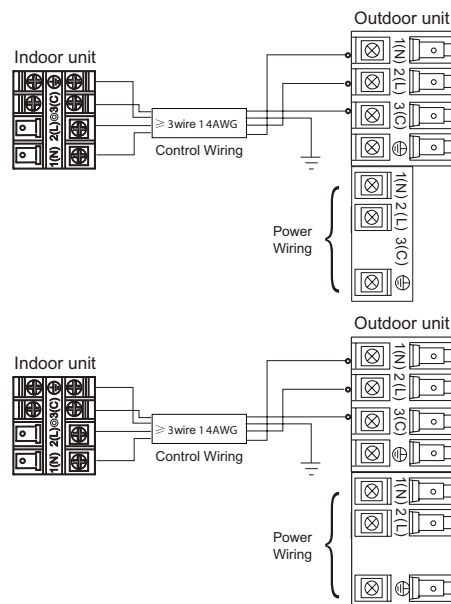

This control board has control over the fan louver movement, manual fan blower control, indoor coil temperature and indoor air temperature sensing functions. All operational decisions are controlled by the OUTDOOR UNIT ECU.

The control board has a replaceable 5A 250V fuse that protects against excessive current. If power is present at the board but the board does not work, check for continuity through the fuse. Replace if the fuse is open.

The indoor unit temperature sensors are connected at Plug CN-13. When testing the calibration of these sensors, the wires can be released from the plug by pressing on the tension tab on the side of the plug.

There 3 motors that control the directional movement of the accessory louver. The motor connects to the circuit board at Plug CN-14, CN-15 and CN-16. The motors are located in the louver assembly.

The blower motor is connected to the circuit board at plug CN-6.

Basic Duct Configurations

Here are the typical duct configurations that can be used with the unit.

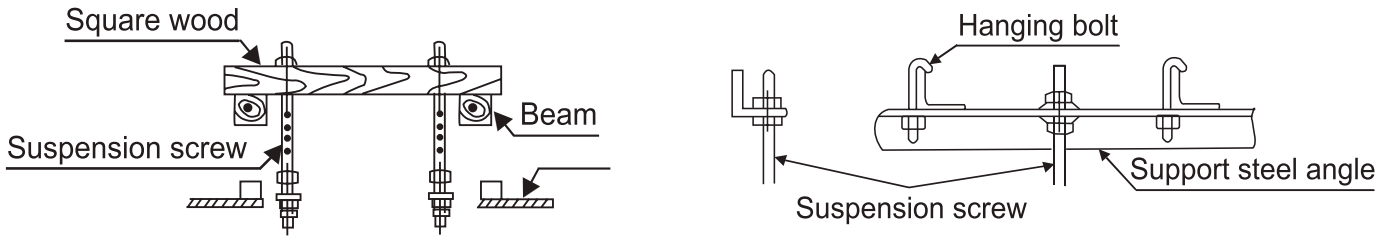

Ductwork Installation

Roof Installation

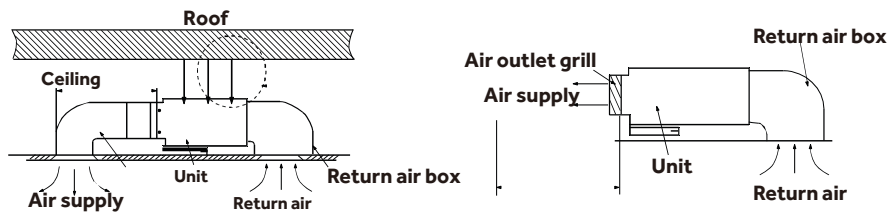

Long Duct

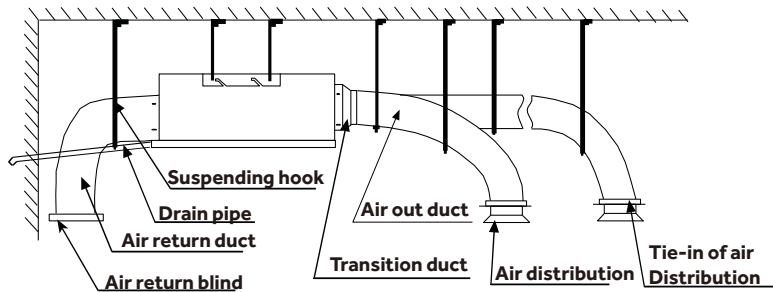

Use rivet to connect the air return duct on the air return inlet of the indoor unit, then connect the other end with the air return

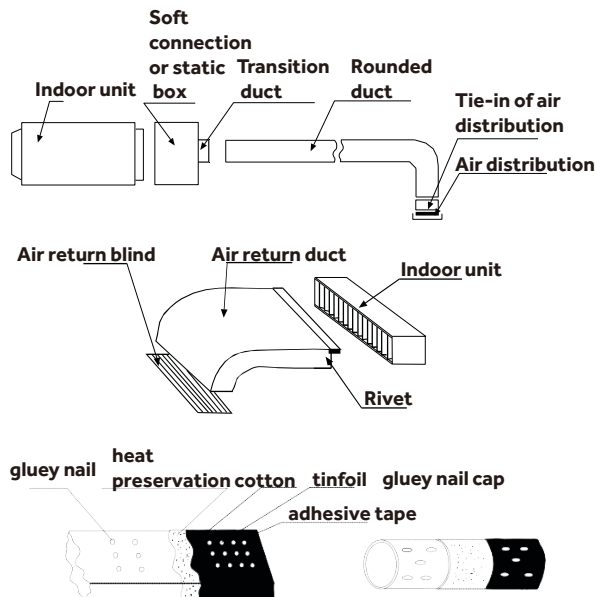

Test Condensate Pump and Float Switch

The unit has a built-in condensate pump and water level safety switch. There are also two optional ports for gravity drainage. The condensate pump is rated to lift water up to 27 9/16" from the point of discharge.

The unit comes with a grey connection hose with clamp. This hose is connected to the High ESP Duct unit condensate discharge hose port. The other end of the hose is sized to accept 3/4 inch PVC piping.

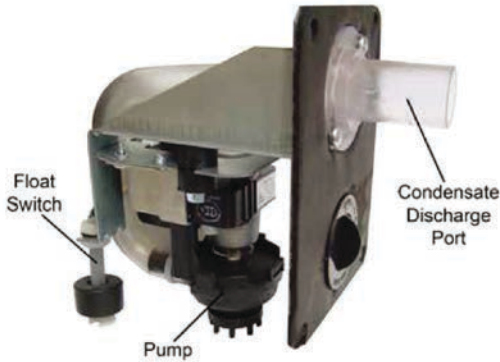

Recommended condensate piping configurations are shown here:

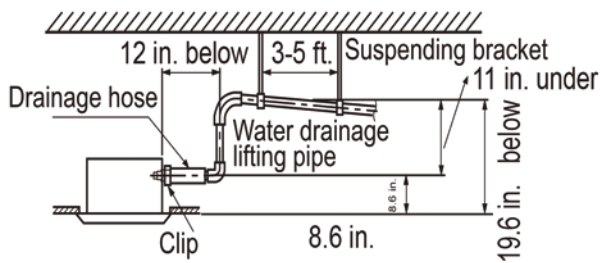

If the internal condensate pump does not operate, the pump may be bad or the float switch may be defective. Perform the following test:

1. Access the electrical control box.
2. Unplug the float switch from the circuit board.

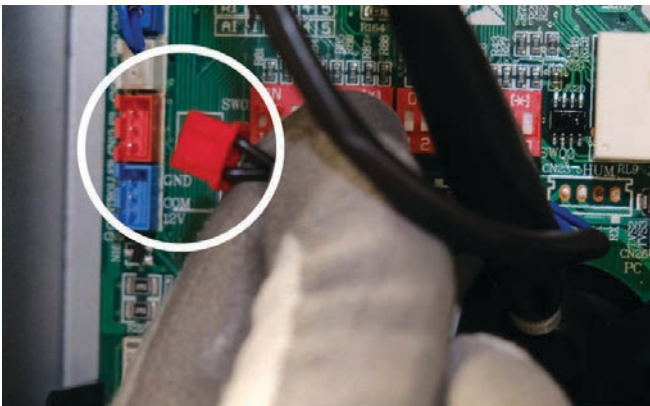

3. The pump should start.
4. If the pump does not start, check for voltage at the pump control board connection. There should be 230 Volts AC to the pump. If there is not, the circuit board is defective. If there is proper voltage to the pump, either the pump or associated pump wiring is defective.

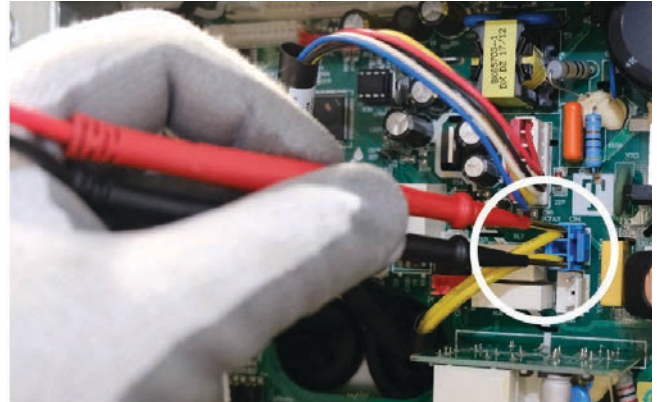

Testing Communication Circuit

If an Error E7 occurs, perform the following test to determine if the indoor control board is functioning properly to send data to the outdoor unit.

Perform this test with the unit powered and all wiring connected between indoor and outdoor unit.

Make sure all wiring between the indoor and outdoor unit are correct. There should no splices between the indoor and outdoor unit wiring connecting terminals 1 or 3. Make sure wiring is correct, before performing this test.

1. Measure the DC voltage between terminals 1 and 3 on the indoor terminal block.

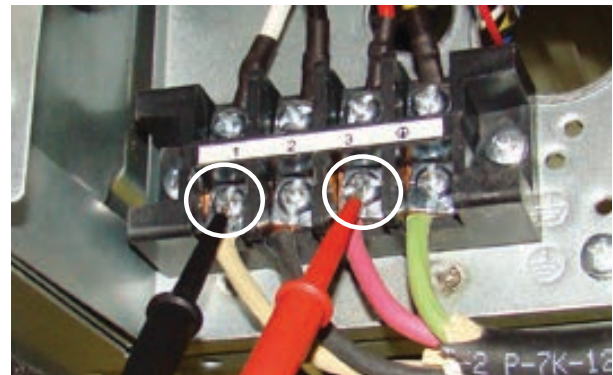

2. The voltage should fluctuate between 8VDC and 23VDC. The fluctuating signal indicates a good communication path.
3. If the voltage does not fluctuate, and the wiring is good, the indoor board is defective.

Testing Temperature Sensors

The easiest problems to solve will involve codes that are related to potential failure of temperature sensors. Common problems may include loose connections, open electrically, and out of calibration. Checking the condition of the sensors requires a temperature probe and an ohmmeter.

The Reference Section of this manual contains temperature resistance tables that can be used to check the calibration of the sensors. The measured resistance must be within the tolerances printed on the top of the tables.

1. Confirm the sensor is firmly attached to the circuit board connection plug.
2. Remove the sensor wires from the connection plug by releasing holding tension on the plugs tension tab.

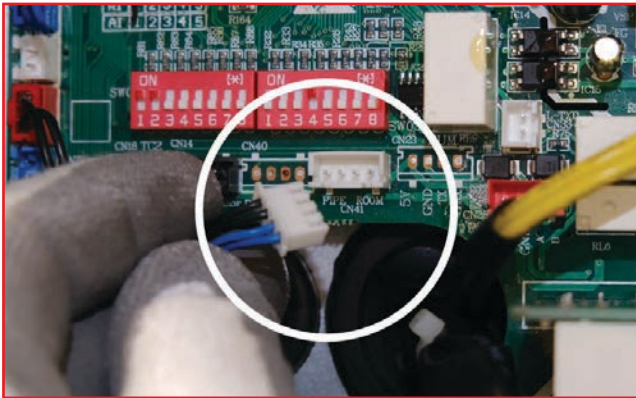

3. Use an ohmmeter to test the electrical resistance of the sensor.

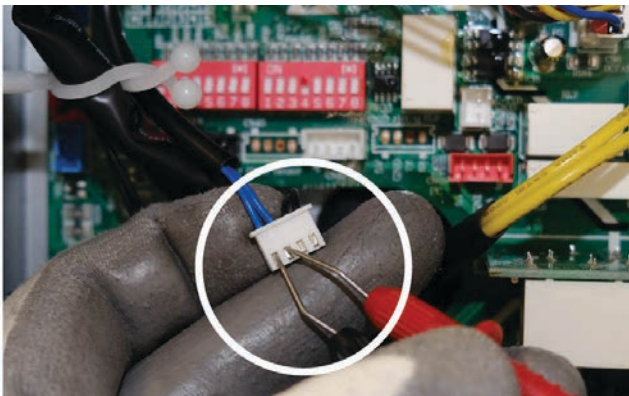

4. Measure the air temperature near the sensor and compare the required resistance against measured resistance. (refer to charts in reference section) If the sensor is within calibration, the sensor is good. If the sensor is out of calibration, replace the sensor. (Tube Sensors should be removed from socket and exposed to air temperature during test.)

Indoor Fan Motor Voltage Check

If The Indoor Fan Motor Does Not Run:

1. Remove the front cover and access the fan motor circuit board connection.
2. Reset power and turn the remote control fan command to Fan On mode.

Motor Test:

1. If the motor doesn't run, check for 310VDC between Pins 1 and 3. If it is not present, the indoor board is bad. If voltage is present, continue on.
2. Check the voltage between Pins 3 and 4. The voltage should be +15VDC. If it is not present, the board is bad. If voltage is present, continue on.
3. Check for voltage between Pins 3 and 6. If no DC voltage is present, the board is bad. If voltage is present, change the motor.

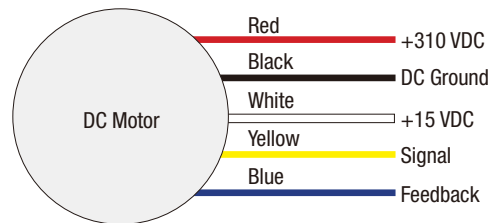
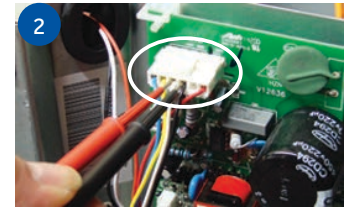

Wiring Diagram

0150523302

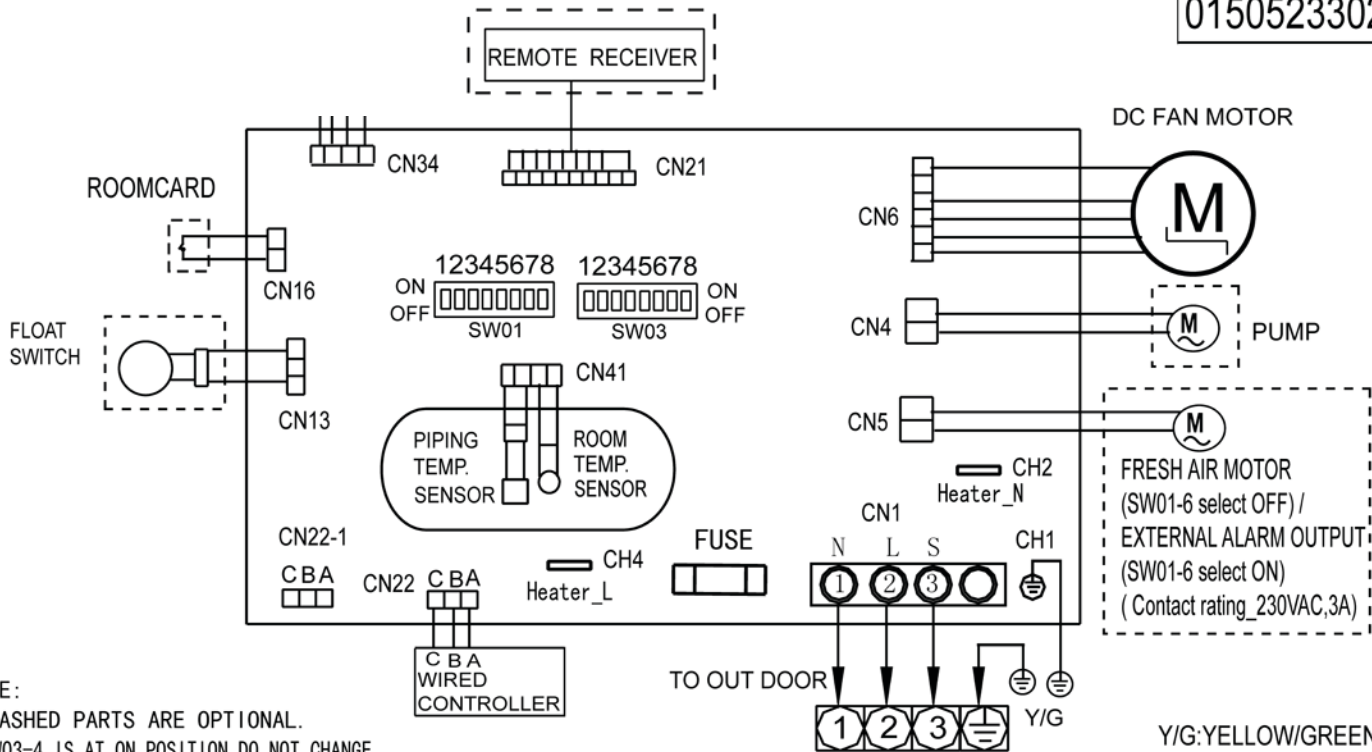

- NOTE:**
1. DASHED PARTS ARE OPTIONAL.
 2. SW03-4 IS AT ON POSITION, DO NOT CHANGE THE SETTINGS OF SWITCHES WITHOUT GUIDANCE.
 3. WHEN ONE WIRED CONTROLLER CONTROL MULTIPLE INDOOR UNIT, IT CAN CONNECT ANOTHER INDOOR UNIT BY CN22 OR CN22-1. WHEN TWO WIRED CONTROLLERS CONTROL ONE INDOOR UNIT, THE WIRED CONTROLLER NEED CONNECT WITH CN22 AND CN22-1.
 4. SW03-5→SW03-08 IS USED FOR ADDRESS SETTING ON THE SITUATION OF ONE WIRED CONTROLLER CONTROL MORE THAN ONE INDOOR UNIT.
 5. REFER TO SERVICE MANUL TO GET MUCH MORE DETAILS ABOUT THE STATIC PRESSURE LEVEL SELECTION.

SW03-1	SW03-2	SW03-3	SW03-4	SW03-5	SW03-6	SW03-7	SW03-8	FOR ALL DUCTED MODEL
OFF	OFF	OFF	ON	OFF	OFF	OFF	OFF	
SW01-1	SW01-2	SW01-3	SW01-4	SW01-5	SW01-6	SW01-7	SW01-8	MODEL
ON	ON	OFF	OFF	OFF	OFF	OFF	OFF	AD71S2SM1FA
ON	ON	OFF	OFF	OFF	OFF	OFF	OFF	AM24LP2VHA
ON	ON	OFF	OFF	OFF	OFF	OFF	ON	ADH071M3ERG
OFF	ON	OFF	OFF	OFF	OFF	OFF	ON	AD50S2SM1FA

ENGLISH

DIP Switch Settings

Description	SW1-1	SW1-2	SW1-3	SW1-4	SW1-5	SW1-6	SW1-7	SW1-8
AM24LP2VHA	ON	ON	OFF	---	---	---	---	---
Room card invalid(default)	---	---	---	OFF	---	---	---	---
Room card valid	---	---	---	ON	---	---	---	---
Cool and heat(default)	---	---	---	---	OFF	---	---	---
Cool only	---	---	---	---	ON	---	---	---
External alarm output(default)	---	---	---	---	---	OFF	---	---
Fresh air	---	---	---	---	---	ON	---	---
Without filter clean remind (default)	---	---	---	---	---	---	OFF	---
With filter clean remind	---	---	---	---	---	---	ON	---
ESP DUCT (USA)	---	---	---	---	---	---	OFF	0
EU. & Australia	---	---	---	---	---	---	---	ON

Wired Controller Communication Address

Indoor unit Address (Indoor unit address for one wired controller control more than one unit)	SW3-5	SW3-6	SW3-7	SW3-8
0 (master)	OFF	OFF	OFF	OFF
1 (slave)	OFF	OFF	OFF	ON
2 (slave)	OFF	OFF	ON	OFF
3 (slave)	OFF	OFF	ON	ON
4 (slave)	OFF	ON	OFF	OFF
5 (slave)	OFF	ON	OFF	ON
6 (slave)	OFF	ON	ON	OFF
7 (slave)	OFF	ON	ON	ON
8 (slave)	ON	OFF	OFF	OFF
9 (slave)	ON	OFF	OFF	ON
10 (slave)	ON	OFF	ON	OFF
11 (slave)	ON	OFF	ON	ON
12 (slave)	ON	ON	OFF	OFF
13 (slave)	ON	ON	OFF	ON
14 (slave)	ON	ON	ON	OFF
15 (slave)	ON	ON	ON	ON

Error Codes

The error codes that are displayed on the indoor units may vary from the outdoor unit codes. The information communicated by the error code will be the SAME for both indoor and outdoor units even though the numbers may differ.

Indoor LED4	Indoor LED3	Outdoor LED	Diagnosis
2	1	1	Outdoor EEPROM failure
2	2	2	IPM overcurrent or short circuit
2	3	/	Compressor over current during deceleration
2	4	4	Communication failure between the IPM and outdoor PCB
2	5	5	Module operated overload (compressor overload protection)
2	6	6	Module low or high voltage
2	7	/	Compressor current sampling circuit fault
2	8	8	Overheat protection for discharge temperature
2	9	9	Malfunction of the DC fan motor
3	0	10	Malfunction of defrost temperature sensor
3	1	11	Suction temperature sensor failure
3	2	12	Ambient temperature sensor failure
3	3	13	Discharge temperature sensor failure
3	4	/	PFC circuit loop voltage
3	5	15	Communication failure between the indoor & outdoor unit
3	6	16	Lack of refrigerant or discharging
3	7	17	4-way valve switching failure
3	8	18	Loss of synchronism detection
3	9	/	Low DC or AC voltage
4	0	20	Indoor thermal overload
4	1	21	Indoor coil frosted
4	2	/	PFC circuit loop overcurrent
4	3	23	Module thermal overload
4	4	24	Compressor start failure, over-current
4	5	25	Phase current protection (IPM)
4	6	26	MCU reset
4	7	27	Module current detect circuit malfunction
4	8	28	Liquid pipe sensor failure: Circuit A
4	9	29	Liquid pipe sensor failure: Circuit B
5	0	30	Liquid pipe sensor failure: Circuit C
5	1	31	Liquid pipe sensor failure: Circuit D
5	2	32	Gas pipe sensor failure: Circuit A
5	3	33	Gas pipe sensor failure: Circuit B
5	4	34	Gas pipe sensor failure: Circuit C
5	5	35	Gas pipe sensor failure: Circuit D
5	6	36	Gas pipe sensor failure: Circuit E
5	7	/	Compressor overcurrent detected by IPM
5	8	38	Malfunction of module temperature sensor momentary power failure detection
5	9	39	Malfunction of condensing temperature sensor
6	0	40	Liquid pipe sensor failure: Circuit E
6	1	41	Toci temperature sensor failure
6	2	42	High Pressure switch open
6	3	43	Low Pressure switch open
6	4	44	System high pressure protection: Overcharged, high condensing temperature or malfunction of fan motor
6	5	45	System low pressure protection: Undercharged, low defrosting temperature, or malfunction of fan motor
0	1	/	Indoor ambient temperature sensor failure
0	2	/	Indoor coil temperature sensor failure
0	4	/	Indoor PCB EEPROM failure
0	7	/	Communication fault between the indoor and outdoor unit
0	8	/	Communication fault between the controller and Indoor unit
0	17	/	DC voltage of the fan motor driver too high or too low
0	18	/	Fan motor driver over 95°F (35°C)
0	19	/	Indoor fan motor out of step
0	12	/	Drain system malfunction
0	13	/	Zero cross signal detected wrong
0	14	/	Indoor fan motor malfunction
0	15	/	Indoor fan motor overcurrent



USYF09UCDWA
 USYF12UCDWA
 USYF18UCDWA

Table of Contents

Components.....I-2

 Component Overview.....I-2

 Indoor Circuit Board.....I-3

Testing.....I-4

 Removing the Filter Cover & Filter.....I-4

 Front Cover Removal.....I-4

 Control Box Removal.....I-4

 Board Replacement.....I-4

 Upper Louver Removal.....I-5

 Lower Damper Assembly Removal.....I-5

 Replace Fan Motor.....I-5

 Indoor Fan Motor Test Procedure.....I-6

 Testing Temperature Sensors.....I-7

 Testing Louver Motors.....I-7

 Testing Communication Circuit.....I-8

 Replacing WiFi Module.....I-8

Wiring Diagram/DIP Switch Settings.....I-9

Error Codes.....I-10

Components

The indoor console unit functions as an evaporator coil during cooling mode, and as a condensing coil during heat mode. Condensate is collected by a drain pan below the coil and condensate is drained directly to the outdoor or to a secondary condensate pump via the provided condensate drain line

Console units may be operated with either a wired remote control or the wireless remote control provided with the unit.

Component Overview

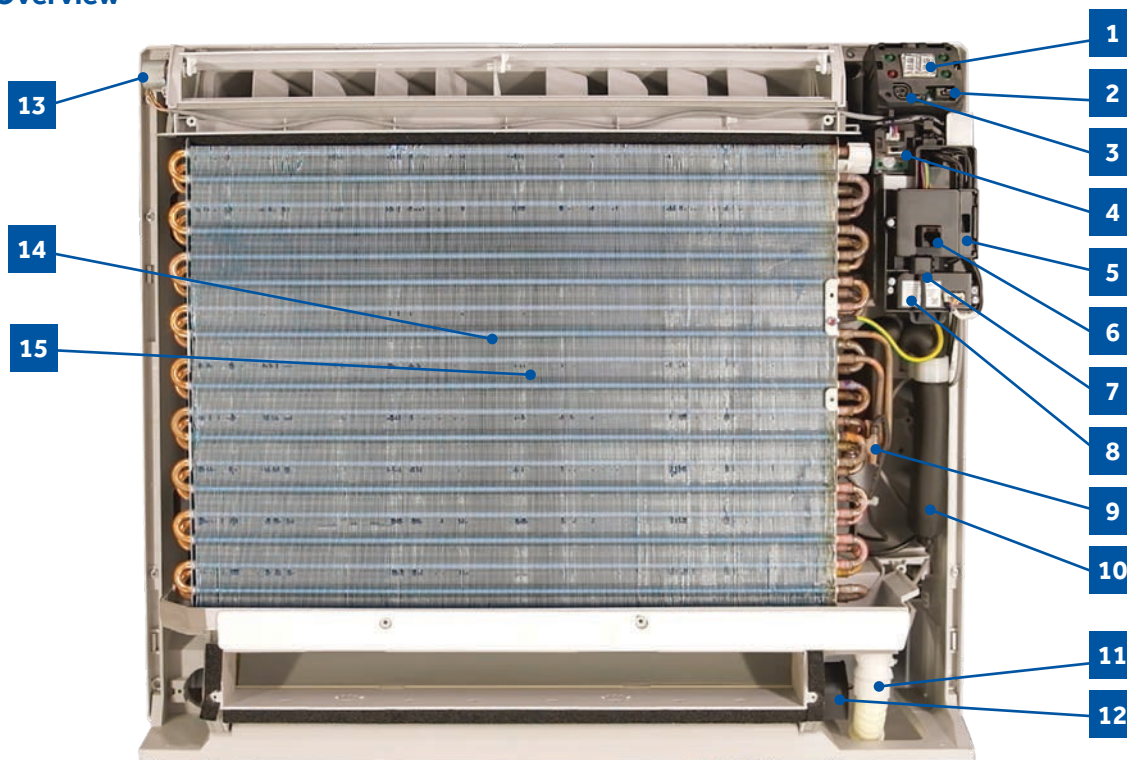

1 Display

The indoor unit display communicates system mode, but does not display temperatures or diagnostic codes. This information is indicated on the wired or wireless control.

When servicing a diagnostic error always refer to the outdoor unit code.

2 IR Receiver

3 Power Switch

4 Lower Damper Control

5 Control Board Box

6 Diagnostic Port

7 Ambient Sensor

The Ambient Temperature Sensor senses room temperature. This sensor provides room temperature information to the ECU for calculation of inverter capacity and temperature control.

8 WiFi Module

9 Coil Sensor

The Coil Temperature Sensor senses indoor coil temperature in the cooling mode and in the heating mode. This sensor is used for Anti Freezing and Anti Cold Blow cycles. The sensor also provides critical temperature information to the ECU that may be used in frequency adjustments.

10 Flare Connections

11 Condensate Drain

12 Lower Damper Motor

13 Upper Louver Motor

The louver motor is a stepper type motor that moves the louver left/right. The motor is controlled by a pulsed voltage that cannot be measured. If the louver does not move when it should, check for a bind in the louvers.

14 Blower Fan (behind coil)

15 Blower Motor (behind coil)

The indoor unit features a multi-speed blower motor that will change speed to match the capacity demand from the outdoor unit. The blower motor is controlled by both the remote control and by commands from the outdoor unit ECU

Indoor Circuit Board

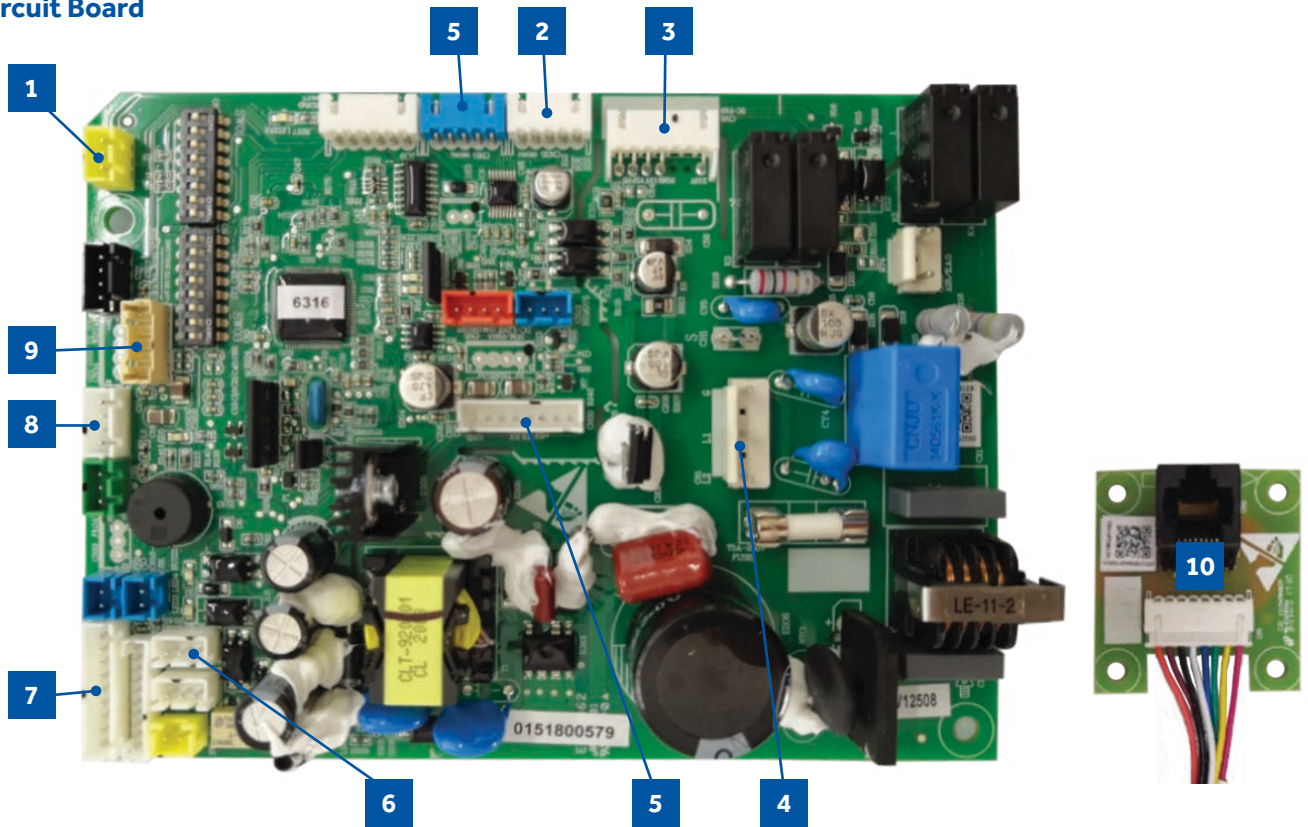

- | | |
|--|---|
| <ul style="list-style-type: none"> 1 SW2-Damper switch 2 CN35- Lower damper motor 3 CN6-DC fan motor 4 Power supply 5 CN20-Diagnostic port 6 CN22- Optional wired controller | <ul style="list-style-type: none"> 7 CN31- Display 8 CN3-Temperature sensor socket (Tr: ROOM SENSOR, Tp:PIPE SENSOR) 9 CN17-WiFi module 10 RJ45 adapter board |
|--|---|

The indoor unit circuit board controls the switching functions of the indoor unit. All control decisions are made by the outdoor unit ECU. The indoor board has some limited diagnostic capability which will be covered in this manual.

The indoor unit Circuit Board communicates with the outdoor unit ECU via a connection at terminal block screw 3. The data pulse that sends the communication information can be measured with a voltmeter set to DC voltage range. From the ground connection at the terminal block to the number 3 screw, voltage should pulse up and down when data is transmitted.

Line voltage to power the indoor unit is made on terminal block connections 1 and 2. Power connects from these terminal connections to CH-3 and CH-4 on the circuit board. If the board does not respond to command and has no display, check for line voltage at these connections. When power is present at the indoor board, the Display Power Indicator will be lit. The control board has a replaceable 3.15A 250V fuse that protects against excessive current. If power is present at the board but the board does not work, check for continuity through the fuse. Replace if the fuse is open.

The indoor unit sensors are connected at plug CN-13. When testing the calibration of these sensors the wires can be released from the plug by pressing the tension tab on the side of the plug.

The receiver/display unit, mounted on the front cover of the indoor unit plugs connects to the circuit board at location CN-29.

The blower/fan motor connection is located at plug CN-11.

Removing the Filter Cover & Filter

1. Slide the side latches up to unlock the cover and pull forward about an inch then lift up.



2. The filter is very flexible and can be grabbed at any location and removed.

Front Cover Removal

1. Remove the 4 screws that are at the corners of the air intake opening. Gently open the horizontal louver. Lift up the top edge of the front cover and then pull forward.

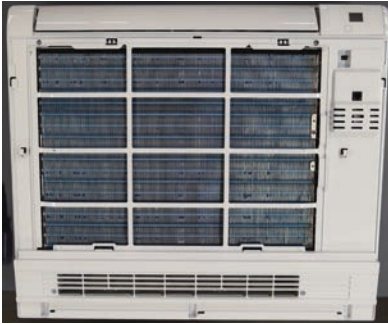

Control Box Removal

1. Remove the screw from the right side of the box cover.



2. Lift up the panel that contains the diagnostic port, wifi module and ambient sensor. And remove the box cover.

3. Unplug the three connectors for the fan motor, upper louver and bottom damper.

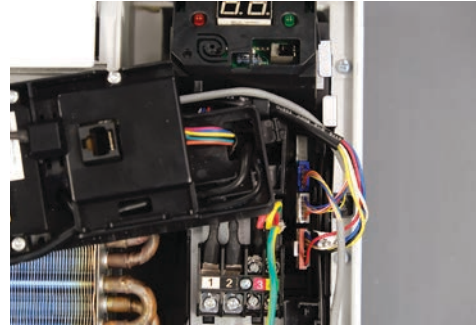

4. Remove the ground screw.



5. Remove the mounting screw for the box.



6. The box can now be removed.

Board Replacement

1. Follow the instructions for removing the control box.
2. Remove the cover screw from the bottom of the box, then remove cover.

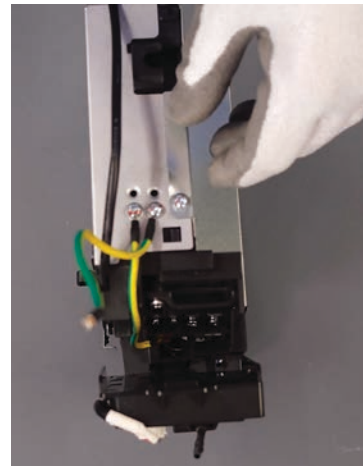

3. Take note of connection location and carefully remove each connector.
4. Remove the 2 screws mounting the board in the box. They in diagonal corners from each other.

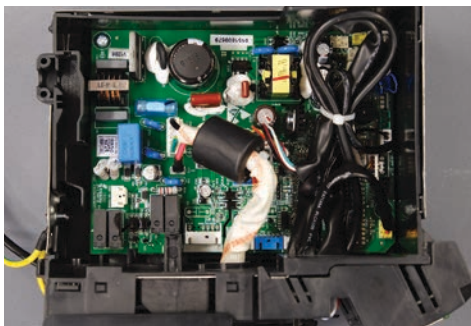

Upper Louver Removal

1. Remove the filter cover and front cover.
2. Locate and remove the two screws mounting the upper louver assembly to the case. They are on either end of the assembly.

Lower Damper Assembly Removal

1. Remove the filter cover and front cover.
2. Disconnect the condensate drain.
3. Locate and remove the two screws mounting the damper assembly to the case.
4. Pull on the right end of the assembly and rotate the bottom of the assembly outward.

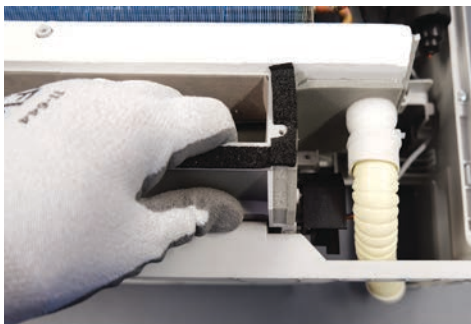

Note: When re-installing the damper assembly, first place the front edge of the condensate drain pan into place then rotate the bottom of the assembly into position.

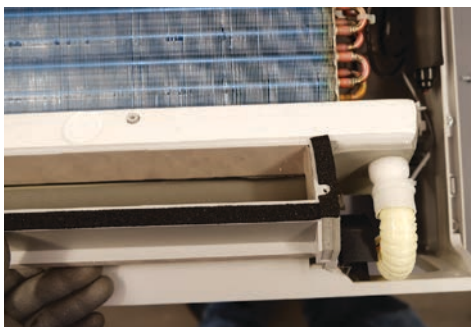

Replace Fan Motor

1. Remove filter cover, front panel, control box, upper louver and bottom damper.
2. Remove the white plastic strap that hold the line set in place on the right side of the unit.

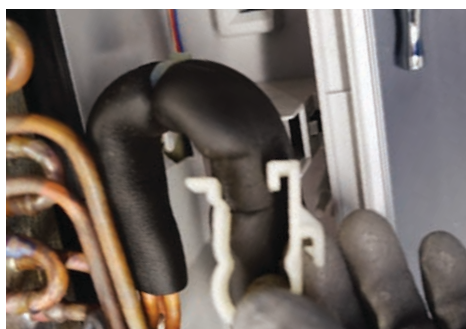

3. Locate the locking tabs on the left side of the evaporator and press them inward and pull the coil forward to remove.



IMPORTANT: Great care should be taken to when performing this step. Excessively moving the lineset that connects to the flare can cause a refrigerant leak.

4. Slide the coil to the right to. The coil can now be gently pulled away from the case. Only move the coil far enough to access the four screws holding on the fan inlet faring.

5. Remove the four screws holding on the fan inlet faring.

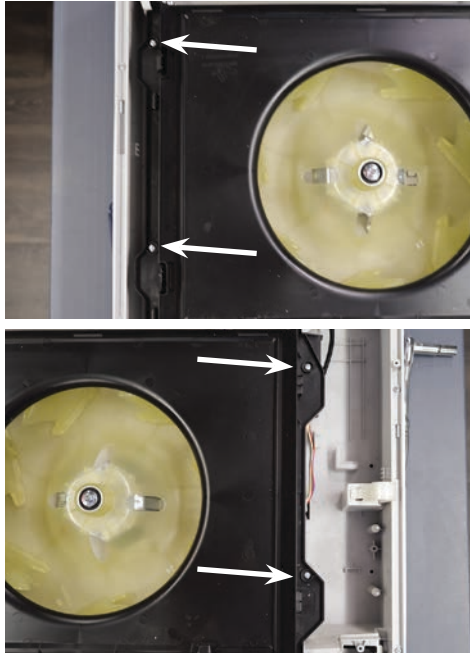

6. Remove the wire cover from the back of the case.



7. Remove the motor bracket.

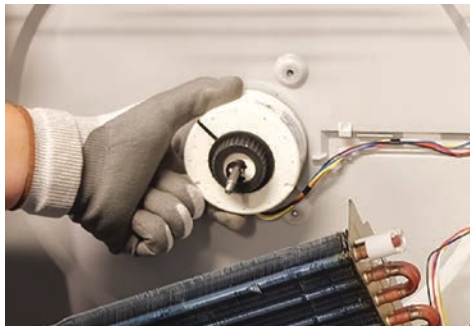

NOTE: when replacing the motor, the wires must exit from the bottom of the motor to prevent water from entering the motor.

Indoor Fan Motor Test Procedure

If the indoor fan motor does not run:

1. Disconnect power to the system.
2. Remove the return air cover and access the fan motor circuit board connection.
3. Reset power and turn the remote control fan command to Fan On mode.

Motor Test:

1. If the motor doesn't run, check for 310VDC between Pins 1 and 3. If it is not present, the indoor board is bad. If voltage is present, continue on.
2. Check the voltage between Pins 3 and 4. The voltage should be +15VDC. If it is not present, the board is bad. If voltage is present, continue on.
3. Check for voltage between Pins 3 and 6. If no DC voltage is present, the board is bad. If voltage is present, change the motor.

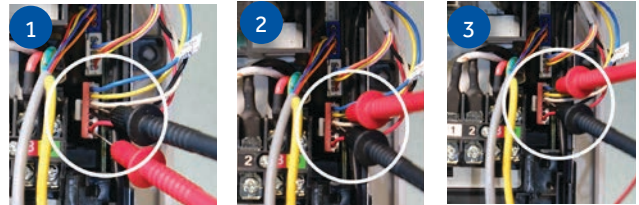
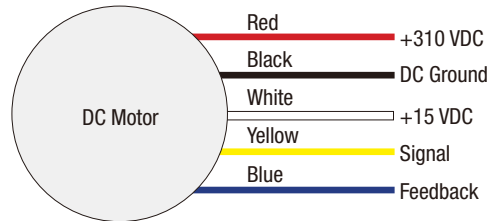

Testing Temperature Sensors

The easiest problems to solve will involve codes that are related to potential failure of temperature sensors. Common problems may include loose connections, open electrically, and out of calibration. Checking the condition of the sensors requires a temperature probe and an ohmmeter.

The Reference Section of this manual contains temperature resistance tables that can be used to check the calibration of the sensors. The measured resistance must be within the tolerances printed on the top of the tables.

To test the electrical condition of a temperature sensor perform the following:

1. Confirm the sensor is firmly attached to the circuit board connection plug.
2. Remove the sensor wires from the connection plug by releasing holding tension on the plug's tension tab.
3. Use an ohmmeter to test the electrical resistance of the sensor.
4. Measure the air temperature near the sensor and compare the required resistance against measured resistance. (See chart in reference section) If the sensor is within calibration, the sensor is good. If the sensor is out of calibration, replace the sensor. (Tube Sensors should be removed from socket and exposed to air temperature during test.)

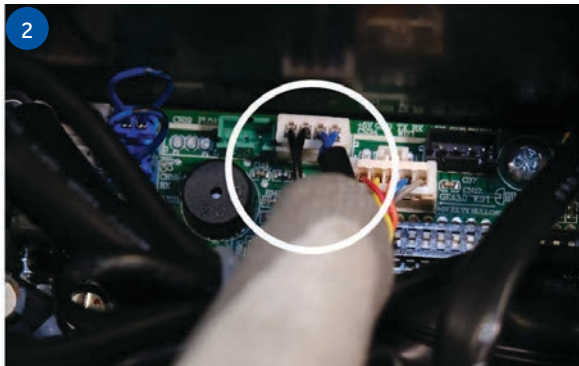

Testing Louver Motors

If the louver does not operate with command from the remote control, either the indoor board is bad, or the louver motor is defective. It is more likely the motor is defective than the board. (Make sure the louver assembly is not binding and keeping the vanes from moving.)

1. Remove power from the unit and remove the indoor unit cover.
2. Access the circuit board.
3. Identify the inoperable louver motor on the schematic drawing below and disconnect the plug from the circuit board.

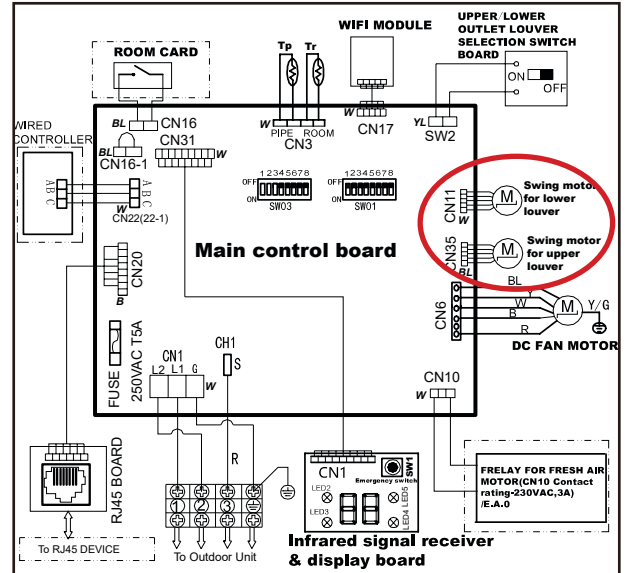

4. Use an Ohmmeter to test the electrical continuity of the louver motor windings. The proper resistance for each winding should be 292Ω from red wire (common) to any other wire.. If the motor winding resistance is erratic or shows open, the motor is defective. Replace the motor.

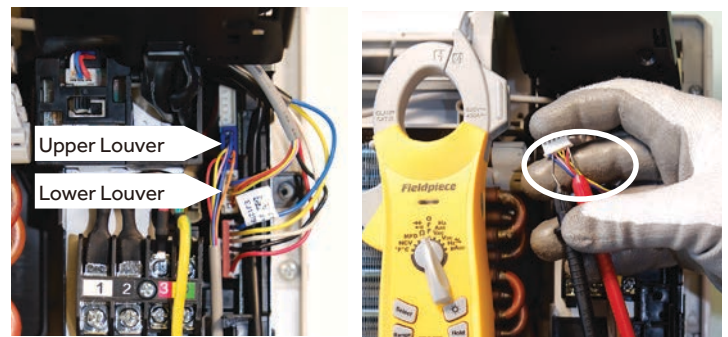

5. If the motor checks out good, replace the indoor control board.

Testing Communication Circuit

If an Error E7 occurs, perform the following test to determine if the indoor control board is functioning properly to send data to the outdoor unit.

Perform this test with the unit powered and all wiring connected between indoor and outdoor unit.

Make sure all wiring between the indoor and outdoor unit are correct. There should no splices between the indoor and outdoor unit wiring connecting terminals 1 or 3. Make sure wiring is correct, before performing this test.

1. Measure the DC voltage between terminals 1 and 3 on the indoor terminal block.

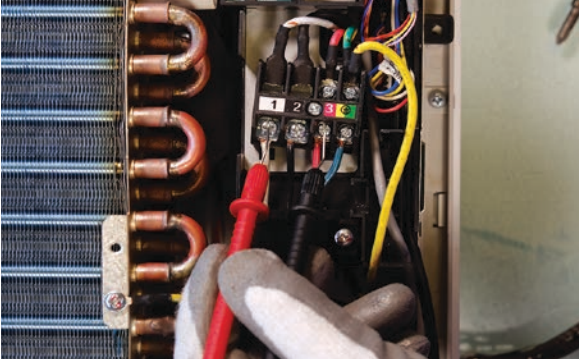

2. The voltage should fluctuate between 8VDC and 23VDC. The fluctuating signal indicates a good communication path.
3. If the voltage does not fluctuate, and the wiring is good, the indoor board is defective.

Replacing WiFi Module

1. Unplug existing WiFi module.
2. Insert new WiFi module.
3. Replace the wifi passcode sticker.
4. Pair the unit to account.

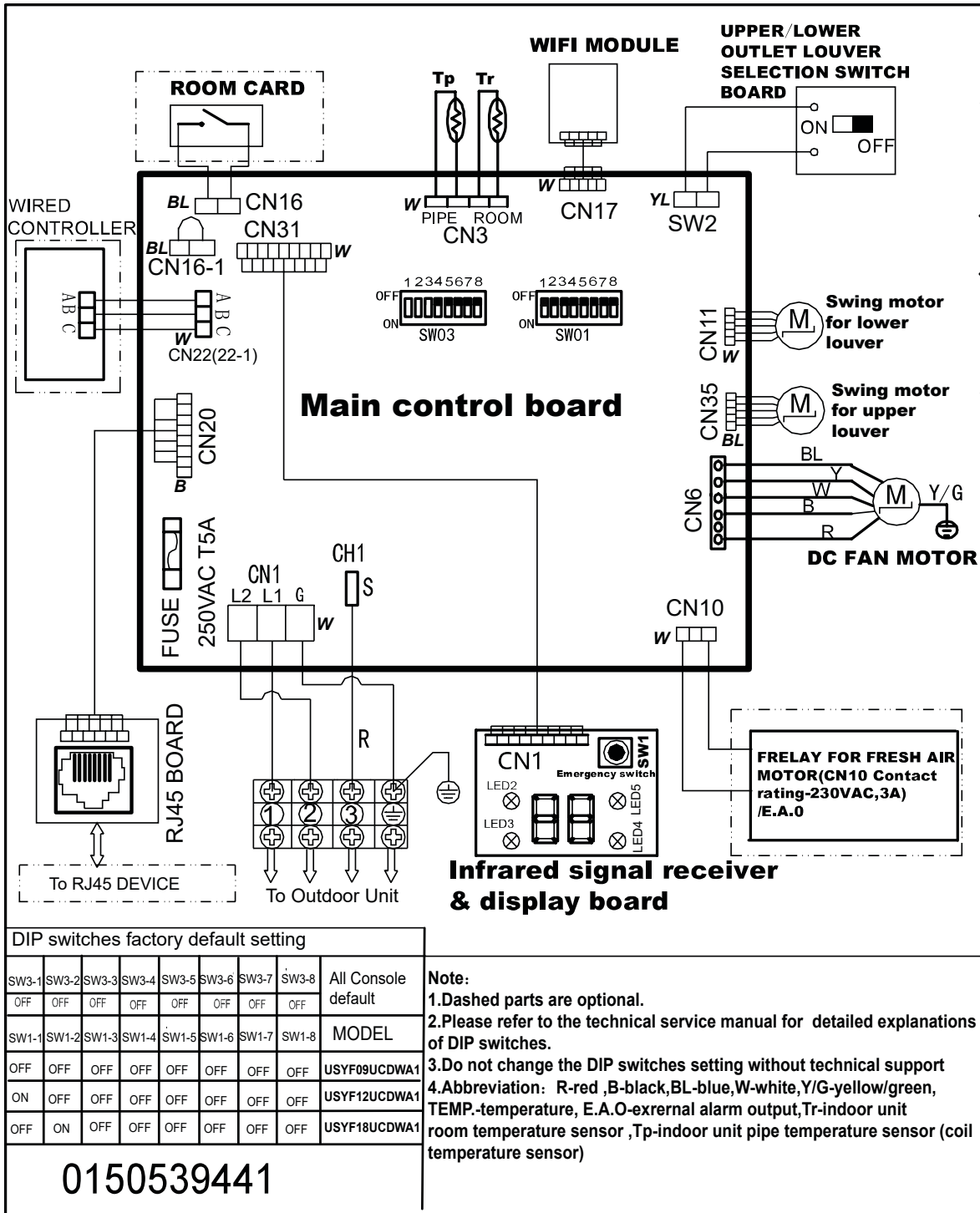

Error Codes

The error codes that are displayed on the indoor units may vary from the outdoor unit codes. The information communicated by the error code will be the SAME for both indoor and outdoor units even though the numbers may differ.

Indoor Display	Outdoor LED	Diagnosis
F12	1	Outdoor EEPROM failure
F1	2	IPM overcurrent or short circuit
F22	/	Outdoor alternating current, over current protection
F3	4	Communication failure between the IPM and outdoor PCB
F20*	5	Module operated overload (compressor overload protection)
F19*	6	Module low or high voltage
F27	/	Compressor current sampling circuit fault
F4	8	Overheat protection for discharge temperature
F8*	9	Malfunction of the DC fan motor
F21	10	Malfunction of defrost temperature sensor
F7	11	Suction temperature sensor failure
F6	12	Ambient temperature sensor failure
F25	13	Discharge temperature sensor failure
F30*	/	High outdoor suction temperature
E7	15	Communication failure between the indoor & outdoor unit
F13*	16	Lack of refrigerant or discharging
F14*	17	4-way valve switching failure
F11	18	Loss of synchronism detection
F28	/	Position detection circuit fault of compressor
F15*	/	Terminal block temp too high
F5*	23	Module thermal overload
F2*	24	Compressor start failure, over-current
F23	25	Phase current protection (IPM)
F9	26	MCU reset
F24	27	Module current detect circuit malfunction
F10	28	Liquid pipe sensor failure: Circuit A
F16	29	Liquid pipe sensor failure: Circuit B
F17	30	Liquid pipe sensor failure: Circuit C
F18	31	Liquid pipe sensor failure: Circuit D
F29	32	Gas pipe sensor failure: Circuit A
F30	33	Gas pipe sensor failure: Circuit B
F31	34	Gas pipe sensor failure: Circuit C
F32	35	Gas pipe sensor failure: Circuit D
F26	36	Gas pipe sensor failure: Circuit E
F34	/	Outdoor pipe temperature protection in cooling mode
F35	38	Malfunction of module temperature sensor momentary power failure detection
F36	39	Malfunction of condensing temperature sensor
F33	40	Liquid pipe sensor failure: Circuit E
F38	41	Toci temperature sensor failure
F39	42	High Pressure switch open
F40	43	Low Pressure switch open
F41	44	System high pressure protection: Overcharged, high condensing temperature or malfunction of fan motor
F42	45	System low pressure protection: Undercharged, low defrosting temperature, or malfunction of fan motor
F43	/	Incorrect match between indoor & outdoor
E1	/	Indoor ambient temperature sensor failure
E2	/	Indoor coil temperature sensor failure
E4	/	Indoor PCB EEPROM failure
E8	/	Communication fault between the controller and Indoor unit
E12	/	Drain system malfunction
E13 / C1	/	Zero cross signal detected wrong
E14	/	Indoor fan motor malfunction

* Hidden indoor error code. LED1 will flash outdoors, but no error will appear on indoor unit display. To view error code on indoor display, press and hold the Emergency button for 15 seconds.

Table of Contents

Special Functions	J-3
Auto Restart.....	J-3
Forced Defrost.....	J-3
Indoor Temperature Display (Highwall Only).....	J-3
Enhanced Defrost.....	J-3
Temperature Compensation.....	J-4
Matching Tables	J-6
Resistance Chart / Sensor Definitions	J-7
Resistance Values	J-8
Louver Motors.....	J-8
EEV.....	J-8
Component Ratings	J-9
4-Way Valve.....	J-9
Basepan Heater.....	J-9
Fan Motors.....	J-9
Refrigeration Diagrams	J-10
Master Error Code Chart	J-12
Outdoor Unit Error Codes	J-16
Temperature Sensor Error Codes.....	J-16
Pressure-Related Error Codes.....	J-17
Communication Error Code.....	J-17
Error Codes Caused by Abnormal Refrigerant Circuit Conditions.....	J-18
Outdoor Error Code Related to Indoor Unit.....	J-18
Error Code Related to the PCB.....	J-18
Error Codes Related to the IPM.....	J-18
Error Codes Related to Compressor, Outdoor Fan & 4-Way Valve.....	J-19
Flow Charts	J-20
[1] Outdoor EEPROM Malfunction.....	J-20
[2] Outdoor IPM over current or short circuit.....	J-20
[4] Communication abnormal between PCB and IPM.....	J-21
[6] DC voltage or AC voltage high.....	J-21
[8] Discharge temperature too high protection.....	J-22
[9] DC fan motor fault.....	J-22
[10] Outdoor defrosting temp. sensor Te abnormal.....	J-23
[11] Suction temp.sensor Ts abnormal.....	J-23
[12] Outdoor ambient temp. sensor Ta abnormal.....	J-23
[13] Discharging temp. sensor Td abnormal.....	J-23
[15] Communication abnormal between indoor unit and outdoor unit.....	J-23
[16] Lack of refrigerant or discharging pipe blocked.....	J-24
[17] 4-way valve reversing failure.....	J-24
[18] Compressor motor desynchronizing.....	J-25
[24] Compressor startup failure.....	J-25
[25] Input overcurrent of the drive module.....	J-25
[42] Open high pressure switch.....	J-26
[43] Open low pressure switch.....	J-26
[44] High pressure detected in system.....	J-27
[45] Low pressure detected in system.....	J-27

Auto Restart

When this is enabled, the following functions will automatically resumes after a power loss:

- ON/OFF State, Mode of Operation, Fan Speed, Temperature Setpoint, Louver Swing settings.
- If there was a timer set or the system was in Sleep mode, they will be canceled upon restart.

Wired Controller:

- Auto Restart is Enabled by Default

Wireless Controller:

- Enable: Press the Sleep button 10 times within 5 seconds. You will hear 4 beeps as confirmation.
- Disable: Press the Sleep button 10 times within 5 seconds. You will hear 2 beeps as confirmation.

Forced Defrost

This will force the unit to run a Defrost Cycle.

Wireless Controller:

- Set the unit to HEAT, 30°C and High fan speed. Press the Sleep button 6 times within 5 seconds.
- You will hear 3 beeps as a confirmation.

Indoor Temperature Display (Highwall Only)

This function will allow you to set the display to show either the Ambient temperature or the setpoint:

- Press the Light button 10 times within 5 seconds.

Enhanced Defrost

Enable Enhanced Defrost via YR-HG Controller:

1. Set to HEAT mode
2. Set to 30C/86F
3. Set High fan speed
4. Press "Temperature +" button 10 times within 5 seconds
5. Unit will beep 7 times to confirm

Disable Enhance Defrost:

- 6. Repeat steps 1-5. Unit will beep 5 times to confirm

Temperature Compensation

This function allows you the capability to adjust the temperature compensation offset of any indoor unit. The adjusted value is programmed into the EEPROM.

Series	IDU	IDU PCB part number		Controls Needed			Guide Reference
		Haier	GEA	Controller	IR Receiver	Wired Controller	
3X3 Cassette	AL24LP2VHA	0151800208	WJ26X23559	YR-HBS01	\	Unplug	Chart 1
3X3 Cassette	AL36LP2VHA	0151800208	WJ26X23559	YR-HBS01	\	Unplug	Chart 1
3X3 Cassette	AL48LP2VHA	0151800208	WJ26X23559	YR-HBS01	\	Unplug	Chart 1
2X2 Cassette	AB09SC2VH*	0151800208A	WJ26X23785	YR-HBS01	\	Unplug	Chart 3
2X2 Cassette	AB12SC2VH*	0151800208A	WJ26X23785	YR-HBS01	\	Unplug	Chart 3
2X2 Cassette	AB18SC2VH*	0151800208A	WJ26X23785	YR-HBS01	\	Unplug	Chart 3
Pro Duct	AM24LP2VHA	0151800267	WJ26X23580	YR-HBS01	RE-02(CN21)	Unplug	Chart 2
Pro Duct	AM36LP2VHA	0151800106E	WJ26X23585	YR-HBS01	RE-02(CN29)	Unplug	Chart 2
Pro Duct	AM48LP2VHA	0151800106E	WJ26X23586	YR-HBS01	RE-02(CN29)	Unplug	Chart 2
Mid-Static Duct	USYM09UCDSA	0151800580	WJ26X27175	YR-HG	RE-02(CN29)	Unplug	Chart 4
Mid-Static Duct	USYM12UCDSA	0151800580	WJ26X27175	YR-HG	RE-02(CN29)	Unplug	Chart 4
Mid-Static Duct	USYM18UCDSA	0151800580	WJ26X27175	YR-HG	RE-02(CN29)	Unplug	Chart 4
Mid-Static Duct	USYM24UCDSA	0151800580	WJ26X27175	YR-HG	RE-02(CN29)	Unplug	Chart 4
Slim Duct	AD07SL2VH*	0151800175A	WJ26X23178	YR-HBS01	RE-02(CN29)	Unplug	Chart 2
Slim Duct	AD09SL2VH*	0151800175A	WJ26X23178	YR-HBS01	RE-02(CN29)	Unplug	Chart 2
Slim Duct	AD12SL2VH*	0151800175A	WJ26X23178	YR-HBS01	RE-02(CN29)	Unplug	Chart 2
Slim Duct	AD18SL2VH*	0151800175A	WJ26X23178	YR-HBS01	RE-02(CN29)	Unplug	Chart 2
Highwall	AW07EH2VHA	A0011001066	WJ26X25213	YR-HG	\	\	Chart 4
Highwall	AW09EH2VHA	A0011001066	WJ26X25213	YR-HG	\	\	Chart 4
Highwall	AW12EH2VHA	A0011001066	WJ26X25213	YR-HG	\	\	Chart 4
Highwall	AW18EH2VHA	A0011007590	WJ26X25413	YR-HG	\	\	Chart 4
Highwall	AW07LC2VHB	A0011800281CA	WJ26X23928	YR-HG	\	\	Chart 4
Highwall	AW09LC2VHB	A0011800281CA	WJ26X23928	YR-HG	\	\	Chart 4
Highwall	AW12LC2VHB	A0011800281CA	WJ26X23928	YR-HG	\	\	Chart 4
Highwall	AW18LC2VHB	A0011800281FA	WJ26X23929	YR-HG	\	\	Chart 4
Console	USYF09UCDWA	0151800579	WJ26X27223	YR-HG	\	\	Chart 4
Console	USYF12UCDWA	0151800579	WJ26X27223	YR-HG	\	\	Chart 4
Console	USYF18UCDWA	0151800579	WJ26X27223	YR-HG	\	\	Chart 4

Guide 1

1. Install the grille assembly and connect the power cable.
2. Unplug the wired controller.
3. Connect power to the unit.
4. Press the ON/OFF button on the remote control (HBS-01).
5. (Ignore this step if the display temperature is already °C,) Press MENU/OF button to switch the display temperature to °C, then press confirm.
6. Open the front cover of the remote controller, and press the LIGHT button 12 times in 7 seconds.
7. The panel will beep 4 times and display an "A".
8. Press the LIGHT button once to confirm. The display will read "A0".
9. Press the button TEMP. ↑ or TEMP. ↓ until the display shows "A5".
10. Press the LIGHT button once to confirm. The display will read "0b".
11. Press the button TEMP. ↑ or TEMP. ↓ to scroll through the listed Codes. Each code is associated with a corresponding compensation value (see table below). For example, if you want make the temperature invalid, scroll it to 0F.
12. Press the LIGHT button once to confirm. The display will read "A5".
13. Press the ON/OFF button on the remote control to save the changes.

Code	0	1	2	3	4	5	6	7	8	9	0A	0b	0C	0d	0E	0F
compensation value °C	15	14	13	12	11	10	9	8	7	6	5	4	3	2	1	0

Guide 2

1. Remove power to the unit and unplug the wired controller from the indoor unit PCB.
2. Connect the infrared remote signal receiver to indoor unit PCB.
0151800106E = socket CN29
0151800267 = socket CN21
3. Apply power to the unit.
4. Press the ON/OFF button on the remote control (HBS-01).
5. (Ignore this step if the display temperature is already °C,) Press MENU/°F button to switch the display temperature to °C, then press confirm.
6. Set the remote controller for HEAT mode operation, and set the temperature to 24°C.
7. Aim the controller at the infrared signal receiver, and press the SLEEP button 7 times within 5 seconds. The remote signal receiver will beep 2 times. The beeps indicates the set temperature compensation modification is available.
8. Aim the controller at the infrared signal receiver and adjust the temperature to X°C, then set the unit to OFF by pressing the controller's ON/OFF button. The remote signal receiver will beep 4 times. The beep indicates the set temperature compensation has been set successfully. *Note: X-24 is the compensation value. If X is set to 24, compensation is canceled (0). If X = 25, compensation is 1°C. If X = 26, compensation is 2°C. If X = 22, compensation is -2°C, and so on.*
9. To disable temperature compensation (0), set X to 24
10. Remove power and connect the wired controller.
11. Set the unit to OFF by pressing the button ON/OFF button. The setting will be in effect with the next ON time. This setting will be saved in the EEPROM.

Guide 3

1. Remove power to the unit and unplug the wired controller from the indoor unit PCB.
2. Apply power to the unit.
3. Press the ON/OFF button on the remote control (HBS-01).
4. (Ignore this step if the display temperature is already °C,) Press MENU/°F button to switch the display temperature to °C, then press confirm.
5. Set the remote controller for HEAT mode operation, and set the temperature to 24°C.
6. Aim the controller at the infrared signal receiver, and press the SLEEP button 7 times within 5 seconds. The remote signal receiver will beep 2 times. The beeps indicates the set temperature compensation modification is available.
7. Aim the controller at the infrared signal receiver and adjust the temperature to X°C, then set the unit to OFF by pressing the controller's ON/OFF button. The remote signal receiver will beep 4 times. The beep indicates the set temperature compensation has been set successfully. *Note: X-24 is the compensation value. If X is set to 24, compensation is canceled (0). If X = 25, compensation is 1°C. If X = 26, compensation is 2°C. If X = 22, compensation is -2°C, and so on.*
8. Remove power and connect the wired controller.
9. Set the unit to OFF by pressing the button ON/OFF button. The setting will be in effect with the next ON time. This setting will be saved in the EEPROM.

Guide 4

1. Apply power to the unit.
2. Set to Cooling Mode or Heating Mode
3. Set the temperature to 24°C.
4. Press the SLEEP button 7 times within 5 seconds. Indoor PCB will Beep 2 times to confirm.
5. 24°C will be the starting/reference point for the Temperature Compensation. Temperature Compensation can be adjusted from -8°C to +6°C. Example: if you want to set the Temperature Compensation value by 4°C, then set the temperature to 28°C.
6. Once the desired value has been selected, turn OFF the unit via the YR-HG controller to save the compensation settings.

Matching Tables

2U18MS2VHB / 2U20EH2VHA

	Combinations		Total Capacity	Required Adapter	
	Port B	Port A		MS	EH
	1/4" x 3/8"	1/4" x 3/8"			
Two Zone	7	7	14K	-	-
	9	7	16K	-	-
	9	9	18K	-	-
	12	7	19K	-	-
	12	9	21K	-	-
	12	12	24K	-	-

3U24MS2VHB / 3U24EH2VHA

	Combinations			Total Capacity	Required Adapter	
	Port C	Port B	Port A		MS	EH
	MS: 1/4" x 3/8" EH: 1/4" x 1/2"	1/4" x 3/8"	1/4" x 3/8"			
Two Zone	7	7	---	14K	-	E
	9	7	---	16K	-	E
	9	9	---	18K	-	E
	12	7	---	19K	-	E
	12	9	---	21K	-	E
	12	12	---	24K	-	E
	18	7	---	25K	D	-
	18	9	---	27K	D	-
	18	12	---	30K	D	-
Three Zone	7	7	7	21K	-	E
	9	7	7	23K	-	E
	9	9	7	25K	-	E
	12	7	7	26K	-	E
	9	9	9	27K	-	E
	12	9	7	28K	-	E
	12	9	9	30K	-	E
	12	12	7	31K*	-	E
	18	7	7	32K*	D	-
12	12	9	33K*	-	E	

*ALL INDOOR UNITS MUST BE FLEXFIT.

Adapters

		GEA Part #
A	1/4" to 3/8" (Liquid line for ports C & D)	WJ01X23925
B	3/8" to 5/8" (Vapor line for port C)	WJ01X23924
C	1/2" to 5/8" (Vapor line for port D)	WJ01X23932
D	3/8" to 1/2" (Vapor line for port C)	WJ01X26853
E	1/2" to 3/8" (Vapor line for port C OR D)	WJ01X26854

4U36MS2VHB/ 4U36EH2VHA

	Combinations				Total Capacity	Required Adapter	
	Port D	Port C	Port B	Port A		MS	EH
	1/4" x 1/2"	1/4" x 3/8"	1/4" x 3/8"	1/4" x 3/8"			
Two Zone	18	9	---	---	27K	-	-
	18	12	---	---	30K	-	-
	24	7	---	---	31K	-	C
	24	9	---	---	33K	-	A
	24	12	---	---	36K	-	A
	18	18	---	---	36K	-	D
	18	24	---	---	42K	-	A
	24	24	---	---	48K*	-	B
							C
							A (x2)
Three Zone	9	9	9	---	27K	E	-
	12	9	7	---	28K	E	-
	12	9	9	---	30K	E	-
	12	12	7	---	31K	E	-
	18	7	7	---	32K	-	-
	12	12	9	---	33K	E	-
	18	9	7	---	34K	-	-
	18	9	9	---	36K	-	-
	12	12	12	---	36K	E	-
	18	12	7	---	37K	-	-
	24	7	7	---	38K	-	C
	18	12	9	---	39K	-	A
	24	9	7	---	40K	-	C
	24	9	9	---	42K	-	A
	18	12	12	---	42K	-	-
	24	12	7	---	43K	-	C
	24	12	9	---	45K	-	A
	18	18	12	---	48K*	-	D
24	12	12	---	48K*	-	C	
						A	
Four Zone	7	7	7	7	28K	-	E
	9	7	7	7	30K	-	E
	9	9	7	7	32K	-	E
	12	7	7	7	33K	-	E
	9	9	9	7	34K	-	E
	12	9	7	7	35K	-	E
	9	9	9	9	36K	-	E
	12	9	9	7	37K	-	E
	12	12	7	7	38K	-	E
	12	9	9	9	39K	-	E
	18	7	7	7	39K	-	-
	12	12	9	7	40K	-	E
	18	9	7	7	41K	-	-
	12	12	9	9	42K	-	E
	12	12	12	7	43K	-	E
	18	9	9	7	43K	-	-
	18	12	7	7	44K	-	-
	24	7	7	7	45K	-	C
	12	12	12	9	45K	-	E
	24	9	7	7	47K*	-	C
	12	12	12	12	48K*	-	E
	18	12	9	9	48K*	-	-

*ALL INDOOR UNITS MUST BE FLEXFIT.

Resistance Chart / Sensor Definitions

Abbr.	Definition	Type
tAo	Temperature of outdoor ambient	10K
tc	Temperature of outdoor condenser	10K
td	Temperature of outdoor discharge	50K
tE	Temperature of outdoor defrost	10K
tS	Temperature of outdoor suction	10K
tdr	Temperature of compressor driver module	10K
ldr	Current of the compressor	10K

Abbr.	Definition	Type
tAI	Temperature of indoor ambient	10K
TCl	Temperature of indoor condenser	10K
Toci	Hot Gas Leaving the 4-Way Valve	10K
Tc2	EEV Liquid Sensor	10K
Tc1	EEV Gas Sensor	10K
Tm	Module Temp Sensor	10K
TAI	Temperature of indoor ambient (9K/12K Tempo & All CAC)	23K

10K Sensors: Ambient (all except ducted, cassette, and 9K-12K Tempo) suction, gas, defrost, and pipe sensors.

23K Sensors: Ambient sensors for ducted, cassette, and 9K-12K Tempo

50K Sensors: Discharge sensors

°F	°C	Normal (KΩ)		
		10K SENSORS	23K SENSORS	50K SENSORS
-22	-30	147.95	513.115	12061.74
-20.2	-29	139.56	478.894	11267.87
-18.4	-28	131.70	447.408	10531.37
-16.6	-27	124.34	418.379	9847.72
-14.8	-26	117.44	391.564	9212.81
-13	-25	110.96	366.751	8622.85
-11.2	-24	104.89	343.754	8074.38
-9.4	-23	99.19	322.407	7564.22
-7.6	-22	93.83	302.567	7089.47
-5.8	-21	88.80	284.105	6647.45
-4	-20	84.07	266.905	6235.71
-2.2	-19	79.62	250.866	5851.99
-0.4	-18	75.44	235.895	5494.21
1.4	-17	71.50	221.911	5160.46
3.2	-16	67.79	208.838	4849.00
5	-15	64.30	196.609	4558.19
6.8	-14	61.01	185.163	4286.55
8.6	-13	57.91	174.443	4032.71
10.4	-12	54.99	164.399	3795.39
12.2	-11	52.23	154.983	3573.43
14	-10	49.62	146.153	3365.73
15.8	-9	47.17	137.87	3171.31
17.6	-8	44.85	130.096	2989.25
19.4	-7	42.65	122.799	2818.67
21.2	-6	40.58	115.946	2658.81
23	-5	38.62	109.51	2508.91
24.8	-4	36.77	103.462	2368.32
26.6	-3	35.01	97.779	2236.39
28.4	-2	33.36	92.437	2112.55
30.2	-1	31.78	87.415	1996.25
32	0	30.30	82.691	1887.00
33.8	1	28.89	78.248	1784.33
35.6	2	27.55	74.067	1687.81
37.4	3	26.29	70.133	1597.04
39.2	4	25.09	66.43	1511.65
41	5	23.95	62.943	1431.28
42.8	6	22.87	59.659	1355.62
44.6	7	21.84	56.566	1284.36
46.4	8	20.87	53.651	1217.23
48.2	9	19.94	50.904	1153.96
50	10	19.06	48.314	1094.32
51.8	11	18.23	45.872	1038.07
53.6	12	17.43	43.569	985.01
55.4	13	16.68	41.395	934.94
57.2	14	15.96	39.343	887.68
59	15	15.28	37.406	843.05
60.8	16	14.63	35.577	800.89
62.6	17	14.01	33.848	761.06
64.4	18	13.42	32.215	723.41
66.2	19	12.86	30.671	687.82
68	20	12.32	29.21	654.16
69.8	21	11.81	27.828	622.32
71.6	22	11.33	26.521	592.18
73.4	23	10.86	25.283	563.66
75.2	24	10.42	24.111	536.65
77	25	10.00	23	511.08
78.8	26	9.60	21.947	486.94

°F	°C	Normal (KΩ)		
		10K SENSORS	23K SENSORS	50K SENSORS
80.6	27	9.21	20.949	464.05
82.4	28	8.85	20.003	442.35
84.2	29	8.50	19.104	421.77
86	30	8.16	18.252	402.24
87.8	31	7.84	17.442	383.72
89.6	32	7.54	16.674	366.13
91.4	33	7.25	15.943	349.43
93.2	34	6.97	15.249	333.58
95	35	6.70	14.588	318.52
96.8	36	6.45	13.96	304.22
98.6	37	6.20	13.362	290.62
100.4	38	5.97	12.794	277.70
102.2	39	5.75	12.252	265.41
104	40	5.53	11.736	253.73
105.8	41	5.33	11.244	242.62
107.6	42	5.13	10.776	232.04
109.4	43	4.94	10.329	221.98
111.2	44	4.76	9.904	212.41
113	45	4.59	9.497	203.29
114.8	46	4.43	9.11	194.61
116.6	47	4.27	8.74	186.34
118.4	48	4.11	8.387	178.46
120.2	49	3.97	8.05	170.95
122	50	3.83	7.728	163.80
123.8	51	3.69	7.421	156.97
125.6	52	3.57	7.127	150.47
127.4	53	3.44	6.846	144.26
129.2	54	3.32		138.35
131	55	3.21		132.70
132.8	56	3.10		127.31
134.6	57	2.99		122.16
136.4	58	2.89		117.25
138.2	59	2.79		112.56
140	60	2.70		108.08
141.8	61	2.61		103.80
143.6	62	2.52		99.70
145.4	63	2.44		95.79
147.2	64	2.36		92.06
149	65	2.28		88.48
150.8	66	2.21		85.06
152.6	67	2.14		81.79
154.4	68	2.07		78.66
156.2	69	2.00		75.67
158	70	1.94		72.80
159.8	71	1.88		70.06
161.6	72	1.82		67.43
163.4	73	1.76		64.91
165.2	74	1.71		62.50
167	75	1.65		60.19
168.8	76	1.60		57.98
170.6	77	1.55		55.86
172.4	78	1.51		53.82
174.2	79	1.46		51.87
176	80	1.41		50.00
177.8	81	1.37		48.21
179.6	82	1.33		46.48
181.4	83	1.29		44.83

°F	°C	Normal (KΩ)		
		10K SENSORS	23K SENSORS	50K SENSORS
183.2	84	1.25		43.25
185	85	1.22		41.72
186.8	86	1.18		40.26
188.6	87	1.14		38.85
190.4	88	1.11		37.50
192.2	89	1.08		36.21
194	90	1.05		34.96
195.8	91	1.02		33.77
197.6	92	0.99		32.62
199.4	93	0.96		31.51
201.2	94	0.93		30.45
203	95	0.91		29.42
204.8	96	0.88		28.44
206.6	97	0.86		27.50
208.4	98	0.83		26.59
210.2	99	0.81		25.71
212	100	0.79		24.87
213.8	101	0.76		24.06
215.6	102	0.74		23.28
217.4	103	0.72		22.52
219.2	104	0.70		21.80
221	105	0.68		21.10
222.8	106	0.67		20.43
224.6	107	0.65		19.78
226.4	108	0.63		19.16
228.2	109	0.61		18.56
230	110	0.60		17.98
231.8	111	0.58		17.42
233.6	112	0.57		16.88
235.4	113	0.55		16.36
237.2	114	0.54		15.85
239	115	0.52		15.37
240.8	116	0.51		14.90
242.6	117	0.50		14.45
244.4	118	0.48		14.01
246.2	119	0.47		13.59
248	120	0.46		13.19
249.8	121			12.80
251.6	122			12.42
253.4	123			12.05
255.2	124			11.70
257	125			11.35
258.8	126			11.02
260.6	127			10.70
262.4	128			10.40
264.2	129			10.10
266	130			9.81
267.8	131			9.53
269.6	132			9.26
271.4	133			9.00
273.2	134			8.74
275	135			8.50
276.8	136			8.26
278.6	137			8.03
280.4	138			7.81
282.2	139			7.60
284	140			7.39

Highwall Horizontal Louver Motor

	Orange	Yellow	Pink	Blue	Grey
Red	193 Ω	189.5 Ω	185.4 Ω	191.5 Ω	-
Orange	-	381.6 Ω	377.4 Ω	383.3 Ω	47 Ω
Yellow	-	-	373.9 Ω	379.9 Ω	-
Pink	-	-	-	375.8 Ω	46.8 Ω
Blue	-	-	-	-	-
Grey	-	-	-	-	-

Highwall Vertical Louver Motor

	Yellow	Orange	Blue	Red	Grey
White	-	92.6 Ω	-	47 Ω	-
Yellow	-	-	93.1 Ω	-	47 Ω
Orange	-	-	-	46.5 Ω	-
Blue	-	-	-	-	46.8 Ω
Red	-	-	-	-	-
Grey	-	-	-	-	-

Highwall Horizontal Louver Motor (FlexFit)

	Blue	Violet	Yellow	Orange	Red
Blue	-	393 Ω	394 Ω	395 Ω	196 Ω
Violet	-	-	396 Ω	397 Ω	198 Ω
Yellow	-	-	-	398 Ω	199 Ω
Orange	-	-	-	-	200 Ω
Red	-	-	-	-	-

Highwall Vertical Louver Motor (FlexFit)

	Blue	Violet	Yellow	Orange	Red
Blue	-	383 Ω	388 Ω	390 Ω	195 Ω
Violet	-	-	381 Ω	385 Ω	189 Ω
Yellow	-	-	-	388 Ω	193 Ω
Orange	-	-	-	-	196 Ω
Red	-	-	-	-	-

Ducted Horizontal & Vertical Louver Motors

	Red
Blue	200 Ω
Violet	200 Ω
Yellow	200 Ω
Orange	200 Ω

Cassette Louver Motor

	Red
Orange	200 Ω
Yellow	200 Ω
Blue	200 Ω
Violet	200 Ω

EEV (6-pin, 5 wire)

	White	Yellow	Orange	Blue	X	Red
White	-	92 Ω	92 Ω	92 Ω	-	46 Ω
Yellow	-	-	92 Ω	92 Ω	-	46 Ω
Orange	-	-	-	92 Ω	-	46 Ω
Blue	-	-	-	-	-	46 Ω
X	-	-	-	-	-	-
Red	-	-	-	-	-	-

EEV (6-pin, 6 wire)

	White	Yellow	Orange	Blue	Brown	Red
White	-	OL	92 Ω	OL	46 Ω	OL
Yellow	-	-	OL	92 Ω	OL	46 Ω
Orange	-	-	-	OL	46 Ω	OL
Blue	-	-	-	-	OL	46 Ω
Brown	-	-	-	-	-	OL
Red	-	-	-	-	-	-

4-Way Valve

Ohms	VAC
2.1K	208-230

Basepan Heater

Ohms	VAC
0.28K - 0.379K	208-230

Fan Motors

VDC Outputs to DC Fan Motor (VDC)			
PIN #	RED Probe	Black Probe	Value
6	Vdc	GND	300~380VDC
5	Blank	Blank	Blank
4	GND	GND	GND
3	Vcc	GND	15 ±1.5VDC
2	Vsp	GND	2~6.5VDC
1	FG	GND	2~9VDC

DC Fan Motor Pin Identification			
PIN #	Color	Abbr.	Definition
1	Blue	FG	Revolution Pulse Output
2	Yellow	Vsp	Speed Control Voltage Input
3	White	Vcc	Control Power Voltage Input
4	Black	GND	Ground
5	Blank	Blank	Blank
6	Red	Vdc	Motor Driver Voltage Input

DC Fan Motor Resistance Values (Ω)			
PIN #	RED Probe	Black Probe	Value
6	Vdc	GND	$\geq 1M\Omega$
5	Blank	Blank	Blank
4	GND	GND	GND
3	Vcc	GND	$\geq 1M\Omega$
2	Vsp	GND	$\geq 135K\Omega$
1	FG	GND	$\geq 1M\Omega$

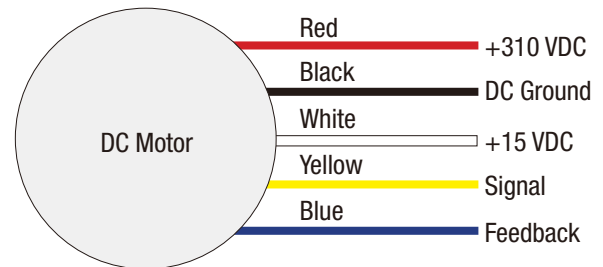

2U20EH2VHA

4-way valve coil:
 OFF → Refrigerant flow in cooling
 ON - - - - - Refrigerant flow in heating

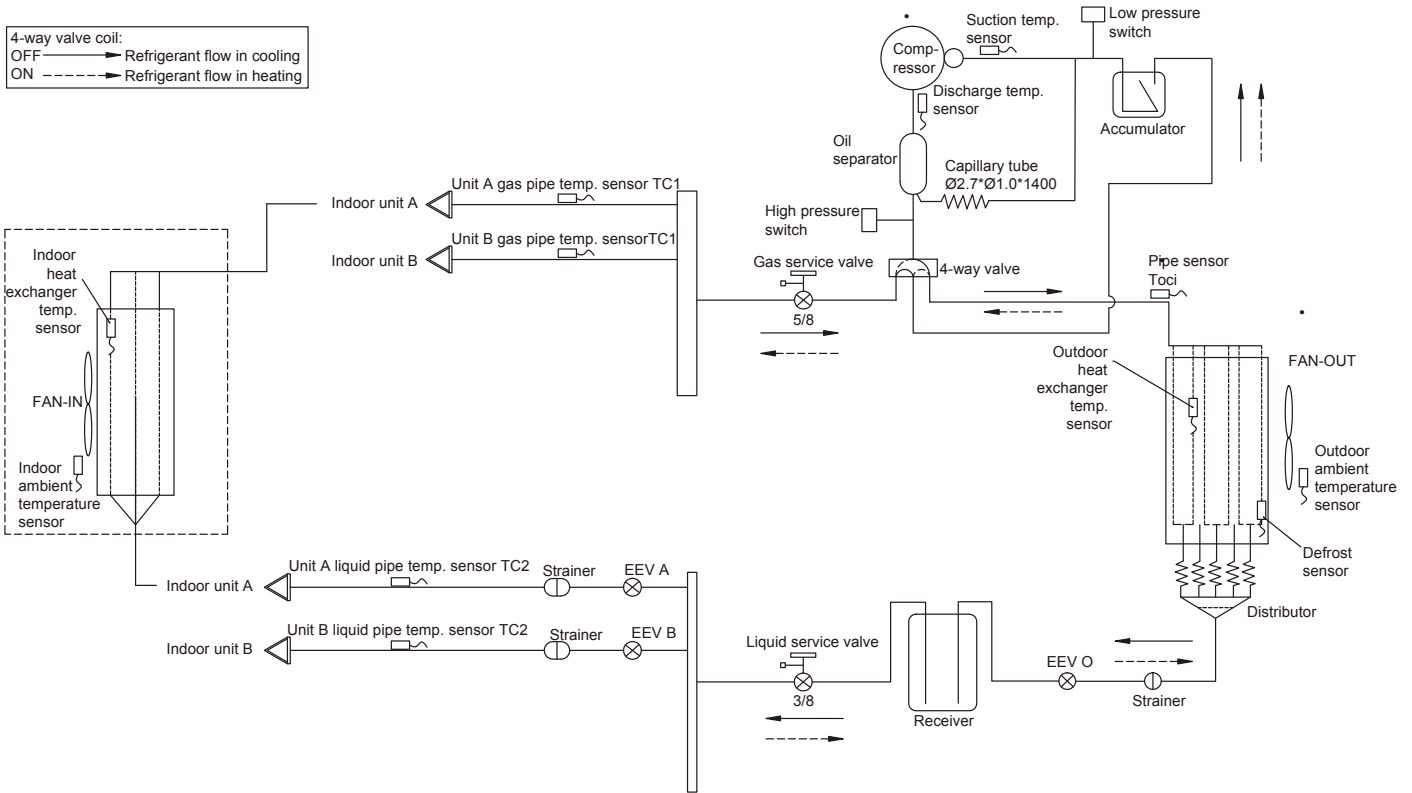

3U24EH2VHA

4-way valve coil:
 OFF → Refrigerant flow in cooling
 ON - - - - - Refrigerant flow in heating

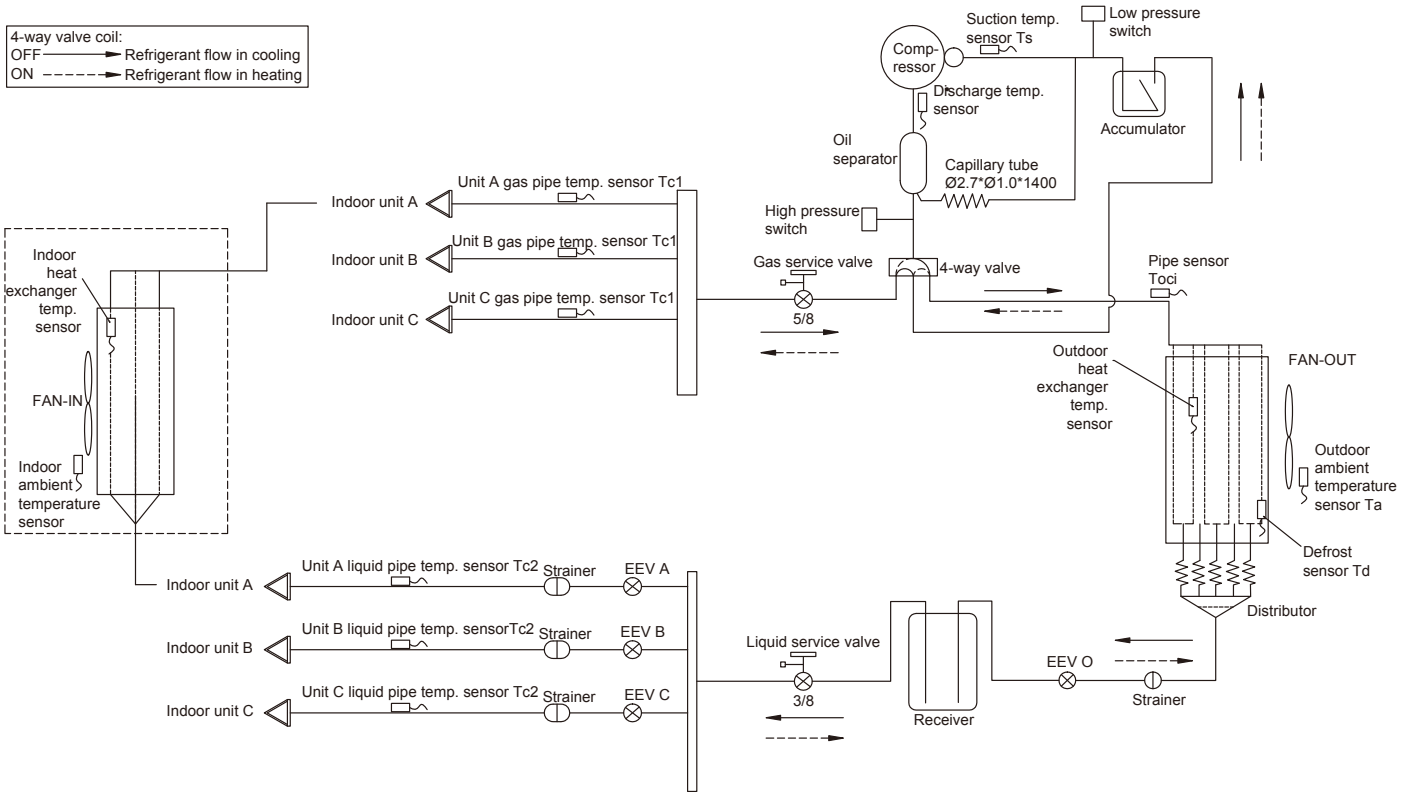

4U36EH2VHA

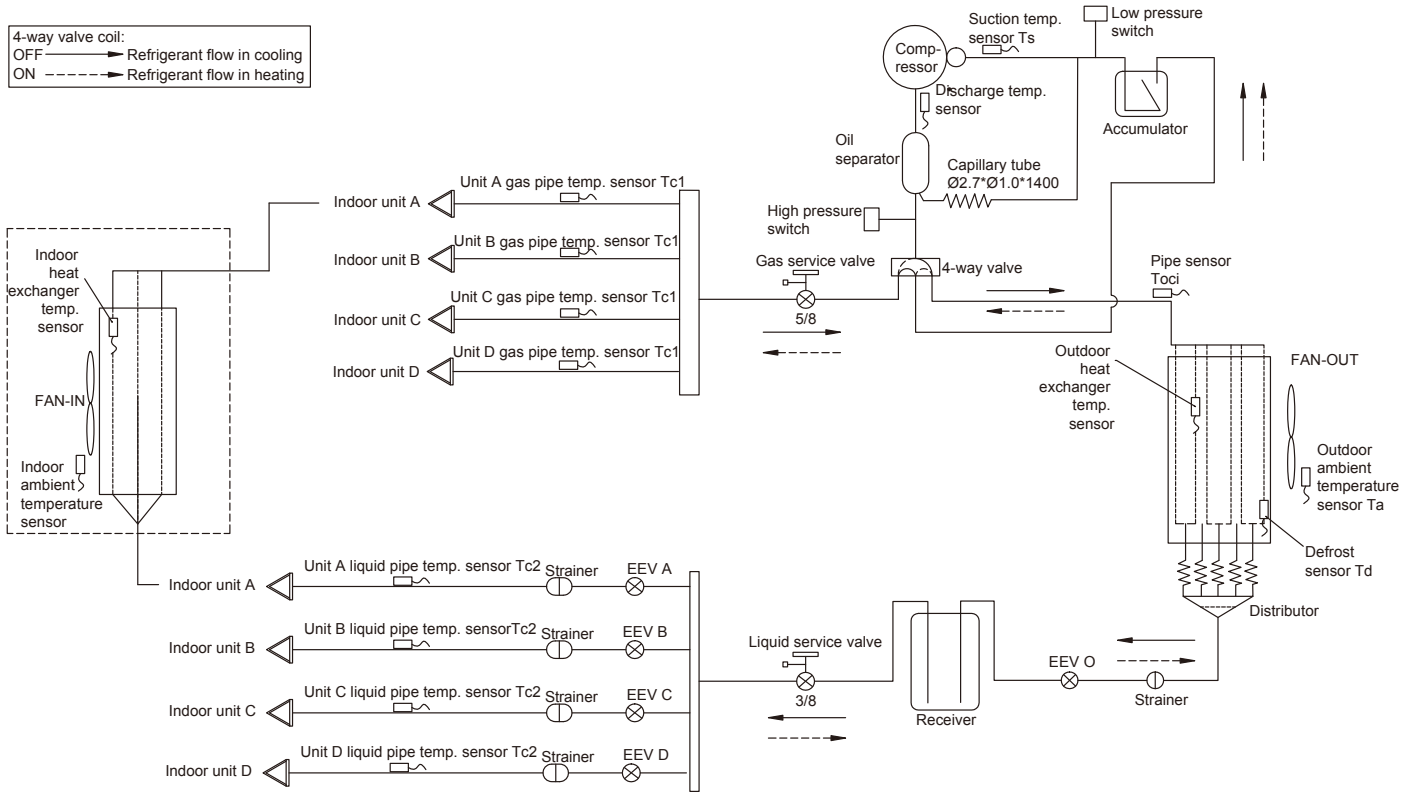

Master Error Code Chart

Outdoor Pro-Series LED Display (CAC)	Outdoor Multi-Zone LED Display (CAC)	Outdoor Single-Zone LED1 Flash (RAC)	FAULT DESCRIPTION	HIGHWALL	CONSOLE	COMPACT CASSETTE	
				Digital Display	Digital Display	Panel LED Flash or ID PCB LED Flash	
						Yellow Timer LED (PCB LED5)	Green Run LED (PCB LED1)
1	1	1	Outdoor EEPROM failure	F12	F12	2	1
2	2	2	IPM overcurrent or short circuit	F1	F1	2	2
/	/	3	Outdoor alternating current, over current protection	F22	F22	2	3
3	/	/	Compressor over current during deceleration	/	/	/	/
4	4	4	Communication failure between the IPM and outdoor PCB	F3	F3	2	4
5	5	5	Module operated overload (compressor overload protection)	F20*	F20*	2	5
6	6	6	Module low or high voltage	F19*	F19*	2	6
7	/	7	Compressor current sampling circuit fault	F27	F27	2	7
8	8	8	Overheat protection for discharge temperature	F4	F4	2	8
9	9	9	Malfunction of the DC fan motor	F8*	F8*	2	9
10	10	10	Malfunction of defrost temperature sensor	F21	F21	3	0
11	11	11	Suction temperature sensor failure	F7	F7	3	1
12	12	12	Ambient temperature sensor failure	F6	F6	3	2
13	13	13	Discharge temperature sensor failure	F25	F25	3	3
/	/	14	High outdoor suction temperature	F30*	F30*	3	4
14	/	/	PFC circuit loop voltage	/	/	/	/
15	15	15	Communication failure between the indoor & outdoor unit	E7	E7	3	5
16	16	16	Lack of refrigerant or discharging	F13*	F13*	3	6
17	17	17	4-way valve switching failure	F14*	F14*	3	7
18	18	18	Loss of synchronism detection	F11	F11	3	8
/	/	19	Position detection circuit fault of compressor	F28	F28	3	9
19	/	/	Low DC or AC voltage	/	/	/	/
/	/	20	Terminal block temp too high	F15*	F15*	4	0
20	20	/	Indoor thermal overload	E9	/	4	0
/	21	21	Indoor unit overload protection, heating mode only.	E9*	/	4	1
/	21	/	Indoor coil frosted	E5	/	4	1
/	/	22	Indoor anti-frosting protection	E5*	/	4	2
22	/	/	PFC circuit loop overcurrent	/	/	/	/
/	/	23	Indoor coil temperature (abnormal reading)	/	/	/	/
23	23	/	Module thermal overload	F5*	F5*	4	3
24	24	24	Compressor start failure, over-current	F2*	F2*	4	4
25	25	25	Phase current protection (IPM)	F23*	F23	4	5
/	26	/	MCU reset	F9	F9	4	6
26	/	/	IPM power supply phase loss (3-phase)	/	/		
27	27	27	Module current detect circuit malfunction	F24	F24	4	7
28	/	/	Wiring error: Compressor to IPM	/	/	/	/

* Hidden indoor error code. LED1 will flash outdoors, but no error will appear on indoor unit display. To view error code on indoor display, press and hold the Emergency button for 15 seconds.

Master Error Code Chart

LARGE CASSETTE			DUCTED						WIRED CONTROLLER	
Panel LED Flash or ID PCB LED Flash		Panel Display (PB*****)	HIGH STATIC		MID-STATIC DUCT (MSP)		SLIM DUCT		YRE-17A QACT17A	YRE-16B
Yellow Timer LED (PCB LED4)	Green Run LED (PCB LED1)		LED4 (Yellow)	LED3 (Green)	LED4	LED3	LED4 (Yellow)	LED3 (Green)		
2	1	15	2	1	2	1	2	1	15	21
2	2	16	2	2	2	2	2	2	16	22
/	/	/	/	/	/	/	/	/	17	23
2	3	17	2	3	2	3	2	3	17	23
2	4	18	2	4	2	4	2	4	18	24
2	5	19	2	5	2	5	2	5	19	25
2	6	1A	2	6	2	6	2	6	1A	26
2	7	1B	2	7	2	7	2	7	1B	27
2	8	1C	2	8	2	8	2	8	1C	28
2	9	1D	2	9	2	9	2	9	1D	29
3	0	1E	3	0	3	0	3	0	1E	30
3	1	1F	3	1	3	1	3	1	1F	31
3	2	20	3	2	3	2	3	2	20	32
3	3	21	3	3	3	3	3	3	21	33
/	/	/	/	/	/	/	/	/	22	34
3	4	22	3	4	3	4	3	4	22	34
3	5	23	3	5	3	5	3	5	23	35
3	6	24	3	6	3	6	3	6	24	36
3	7	25	3	7	3	7	3	7	25	37
3	8	26	3	8	3	8	3	8	26	38
/	/	/	/	/	/	/	/	/	27	39
3	9	27	3	9	3	9	3	9	27	39
/	/	/	/	/	/	/	/	/	28	40
4	0	28	4	0	4	0	4	0	28	40
/	/	/	/	/	/	/	/	/	29	41
4	1	29	4	1	4	1	4	1	29	41
/	/	/	/	/	/	/	/	/	2A	42
4	2	2A	4	2	4	2	4	2	2A	42
/	/	/	/	/	/	/	/	/	/	/
4	3	2B	4	3	4	3	4	3	2B	43
4	4	2C	4	4	4	4	4	4	2C	44
4	5	2D	4	5	4	5	4	5	2D	45
4	6	2E	4	6	4	6	4	6	2E	46
/	/	/	/	/	/	/	/	/	2F	47
4	7	2F	4	7	4	7	4	7	2F	47
/	/	/	/	/	/	/	/	/	/	/

Master Error Code Chart

Outdoor Pro-Series LED Display (CAC)	Outdoor Multi-Zone LED Display (CAC)	Outdoor Single-Zone LED1 Flash (RAC)	FAULT DESCRIPTION	HIGHWALL	CONSOLE	COMPACT CASSETTE	
				Digital Display	Digital Display	Panel LED Flash or ID PCB LED Flash	
						Yellow Timer LED (PCB LED5)	Green Run LED (PCB LED1)
/	/	28	Low refrigerant flow. Lockout.	/	/	/	/
/	28	/	Liquid pipe sensor failure: Circuit A	F10	F10	4	8
/	29	/	Liquid pipe sensor failure: Circuit B	F16	F16	4	9
/	30	/	Liquid pipe sensor failure: Circuit C	F17	F17	5	0
/	31	/	Liquid pipe sensor failure: Circuit D	F18	F18	5	1
/	32	/	Gas pipe sensor failure: Circuit A	F29	F29	5	2
/	33	/	Gas pipe sensor failure: Circuit B	F30	F30	5	3
/	34	/	Gas pipe sensor failure: Circuit C	F31	F31	5	4
/	35	/	Gas pipe sensor failure: Circuit D	F32	F32	5	5
/	36	/	Gas pipe sensor failure: Circuit E	F26	F26	5	6
/	/	37	Outdoor pipe temperature protection in cooling mode	F34	F34	5	7
37	/	/	Compressor overcurrent detected by IPM	/	/	/	/
38	38	/	Malfunction of module temperature sensor momentary power failure detection	F35	F35	5	8
39	39	39	Malfunction of condensing temperature sensor	F36	F36	5	9
/	40	/	Liquid pipe sensor failure - Circuit E	F33	F33	6	0
/	41	/	Toci temperature sensor failure	F38	F38	6	1
42	42	/	High Pressure switch open	F39	F39	6	2
43	43	/	Low Pressure switch open	F40	F40	6	3
44	44	/	System high pressure protection: Overcharged, high condensing temperature or malfunction of fan motor.	F41	F41	6	4
45	45	/	System low pressure protection: Undercharged, low defrosting temperature, or malfunction of fan motor.	F42	F42	6	5
/	/	46	Incorrect match between indoor & outdoor	F43	F43	6	6
/	L0	/	OAT less than -22°F (-30°C)	/	/	/	/
/	/	/	Indoor ambient temperature sensor failure	E1	E1	0	1
/	/	/	Indoor coil temperature sensor failure	E2	E2	0	2
/	/	/	Indoor PCB EEPROM failure	E4	E4	0	4
/	/	/	Communication fault between the indoor and outdoor unit	/	/	0	7
/	/	/	Communication fault between the controller and Indoor unit	/	E8	0	8
/	/	/	DC voltage of the fan motor driver too high or too low	/	/	/	/
/	/	/	Fan motor driver over 95°F (35°C)	/	/	/	/
/	/	/	Indoor fan motor out of step	/	/	/	/
/	/	/	Drain system malfunction	/	E12	0	12
/	/	/	Zero cross signal detected wrong	/	E13 / C1	0	13
/	/	/	Indoor fan motor malfunction	E14*	E14	0	14
/	/	/	Indoor fan motor overcurrent	/	/	/	/

* Hidden indoor error code. LED1 will flash outdoors, but no error will appear on indoor unit display. To view error code on indoor display, press and hold the Emergency button for 15 seconds.

Master Error Code Chart

LARGE CASSETTE			DUCTED						WIRED CONTROLLER	
Panel LED Flash or ID PCB LED Flash		Panel Display (PB*****)	HIGH STATIC		MID-STATIC DUCT (MSP)		SLIM DUCT		YRE-17A QACT17A	YRE-16B
Yellow Timer LED (PCB LED4)	Green Run LED (PCB LED1)		LED4 (Yellow)	LED3 (Green)	LED4	LED3	LED4 (Yellow)	LED3 (Green)		
/	/	/	/	/	/	/	/	/	/	/
4	8	30	4	8	4	8	4	8	30	48
4	9	31	4	9	4	9	4	9	31	49
5	0	32	5	0	5	0	5	0	32	50
5	1	33	5	1	5	1	5	1	33	51
5	2	34	5	2	5	2	5	2	34	52
5	3	35	5	3	5	3	5	3	35	53
5	4	36	5	4	5	4	5	4	36	54
5	5	37	5	5	5	5	5	5	37	55
5	6	38	5	6	5	6	5	6	38	56
/	/	/	/	/	/	/	/	/	39	57
5	7	39	5	7	5	7	5	7	39	57
5	8	3A	5	8	5	8	5	8	3A	58
5	9	3B	5	9	5	9	5	9	3B	59
6	0	3C	6	0	6	0	6	0	3C	60
6	1	3D	6	1	6	1	6	1	3D	61
6	2	3E	6	2	6	2	6	2	3E	62
6	3	3F	6	3	6	3	6	3	3F	63
6	4	40	6	4	6	4	6	4	40	64
6	5	41	6	5	6	5	6	5	41	65
/	/	/	/	/	/	/	/	/	42	66
/	/	/	/	/	/	/	/	/	/	/
0	1	01	0	1	0	1	0	1	01	01
0	2	02	0	2	0	2	0	2	02	02
0	4	04	0	4	0	4	0	4	04	04
0	7	07	0	7	0	7	0	7	07	07
0	8	08	0	8	0	8	0	8	Flashing 07 (YR-E17) / Flashing ! (QACT17A)	/
/	/	/	0	17	/	/	0	17	11	17
/	/	/	0	18	/	/	0	18	12	18
/	/	/	0	19	/	/	0	19	13	19
0	12	0C	0	12	0	12	0	12	0C	12
0	13	0D	0	13	0	13	0	13	0D	13
0	14	0E	0	14	0	14	0	14	0E	14
/	/	/	0	15	/	/	0	15	0F	15

When the system generates an error code, it will be displayed on the Service Monitor Board, the number of flashes on the PCB, and also on the indoor unit display panel.

Temperature Sensor Error Codes

The easiest problems to solve will involve codes that are related to potential failure of temperature sensors. Common problems may include loose connections, open or shorted, and out of calibration. Checking the condition of the sensors requires a temperature probe and an ohmmeter.

The Reference Section of this manual contains temperature resistance tables that can be used to check the calibration of the sensors. The measured resistance must be within the tolerances located in the tables.

There are 16 potential Error Codes that can be generated by the PCB to indicate a failure of an outdoor unit temperature sensor.

Error Code 10

This code indicates an electrical failure of the sensor that is used to sense the temperature of the outdoor coil during defrost. This sensor is connected to the PCB via a connection at Plug CN-14.

Error Code 11

This code indicates an electrical failure of the sensor that is used to sense the temperature of the suction gas that enters the compressor. The sensor is connected to the PCB via two wires at Plug CN-14.

Error Code 12

This code indicates an electrical failure of the sensor that is used to sense the temperature of the outdoor air. The sensor is connected to the PCB via two wires at Plug CN-14.

Error Code 13

This code indicates an electrical failure of the sensor that is used to sense the temperature of the compressor hot gas discharge line. The sensor is connected to the PCB via two wires at Plug CN-14.

Error Code 28-36

These codes indicate a failure of either a Liquid or Gas Temperature Sensor that is part of either the A, B, C, or D indoor unit EEV circuit. Refer to the outdoor unit Error Code Decal for specific identification of the malfunctioning temperature sensor. These sensors connect to the PCB at connection plugs near the center of the circuit board. (Note that if the sensor has failed, and there is an unused port on the unit available, the sensor from the unused port can be used to temporarily fix the problem.)

Error Code 38

This code indicates a potential failure of the IPM temperature sensor. This sensor connects to the IPM via Plug CN-8. This sensor is mounted near the heat sink.

Error Code 39

This code indicates an electrical failure of the sensor that is used to sense the condensing temperature of the outdoor coil. The sensor is connected to the PCB via two wires at Plug CN-14.

Error Code 41

This code indicates an electrical failure of the 'Toci' sensor, which ensures there is no drop in hot gas temperature through the 4-way valve. The sensor is connected to the PCB via two wires at Plug CN-7.

Pressure-Related Error Codes

To protect the compressor, the PCB has a low pressure switch connection at CN13, and a high pressure switch connection at CN12.

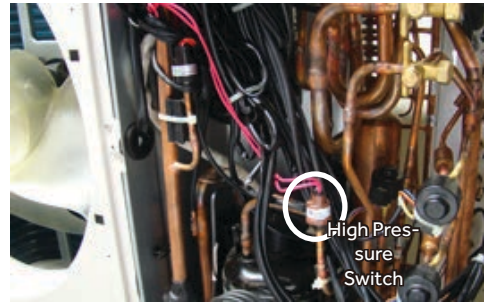
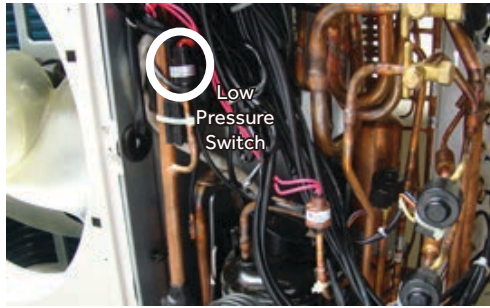

Error Code 42 & 43

The low pressure switch will generate an Error Code 43 if open. An open high pressure switch will show an Error Code 42.

Testing Procedure

If the system generates either of these two codes, check the continuity of the switch to ensure it is not open or shorted. High or low pressures are usually related to dirt in the coils, dirt in the air filter, or incorrect refrigerant charge.

There are no pressure ports that can be accessed to measure low pressure in heat mode nor high pressure in cool mode. If the system trips on one of these errors, it will be necessary to remove the refrigerant and re-charge to confirm low or high charge is not causing the problem.

Error Code 44

The system is operating at excessive refrigerant pressure. If the system is a new installation, it is likely that the charge is too high. Note the Weight Method is the ONLY way to charge this system.

Typical Causes of High Pressure in Cooling Mode:

- Overcharge
- Dirty outdoor coil
- Restriction

Typical Causes of High Pressure in Heating Mode:

- Overcharge
- Undersized refrigerant lines or excessive length
- Restriction

Note: If the refrigerant pressures are correct, yet the system does not close the error reporting pressure switch, replace the defective pressure switch.

Error Code 45

This code is indicating that system pressure is too low.

Typical Causes of Low Pressure in Cooling Mode:

- Lack of charge
- Low Heat on Indoor coil
- Restrictions, air flow, or dirt
- Low indoor load

Typical Causes of Low Pressure in Heating Mode:

- Cold outdoor air
- Lack of charge
- Restriction

Communication Error Code

Error Code 15

Data travels between the units on the terminal block connections 3/C and 1. A correct connection for each unit is indicated by a solid green LED on the Service Monitor Board. If an LED is flashing or not on, make sure the 14/4 stranded copper communication cable connections are tight and on the correct terminals. Additionally, ensure there are no splices in the 3/C wire, and that the PCB connections at CN21 are in good order. An incomplete or inadequate ground can easily be an issue.

Error Codes Caused by Abnormal Refrigerant Circuit Conditions

Error Code 8

This code indicates the temperature of the compressor hot gas is too high. This error occurs after the PCB has attempted to correct high temperature by reducing the compressor speed, adjusting the fan speed, or opening the EEV. Causes of this type of condition are typically a lack of refrigerant in the system, excessive heat in the conditioned space, or a restriction in the refrigeration circuit.

Error Code 16

This error code indicates the system may lack refrigerant. Recover and check the system charge.

Outdoor Error Code Related to Indoor Unit

Error Code 21

This code indicates the indoor coil has frosted. This condition can be due to a lack of heat in the conditioned space, operating the indoor unit at excessively cold air temperature, a blockage of air flow to the indoor unit, or an issue with the indoor fan motor. This condition will cause the system to enter an anti-freezing cycle.

Error Code Related to the PCB

Error Code 1

The EEPROM of the PCB cannot read or write data. Replace the PCB.

Error Codes Related to the IPM

Error Code 2

The IPM has either failed or has detected excessive current. Before replacing the IPM, check these potential causes of high current:

- Overcharge
- Dirty outdoor coil
- Hot conditioned space
- High temperature or excessive load
- Refrigeration circuit restriction
- Seized compressor
- Faulty wiring or wiring connections

Error Code 4

This code indicates the IPM is not communicating with the PCB. Check the wiring and the connections CN9 on the PCB and CN15 on the IPM. If the connections are good, yet the boards do not communicate and the code will not clear, check for correct voltage at the IPM CN15 connection. If the communication voltage is correct and the high voltage input is present, replace the IPM. If the communication voltage is not correct, replace the PCB.

Error Code 5

The IPM is protecting the compressor from overload, which can be caused by low building power supply, restrictions, a non-condensable in the system, a plugged coil, an excessive load, or a refrigerant overcharge.

Error Code 6

This code indicates the operating voltage of the system is either too high or too low. Check line voltage for proper limits. The line voltage supplied to the outdoor unit should be no lower than 187VAC when the compressor starts. The running voltage should be no lower than 197VAC. The incoming line voltage to the outdoor unit should never be higher than 253VAC. If improper voltage is present, check the supply voltage circuit from the building for correct wire size and good connections. If the voltage is still outside operating limits, contact the power company to have the service corrected.

If the line voltage from the power company is correct, check the output voltage of the Power Filter. This voltage connects to the IPM at terminals ACL and ACN.

If the voltage is not within specifications shown above, replace the PFB.

Error Code 18

There is a loss of synchronization among the U, V, and W compressor windings during frequency changes as they slow down or speed up the compressor.

Possible causes include:

- Unstable power supply
- Internal compressor fault
- IPM fault
- Compressor terminal wiring incorrect
- Poor wiring condition
- Loose compressor wiring connection

Error Code 23

This code indicates an IPM thermal overload. This error was generated by a temperature sensor located in the IPM heat sink. Causes of overheating are typically overcharge of refrigerant, excessively plugged coil, sensor open or shorted, or a non-condensable in system.

Error Code 26

Module reset indicates possible PCB power anomalies. This usually occurs when low line voltage conditions are present.

Error Code 27

The IPM has detected that the compressor current is too high.

Possible Causes:

- Overcharge
- Dirty outdoor coil
- Hot conditioned space temperature or high load
- Refrigeration circuit restriction
- Seized compressor
- Defective IPM

Error Codes Related to Compressor, Outdoor Fan & 4-Way Valve

Error Code 9

This code indicates the outdoor fan motor is not running. The fault is detected very quickly by the PCB. The system will shut off and display this error code. If this error occurs, refer to the outdoor fan motor test procedure.

Error Code 17

This error code indicates that the 4-way valve is not directing hot gas to the proper coil. Refer to the 4-way valve testing procedure.

Error Code 24

This error code indicates the compressor failed to start when a call for operation occurred. Refer to the compressor testing procedure.

[1] Outdoor EEPROM Malfunction

EEPROM communication error; EEPROM data check error (model ID, checksum, etc.); EEPROM data logic error (wider data range, wrong order, etc.)

Possible causes:

- EEPROM is bad
- Loose EEPROM wiring

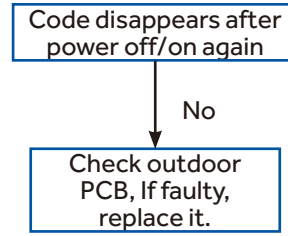

[2] Outdoor IPM over current or short circuit

Input over current detected by PIM's hardware.

Possible causes:

- The IPM is bad
- Loose compressor wire
- The compressor is bad

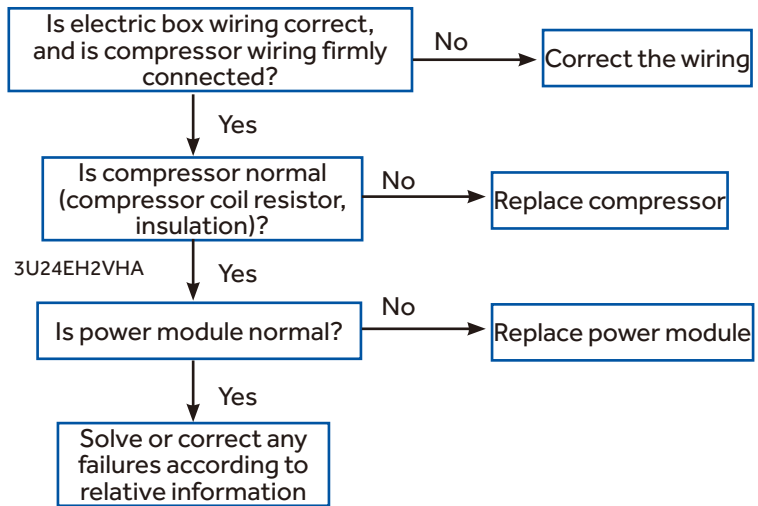

[4] Communication abnormal between PCB and IPM

Control board can not communicate with the compressor driver module for over 4 minutes

Possible causes:

- The communication wire is bad
- The PCB is bad
- The power module is bad

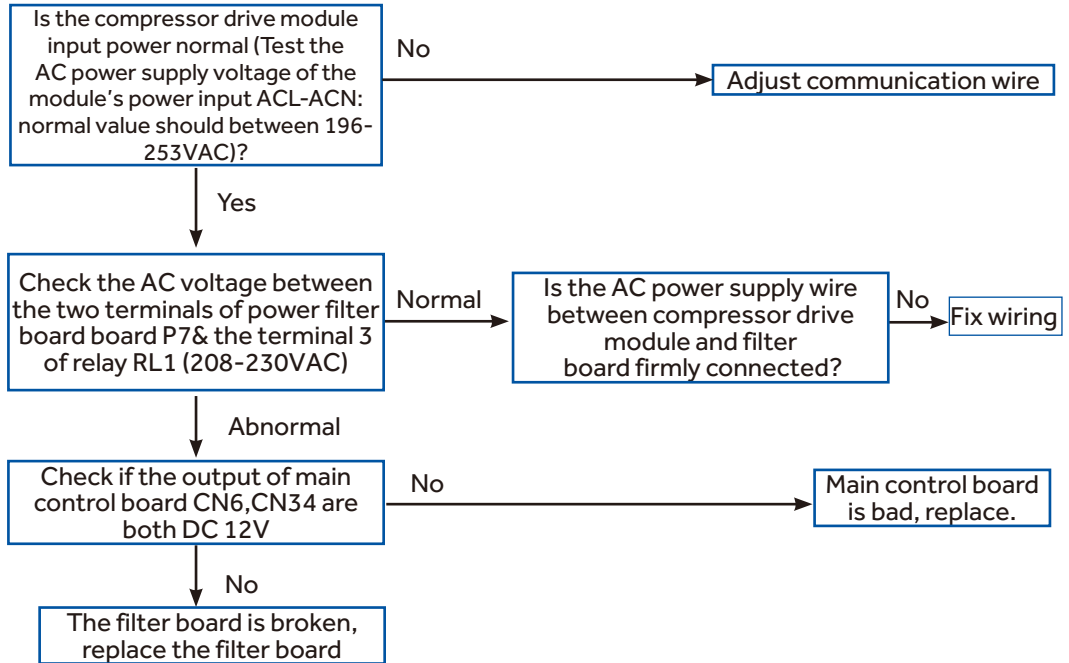

[6] DC voltage or AC voltage high

Driver module AC power supply voltage over 280VAC, or driver module DC-BUS voltage over 390VDC.

Possible causes:

- The power supply is abnormal
- Incorrect wiring
- Power module is bad

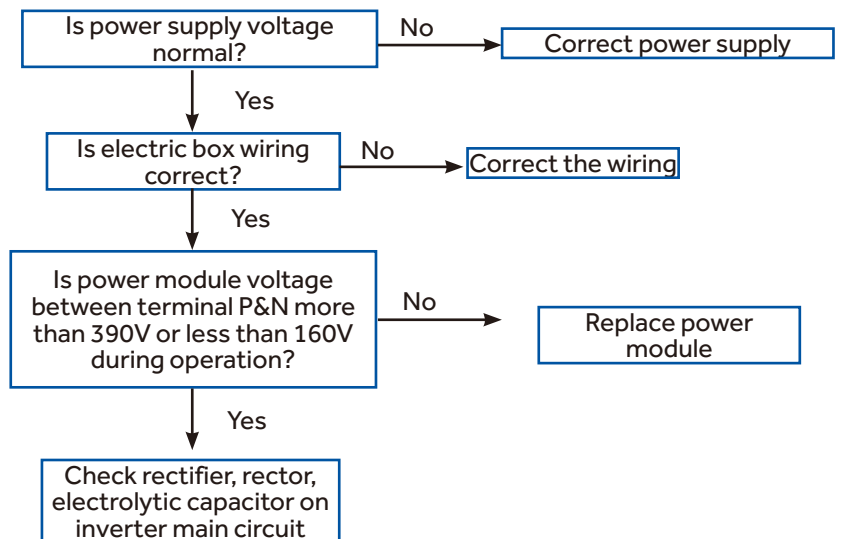

[8] Discharge temperature too high protection

Compressor discharge temperature over 115°C. Error clears within 3 minutes if temperature lowers below 115°C. Error status lock if it occurs 3 times in 1 hour.

Possible causes:

- The sensor is bad or fixed bad
- The system is clogged
- The system lack of refrigerant
- The valve opening is wrong

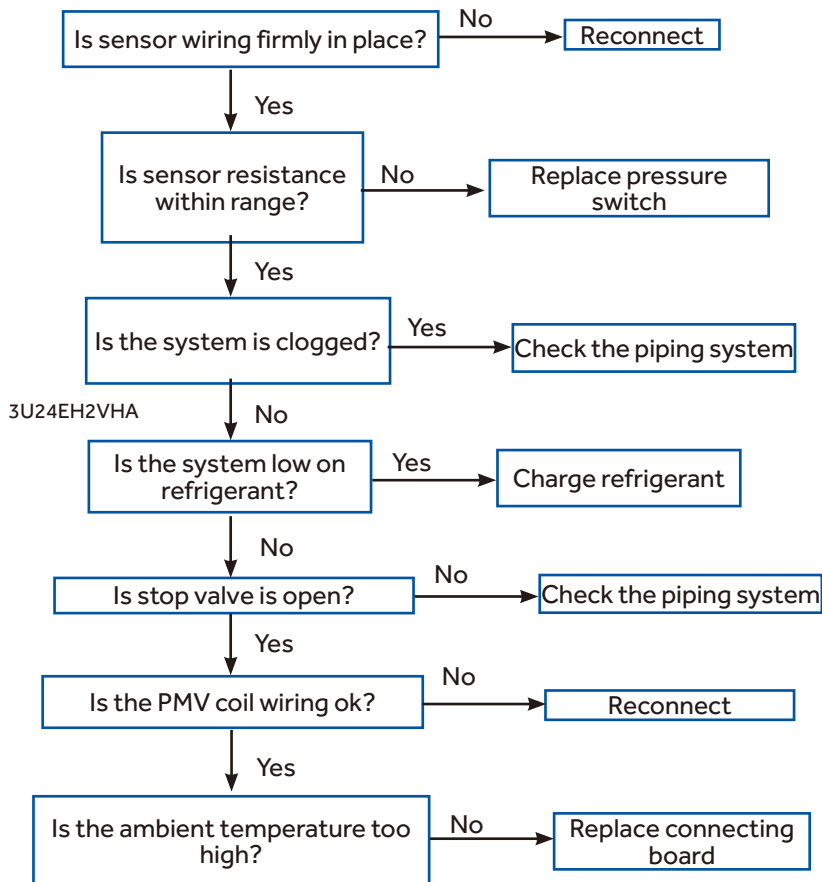

[9] DC fan motor fault

DC fan motor damaged, not connected, or related circuit broken. Error status confirms and locks if occurs 3 times within 30 minutes.

Possible causes:

- Loose motor wiring
- The motor is bad
- The PCB is bad

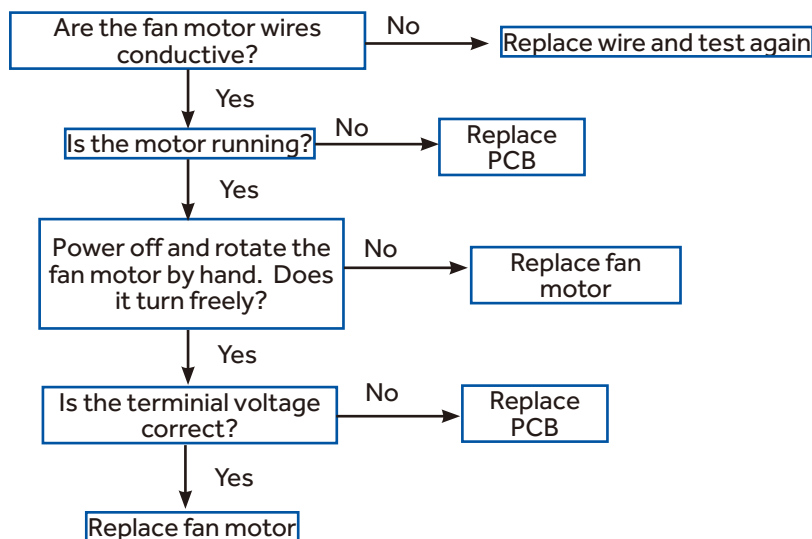

[10] Outdoor defrosting temp. sensor Te abnormal

[11] Suction temp. sensor Ts abnormal

[12] Outdoor ambient temp. sensor Ta abnormal

[13] Discharging temp. sensor Td abnormal

Sensor temperature has been detected below or higher than expected, or the sensor has been detected as a shorted or open circuit.

(for expected temperature, refer to part failure code)

Possible causes:

- Bad sensor connection
- The sensor is bad
- Sensor resistance drift
- The temperature acquired by PCB is not accurate

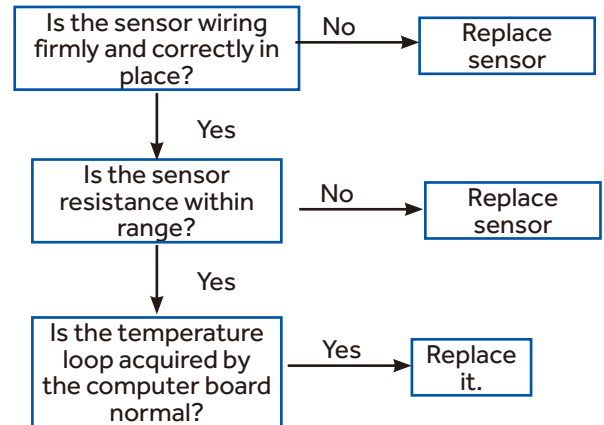

[15] Communication abnormal between indoor unit and outdoor unit

Outdoor unit control board cannot communicate with the indoor unit control board for over 4 minutes.

Possible causes:

- Bad communication wiring
- The PCB is bad

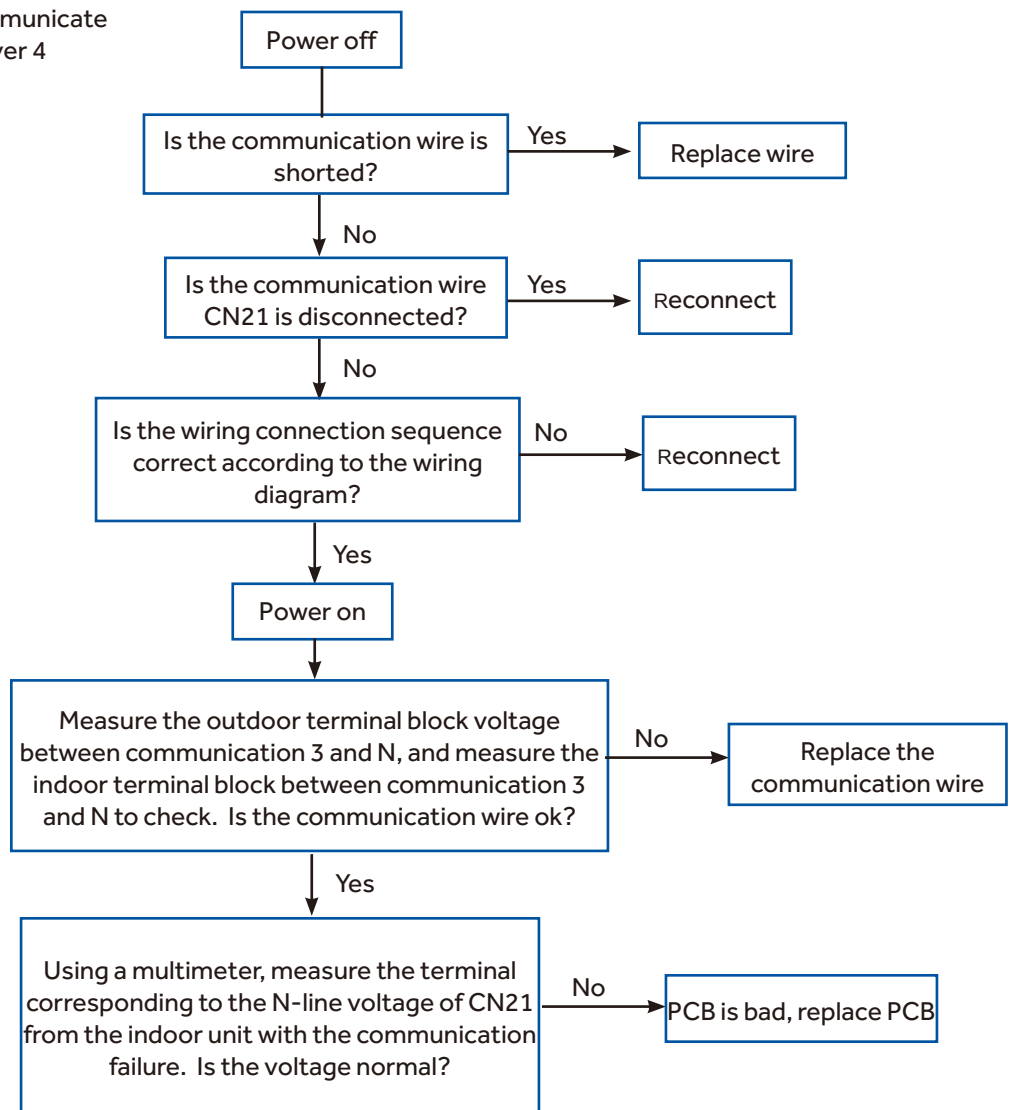

[16] Lack of refrigerant or discharging pipe blocked

Discharge & suction temperature $T_d - T_s \geq 80^\circ\text{C}$ 10 minutes after compressor start. Error status locks if it occurs 3 times in 1 hour.

Possible causes:

- Wrong sensor connection
- Lack of refrigerant
- The sensor is bad
- The 4-way valve is bad
- The electronic expansion valve is bad
- Out of the operating range

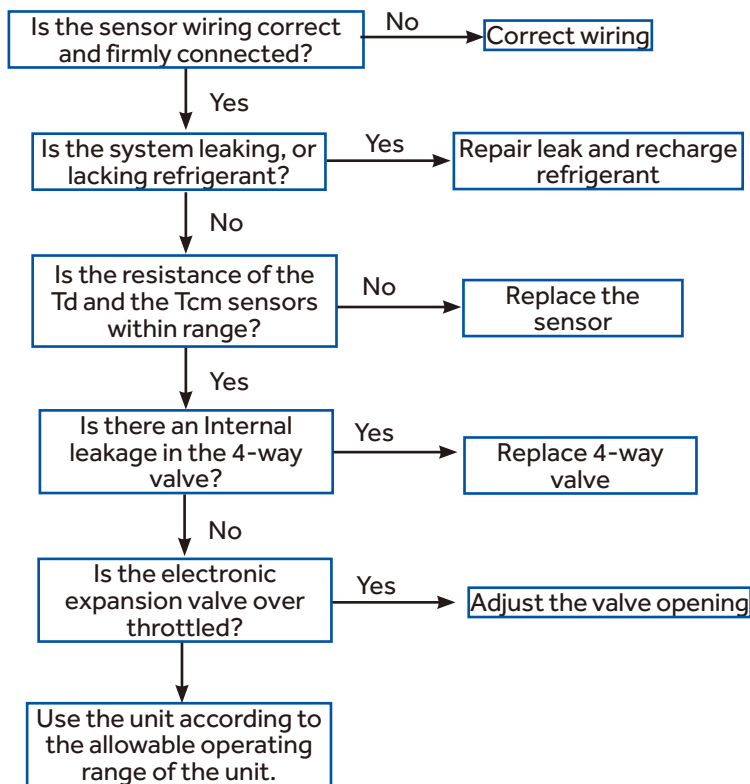

[17] 4-way valve reversing failure

Indoor pipe & indoor ambient temperature $T_m - T_{ai} \geq 5^\circ\text{C}$ 10 minutes after compressor started. Error status locks if it occurs 3 times in 1 hour.

Possible causes:

- The 4-way valve is bad
- The PCB is bad
- The 4-way valve coil connection is bad
- The system pressure difference is too small.

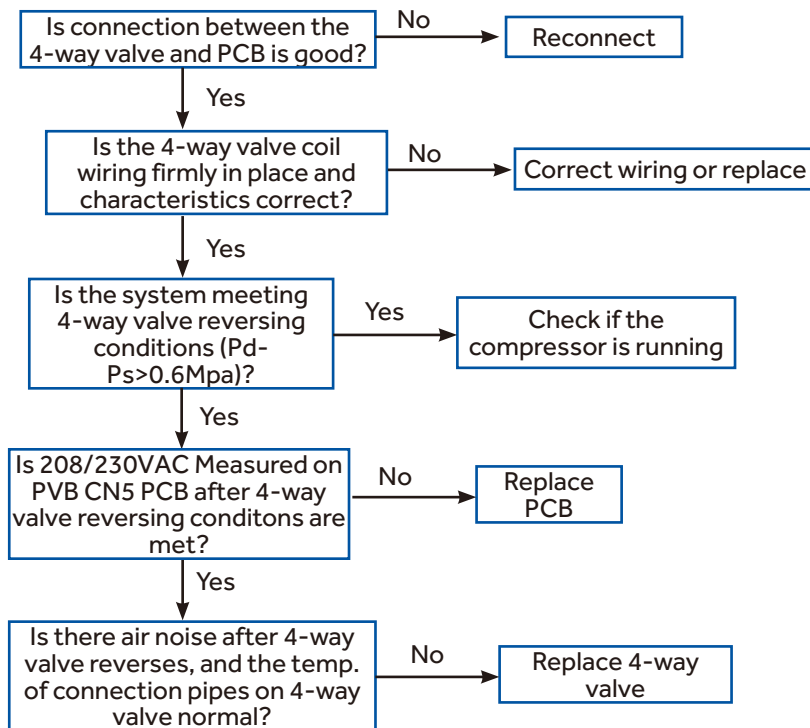

[18] Compressor motor desynchronizing

Motor desynchronizing occurred. Caused by overload, load sharply fluctuating, abnormal compressor current sensor circuit, or one of the inverter gate drive signals is missing.

Possible causes:

- The power supply is abnormal
- Incorrect compressor wiring
- The power module is bad
- The compressor is bad
- The system is overload

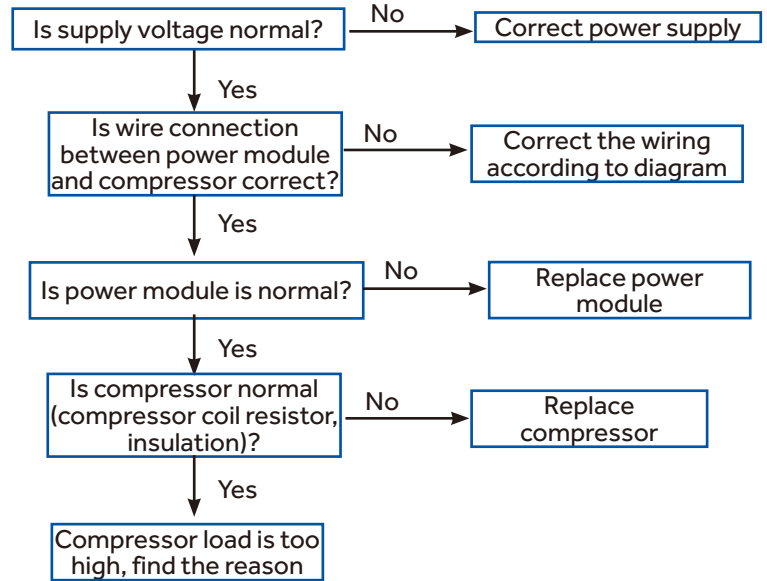

[24] Compressor startup failure

Compressor start failure has been detected by driver module.

Possible causes:

- The power supply is abnormal
- Incorrect compressor wiring
- The power module is bad
- The compressor is bad
- System overload

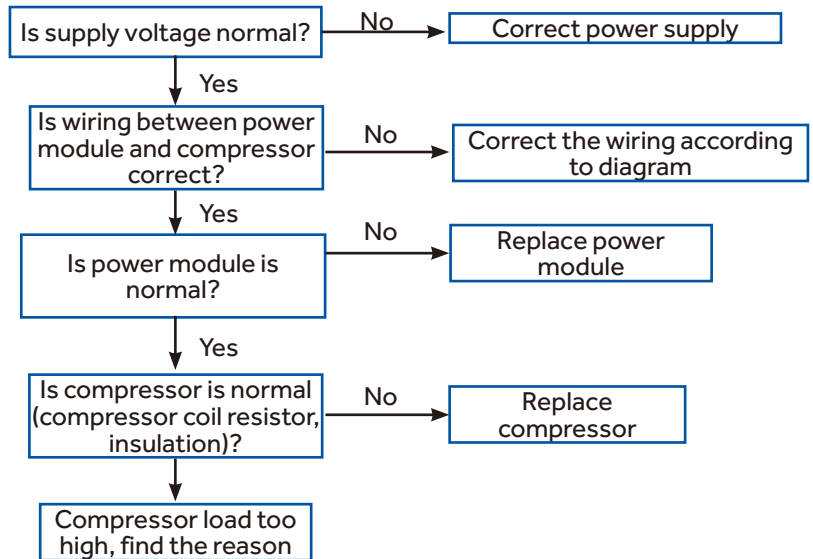

[25] Input overcurrent of the drive module

Compressor drive module input current higher than 32A (double fan model), or 27A (single fan). Locks if it occurs 3 times in 1 hour.

Possible causes:

- Incorrect compressor wiring
- The power module is bad
- The compressor is bad

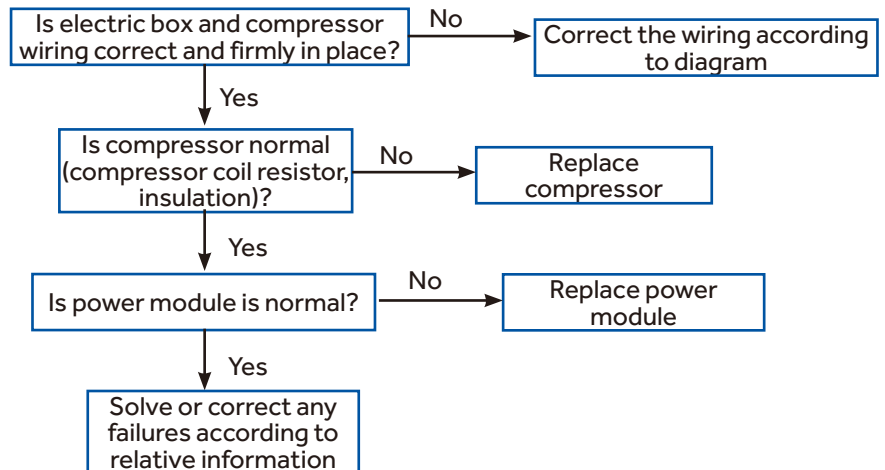

[42] Open high pressure switch

High pressure switch: Switch circuit has been detected open for 30 seconds (after 3 minute of compressor run time). Error locks if it occurs 3 times in 1 hour.

Possible causes:

- Incorrect pressure switch wiring
- Abnormal system pressure
- System is clogged
- Incorrect refrigerant charge
- Bad valve
- Pressure switch is bad
- PCB is bad

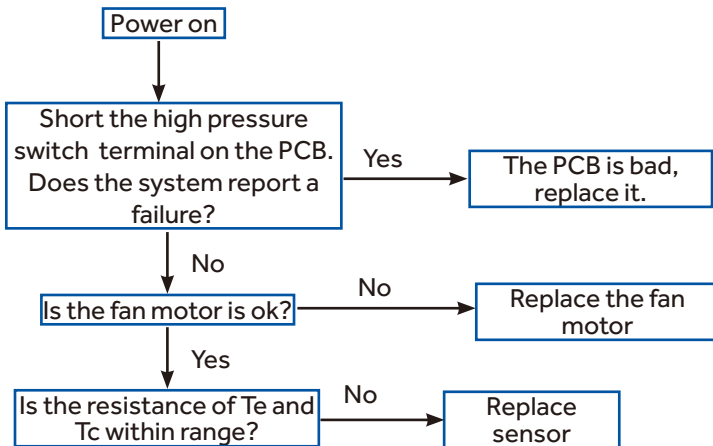

[43] Open low pressure switch

Low pressure switch: Switch has been detected open for 60 seconds (after 3 minute of compressor run time) or open for 30 seconds during standby.

Possible causes:

- Incorrect pressure switch wiring
- Abnormal system pressure
- System is clogged
- Incorrect refrigerant charge
- Bad valve
- Pressure switch is bad
- PCB is bad

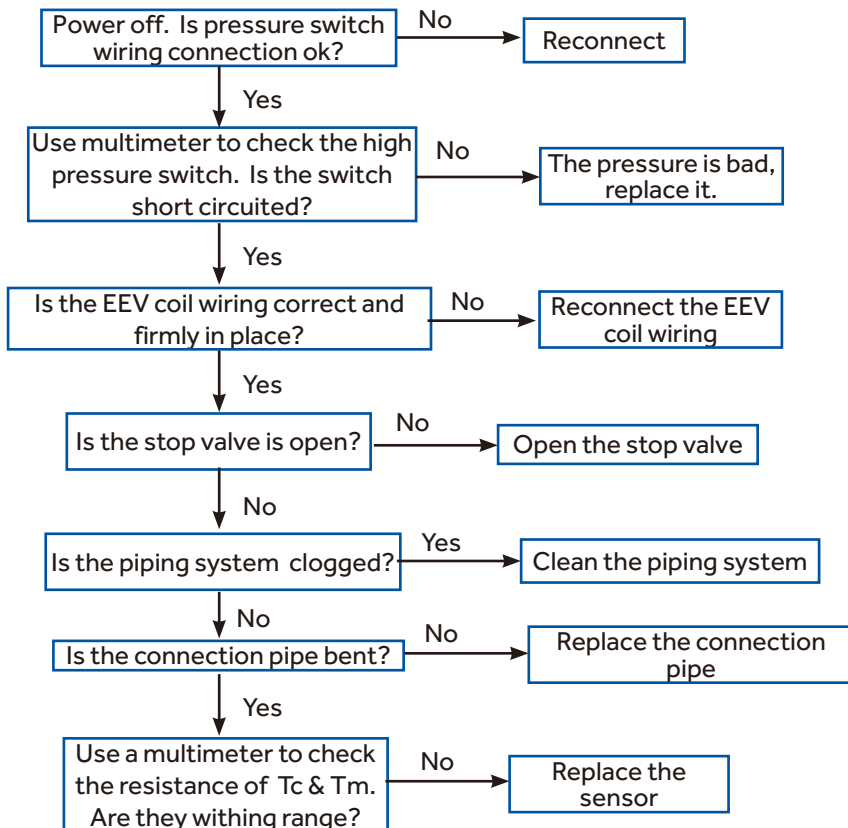

[44] High pressure detected in system

The minimum temperature value of indoor pipe T_m and outdoor T_s is lower than $-45\text{ }^\circ\text{C}$ during cooling mode, or minimum temperature value of outdoor T_c and outdoor T_e is lower than $-45\text{ }^\circ\text{C}$.

Possible causes:

- High pressure sensor detection value is incorrect
- Refrigerant overcharge
- Blocked liquid line piping
- The outdoor unit cannot be turned on normally due to failure to open outdoor heat exchanger electronic expansion valve when heating.
- The operation environment is beyond the allowed range.

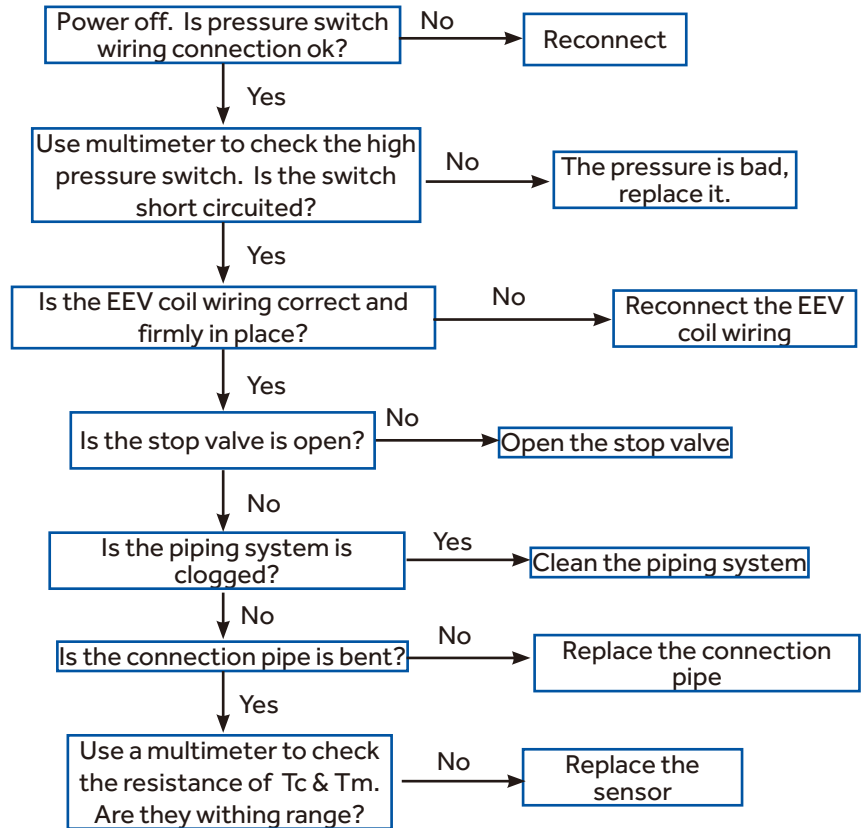

[45] Low pressure detected in system

The minimum temperature value of indoor pipe T_m and outdoor T_s is lower than $-45\text{ }^\circ\text{C}$ during cooling mode, or minimum temperature value of outdoor T_c and outdoor T_e is lower than $-45\text{ }^\circ\text{C}$.

Possible causes:

- Low pressure sensor detection value is incorrect
- Low refrigerant charge
- System air leakage
- Blocked low pressure or liquid line piping
- The outdoor unit cannot be turned on normally due to failure to open outdoor heat exchanger electronic expansion valve when heating.
- The operation environment is beyond the allowed range.

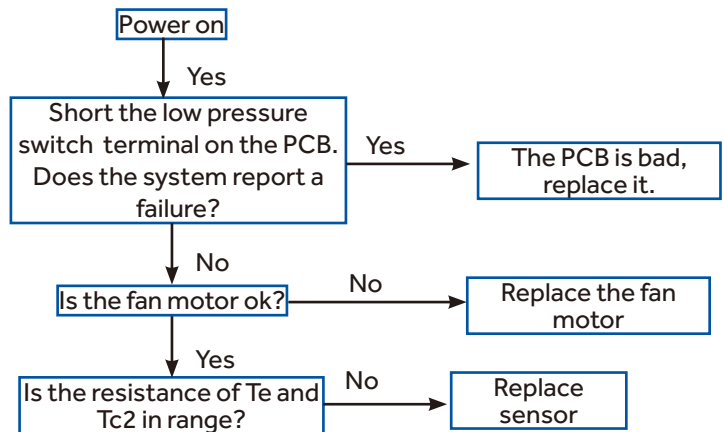

www.haierductless.com