



LANDSCAPE PLAN GUIDE
FOR DEVELOPMENTS IN
CAMPASPE SHIRE COUNCIL
CITY OF GREATER SHEPPARTON AND
MOIRA SHIRE COUNCIL



FINAL

Inspiring people and places

This Landscape Plan Guide was prepared by Spiire Australia

© May 16, 2017 9:25 AM Spiire Australia



The information contained in this document is intended solely for the use of the client named for the purpose for which it has been prepared and no representation is made or is to be implied as being made to any third party. Other than for the exclusive use of the named client, no part of this report may be reproduced, stored in a retrieval system or transmitted in any form or by any means, electronic, mechanical, photocopying or otherwise, without the prior written permission of Spiire.

Landscape Plan Guide

| STATUS | DATE | COMPILED BY | AUTHORISED |
|------------------------------------------------|------------|-------------|------------|
| Preliminary Draft provided to GSCC | 28/06/2016 | SE | SE |
| Final Draft v1 | 13/09/2016 | SE | SE |
| Final Draft v2 | 10/10/2016 | SE | SE |
| Final Draft v3 | 14/12/2016 | SE | SE |
| Final Draft v4 | 23/12/2016 | SE | SE/JM |
| Final Draft v5 | 10/01/2017 | SE | SE/JM |
| Final Draft v6 | 31/01/2017 | SE | SE/JM |
| Final | 12/04/2017 | SE | SE/JM |
| Final (incorporating feedback from DRAFT) | 25/04/2017 | SE | SE/JM |
| Final (incorporating more feedback from DRAFT) | 16/05/2017 | SE | SE/JM |

CONTENTS

SECTION 1

- | | | |
|----|-----------------------------------------|---|
| 1. | INTRODUCTION | 4 |
| 2. | PURPOSE OF THE LANDSCAPE GUIDE | 5 |
| 3. | GENERAL LANDSCAPE DESIGN CONSIDERATIONS | 6 |
| 4. | LANDSCAPE PLAN APPROVALS PROCESS | 7 |

SECTION 2

- | | | |
|----|--------------------------------|----|
| 5. | URBAN RESIDENTIAL DEVELOPMENTS | 12 |
|----|--------------------------------|----|

SECTION 3

- | | | |
|----|--------------------|----|
| 6. | RURAL DEVELOPMENTS | 36 |
|----|--------------------|----|

SECTION 4

- | | | |
|----|-------------------------|----|
| 7. | COMMERCIAL DEVELOPMENTS | 50 |
|----|-------------------------|----|

SECTION 5

- | | | |
|----|-------------------------|----|
| 8. | INDUSTRIAL DEVELOPMENTS | 66 |
|----|-------------------------|----|

SECTION 6

- | | | |
|----|---------------------------------------------------|----|
| 9. | DESIGN AND APPROVALS PROCESS FOR COUNCIL PROJECTS | 80 |
|----|---------------------------------------------------|----|

SECTION 7

- | | | |
|-----|----------------------------|-----|
| 10. | BIOREGIONS | 86 |
| 11. | RECOMMENDED PLANTING LISTS | 87 |
| 12. | PLANT SPECIES LISTS | 100 |
| 13. | ENVIRONMENTAL WEEDS | 112 |

SECTION 8

- | | | |
|-----|------------------------------------------------|-----|
| 14. | LANDSCAPE STANDARDS – MATERIALS AND TECHNIQUES | 116 |
|-----|------------------------------------------------|-----|

SECTION 9

- | | | |
|-----|------------------------------------|-----|
| 15. | NURSERIES | 132 |
| 16. | FURTHER INFORMATION AND REFERENCES | 133 |
| 17. | LOCAL GOVERNMENT AREAS | 134 |

SECTION 10

- | | | |
|-----|------------|-----|
| 18. | CHECKLISTS | 138 |
|-----|------------|-----|

APPENDICES

APPENDIX 1 LANDSCAPE PLAN TEMPLATE
EXAMPLE LEGENDS

APPENDIX 2 CITY OF GREATER SHEPPARTON DEVELOPER GUIDELINES

APPENDIX 3 SUBMISSIONS ON DRAFT LANDSCAPE PLAN GUIDE

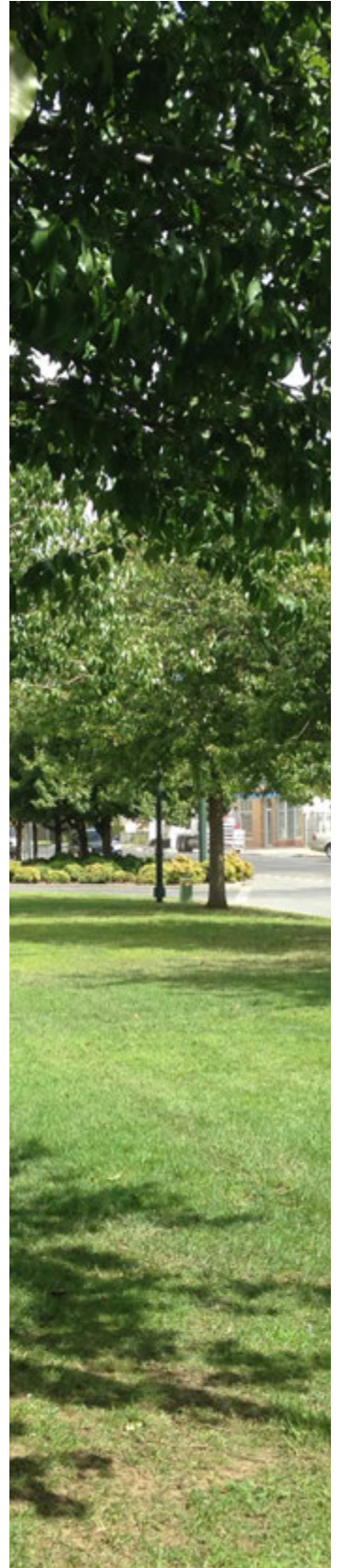

EXECUTIVE SUMMARY

On behalf of Greater Shepparton City Council, Moria Shire Council, Campaspe Shire Council and the Goulburn Broken Catchment Management Authority, welcome to the Landscape Plan Guide for residential, rural, commercial and industrial developments in the Local Government Areas.

This guide has been prepared in partnership by the above Councils and Catchment Management Authority to develop consistent standards for the preparation of landscape plans, implementation of landscape works and on going maintenance for new developments.

The purpose of the Landscape Plan Guide is to ensure Councils have appropriate consideration of and input into landscape developments within the Local Government Areas.

The Guide provides an outline for residential, rural, commercial and industrial developments Approvals Process and Requirements, Landscape Design Considerations, Landscape Plan requirements, general Materials and Techniques and Plant Species required in landscape developments.

The use of this Guide and subsequent approvals and implementation of approved landscape developments will ensure sustainable landscapes that contribute positively to our local environments.

Mark Henderson
Moria Shire

Chief Executive Officer

Jason Russell
Campaspe Shire Council

Chief Executive Officer

Peter Harriott
Greater Shepparton City Council

Chief Executive Officer

Chris Norman
*Goulburn Broken Catchment
Management Authority*

Chief Executive Officer



SECTION 1 INTRODUCTION

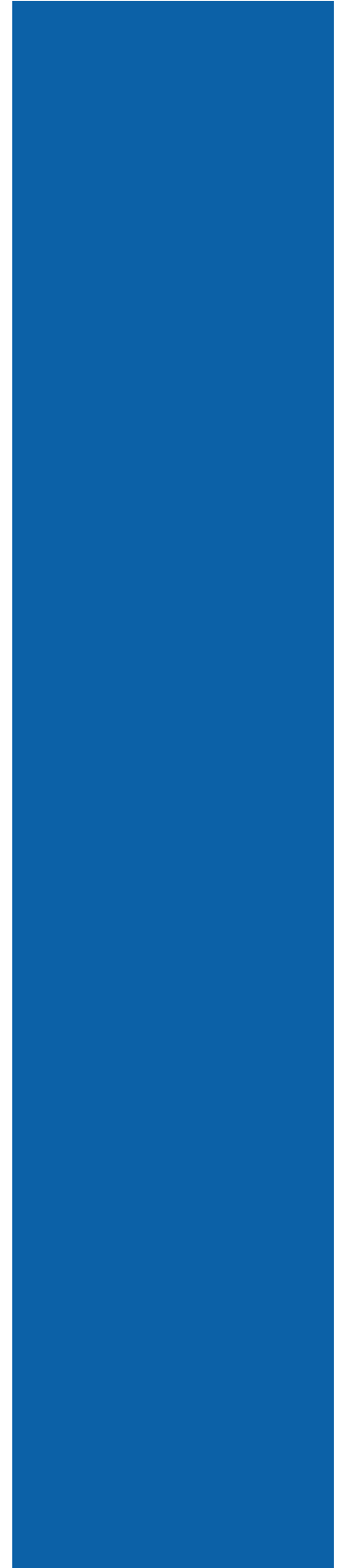

1. INTRODUCTION

This Landscape Plan Guide applies to residential, rural, commercial and industrial developments in the City of Greater Shepparton, Moira Shire and the Shire of Campaspe.

The landscape settings of these municipalities has a unique set of diverse environmental and climatic conditions. These conditions require appropriate landscape design responses in the design and construction of new developments.

The preparation of this guide has been a collaborative process facilitated through the Goulburn Broken Catchment Management Authority (GBCMA) partnerships with each of the Councils working to improve and protect the Catchment's land, water and biodiversity.

This Landscape Plan Guide establishes common requirements for sustainable and appropriate landscape developments across the municipalities. The Guide will also assist developers and Councils in landscape plan requirements that meet Council expectations.

It is recommended that this Guide become a reference document in each of the Council's Planning Schemes.

Extensive planting lists are provided within this Guide to encourage the use of native plants suited to the conditions of the municipalities. A variety of native plants are very suitable for use in gardens and open spaces. The species lists also outline a selection of indigenous plants found in the region. Indigenous plants are those that occur naturally in the local area. The specifying of native plants aims to develop an appreciation and understanding of natural biodiversity in the region and how they can be used within developments.

It is recommended that this Landscape Plan Guide is made available to anyone considering landscape developments, particularly developers and planning permit applicants early in the planning process to enable understanding of landscape plan requirements that are in line with the agreed standard across the Campaspe, Greater Shepparton and Moira municipalities.

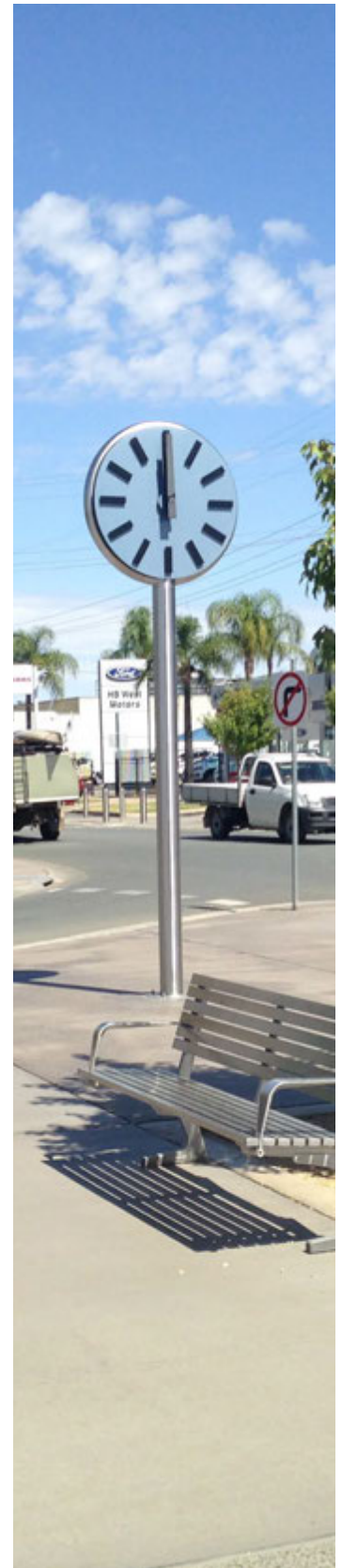

2. PURPOSE OF THE LANDSCAPE GUIDE

All new developments are required to submit a landscape plan for Council approval as part of a planning permit application or to meet Conditions of a planning permit.

This guide is a resource that:

- ▶ Provides the Greater Shepparton City Council, Campaspe Shire Council and Moira Shire Council with the appropriate consideration of and input into landscape developments.
- ▶ Establishes a clear and concise framework for the preparation of landscape plans.
- ▶ Provides a clear process for the approval of landscape works both by external parties and Council.
- ▶ Assists planning permit applicants and also applicants who have received a permit to efficiently and effectively submit the required characteristics of a landscape plan.
- ▶ Ensures the landscape is considered as part of engineering approvals and is in line with the Infrastructure Design Manual (IDM).
- ▶ Ensures applications address numerous aspects of landscape requirements that are relevant to the development.
- ▶ Ensures the visual and environmental quality of the landscape and neighbourhood character is not adversely affected by inappropriate landscaping.
- ▶ Assists applicants prepare informed and sustainable landscape designs.
- ▶ Outlines key landscape design considerations in order to achieve appropriate and quality landscape outcomes for new developments.
- ▶ Provides a comprehensive list of plant species which are appropriate to the environmental and climatic conditions of the municipalities.
- ▶ Acknowledges the use of and benefits from planting indigenous species, including:
 - ▶ Adaptation to the local climate, soil type and tolerance of drought and frost.
 - ▶ Attract native fauna to the garden by providing a source of food and shelter.
 - ▶ Local plants do not 'escape' from gardens to become environmental weeds.
 - ▶ Require less water and fertiliser than many exotic species. Reducing water and fertiliser application reduces salinity and limits the amount of nutrients entering natural waterways.
 - ▶ Contribute to wildlife corridors that enable wildlife to move from one forest area to another.
 - ▶ By planting native plants in your garden you will assist in the preservation of the natural landscape and enhance natural biodiversity.
- ▶ Outlines the maintenance requirements and handover obligations for newly constructed landscape works.
- ▶ Identifies other Council documents relevant to the design and development of landscape.

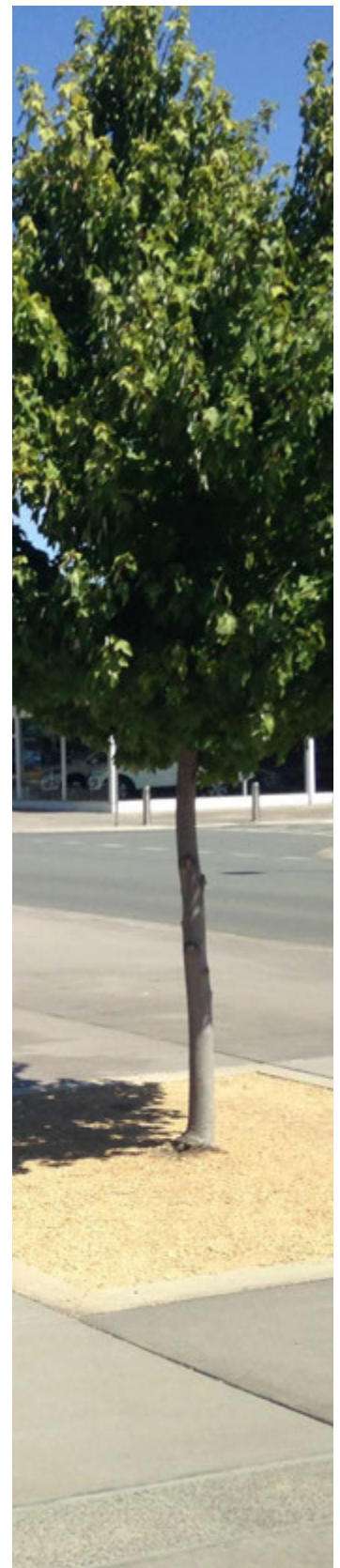

3. GENERAL LANDSCAPE DESIGN CONSIDERATIONS

The following design considerations are to be addressed in any landscape proposal.

Landscape Character

- ▶ Promote designed landscapes as part of a fully integrated approach to site development within residential, commercial and industrial areas.
- ▶ Retain and protect quality existing vegetation, particularly large and medium trees, to conserve significant natural features of the site and provide habitat. An arborist assessment may be required to confirm suitability for tree retention.
- ▶ Landscape proposals shall respond to existing site conditions, local character and ensure that the landscape outcomes create and enhance community environments.
- ▶ Ensure the landscape adequately complements the proposed built forms and minimises the impacts of scale, mass and bulk of the development on the existing area and surrounding streetscapes, view lines and neighbourhood amenity.
- ▶ Promote the use of native and indigenous plant materials that are suitable to and reflect the local character.
- ▶ Enhance and define areas and frame views from and into the landscape site.
- ▶ Ensure the landscape proposal meets current and future use requirements.
- ▶ Encourage landscape that can be effectively maintained to a high standard for the life of the development.

Environmental Sustainability

- ▶ Ensure quality, sustainable landscapes that make a positive contribution to the liveability of communities.
- ▶ Promote the use of and benefits from planting indigenous species, including:
 - ▶ Adaptation to the local climate, soil type and tolerance of drought and frost.
 - ▶ Attract native fauna to the garden by providing a source of food and shelter.
 - ▶ Requirements for less water and fertiliser than many exotic species. Reducing water and fertiliser application limits the amount of nutrients entering natural waterways.
 - ▶ Contribute to wildlife corridors that enable wildlife to move from one forest area to another.
 - ▶ Assisting in the preservation of the natural landscape and enhance natural biodiversity.
 - ▶ Reducing environmental weeds in the landscape.
- ▶ Incorporate best practice Water Sensitive Urban Design.
- ▶ Use appropriate species that enhance biodiversity and minimise pests and disease, such as fruit fly, exotic birds and human health.
- ▶ Protect and enhance native vegetation, wetlands and waterways.



4. LANDSCAPE PLAN APPROVALS PROCESS

Landscape proposals are subject to a Council approval process prior to any construction being undertaken. This applies to external private developments and internal Council landscape projects.

Council requires that Landscape plans are required as part of the Planning Permit application or through secondary consent as part of Conditions on the Planning Permit.

The type of the development proposal will determine whether a simple or complex approvals process will be undertaken. A pre-application discussion with all relevant Council departments will assist in the determination of the approvals and approvals process required. For example a simple landscape proposal may be limited to planting in terms of species selection, distribution and layout, while complex landscape proposal may include integrated landscape and engineering outcomes. Relevant Council departments to be consulted may include sustainability and environment, engineering, assets and parks teams.

Landscape plans for complex landscape proposals must be prepared by a Council accredited landscape architect or landscape consultant. Landscape plans for small or less complex developments may be prepared by landscape designers or horticulturists. Mid range to larger complex developments which require landscape plans must be prepared by registered landscape architects.

The following flow charts outline the general landscape plan approvals processes that are undertaken by the Campaspe Shire Council, Moira Shire and Greater Shepparton City Council.

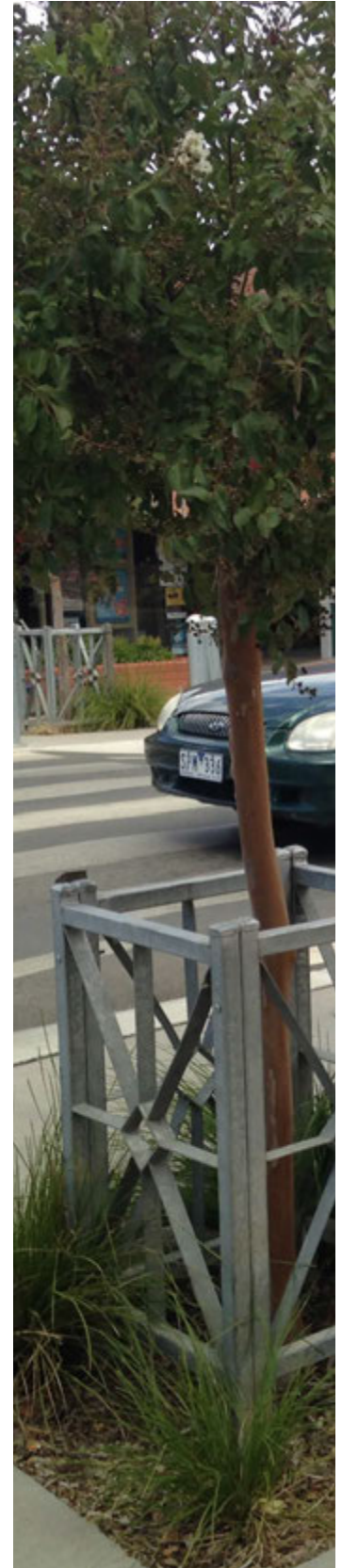

4.1 Campaspe Shire Council approvals process

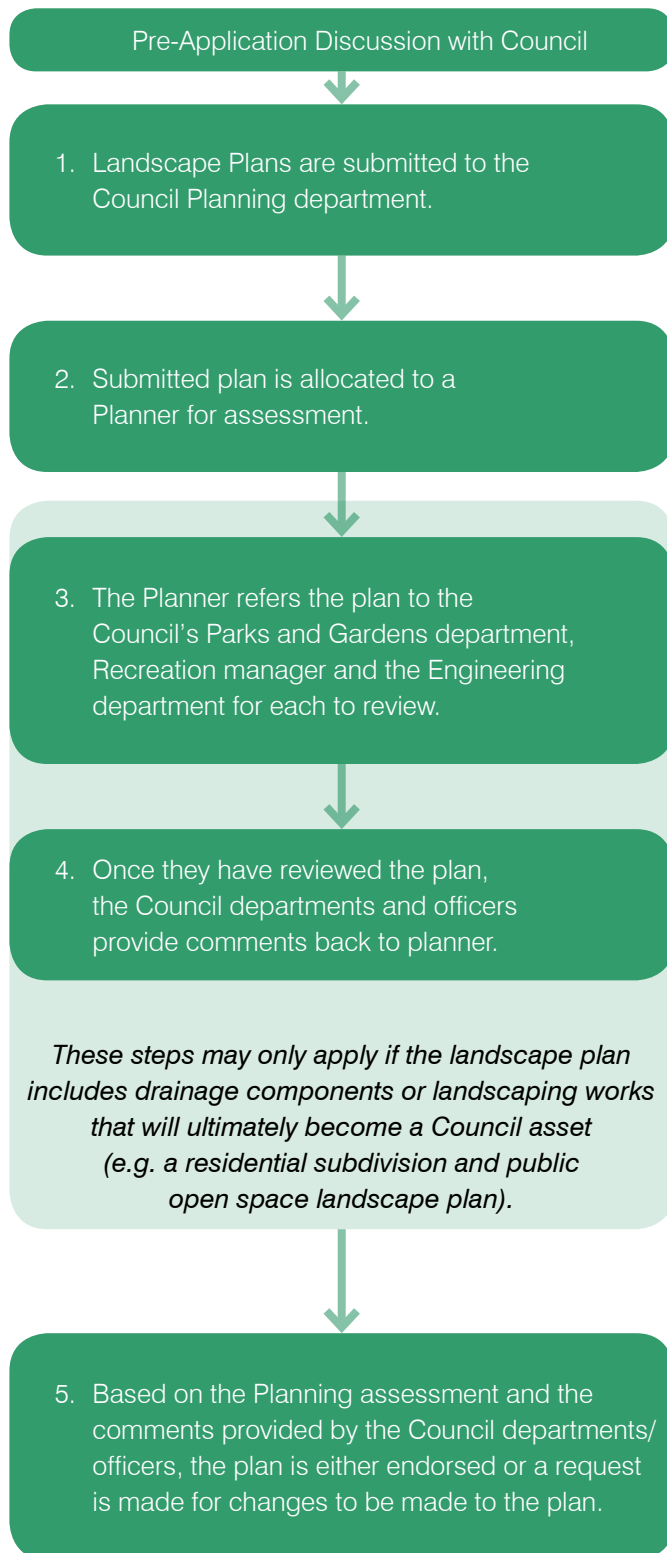

4.2 Moira Shire Council approvals process

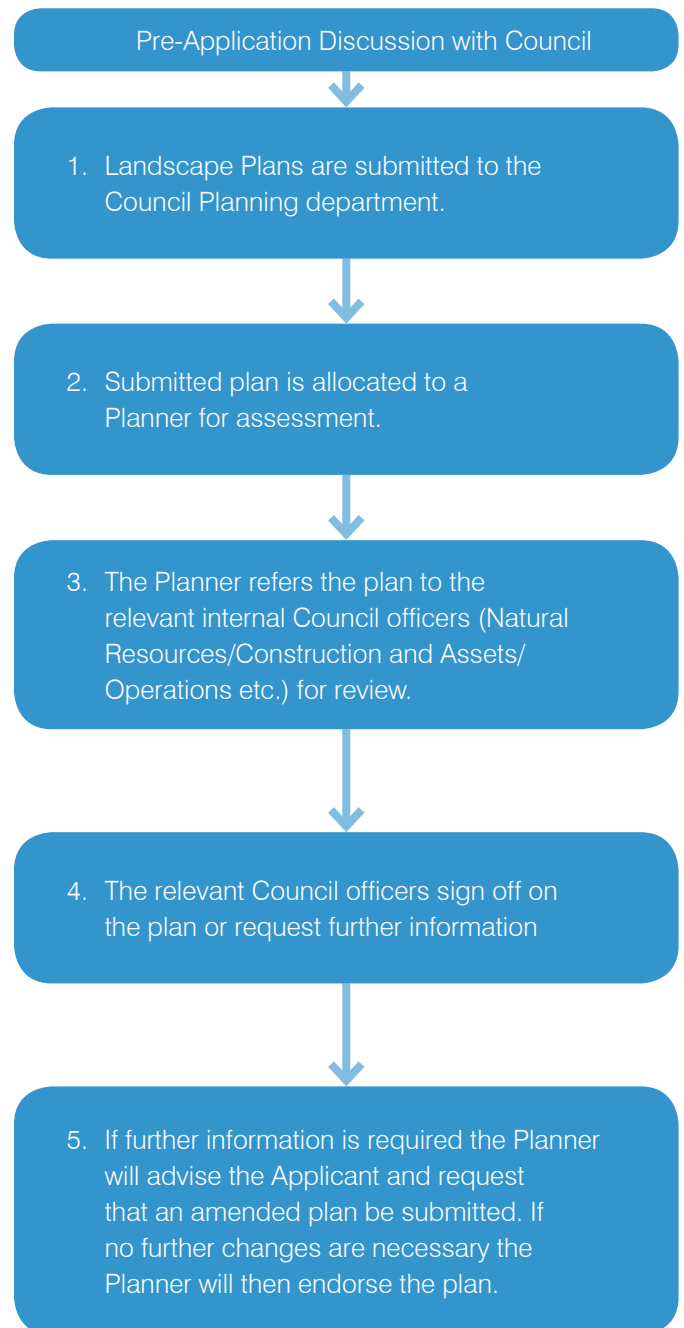

4.3 Greater Shepparton City Council approvals process

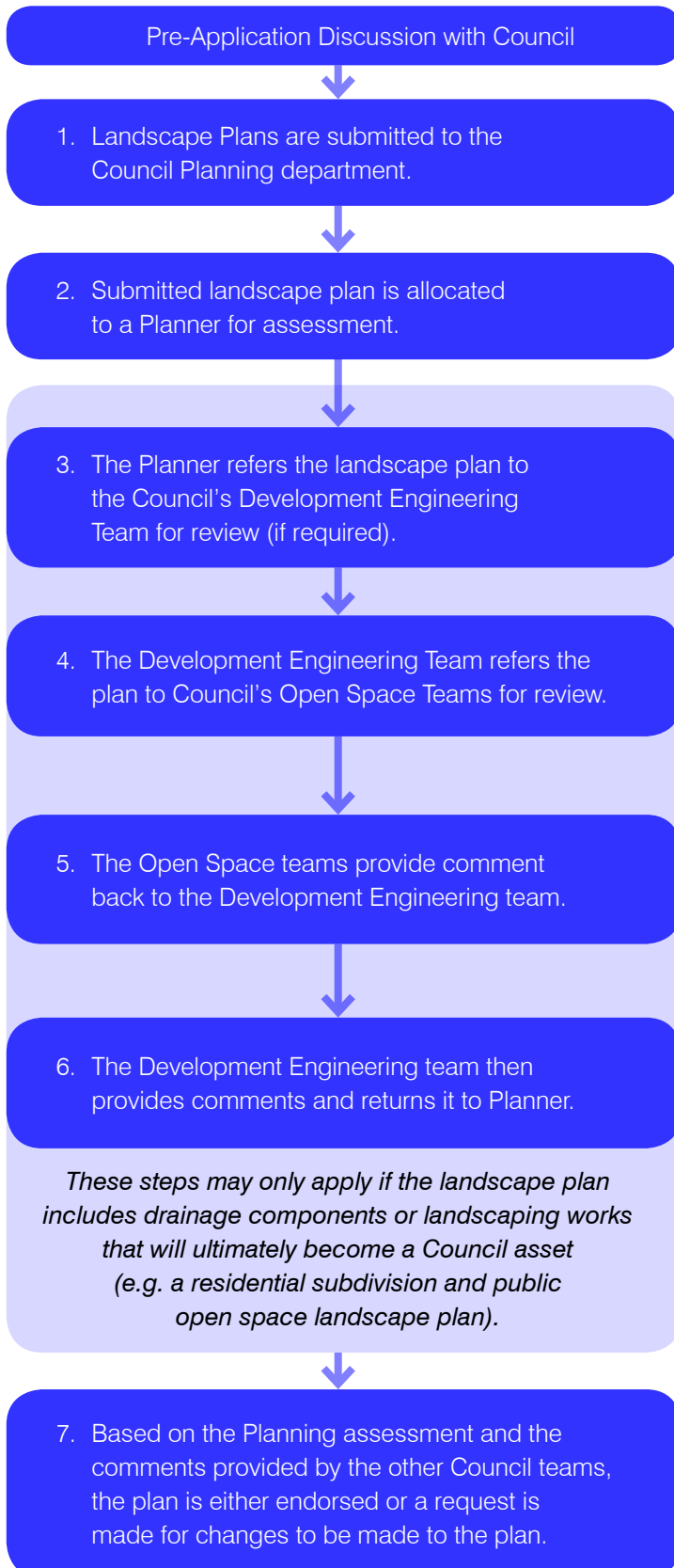



SECTION 2 URBAN RESIDENTIAL DEVELOPMENTS

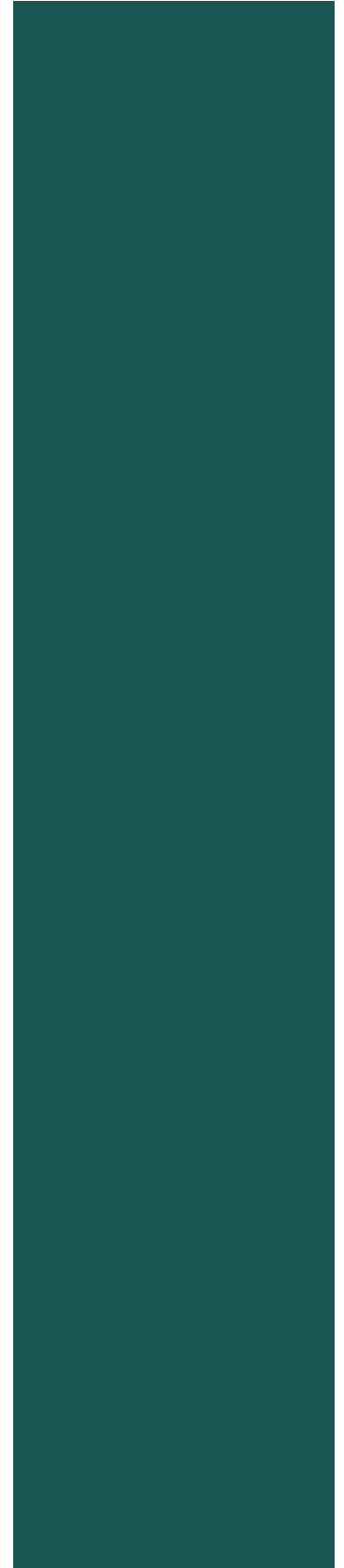

5. URBAN RESIDENTIAL DEVELOPMENTS

5.1 Design Considerations

Some factors to consider in the preparation of a landscape plan for urban residential developments are outlined below.

PRIVATE OPEN SPACE

- ▶ Streetscape frontage that enhances the street aesthetic through garden bed and tree planting, paving, grass areas, edging and so on.

STREETSCAPES – STREET TREES

“The right tree in the right location”

- ▶ Species variety to complement/create local character, ensure resilience and longevity, and provide habitat.
- ▶ Canopy cover – achieve maximum canopy cover that is appropriate to the site location. Full mature tree canopy size to be shown and as percentage of public land.
- ▶ Consistency – achieve consistency in themes/character and regular planting intervals.
- ▶ Services – prioritise tree locations over services to achieve maximum canopy cover and regular planting intervals, while ensuring required clearances to existing and proposed services.
- ▶ Tree planting details – stakes and ties, tree planting cells, root barriers.
- ▶ Sight lines – maintain sight lines at driveways and cross streets.

STREETSCAPES – NATURE STRIPS

- ▶ Grassing – turf or seeding.
- ▶ Other treatments (subject to Council consent) such as permeable paving, granitic gravel, groundcover planting or mulch only.

STREETSCAPES – TRAFFIC ISLANDS / ROUNDABOUTS

- ▶ Surface finishes – planted garden beds, paved (continuous or unit hard paving, permeable paving, granitic gravel), or combination of planting and paving. Minimise large expanses of continuous hard paving.
- ▶ Planting – trees, garden beds, species selection appropriate for streetscapes.
- ▶ Safety – traffic and pedestrian safety, sight lines, safety of maintenance crews.
- ▶ Maintenance – ongoing maintenance obligations to minimise high maintenance.

PUBLIC OPEN SPACE

Parks and reserves, recreation precincts, waterways and wetlands, urban squares.

General

- ▶ Open areas and activity areas for a range of passive and active recreation opportunities suitable for local, neighbourhood or regional parks.
- ▶ Comply with Infrastructure Design Manual (IDM) Clause 24 Landscaping and Public Open Space.
- ▶ Comply with Federal Disability Discrimination Act 1992 (DDA).



Centre median planting

- ▶ Comply with Crime Prevention Through Environmental Design (CPTED) guidelines.
- ▶ Comply with Supportive Environments for Physical Activity (SEPA) guidelines, now also Active by Design and Healthy Design.
- ▶ Ensure general compliance with the Parks and Leisure Australia Open Space Planning and Design Guide.
- ▶ Integration of activity areas, play spaces and connecting pathways to ensure unified outcomes.
- ▶ Integration of high quality landscape outcomes with engineering infrastructure.
- ▶ Interface treatments – screen/buffer planting.
- ▶ Connectivity – pedestrian desire lines, pathway connections to adjacent path networks, road crossings.
- ▶ Surface treatments – paving (permeable, continuous or unit hard surface), grassing (turf, seeding, species, edging).
- ▶ Sustainability – durability and longevity of materials and finishes to reduce maintenance obligations, and the use of recyclable materials where possible
- ▶ Heritage – preservation and integration of heritage elements.
- ▶ Remnant vegetation – retention of existing high quality vegetation for amenity or habitat value.
- ▶ Public Art – purpose, scale, form, materials and compliance with relevant policies.
- ▶ Maintenance – layout, accessibility, on-going life cycle.

Tree Planting

- ▶ Species variety to complement/create local character, ensure appropriate scale, resilience and longevity, provide habitat for native fauna.
- ▶ Appropriate installation size and planting details.
- ▶ Structure – use tree planting to enhance landscape character and spatial arrangements.
- ▶ Canopy cover – achieve maximum canopy cover using appropriate species adjacent pathways, activity areas, play spaces and grassed areas.

Garden Beds

- ▶ Appropriate size and location for visual effect and ease of maintenance.
- ▶ Edge treatments.
- ▶ Soils and mulch requirements.
- ▶ Species selection for drought tolerance, suitability to site, habitat, purpose (screening, ornamental, personal safety). Encourage use of native/indigenous species for the biodiversity benefits they provide.
- ▶ Layout of species for variety, visual impact and cohesive themes.
- ▶ Irrigation.

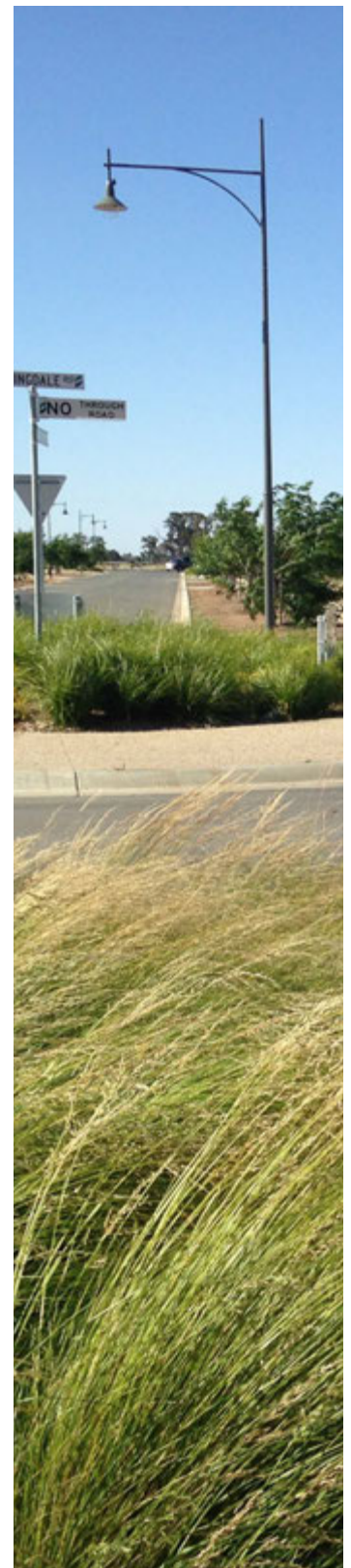

Streetscape and roundabout planting

Play Spaces

- ▶ Passive surveillance from surrounding land uses.
- ▶ Provide shade through tree planting or approved shade structures.
- ▶ Provide a range of play opportunities for a variety of age groups including structured, unstructured and nature based play.
- ▶ Ensure compliance to relevant Australian Standards and Council Play Space Strategies.
- ▶ Ensure play equipment meets Australian Standards.
- ▶ Certification of play space design and installation.
- ▶ Surface finishes – organic soft fall, rubber soft fall (high impact areas).
- ▶ Edging treatments – materials and locations, considering natural elements as edge treatments.
- ▶ Natural play elements – logs, rocks, timber rounds, sand, water.
- ▶ Drainage and connections to stormwater.
- ▶ Ongoing management and maintenance.

Activity Areas

- ▶ Passive surveillance from surrounding land uses.
- ▶ Furniture and amenity elements – shelters, barbecues, seating, picnic settings, waste receptacles, drinking fountains and other furniture.
- ▶ Lighting – locations, fittings, energy saving materials.

Grass Areas

- ▶ Open grass areas for passive and active recreation.
- ▶ Mounding.
- ▶ Turf areas and seeding, using species appropriate for use.
- ▶ Soil preparation for appropriate use.
- ▶ Edge treatments and interfaces.
- ▶ Irrigation.
- ▶ Drainage.

Stormwater, Floodways and Wetlands

- ▶ Integration of high quality landscape outcomes with engineering requirements.
- ▶ Swales – locations, planting/grass treatments, crossing points.
- ▶ Infrastructure – locations and visual appeal of headwalls, pits, culverts and so on.
- ▶ Slopes, banks and batters – grades and treatments.
- ▶ Planting – species selections (local indigenous species for terrestrial and aquatic vegetation), establishment.
- ▶ Amenity – seating, visual and physical access.
- ▶ Maintenance obligations – accessibility, dewatering for system health.



Other

- ▶ Infrastructure – irrigation controllers/valve boxes, water supply, pit locations, substation locations.

MAINTENANCE

- ▶ Maintenance obligations that meet Council requirements for all elements of the landscape.

Refer to Section 11 Recommended Plant Lists and Section 15 Materials and Techniques for further information on plant species, design and specification of landscape works.

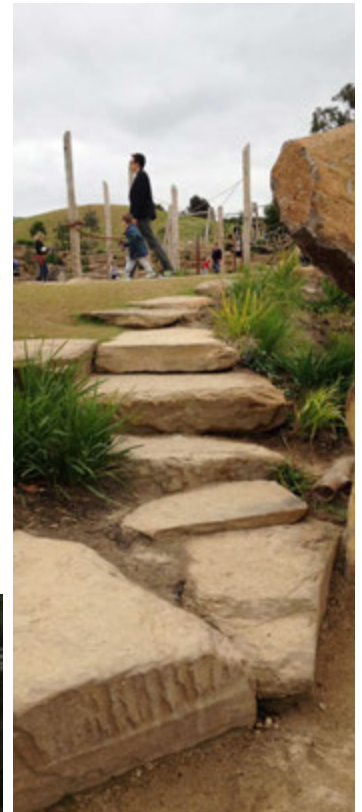

Natural materials in play spaces



Natural materials in play spaces



Good nature strip treatments

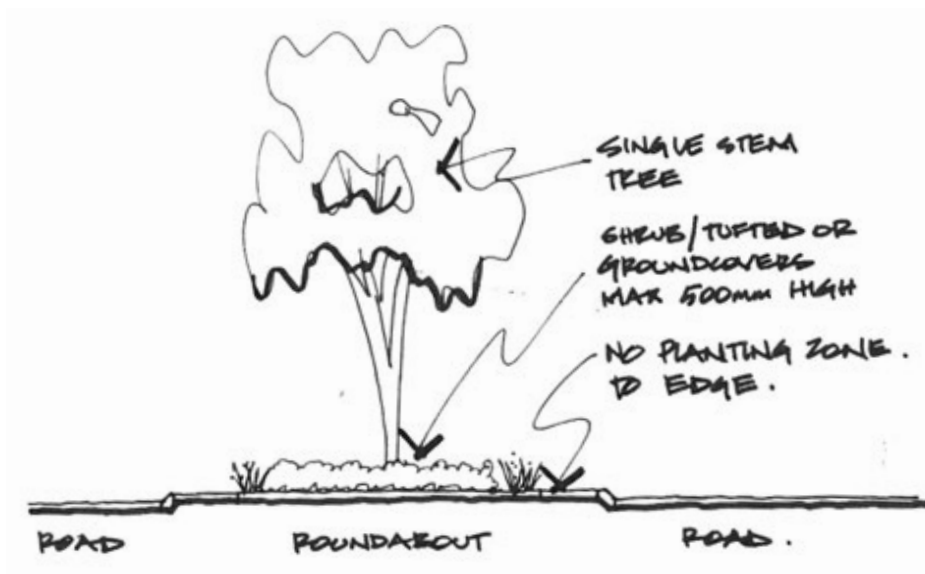

Roundabout with central planting sketch. Shrub and groundcover planting to be max. 500mm high.

MEDIUM DENSITY DEVELOPMENTS

- ▶ Streetscape frontage (garden bed treatments, private realm and street tree planting, fencing, service locations).
- ▶ One medium to large tree to front yard.
- ▶ Boundary planting of trees and hedging/screening plants (along driveways, interfaces with adjoining land uses).
- ▶ Access (pedestrian paths, vehicle crossings/ driveways, resident/visitor parking areas).
- ▶ Private open space (front/rear courtyards including grass, garden beds, paving and tree planting, drainage).

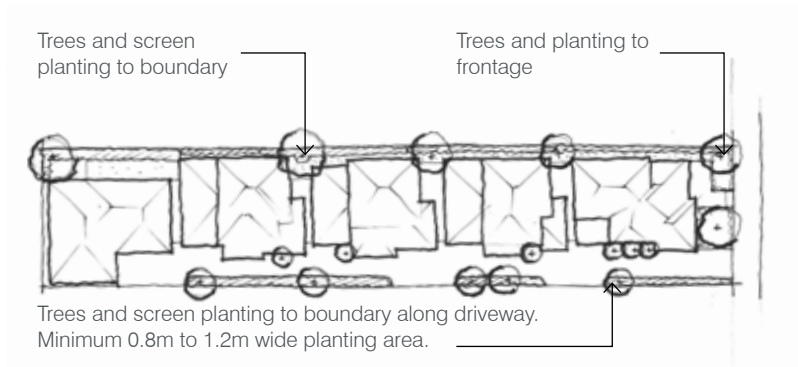

Sketch of medium density boundary planting

Trees and screen planting to boundary along driveway.
Minimum 0.8m to 1.2m wide planting area.

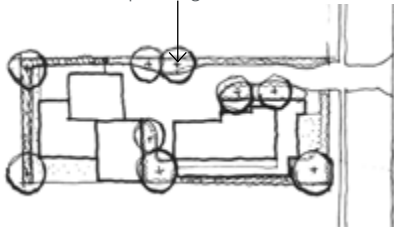

Sketch of medium density boundary planting

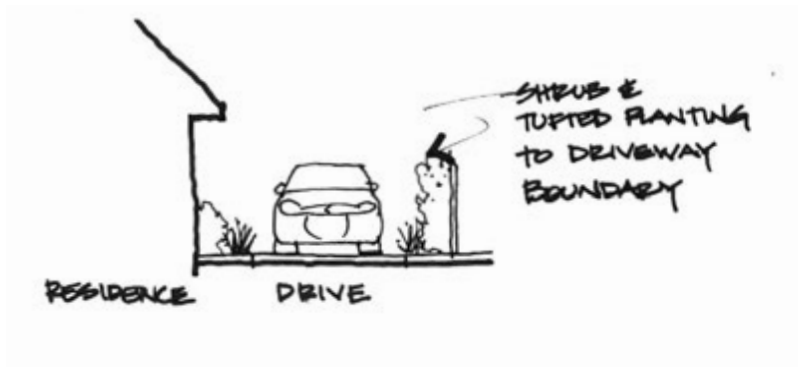

Sketch of medium density boundary planting along driveway

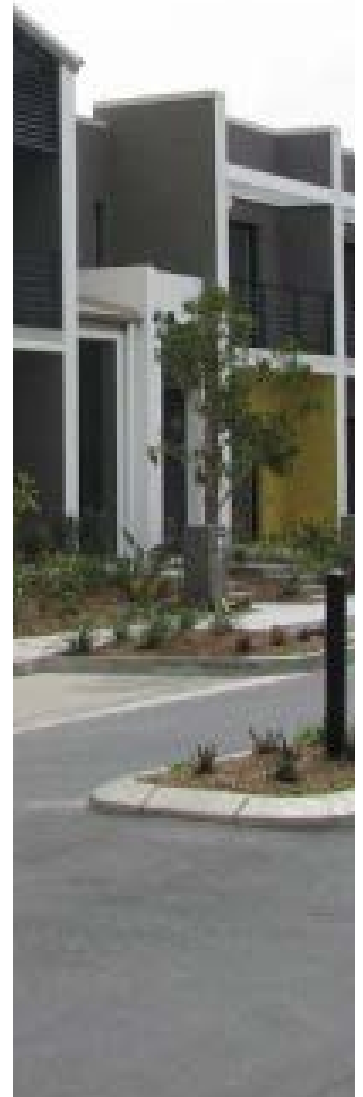

Medium density streetscape interface landscape treatments

5.2 Approvals Process

The following outlines the preferred approval process for complex landscape proposals, such as urban residential developments. These generally include landscapes (streets and open space) which will become Council assets. It is important that a thorough landscape design and installation process is undertaken to ensure high quality and integrated outcomes.

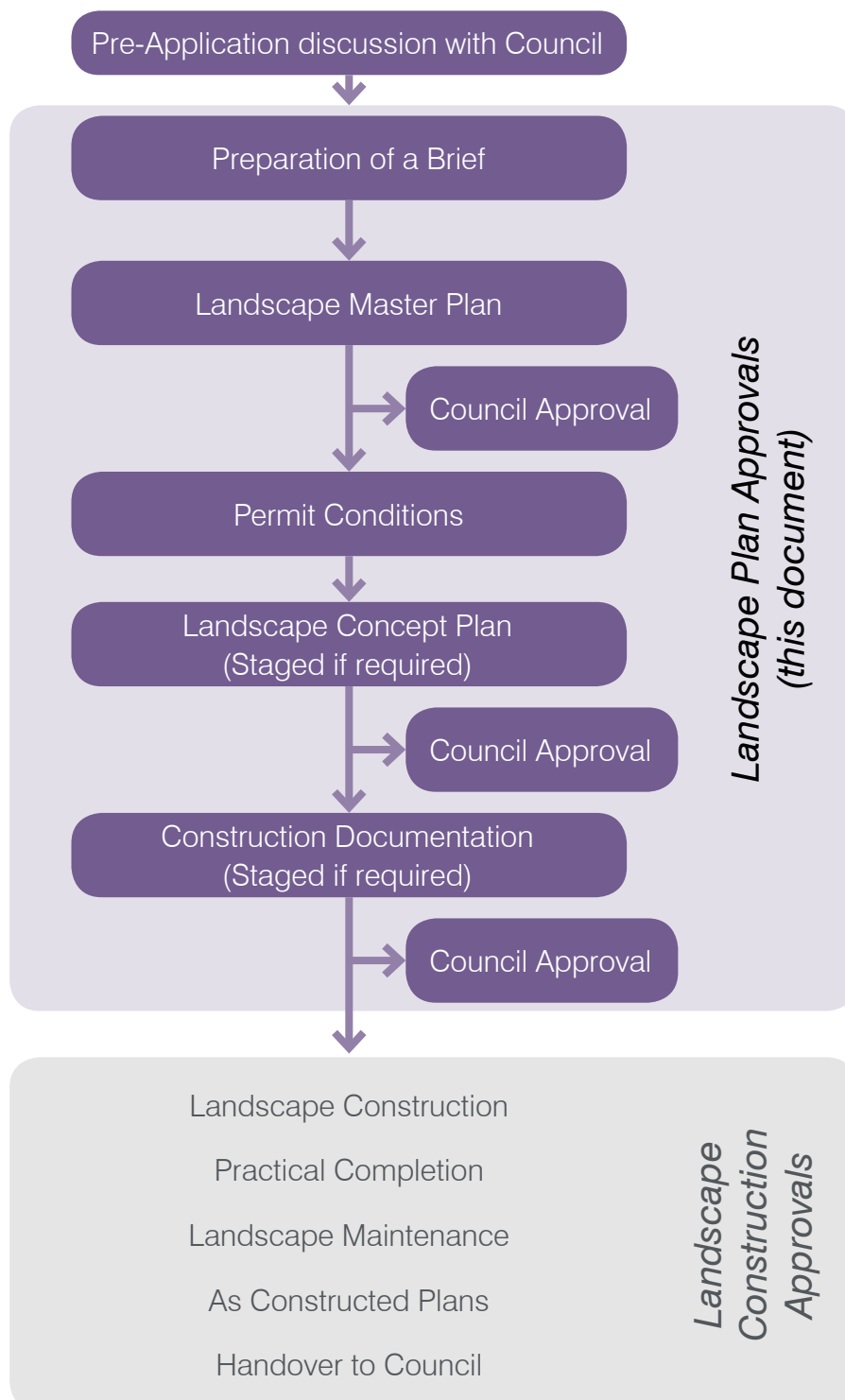

5.3 Landscape Plan Approvals process for landscape works that will become Council assets

In some cases, landscape works that will be handed over to Council for ongoing management and maintenance will generally follow the following process.

PREPARATION OF A BRIEF

Design requirements to be met in the proposed landscape works must be considered early in the application process. A Brief may be prepared by the applicant which outlines the following:

- ▶ Opportunities and constraints to be assessed and identified.
- ▶ Site Analysis.
- ▶ Any further investigation required.

Preparation of the Brief may also include a pre-application discussion between the applicant and Council to consider and formulate landscape design requirements. In discussion, Council should ensure that the applicant is aware of relevant policies and guidelines which will inform the landscape design.

LANDSCAPE MASTER PLAN

Landscape Master Plans are to be produced for relevant subject sites and included as part of a Planning Permit application. This may be a requirement of the Planning Scheme, or it may be 'required additional information'. The Landscape Master Plan shall address streetscape and open space landscape proposals.

Where appropriate the Landscape Master Plan is to be developed from the prepared Brief and/or discussions with Council.

Application Review

The Landscape Master Plan will be reviewed by appropriate Council officers. The Landscape Master Plan will be assessed against relevant State, regional and local planning legislation. It will also be reviewed against Council's Standards and Policies.

Council will be responsible for internal referrals to ensure adequate consultation.

External referrals

While it is expected that applicants ensure the Landscape Master Plan meets requirements of external authorities, Council is responsible for seeking comments for Landscape Master Plans to any relevant authorities for their review and approval.

These authorities may include for example, Department of Environment, Land, Water and Planning (DELWP), VicRoads, Catchment Management Authorities and Goulburn-Murray Water.

Request for further information

Council may request further information from the applicant during the approval process. This may include, for example, information on integration with engineering proposals such as water sensitive urban design or justification for removal of vegetation.



Road reserve walkway with buffer planting

Public Display (if required)

Public Consultation and/or Notification may be required as part of the application depending on the nature of the development. Council should advise the applicant of this requirement and arrange for display of the Landscape Master Plan and receipt of comments.

Amendments to the Landscape Master Plan may be required following Council consideration of community comment. Where this is the case, Council will provide this information to the applicant in writing and provide time frames within which the amendments will be accepted.

PERMIT CONDITIONS

The approved Landscape Master Plan will be the basis of any Permit Condition requirements for landscape works.

A Condition for the requirement of landscape plans will be included in the Permit and will be similar to the following:

Before the use or developments starts, a landscape plan to the satisfaction of the responsible authority must be submitted to and approved by the responsible authority. The plan must be prepared in accordance with The Landscape Plan Guide. When approved, the plan will be endorsed and will then form part of the permit.

Permit Conditions may also detail requirements for:

- ▶ Landscape Concept Plans.
- ▶ Construction Documentation Plans.

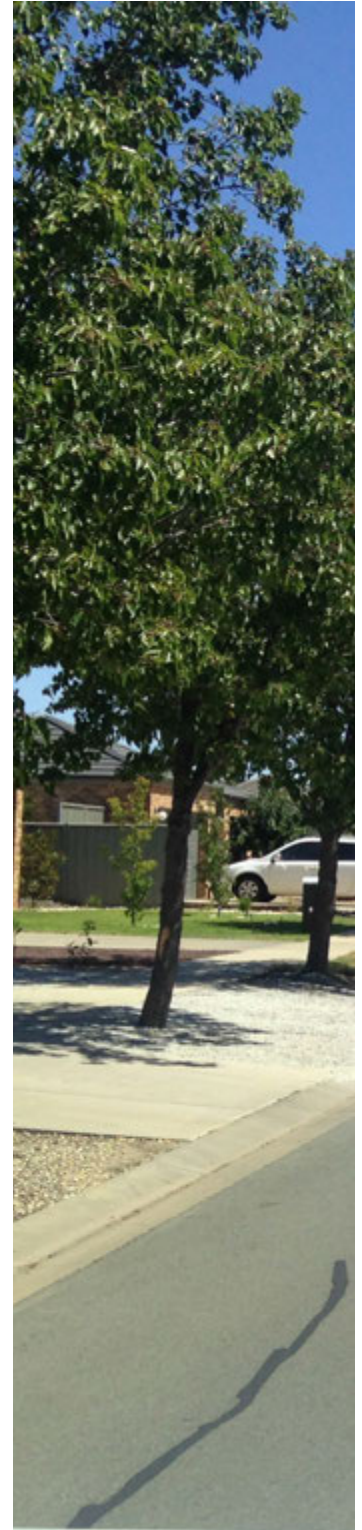

Tree planting of appropriate scale

LANDSCAPE CONCEPT PLAN (STAGED IF REQUIRED)

Permit Conditions will normally require a Landscape Concept Plan to be submitted, developed from the approved Landscape Master Plan.

Separate Concept Plans may be prepared and submitted according to the staging of the development.

The Landscape Concept Plan must be submitted to Council and approved prior to the approval of engineering/architectural construction plans and/or plan of subdivision certification for any particular stage.

The Landscape Concept Plan will be assessed against the approved Landscape Master Plan and engineering/architectural construction plans. When approved, the Landscape Concept Plan will be the basis for Construction Documentation plans.

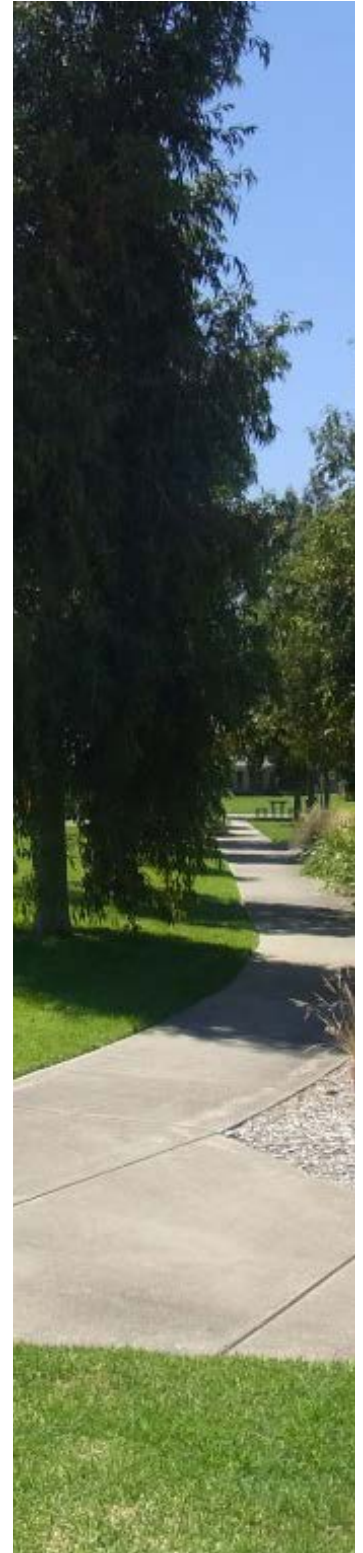

Reserve walkway with tree planting

CONSTRUCTION DOCUMENTATION PLANS (STAGED IF REQUIRED)

Permit Conditions will normally require Construction Documentation Plans to be submitted, developed from the approved Landscape Concept Plan.

Separate Construction Documentation Plans may be prepared and submitted according to the staging of the development.

Construction Documentation Plans are to be submitted to Council for approval prior to Council acceptance of any associated engineering/architectural works. Council will refer the plans to relevant internal departments. The plans will be assessed against the engineering construction plans to ensure integrated proposals.



Reserve shelter and seating with tree planting

5.4 Landscape Plan Requirements

The following describes Council's expectations relating to the range of landscape plans and construction works required by the design and approvals processes defined above.

The requirements for landscape plans will vary depending on the level of detail required by the landscape proposals, including the size and cost of the works.

Landscape plans must be prepared by a Council accredited landscape architect or landscape consultant. Landscape plans for small or less complex developments may be prepared by landscape designers or horticulturists. Mid range to larger complex developments landscape plans must be prepared by registered landscape architects (Registered member of the Australian Institute of Landscape Architects). Ideally, the landscape architect/designer shall be commissioned early in the design process to ensure that all landscape related issues are considered.

LANDSCAPE MASTER PLAN

A Landscape Master Plan is a review of the site that includes relevant landscape design and maintenance considerations sufficient to demonstrate an understanding of the proposed development and provide an adequate basis for the production of concept designs. Landscape Master Plans may be drawn and/or written.

Site Analysis

A site analysis plan shall be prepared as the first step in the master planning process and include such things as the following:

- ▶ Photographs of existing conditions and any key features.
- ▶ Existing conditions including landscape characteristics, topographical information, existing native and exotic vegetation, views to and from the site, micro-climate (such as wind and sun), overland flows and water courses.
- ▶ Pedestrian and vehicular access.
- ▶ Solar access, orientation and noise sources.
- ▶ Fences, boundaries and easements.
- ▶ Proximity of, connection and access to public open space.
- ▶ Surrounding neighbourhood character (built form and landscape character) such as residential areas, play areas and outdoor activities, buffer zones, screening, public and private areas, security, passive surveillance and landmark elements.
- ▶ Heritage acknowledgments.

Site Layout

The site layout should be based on the site analysis and be determined in conjunction with other professionals including engineers, planners and urban designers.

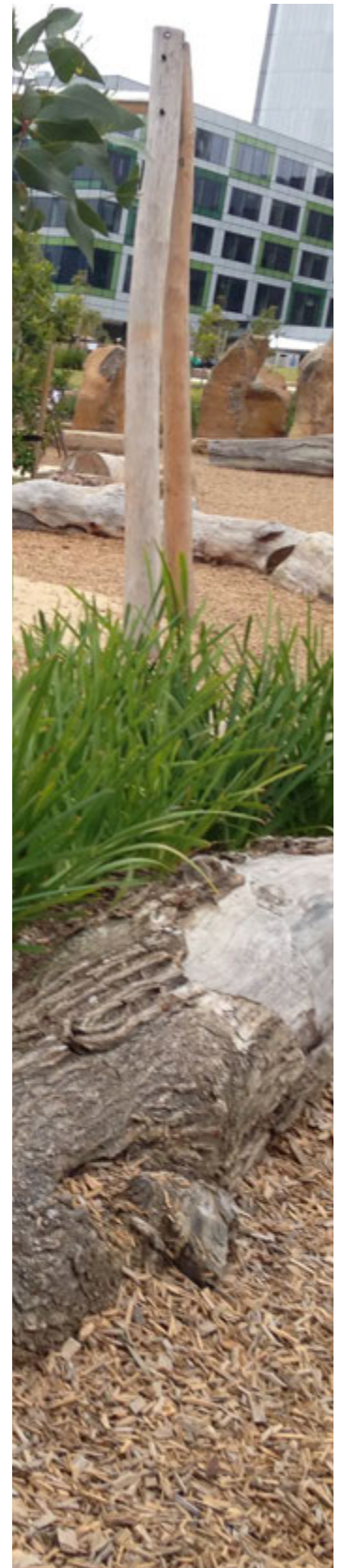

Planting

Planting design at the Landscape Master Plan stage should include the following:

- ▶ Layout of proposed planting, including indicative locations of proposed trees and areas of proposed garden bed planting.
- ▶ A recommended plant schedule for proposed trees, shrubs, tufted plants and groundcovers in accordance with the approved planting lists.
- ▶ Planting themes to ensure a cohesive landscape outcome.
- ▶ Protection and enhancement of existing vegetation which is to be retained.

Water Sensitive Urban Design

The Landscape Master Plan is to demonstrate the ways in which the proposed design integrates with engineering treats water including:

- ▶ Stormwater treatment and/or retention.
- ▶ Reuse of captured stormwater.
- ▶ Grey water systems.

Materials and Finishes

Materials and finishes are to be in line with Landscape Standards – Materials and Techniques as described in this document.

Community art

Inclusion of appropriate public art opportunities should be considered.



LANDSCAPE CONCEPT PLAN (STAGED IF REQUIRED)

The Landscape Concept Plan is a clearly resolved landscape design, traceable to the Landscape Master Plan and where relevant, based on defined engineering and architectural proposals. Landscape Concept Plans should be to scale and show proposed hard and soft materials to an extent appropriate to review, discussion and approval, but not in sufficient detail to enable construction.

A Landscape Concept Plan for each stage of development must be prepared according to the design and approval process. Plans may be prepared separately according to stages.

The Concept Plan must be drawn to scale.

The Landscape Concept Plan should show:

- ▶ Existing vegetation to be retained (a tree assessment and management plan may be required).
- ▶ Existing vegetation to be removed (a tree assessment may be required).
- ▶ The proposed quantity and location of landscape elements in all proposed open space and streetscape embellishments which comprise the landscape works. This includes elements such as tree planting, garden beds, pathways, seating, shelters, picnic facilities, boardwalks, signage, drinking fountains, rubbish receptacles, irrigation systems, playgrounds, artwork, retaining walls, protective fencing (temporary and permanent), vehicle control methods, wetlands, ornamental water bodies and so on.
- ▶ Areas to be managed and rehabilitated for conservation or offset planting purposes and the method by which these areas will be protected.

CONSTRUCTION DOCUMENTATION PLANS (STAGED IF REQUIRED)

Landscape Construction Documentation Plans are precise plans, schedules and specifications, clearly traceable to the Landscape Concept Plan and based on final engineering and architectural proposals. The plans are sufficient to control the construction of the landscape works and are appropriate for review, discussion and approval.

Construction Plans for each stage of development must be prepared according to the approval process. Plans may be prepared separately according to stages.

The construction plans are to be drawn to scale.

The following is to be included in the Construction Documentation plans and must be submitted to Council for approval prior to construction.

Existing Conditions

All existing site conditions and information including buildings, services, roads, footpaths and vegetation.



Streetscape planting with viewlines to park

Demolition

All existing site features that are to be removed as part of the landscape construction including removal of any vegetation.

Grading and Drainage

Proposed contours and finished levels of the works. This should include falls and drainage associated with the new landscape design.

Setout

The proposed layout of the landscape design with accurate descriptions and dimensions of the proposed elements sufficient for construction of the works. Existing and proposed utility services must be shown on the plans.

Materials & Finishes

The materials and finishes of all proposed hard & soft landscape treatments, including furniture types, any colours and or themes for the hard and soft landscape.

Planting

The type and location of the planting included in the works including botanical and common names of proposed plant species, mature height and installation size, location and quantity.

Tree canopy size to be shown on plans as full mature size and as a percentage of public land.

Irrigation

The location, type and performance of the proposed irrigation system. This may be prepared by the Contractor as a 'Design and Construct' irrigation system.

Elevation / Sections

The vertical and horizontal relationships of the design in the form of scaled elevations and or sections. The elevations and sections are to demonstrate how the works are to look and are to be drawn from relevant and key locations across the works.

Construction Details

Construction Details are a combination of plans, sections and elevations at varying scales (for example 1:10, 1:20, 1:50) which clearly describe the construction intent and requirements of the hard and soft landscape works.

Landscape Specifications (when required)

The Specification describes the requirements for construction and installation of the works, Completion, Maintenance and Handover obligations.



Streetscape planting with large deciduous trees

MAINTENANCE / ESTABLISHMENT PLAN

The Maintenance or Establishment Plan or Program may be required to be submitted to Council for approval with the Construction Documentation.

Any Maintenance Plan requirements will be provided by Council and may include the obligations and requirements for the maintenance of the hard and soft landscape works such as the following:

- ▶ Weeding & Rubbish Removal.
- ▶ Replacement Plants.
- ▶ Stakes & Ties.
- ▶ Grass.
- ▶ Pruning.
- ▶ Mulch.
- ▶ Fertiliser.
- ▶ Remnant Vegetation maintenance.

5.5 Landscape Plan Submissions

Landscape Plans shall be produced according to the following minimum standards.

- ▶ Scale appropriate to the size of the site and nature of development to adequately describe the landscape proposal.
- ▶ Large sites may be scale 1:500 or 1:200 and smaller sites 1:100 or 1:50.
- ▶ Construction Details are to be generally 1:20 or 1:10.

PRESENTATION

- ▶ Landscape Master Plans and Landscape Concept Plans
1 x coloured plan and 2 x black and white plans.
- ▶ Landscape Construction Documentation Plans
3 x black and white plans
- ▶ Neatly printed, legible and supported by relevant documentation.
- ▶ Accurate location of existing and proposed site features.
- ▶ Include legend, titleblock, scale and scale bar, and north point.
- ▶ Include plant schedule of proposed trees, shrubs, grasses and groundcover species.

5.6 Landscape Plan Templates/Examples



Template example of a typical open space landscape plan integrating engineering and landscape

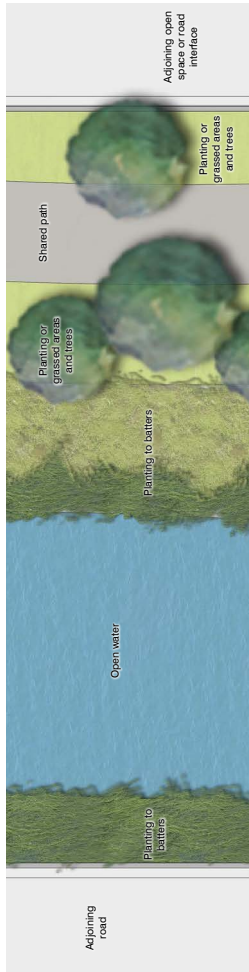

- Adjoining road
- Where space does not permit re-shape for safe heavy plant or fence in accordance with current safety requirements
- Open water
- Where space permits re-shape drain edge to provide safe approach batters and vegetate with appropriate plant species
- 0-3m terrestrial planting or grassed area and trees
- 3m wide shared path and maintenance access
- Terrestrial planting or grassed area and trees
- Adjoining open space or road interface



PROJECT TITLE LOGO

PLAN TYPE | PROJECT LOCATION

Drawing Number: 123456 000
 RevisionDate: 01 01/01/2001
 Sheet: 01 of 01
 Drawn by: Person 1
 Checked by: Person 2

Template example of a typical landscape section integrating engineering and landscape

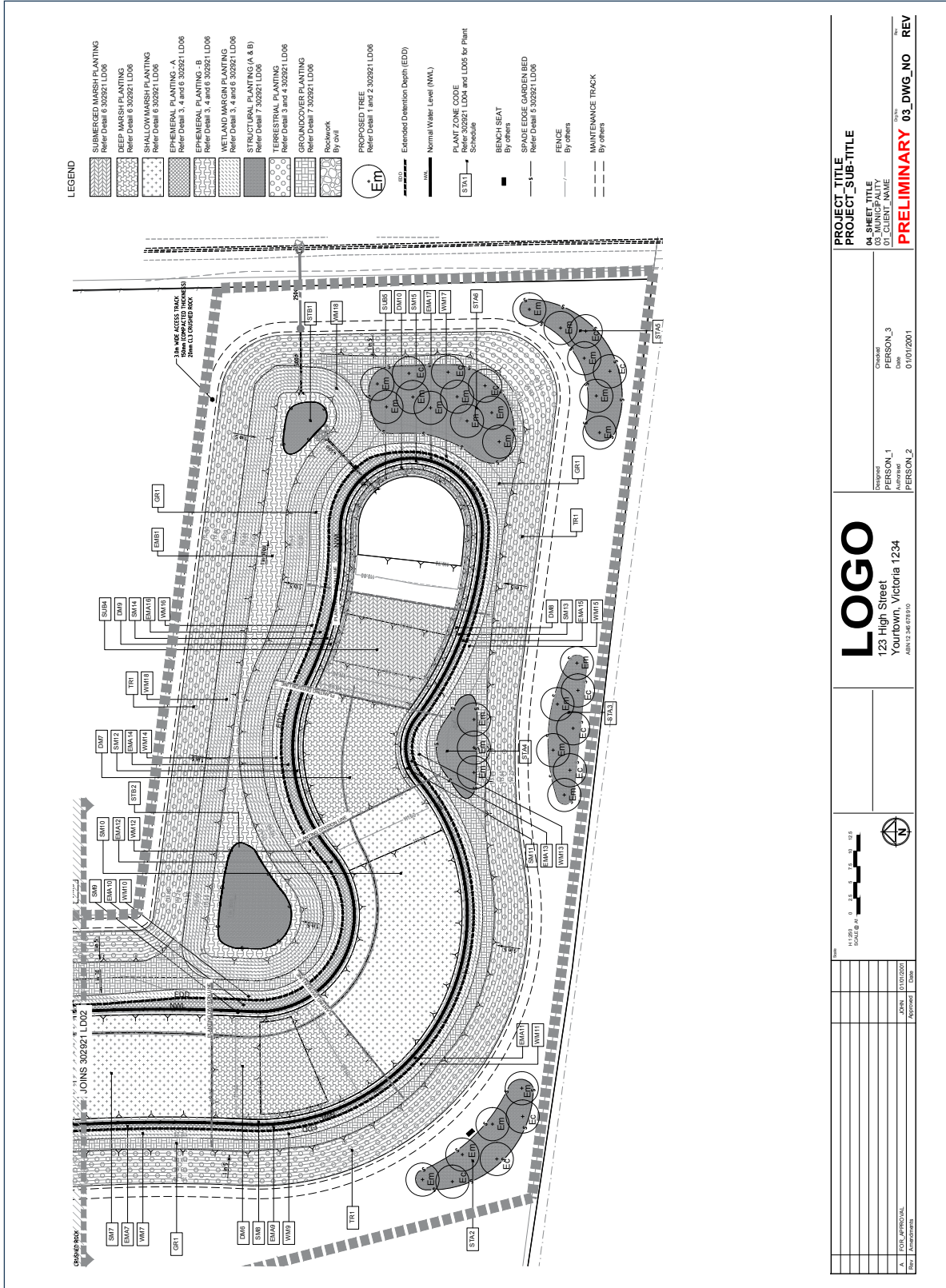

Template example of a part of a typical wetland planting plan

PLANT SCHEDULE DWG 001

| TREES | | | |
|--------------|-------------------------------------------|------------------------------|-----------|
| Code | Botanical Name | Common Name | Qty |
| Af | <i>Acer freemanii</i> 'Jeffersred' | Maple | 6 |
| Bp | <i>Baccharis confertiflora</i> | Kurrajong | 21 |
| Em | <i>Eucalyptus melliodora</i> | Yellow Box | 25 |
| EEd | <i>Eucalyptus leucopylla</i> 'Euky Dwarf' | Dwarf Yellow Gum | 6 |
| Li | <i>Lagerstroemia indica</i> 'Natchez' | White flowering Crepe Myrtle | 5 |
| Pc | <i>Pistacia chinensis</i> | Chinese Pistachio | 1 |
| Total | | | 64 |

| SHRUBS | | | |
|--------------|------------------------------------------------|--------------------------|------------|
| Code | Botanical Name | Common Name | Qty |
| Bs | <i>Banksia spinulosa</i> x <i>ericifolia</i> | Banksia 'Giant Candles' | 180 |
| CWm | <i>Callistemon 'Maive Mist'</i> | Callistemon 'Maive Mist' | 180 |
| Cr | <i>Correa reflexa</i> | Common Correa | 180 |
| Gb | <i>Grevillea (G.banksii x G.bipinnatifida)</i> | Grevillea 'Ned Kelly' | 180 |
| Wc | <i>Westringia crassifolia</i> | Whipslick Westringia | 180 |
| Total | | | 900 |

| GROUNDCOVERS | | | |
|--------------|------------------------------------|--------------------|------------|
| Code | Botanical Name | Common Name | Qty |
| Ch | <i>Chrysanthemum apiculatum</i> | Yellow Buttons | 180 |
| EKc | <i>Eriophylla 'Kaltarr Carpet'</i> | Ernu Bush | 180 |
| Mp | <i>Myoporum parvifolium</i> | Creeping boobialla | 180 |
| Sa | <i>Scaevola aemula</i> | Fan Flower | 180 |
| Total | | | 720 |

| TUSSOCK PLANTS | | | |
|----------------|----------------------------|----------------------|------------|
| Code | Botanical Name | Common Name | Qty |
| Ca | <i>Carex appressa</i> | Tall Sedge | 180 |
| CI | <i>Carex inversa</i> | Knob Sedge | 180 |
| Ju | <i>Juncus ustulatus</i> | Ernu Bush | 180 |
| Ll | <i>Lomandra longifolia</i> | Pin Rush | 180 |
| Pl | <i>Poa labillardieri</i> | Common Tussock Grass | 180 |
| Total | | | 900 |

| CLIMBERS | | | |
|--------------|------------------------------|-----------------------|------------|
| Code | Botanical Name | Common Name | Qty |
| Cm | <i>Clematis microphylla</i> | Small-leaved Clematis | 180 |
| Hv | <i>Hardenbergia violacea</i> | Happy Wanderer | 180 |
| Rp | <i>Rubus parvifolius</i> | Native Raspberry | 180 |
| Total | | | 540 |

| | | |
|----------------------------------------------------------------------------------------|--|---------------------------------------------------------------------------------------------------------------------------------------------------------------------------------------------------|
| | | <p>PROJECT TITLE PROJECT_SUB-TITLE</p> <p>04_SHEET_TITLE 01_CLIENT_NAME</p> <p>PERSON_1 PERSON_2</p> <p>PERSON_3 Date: 01/10/2001</p> <p>PRELIMINARY 03_DWG_NO REV</p> |
| <p>SCALE @ 1:100</p> | | |
| <p>DATE: _____</p> <p>DESIGNER: _____</p> <p>CHECKED: _____</p> <p>APPROVED: _____</p> | | |



Integrated seating area with tree and garden planting



Integration of landscape and engineering WSUD



Screen planting and gravel access area around substation



Open grassed areas and buffer planting adjacent residential lots



Grass areas, pathway and planting incorporated with WSUD basin



Seating area with concrete pad set in gravel.



SECTION 3

RURAL DEVELOPMENTS



6. RURAL DEVELOPMENTS

6.1 Design Considerations

Refer to Section 11 Recommended Plant Lists and Section 15 Materials and Techniques for further information on plant species, design and specification of landscape works. Rural species are denoted with **R** in the plant list.

Some factors to consider in the preparation of a landscape plan for rural developments are outlined below.

- ▶ Visual Landscape Assessment.
- ▶ Siting of buildings in relation to existing vegetation and view lines.
- ▶ Boundary planting for screening and habitat.
- ▶ Wildlife corridors as habitat for native fauna, including connectivity to external wildlife corridors.
- ▶ Fencing that is visually unobtrusive and minimises harm to native fauna such as post and wire (e.g. do not use barbed wire).
- ▶ Setbacks for proposed buildings/structures from existing native vegetation to be retained.
- ▶ Tree Protection Zones for existing native vegetation.
- ▶ Use of indigenous and native plants. Indigenous plants are those that occur naturally in a local area. Benefits of indigenous species include:
 - ▶ Adaptation to the local climate, soil type and tolerance of drought and frost.
 - ▶ Attract native fauna to the garden by providing a source of food and shelter.
 - ▶ Are not likely to become environmental weeds.
 - ▶ Require less water and fertiliser than many exotic species. Reducing water and fertiliser application limits the amount of nutrients entering natural waterways.
 - ▶ Reducing soil erosion and improving soil structure.
 - ▶ Contribute to wildlife corridors that enable wildlife to move from one forest area to another.
 - ▶ Planting native plants will assist in the preservation of the natural landscape and enhance natural biodiversity.
 - ▶ Improving the appearance and aesthetics of properties and rural landscapes.
- ▶ Setback of planting to allow for fence maintenance, firebreaks, services, sight lines near roads, access ways etc.
- ▶ Landscaping in fire prone situations using appropriate offsets and species.
[Refer http://www.cfa.vic.gov.au/plan-prepare/landscaping-for-bushfire/](http://www.cfa.vic.gov.au/plan-prepare/landscaping-for-bushfire/)
- ▶ Ensure successful establishment of plants through adequate site preparation, row spacing and planting patterns which match plant variety with aspect, drainage and soil type characteristics of the site.
- ▶ Canopy cover – achieve maximum canopy cover that is appropriate to the site location.

- ▶ Use appropriate ratios trees:shrubs for various purposes e.g. screen, dust, visual, filter views, light, noise etc
 - ▶ minimum two rows of planting however more rows may be required depending on site and circumstance
 - ▶ tree spacing may be 12 m apart or 20% of site area depending on species characteristics
 - ▶ shrub spacing may be 2 - 3 m spacing or 80% of the site area depending on species characteristics.
- ▶ Use a variety of species including trees, shrubs, tufting plants and ground covers to provide layered vegetation.
- ▶ Use planting layouts where the variety of species may be repeated along the length of the subject site, for example repeating a 10m x 20m layout of planting area (as per example sketch below).
- ▶ Revegetation areas to include a combination of Trees, shrubs and understorey plants.
- ▶ Tree planting density to be a minimum of one tree per 10 sq m or 10-15 lin m.
- ▶ Plant Understorey species in groups five to seven plants of same species.
- ▶ Use of ground covers and mulch to retain water and minimise erosion.
- ▶ Maintenance especially watering, weed control, replacement of losses.

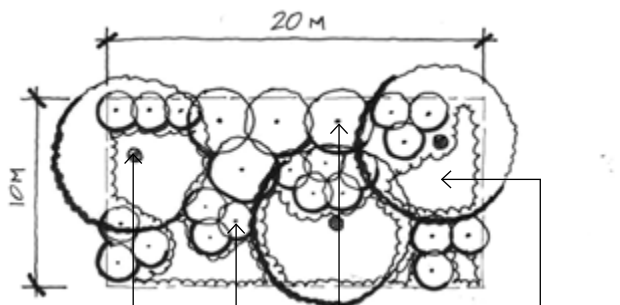

Tree under-planted with grasses and ground covers Small shrubs (2m spread) Large shrubs (4m spread) Grasses and/or ground covers

Note: Spacings and plant varieties may vary.

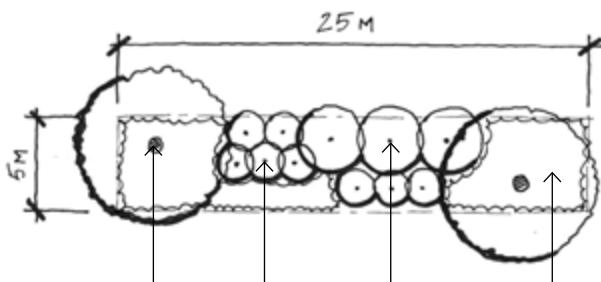

Tree under-planted with grasses and ground covers Small shrubs (2m spread) Large shrubs (4m spread) Grasses and/or ground covers

Note: Spacings and plant varieties may vary.

Example sketches of boundary/buffer planting. Layout of planting may be repeated along the length of the subject site to meet the required landscape area.

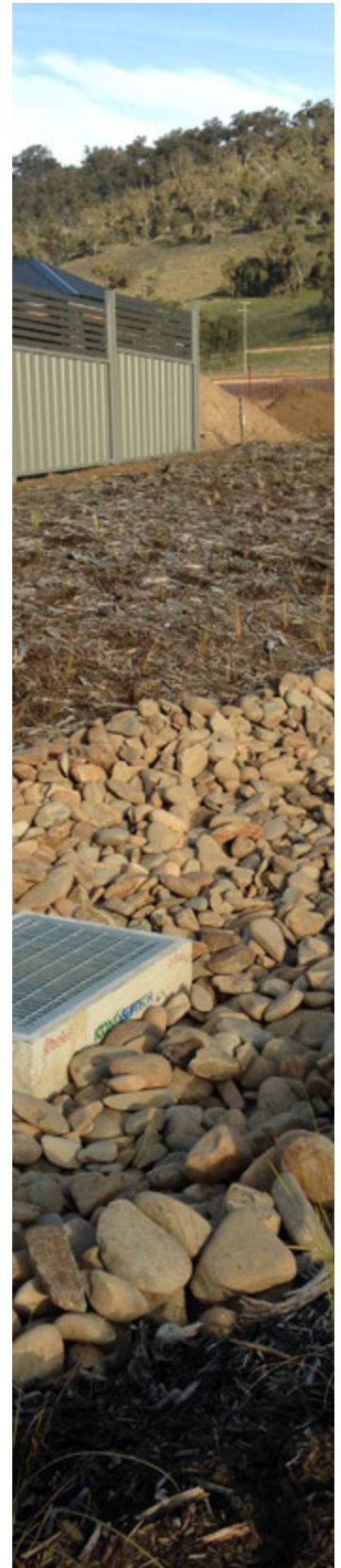

6.2 Approvals Process

The following outlines the general approval process for rural developments landscape proposals.

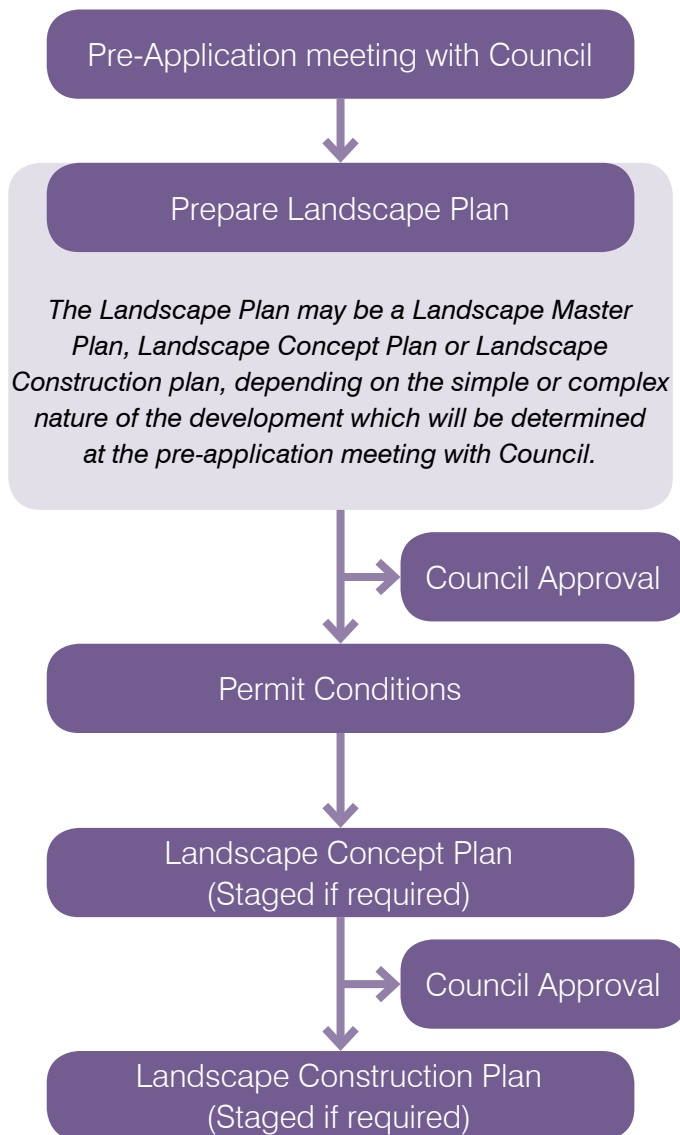

6.3 Landscape Plan Requirements

The following describes Council's expectations relating to the range of landscape plans and construction works required by the design and approvals processes defined above for rural developments.

The requirements for landscape plans will vary depending on the level of detail required by the landscape proposals, including the size and cost of the works.

Council recommends the applicant employ a qualified landscape architect, landscape designer or horticulturist to prepare or assist with developing the required landscape plans. Ideally, the landscape architect/designer shall be commissioned early in the design process to ensure that all landscape related issues are considered.

LANDSCAPE MASTER PLAN

A Landscape Master Plan is a review of the site that includes relevant landscape design and maintenance considerations sufficient to demonstrate an understanding of the proposed development and provide an adequate basis for the production of concept designs. Landscape Master Plans may be drawn and/or written.

Site Analysis

A site analysis plan may be prepared as the first step in the master planning process and include such things as the following:

- ▶ Photographs of existing conditions and any key features.
- ▶ Existing conditions including landscape characteristics, topographical information, existing native and exotic vegetation, views to and from the site, micro-climate (such as wind and sun), overland flows and watercourses.
- ▶ Pedestrian and vehicular access.
- ▶ Solar access, orientation and noise sources.
- ▶ Fences, boundaries and easements.
- ▶ Proximity of, connection and access to public open space.
- ▶ Surrounding neighbourhood character (built form and landscape character) such as residential areas, play areas and outdoor activities, buffer zones, screening, public and private areas, security, passive surveillance and landmark elements.
- ▶ Heritage acknowledgments.

Site Layout

The site layout should be based on the site analysis and where relevant be determined in conjunction with other professionals including engineers, planners and urban designers.

Planting

Planting design at the Landscape Master Plan stage should include the following:

- ▶ Layout of proposed planting, including indicative locations of proposed trees and areas of proposed garden bed planting and any watercourse planting.
- ▶ A recommended plant schedule for proposed trees, shrubs,



tufted plants, groundcovers and aquatic vegetation in accordance with the approved planting lists.

- ▶ Planting themes to ensure a cohesive landscape outcome that is in keeping with the local rural character.
- ▶ Protection and enhancement of existing vegetation which is to be retained.

Water Sensitive Urban Design

The Landscape Master Plan is to demonstrate the ways in which the proposed design treats water including:

- ▶ Stormwater treatment and/or retention.
- ▶ Reuse of captured stormwater.
- ▶ Grey water systems.

Materials and Finishes

Materials and finishes should be described in the Master Plan and where appropriate are to be in line with Landscape Standards – Materials and Techniques as described in the Landscape Plan Guide.

LANDSCAPE CONCEPT PLAN (STAGED IF REQUIRED)

The Landscape Concept Plan is a clearly resolved landscape design, traceable to the Landscape Master Plan and where relevant, based on defined engineering and architectural proposals. Landscape Concept Plans should be to scale and show proposed hard and soft materials to an extent appropriate to review, discussion and approval, but not in sufficient detail to enable construction.

A Landscape Concept Plan for each stage of development must be prepared according to the design and approval process. Plans may be prepared separately according to stages.

The Concept Plan must be drawn to scale.

The Landscape Concept Plan should show:

- ▶ Existing vegetation to be retained (a tree assessment and management plan may be required).
- ▶ Existing vegetation to be removed (a tree assessment may be required).
- ▶ The proposed quantity and location of landscape elements which comprise the landscape works. This includes (but not limited to) elements such as tree planting, buffer/screen planting, garden beds, pathways, buildings, sheds, shelters, signage, irrigation systems, retaining walls, protective fencing (temporary and permanent), access roads, wetlands/waterways, ornamental water bodies and so on.
- ▶ Areas to be managed and rehabilitated for conservation or offset planting purposes and the method by which these areas will be protected.



Buffer planting to large scale rural development

CONSTRUCTION DOCUMENTATION PLANS (STAGED IF REQUIRED)

Landscape Construction Documentation Plans are precise plans, schedules and specifications, clearly traceable to the Landscape Concept Plan and where relevant based on final engineering and architectural proposals. The plans are sufficient to control the construction of the landscape works and are appropriate for review, discussion and approval.

Construction Plans for each stage of development must be prepared according to the approval process. Plans may be prepared separately according to stages.

Council may consider applications which combine the Landscape Concept and Landscape Construction Plans in one drawing set.

The construction plans are to be drawn to scale.

The following is to be included in the Construction Documentation plans and must be submitted to Council for approval prior to construction.

Existing Conditions

All existing site conditions and information including buildings, services, roads, footpaths and vegetation.

Demolition

All existing site features that are to be removed as part of the landscape construction including removal of any vegetation.

Grading and Drainage

Proposed contours and finished levels of the works. This should include falls and drainage associated with the new landscape design.

Setout

The proposed layout of the landscape design with accurate descriptions and dimensions of the proposed elements sufficient for construction of the works. Existing and proposed utility services must be shown on the plans.

Materials & Finishes

The materials and finishes of all proposed hard & soft landscape treatments, including furniture types, any colours and or themes for the hard and soft landscape.

Planting

The type and location of the planting included in the works for both terrestrial and aquatic planting including botanical and common names of proposed plant species, mature height and installation size, location and quantity.



Irrigation

The location, type and performance of the proposed irrigation system. This may be prepared by the Contractor as a 'Design and Construct' irrigation system.

Elevation / Sections

The vertical and horizontal relationships of the design in the form of scaled elevations and or sections. The elevations and sections are to demonstrate how the works are to look and are to be drawn from relevant and key locations across the works.

Construction Details

Construction Details are a combination of plans, sections and elevations at varying scales (for example 1:10, 1:20, 1:50) which clearly describe the construction intent and requirements of the hard and soft landscape works.

Landscape Specifications (when required)

The Specification describes the requirements for construction and installation of the works. The Landscape Specifications will detail the proposed method of Completion and ongoing Maintenance obligations.

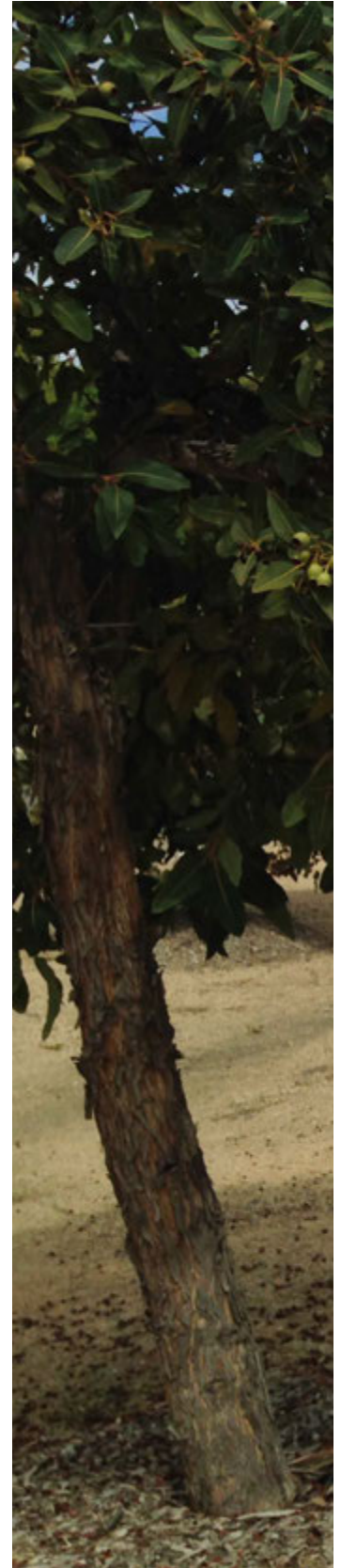

MAINTENANCE / ESTABLISHMENT PLAN

The Maintenance or Establishment Plan or Program may be required to be submitted to Council for approval with the Construction Documentation.

Any Maintenance Plan requirements will be provided by Council and may include the obligations and requirements for the maintenance of the hard and soft landscape works such as the following:

- ▶ Weeding & Rubbish Removal.
- ▶ Replacement Plants.
- ▶ Stakes & Ties.
- ▶ Fencing.
- ▶ Grass.
- ▶ Pruning.
- ▶ Mulch.
- ▶ Fertiliser.
- ▶ Remnant Vegetation maintenance.

6.4 Landscape Plan Submissions

Landscape Plans shall be produced according to the following minimum standards.

- ▶ Scale appropriate to the size of the site and nature of development to adequately describe the landscape proposal.
- ▶ Large sites may be scale 1:500 or 1:200 and smaller sites 1:100 or 1:50.
- ▶ Construction Details are to be generally 1:20 or 1:10.

PRESENTATION

- ▶ Landscape Master Plans and Landscape Concept Plans
1 x coloured plan and 2 x black and white plans.
- ▶ Landscape Construction Documentation Plans
3 x black and white plans
- ▶ Neatly printed, legible and supported by relevant documentation.
- ▶ Accurate location of existing and proposed site features.
- ▶ Include legend, titleblock, scale and scale bar, and north point.
- ▶ Include plant schedule of proposed trees, shrubs, grasses and groundcover species.

6.5 Landscape Plan Templates/Examples

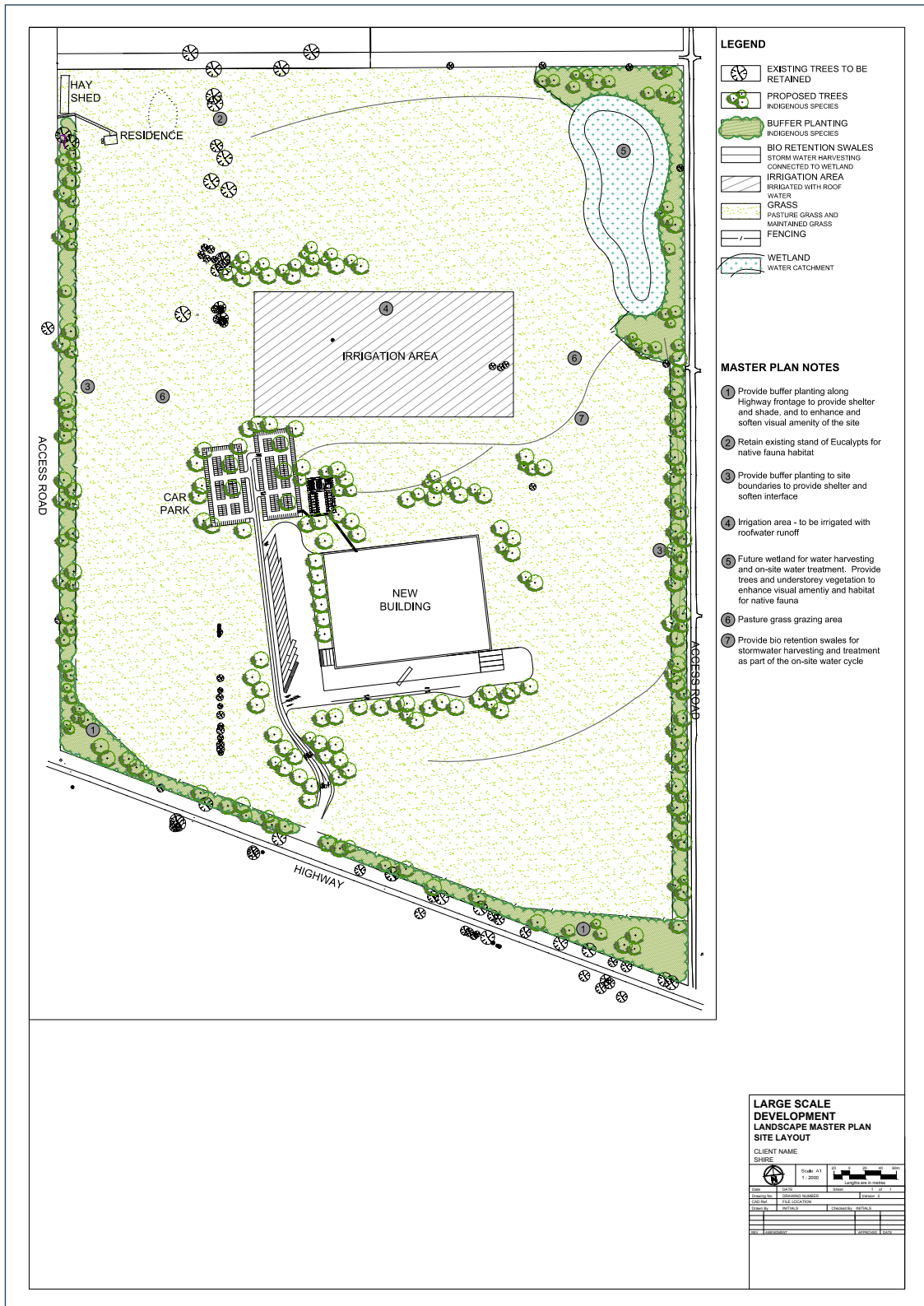

Template example of large scale rural development including buffer planting

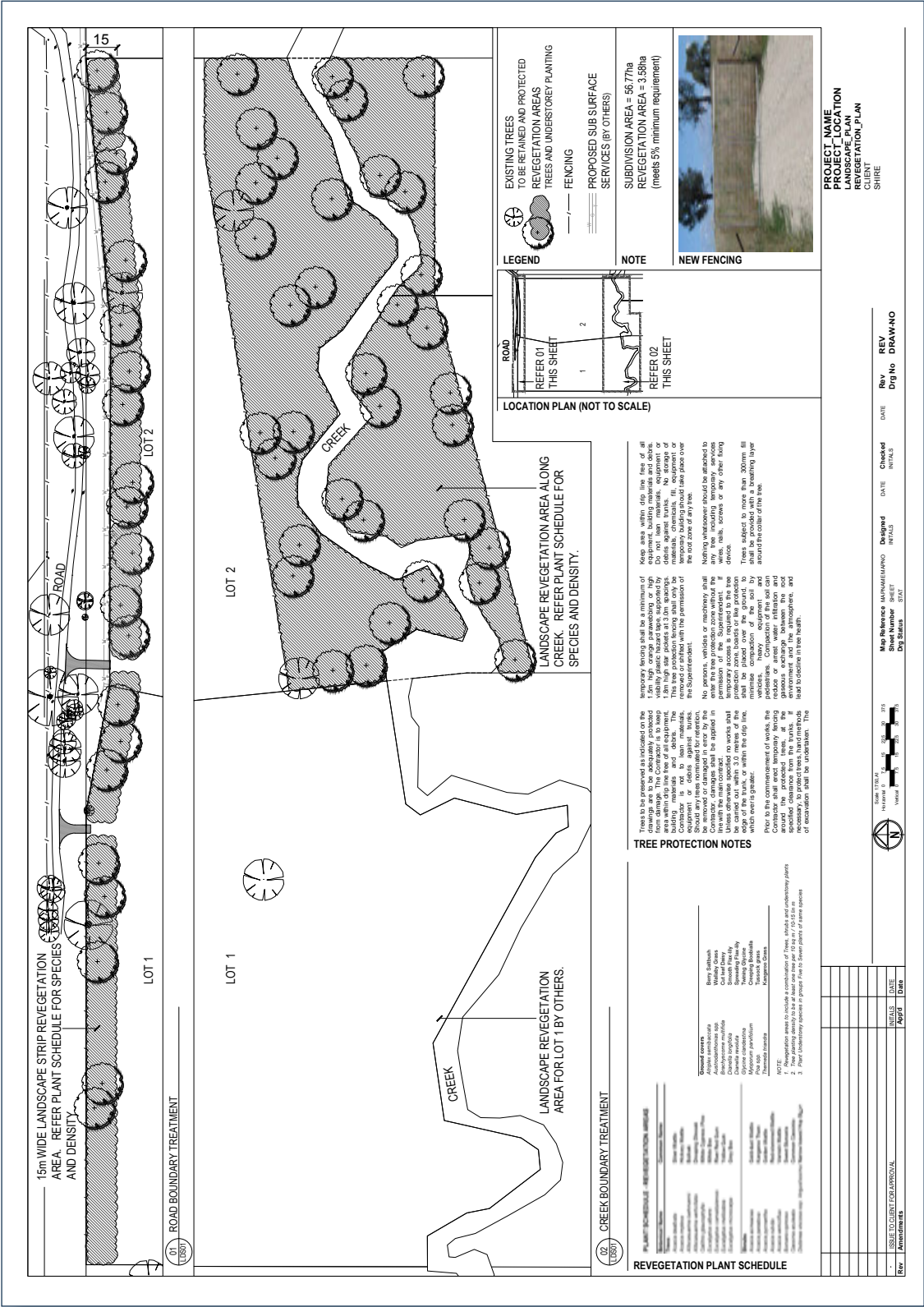

15m WIDE LANDSCAPE STRIP REVEGETATION AREA. REFER PLANT SCHEDULE FOR SPECIES AND DENSITY.

LOT 1

LOT 2

ROAD

CREEK

LANDSCAPE REVEGETATION AREA FOR LOT 1 BY OTHERS.

01 ROAD BOUNDARY TREATMENT

02 CREEK BOUNDARY TREATMENT

LANDSCAPE REVEGETATION AREA ALONG CREEK. REFER PLANT SCHEDULE FOR SPECIES AND DENSITY.

EXISTING TREES TO BE RETAINED AND PROTECTED TREES AND UNDERSTORY PLANTING

FENCING

PROPOSED SUB SURFACE SERVICES (BY OTHERS)

SUBDIVISION AREA = 56.77ha
REVEGETATION AREA = 3.58ha
(meets 5% minimum requirement)

NEW FENCING

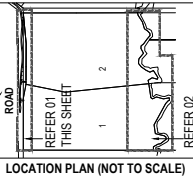

Tree protection shall be a minimum of 1.5m wide, when dip line free of all vegetation and debris. Temporary fencing shall be visible plastic hazard tape supported by 4m high steel poles and 1.5m diameter posts. The high use poles and posts shall be removed or shifted with the permission of the Superintendent. Temporary fencing shall be placed over the top zone of any tree.

When removing any tree, the contractor shall submit a written application to the Superintendent for the removal of the tree. The application shall include the following information: 1. A written report of the tree's condition, including a detailed description of the tree's location, size, and species. 2. A written report of the tree's value, including a written estimate of the tree's replacement cost. 3. A written report of the tree's importance to the site, including a written description of the tree's role in the site's landscape. 4. A written report of the tree's removal method, including a written description of the equipment to be used and the safety measures to be taken. 5. A written report of the tree's removal date, including a written description of the date and time of removal. 6. A written report of the tree's removal location, including a written description of the location and the method of disposal. 7. A written report of the tree's removal cost, including a written description of the cost and the method of payment.

Any tree that is removed without the written permission of the Superintendent shall be removed at the contractor's expense. Any tree that is removed without the written permission of the Superintendent shall be removed at the contractor's expense. Any tree that is removed without the written permission of the Superintendent shall be removed at the contractor's expense.

TREE PROTECTION NOTES

- 1. Any tree that is removed without the written permission of the Superintendent shall be removed at the contractor's expense.
- 2. Any tree that is removed without the written permission of the Superintendent shall be removed at the contractor's expense.
- 3. Any tree that is removed without the written permission of the Superintendent shall be removed at the contractor's expense.
- 4. Any tree that is removed without the written permission of the Superintendent shall be removed at the contractor's expense.
- 5. Any tree that is removed without the written permission of the Superintendent shall be removed at the contractor's expense.
- 6. Any tree that is removed without the written permission of the Superintendent shall be removed at the contractor's expense.
- 7. Any tree that is removed without the written permission of the Superintendent shall be removed at the contractor's expense.
- 8. Any tree that is removed without the written permission of the Superintendent shall be removed at the contractor's expense.
- 9. Any tree that is removed without the written permission of the Superintendent shall be removed at the contractor's expense.
- 10. Any tree that is removed without the written permission of the Superintendent shall be removed at the contractor's expense.

REVEGETATION PLANT SCHEDULE

| Rev | Issue | Client | Contractor | Date |
|-----|-------|--------|------------|------|
| | | | | |
| | | | | |
| | | | | |

PROJECT NAME
PROJECT LOCATION
LANDSCAPE PLAN
SUBDIVISION PLAN
CLIENT
SHIRE

| Map Reference | M/W/L | M/W/L | DATE | Checked | DATE | Rev | Rev |
|---------------|-------|-------|----------|----------|----------|--------|---------|
| Sheet Number | Sheet | Sheet | INITIALS | INITIALS | INITIALS | Dwg No | Draw No |
| | | | | | | | |
| | | | | | | | |
| | | | | | | | |
| | | | | | | | |

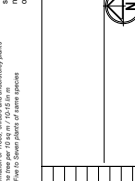

Template example of a rural subdivision landscape plan and notes

LEGEND showing all elements on plan

- LEGEND**
- EXISTING DECIDUOUS TREES
 - EXISTING EVERGREEN TREES
 - NEW EVERGREEN TREES
 - EXISTING REVEGETATION AREAS
 - NEW REVEGETATION AREAS
 - NEW DAM
 - NEW DAM MARGIN PLANTING
 - EXISTING POST AND WIRE FENCING
 - NEW POST AND WIRE FENCING

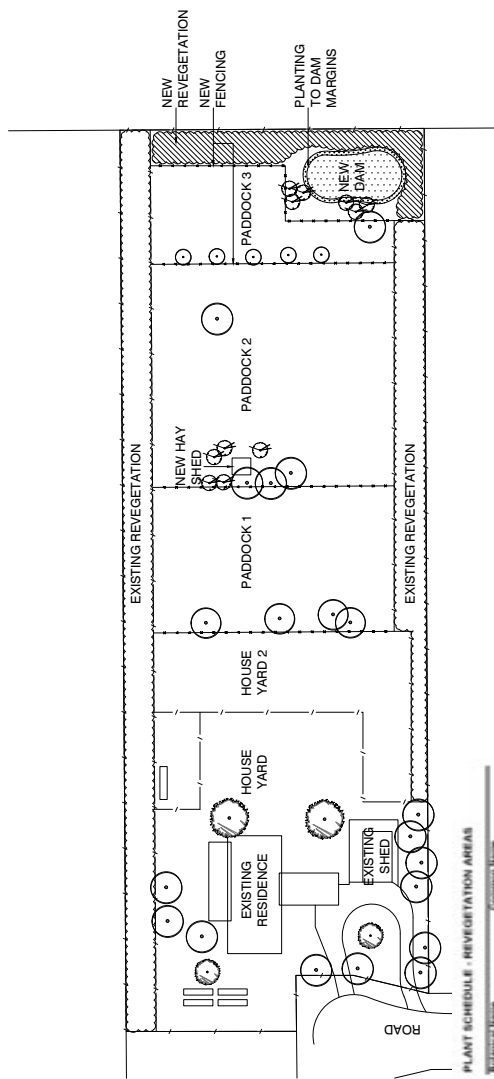

PLANT SCHEDULE - REVEGETATION AREAS

| Scientific Name | Common Name |
|--------------------------|---------------------------|
| Acacia dealbata | Brown Wattle |
| Acacia farnesiana | Yellow Wattle |
| Acacia melanocorynia | Black Wattle |
| Acacia senilis | White Cypress Pine |
| Casuarina cunninghamiana | Wattlebird |
| Eucalyptus melliodora | Yellow Gum |
| Eucalyptus microcarpa | Grey Gum |
| Leptosiphon juncea | Old Red Wattle |
| Leptosiphon juncea | Kingston Thorn |
| Leptosiphon juncea | Golden Wattle |
| Leptosiphon juncea | Yarrah Wattle |
| Leptosiphon juncea | Beest Burdock |
| Leptosiphon juncea | Common Clematis |
| Leptosiphon juncea | Horizon Spider (Sp. Bush) |
| Leptosiphon juncea | Berry Balm |
| Leptosiphon juncea | Blackberry |
| Leptosiphon juncea | Old Red Wattle |
| Leptosiphon juncea | Smooth Foxglove |
| Leptosiphon juncea | Spreading Thistle |
| Leptosiphon juncea | Creeping Broomrape |
| Leptosiphon juncea | Trunking Grass |
| Leptosiphon juncea | Kingston Thorn |

Template example of planting layout

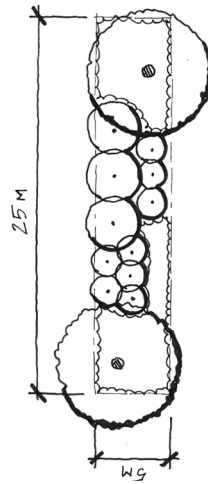

TITLEBLOCK with project name, location, plan type and municipality

| | | | |
|-----------------------------------------|-----|------------------------|-----------------------|
| RURAL DEVELOPMENT LANDSCAPE PLAN | | | |
| SHIRE/MUNICIPALITY | | DATE | |
| DRG_NO | REV | Designed INITIALS/DATE | Checked INITIALS/DATE |

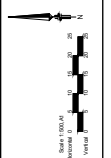

TITLEBLOCK with north point and scale bar

Template example of a rural lot development landscape plan



SECTION 4 COMMERCIAL DEVELOPMENTS



7. COMMERCIAL DEVELOPMENTS

7.1 Design Considerations

Commercial developments typically include landscape areas used by the public, such as entry forecourts and car parks. These typically interface with the broader public realm physically and visually.

Refer to Section 11 Recommended Plant Lists and Section 15 Materials and Techniques for further information on plant species, design and specification of landscape works.

Key landscape design elements to be considered are outlined below.

GENERAL

- ▶ Landscape treatments are to address the visual bulk and scale of the development such as with tree and garden bed planting or green walls.

STREETSCAPE/PROPERTY INTERFACES

- ▶ Consider appropriate width areas for garden bed and verge width for tree planting – minimum 2.1m wide and wider where large trees are to be used.
- ▶ Soften visual impact of blank walls and blur hard edges/lines with garden bed and tree planting of appropriate scale.
- ▶ Soften street interfaces and adjoining properties through tree and garden planting and appropriate fence treatments (where fencing is required).
- ▶ Define pedestrian access from streets into commercial developments via connecting pathways, including through car parks.

GARDEN BEDS

- ▶ Appropriate size and location for visual effect, success of planting and ease of maintenance (minimal traffic management plans).
- ▶ Species selection that promotes native plants for drought tolerance, suitability to site, micro-climate, purpose (screening, ornamental, personal safety).
- ▶ Layout of species for variety, visual impact and cohesive themes.
- ▶ Appropriate edge treatments, soils and mulch.
- ▶ Irrigation for planting establishment and on-going longevity.

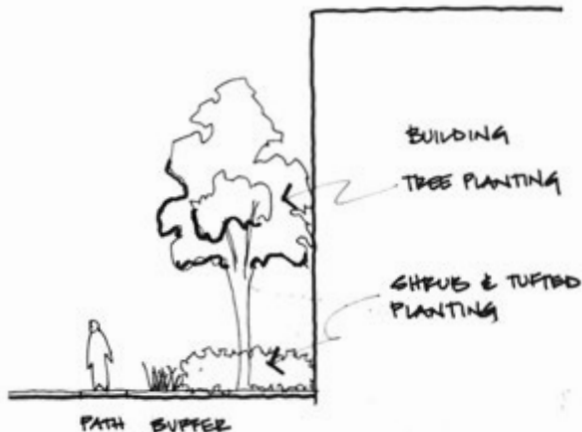

Boundary planting sketch showing tree and garden planting to soften interface

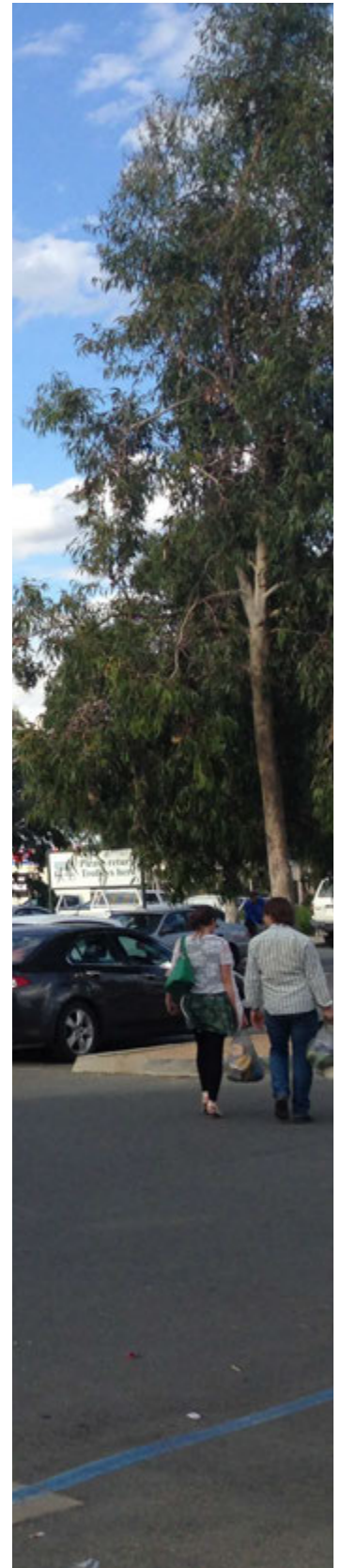

CAR PARKS

- ▶ Tree planting throughout car parks to achieve maximum shade and amenity.
- ▶ Tree species for car parks are to be determined according to locality, aspect, microclimate and other considerations such as local character.
- ▶ Full mature tree canopy size to be shown.
- ▶ Planting areas of appropriate width (minimum 2.1m) where car parks interface with streets/road reserves and buildings.
- ▶ Ensure success of planting areas by not allowing vehicle overhang to burn/damage planting – use permeable paving or mulch only beneath vehicle overhang area.
- ▶ Use wheel stops or bollards in parking bays to mitigate damage to planted areas from front vehicle overhang.
- ▶ Incorporate best practice Water Sensitive Urban Design (WSUD) including passive watering of trees throughout car park.
- ▶ Pedestrian access and safety through car parks via connecting pathways and appropriate line marking.
- ▶ Surface treatments to be permeable paving where appropriate.
- ▶ Minimum garden bed width to be 2.0m wide.



Car park sketch showing no planting beneath vehicle overhang



Car park sketch showing wheel stop and planting



Car park sketch showing wheel stop with central swale tree and garden planting



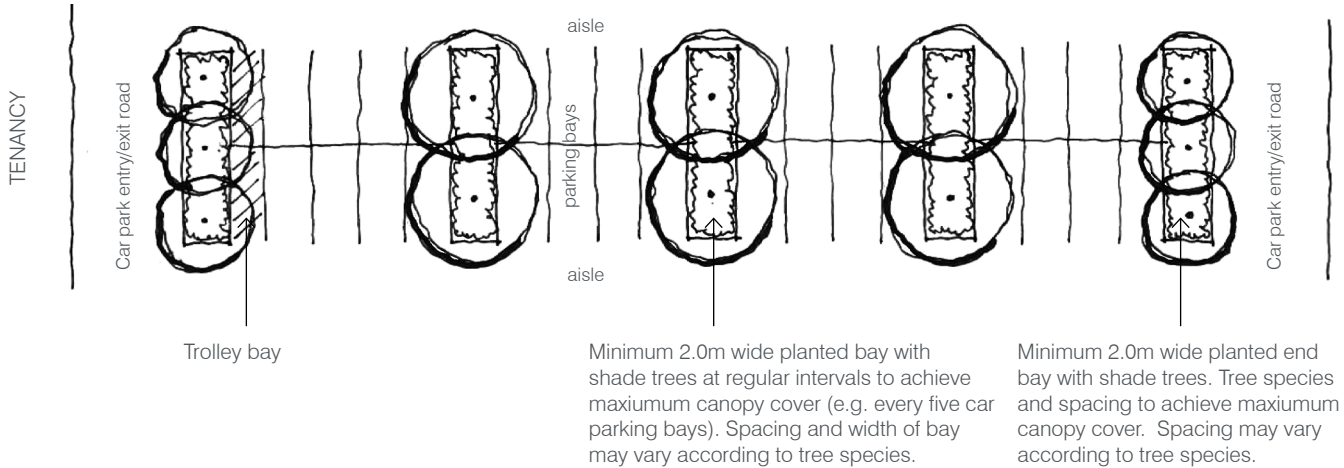

Car park with planted end bay and planted bays at regular intervals

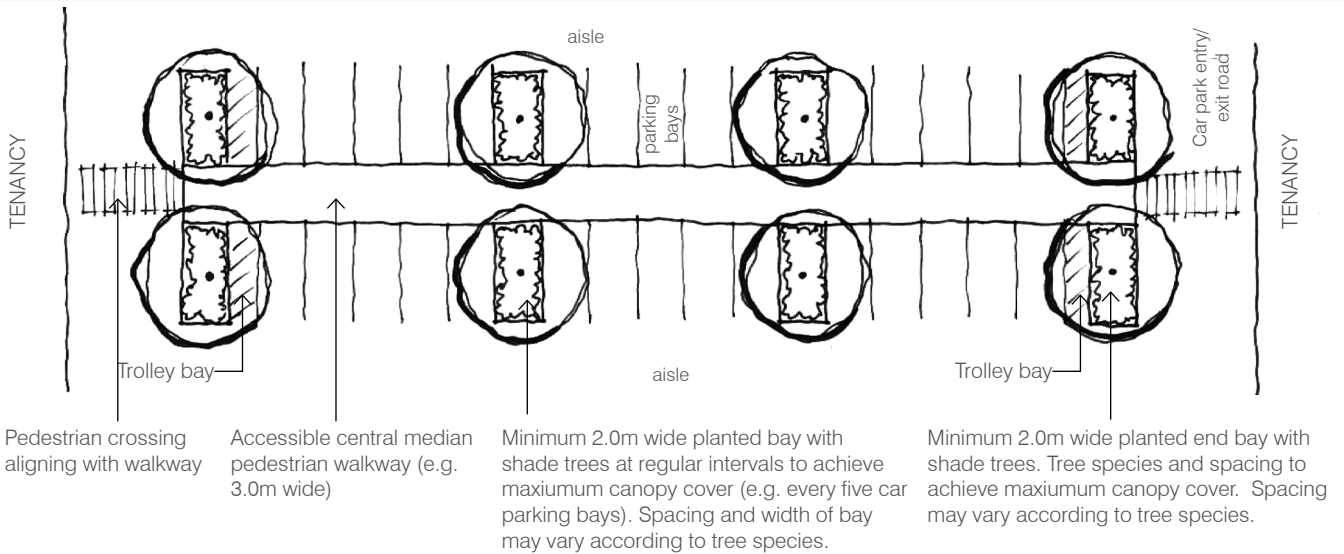

Car park with central walkway including tree planting in paving at regular intervals

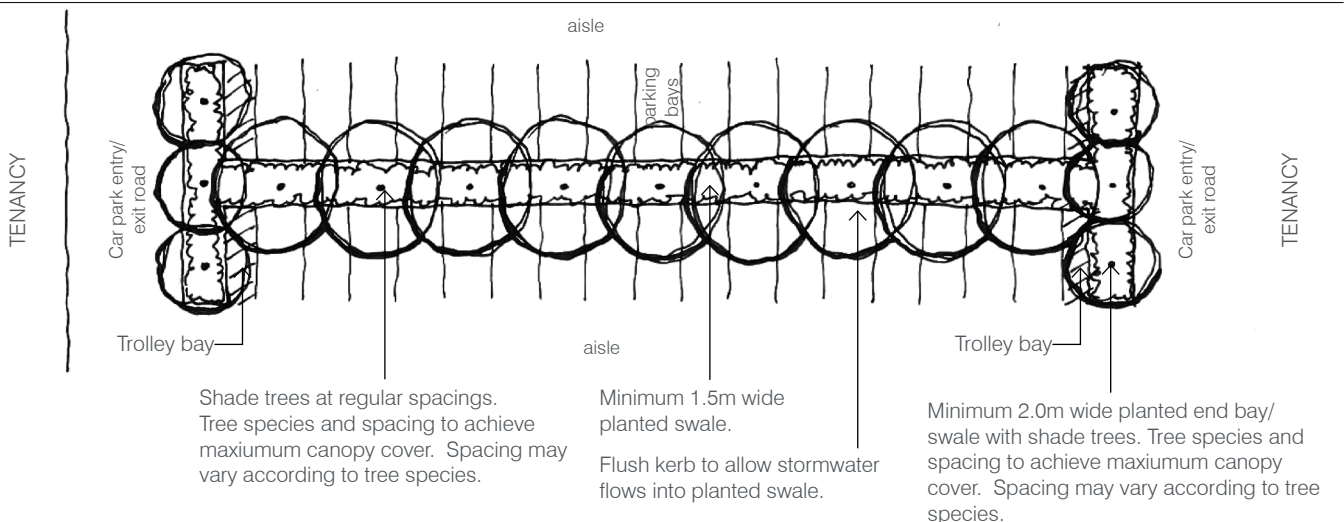

Car park with flush kerb, central planted swale and wheel stops

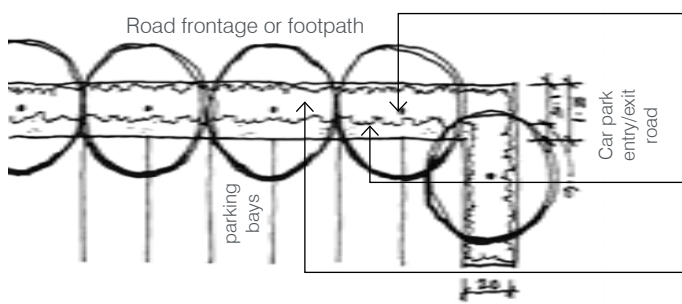

Shade trees at regular spacings. Tree species and spacing to achieve maximum canopy cover. Spacing may vary according to tree species.

600mm wide no planting zone to allow for vehicle overhang (apply to all barrier kerbs).

Minimum 2.1m wide garden bed interface to road reserve/street frontage.

Car park with barrier kerb and planting area to street frontage

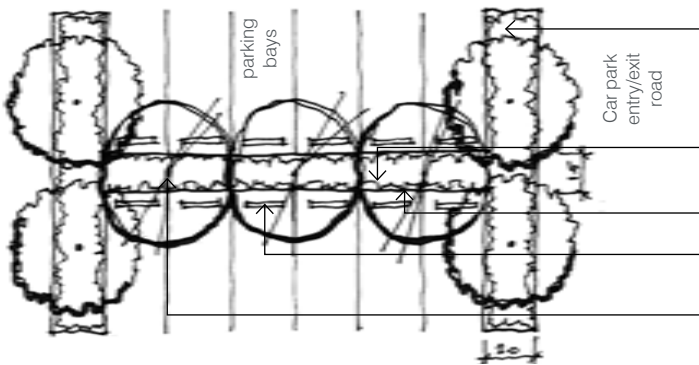

Minimum 2.0m wide planted end bay with shade trees. Tree species and spacing to achieve maximum canopy cover. Spacing may vary according to tree species.

Minimum 1.5m wide planted swale.

Flush kerb to allow stormwater flows into planted swale.

Wheel stops.

Shade trees at regular spacings. Tree species and spacing to achieve maximum canopy cover. Spacing may vary according to tree species.

Car park with flush kerb, central planted swale and wheel stops

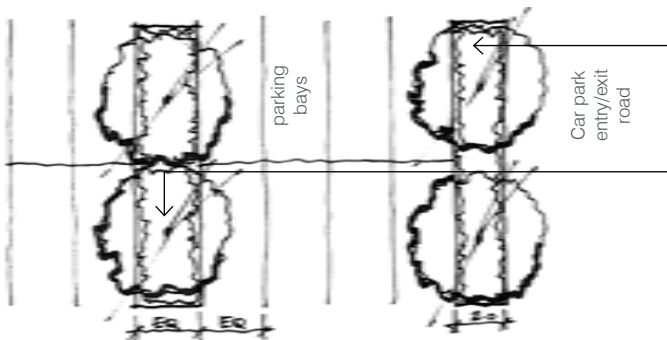

Minimum 2.0m wide planted end bay with shade trees. Tree species and spacing to achieve maximum canopy cover. Spacing may vary according to tree species.

Minimum 2.0m wide planted bay with shade trees at regular intervals to achieve maximum canopy cover (e.g. every five car parking bays). Spacing and width of bay may vary according to tree species.

Car park with planted end bay and planted bays at regular intervals

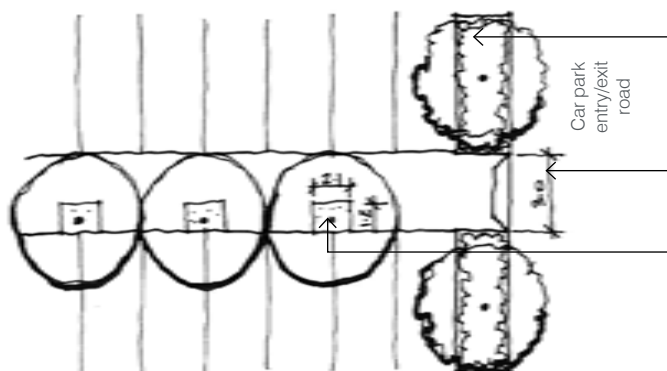

Minimum 2.0m wide planted end bay with shade trees. Tree species and spacing to achieve maximum canopy cover. Spacing may vary according to tree species.

Suggested 3.0m wide pedestrian access through carpark including shade trees in paving.

Shade trees in paving cut outs (e.g. 1.5m x 1.2m). Tree species and spacing is to achieve maximum canopy cover. Spacing may vary according to tree species.

Car park with central walkway including tree planting in paving at regular intervals

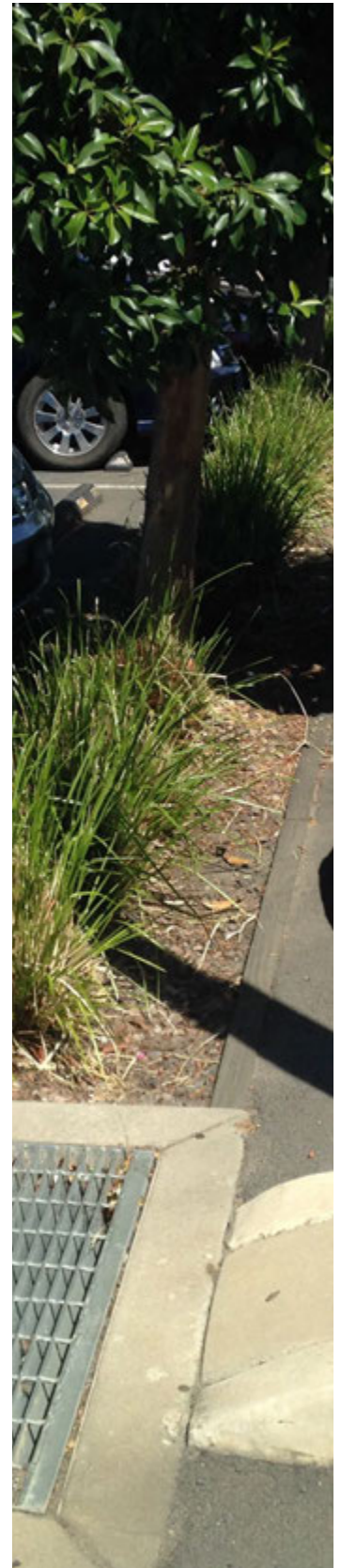

7.2 Approvals Process

The following outlines the general approval process for commercial development landscape proposals.

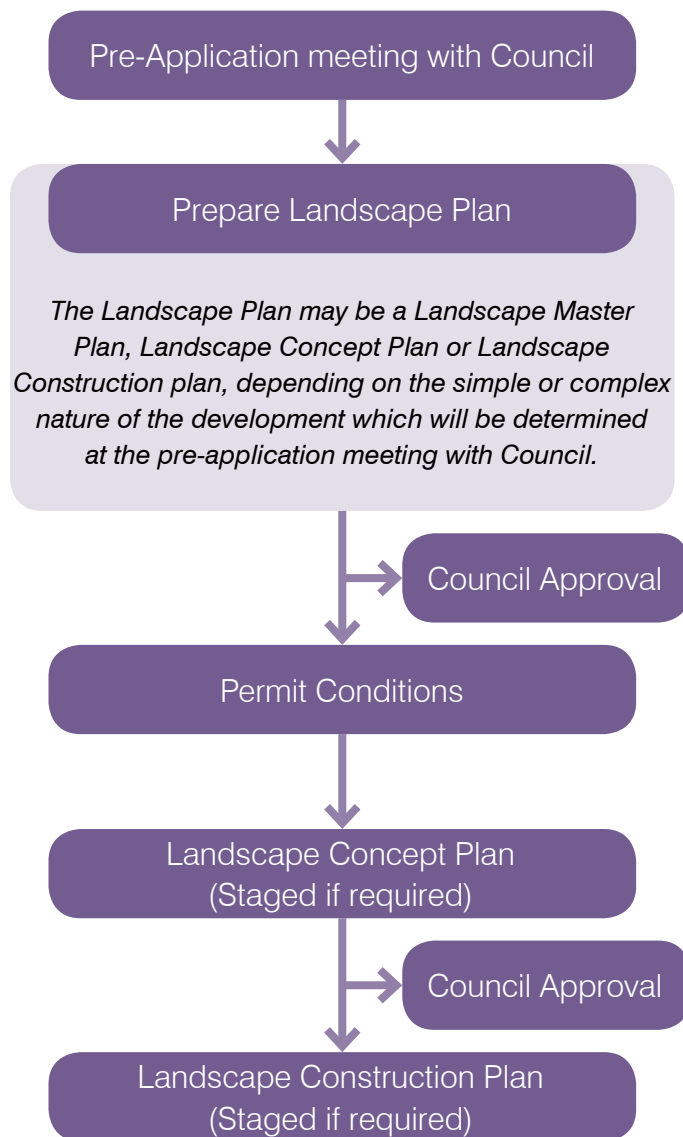

7.3 Landscape Plan Requirements

The following describes Council's expectations relating to the range of landscape plans and construction works required by the design and approvals processes defined above.

The requirements for landscape plans will vary depending on the level of detail required by the landscape proposals, including the size and cost of the works.

Council recommends the applicant employ a qualified landscape architect, landscape designer or horticulturist to prepare or assist with developing the required landscape plans. Ideally, the landscape architect/designer shall be commissioned early in the design process to ensure that all landscape related issues are considered.

LANDSCAPE MASTER PLAN

A Landscape Master Plan is a review of the site that includes relevant landscape design and maintenance considerations sufficient to demonstrate an understanding of the proposed development and provide an adequate basis for the production of concept designs. Landscape Master Plans may be drawn and/or written.

Site Analysis

A site analysis plan shall be prepared as the first step in the master planning process and include such things as the following:

- ▶ Photographs of existing conditions and any key features.
- ▶ Existing conditions including landscape characteristics, topographical information, existing native and exotic vegetation, views to and from the site, micro-climate (such as wind and sun), overland flows and water courses.
- ▶ Pedestrian and vehicular access.
- ▶ Solar access, orientation and noise sources.
- ▶ Fences, boundaries and easements.
- ▶ Proximity of, connection and access to public open space.
- ▶ Surrounding neighbourhood character (built form and landscape character) such as residential areas, play areas and outdoor activities, buffer zones, screening, public and private areas, security, passive surveillance and landmark elements.
- ▶ Heritage acknowledgments.

Site Layout

The site layout should be based on the site analysis and be determined in conjunction with other professionals including engineers, planners and urban designers.

Planting

Planting design at the Landscape Master Plan stage should include the following:

- ▶ Layout of proposed planting, including indicative locations of proposed trees and areas of proposed garden bed planting.
- ▶ A recommended plant schedule for proposed trees, shrubs, tufted plants and groundcovers in accordance with the approved planting lists.



- ▶ Planting themes to ensure a cohesive landscape outcome.
- ▶ Protection and enhancement of existing vegetation which is to be retained.

Water Sensitive Urban Design

The Landscape Master Plan is to demonstrate the ways in which the proposed design treats water including:

- ▶ Stormwater treatment and/or retention.
- ▶ Reuse of captured stormwater.
- ▶ Grey water systems.

Materials and Finishes

Materials and finishes should be described in the Master Plan and where appropriate are to be in line with Landscape Standards – Materials and Techniques as described in the Landscape Plan Guide.

Community art

Inclusion of appropriate public art opportunities should be considered.

LANDSCAPE CONCEPT PLAN (STAGED IF REQUIRED)

The Landscape Concept Plan is a clearly resolved landscape design, traceable to the Landscape Master Plan and where relevant, based on defined engineering and architectural proposals. Landscape Concept Plans should be to scale and show proposed hard and soft materials to an extent appropriate to review, discussion and approval, but not in sufficient detail to enable construction.

A Landscape Concept Plan for each stage of development must be prepared according to the design and approval process. Plans may be prepared separately according to stages.

The Concept Plan must be drawn to scale.

The Landscape Concept Plan should show:

- ▶ Existing vegetation to be retained (a tree assessment and management plan may be required).
- ▶ Existing vegetation to be removed (a tree assessment may be required).
- ▶ The proposed quantity and location of landscape elements in all proposed open space and streetscape embellishments which comprise the landscape works. This includes elements such as tree planting, garden beds, pathways, seating, shelters, picnic facilities, boardwalks, signage, drinking fountains, rubbish receptacles, irrigation systems, playgrounds, artwork, retaining walls, protective fencing (temporary and permanent), vehicle control methods, wetlands, ornamental water bodies and so on.
- ▶ Areas to be managed and rehabilitated for conservation or offset planting purposes and the method by which these areas will be protected.



Car park shade tree planting

CONSTRUCTION DOCUMENTATION PLANS (STAGED IF REQUIRED)

Landscape Construction Documentation Plans are precise plans, schedules and specifications, clearly traceable to the Landscape Concept Plan and based on final engineering and architectural proposals. The plans are sufficient to control the construction of the landscape works and are appropriate for review, discussion and approval.

Construction Plans for each stage of development must be prepared according to the approval process. Plans may be prepared separately according to stages.

The construction plans are to be drawn to scale.

The following is to be included in the Construction Documentation plans and must be submitted to Council for approval prior to construction.

Existing Conditions

All existing site conditions and information including buildings, services, roads, footpaths and vegetation.

Demolition

All existing site features that are to be removed as part of the landscape construction including removal of any vegetation.

Grading and Drainage

Proposed contours and finished levels of the works. This should include falls and drainage associated with the new landscape design.

Setout

The proposed layout of the landscape design with accurate descriptions and dimensions of the proposed elements sufficient for construction of the works. Existing and proposed utility services must be shown on the plans.

Materials & Finishes

The materials and finishes of all proposed hard & soft landscape treatments, including furniture types, any colours and or themes for the hard and soft landscape.

Planting

The type and location of the planting included in the works including botanical and common names of proposed plant species, mature height and installation size, location and quantity.

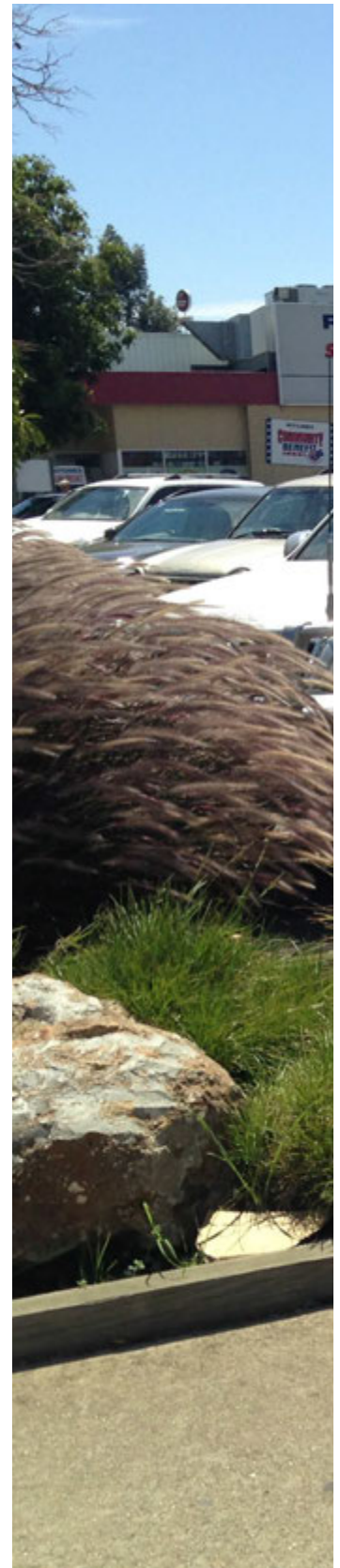

Irrigation

The location, type and performance of the proposed irrigation system. This may be prepared by the Contractor as a 'Design and Construct' irrigation system.

Elevation / Sections

The vertical and horizontal relationships of the design in the form of scaled elevations and or sections. The elevations and sections are to demonstrate how the works are to look and are to be drawn from relevant and key locations across the works.

Construction Details

Construction Details are a combination of plans, sections and elevations at varying scales (for example 1:10, 1:20, 1:50) which clearly describe the construction intent and requirements of the hard and soft landscape works.

Landscape Specifications (when required)

The Specification describes the requirements for construction and installation of the works, Completion, Maintenance and any Handover obligations (where required).

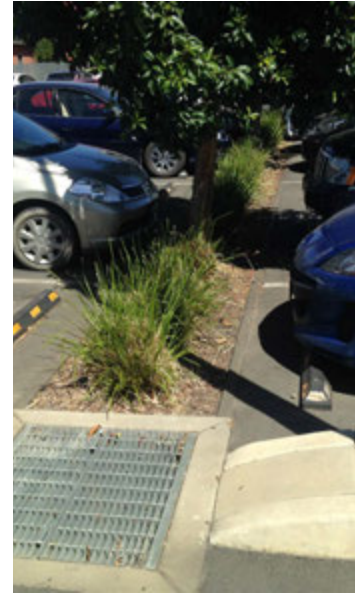

WSUD to car park medians including wheel stops

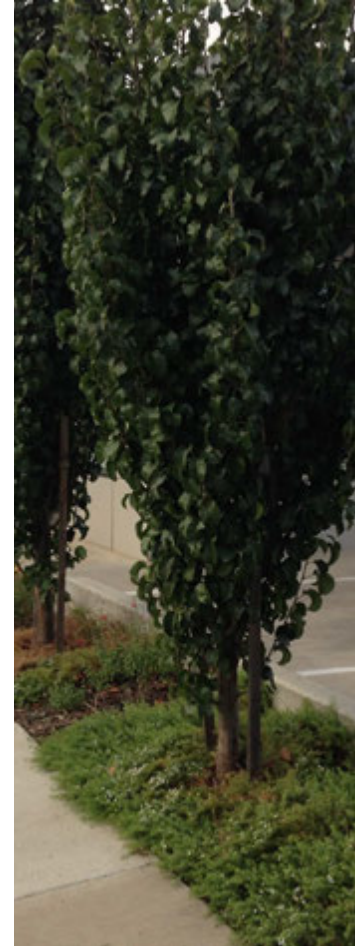

Tree and garden bed planting in narrow car park area

MAINTENANCE / ESTABLISHMENT PLAN

The Maintenance or Establishment Plan or Program may be required to be submitted to Council for approval with the Construction Documentation.

Any Maintenance Plan requirements will be provided by Council and may include the obligations and requirements for the maintenance of the hard and soft landscape works such as the following:

- ▶ Weeding & Rubbish Removal.
- ▶ Replacement Plants.
- ▶ Stakes & Ties.
- ▶ Grass.
- ▶ Pruning.
- ▶ Mulch.
- ▶ Fertiliser.
- ▶ Remnant Vegetation maintenance.

7.4 Landscape Plan Submissions

Landscape Plans shall be produced according to the following minimum standards.

- ▶ Scale appropriate to the size of the site and nature of development to adequately describe the landscape proposal.
- ▶ Large sites may be scale 1:500 or 1:200 and smaller sites 1:100 or 1:50.
- ▶ Construction Details are to be generally 1:20 or 1:10.

PRESENTATION

- ▶ Landscape Master Plans and Landscape Concept Plans
1 x coloured plan and 2 x black and white plans.
- ▶ Landscape Construction Documentation Plans
3 x black and white plans
- ▶ Neatly printed, legible and supported by relevant documentation.
- ▶ Accurate location of existing and proposed site features.
- ▶ Include legend, titleblock, scale and scale bar, and north point.
- ▶ Include plant schedule of proposed trees, shrubs, grasses and groundcover species.



Suitable shade trees in car park median



Town Centre with seating, tree planting, paving and green space

7.5 Landscape Plan Templates/Examples



Template example of commercial development landscape master plan



RECOMMENDED PLANT SCHEDULE

| Large Evergreen Trees | | | |
|--------------------------------------------|-------------------------|------------------|--------------|
| Botanical name | Common Name | Mature h x w (m) | Approx total |
| <i>Corymba citrifolia</i> | Lemon-scented gum | 20 x 8 | 30 |
| <i>Excoecaria agallocha</i> | Grey Box | 25 x 8 | 7 |
| <i>Excoecaria agallocha</i> | Yellow Box | 25 x 8 | 6 |
| Small Evergreen Tree | | | |
| Botanical name | Common Name | Mature h x w (m) | Approx total |
| <i>Gyneria parviflora</i> | Whigs | 10 x 5 | 37 |
| Deciduous Tree | | | |
| Botanical name | Common Name | Mature h x w (m) | Approx total |
| <i>Ulmus parviflora - 'Toad'</i> | Chinese Elm | 10 x 11 | 41 |
| Small Shrubs | | | |
| Botanical name | Common Name | Mature h x w (m) | Approx total |
| <i>Callistemon seberi</i> | River Bottlebrush | 1 x 1 | 100 |
| <i>Grevillea roosemiffolia</i> | Rosemary Grevillea | 1 x 1 | 400 |
| <i>Grevillea roosemiffolia</i> | Rosemary Grevillea | 1 x 1 | 400 |
| <i>Navolina Obesection</i> | Navolina Obesection | 1 x 1 | 400 |
| <i>Acrocomia ciliata</i> | Fringed Heath Myrtle | 0.6 x 1 | 450 |
| Groundcover & Tufting plants | | | |
| Botanical name | Common Name | Mature h x w (m) | Approx total |
| <i>Dioscorea revivida</i> | Black amber-flax lily | 1 x 1.5 | 200 |
| <i>Grevillea 'Poinsettia Royal Mantle'</i> | Poinsettia Royal Mantle | 0.2 x 3 | 100 |
| <i>Myopodium parvifolium</i> | Creeping Boobialla | 0.15 x 1 | 220 |
| Rainforest | | | |
| Botanical name | Common Name | Mature h x w (m) | Approx total |
| <i>Colocleptopholus betulae</i> | Milly Beauty-heads | 0.20 x 0.50 | 100 |
| <i>Zinnia opposita</i> | Tall Sedge | 1 x 1 | 70 |
| <i>Leptocarpus tenax</i> | Lepton Buri | 1 x 1 | 70 |
| <i>Leptocarpus tenax</i> | Lepton Buri | 1 x 1 | 70 |
| <i>Leptocarpus tenax</i> | Lepton Buri | 1 x 1 | 70 |
| <i>Leptocarpus tenax</i> | Lepton Buri | 1 x 1 | 70 |
| <i>Leptocarpus tenax</i> | Lepton Buri | 1 x 1 | 70 |
| Screen Planting | | | |
| Botanical name | Common Name | Mature h x w (m) | Approx total |
| <i>Grevillea roosemiffolia</i> | Rosemary Grevillea | 3 x 2 | 80 |
| <i>Grevillea 'Nack Kelly'</i> | Grevillea Nack Kelly | 3 x 2 | 80 |
| <i>Grevillea 'Moonlight'</i> | Grevillea Moonlight | 2 x 2 | 80 |

Large feature trees for canopy shade and to soften building interfaces

Small hardy native shrubs to give a human scale and soften landscape

Small trees provide shade and human scale to pathways

Median planting to soften visual impact of road space

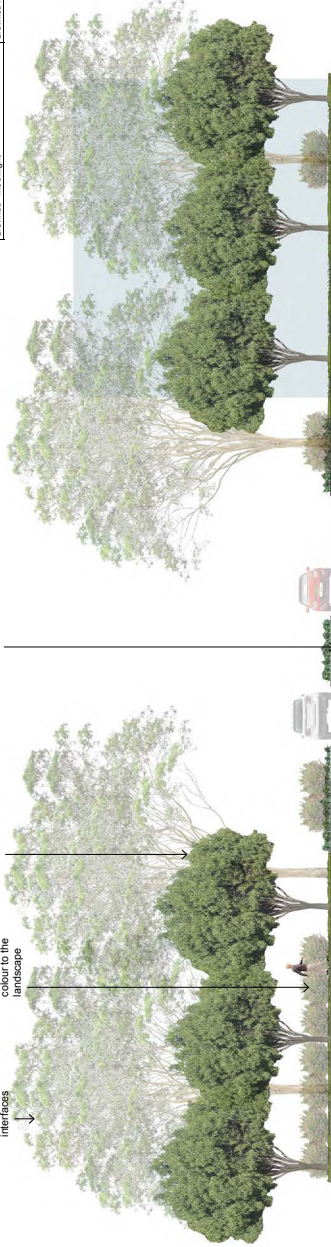

SECTION A - A - 1:200@A3



| | | | | | |
|--------------|-----|------|--------|------|--------|
| DESIGN NO. | REV | DATE | DESIGN | DATE | DESIGN |
| 123456 LUPPI | .. | .. | .. | .. | .. |

**LANDSCAPE MASTER PLAN
PLANT MATERIALS AND ELEVATION**

LOGO

Template example of commercial development landscape master plan elevation and plant schedule with images

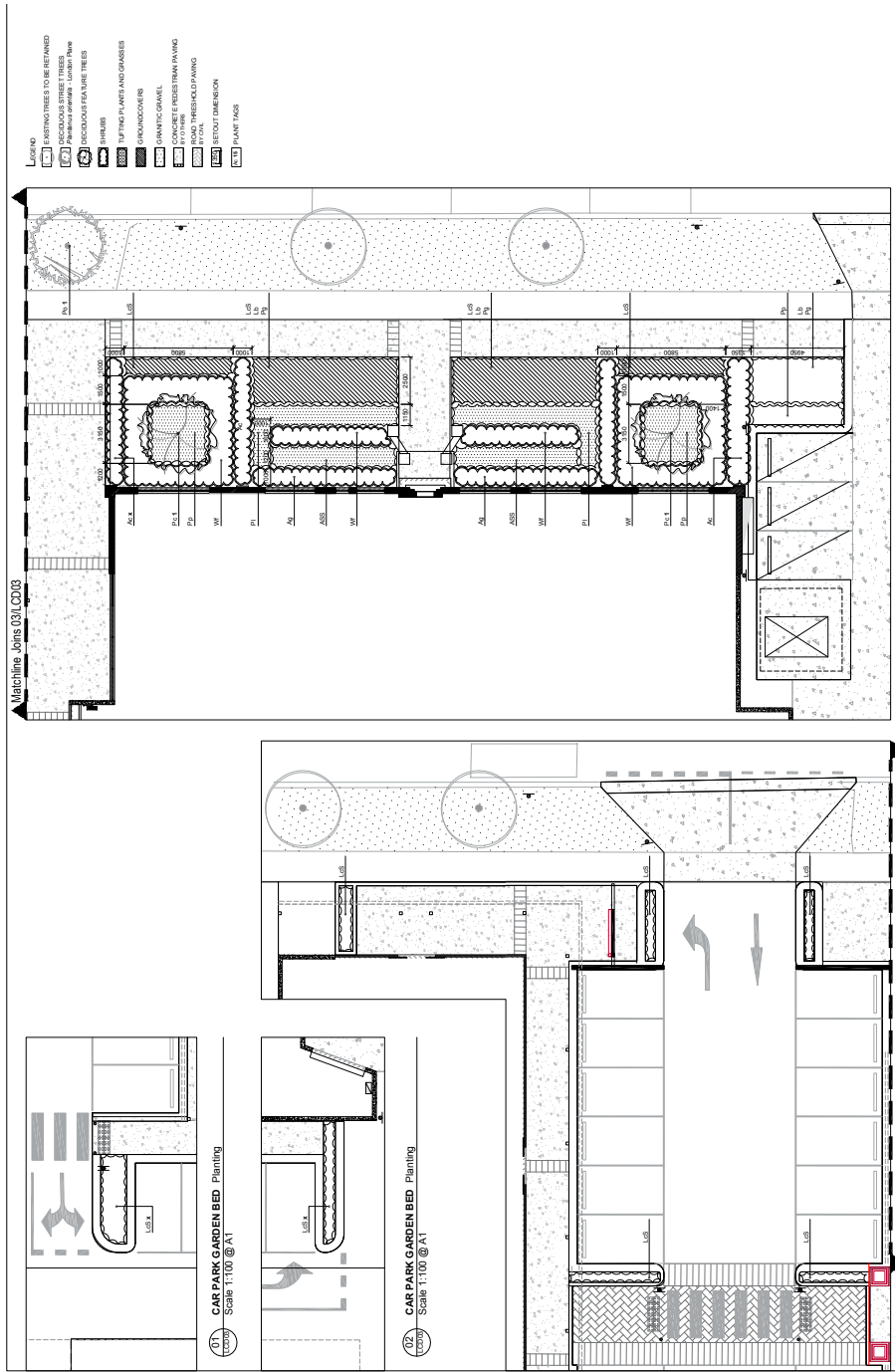

PROJECT TITLE LOGO
 PLAN TYPE | PROJECT LOCATION

Drawing Number: 123456 000
 Revision Date: 01 01/01/2001
 Sheet: 01 of 01
 Drawn by: Person 1
 Checked by: Person 2



Template example of commercial development landscape planting plan



SECTION 5 INDUSTRIAL DEVELOPMENTS

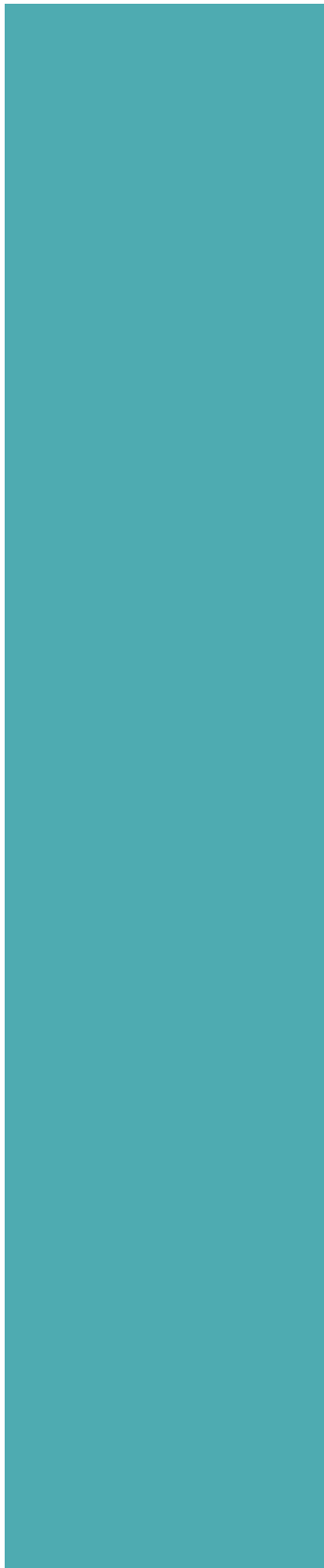

8. INDUSTRIAL DEVELOPMENTS

8.1 Design Considerations

Industrial developments typically include landscape areas within the property boundary. These may include around buildings, car park areas and boundary treatments to adjacent land uses. These landscape areas impact the public realm visually.

Refer to Section 11 Recommended Plant Lists and Section 15 Materials and Techniques for further information on plant species, design and specification of landscape works.

Key landscape design elements to be considered are outlined below.

GENERAL

- ▶ Landscape treatments are to address the visual bulk and scale of the development such as with tree and garden bed planting, grassed areas and/or green walls.

STREETSCAPE/PROPERTY INTERFACES

- ▶ Include appropriate width areas for garden bed and tree planting – minimum 2.1m wide and wider where large trees are to be used.
- ▶ Soften visual impact of blank walls with garden bed and tree planting of appropriate scale.
- ▶ Soften interfaces with streets and adjoining properties through tree and garden planting and visually appealing fence treatments (where fencing is required).
- ▶ Combine fence treatments with soft landscape treatments for maximum visual effect.
- ▶ Define pedestrian access from streets into industrial developments via connecting pathways, including through car parks.

GARDEN BEDS

- ▶ Appropriate size and location for visual effect, success of planting and ease of maintenance.
- ▶ Species selection that promotes native plants for drought tolerance, suitability to site, micro-climate, purpose (screening, ornamental, personal safety).
- ▶ Layout of species for variety, visual impact and cohesive themes. Appropriate edge treatments, soils and mulch.
- ▶ Irrigation for planting establishment and on-going longevity.

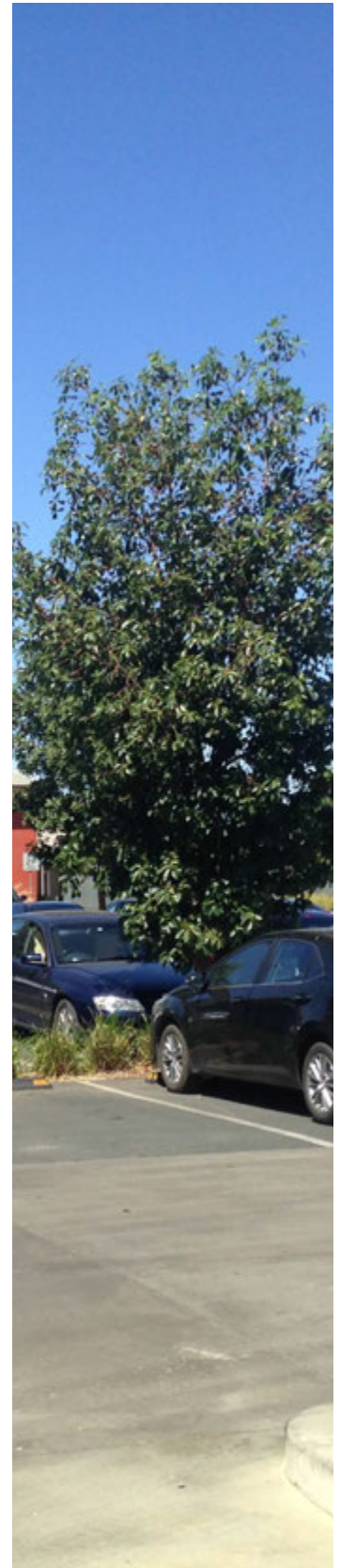

CAR PARKS

- ▶ Tree planting throughout car parks to achieve maximum shade and amenity.
- ▶ Tree species for car parks are to be determined according to locality, aspect, microclimate and other considerations such as local character.
- ▶ Full mature tree canopy size to be shown.
- ▶ Planting areas of appropriate width (minimum 2.0m wide) where car parks interface with streets and buildings.
- ▶ Ensure success of planting areas by not allowing vehicle overhang to burn/damage planting.
- ▶ Use wheel stops in parking bays to mitigate vehicle damage to planted areas.
- ▶ Incorporate best practice Water Sensitive Urban Design (WSUD).
- ▶ Pedestrian access and safety through car parks via connecting pathways.
- ▶ Soften visual impact of large expanses of hardstand (for example loading bays) with adjoining suitable garden bed and tree planting.
- ▶ Surface treatments to be permeable where appropriate.



Car park sketch showing no planting beneath vehicle overhang

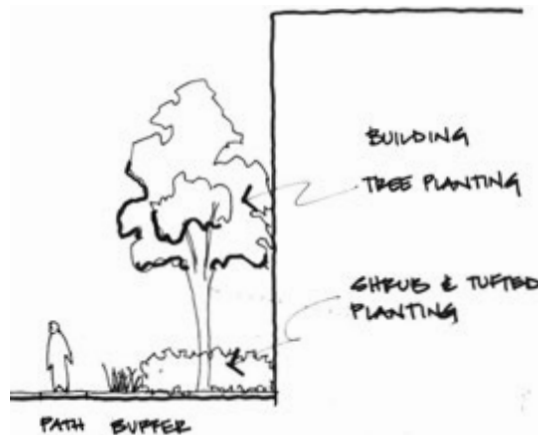

Boundary planting sketch showing tree and garden planting to soften interface



Car park sketch showing wheel stop and planting

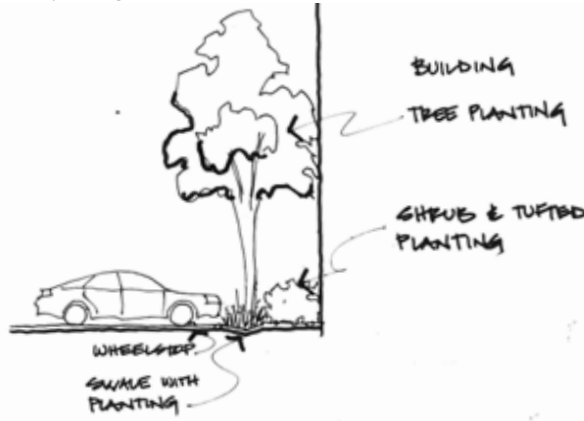

Car park sketch showing wheel stop with swale including tree and garden planting adjacent building



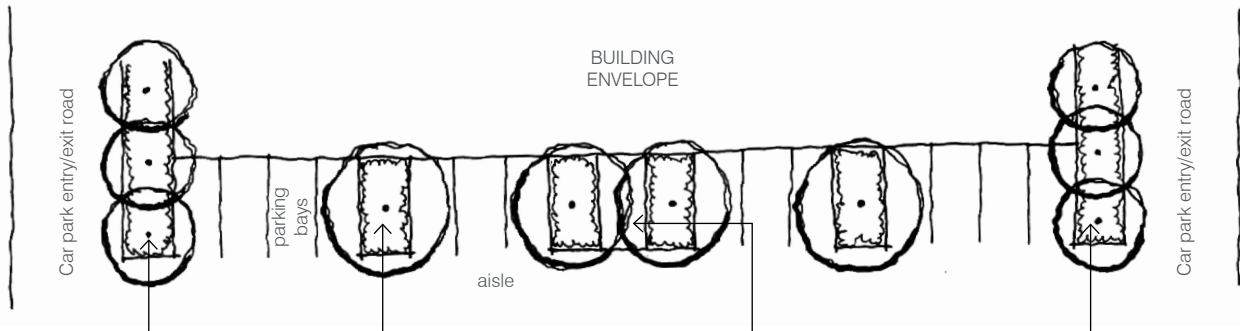

Minimum 2.0m wide planted bay at end of parking aisle/building with garden bed planting and trees. Width of bay may vary.

Minimum 2.0m wide planted bay with shade trees at regular intervals to achieve maximum canopy cover (e.g. every five car parking bays). Spacing and width of bay may vary.

Pedestrian access to building area. Consider planting adjacent pedestrian access.

Minimum 2.0m wide planted bay at end of parking aisle/building with garden bed planting and trees. Width of bay may vary.

Car park with planted end bays adjacent building and planted bays at regular intervals including trees

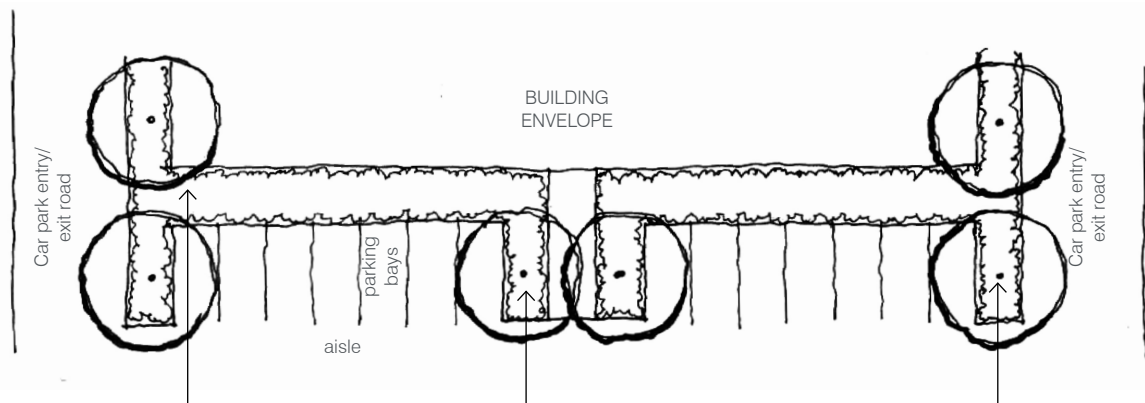

Minimum 1.5m wide planted swale or garden bed adjacent building.

Minimum 2.0m wide planted bay with shade trees at regular intervals and/or adjacent pedestrian access to achieve maximum canopy cover (e.g. every five car parking bays). Spacing and width of bay may vary.

Minimum 2.0m wide planted end bay/planting adjacent building with shade trees. Tree species and spacing to achieve maximum canopy cover. Spacing may vary according to tree species.

Car park with planted area adjacent building and planted bays at regular intervals including trees

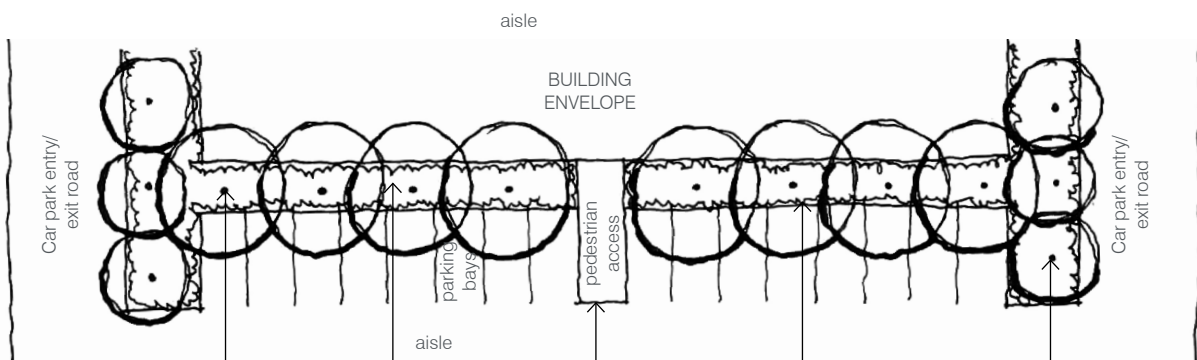

Trees at regular spacings adjacent building. Tree species and spacing may vary.

Minimum 1.5m wide planted swale or garden bed adjacent building.

Pedestrian access to building area.

Minimum 2.0m wide planted end bay/swale adjacent building. Tree species and spacing may vary.

Flush kerb to allow stormwater flows into planted swale.

Car park with wheel stops, flush kerb and planting area/swale to building frontage

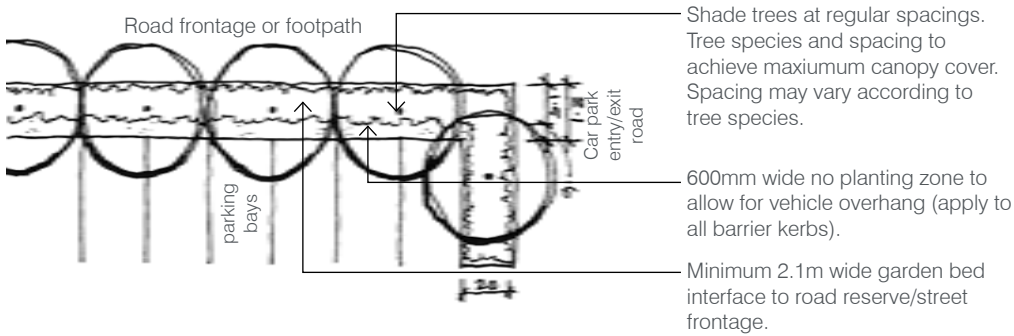

Shade trees at regular spacings. Tree species and spacing to achieve maximum canopy cover. Spacing may vary according to tree species.

600mm wide no planting zone to allow for vehicle overhang (apply to all barrier kerbs).

Minimum 2.1m wide garden bed interface to road reserve/street frontage.

Car park with barrier kerb and planting area to street frontage

Note: Building envelope and car park size and interface may vary and each site shall be considered to achieve best practice design.

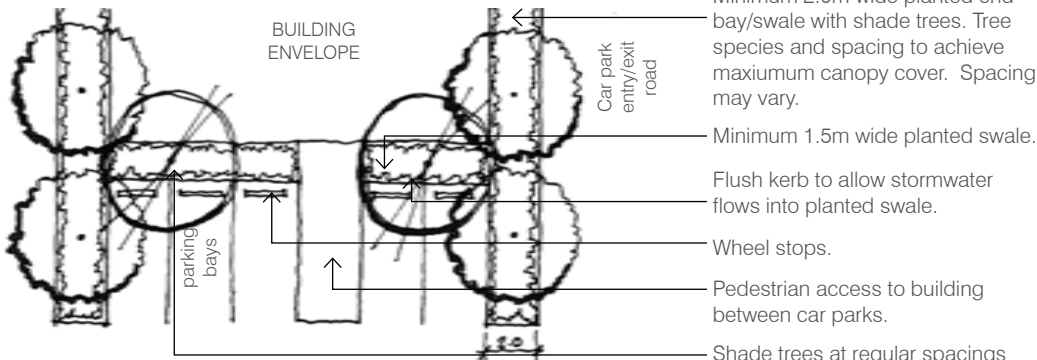

Minimum 2.0m wide planted end bay/swale with shade trees. Tree species and spacing to achieve maximum canopy cover. Spacing may vary.

Minimum 1.5m wide planted swale.

Flush kerb to allow stormwater flows into planted swale.

Wheel stops.

Pedestrian access to building between car parks.

Shade trees at regular spacings along building frontage. Tree species and spacing may vary.

Car park with flush kerb, central planted swale and wheel stops

Note: Building envelope and car park size and interface may vary and each site shall be considered to achieve best practice design.

Minimum 2.0m wide planted end bay with shade trees. Tree species and spacing to achieve maximum canopy cover. Spacing may vary according to tree species.

Minimum 2.0m wide planted bay with shade trees at regular intervals to achieve maximum canopy cover (e.g. every five car parking bays). Spacing and width of bay may vary according to tree species.

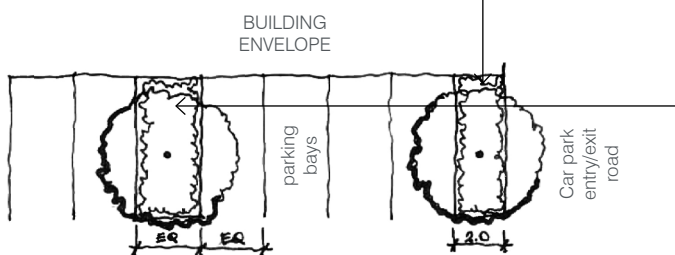

Car park with planted end bay and planted bays at regular intervals

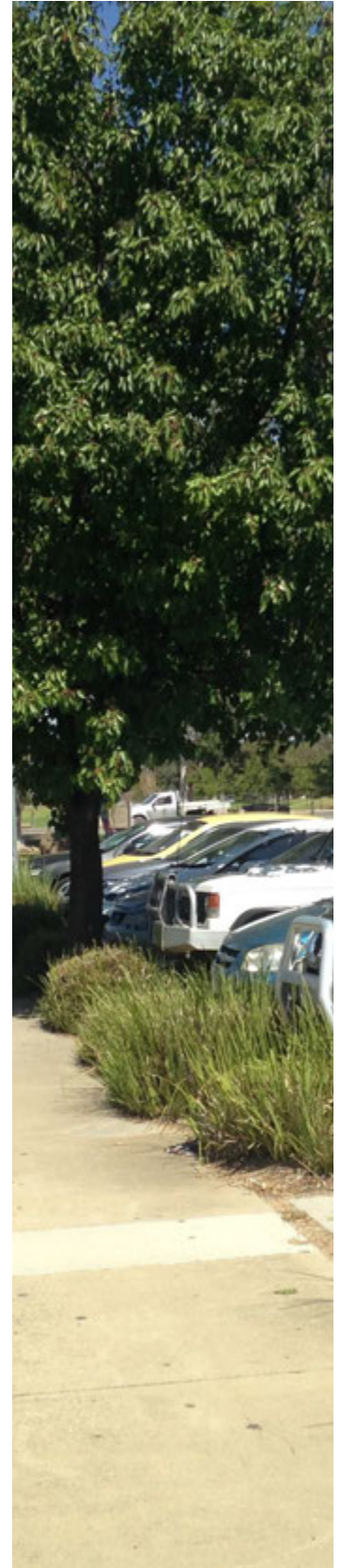

8.2 Approvals Process

The following outlines the approval process for industrial development landscape proposals.

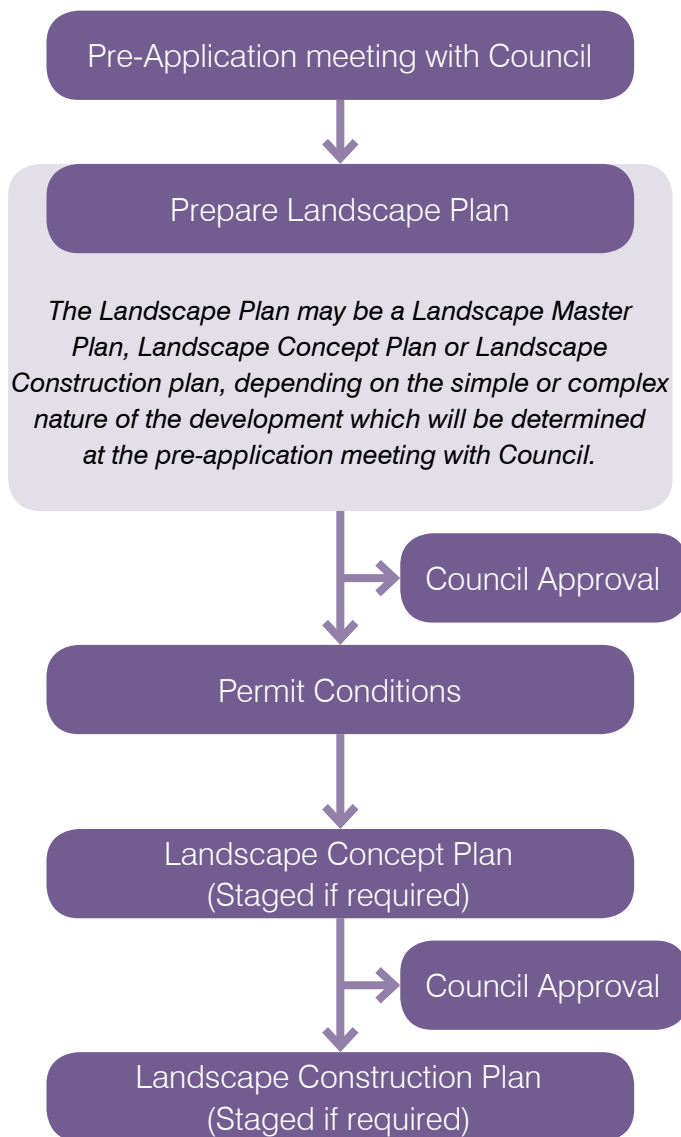

8.3 Landscape Plan Requirements

The following describes Council's expectations relating to the range of landscape plans and construction works required by the design and approvals processes defined above.

The requirements for landscape plans will vary depending on the level of detail required by the landscape proposals, including the size and cost of the works.

Council recommends the applicant employ a qualified landscape architect, landscape designer or horticulturist to prepare or assist with developing the required landscape plans. Ideally, the landscape architect/designer shall be commissioned early in the design process to ensure that all landscape related issues are considered.

LANDSCAPE MASTER PLAN

A Landscape Master Plan is a review of the site that includes relevant landscape design and maintenance considerations sufficient to demonstrate an understanding of the proposed development and provide an adequate basis for the production of concept designs. Landscape Master Plans may be drawn and/or written.

Site Analysis

A site analysis plan shall be prepared as the first step in the master planning process and include such things as the following:

- ▶ Photographs of existing conditions and any key features.
- ▶ Existing conditions including landscape characteristics, topographical information, existing native and exotic vegetation, views to and from the site, micro-climate (such as wind and sun), overland flows and watercourses.
- ▶ Pedestrian and vehicular access.
- ▶ Solar access, orientation and noise sources.
- ▶ Fences, boundaries and easements.
- ▶ Proximity of, connection and access to public open space.
- ▶ Surrounding neighbourhood character (built form and landscape character) such as residential areas, play areas and outdoor activities, buffer zones, screening, public and private areas, security, passive surveillance and landmark elements.
- ▶ Heritage acknowledgments.

Site Layout

The site layout should be based on the site analysis and be determined in conjunction with other professionals including engineers, planners and urban designers.

Planting

Planting design at the Landscape Master Plan stage should include the following:

- ▶ Layout of proposed planting, including indicative locations of proposed trees and areas of proposed garden bed planting.
- ▶ A recommended plant schedule for proposed trees, shrubs, tufted plants and groundcovers in accordance with the approved planting lists.

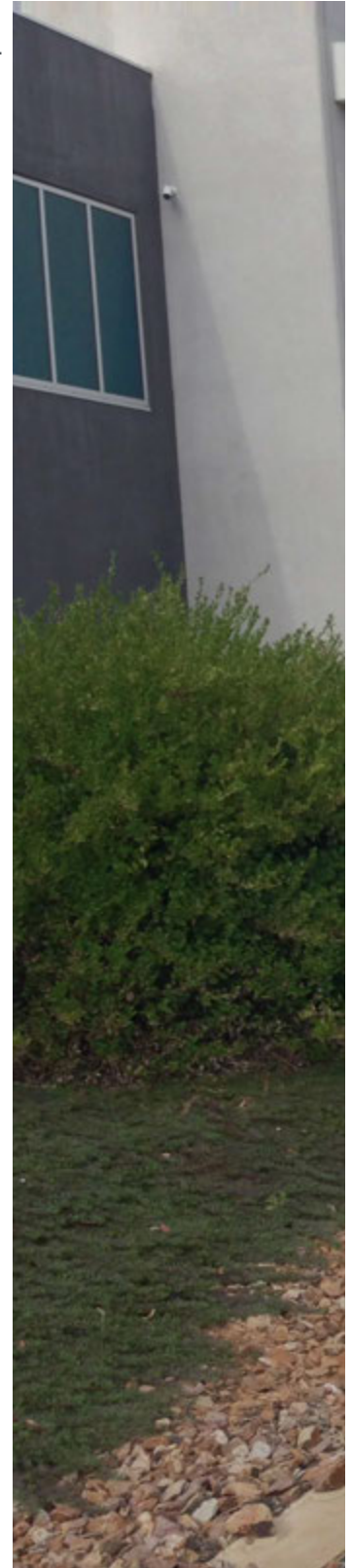

- ▶ Planting themes to ensure a cohesive landscape outcome.
- ▶ Protection and enhancement of existing vegetation which is to be retained.

Water Sensitive Urban Design

The Landscape Master Plan is to demonstrate the ways in which the proposed design treats water including:

- ▶ Stormwater treatment and/or retention.
- ▶ Reuse of captured stormwater.
- ▶ Grey water systems.

Materials and Finishes

Materials and finishes are to be in line with Landscape Standards – Materials and Techniques as described in this document.

LANDSCAPE CONCEPT PLAN (STAGED IF REQUIRED)

The Landscape Concept Plan is a clearly resolved landscape design, traceable to the Landscape Master Plan and where relevant, based on defined engineering and architectural proposals. Landscape Concept Plans should be to scale and show proposed hard and soft materials to an extent appropriate to review, discussion and approval, but not in sufficient detail to enable construction.

A Landscape Concept Plan for each stage of development must be prepared according to the design and approval process. Plans may be prepared separately according to stages.

The Concept Plan must be drawn to scale.

The Landscape Concept Plan should show:

- ▶ Existing vegetation to be retained (a tree assessment and management plan may be required).
- ▶ Existing vegetation to be removed (a tree assessment may be required).
- ▶ The proposed quantity and location of landscape elements in the proposed development. This includes elements such as tree planting, garden beds, pathways, seating areas, shelters, signage, rubbish receptacles, irrigation systems, retaining walls, protective fencing (temporary and permanent), vehicle control methods, wetlands, ornamental water bodies and so on.
- ▶ Areas to be managed and rehabilitated for conservation or offset planting purposes and the method by which these areas will be protected.



Streetscape treatment including planting and WSUD



Shade trees and mass planting to car park interface

CONSTRUCTION DOCUMENTATION PLANS (STAGED IF REQUIRED)

Landscape Construction Documentation Plans are precise plans, schedules and specifications, clearly traceable to the Landscape Concept Plan and based on final engineering and architectural proposals. The plans are sufficient to control the construction of the landscape works and are appropriate for review, discussion and approval.

Construction Plans for each stage of development must be prepared according to the approval process. Plans may be prepared separately according to stages.

The construction plans are to be drawn to scale.

The following is to be included in the Construction Documentation plans and must be submitted to Council for approval prior to construction.

Existing Conditions

All existing site conditions and information including buildings, services, roads, footpaths and vegetation.

Demolition

All existing site features that are to be removed as part of the landscape construction including removal of any vegetation.

Grading and Drainage

Proposed contours and finished levels of the works. This should include falls and drainage associated with the new landscape design.

Setout

The proposed layout of the landscape design with accurate descriptions and dimensions of the proposed elements sufficient for construction of the works. Existing and proposed utility services must be shown on the plans.

Materials & Finishes

The materials and finishes of all proposed hard & soft landscape treatments, including furniture types, any colours and or themes for the hard and soft landscape.

Planting

The type and location of the planting included in the works including botanical and common names of proposed plant species, mature height and installation size, location and quantity.

Irrigation

The location, type and performance of the proposed irrigation system. This may be prepared by the Contractor as a 'Design and Construct' irrigation system.

Elevation / Sections

The vertical and horizontal relationships of the design in the form of scaled elevations and or sections. The elevations and sections are to demonstrate how the works are to look and are to be drawn from relevant and key locations across the works.

Construction Details

Construction Details are a combination of plans, sections and elevations at varying scales (for example 1:10, 1:20, 1:50) which clearly describe the construction intent and requirements of the hard and soft landscape works.

Landscape Specifications (when required)

The Specification describes the requirements for construction and installation of the works, Completion, Maintenance and Handover obligations (where relevant).



Plant species that work well with fencing

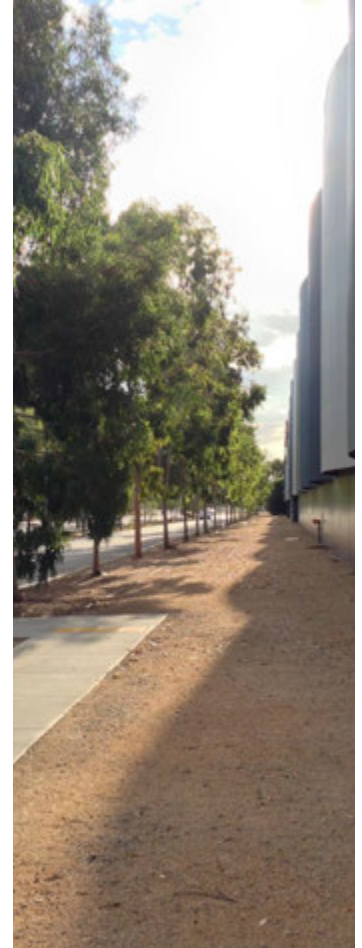

Appropriate scale tree planting to soften large walls

MAINTENANCE / ESTABLISHMENT PLAN

The Maintenance or Establishment Plan or Program may be required to be submitted to Council for approval with the Construction Documentation.

Any Maintenance Plan requirements will be provided by Council and may include the obligations and requirements for the maintenance of the hard and soft landscape works such as the following:

- ▶ Weeding & Rubbish Removal.
- ▶ Replacement Plants.
- ▶ Stakes & Ties.
- ▶ Grass.
- ▶ Pruning.
- ▶ Mulch.
- ▶ Fertiliser.
- ▶ Remnant Vegetation maintenance.

8.4 Landscape Plan Submissions

Landscape Plans shall be produced according to the following minimum standards.

- ▶ Scale appropriate to the size of the site and nature of development to adequately describe the landscape proposal.
- ▶ Large sites may be scale 1:500 or 1:200 and smaller sites 1:100 or 1:50.
- ▶ Construction Details are to be generally 1:20 or 1:10.

PRESENTATION

- ▶ Landscape Master Plans and Landscape Concept Plans
1 x coloured plan and 2 x black and white plans.
- ▶ Landscape Construction Documentation Plans
3 x black and white plans
- ▶ Neatly printed, legible and supported by relevant documentation.
- ▶ Accurate location of existing and proposed site features.
- ▶ Include legend, titleblock, scale and scale bar, and north point.
- ▶ Include plant schedule of proposed trees, shrubs, grasses and groundcover species.

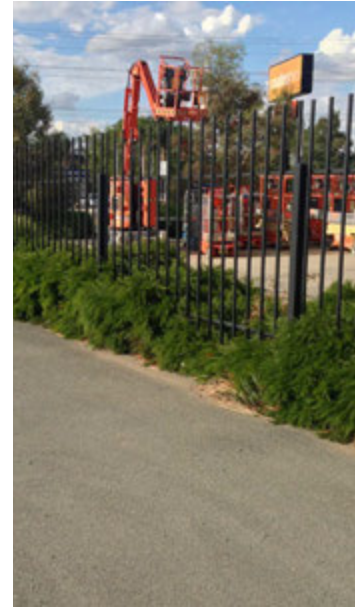

Low planting along transparent fence to soften interface

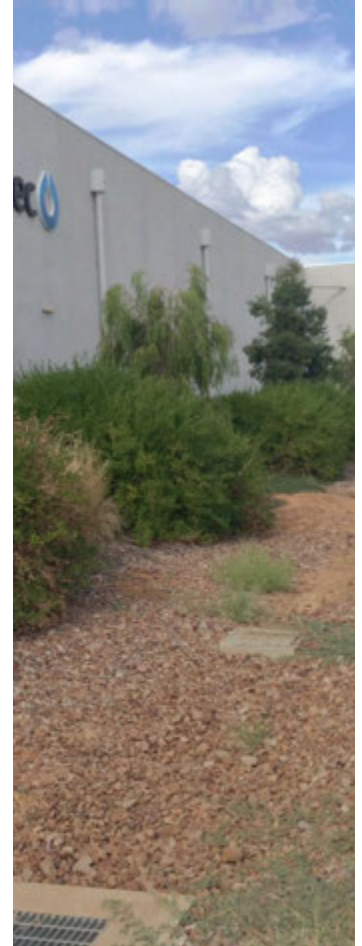

Landscape planting to interface and WSUD treatment

8.5 Landscape Plan Templates/Examples

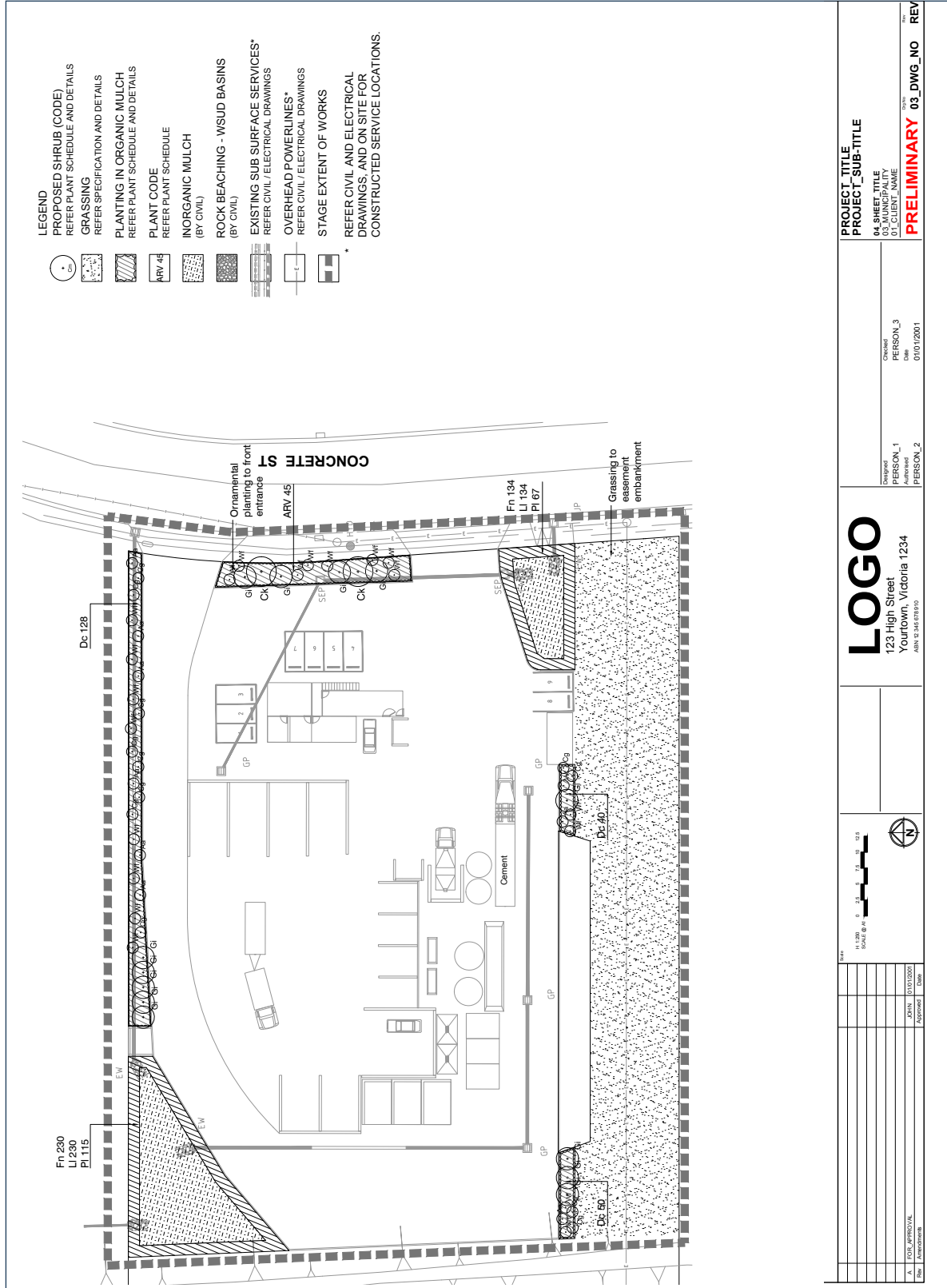

Template example of industrial development landscape plan

PLANT SCHEDULE

| Planting Detail | Plant Species | Plant Size | Plant Spacing | Planting Method | Planting Notes |
|-----------------|----------------------|------------|---------------|-----------------|----------------------|
| 1 | Planting Detail 1.1 | 3.0m | 3.0m | Standard Tree | Planting Detail 1.1 |
| | Planting Detail 1.2 | 3.0m | 3.0m | Standard Tree | Planting Detail 1.2 |
| | Planting Detail 1.3 | 3.0m | 3.0m | Standard Tree | Planting Detail 1.3 |
| | Planting Detail 1.4 | 3.0m | 3.0m | Standard Tree | Planting Detail 1.4 |
| | Planting Detail 1.5 | 3.0m | 3.0m | Standard Tree | Planting Detail 1.5 |
| | Planting Detail 1.6 | 3.0m | 3.0m | Standard Tree | Planting Detail 1.6 |
| | Planting Detail 1.7 | 3.0m | 3.0m | Standard Tree | Planting Detail 1.7 |
| | Planting Detail 1.8 | 3.0m | 3.0m | Standard Tree | Planting Detail 1.8 |
| | Planting Detail 1.9 | 3.0m | 3.0m | Standard Tree | Planting Detail 1.9 |
| | Planting Detail 1.10 | 3.0m | 3.0m | Standard Tree | Planting Detail 1.10 |
| 2 | Planting Detail 2.1 | 3.0m | 3.0m | Tree Stake | Planting Detail 2.1 |
| | Planting Detail 2.2 | 3.0m | 3.0m | Tree Stake | Planting Detail 2.2 |
| | Planting Detail 2.3 | 3.0m | 3.0m | Tree Stake | Planting Detail 2.3 |
| | Planting Detail 2.4 | 3.0m | 3.0m | Tree Stake | Planting Detail 2.4 |
| | Planting Detail 2.5 | 3.0m | 3.0m | Tree Stake | Planting Detail 2.5 |
| | Planting Detail 2.6 | 3.0m | 3.0m | Tree Stake | Planting Detail 2.6 |
| | Planting Detail 2.7 | 3.0m | 3.0m | Tree Stake | Planting Detail 2.7 |
| | Planting Detail 2.8 | 3.0m | 3.0m | Tree Stake | Planting Detail 2.8 |
| | Planting Detail 2.9 | 3.0m | 3.0m | Tree Stake | Planting Detail 2.9 |
| | Planting Detail 2.10 | 3.0m | 3.0m | Tree Stake | Planting Detail 2.10 |
| 3 | Planting Detail 3.1 | 3.0m | 3.0m | Garden Bed | Planting Detail 3.1 |
| | Planting Detail 3.2 | 3.0m | 3.0m | Garden Bed | Planting Detail 3.2 |
| | Planting Detail 3.3 | 3.0m | 3.0m | Garden Bed | Planting Detail 3.3 |
| | Planting Detail 3.4 | 3.0m | 3.0m | Garden Bed | Planting Detail 3.4 |
| | Planting Detail 3.5 | 3.0m | 3.0m | Garden Bed | Planting Detail 3.5 |
| | Planting Detail 3.6 | 3.0m | 3.0m | Garden Bed | Planting Detail 3.6 |
| | Planting Detail 3.7 | 3.0m | 3.0m | Garden Bed | Planting Detail 3.7 |
| | Planting Detail 3.8 | 3.0m | 3.0m | Garden Bed | Planting Detail 3.8 |
| | Planting Detail 3.9 | 3.0m | 3.0m | Garden Bed | Planting Detail 3.9 |
| | Planting Detail 3.10 | 3.0m | 3.0m | Garden Bed | Planting Detail 3.10 |

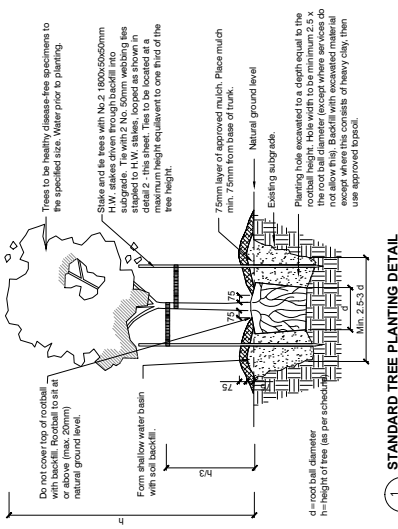

1 STANDARD TREE PLANTING DETAIL Scale 1:20 @ A1

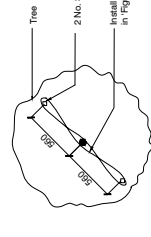

2 TREE STAKE SET OUT DETAIL Scale 1:10 @ A1

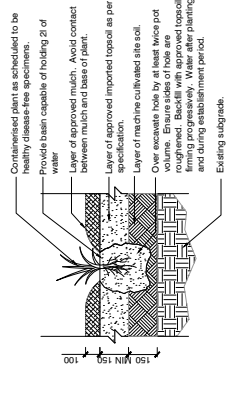

3 GARDEN BED WITH ORGANIC MULCH PLANTING DETAIL Scale 1:10 @ A1



Drawing Number: 123456 000

Revision Date: 01 01/01/2001

Sheet: 01 of 01

Drawn by: Person 1

Checked by: Person 2

PROJECT TITLE
PLAN TYPE | PROJECT LOCATION



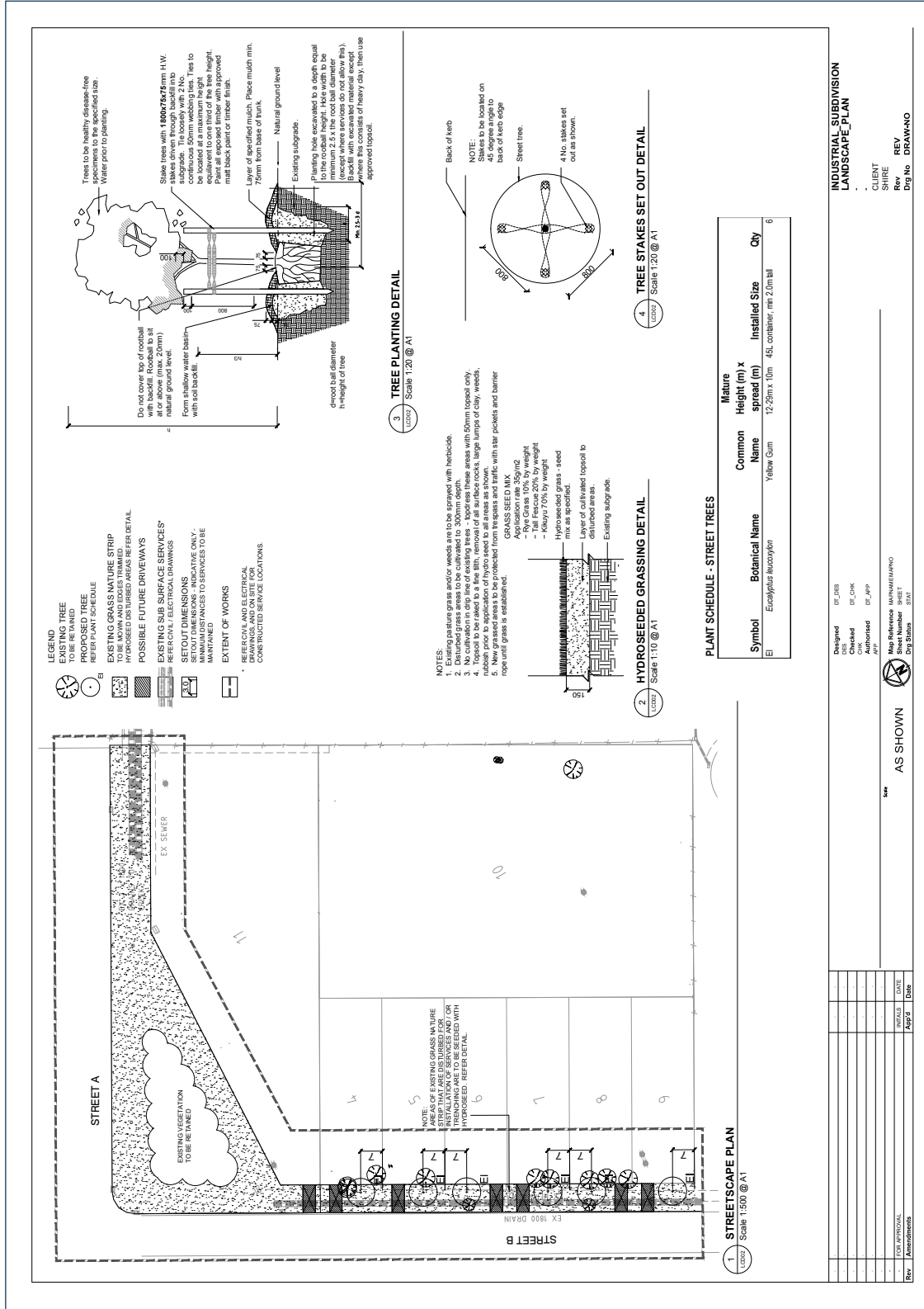

**INDUSTRIAL SUBDIVISION
LANDSCAPE PLAN**

DESIGNED: DT_DBS
 CHECKED: DT_CHK
 DRAWN: DT_APP
 CLIENT: SHIRE
 REV: DT_CHK
 Dwg No: DRA1040

PLANT SCHEDULE - STREET TREES

| Symbol | Botanical Name | Common Name | Mature Height (m) x spread (m) | Installed Size | Qty |
|--------|------------------------------|-------------|--------------------------------|------------------------------|-----|
| E1 | <i>Eucalyptus leucopylla</i> | Yellow Gum | 12-23m x 10m | 45L container, min 2.0m tall | 6 |

AS SHOWN

| Rev | FOR APPROVAL | DATE |
|-----|--------------|------|
| | | |
| | | |

Template example of industrial development landscape plan and details



SECTION 6 COUNCIL PROJECTS PROCESS



9. DESIGN AND APPROVALS PROCESS FOR COUNCIL PROJECTS

9.1 Council Approvals Process

Internal Council projects that require landscape works will follow a design and approvals process similar to that for planning permit applications. The internal Council design and approvals process is shown in the chart below.

All relevant parts of Council landscape projects should be prepared by a Council accredited landscape architect / landscape designer (Registered member of the Australian Institute of Landscape Architects). This may be a Council employed landscape architect or a consultant professional with appropriate qualifications.

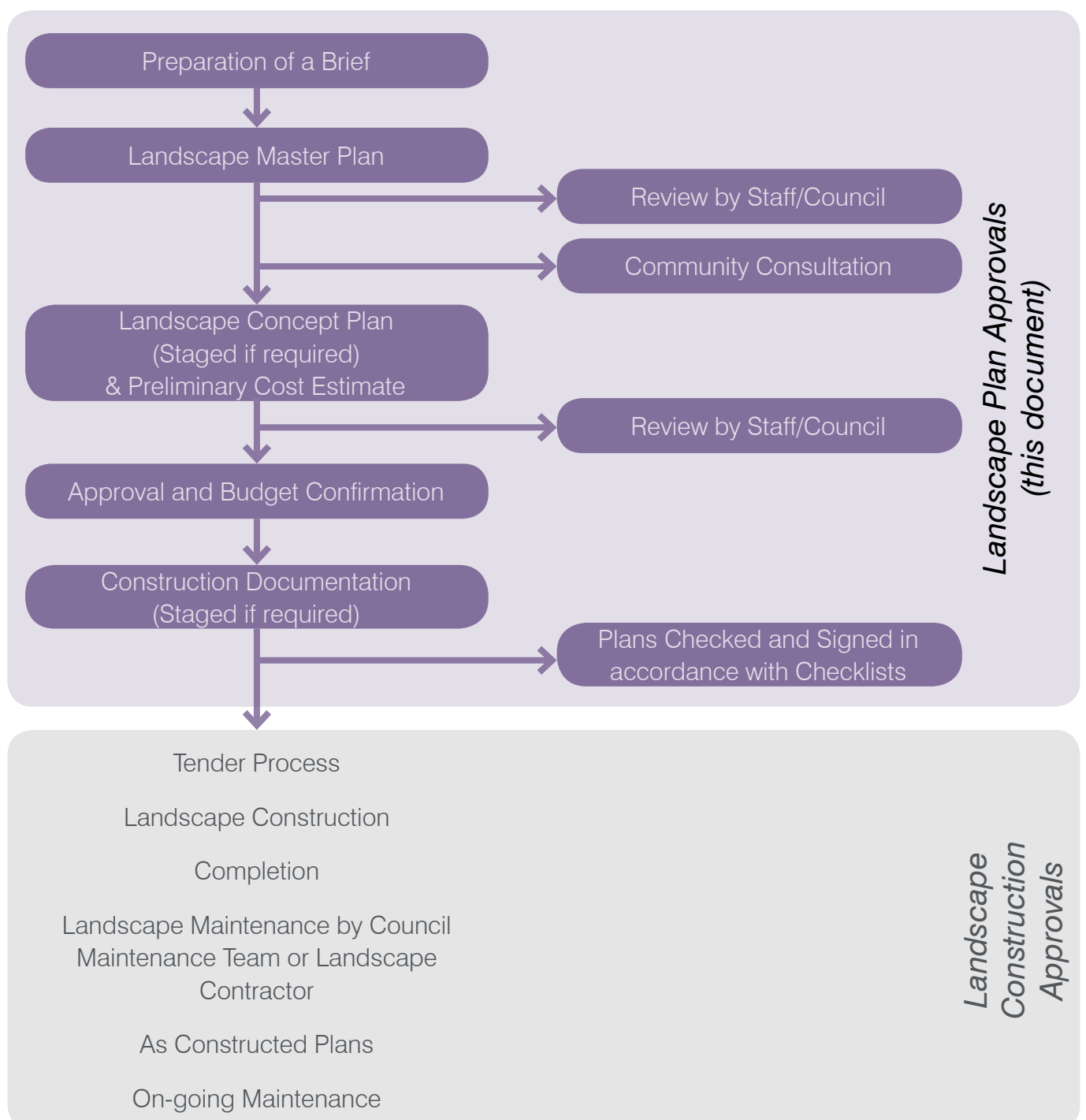

9.2 Landscape Plan Requirements

PREPARATION OF BRIEF

A Brief is to be prepared for all Council landscape works. The Brief is to outline the requirements of the proposed work and include the design outputs to be delivered and approved as part of the design process.

Internal departmental discussions will be held to determine opportunities to be assessed, constraints identified and needs for further investigation clarified.

An appropriate document control system and planning process will be developed for each project by Council Officers and consistent with the internal landscape design and approvals process.

Due to the greater probability of community involvement in Council's own projects, this Preparation of Brief stage should include consideration of the project Community Consultation and Communication Strategy.

LANDSCAPE MASTER PLAN

A Landscape Master Plan will be produced for internal approval prior to any detailed design or construction. A preliminary Opinion of Probable Cost will also be developed, based on the Landscape Master Plan, and issued for internal approval.

Review by Staff / Council

The Landscape Master Plan will be referred to other Council departments, such as the engineering, assets, and environment teams through the internal planning approvals process. This will ensure departments which have vested interest in the subject land, its development and future maintenance are included in the design and approvals process.

Written comments will be received from relevant departments.

Community Consultation and Communication

Community consultation and communication will normally be undertaken for all Council Landscape Master Plans in order to engage the community early in the design and approvals process.

The Community Consultation and Communication Strategy will ensure public display, receipt of community comments, and required amendment.



LANDSCAPE CONCEPT PLAN AND PRELIMINARY OPINION OF PROBABLE COST (STAGED IF REQUIRED)

Internal Council projects require detailed Landscape Concept Plans to be prepared based on the approved Landscape Master Plan.

Separate Concept Plans may be prepared and submitted according to the staging of the development.

The Landscape Concept Plan should be submitted to relevant internal departments through the planning approvals process, and approved prior to approval of engineering/architectural construction plans for any particular stage. The Concept Plans will be assessed against relevant engineering/architectural construction plans. When approved, the Landscape Concept Plan will be the basis for the Landscape Construction plans.

A Preliminary Opinion of Probable Cost is to be developed from the Landscape Concept Plan and submitted to relevant internal departments for review and approval with the plans.

APPROVAL AND BUDGET CONFIRMATION

Projects will receive written approval and confirmation of budget from relevant departments prior to proceeding with Construction Documentation.

CONSTRUCTION DOCUMENTATION PLANS (STAGED IF REQUIRED)

Construction Documentation Plans are required to control the construction of the landscape works and are to be developed from the approved Landscape Concept Plan.

Separate Construction Documentation Plans may be prepared and issued for review according to the staging of proposed works.

Council will refer the plans to relevant internal departments for approval through planning approvals process. The plans will be assessed and approved against endorsed engineering construction plans.

Construction Documentation of the approved concept is to be completed prior to any commencement of built works.

A Pre-Tender Opinion of Probable Cost is to be prepared for the proposed construction, based on the preliminary cost estimate and completed in line with the construction documents.

Plans Checked and Signed in accordance with Checklists

Construction Documentation Plans and Pre-Tender Opinion of Probable Cost are to be checked and signed by the relevant Council Officer in accordance with Checklists and Council's internal Systems.



SECTION 7 PLANTING SPECIES

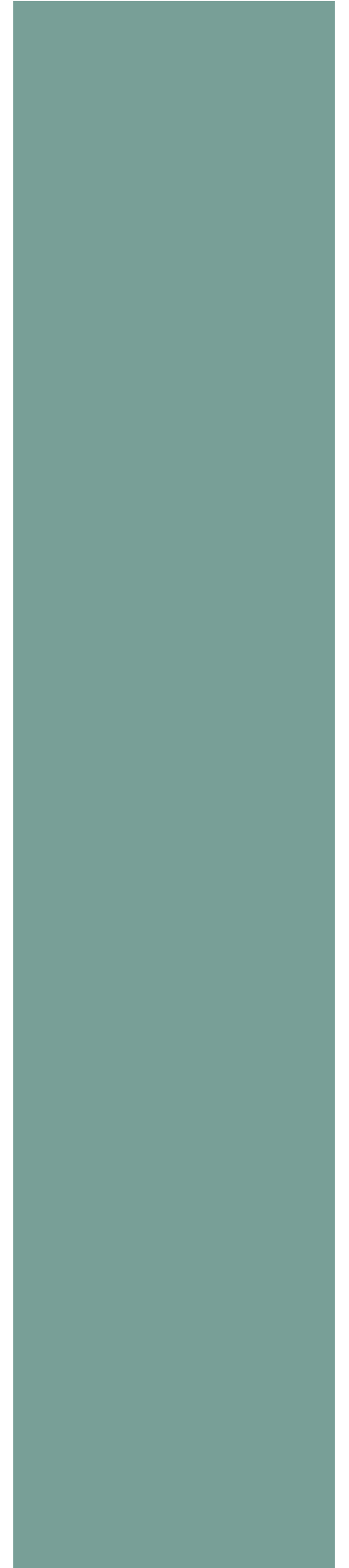

10. BIOREGIONS

10.1 Local Government Areas Bioregions

Across the extensive area covered by Moira Shire, Campaspe Shire Council and the Greater Shepparton City Council the landscape varies according to local conditions. These landscape types are called 'bioregions'.

Bioregions classify the environment using a range of attributes such as climate, geomorphology, geology, soils and vegetation. By identifying which bioregion a development falls within it is possible to better understand the local conditions, and therefore which plant species are more likely to survive and thrive in the landscape.

For further information on the bioregions please refer to section one in the appendix of this guide.

Four bioregions are present across Moira Shire, Shire of Campaspe and Greater Shepparton City Council:

- ▶ Victorian Riverina
- ▶ Murray Fans
- ▶ Northern Inland Slopes
- ▶ Goldfields

Below is a map showing the bioregions within the Local Government Areas. Plant species should be selected which are present in the relevant bioregion for the development site.

Further details about these bioregions can be found at

<http://www.depi.vic.gov.au/environment-and-wildlife/biodiversity/evc-benchmarks>



11. RECOMMENDED PLANTING LISTS

The following planting images and lists provides a guide for suggested and recommended species for landscape developments.

The applicant shall ensure that the species selected are appropriate to the individual site conditions and intended purpose, and that the plants are available from local nurseries.

Tree species selection shall be discussed with appropriate Council officers to determine the *right tree for the right location*.

11.1 Native Plants & Local/Indigenous Plants in Cultivation

GROUND COVERS & PERENNIAL HERBS

VR = Victorian Riverina
GF = Goldfields
MF = Murray Fans
NS = North Inland Slopes
R/V = Rare/Vulnerable plants



Acacia aculeatissima - Thin Leaf Wattle
VR, GF, NS



Acaena novae-zelandiae - Bidgee Widgee
VR, GF, MF, NS



Acrotriche serrulata - Honey Pots
VR, GF, NS



Ajuga australis - Austral Bugle
VR, GF, MF, NS



Alternanthera denticulata - Lesser Joyweed
VR, GF, MF, NS



Asperula conferta - Common Woodruff
VR, GF, MF, NS



Astroloma humifusum - Cranberry Heath
VR, GF, MF, NS



Atriplex semibaccata - Creeping Saltbush
VR, GF, MF, NS



Atriplex vesicaria - Bladder Saltbush
MF

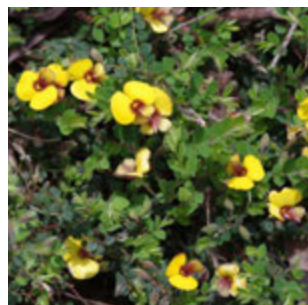

Bossiaea buxifolia - Matted Bossiaea
GF, NS

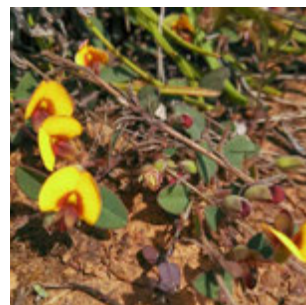

Bossiaea prostrata - Creeping Bossiaea
VR, GF, NS



Brachyscome chrysoglossa - Yellow-tongue Daisy (**R/V**)
VR, GF, MF

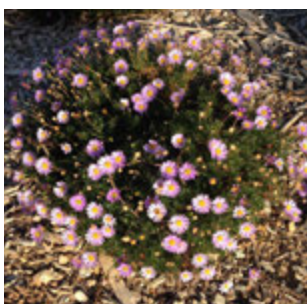

Brachyscome multifida - Cut Leaf Daisy
VR, GF, MF

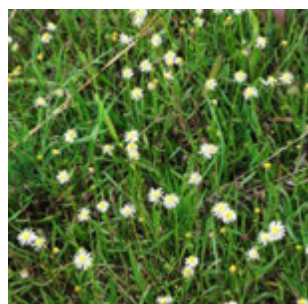

Calotis scapigera - Tufted Burr Daisy
VR, GF, MF

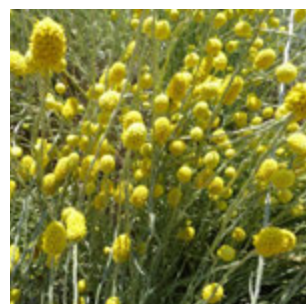

Calocephalus citreus - Lemon Beauty Heads
VR, GF

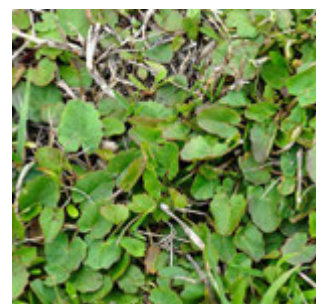

Centella cordifolia - Swamp Pennywort
VR, GF, MF, NS



Chenopodium desertorum -
Desert Goosefoot
VR, GF, MF, NS



Chrysocephalum apiculatum -
Common Everlasting
VR, GF, MF, NS



Convolvulus angustissimus -
Blushing Bindweed
VR, GF, MF, NS



Convolvulus wimmerensis -
Bindweed
VR, MF, NS



Desmodium varians - Slender
Tick-Trefoil
VR, GF, NS



Dichondra repens - Kidney
Weed
VR, GF, MF



Dodonaea procumbens - Trailing
Hop Bush
VR, GF



Einadia hastata - Saloop Salt
Bush
VR, GF, MF, NS



Einadia nutans - Nodding Salt
Bush
GF, NS



Enchylaena tomentosa -
Creeping Ruby Salt Bush
VR, GF, MF



Eryngium paludosum - Long
Eryngium **(R/V)**
VR, GF, MF, NS



Glycine latrobeana - Clover
Glycine **(R/V)**
VR, GF



Glycine tabacina - Variable
Glycine
VR, GF, MF, NS

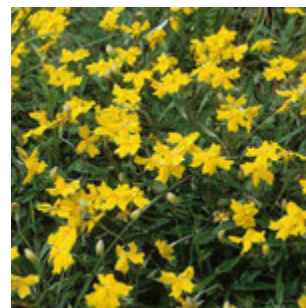

Goodenia blackiana - Primrose
Goodenia
VR, GF, MF

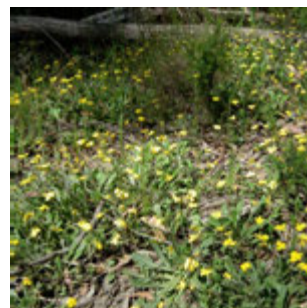

Goodenia lanata - Trailing
Goodenia
VR, GF, NS



Goodenia pinnatifida - Cut-leaf
Goodenia
VR, GF, MF, NS



Grevillea ilicifolia - Holly Grevillea
VR, GF, MF, NS



Grevillea obtecta - Elphinstone
Grevillea **(R/V)**
GF

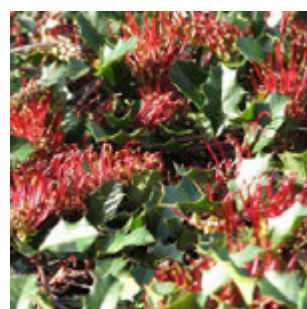

Grevillea repens - Creeping
Grevillea **(R/V)**
VR, GF

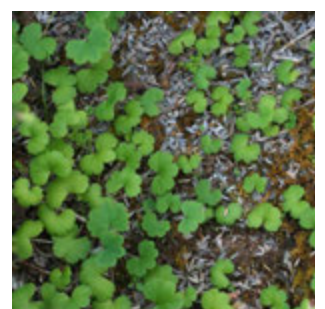

Hydrocotyle laxiflora - Stinking
Pennywort
VR, GF, MF, NS



Hydrocotyle sibthorpioides - Shining Pennywort (wetland plant) **VR, GF, MF, NS**



Isotoma fluviatilis - Swamp Isotome **VR, GF, MF, NS**



Kennedia prostrata - Running Postman **VR, GF, MF, NS**



Lepidium pseudopapillosum - Erect Peppergrass (**R/V**) **VR, GF**



Lissanthe strigosa - Peach Heath **VR, GF, MF, NS**



Lobelia concolor - Milky Lobelia (wetland plant) **VR, GF, MF, NS**



Lobelia pedunculata - Matted Lobelia (wetland plant) **VR, GF, NS**



Lobelia pratioides - Poison Lobelia (wetland plant) **VR, GF, MF, NS**

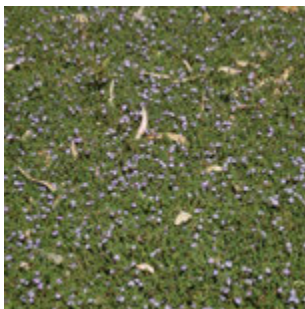

Mimulus repens - Creeping Monkey Flower **VR**



Myoporum parvifolium - Creeping Boobialla **VR, GF**

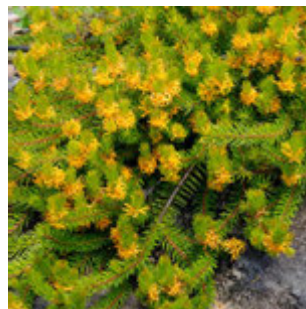

Persoonia chamaepeuce - Dwarf Geebung **VR, GF, NS**



Pultenaea pedunculata - Matted Bush Pea **VR, GF**



Senecio behrianus - Stiff Groundsel (**R/V**) **VR, GF, MF**



Stellaria pungens - Prickly Starwort **VR, GF, NS**

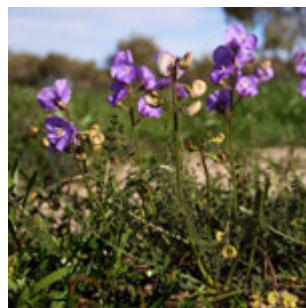

Swainsona procumbens - Small Leaf Broughton Pea **VR, GF, MF, NS**



Swainsona swainsonioides - Downy Swainson Pea (**R/V**) **VR, GF, NS**

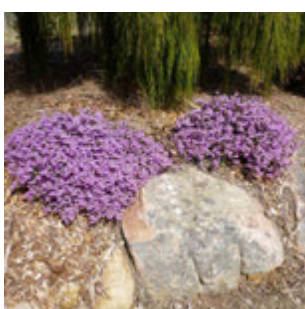

Tetradlea thymifolia - Black-eyed Susan (**NSW, QLD**)

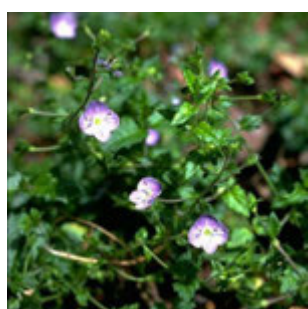

Veronica calycina - Hairy Speedwell **VR, GF, NS**

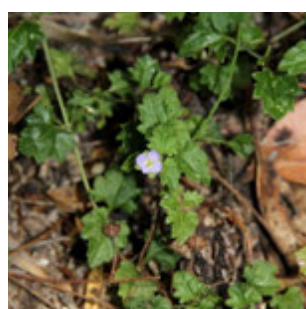

Veronica plebeia - Trailing Speedwell **VR, GF, NS**



Viola hederacea - Native Violet **VR, GF, MF, NS**

GRASSES & TUFTING PLANTS

VR = Victorian Riverina
GF = Goldfields
MF = Murray Fans
NS = North Inland Slopes
R/V = Rare/Vulnerable plants



Amphibromus nervosus -
 Swamp Wallaby Grass
VR, GF, MF, NS



Amphipogon caricinus var.
caricinus - Long Greybeard
 Grass **VR, MF**



Anigozanthos - Kangaroo Paws
(Western Australia)



Aristida behriana - Brush Wire
 Grass
VR, GF, MF, NS



Austrostipa breviglumis - Cane
 Spear Grass **(R/V)**
VR, GF, NS



Aristida ramosa - Purple Wire
 Grass
VR, GF, MF, NS



Austrodanthonia auriculata -
 Lobed Wallaby Grass
VR, GF, MF, NS



Austrodanthonia caespitosa -
 Common Wallaby Grass
VR, GF, MF, NS



Austrodanthonia carphoides -
 Short Wallaby Grass
VR, GF, MF, NS



Austrostipa densiflora - Foxtail
 Spear Grass
VR, GF, NS



Austrostipa elegantissima -
 Feather Spear Grass
VR, GF, MF, NS



Bothriochloa macra - Redleg
 Grass
VR, GF, MF, NS



Bulbine glauca - Rock Lily
VR, NS



Chloris truncata - Windmill Grass
VR, GF, MF, NS



Carex appressa - Tall Sedge
VR, GF, MF, NS

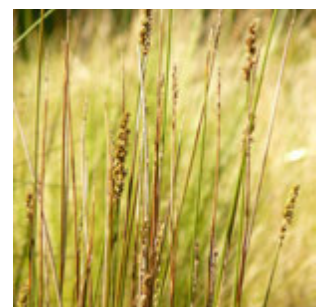

Carex tereticaulis - Basket
 Sedge, Terete Culm-Sedge
VR, GF, MF, NS



Dianella revoluta - Black-anther
Flax-lily
VR, GF, MF



Doryanthes excelsa - Gymea Lily
(NSW)



Lomandra longifolia - Spiny-
headed Mat-rush
VR, GF, MF, NS



Poa labillardieri - Common
Tussock Grass
VR, GF, MF, NS

CLIMBERS AND RAMBLERS



Billardiera cymosa - Sweet Apple
Berry
VR, GF



Clematis microphylla -
Small-leaved Clematis
VR, GF, MF, NS

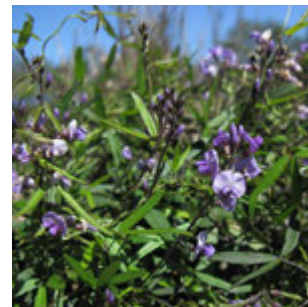

Glycine clandestina - Trailing
Glycine, Twining Glycine
VF, GF, MF, NS



Hardenbergia violacea - Happy
Wanderer, Purple Coral Pea,
Sarsaparilla **VR, GF, MF, NS**

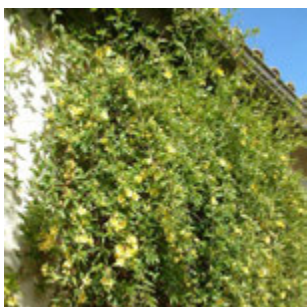

Hibbertia scandens - Golden
Guinea Vine
(NSW, QLD)



Millettia megasperma - Native
Wisteria **(NSW, QLD)**



Pandorea jasminoides - Bower
Vine **(NSW, QLD)**



Rubus parvifolius - Native
Raspberry
VR, GF, NS

SMALL TO MEDIUM SHRUBS (1 – 3 M)

VR = Victorian Riverina
GF = Goldfields
MF = Murray Fans
NS = North Inland Slopes
R/V = Rare/Vulnerable plants



Acacia acinacea - Gold Dust Wattle
VR, GF, MF, NS



Acacia acinacea - Gold Dust Wattle (Red-bud form)
VR, GF, MF, NS



Acacia brachybotrya - Grey Mulga
VR, GF, MF



Atriplex nummularia - Old Man Salt-bush
VR, MF



Astroloma pinifolium - Pine Heath
GF



Baeckea crassifolia - Desert Heath-myrtle
GF



Calytrix tetragona - Common fringe myrtle
VR, GF, MF, NS



Cheiranthra cyanea - Blue Finger Flower
VR, MF, GF, NS



Correa reflexa - Common Correa
VR, GF, NS

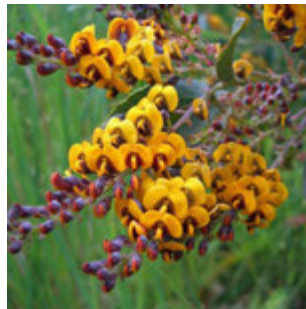

Daviesia latifolia - Hop Bitter Pea
VR, GF, NS



Daviesia genistifolia - Broom Bitter Pea **(R/V)**
VR, GF, NS



Discaria pubescens - Australian Anchor Plant **(R/V)**
VR, GF, NS



Epacris impressa - Common Heath
GF

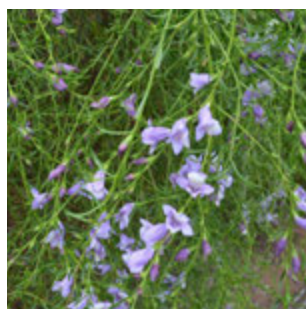

Eremophila divaricata - Spreading Emu Bush
VR, MF

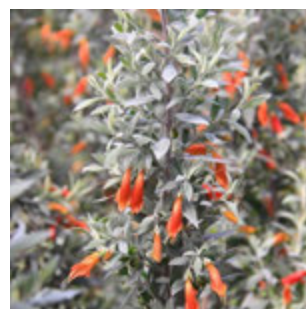

Eremophila glabra - Common Emu Bush
VR, GF, MF



Eutaxia microphylla var. *diffusa* - Spineless Eutaxia **(R/V)**
VR, MF, GF



Grevillea alpina - Cat's Claw
VR, GF, MF, NS



Grevillea rosmarinifolia - Rosemary Grevillea
VR, GF, NS



Grevillea micrantha - Small Flower Grevillea
VR, GF



Hibbertia obtusifolia - Grey Guinea Flower **(R/V)**
VR, GF, NS



Hybanthus floribundus - Shrub Violet
VR, GF, MF



Leucopogon ericoides - Pink Beard Heath
VR, GF, NS



Micromyrtus ciliata - Fringed Heath Myrtle
VR, GF, MF, NS



Olearia pannosa subsp. cardiocarpa - Velvet Daisy Bush **(R/V)**
VR, GF



Olearia pimeleoides - Pimelea Daisy Bush
VR, GF, MF, NS



Ozothamnus retusus - Rough Everlasting
GF



Phebalium festivum - Dainty Phebalium **(R/V)**
VR, GF



Phebalium festivum - Prickly Waxflower **(R/V)**
GF



Philotheca verrucosa - Bendigo Wax (Semmens double white form) **(R/V)**
VR, GF, MF

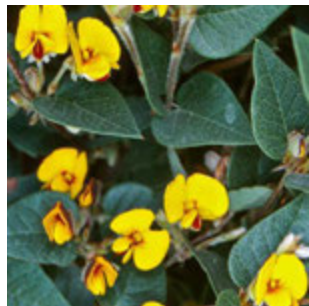

Platylobium formosum - Handsome Flat Pea
GF



Prostanthera aspalathoides - Scarlet Mint Bush
VR, GF, MF, GF



Pultenaea humilis - Dwarf Bush Pea
VR, GF, NS



Templetonia stenophylla - Leafy Templetonia **(R/V)**
VR, GF, MF, NS



Tetratheca ciliata - Pink Bells
VR, GF, NS



Westringia eremicola - Slender Westringer
VR, GF, NS



Zieria aspalathoides - Whorled Zieria/Sandfly Bush **(R/V)**
VR, GF

VR = Victorian Riverina
GF = Goldfields
MF = Murray Fans
NS = North Inland Slopes
R/V = Rare/Vulnerable plants

MEDIUM TO LARGE SHRUBS (3 – 5 M)



Acacia hakeoides - Hakea Wattle
VR, GF, MF



Acacia implexa - Lightwood
VR, GF, MF, NS



Acacia montana - Mallee Wattle
VR, GF, MF, NS



Acacia oswaldii - Umbrella Wattle (**R/V**)
VR, GF, MF



Acacia paradoxa - Hedge Wattle
VR, GF, MF, NS



Acacia pycnantha - Golden Wattle
VR, GF, MF, NS



Acacia rigens - Needle Wattle, Nealie
VR, GF, MF



Acacia verniciflua - Varnish Wattle
VR, GF, MF, NS



Acacia williamsonii - Whirrakee Wattle (**R/V**)
VR, GF



Bursaria spinosa subsp. spinosa - Sweet Bursaria
VR, GF, MF, NS



Callistemon citrinus - Crimson Bottlebrush
GF



Callistemon rugulosus - Scarlet Bottlebrush
GF, MF, NS



Callistemon sieberi - River Bottlebrush
VR, GF, MF, NS



Cassinia ozothamnoides - Cottoney Haeckeria (**R/V**)
VR, GF, NS



Coprosma quadriifida - Prickly Currant Bush
VR, GF, NS



Daviesia latifolia - Hop Bitter Pea
VR, GF, NS



Dillwynia phyllicoides - Small Leaf Parrot Pea
VR, GF, NS



Dodonaea viscosa subsp. *cuneata* - Wedge-leaf Hop Bush
VR, GF, MF, NS



Eremophila longifolia - Turkey Bush
VR, GF, MF, NS



Eremophila glabra - Common Emu Bush
VR, GF, MF



Grevillea rosmarinifolia - Rosemary grevillea
VR, GF, NS

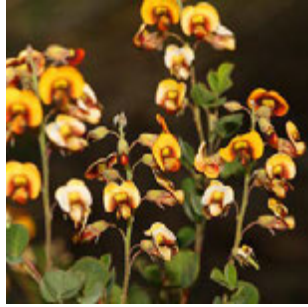

Goodia medicaginea - Western Golden Tip **(R/V)**
VR, GF, NS



Hakea decurrens subsp. *physocarpa* - Bushy Needlewood **GF**



Hakea tephrosperma - Hooked Needlewood
VR, GF, MF



Hovea asperifolia subsp. *asperifolia* - Mountain Beauty
VR, NS

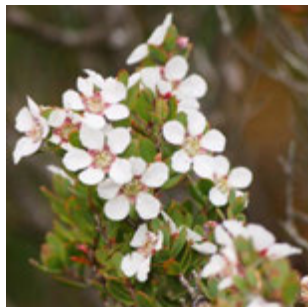

Leptospermum lanigerum - Woolly Tea Tree
GF, NS



Logania albiflora - Narrow Leaf Logania
GF



Melaleuca decussata - Cross Leaf Honey Myrtle
VR, GF, NS



Melaleuca lanceolata - Moonah
VR, GF, MF



Myoporum montanum - Waterbush **(R/V)**
VR, GF, MF, NS



Ozothamnus rosmarinifolius - Rosemary Everlasting
NS



Pittosporum angustifolium - Weeping Pittosporum
VR, GF, MF



Pomaderris paniculosa subsp. *paniculosa* - Inland Pomaderris **(R/V)**
VR, GF



Pultenaea graveolens - Scented Bush Pea **(R/V)**
GF



Westringia crassifolia - Whipstick Westringia **(R/V)**
VR, GF



Xanthorrhoea glauca subsp. *angustifolia* - Grass Tree
VR, GF, MF

VR = Victorian Riverina
GF = Goldfields
MF = Murray Fans
NS = North Inland Slopes
R/V = Rare/Vulnerable plants

SMALL TO MEDIUM TREES <10M



Acacia dealbata - Silver Wattle
VR, GF, MF, NS



Acacia implexa - Lightwood
VR, GF, MF, NS



Acacia melanoxylon - Blackwood
VR, GF, MF, NS



Acacia pendula - Weeping Myall **(R/V)**
VR, MF



Acacia pycnantha - Golden Wattle
VR, GF, MF, NS



Acacia salicina - Weeping Acacia, Native Willow
VR, GF, MF, NS



Acacia stenophylla - Eumong, River Cooba, Showstring Acacia
VR, MF



Allocasuarina luehmannii - Buloke **(R/V)**
VR, GF, MF, NS



Brachychiton populneus - Kurrajong
VR,GF, MF, NS



Callitris rhomboidea - Port Jackson Pine
GF, NS



Corymbia ficifolia - Red Flowering Gum
(Western Australia)



Callistemon sieberi - River Bottlebrush
VR, GF, MF, NS



Eucalyptus caesia - Silver Princess
(Western Australia)



Eucalyptus pauciflora subsp. *pauciflora* - Little Snowman
VR, NS

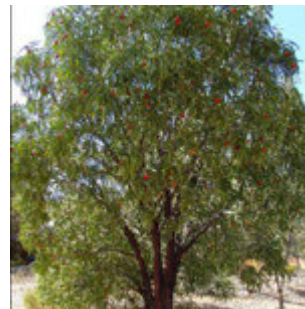

Santalum acuminatum - Sweet Quandong
VR, MF, NS



Leptospermum obovatum - River Tea Tree
VR, GF, NS

MEDIUM TO LARGE TREES >10M



Angophora costata -
Smooth-barked Apple
(QLD, NSW)



Acacia stenophylla - Eumong
VR, MF



Allocasuarina luehmannii -
Buloke (R/V)
VR, GF, MF, NS



Callitris glaucophylla -
Murray Pine
(R/V) VR, GF, MF, NS



Corymbia citriodora -
Lemon-scented Gum (QLD)



Corymbia maculata -
Spotted Gum (NSW)

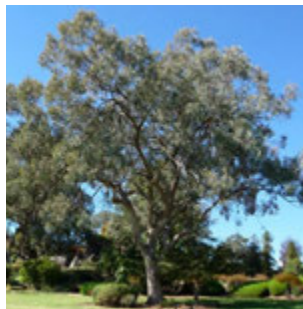

Eucalyptus albens -
White Box
VR, GF, MF, NS



Eucalyptus camaldulensis -
River Red Gum (*waterways/
wetlands only) VR, GF, MF, NS



Eucalyptus largiflorens -
Black Box, River Box
VR, GF, MF, NS



Eucalyptus leucoxylon subsp
pruinosa - Yellow Gum, White
Ironbark VR, GF

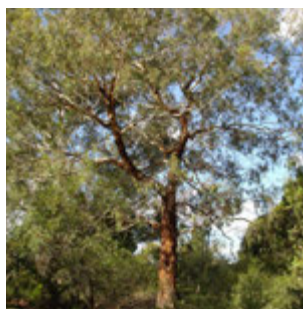

Eucalyptus melliodora -
Yellow Box
VR, GF, MF, NS

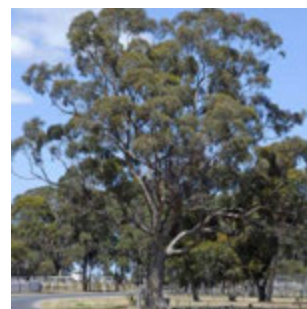

Eucalyptus microcarpa -
Grey Box VR, GF, MF, NS

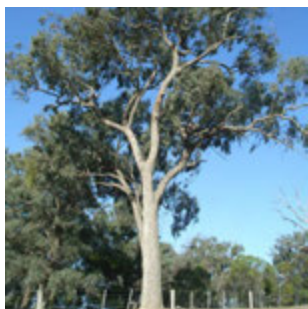

Eucalyptus polyanthemos subsp
vestita - Red Box
VR, GF, NS



Eucalyptus tricarpa - Red
Ironbark
VR, GF, MF



Geijera parviflora - Wilga



Hymenosporum flavum -
Native Frangipani
(QLD, NSW)

11.2 Exotic Trees

The following is a selection of exotic tree species suitable for the area. Applicants are to confirm proposed trees with Council to ensure the 'right tree for the right location'.



Acer x freemanii 'Jeffersred'
Autumn Blaze®
Jeffersred Maple



Acer rubrum 'October Glory'
Lipstick Maple

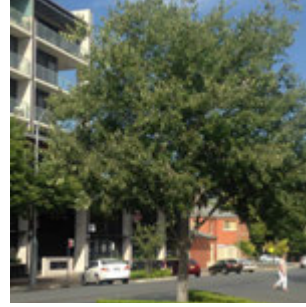

Celtis australis
Nettle Tree



Fraxinus americana 'Autumn Applause'
White Ash



Nyssa sylvatica
Black Tupelo



Pistacia chinensis
Chinese Pistacio



Platanus orientalis var. *insularis*
Plane



Pyrus calleryana 'Aristocrat'
Ornamental Pear



Quercus cerris
Turkey Oak



Quercus palustris 'Green Pillar'
Upright Oak



Quercus palustris
Pin Oak



Quercus rubra
Red Oak

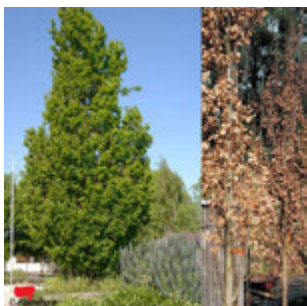

Quercus robur 'Fastigiata'
Upright English Oak



Sapphora japonica
Japanese Pagoda



Ulmus parvifolia
Chinese Elm



Zelkova serrata
Japanese Elm

12. PLANT SPECIES LISTS

12.1 Ground Covers

(R denotes RURAL SPECIES LIST and only where ongoing pest plant maintenance will not be an issue)

| <i>Botanical Name</i> | <i>Common Name</i> |
|---------------------------------------------|------------------------|
| Ground Covers | |
| <i>Acacia aculeatissima</i> | Thin Leaf Wattle |
| <i>Acaena novae-zelandiae</i> | Bidgee Widgee |
| <i>Acrotriche prostrata</i> | Trailing Ground Berry |
| <i>Acrotriche serrulata</i> | Honey Pots |
| <i>Ajuga australis</i> | Austral Bugle |
| <i>Alternanthera denticulata</i> | Lesser Joyweed |
| <i>Asperula conferta</i> | Common Woodruff |
| <i>Astroloma humifusum</i> | Cranberry Heath |
| <i>Atriplex leptocarpa</i> R | Creeping Saltbush |
| <i>Atriplex semibaccata</i> R | Berry Saltbush |
| <i>Atriplex vesicaria</i> | Bladder Salt Bush |
| <i>Bossiaea buxifolia</i> | Matted Bossiaea |
| <i>Bossiaea prostrata</i> | Creeping Bossiaea |
| <i>Brachyscome multifida</i> R | Cut Leaf Daisy |
| <i>Brachyscome chrysoglossa</i> | Yellow-tongue Daisy |
| <i>Calocephalus citreus</i> R | Lemon Beauty Heads |
| <i>Calotis scapigera</i> R | Tufted Burr Daisy |
| <i>Carpobrotus modestus</i> | Inland Pigface |
| <i>Centella cordifolia</i> | Swamp Pennywort |
| <i>Chenopodium desertorum</i> | Desert Goosefoot |
| <i>Chrysocephalum apiculatum</i> R | Common Everlasting |
| <i>Chrysocephalum semipapposum</i> R | Clustered Everlasting |
| <i>Convolvulus angustissimus</i> R | Australian Bindweed |
| <i>Convolvulus erubescens</i> R | Blushing Bindweed |
| <i>Convolvulus wimmerensis</i> R | Pink Bindweed |
| <i>Dichondra repens</i> | Kidney Weed |
| <i>Dodonaea procumbens</i> R | Trailing Hop Bush |
| <i>Einadia hastata</i> R | Saloop Salt Bush |
| <i>Einadia nutans</i> R | Nodding Salt Bush |
| <i>Enchylaena tomentosa</i> R | Ruby Salt Bush |
| <i>Eremophila glabra prostrata</i> R | Silver Spread Emu Bush |
| <i>Eremophila debilis</i> R | Amula |
| <i>Eryngium paludosum</i> | Long Eryngium |
| <i>Glycine latrobeana</i> | Clover Glycine |
| <i>Glycine tabacina</i> | Variable Glycine |
| <i>Goodenia blackiana</i> | Primrose Goodenia |
| <i>Goodenia lanata</i> | Trailing Goodenia |
| <i>Goodenia pinnatifida</i> | Cutleaf Goodenia |
| <i>Grevillea ilicifolia</i> | Holly Grevillea |
| <i>Grevillea obtecta</i> | Elphinstone Grevillea |

| <i>Botanical Name</i> | <i>Common Name</i> |
|-----------------------------------|--------------------------|
| <i>Grevillea repens</i> | Creeping Grevillea |
| <i>Hibbertia exutiacies</i> | Tangled Guinea Flower |
| <i>Hydrocotyle laxiflora</i> | Stinking Pennywort |
| <i>Hydrocotyle sibthorpioides</i> | Shining Pennywort |
| <i>Isotoma fluviatilis</i> | Swamp Isotome |
| <i>Kennedia prostrata</i> | Running Postman |
| <i>Kunzea pomifera</i> | Muntries |
| <i>Lissanthe strigosa</i> | Peach Heath |
| <i>Lobelia concolor</i> | Milky Lobelia |
| <i>Lobelia pendunculata</i> | Matted Lobelia |
| <i>Lobelia pratioides</i> | Poison Lobelia |
| <i>Mimulus repens</i> | Creeping Monkey Flower |
| <i>Myoporum parvifolium</i> | Creeping Boobialla |
| <i>Persicaria prostrata</i> | Creeping Knotweed |
| <i>Persoonia chamaepeuce</i> | Dwarf Geebung |
| <i>Podolobium procumbens</i> | Trailing Shaggy-pea |
| <i>Pultenaea pedunculata</i> | Matted Bush Pea |
| <i>Pycnosorus globulus</i> | Billy Button |
| <i>Scleranthus biflorus</i> | Twin-flower Knaweel |
| <i>Stellaria pungens</i> | Prickly Starwort |
| <i>Swainsona procumbens</i> | Small Leaf Broughton Pea |
| <i>Swainsona swainsonioides</i> | Downy Swainson Pea |
| <i>Tetralochea thymifolia</i> | Black-eyed Susan |
| <i>Veronica calycina</i> | Hairy Speedwell |
| <i>Veronica plebeia</i> | Trailing Speedwell |
| <i>Viola hederacea</i> | Native Violet |

12.2 Climbers and Ramblers

| <i>Botanical Name</i> | <i>Common Name</i> |
|-------------------------------|-----------------------------|
| Climbers and Ramblers | |
| <i>Billardiera cymosa</i> | Sweet Apple Berry |
| <i>Billardiera longifolia</i> | Purple Apple Berry |
| <i>Billardiera scandens</i> | Common Apple Berry |
| <i>Clematis aristata</i> | Old Man's Beard |
| <i>Clematis microphylla</i> | Small-leaved Clematis |
| <i>Glycine clandestina</i> | Trailing Glycine |
| <i>Hardenbergia violacea</i> | Happy Wanderer, Sarsparilla |
| <i>Hibbertia scandens</i> | Golden Guinea Vine |
| <i>Pandorea jasminoides</i> | Bower Vine |
| <i>Rubus parvifolius</i> | Native Raspberry |

12.3 Grasses

(R denotes RURAL SPECIES LIST and only where ongoing pest plant maintenance will not be an issue)

| <i>Botanical Name</i> | <i>Common Name</i> |
|---------------------------------------------------|-----------------------------|
| Grasses | |
| <i>Amphibromus nervosus</i> R | Swamp Wallaby Grass |
| <i>Amphipogon caricinus</i> var. <i>caricinus</i> | Long Greybeard Grass |
| <i>Aristida behriana</i> | Brush Wire Grass |
| <i>Aristida ramosa</i> | Purple Wire Grass |
| <i>Austrodanthonia auriculata</i> | Lobed Wallaby Grass |
| <i>Austrodanthonia bipartita</i> R | Wallaby Grass |
| <i>Austrodanthonia caespitosa</i> R | Common Wallaby Grass |
| <i>Austrodanthonia carphoides</i> | Short Wallaby Grass |
| <i>Austrodanthonia duttoniana</i> | Brown Back Wallaby Grass |
| <i>Austrodanthonia eriantha</i> | Hill Wallaby Grass |
| <i>Austrodanthonia fulva</i> | Copper-awned Wallaby-grass |
| <i>Austrodanthonia geniculata</i> | Kneed Wallaby Grass |
| <i>Austrodanthonia induta</i> | Yellow Anther Wallaby Grass |
| <i>Austrodanthonia penicillata</i> | Slender Wallaby Grass |
| <i>Austrodanthonia pilosa</i> | Velvet Wallaby Grass |
| <i>Austrodanthonia racemosa</i> | Clustered Wallaby-grass |
| <i>Austrodanthonia richardsonii</i> | Straw Wallaby-grass |
| <i>Austrodanthonia setacea</i> | Bristly Wallaby Grass |
| <i>Austrodanthonia tenuior</i> | Short-awn Wallaby-grass |
| <i>Austrostipa aristiglumis</i> | Plump Spear Grass |
| <i>Austrostipa blackii</i> | Plains Spear Grass |
| <i>Austrostipa breviglumis</i> | Cane Spear Grass |
| <i>Austrostipa densiflora</i> | Foxtail Spear Grass |
| <i>Austrostipa elegantissima</i> R | Feather Spear Grass |
| <i>Austrostipa gibbosa</i> | Spurred Spear Grass |
| <i>Austrostipa mollis</i> | Soft Spear Grass |
| <i>Austrostipa nodosa</i> | Knotty Speargrass |
| <i>Austrostipa rudis</i> | Veined Spear-grass |
| <i>Austrostipa oligostachya</i> | Fine-head Spear-grass |
| <i>Austrostipa scabra</i> | Rough Spear Grass |
| <i>Austrostipa semibarbata</i> | Fibrous Spear Grass |
| <i>Austrostipa setacea</i> | Corkscrew Spear Grass |
| <i>Austrostipa stuposa</i> | Tasmanian Spear-grass |
| <i>Austrostipa tuckeri</i> | Tucker's Spear-grass |
| <i>Bothriochloa macra</i> | Redleg Grass |
| <i>Chloris truncata</i> | Windmill Grass |
| <i>Deschampsia caespitosa</i> | Tufted Hair Grass |
| <i>Dichanthium sericeum</i> | Silky Blue-grass |
| <i>Dichelachne crinita</i> | Long Hair Plume Grass |
| <i>Dichelachne hirtella</i> | Slender Plume Grass |

| <i>Botanical Name</i> | <i>Common Name</i> |
|----------------------------------------|-----------------------------|
| <i>Distichlis distichophylla</i> | Emu Grass |
| <i>Elymus scaber</i> | Common Wheat Grass |
| <i>Enneapogon nigricans</i> | Pappus Grass |
| <i>Eragrostis australasica</i> | Cane Grass |
| <i>Eragrostis brownii</i> | Common Love Grass |
| <i>Eragrostis diandra</i> | Clustered Love Grass |
| <i>Eragrostis dielsii</i> | Mallee Love-grass |
| <i>Glyceria australis</i> | Manna Grass |
| <i>Hemarthria uncinata</i> | Mat Grass |
| <i>Homopholis proluta</i> | Rigid Panic |
| <i>Joycea pallida</i> | Red Anther Wallaby Grass |
| <i>Lachnagrostis filiformis</i> var. 2 | Common Blown Grass (Annual) |
| <i>Microlaena stipoides</i> R | Weeping Grass |
| <i>Pentapogon quadrifidus</i> | Five-awned Spear Grass |
| <i>Poa labillardieri</i> R | Common Tussock Grass |
| <i>Poa morrisii</i> | Velvet Tussock Grass |
| <i>Poa sieberiana</i> | Fine-leaf Tussock Grass |
| <i>Poa tenera</i> | Slender Tussock Grass |
| <i>Themeda triandra</i> R | Kangaroo Grass |

12.4 Ferns, Perennial Herbs, Lilies, Rushes, Sedges & Other Tufts

(R denotes RURAL SPECIES LIST and only where ongoing pest plant maintenance will not be an issue)

| <i>Botanical Name</i> | <i>Common Name</i> |
|-------------------------------------------------------------------------|------------------------|
| Ferns, Perennial Herbs, Lilies, Rushes, Sedges & Other Tufts | |
| <i>Acaena echinata</i> | Sheep's Burr |
| <i>Adiantum aethiopicum</i> | Common Maidenhair |
| <i>Anigozanthos</i> | Kangaroo Paws |
| <i>Arthropodium fimbriatum</i> | Nodding Chocolate Lily |
| <i>Arthropodium milleflorum</i> | Pale Vanilla Lily |
| <i>Arthropodium minus</i> | Small Vanilla Lily |
| <i>Arthropodium strictum</i> | Chocolate Lily |
| <i>Baumea articulata</i> | Jointed Twig Rush |
| <i>Blechnum minus</i> | Soft Water Fern |
| <i>Bolboschoenus caldwellii</i> | Sea Club Rush |
| <i>Brachyscome basaltica</i> | Swamp Daisy |
| <i>Brachyscome chrysoglossa</i> | Yellow-tongue Daisy |
| <i>Brachyscome ciliaris</i> | Variable Daisy |
| <i>Brachyscome dentata</i> | Lobe-seed Daisy |
| <i>Brachyscome diversifolia</i> | Large-headed Daisy |
| <i>Brunonia australis</i> | Blue Pincushion |
| <i>Bulbine bulbosa</i> | Bulbine Lily |
| <i>Bulbine glauca</i> | Rock Lily |
| <i>Burchardia umbellata</i> | Milkmaids |
| <i>Caesia calliantha</i> | Blue Grass Lily |
| <i>Calocephalus citreus</i> | Lemon Beauty Heads |
| <i>Calocephalus lacteus</i> | Milky Beauty Heads |
| <i>Calocephalus sonderi</i> | Pale Beauty Heads |
| <i>Calostemma purpureum</i> | Garland Lily |
| <i>Calotis cuneifolia</i> | Purple Burr Daisy |
| <i>Calotis scabiosifolia</i> var. <i>integrifolia</i> | Rough Burr Daisy |
| <i>Calotis scabiosifolia</i> var. <i>scabiosifolia</i> | Rough Burr Daisy |
| <i>Carex appressa</i> | Tall Sedge |
| <i>Carex breviculmis</i> | Short Stem Sedge |
| <i>Carex fascicularis</i> | Tassel Sedge |
| <i>Carex gaudichaudiana</i> | Tufted Sedge |
| <i>Carex inversa</i> | Knob Sedge |
| <i>Carex tereticaulis</i> | Basket Sedge |
| <i>Centipeda cunninghamii</i> | Old Man's Weed |
| <i>Centipeda minima</i> | Small Old Man's Weed |
| <i>Cheilanthes austrotenuifolia</i> | Rock Fern |
| <i>Cheilanthes sieberi</i> | Mulga Fern |
| <i>Chrysocephalum baxteri</i> | White Everlasting |
| <i>Chrysocephalum semipapposum</i> | Clustered Everlasting |

| <i>Botanical Name</i> | <i>Common Name</i> |
|-----------------------------------------------------------------|-----------------------|
| <i>Craspedia paludicola</i> | Swamp Billy Buttons |
| <i>Craspedia variabilis</i> | Common Billy Buttons |
| <i>Correa reflexa</i> | Common Correa |
| <i>Cullen microcephalum</i> | Dusky Scurf-pea |
| <i>Cullen parvum</i> | Small Scurf Pea |
| <i>Cullen tenax</i> | Tough Scurf Pea |
| <i>Cymbonotus pressianus</i> | Austral Bear's Ears |
| <i>Cynoglossum sauveolens</i> | Sweet Hounds Tongue |
| <i>Cyperus exaltatus</i> | Tall Flat Sedge |
| <i>Cyperus gunnii</i> | Flecked Flat Sedge |
| <i>Dianella admixta</i> (formerly <i>D. revoluta</i>) R | Flax Lily |
| <i>Dianella amoena</i> | Matted Flax Lily |
| <i>Dianella</i> sp. aff. <i>longifolia</i> (<i>Benambra</i>) | Arching Flax-lily |
| <i>Dianella tarda</i> | Smooth Flax Lily |
| <i>Dianella porracea</i> | Riverine Flax-lily |
| <i>Dianella tasmanica</i> | Tasman Flax Lily |
| <i>Doodia australis</i> | Common Rasp Fern |
| <i>Doryanthes excelsa</i> | Gyma Lily |
| <i>Eryngium ovinum</i> | Blue Devil |
| <i>Eryngium paludosum</i> | Long Eryngium |
| <i>Gahnia radula</i> | Thatch Saw-sedge |
| <i>Gahnia sieberiana</i> | Red-fruited Saw-sedge |
| <i>Galium gaudichaudii</i> | Rough Bedstraw |
| <i>Geranium retrorsum</i> | Crane's Bill |
| <i>Geranium solanderi</i> | Austral Crane's Bill |
| <i>Glischrocaryon behrii</i> | Golden Pennants |
| <i>Glycine latrobeana</i> | Clover Glycine |
| <i>Gonocarpus elatus</i> | Tall Raspwort |
| <i>Gonocarpus tetragynus</i> | Common Raspwort |
| <i>Goodenia benthamiana</i> | Clasping Goodenia |
| <i>Goodenia elongata</i> | Lanky Goodenia |
| <i>Goodenia gracilis</i> | Slender Goodenia |
| <i>Goodenia heteromera</i> | Spreading Goodenia |
| <i>Haloragis glauca</i> | Grey Raspwort |
| <i>Haloragis heterophylla</i> | Varied Raspwort |
| <i>Helichrysum rutidolepis</i> | Pale Everlasting |
| <i>Helichrysum scorpioides</i> | Button Everlasting |
| <i>Hypoxis glabella</i> | Tiny Star |
| <i>Isotoma axillaris</i> | Showy Isotome |
| <i>Juncus amabilis</i> | Clustered Rush |
| <i>Juncus aridicola</i> | Tussock Rush |

| Botanical Name | Common Name |
|---------------------------------------------------|-------------------------|
| <i>Juncus flavidus</i> | Rush |
| <i>Juncus holoschoenus</i> | Jointed-leaf Rush |
| <i>Juncus homalocaulis</i> | Wiry Rush |
| <i>Juncus ingens</i> | Giant Rush |
| <i>Juncus pallidus</i> | Pale Rush |
| <i>Juncus planifolius</i> | Broad-leaf Rush |
| <i>Juncus radula</i> | Hoary Rush |
| <i>Juncus sarophorus</i> | Broom Rush |
| <i>Lagenophora stipitata</i> | Common Lagenifera |
| <i>Leiocarpa panaetioides</i> | Woolly Buttons |
| <i>Lepidosperma curtisiae</i> | Short Rapier Sedge |
| <i>Lepidosperma filiforme</i> | Rapier-sedge |
| <i>Lepidosperma semiteres</i> | Wire Rapier-sedge |
| <i>Lepidium pseudopapillosum</i> | Erect Peppergrass |
| <i>Leptorhynchus squamatus</i> | Scaly Buttons |
| <i>Leptorhynchus tenuifolius</i> | Wiry Buttons |
| <i>Leucochrysum albicans</i> | Hoary Sunray |
| <i>Leucochrysum albicans</i> var. <i>tricolor</i> | Hoary Sunray |
| <i>Linum marginale</i> | Native Flax |
| <i>Lobelia anceps</i> | Angled Lobelia |
| <i>Lomandra collina</i> | Pale Mat Rush |
| <i>Lomandra filiformis</i> | Wattle Mat Rush |
| <i>Lomandra longifolia</i> | Spiny-headed Mat Rush |
| <i>Lomandra micrantha</i> | Small Flowered Mat Rush |
| <i>Lomandra multiflora</i> | Many-flowered Mat Rush |
| <i>Luzula meridionalis</i> | Woodrush |
| <i>Lycopus australis</i> | Australian Gypsywort |
| <i>Maireana enchylaenoides</i> | Wingless Bluebush |
| <i>Maireana excavata</i> | Bottle Fissure-weed |
| <i>Maireana humillima</i> | Dwarf Bluebush |
| <i>Mentha laxiflora</i> | Forest Mint |
| <i>Mentha saturoides</i> | Native Pennyroyal |
| <i>Microseris lanceolata</i> | Yam Daisy |
| <i>Microtis unifolia</i> | Common Onion Orchid |
| <i>Minuria integerrima</i> | Smooth Minuria |
| <i>Minuria leptophylla</i> | Minnie Daisy |
| <i>Nicotiana suaveolens</i> | Austral Tobacco |
| <i>Opercularia varia</i> | Variable Stinkweed |
| <i>Oreomyrrhis eriopoda</i> | Hairy Caraway |
| <i>Pelargonium australe</i> | Austral Stork's-bill |
| <i>Pelargonium rodneyanum</i> | Magenta Stork's-bill |
| <i>Plantago gaudichaudii</i> | Narrow Leaf Plantain |

| Botanical Name | Common Name |
|-----------------------------------|-------------------------|
| <i>Podolepis jaceoides</i> | Showy Podolepis |
| <i>Podolepis</i> | Riverine Podolepis |
| <i>Pomax umbellata</i> | Pomax |
| <i>Pterostylis curta</i> | Blunt Greenhood Orchid |
| <i>Ptilotus exaltatus</i> | Lamb-tails |
| <i>Ptilotus macrocephalus</i> | Green Pusstail |
| <i>Ptilotus spathulatus</i> | Pusstails |
| <i>Pycnosorus chrysanthes</i> | Golden Billy Buttons |
| <i>Pycnosorus globosus</i> | Drumsticks |
| <i>Ranunculus amphitrichus</i> | Small River Buttercup |
| <i>Ranunculus lappaceus</i> | Australian Buttercup |
| <i>Ranunculus pachycarpus</i> | Thick-fruit Buttercup |
| <i>Rhodanthe anethemoides</i> | Chamomile Sunray |
| <i>Rhodanthe corymbiflora</i> | Grey Sunray (Annual) |
| <i>Rutidosis leptorhynchoides</i> | Button Wrinklewort |
| <i>Senecio behrianus</i> | Stiff Groundsel |
| <i>Solenogyne dominii</i> | Solenogyne |
| <i>Stackhousia monogyna</i> | Creamy Candles |
| <i>Stylidium graminifolium</i> | Grass Trigger Plant |
| <i>Styandra glauca</i> | Nodding Blue Lily |
| <i>Teucrium racemosum</i> | Grey Germander |
| <i>Thysanotus patersonii</i> | Twining Fringe Lily |
| <i>Tricoryne elatior</i> | Yellow Rush Lily |
| <i>Velleia paradoxa</i> | Spur Velleia |
| <i>Wahlenbergia communis</i> | Tufted Blue Bell |
| <i>Wahlenbergia fluminalis</i> | River Blue Bell |
| <i>Wahlenbergia gracilentata</i> | Annual Blue Bell |
| <i>Wahlenbergia gracilis</i> | Sprawling Blue Bell |
| <i>Wahlenbergia luteola</i> | Yellow-backed Blue Bell |
| <i>Wahlenbergia stricta</i> | Tall Blue Bell |
| <i>Wurmbea dioica</i> | Early Nancies |
| <i>Xanthorrhoea minor</i> | Small Grass Tree |
| <i>Xerochrysum bracteatum</i> | Golden Everlasting |
| <i>Xerochrysum palustre</i> | Swamp Everlasting |
| <i>Xerochrysum viscosum</i> | Sticky Everlasting |

12.5 Small to Medium Shrubs (1 – 3 m)

(R denotes RURAL SPECIES LIST and only where ongoing pest plant maintenance will not be an issue)

| <i>Botanical Name</i> | <i>Common Name</i> |
|-------------------------------------------------------------|-----------------------------|
| Small to Medium Shrubs | |
| <i>Acacia acinacea</i> R | Gold Dust Wattle |
| <i>Acacia decora</i> | Western silver wattle |
| <i>Acacia gunnii</i> | Ploughshare Wattle |
| <i>Acacia mitchellii</i> | Mitchell's Wattle |
| <i>Astroloma conostephioides</i> | Flame Heath |
| <i>Astroloma pinifolium</i> | Pine Heath |
| <i>Baeckea crassifolia</i> | Desert Heath-myrtle |
| <i>Bossiaea cordigera</i> | Wiry Bossiaea |
| <i>Brachyloma daphnoides</i> | Daphne Heath |
| <i>Brachyloma ericoides</i> | Brush Heath |
| <i>Calytrix tetragona</i> | Common fringe myrtle |
| <i>Cassinia arcuata</i> R | Drooping Cassinia |
| <i>Cheiranthra cyanea</i> | Blue Finger Flower |
| <i>Chenopodium curvispicatum</i> | Cottony Salt Bush |
| <i>Chenopodium nitrariaceum</i> | Nitre goosefoot |
| <i>Correa lawrenceana</i> | Mountain Correa |
| <i>Correa reflexa</i> | Common Correa |
| <i>Crocea exalata</i> | Small Crocea |
| <i>Cryptandra amara</i> | Bitter Cryptandra |
| <i>Cryptandra tomentosa</i> | Prickly Cryptandra |
| <i>Dampiera dysantha</i> | Shrubby Dampiera |
| <i>Daviesia benthamii</i> | Spiny Bitter Pea |
| <i>Daviesia genistifolia</i> | Broom Bitter Pea |
| <i>Daviesia latifolia</i> | Hop Bitter Pea |
| <i>Derwentia derwentiana</i> | Derwent Speedwell |
| <i>Derwentia perfoliata</i> | Digger's Speedwell |
| <i>Dillwynia cinerascens</i> R | Grey Parrot Pea |
| <i>Dillwynia hispida</i> | Red Parrot Pea |
| <i>Dillwynia sericea</i> | Showy Parrot Pea |
| <i>Discaria pubescens</i> | Anchor Plant |
| <i>Epacris impressa</i> | Common Heath |
| <i>Eremophila glabra</i> R | Emu Bush |
| <i>Eremophila divaricata</i> | Spreading Emu Bush |
| <i>Euomyrtus ramosissima</i> | Rosy Heath-myrtle |
| <i>Eutaxia microphylla</i> var. <i>microphylla</i> R | Common Eutaxia |
| <i>Eutaxia microphylla</i> var. <i>diffusa</i> | Spineless Eutaxia |
| <i>Gompholobium huegelii</i> | Common Wedge Pea |
| <i>Goodenia varia</i> | Sticky Goodenia |
| <i>Grevillea alpina</i> | Cat's Claw (VR, MF, GF, NS) |
| <i>Grevillea dryophylla</i> | Goldfields Grevillea |
| <i>Grevillea micrantha</i> | Small-flower Grevillea |

| <i>Botanical Name</i> | <i>Common Name</i> |
|--------------------------------------------------|-----------------------|
| <i>Grevillea rosmarinifolia</i> | Rosemary Grevillea |
| <i>Halgania cyanea</i> | Mallee Blue Flower |
| <i>Hibbertia prostrata</i> | Bundled Guinea Flower |
| <i>Hibbertia humifusa</i> subsp. <i>humifusa</i> | Guinea flower |
| <i>Hibbertia obtusifolia</i> | Grey Guinea Flower |
| <i>Hibbertia riparia</i> | Erect Guinea Flower |
| <i>Hovea heterophylla</i> | Common Hovea |
| <i>Hybanthus floribundus</i> | Shrub Violet |
| <i>Lasiopetalum baueri</i> | Slender Velvet Bush |
| <i>Leucopogon ericoides</i> | Pink Beard Heath |
| <i>Leucopogon rufus</i> | Ruddy Beard Heath |
| <i>Leucopogon virgatus</i> | Common Beard Heath |
| <i>Malva australiana</i> | Australian Hollyhock |
| <i>Maireana brevifolia</i> | Yanga Bush |
| <i>Maireana microphylla</i> R | Eastern Cottonbush |
| <i>Maireana cheelii</i> | Chariot Wheels |
| <i>Maireana decalvans</i> | Black Cottonbush |
| <i>Melichrus urceolatus</i> | Urn Heath |
| <i>Micromyrtus ciliata</i> | Fringed Heath Myrtle |
| <i>Monotoca scoparia</i> | Prickly Broom Heath |
| <i>Olearia floribunda</i> | Heath Daisy Bush |
| <i>Olearia glandulosa</i> | Swamp Daisy Bush |
| <i>Olearia myrsinoides</i> | Silky Daisy Bush |
| <i>Olearia pannosa</i> subsp. <i>cardiocarpa</i> | Velvet Daisy Bush |
| <i>Olearia pimeleoides</i> | Pimelea Daisy Bush |
| <i>Ozothamnus retusus</i> | Rough Everlasting |
| <i>Phebalium festivum</i> | Dainty Phebalium |
| <i>Philothea angustifolia</i> | Small Leaf Waxflower |
| <i>Philothea pungens</i> | Prickly Waxflower |
| <i>Philothea verrucosa</i> | Bendigo Waxflower |
| <i>Philothea verrucosa</i> | Double White Form |
| <i>Pimelea curviflora</i> | Curved Rice Flower |
| <i>Pimelea glauca</i> | Smooth Rice Flower |
| <i>Pimelea humilis</i> | Small Rice Flower |
| <i>Pimelea linifolia</i> | Slender Rice Flower |
| <i>Pimelea phyllicoides</i> | Hairy Rice Flower |
| <i>Platylobium formosum</i> | Handsome Flat Pea |
| <i>Platylobium obtusangulum</i> | Common Flat Pea |
| <i>Prostanthera aspalathoides</i> | Scarlet Mint Bush |
| <i>Prostanthera saxicola</i> | Slender Mint Bush |
| <i>Pseudanthus ovalifolius</i> | Oval Leaf Pseudanthus |

| Botanical Name | Common Name |
|-----------------------------------------------------------------|-------------------------------|
| <i>Pultenaea humilis</i> | Dwarf Bush Pea |
| <i>Pultenaea largiflorens</i> | Twiggy Bush Pea |
| <i>Pultenaea laxiflora</i> | Loose Flower Bush Pea |
| <i>Pultenaea prostrata</i> | Silky Bush Pea |
| <i>Pultenaea reflexifolia</i> | Wombat Bush Pea |
| <i>Pultenaea scabra</i> | Rough Bush Pea |
| <i>Rhagodia spinescens</i> R | Hedge Saltbush |
| <i>Rhytidosporum procumbens</i> | White Marianth |
| <i>Senecio odoratus</i> | Scented Groundsel |
| <i>Senna artemisioides</i> subsp. <i>zygophylla</i> R | Desert Cassia |
| <i>Spyridium eriocephalum</i> | Heath Spyridium |
| <i>Templetonia stenophylla</i> | Leafy Templetonia |
| <i>Tetratheca ciliata</i> | Pink Bells |
| <i>Vittadinia cuneata</i> (v. <i>gracilis</i>) | Woolly New Holland Daisy |
| <i>Vittadinia muelleri</i> | Narrow-leaf New Holland Daisy |
| <i>Westringia eremicola</i> | Slender Westringia |
| <i>Zieria aspalathoides</i> | Whorled Zieria/Sandfly Bush |

12.6 Medium to Large Shrubs (3 - 5 m)

(R denotes RURAL SPECIES LIST and only where ongoing pest plant maintenance will not be an issue)

| <i>Botanical Name</i> | <i>Common Name</i> |
|------------------------------------------------------------|---------------------------|
| Medium to Large Shrubs | |
| <i>Acacia aspera</i> | Rough Wattle |
| <i>Acacia ausfeldii</i> | Whipstick Cinnamon Wattle |
| <i>Acacia brachybotrya</i> R | Grey Mulga |
| <i>Acacia deanei</i> subsp. <i>paucijuga</i> | Deane's Wattle |
| <i>Acacia difformis</i> | Drooping Wattle |
| <i>Acacia euthycarpa</i> | Wallowa |
| <i>Acacia flexifolia</i> | Bent Leaf Wattle |
| <i>Acacia genistifolia</i> | Spreading Wattle |
| <i>Acacia hakeoides</i> R | Hakea Wattle |
| <i>Acacia lanigera</i> | Woolly Wattle |
| <i>Acacia leprosa</i> | Cinnamon Wattle |
| <i>Acacia ligulata</i> R | Small Cooba |
| <i>Acacia lineata</i> | Streaked Wattle |
| <i>Acacia melvillei</i> R | Yarran |
| <i>Acacia microcarpa</i> | Manna Wattle |
| <i>Acacia mitchellii</i> | Mitchell's Wattle |
| <i>Acacia montana</i> R | Mallee Wattle |
| <i>Acacia mucronata</i> | Variable Sallow Wattle |
| <i>Acacia oswaldii</i> R | Umbrella Wattle |
| <i>Acacia oxycedrus</i> | Spike Wattle |
| <i>Acacia paradoxa</i> | Hedge Wattle |
| <i>Acacia pendula</i> R | Weeping Myall |
| <i>Acacia penninervis</i> R | Hickory Wattle |
| <i>Acacia pravissima</i> | Oven's Wattle |
| <i>Acacia pycnantha</i> R | Golden Wattle |
| <i>Acacia retinodes</i> | Wirilda |
| <i>Acacia rigens</i> | Nealie |
| <i>Acacia rubida</i> | Red Stem Wattle |
| <i>Acacia verniciflua</i> R | Varnish Wattle |
| <i>Acacia verticillata</i> | Prickly Moses |
| <i>Acacia williamsonii</i> | Whirrakee Wattle |
| <i>Allocasuarina muelleriana</i> | Slaty She Oak |
| <i>Astrotricha asperifolia</i> | Rough Starhair |
| <i>Atriplex rhagodioides</i> | Silver Salt Bush |
| <i>Babingtonia behrii</i> | Broom Baeckea |
| <i>Baeckea utilis</i> | Mountain Baeckea |
| <i>Banksia marginata</i> R | Silver Banksia |
| <i>Boronia anemonifolia</i> | Sticky Boronia |
| <i>Bursaria spinosa</i> subsp. <i>lasiophylla</i> R | Bursaria |
| <i>Bursaria spinosa</i> subsp. <i>spinosa</i> R | Sweet Bursaria |

| <i>Botanical Name</i> | <i>Common Name</i> |
|-------------------------------------------------------------------|-----------------------------|
| <i>Callistemon citrinus</i> | Crimson bottlebrush |
| <i>Callistemon rugulosus</i> | Scarlet Bottlebrush |
| <i>Callistemon salignus</i> | White weeping bottlebrush |
| <i>Callistemon sieberi</i> R | River Bottlebrush |
| <i>Calytrix tetragona</i> R | Common Fringe Myrtle |
| <i>Cassinia aculeata</i> | Dogwood |
| <i>Cassinia arcuata</i> R | Drooping Cassinia |
| <i>Cassinia longifolia</i> | Shiny Cassinia |
| <i>Cassinia ozothamnoides</i> | Cottoney Haeckeria |
| <i>Cassinia uncata</i> | Sticky Cassinia |
| <i>Coprosma quadrifida</i> | Prickly Currant Bush |
| <i>Correa glabra</i> | Rock Correa |
| <i>Daviesia arenaria</i> | Sandhill Bitter Pea |
| <i>Daviesia benthamii</i> subsp. <i>humilis</i> | Spiny Bitter Pea |
| <i>Daviesia latifolia</i> | Hop Bitter Pea |
| <i>Daviesia leptophylla</i> | Narrow Leaf Bitter Pea |
| <i>Daviesia ulicifolia</i> | Gorse Bitter Pea |
| <i>Dillwynia phyllicoides</i> | Small Leaf Parrot Pea |
| <i>Dillwynia ramosissima</i> | Bushy Parrot Pea |
| <i>Dodonaea viscosa</i> subsp. <i>angustissima</i> R | Narrow-leaf Hop-bush |
| <i>Dodonaea viscosa</i> subsp. <i>cuneata</i> R | Wedge-leaf Hop Bush |
| <i>Dodonaea viscosa</i> subsp. <i>spatulata</i> R | Sticky Hop-Bush |
| <i>Eremophila bignoniiflora</i> R | Creek Wilga |
| <i>Eremophila deserti</i> | Turkey Bush |
| <i>Eremophila longifolia</i> R | Berrigan Emu Bush |
| <i>Exocarpos strictus</i> | Dwarf Cherry |
| <i>Goodenia ovata</i> | Hop Goodenia |
| <i>Goodia lotifolia</i> | Golden Tip Goodenia |
| <i>Goodia medicaginea</i> | Western Golden Tip Goodenia |
| <i>Grevillea rosmarinifolia</i> | Rosemary grevillea |
| <i>Hakea decurrens</i> subsp. <i>physocarpa</i> | Bushy Needlewood |
| <i>Hakea laurina</i> | Kodset pincushion |
| <i>Hakea tephrosperma</i> R | Hooked Needlewood |
| <i>Hovea asperifolia</i> subsp. <i>asperifolia</i> | Mountain Beauty |
| <i>Indigofera australis</i> | Indigofera |
| <i>Kunzea</i> sp. - <i>Burgan</i> (formerly <i>K. ericoides</i>) | Burgan |
| <i>Lasiopetalum behrii</i> | Pink Velvet Bus |
| <i>Leptomeria aphylla</i> | Leafless Currant Bush |

| Botanical Name | Common Name |
|------------------------------------------------------------|---------------------------|
| <i>Leptospermum continentale</i> | Prickly Tea Tree |
| <i>Leptospermum lanigerum</i> | Woolly Tea Tree |
| <i>Leptospermum myrsinoides</i> | Heath Tea Tree |
| <i>Leptospermum obovatum</i> R | River Tea Tree |
| <i>Logania albiflora</i> | Narrow Leaf Logania |
| <i>Melaleuca acuminata</i> | Mallee Honey Myrtle |
| <i>Melaleuca decussata</i> | Cross-leaf honey myrtle |
| <i>Melaleuca lanceolata</i> R | Moonah |
| <i>Melaleuca parvistaminea</i> | Rough-barked Honey Myrtle |
| <i>Melaleuca uncinata</i> | Broom Honey Myrtle |
| <i>Melaleuca wilsonii</i> | Violet Honey Myrtle |
| <i>Melicytus dentatus</i> | Tree Violet |
| <i>Mirbelia oxylobioides</i> | Mountain Mirbelia |
| <i>Muehlenbeckia florulenta</i> R | Tangled Lignum |
| <i>Myoporum montanum</i> R | Waterbush |
| <i>Myoporum platycarpum</i> R | Sugarwood |
| <i>Nitraria billardierei</i> R | Dillon Bush |
| <i>Olearia argophylla</i> | Musk Daisy Bush |
| <i>Olearia decurrens</i> | Clammy Daisy Bush |
| <i>Olearia lirata</i> | Snow Daisy Bush |
| <i>Olearia phlogopappa</i> | Dusty Daisy Bush |
| <i>Olearia teretifolia</i> | Cypress Daisy Bush |
| <i>Olearia tubuliflora</i> | Rayless Daisy Bush |
| <i>Ozothamnus ferrugineus</i> | Tree Everlasting |
| <i>Ozothamnus obcordatus</i> | Grey Everlasting |
| <i>Ozothamnus rosmarinifolius</i> | Rosemary Everlasting |
| <i>Persoonia rigida</i> | Stiff Geebung |
| <i>Pimelea axiflora</i> subsp. <i>axiflora</i> | Bootlace Bush |
| <i>Pittosporum angustifolium</i> R | Weeping Pittosporum |
| <i>Pomaderris aspera</i> | Hazel Pomaderris |
| <i>Pomaderris paniculosa</i> subsp. <i>paniculosa</i> | Inland Pomaderris |
| <i>Pomaderris racemosa</i> | Cluster Pomaderris |
| <i>Pomaderris vacciniifolia</i> | Round-leaf Pomaderris |
| <i>Prostanthera denticulata</i> | Rough Mint Bush |
| <i>Prostanthera lasianthos</i> var. <i>lasianthos</i> | Victorian Christmas Bush |
| <i>Prostanthera nivea</i> | Snowy Mint Bush |
| <i>Pultenaea daphnoides</i> | Large-leaf Bush Pea |
| <i>Pultenaea graveolens</i> | Scented Bush Pea |
| <i>Pultenaea platyphylla</i> | Flat-leaf Bush Pea |
| <i>Senna artemisioides</i> subsp. <i>coriacea</i> R | Desert Cassia |

| Botanical Name | Common Name |
|--------------------------------------------------------------|----------------------|
| <i>Senna artemisioides</i> subsp. <i>petiolaris</i> | Woody Cassia |
| <i>Senna artemisioides</i> subsp. <i>zygophylla</i> R | Desert Cassia |
| <i>Solanum laciniatum</i> | Kangaroo Apple |
| <i>Solanum simile</i> | Oondoroo |
| <i>Spyridium parvifolium</i> | Dusty Miller |
| <i>Viminaria juncea</i> | Golden Spray |
| <i>Westringia crassifolia</i> | Whipstick Westringia |
| <i>Xanthorrhoea glauca</i> subsp. <i>angustifolia</i> | Grass Tree |

12.7 Native Trees

(R denotes RURAL SPECIES LIST)

| <i>Botanical Name</i> | <i>Common Name</i> | <i>Size h x w</i> | <i>Botanical Name</i> | <i>Common Name</i> | <i>Size h x w</i> |
|------------------------------------------------------------------|-----------------------|-------------------|----------------------------------------------------------------------------|----------------------------------|-------------------|
| Small-Medium Trees <10m | | | Large Trees >10m | | |
| <i>Acacia dealbata</i> R | Silver Wattle | 5-10 x 3-5m | <i>Acacia salicina</i> R | Native Willow | 10-15 x 5-7m |
| <i>Acacia implexa</i> R | Lightwood | 5-10 x 3-5m | <i>Acacia stenophylla</i> R | Eumong | 5 -20 x 3-10m |
| <i>Acacia mearnsii</i> | Late Black Wattle | 10 x 5m | <i>Angophora costata</i> | Smooth-barked Apple | 15-30 x 8-15 |
| <i>Acacia melanoxylon</i> | Blackwood | 10m x 5m | <i>Callitris glaucophylla</i> R | Murray Pine (White Cypress Pine) | 3-15 x 2-7m |
| <i>Acacia pendula</i> | Weeping Boree | 5-12 x 3-6m | <i>Callitris gracilis</i> | Slender Cypress Pine | 20 x 10m |
| <i>Allocasuarina littoralis</i> | Black Sheoak | 5-15 x 3-8m | <i>Corymbia citriodora</i> | Lemon Scented Gum | 20 x 8m |
| <i>Allocasuarina luehmannii</i> R | Buloke | 5-15 x 3-8m | <i>Corymbia maculata</i> | Spotted Gum | 30 x 10m |
| <i>Allocasuarina verticillata</i> | Drooping Sheoak | 10 x 5m | <i>Casuarina cristata</i> | Belah | 10-20 x 4-8m |
| <i>Angophora cordifolia</i> | Dwarf Apple Myrtle | 7-10 x 4-5m | <i>Eucalyptus albens</i> R | White Box | 10-15 x 8-10m |
| <i>Brachychiton populneus</i> <i>subsp. populneus</i> | Kurrajong | 6-15 x 4-8m | <i>Eucalyptus baxteri</i> | Brown Stringybark | 20-30 x 8-15m |
| <i>Brachychiton acerifolius</i> x <i>populneus</i> | Hybrid Flame Tree | 8-10 x 4-5m | <i>Eucalyptus behriana</i> | Bull Mallee | 10-12 x 5-6m |
| <i>Bursaria spinosa</i> <i>subsp.</i> <i>spinosa</i> R | Sweet Bursaria | 3-10 x 2-5m | <i>Eucalyptus blakelyi</i> | Blakely's Red Gum | 20 x 8m |
| <i>Callitris rhomboidea</i> | Port Jackson Pine | 6 x 3m | <i>Eucalyptus camaldulensis</i> R (for natural water areas only) | River Red Gum | 30 x 15m |
| <i>Corymbia ficifolia</i> | Scarlet Flowering Gum | 6-10 x 3-5m | <i>Eucalyptus dives</i> | Broad Leaf Peppermint | 10-20 x 4-8m |
| <i>Eucalyptus behriana</i> | Bull Mallee | 10-12 x 5-6m | <i>Eucalyptus froggattii</i> | Kamarooka Mallee | 5-12 x 4-8m |
| <i>Eucalyptus caesia</i> | Silver Princess | 8 x 4m | <i>Eucalyptus globulus</i> <i>subsp.</i> <i>bicostata</i> | Eurabbie | 30-50 x 15-30m |
| <i>Eucalyptus calycogona</i> | Red Mallee | 5 x 4m | <i>Eucalyptus goniocalyx</i> | Long Leaved Box | 15 x 7m |
| <i>Eucalyptus dumosa</i> | Dumosa Mallee | 6 x 4m | <i>Eucalyptus largiflorens</i> R | Black Box | 20 x 10m |
| <i>Eucalyptus froggattii</i> | Kamarooka Mallee | 5-12 x 4-8m | <i>Eucalyptus leucoxydon</i> <i>subsp.</i> <i>pruinosa</i> | Yellow Gum | 20-25 x 10-12m |
| <i>Eucalyptus leucoxydon</i> | Flowering Gum | 9-15 x 5-8 | <i>Eucalyptus macrorhyncha</i> | Red Stringy Bark | 25-35 x 13-17m |
| <i>Eucalyptus nortonii</i> | Mealy Bundy | 10-15 x 5-7m | <i>Eucalyptus melliodora</i> R | Yellow Box | 20-30 x 10-15m |
| <i>Eucalyptus polybractea</i> | Blue Mallee | 8 x 5m | <i>Eucalyptus microcarpa</i> R | Grey Box | 20-25 x 10-12m |
| <i>Eucalyptus viridis</i> | Green Mallee | 8 x 5m | <i>Eucalyptus obliqua</i> | Messmate | 30-60 x 15-30m |
| <i>Exocarpos cupressiformis</i> R | Cherry Ballart | 8 x 4m | <i>Eucalyptus ovata</i> | Swamp Gum | 20 x 10m |
| <i>Geijera parviflora</i> R | Wilga | 10 x 8m | <i>Eucalyptus pauciflora</i> <i>subsp.</i> <i>pauciflora</i> | Snow Gum | 20-30 x 10-15m |
| <i>Hakea tephrosperma</i> R | Hooked Needlewood | 5-8 x 3-4m | <i>Eucalyptus polyanthemos</i> | Red Box | 20-40 x 10-15m |
| <i>Hymenosporum flavum</i> | Native frangipani | 8-18 x 4-8m | <i>Eucalyptus radiata</i> | Narrow-leaved peppermint | 30-40 x 12-15m |
| <i>Melaleuca lanceolata</i> R | Moonah | | <i>Eucalyptus rubida</i> | Candlebark | 25-35 x 10-15m |
| <i>Melaleuca uncinata</i> | Broom Honey Myrtle | 5-8 x 3-4m | <i>Eucalyptus salmonophloia</i> | Salmon Gum | 20-30 x 20-15m |
| <i>Myoporum platycarpum</i> R | Sugarwood | 5-10 x 3-5m | <i>Eucalyptus tricarpa</i> | Red Ironbark | 25-35 x 10-15m |
| <i>Santalum acuminatum</i> R | Sweet Quandong | 5 x 4m | <i>Eucalyptus viminalis</i> | Manna Gum | 20-35 x 10-13m |
| <i>Tristaniopsis laurina</i> | Water Gum | 8-15 x 4-8m | <i>Hymenosporum flavum</i> | Native Frangipani | 8-18 x 4-8m |
| | | | <i>Stenocarpus sinuatus</i> | Firewheel tree | 15-20 x |

12.8 Exotic trees

| <i>Botanical Name</i> | <i>Common Name</i> | <i>Size h x w</i> |
|----------------------------------------------------------------|-------------------------|-------------------|
| Small-Medium Trees <10m | | |
| <i>Acer buergeranum</i> | Trident Maple | 5 x 3m |
| <i>Acer campestre</i> | Hedge Maple | 7 x 6m |
| <i>Acer negundo</i> 'Sensation' | Sensational Box Elder | 9 x 6m |
| <i>Arbutus unedo</i> | Strawberry Tree | 7 x 5m |
| <i>Calodendrum capense</i> | Cape Chestnut | 10 x 6m |
| <i>Gleditsia triacanthos</i> var. <i>inermis</i> 'Shademaster' | Green Honey Locust | 9-12 x 8-10m |
| <i>Koelreuteria paniculata</i> | Golden Rain Tree | 5 x 8m |
| <i>Malus X floribunda</i> | Japanese Flowering crab | 6 x 4m |
| <i>Malus ioensis</i> 'Plena' | Betchel crab apple | 4 x 3m |
| <i>Malus spectabilis</i> | Chinese crab | 8 x 4m |
| <i>Nyssa sylvatica</i> | Tupelo | 9-11 x 6m |
| <i>Lagerstroemia spp.</i> | Crepe Myrtle | 3-10 x 3-8m |
| <i>Pistacia chinensis</i> | Chinese Pistachio | 8 x 6m |
| <i>Prunus x blireana</i> | Double Flowering Pum | 4 x 4m |
| <i>Pyrus calleryana</i> 'Aristocrat' | Ornamental Pear | 10 x 7m |

| <i>Botanical Name</i> | <i>Common Name</i> | <i>Size h x w</i> |
|----------------------------------------------------------------|--------------------|-------------------|
| Large Trees >10m | | |
| <i>Acer x freemanii</i> 'Jefferson Red' | Jefferson Red | 13-15 x 5-7m |
| <i>Acer saccharinum</i> | Silver Maple | 12-15 x 10m |
| <i>Gleditsia triacanthos</i> var. <i>inermis</i> 'Shademaster' | Green Honey Locust | 9-12 x 8-10m |
| <i>Jacaranda mimosifolia</i> | Jacaranda | 10 x 8m |
| <i>Liriodendron tulipifera</i> | Tulip Tree | 15 x 15m |
| <i>Liquidamber styraciflua</i> | Liquidamber | 20 x 6m |
| <i>Magnolia grandiflora</i> | Bull Bay Magnolia | 25 x 10m |
| <i>Platanus (orientalis) X 'Chilensis'</i> | Plane | 18 x 8m |
| <i>Platanus orientalis</i> 'Digitata' | Cut Leaf Plane | 18 x 10m |
| <i>Quercus cerris</i> | Turkey Oak | 20 x 15m |
| <i>Quercus coccinea</i> | Scarlet Oak | 12-20 x 8-10m |
| <i>Quercus palustris</i> | Pin Oak | 15 x 8m |
| <i>Quercus robur</i> | English Oak | 20 x 20m |
| <i>Ulmus glabra</i> 'Lutescens' | Golden Elm | 10-12 x 10-12m |
| <i>Ulmus parvifolia</i> 'Todd' | Chinese Elm | 10-12 x 10-11m |
| <i>Sophora japonica</i> | Japanese Pagoda | 12-15 x 10m |
| <i>Zelkova serrata</i> 'Green Vase' | Japanese Zelkova | 14 x 10m |

NOTE: Refer to Greater Shepparton City Council Street Tree Master Plan for precinct plans. Approval of alternative Tree Species will be at the discretion of Council.

Tree species selections are to be discussed with relevant Council officers to ensure the selections are *the right tree for the right location*

12.9 Aquatic Plants

| <i>Botanical Name</i> | <i>Common Name</i> |
|-----------------------------------------------|----------------------------|
| Aquatic | |
| Submerged Marsh (0.4 -0.9m below TWL) | |
| <i>Potamogeton ochreatus</i> | Blunt Pondweed |
| <i>Potamogeton tricarlinatus</i> | Floating Pondweed |
| <i>Triglochin procera (T. procerum)</i> | Water Ribbons |
| Deep Marsh (0.2 - 0.4m below TWL) | |
| <i>Baumea articulata</i> | Jointed Twig-rush |
| <i>Eleocharis sphacelata</i> | Tall Spike Rush |
| <i>Myriophyllum papillosum</i> | Robust Milfoil |
| <i>Nymphoides crenata</i> | Wavy Marshwort |
| <i>Ottelia ovalifolia</i> | Swamp Lily |
| <i>Potamogeton ochreatus</i> | Blunt Pondweed |
| <i>Potamogeton tricarlinatus</i> | Floating Pondweed |
| <i>Schoenoplectus tabernaemontani</i> | Grey Club-rush |
| <i>Triglochin procera (T. procerum)</i> | Water Ribbons |
| Shallow Marsh (0 - 0.2m below TWL) | |
| <i>Alisma plantago-aquatica</i> | Common water plantain |
| <i>Amphibromus nervosus</i> | Common Swamp Wallaby Grass |
| <i>Bolboschoenus caldwellii</i> | Marsh Club-rush |
| <i>Cyperus exaltatus</i> | Tall Flat-sedge |
| <i>Eleocharis acuta</i> | Common Spike-rush |
| <i>Juncus amabilis</i> | Gentle Rush |
| <i>Juncus flavidus</i> | Rush |
| <i>Juncus holoschoenus</i> | Joint-leaved Rush |
| <i>Juncus semisolidus</i> | Rush |
| <i>Marsilea costulifera</i> | Narrow-leaf Nardoo |
| <i>Marsilea drummondii</i> | Common Nardoo |
| <i>Marsilea hirsuta</i> | Short Fruit Nardoo |
| <i>Myriophyllum crispatum</i> | Upright Water-milfoil |
| <i>Myriophyllum papillosum</i> | Robust Milfoil |
| <i>Nymphoides crenata</i> | Wavy Marshwort |
| <i>Persicaria decipiens</i> | Slender Knotweed |
| <i>Persicaria hydropiper</i> | Water Pepper |
| <i>Ranunculus inundatus</i> | River Buttercup |
| <i>Triglochin procera (T. procerum)</i> | Water Ribbons |
| Ephemeral Marsh (Temporary inundation) | |
| <i>Brachyscome basaltica</i> | Swamp Daisy |
| <i>Carex appressa</i> | Tall Sedge |
| <i>Carex inversa</i> | Knob Sedge |

| <i>Botanical Name</i> | <i>Common Name</i> |
|------------------------------------------|---------------------------|
| <i>Carex tereticaulis</i> | Rush Sedge |
| <i>Crassula helmsii</i> | Swamp Crassula |
| <i>Dichondra repens</i> | Kidney-weed |
| <i>Eleocharis acuta</i> | Common Spike-rush |
| <i>Eryngium ovinum</i> | Blue Devil |
| <i>Isolepis inundata</i> | Swamp Club Rush |
| <i>Juncus flavidus</i> | Rush |
| <i>Juncus usitatus</i> | Common Rush |
| <i>Lythrum salicaria</i> | Purple Loosestrife |
| <i>Mentha australis</i> | River Mint |
| <i>Mentha diemenica</i> | Slender Mint |
| <i>Mentha satuireioides</i> | Creeping Mint |
| <i>Mimulus gracilis</i> | Slender Monkey Flower |
| <i>Paspalidium jubiflorum</i> | Warrego Summer-grass |
| <i>Pycnosorus globosus</i> | Slender Knotweed |
| <i>Poa labillardieri</i> | Tussock Grass |
| <i>Pycnosaurus globosus</i> | Drumstick Billy Buttons |
| <i>Triglochin striatum</i> | Streaked Arrow-grass |
| <i>Wahlenbergia fluminalis</i> | River Bluebell |
| Wetland margin (capillary action) | |
| <i>Brachyscome basaltica</i> | Swamp Daisy |
| <i>Calocephalus citreus</i> | Lemon Beauty Heads |
| <i>Calotis anthemoides</i> | Cut-leaf Burr-daisy |
| <i>Calotis scapigera</i> | Tufted Burr-daisy |
| <i>Carex appressa</i> | Tall Sedge |
| <i>Carex inversa</i> | Knob Sedge |
| <i>Carex tereticaulis</i> | Rush Sedge |
| <i>Chloris truncata</i> | Windmill Grass |
| <i>Dianella revoluta</i> | Black-anther Flax-lily |
| <i>Einadia nutans</i> | Nodding Saltbush |
| <i>Enchylaena tomentosa</i> | Ruby Saltbush |
| <i>Eryngium ovinum</i> | Blue Devil |
| <i>Juncus usitatus</i> | Common Rush |
| <i>Lythrum salicaria</i> | Purple Loosestrife |
| <i>Mentha diemenica</i> | Slender Mint |
| <i>Paspalidium jubiflorum</i> | Warrego Summer-grass |
| <i>Poa labillardieri</i> | Tussock Grass |
| <i>Pycnosaurus globosus</i> | Drumstick Billy Buttons |
| <i>Rytidosperma caespitosum</i> | Ringed Wallaby Grass |
| <i>Rytidosperma setaceum</i> | Smallflower Wallaby Grass |
| <i>Themeda triandra</i> | Kangaroo Grass |



13. ENVIRONMENTAL WEEDS

Environmental weeds are plants that invade areas of natural bushland. Weeds include both introduced plants and native plants that originally come from other areas of Australia. It is important to ensure these environmental weed species are not used in the landscape of any development as they could escape into the local environment and threaten the health of native bushland areas.

While a number of species have traditionally been used in recent years, these species should be avoided due to issues associated with vermin, safety and the environment.

Further information on weeds can be obtained from the below links

<http://agriculture.vic.gov.au/agriculture/pests-diseases-and-weeds/weeds/a-z-of-weeds>

<http://www.weeds.org.au/vicmap.htm>

WEED SPECIES AND NATIVE ALTERNATIVES

| <i>Botanical name</i> | <i>Common Name</i> | <i>Native Alternative</i> |
|-------------------------------|--------------------|-------------------------------------------------------------------------------------------------------------|
| <i>Fraxinus rotundifolia</i> | Desert Ash | <i>Euc. polyanthemos</i> |
| <i>Schinus molle</i> | Peppercorn | <i>Acacia salicina</i> |
| <i>Salix spp.</i> | Willow | <i>Callistemon sieberi</i> <i>Acacia dealbata</i> <i>Acacia salicina</i> <i>Geijera parviflora</i> |
| <i>Acacia baileyana</i> | Cootamundra Wattle | <i>Acacia dealbata</i> <i>Acacia pycnantha</i> <i>Acacia implexa</i> |
| <i>Crataegus monogyna</i> | Hawthorn | <i>Acacia paradoxa</i> <i>Bursaria spinosa</i> |
| <i>Cotoneaster divaricata</i> | Cotoneaster | <i>Dodonea viscosa ssp. cuneata</i> |
| <i>Genista monspessulana</i> | Montpellier Broom | <i>Acacia verniciflua</i> <i>Acacia acinacea</i> |
| <i>Agapanthus orientalis</i> | Africa Lily | <i>Dianella revoluta</i> |
| <i>Hedera helix</i> | Ivy | <i>Hardenbergia violacea</i> <i>Einadia nutans</i> <i>Enchylaena tomentosa</i> |

OTHER ENVIRONMENTAL WEED SPECIES TO BE AVOIDED

| Botanical Name | Common Name |
|-------------------------------|-------------------------|
| TREES & SHRUBS | |
| <i>Acacia saligna</i> | Golden Wreath Wattle |
| <i>Phoenix canariensis</i> | Canary Island Date Palm |
| <i>Poplar spp.</i> | Poplar |
| <i>Prunus cerasifera</i> | Cherry Plum |
| <i>Ligustrum lucidum</i> | Privet |
| AQUATIC PLANTS | |
| <i>Nymphaea Mexicana</i> | Yellow Water-lily |
| <i>Tradescantia albiflora</i> | Wandering Jew |
| <i>Vinca major</i> | Blue Periwinkle |
| HERBS AND GRASSES | |
| <i>Avena fatua</i> | Wild Oat |
| <i>Chicorium intypus</i> | Chicory |
| <i>Foeniculum vulgare</i> | Fennel |
| <i>Nassella neesiana</i> | Chilean Needlegrass |
| <i>Phalaris paradoxa</i> | Phalaris |
| <i>Rumex crispus</i> | Curled Dock |



SECTION 8

LANDSCAPE STANDARDS

MATERIALS AND TECHNIQUES

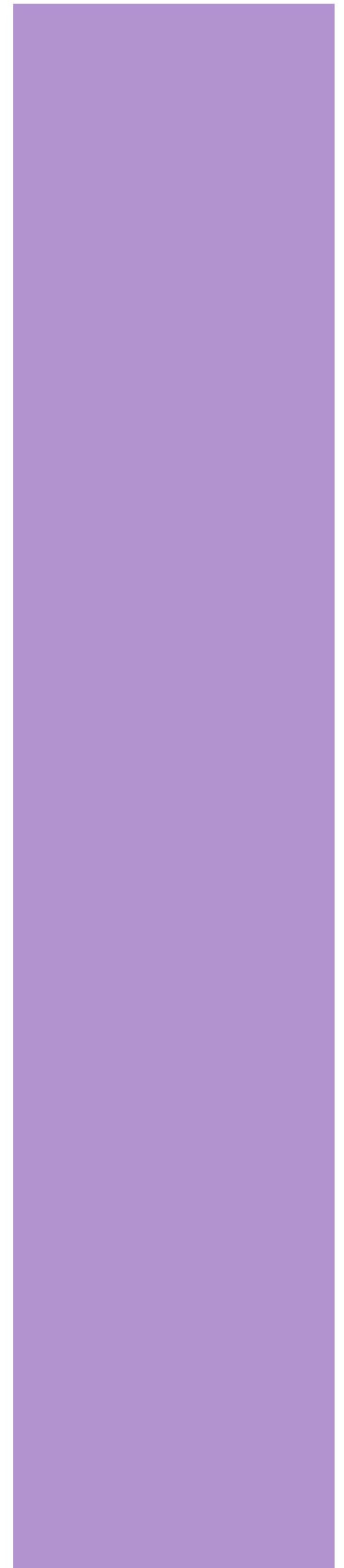

14. LANDSCAPE STANDARDS – MATERIALS AND TECHNIQUES

The following materials and techniques are provided as a guide for design and specification of landscape works.

These standards provide similar requirements across the Moira Shire, the Shire of Campaspe and the City of Greater Shepparton.

Further information for maintenance and handover requirements is to be obtained from each Council.

The following materials and techniques are to be read in conjunction with the Infrastructure Design Manual (IDM).

The Greater Shepparton City Council Parks, Sport and Recreation Department Developers Guideline document should be read in conjunction with this Landscape Plan Guide for supplementary information and specifications for landscape works within the City of Greater Shepparton.

EARTHWORKS, DRAINAGE, WATER SENSITIVE URBAN DESIGN AND EASEMENTS

Purpose

To ensure:

- ▶ That earthworks and drainage systems are implemented to maximise the on-site retention and infiltration of stormwater.
- ▶ Positive effect on existing wetlands, watercourses and water bodies.

Earthworks and Drainage

- ▶ Earthworks design shall incorporate features and functions of the site's natural drainage system and shall maximise on-site retention and infiltration of stormwater and any irrigation.
- ▶ Where a site is adjacent to a natural aquatic system, earthworks design shall provide for surface runoff to be contained and treated within the site prior to release into the natural system.
- ▶ Parks and Reserves are to be freely draining.
- ▶ Full drainage specifications are to be shown on plans.
- ▶ Heavy duty accessible pits to be used.

Slopes, Banks and Batters

- ▶ Slopes less than 1:3: non irrigated slopes with gradient 1:3 or less to have adequate established vegetation of at least 90% cover at handover. Grassing is to be drilled or hydromulched.
- ▶ Slopes greater than 1:3 are to be stabilised with 100% cover by either:
 - ▶ Retaining walls plus vegetation.
 - ▶ Slope reinforcement mesh/geo-cell plus vegetation.
 - ▶ Seeded then hydro-mulched plus addition of straw.
 - ▶ Non-woven geotextile and >150mm spalls.
- ▶ Run off areas: where concentrated rainfall runoff is directed onto a slope and not through drainage pipework, the slope must be stabilised with non-woven geotextile and established vegetation or rock riprap as minimum.
- ▶ Any concrete type inlet/outlet structure on or in a slope or batter to be stabilised with non-woven geotextile and riprap.

Water Sensitive Urban Design

- ▶ Water Sensitive Urban Design shall be incorporated into drainage design through the provision of on site stormwater treatment to achieve best practice outcomes.
- ▶ Species selection is to be locally available indigenous species from the species list contained in this document.
- ▶ Provide adequate maintenance access for maintenance machinery.
- ▶ Design wetland system with ability to easily draw down all sections to submerged marsh level for dewatering for maintenance and system health.
- ▶ Swales are to be grassed or include mulch media and vegetation.

- ▶ Swale mulch media shall include installation gravel/coarse granitic mulch layer or rock beaching at inlet locations (refer Council for depth).
- ▶ Vegetation with appropriate plant species is to completely surrounding any outlet pit.
- ▶ Terrestrial planting areas are to be protected and stabilised with mulch, slotted jute mat or mesh (or similar approved by Council).
- ▶ Aquatic vegetation in shallow marsh, deep marsh and ephemeral areas should be protected during establishment period with the use of netting to achieve at least 80% survival rate at handover.
- ▶ Floodways and open native grassland areas are to be seeded to have established grass cover of at least 90% at handover.

Easements

- ▶ Soft landscape works (except some trees) are permitted on most service easements provided that the works will not damage or create risk to services within the easement.
- ▶ Offset requirements should be followed. Service providers cannot be held responsible for any damage caused when accessing services within the easement.
- ▶ Permanent structures should not be constructed within easements unless site specific arrangements and agreements are made with Council.

IRRIGATION AND WATER

Purpose

To ensure that when provision of water and irrigation systems are required they are designed and installed:

- ▶ To provide reliable and effective use of water resources.
- ▶ To minimise water use and wastage.
- ▶ To prevent damage to irrigation equipment.
- ▶ To allow cost effective maintenance of irrigation components.

General Requirements

- ▶ Considerations should be made for potable water connection for future infrastructure installations such as drinking fountains.
- ▶ Open space sites should have a minimum of 20mm water tapping.
- ▶ Water meters must be above ground and housed in lockable cage.
- ▶ Irrigation shall be designed and installed to the Council’s irrigation specifications.
- ▶ Irrigation system designs shall be submitted with Landscape Construction Plans for Council approval prior to any landscape works being undertaken.
- ▶ All irrigation designs shall be designed to achieve best practice outcomes, with the location and type of spray outlet selected to avoid water spray onto roads, crossovers, paths, other paved areas and playground equipment.



Irrigation controller example



Water meter cage example



Irrigation cabinet example



Hydrawise controller example

- ▶ Non potable water supply should be first supply option.
- ▶ Potable water supply for irrigation requires minimum 32mm tapping.
- ▶ Irrigation within planting and grass areas shall be by pop up sprays or rotor sprinklers. No part shall protrude above ground level except for pop-up sprinklers during operation.
- ▶ Sub surface dripper line may be possible only in garden beds subject to discussions with Council prior to design work.
- ▶ Install all solenoid valves, isolating valves and/or gate valves within public space where practical for commissioning and maintenance.
- ▶ Where irrigation is on a pump system the use of multistage pumps with variable speed drives are required in a fully enclosed lockable pump shed.
- ▶ Valve boxes must be heavy duty type and needs to be installed on treated pine sleepers to ensure finished level of valve box meets flush with ground height.
- ▶ Isolation points are to be provided at every valve with a main isolation point on the discharge side of a meter pump.
- ▶ Confirm with Council the preferred irrigation controllers (e.g. Hunter ACC) to ensure it can be linked into Council's Central Control Irrigation System.
- ▶ Specified irrigation controllers must be installed for station numbers greater than 10 to allow for offsite programming.
- ▶ Irrigation controllers to be housed in a lockable cabinet allowing the installation of a padlock.
- ▶ Irrigation systems less than 10 stations must be controlled through controller (e.g. 'Hydrawise') to allow for onsite programming.
- ▶ Council prefers the use of mains power to run irrigation controllers. In the event of no mains power, Council prefers the use of controllers that are installed in above ground cabinets (e.g. XC Hybrid Hunter).
- ▶ Council prefers the use of sprays or rotor sprinklers in irrigation systems for both lawn and garden areas. Sub surface dripper line may be possible only in garden beds but will need to be discussed with Council prior to design work.
- ▶ If irrigation is supplied by a pump system the use of multistage pumps with variable speed drives are required in a fully enclosed lockable pump shed.



Valve box example



Isolation point example



Isolation point example



Pop up spray example

Maintenance

- ▶ Irrigation systems are to be maintained in accordance with Council irrigation specifications.

TREES

Purpose

To ensure:

- ▶ Trees are chosen to reflect the local character and conditions.
- ▶ Trees provide attractive streetscapes (according to street hierarchy) and the environmental benefits of shade, improved micro-climate and wildlife habitat.
- ▶ Trees do not interfere with lighting, paving or other public infrastructure.
- ▶ Acceptable maintenance obligations.

General Requirements

- ▶ Tree planting is required to comply with Council's tree planting guidelines.
- ▶ All proposed trees will be described in submitted Landscape Plans and will require Council approval.
- ▶ Trees are to be grown and supplied to Australian Standards.
- ▶ Tree planting in roads controlled by VicRoads shall also comply with VicRoads standards.

Approved Plant Species List

- ▶ Tree species used within the Council areas may be native, locally indigenous and exotic.

Tree species selection is to be from the Tree Species list contained in this document or other approved tree planting lists or approved Street Tree Master Plans relevant to each Shire.

Setout Requirements

- ▶ Street trees shall be planted at the following average spacing intervals:
 - ▶ 8.0 m spacing for small trees (less than 10 m canopy).
 - ▶ 10 m spacing for medium trees (10 – 15 m canopy).
 - ▶ 12 + m spacing for large trees (canopy larger than 15 m).
- ▶ Street trees are to be planted with minimum one tree per property frontage.
- ▶ Private front yards shall have one medium to large tree where possible.
- ▶ Corner properties require two or three trees per side street nature strip, subject to the width and length of property.
- ▶ Deciduous tree plantings are discouraged within 120 m of any natural and/or existing and proposed wetland.
- ▶ Car park areas require a minimum of 1 tree per every 4 car parking bays.
- ▶ Depending on the type of tree, trees shall not be planted less than the following offset measurements existing elements, unless otherwise approved:
 - ▶ 1.2m from pedestrian pathways.
 - ▶ 3.0m from pedestrian pathways in a open space areas.
 - ▶ 3.0m from driveways and crossovers.

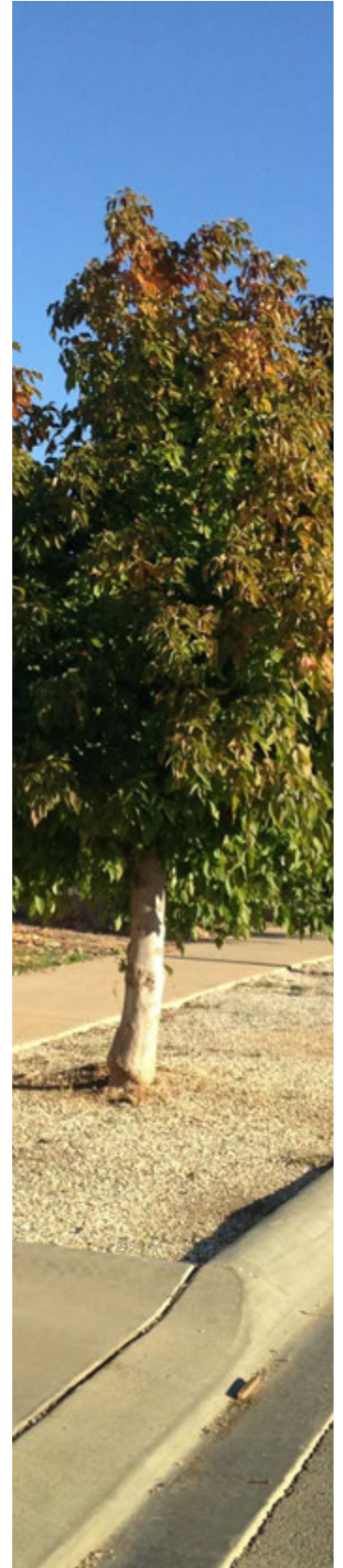

- ▶ 2.0m from stormwater and sewerage pits.
- ▶ Ensure clear sight lines at intersections.
- ▶ 2.0m from service crossings.
- ▶ 1.5m from the face of kerb or edge of road pavement.
- ▶ 4.0m from a street lights or power poles.
- ▶ 2.0m from service assets including junction boxes, pits etc.
- ▶ 3.0m from fire hydrants.
- ▶ 3.0m to 6.0m apart in open space areas to allow ride-on mowing maintenance between each tree.
- ▶ Root control barriers are required on trees that are to be planted within 1.8m of paths and paving.
- ▶ 1.0m tree basins for watering.

Medians

- ▶ Central medians in municipal roads will be planted with trees where:
 - ▶ The median is greater than 4.0m wide with trees located centrally at a minimum spacing of 6.0m.
 - ▶ Medians less than 4.0m are considered by Council to be appropriate for trees.
 - ▶ Medians with flush kerbs to the finished road surface include approved safety measures including bollards with reflective tape.

Roundabouts

- ▶ Roundabouts in municipal roads will be planted with trees where:
 - ▶ The roundabout is less than 10m diameter and will include three single stem trees centrally located with maximum mature height of 8.0m.
 - ▶ The roundabout is greater than 10m in diameter and will include trees centrally located with maximum mature height greater than 8.0m.

Installation size

- ▶ Tree installation size shall be:
 - ▶ A minimum of 1.5m to 2.0m tall and either a 45 or 100 litre container for all streetscape work and 30 to 40mm caliper.
 - ▶ Tube stock for revegetation and or mass planting situations.
- ▶ Refer 'A Guide to Specifying Trees' by Ross Clarke.
- ▶ Refer natspec.com.au

Maintenance

- ▶ Tree maintenance shall be carried out in accordance with Council's maintenance standards and Australian Standards.

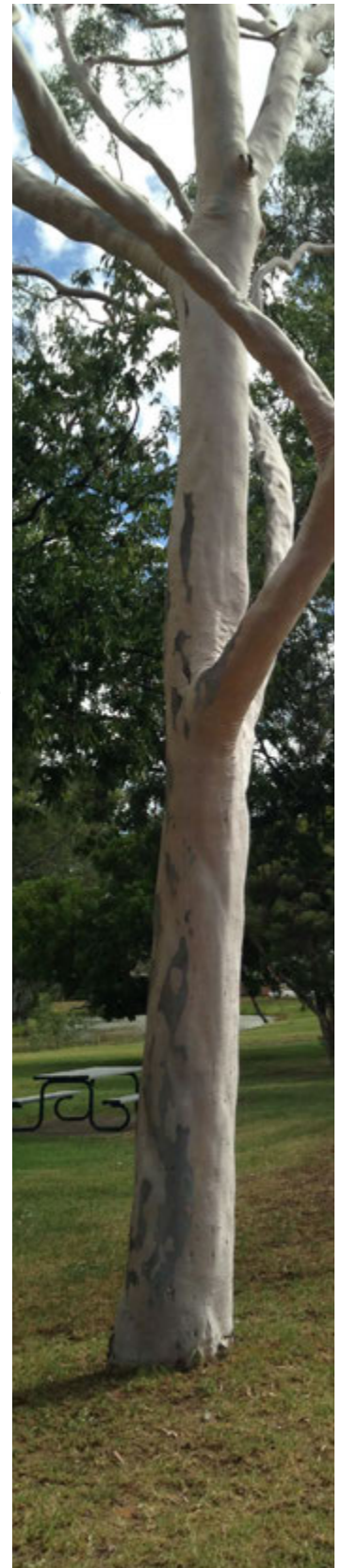

GARDEN BEDS

Purpose

To ensure:

- ▶ Garden bed planting takes advantage of locally appropriate indigenous, native or exotic plants.
- ▶ Garden planting reduces the need for water use and ongoing maintenance costs.
- ▶ Planting provides a safe and attractive environment.
- ▶ Retention and enhancement of remnant indigenous vegetation.

General Requirements

- ▶ Garden bed planting is required to comply with the requirements outlined in this document.
- ▶ All proposed shrub, groundcover and grass species will be described in submitted Landscape Plans and will require Council approval.
- ▶ Garden bed installation and planting is to comply with the requirements set out in this document.

Approved Plant Species List

- ▶ Plant species used within the Council areas should be selected from the list contained in this document.
- ▶ Use local indigenous species where appropriate.
- ▶ Approval of the use of alternative species other than those listed in this document will be at the discretion of Council.
- ▶ Full plant schedules must be listed on plans.
- ▶ Plant species selection shall consider:
 - ▶ Drought tolerance.
 - ▶ Maintenance issues including requirements for fertiliser application and pruning.
 - ▶ Hierarchy of plant materials including upper, middle and lower storey plants in appropriate combinations and layout which provide interest, diversity and amenity.
 - ▶ Safety and surveillance issues.

Setout Requirements

- ▶ Proposed planting designs and species selection must adhere to road user and pedestrian sight line requirements, and be in line with the following offsets:
 - ▶ Species which have a mature maximum height of 500mm are permissible within 5.0m of pedestrian crossing points.
 - ▶ No closer than 500mm from a path, driveway, service facility or any other structural elements within the nature strip.
 - ▶ Garden bed or mass planting areas within open space and adjacent to grass areas must allow for 1.8m deck ride on mowing maintenance.

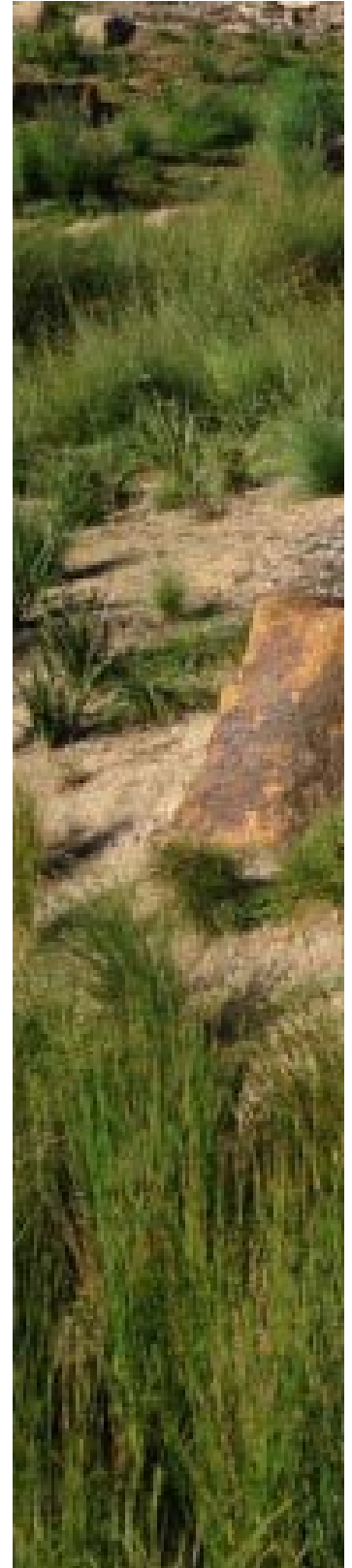

Wetland vegetation establishment

Medians

- ▶ Central medians in municipal roads will be planted with garden bed species where:
 - ▶ Planting is set back minimum 1.5m from back of kerb.
 - ▶ Planting area is minimum 0.8m wide.

Roundabouts

- ▶ Roundabouts in municipal roads will be planted with garden bed species where:
 - ▶ The roundabout is less than 10m diameter and will include planting centrally located with maximum mature height of 500mm.
 - ▶ The roundabout is greater than 10m in diameter and will include planting centrally located with maximum mature height of 1.0m.
 - ▶ Setback of planted area from back of kerb will be 1.2m.

Naturestrip Planting

- ▶ The use of planting in nature strips is not normally encouraged for reasons relating to safety, drainage and appropriateness.
- ▶ Should planting in nature strips be requested, a written application is required to be submitted to Council for assessment and determination.

Garden edging

- ▶ All garden beds and/or mass planted areas shall be enclosed by appropriate edge treatments which may be as follows:
 - ▶ Concrete edge minimum 150mm wide.
 - ▶ Spade edge.
 - ▶ Steel edging for straight edges that is 9m length angle iron 50mm x 75mm x 5mm welded together, or similar approved.
 - ▶ Steel edging for curved edges that is 50mm x 5mm flat steel welded together, or similar approved.
 - ▶ All steel edges to be welded onto reinforcing rods for stability and support no greater than 2m apart.

Topsoil

- ▶ 100mm of Council approved topsoil is required.
- ▶ Subgrade to be cultivated min 200mm prior to spreading of topsoil.

Mulch

- ▶ Mulch must be provided and may be bark, pebble or other approved alternative.
- ▶ Mulch shall be placed to a minimum depth of 75mm in garden beds and maintained throughout maintenance period.

Maintenance

- ▶ Pruning is to be carried out at the appropriate time of year and according to the particular species growth habit.
- ▶ All garden beds are to be maintained free of weeds and rubbish.

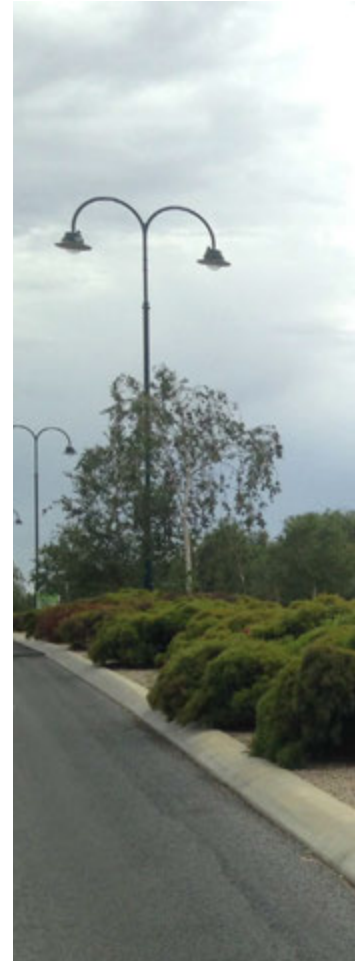

Central median planting



Steel edging

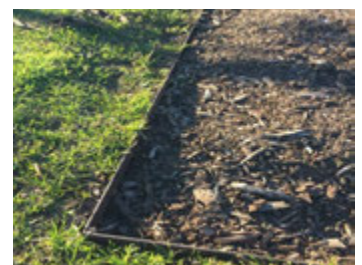

Steel edging

TURF / GRASSING

Purpose

To ensure:

- ▶ Grass areas are provided in appropriate locations that are useable by the public and/or complementary to landscape design.
- ▶ Grass areas allow cost-effective maintenance through avoidance of small, inaccessible areas that are difficult or time-consuming to maintain.

General Requirements

- ▶ Where suitable, native or ornamental grass species may be substituted for lawn grasses.
- ▶ Gradients for mown grass areas shall be equal to or flatter than 1:6.
- ▶ Open space grass areas shall be greater than 3.0m wide and 3.0m long, in manageable sizes and shapes.
- ▶ Designs shall allow for ease of access for a 1.8m ride on lawn mower and allow for a turning circle of 3.0m radius around any trees, structures or furniture.
- ▶ Grass areas shall be bounded by a road, path, garden edge or other approved solid edging material.

Seed mixes and Turf

- ▶ Grass species are to be as described in this document. Alternative grass species will be at the discretion of Council.
- ▶ Kikuyu grass/stolons to be used in Parks and Reserves.
- ▶ Turf grass will be male, sterile and seedless Kikuyu.
- ▶ Where seeding is required, a blend of Kikuyu and Rye grass is to be used with a minimum of 10% Kikuyu.
- ▶ Grass areas less than 500m² will be turfed.
- ▶ Grass areas greater than 500m² may be seeded with approved seed and turf will be installed adjacent all hard surfaces, pits and sprinklers.

Maintenance

- ▶ Irrigated lawn areas are to be maintained at an even height of between 25 and 40mm.
- ▶ Watering is to be carried out as required to maintain lawns in a healthy condition. Generally 30mm of water is required per week (depending on temperature and rainfall).
- ▶ All unirrigated dryland grassed areas are to be maintained at an even height of between 50 and 150mm.
- ▶ Native or ornamental grasses that are approved in nature strip plantings shall be selected to grow to a maximum height of 500mm at maturity and maintained to that height.
- ▶ Grass health is to be maintained through applications of appropriate fertiliser and top dressing as required. Two applications of fertiliser per annum is recommended for exotic grasses.



- ▶ Dead areas of lawn are to be removed and replaced with the same lawn species and managed to a healthy standard.

PAVING – CONTINUOUS AND UNIT PAVING

Purpose

To ensure:

- ▶ Paving is designed to cater for safe and convenient pedestrian access for people of all ages and abilities.
- ▶ Appropriate access is provided for maintenance purposes.
- ▶ Paving materials can be maintained satisfactorily and replaced if required.

General Requirements

- ▶ Footpaths and other paved areas shall be installed in accordance with relevant standards and be designed for equitable access and mobility.
- ▶ Tactile Ground Surface Indicators (TGSIs) are to be installed in accordance with relevant standards.
- ▶ TGSIs may be in the form of pre-cast pavers and consistent with adjacent paving styles and colours.
- ▶ Paving is to be of appropriate strength to allow for crossing by maintenance vehicles where vehicle access is required.
- ▶ Paths in open space areas no greater 1:10.
- ▶ Path material is to provide a path that is suited to purpose, cost effective and low maintenance.
- ▶ Footpaths width are to comply with Council's IDM standards.
- ▶ Where unit paving is being installed as the path material or as an edge restraint, its concrete footing shall not extend beyond the outside edge of the unit paver.
- ▶ Aggregate, stone or other hard material shall only be used if it is permanently fixed in place with concrete, adhesive or other approved product.
- ▶ Path crossings at roads shall have pram ramps installed to Council's IDM standards.
- ▶ Where granitic gravel is used for pathways steel edging is to be provided. Granitic sand is to be minimum compacted 50mm depth placed on a 50mm compacted crushed rock base.

Naturestrip Paving

- ▶ The use of paving as a nature strip treatment other than for path and crossovers is not normally encouraged for reasons relating to safety, drainage and aesthetics.
- ▶ Should nature strip paving be requested, a written application is required to be submitted to Council for assessment and determination.

Shared Paths

- ▶ Paths within public open space shall be a minimum of 2.0m wide, designated shared use paths to be a minimum of 3.0m wide.

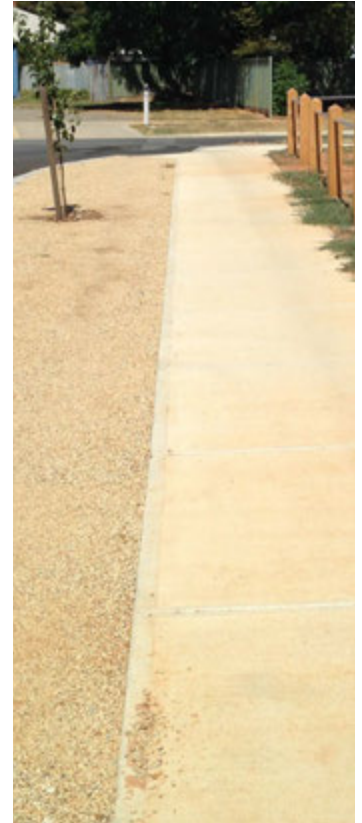

- ▶ Shared paths in open space areas will be reinforced concrete or asphalt.
- ▶ Shared use paths and designated cycle ways within parks and nature strips must intersect at 90° to the centre lines.
- ▶ All paths shall have a lateral clearance of 1.0m between any object and the edge of the path.
- ▶ Minimum 500mm wide shoulder constructed on pathways.
- ▶ Paved access for maintenance and emergency vehicles shall be provided to all public open spaces. Access points are to be appropriately secured.

Medians

- ▶ All medians less than 3.0m in width between face of kerbs, shall be paved or mulched.
- ▶ All medians and islands within 12.0m of an intersection and other median openings shall be paved.
- ▶ Medians greater than 3.0m in width between face of kerbs shall have a 1.5m minimum width of paving or mulch abutting the kerb, with the balance of the median being either paved or planted.

Roundabouts

- ▶ A 2.0m wide minimum paved/concrete area to face kerb shall be installed within a roundabout, with the balance of the roundabouts to be planted to Council standards.
- ▶ Walls or other structures shall not be permitted within roundabouts less than 10m in diameter.

Maintenance

- ▶ Paving maintenance is to ensure footpaths, shared paths and other paved areas are safe and functional.
- ▶ Paving maintenance shall be carried out in accordance with Council's maintenance standards.



FURNITURE AND STRUCTURES

Purpose

To ensure:

- ▶ Street and open space furniture (for example seats, picnic settings, bins etc) in public areas is provided to meet functional requirements and enhance the use of the public space.
- ▶ Integration of furniture into the overall landscape and streetscape includes provision in appropriate locations for accessibility and weather protection and sited appropriately in relation to adjacent hard and soft landscape elements.
- ▶ Furniture allows for cost effective maintenance.
- ▶ Furniture should allow for recycling at end of life.

General

- ▶ All furniture selections are to comply with elements described in this document, or other approved elements at the discretion of Council.
- ▶ Installation of furniture is to be in accordance with installation requirements described in this document, manufacturers specifications and other relevant Council standards and specifications.

Installation

- ▶ Furniture elements such as seats, bins and drinking fountains will be installed on concrete slabs.
- ▶ Furniture elements such as seats, picnic settings and drinking fountains must be wheelchair/mobility accessible.
- ▶ Concrete pad sizes to be minimum 3m x 1.5m for seats and benches and 3m x 3m for picnic settings
- ▶ Confirm with Council the required style of park furniture.
- ▶ Drinking fountain installation will include drainage point/pit and dog bowl must fit within the concrete slab to avoid water pooling then emptying the bowl avoiding water pooling.
- ▶ Bollards are to be cypress pine with 50mm galvanised rails, or other approved elements at the discretion of Council.
- ▶ Breaks in bollard and rail fencing is to allow for pedestrian access.
- ▶ Removable bollards are to be installed to allow maintenance access to parks and reserves. Chains are not be used.

Maintenance

- ▶ Street and open space furniture is to be maintained in accordance with Council's maintenance standards.



Bench seat on concrete slab example



Tables on concrete slab example



Bollard fencing example



Bins on concrete slab example



Drinking fountain with wheelchair access example

PLAYGROUNDS

Purpose

To ensure:

- ▶ Playgrounds in open spaces provide maximum play value that encourages child development through play sensations, opportunities and experiences.
- ▶ Integration of playgrounds into the overall landscape including accessibility and sited appropriately in relation to adjacent hard and soft landscape elements and provide for user safety.
- ▶ Playgrounds provide for wheelchair/mobility accessibility.
- ▶ Playgrounds allow for cost effective maintenance.

General

- ▶ All playgrounds will meet relevant Australian Standards.
- ▶ Certification of playground design during design phase and prior to tender.
- ▶ Certification of playground installation.
- ▶ Installation of playgrounds is to be in accordance with installation requirements in this document and other Australian standards.
- ▶ Fencing around playgrounds will be included where risks adjacent roads and/or water bodies is present. Confirm with Council.
- ▶ Playgrounds shall not be installed closer than 20m from roads or private property.

Installation

- ▶ Installation of playgrounds will be by qualified installation contractors.
- ▶ Certified playground organic soft fall must be 300mm of depth within fall zones.
- ▶ Rubber pour/rubber mats must be installed under high wear areas such as under swings and slides.
- ▶ Rubber soft fall depth to comply with Australian Standards and height of equipment.
- ▶ Concrete borders are to be installed around playgrounds.
- ▶ Drainage lines are to be installed inside the playground area with an external discharge point outside of concrete border.
- ▶ Include trade literature at practical completion.

Maintenance

- ▶ Playgrounds are to be maintained in accordance with Council's maintenance standards.

NOTE: Fitness equipment is not considered to be part of play spaces and not covered by this document. Confirm with Council any proposals for fitness equipment.



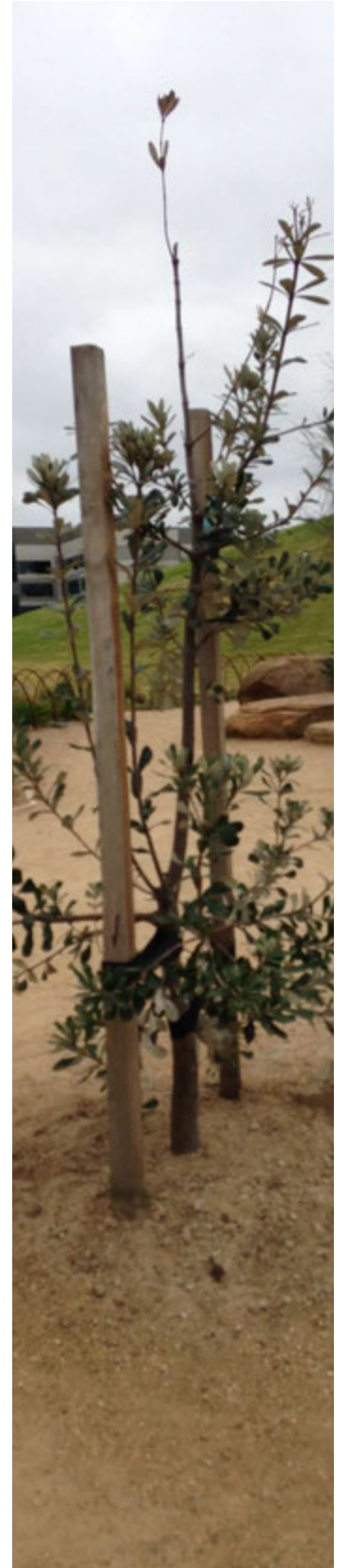



SECTION 9 FURTHER INFORMATION

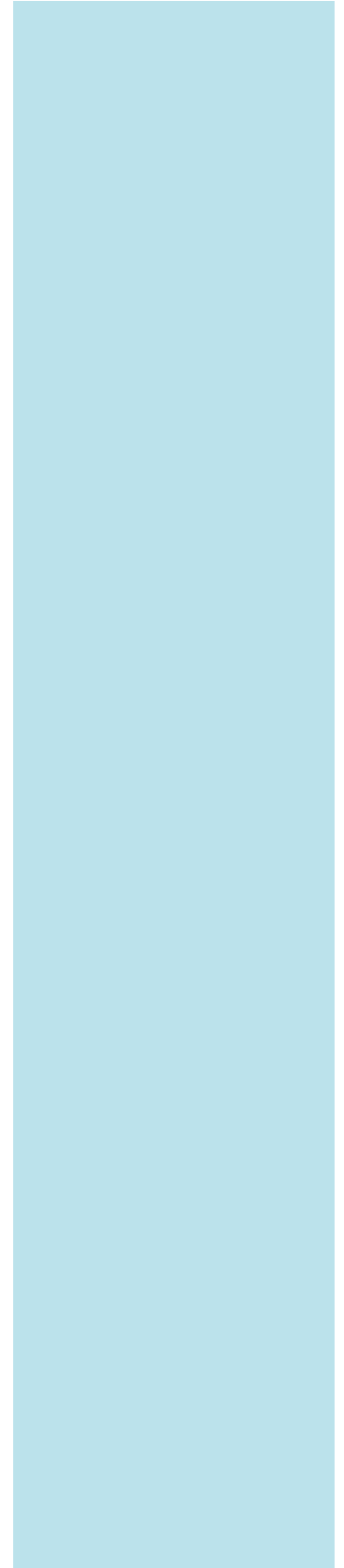

15. NURSERIES

The following nurseries within the Local Government Areas provide indigenous plant species.

The nurseries listed is not exhaustive nor do they have formal endorsement from the organisations who developed this report.

AUSTRALIAN NATIVE FARM FORESTRY (ANFF)

Murray Valley Highway, approximately 15km East of Cobram.

T (03) 5873 5444 / 0417 123 432

<http://www.iwanttrees.com.au/>

ROCHESTER NATIVE NURSERY

6708 Northern Highway

Rochester VIC 3561

T (03) 5484 3777

<http://www.rochesternursery.com.au/>

MCKINDLAY'S RIVERINE NURSERY

2220 Perricoota Road, PO Box 32, Moama NSW 2731

T John 0448 836 248 / Deb 03 5483 6240

john@mckindlaysriverinenursery.com.au

THE EUROA ARBORETUM

76 Euroa Main Road.

Plant Sales and Seed Sales

E: nursery@euroaarboretum.com.au

M: 0429 127 399

BILLABONG NURSERY SHEPPARTON

295 Numurkah Road Shepparton VIC 3631

T: 03 5821 8632

16. FURTHER INFORMATION AND REFERENCES

SHIRE OF CAMPASPE

Main office
Echuca Civic Centre
2 Heygarth Street
Echuca VIC 3564
shire@campaspe.vic.gov.au

Shire of Campaspe Planning Scheme
<http://planningschemes.dpcd.vic.gov.au/schemes/campaspe>

MOIRA SHIRE COUNCIL

Main Administration Centre
44 Station Street
Cobram VIC 3644
(03) 5871 9222
info@moira.vic.gov.au

Moira Shire Planning Scheme
<http://planningschemes.dpcd.vic.gov.au/schemes/moira>

GREATER SHEPPARTON CITY COUNCIL

90 Welsford Street,
Shepparton VIC 3630
(03) 5832 9700
council@shepparton.vic.gov.au

City of Greater Shepparton Planning Scheme
<http://planningschemes.dpcd.vic.gov.au/schemes/greatershepparton>

City of Greater Shepparton Environmental Sustainability Strategy
<http://greatershepparton.com.au/animals-environment-and-waste/environment/environmental-sustainability-strategy>

Street Tree Master Plan
Urban Forest Strategy

GENERAL REFERENCES

Infrastructure Design Manual
<http://www.designmanual.com.au/>

Supportive Environments for Physical Activity (SEPA) guidelines
<http://www.heartfoundation.org.au/victoria-healthy-design>

Crime Prevention Through Environmental Design (CPTED) guidelines
<http://www.police.vic.gov.au/>

The Good Play Space Guide “I can play too”
<http://www.playaustralia.org.au/>

Use of ‘best practice’ in water sensitive urban design (WSUD)
<http://wsud.melbournewater.com.au/>
<http://www.wsud.org/>

Australian Institute of Landscape Architects
<http://www.aila.org.au/>

GBCMA Revegetation guide
<http://www.gbcma.vic.gov.au/revegetation/>

Native Vegetation of Goulburn Broken Riverine Plains
http://www.gbcma.vic.gov.au/land_and_biodiversity/resources_publications/native-vegetation-of-the-goulburn-broken-riverine-plains

Birdlife Australia Birds in Backyards Program
<http://www.birdsinbackyards.net/>

17. LOCAL GOVERNMENT AREAS

City of Greater Shepparton

The City of Greater Shepparton is located in the Goulburn Valley region of Victoria and covers an area of 2,422 km². It is the fourth largest regional centre in Victoria. Shepparton is located about 180 kilometres to the north of Melbourne at the junction of the Goulburn Valley Highway and the Midland Highway. Greater Shepparton has a population of approximately 60,000 and is home to a diverse number of ethnic groups.

Shepparton is located at the confluence of the Goulburn and Broken Rivers which form part of the surround Goulburn-Broken river system. This river system and surrounding environs, including floodplains and wetland systems is a significant environmental and recreational asset in the municipality.

The largest urban centre is Shepparton (together with Mooroopna and Kialla) which has a vibrant central business district and extensive commercial, administrative and industrial base. This centre is supported by smaller settlements at Congupna, Dookie, Katandra West, Merrigum, Murchison, Tallygaroopna, Tatura, Toolamba and Undera. The regional economic catchment of Shepparton extends from Seymour to Deniliquin. Shepparton also provides a wide range of higher order community services and facilities for a regional population of approximately 160,000 persons.

Moira Shire

Moira Shire is located on the southern banks of the Murray River, bordering New South Wales. The Shire covers an area of over 4000 square kilometres and includes the major towns of Cobram, Numurkah and Yarrowonga. These townships along with Nathalia and a host of smaller towns are supported by a diverse agricultural base heavily reliant on irrigation farming for the production and processing of a range of agricultural products.

The Shire is located on the alluvial floodplains of the Murray, Goulburn and Ovens Rivers and the Broken Creek system. The natural systems of these rivers are the core natural assets of the Shire providing fertile farming land, a desirable tourist attraction and important habitat for native species and ecosystem services. The use of these assets has been developed in a variety of ways across the Shire responding to a mix of historical, cultural and physical conditions. At the 2011 Census the population of Moira Shire was at 28,124, and has continued to grow since.



Campaspe Shire Council

Campaspe Shire Council is located in north central Victoria and covers an area of approximately 4,500 square kilometres. The Shire is located approximately 200 kilometres directly north of Melbourne. It's southern border is bounded by State Forest, with its northern border aligned with the Murray and Goulburn Rivers. The western boundary is defined by the Bendigo Creek and the Campaspe River. The eastern boundary is generally defined as east of Wyuna and Kyabram and the Waranga Basin. At the 2011 Census, the Shire of Campaspe had a population of 36,365, and has continued to grow since.

Campaspe Shire's largest town is Echuca which interacts with its New South Wales' counterpart, Moama. The bulk of the Shire's population is centred around the northern and eastern points of the Shire, especially within the Echuca - Kyabram - Rochester triangle. The southern and western areas of the Shire are more sparsely populated. Other primary population centres of the Shire include Kyabram, Rochester, Tongala, Rushworth, Stanhope, Lockington, Gunbower, Girdarre and Colbinabbin.

Agricultural production, based on intensive irrigated areas and large tracts of dry land farming, combine to form the largest industry in the Shire. Tourism is an economic and employment growth sector for the Shire and is an important aspect of the social, economic and physical make up of the Shire. The key tourism assets of the Shire are based on the Murray River, the Port of Echuca, River Boats, Native Forests, Historic Buildings, the Kyabram Fauna Park and local tourist attractions. The Port of Echuca because of its heritage values is recognized as the 'anchor' tourist attraction in the region.

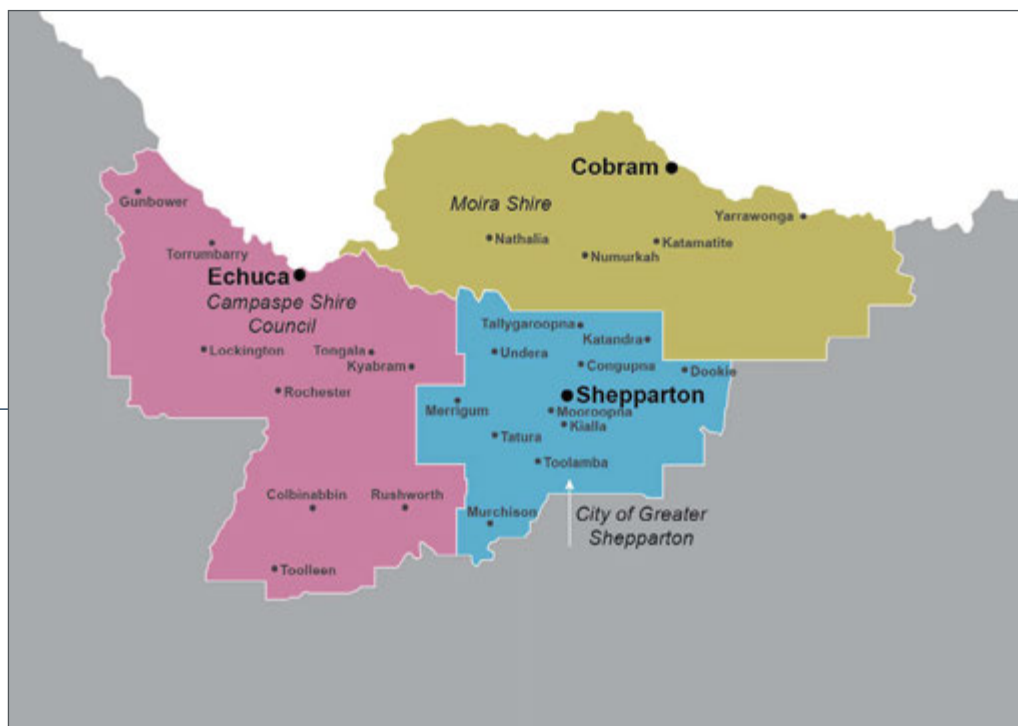



SECTION 10 CHECKLISTS

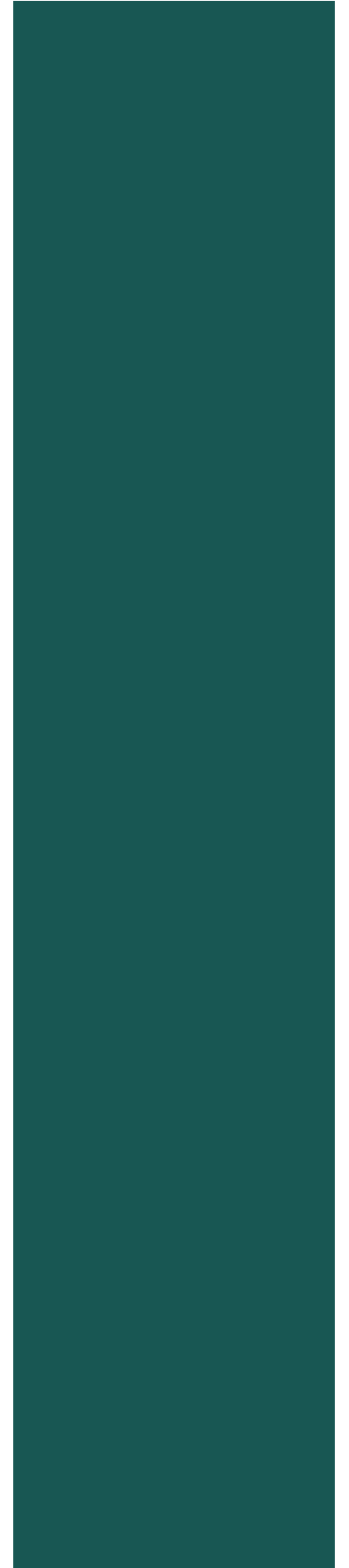

18. CHECKLISTS

18.1 Master Plan Checklist

To be submitted to Council with Master Plan

| |
|-----------------------------|
| Name of Subdivision: |
| Address: |
| Owner / Applicant: |
| Email: |
| Phone number: |
| Landscape Architect: |
| Permit Number: |

| Master Plan Checklist | Yes | No | N/A | Comments |
|-----------------------------------------------------------------------------------------------------------------|-----|----|-----|----------|
| Compliance with Planning policies | | | | |
| Development Plans and/or Design Frameworks | | | | |
| Development Area, property boundaries and survey/topographical information (e.g. contours, roads and easements) | | | | |
| Water Sensitive Urban Design / Stormwater / Drainage Plan or report | | | | |
| Flora and Fauna Report | | | | |
| Cultural Heritage Management Plan | | | | |
| Relevant information from stakeholders/authorities (Council, Parks Victoria, VicRoads, Water Authorities etc) | | | | |
| Other expert reports (specify) | | | | |
| Bushfire Asset Protection Zones | | | | |
| Site Context Plan and/or Site Analysis Plan | | | | |
| Existing Conditions Plan – including Existing Vegetation for Retention and Removal | | | | |
| Landscape Vision | | | | |
| Community Structure | | | | |
| Access and Permeability | | | | |
| Roads and Access, Open Spaces, Cycling and Walking Paths | | | | |
| Residential Interfaces and Fences/Screens | | | | |
| Street Tree Master Plan | | | | |
| Indicative Cross Sections (entrances, watercourses, retaining walls) | | | | |
| Open Space Treatments | | | | |
| Planting – Reserves, WSUD plantings | | | | |
| Furniture and Fittings | | | | |
| Structures and Surfaces | | | | |
| Materials | | | | |
| Play Spaces | | | | |
| Signage, Interpretation, Entry Statements and Artwork | | | | |
| Maintenance and Management | | | | |

18.2 Landscape Concept Plan Checklist

To be submitted to Council with Landscape Concept Plan

| |
|-----------------------------|
| Name of Subdivision: |
| Address: |
| Owner / Applicant: |
| Email: |
| Phone number: |
| Landscape Architect: |
| Permit Number: |

| Landscape Concept Plan Checklist | Yes | No | N/A | Comment |
|----------------------------------------------------------------------------|-----|----|-----|---------|
| Previous design work, such as Landscape Master Plans | | | | |
| Budget (both design and construction) | | | | |
| Relevant standards, guidelines, planning restrictions / permit conditions | | | | |
| Ecological Vegetation Classes (EVCs) / recommended planting palettes | | | | |
| Site specific reports (Flora and Fauna, CHMP, PSP, Development Plans, etc) | | | | |
| Current base plans (urban design, survey, civil, architectural etc) | | | | |
| Findings from a site inspection / site analysis. | | | | |
| Retention of existing features, such as significant vegetation | | | | |
| Existing / proposed services | | | | |
| Earthworks and Grading | | | | |
| Drainage / WSUD | | | | |
| Hardscape / paving finishes | | | | |
| Furniture | | | | |
| Landscape Features (e.g. sculpture) | | | | |
| Structures | | | | |
| Lighting | | | | |
| Materials Palette | | | | |
| Planting Palette and Planting Densities | | | | |
| Surface Treatments | | | | |
| Function / Fit for Purpose | | | | |
| Circulation and Accessibility including maintenance and emergency access | | | | |
| Environmental impact | | | | |
| Aesthetics / Design Theme | | | | |
| Maintenance | | | | |
| User Safety (sightlines, passive surveillance and level changes) | | | | |
| Other information such as Structural Engineering, Lighting | | | | |

18.3 Construction Documentation Plans Checklist

To be submitted to Council with Construction Documentation Plan

| |
|-----------------------------|
| Name of Subdivision: |
| Address: |
| Owner / Applicant: |
| Email: |
| Phone number: |
| Landscape Architect: |
| Permit Number: |

| Construction Documentation Plans Checklist | Yes | No | N/A | Comments |
|----------------------------------------------------------------------------------------------------------------------------------------------------|-----|----|-----|----------|
| Current base plans (urban design, survey, civil, architectural etc). | | | | |
| Service locations. | | | | |
| Demolition and/or protection of existing features. | | | | |
| Earthworks, finished surface levels, top of wall levels, critical grades for access, function and maintenance. | | | | |
| Proposed drainage, connection to existing drainage system, overland flow path, vulnerability of other materials/design elements to excess water. | | | | |
| Soil quality and any improvements required to support plants/ grass. | | | | |
| Trees (species, location, installed size, quantity). | | | | |
| Plants (species, location, installed size, quantity). | | | | |
| Grassed areas (seed mix, performance, irrigation and maintenance requirements). | | | | |
| Paving (nominate materials and finishes, general design effects of expansion and control joints). | | | | |
| Furniture (proprietary or custom, materials and finishes). | | | | |
| Fencing (materials and finishes, maintenance and emergency access requirements). | | | | |
| Playground (Design audit and certification of design to be provided) | | | | |
| Landscape features and custom built items e.g. Signage (prepare supporting images/sections/sketches and provide typical dimensions and materials). | | | | |
| Lighting (nominate product, supplier and location). Consider country of manufacture, availability of parts, vandalism protection. | | | | |
| Irrigation (determine extent, temporary/permanent system, tapping points, conduit, controller and meter requirements). | | | | |
| Construction Details. | | | | |
| Maintenance Specifications (if requested by Council). | | | | |





APPENDIX 1

LANDSCAPE PLAN TEMPLATE EXAMPLE LEGENDS

LANDSCAPE PLAN TEMPLATE

LEGEND

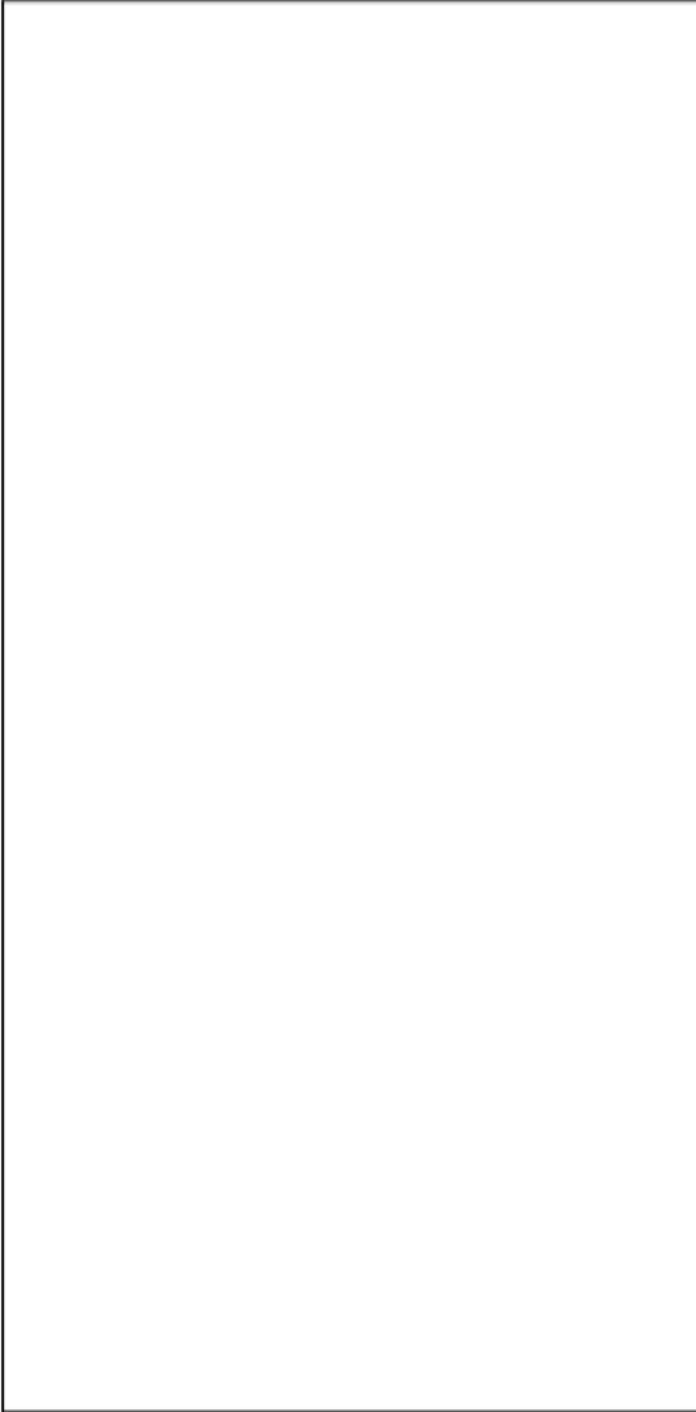

PLAN

PLANT SCHEDULE

| BOTANICAL NAME | COMMON NAME | HEIGHT X WIDTH | QUANTITY |
|----------------|-------------|----------------|----------|
| | | | |
| | | | |
| | | | |
| | | | |
| | | | |
| | | | |
| | | | |
| | | | |
| | | | |









Drawing Number: _____ Drawn by: _____
Revision: _____ Checked by: _____
Date: _____
Sheet: _____

PROJECT TITLE _____
PROJECT LOCATION _____

















NORTH ARROW SCALE BAR

EXAMPLE LEGENDS









LEGEND

-  **EXISTING TREES**
To be protected and retained
-  **EXISTING TREES TO BE RELOCATED**
Refer planting plan for location
-  **EXTENT OF ASPHALT SEAL DEMOLITION**
-  **EXTENT OF CONCRETE DEMOLITION**
-  **EXTENT OF PLAY/GARDEN MULCH DEMOLITION**
Stockpile for re-use
-  **EXTENT OF POST AND RAIL FENCE DEMOLITION**
-  **EXTENT OF FURNITURE AND STRUCTURE DEMOLITION**
-  **EXTENT OF WORKS**

LEGEND

-  **EXISTING TREES**
To be protected and retained
-  **PROPOSED TREE**
Refer plant schedule
-  **INSITU GREY CONCRETE PAVING**
Refer schedule, details and specification
-  **EXPOSED AGGREGATE CONCRETE PAVING**
Refer schedule, details and specification
-  **INSITU ASPHALT PAVING**
Refer schedule, details and specification
-  **GRANITIC GRAVEL PAVING**
Refer schedule, details and specification
-  **PLAYGROUND SOFTFALL MULCH**
Refer schedule, details and specification
-  **PLAYGROUND SAND**
Refer schedule, details and specification
-  **GARDEN BED PLANTING**
Refer details, specification and plant schedule
-  **FLUSH STONE PAVING**
Refer schedule, details and specification
-  **MULCH BENEATH TREES**
Refer schedule, details and specification
-  **GRASS**
Refer details and specification
-  **CONCRETE EDGING TO PLAYGROUND**
Refer schedule, details and specification
-  **DRY CREEK BED**
Refer schedule, details and specification
-  **STEEL EDGING**
Refer schedule, details and specification
-  **FREE STANDING STONE WALL**
Refer schedule, details and specification

LEGEND

-  **EXISTING DECIDUOUS TREES**
-  **EXISTING EVERGREEN TREES**
-  **NEW EVERGREEN TREES**
-  **EXISTING REVEGETATION AREAS**
-  **NEW REVEGETATION AREAS**
-  **NEW DAM**
-  **NEW DAM MARGIN PLANTING**
-  **EXISTING POST AND WIRE FENCING**
-  **NEW POST AND WIRE FENCING**



APPENDIX 2

CITY OF GREATER SHEPPARTON DEVELOPER GUIDELINES



APPENDIX 3

FEEDBACK ON DRAFT LANDSCAPE PLAN GUIDE

Feedback on the Draft Landscape Plan Guide was provided through a Stakeholder Workshop on 21 March 2017 and public submissions. Feedback from the workshop included the following discussion points.

- ▶ City of Greater Shepparton confirmed that simple or less complex landscape proposals (e.g. rural landscape proposals) may be prepared by a horticulturalist or landscape designer while complex landscape proposals shall be prepared by a landscape architect.
- ▶ General support for the Guide and the clarity of process and requirements for landscape plans which is outlined in the document.
- ▶ City of Greater Shepparton Developer Guidelines will be added as Appendix.

The following table outlines summary of submissions received on the Draft Master Plan and notes the relevant section in the Master Plan where relevant comments have been included in the Final Master Plan.

| SUBMISSION NUMBER | SUMMARY OF SUBMISSION | RESPONSE |
|-------------------|---------------------------------------------------------------------------------------------------------------------------------------------------------------------------|----------------------------------------------------------------------------------------------------------------------------------------------------------------------------------------------------------------------------------------|
| 1 | Generally supportive of the document. Highlights that a review of the trees planted in the last 10 years is required due to losses. | Comments noted. Species proposed are suggested. Document notes tree species selection shall be discussed with Council to determine the right tree for the right location. |
| 2 | Species/planting lists needs to be better arranged to be more user friendly. | Comments noted and lists revised as appropriate. Plant species listed in alphabetical order for botanical name. Images and headings checked and amended as required. |
| 3 | Support from Goulburn Broken Catchment Management Authority and welcomes adoption by Councils. | Noted. |
| 4 | Goulburn Broken Catchment Management Authority proof read mark ups. | Noted and amended as required. |
| 5 | Tree canopy size should be displayed on plans, noting Council's Urban Forest Strategy. General comments on Shepparton-specific guidelines. | Comments noted and revisions made as required. Document refers to canopy cover under 'Design Considerations' for each section. COGS Developers Guidelines to be included as appendices. References to fitness equipment removed. |
| 6 | General comments regarding images for each section, Rural Developments design considerations and planting layout templates, plant species, blank landscape plan template. | Comments included in final document, including blank landscape plan template. |

