

# COTTON PHYSIOLOGY

NUMBER ONE  
THE COTTON FOUNDATION  
REFERENCE BOOK SERIES



Edited by  
Jack R. Mauney  
and  
James McD. Stewart

# **COTTON PHYSIOLOGY**

# THE COTTON FOUNDATION

## *Reference Book Series*

The Cotton Foundation was created in 1955 to foster innovative research and education not covered by other private or public agencies. It is supported by many of America's finest agri-industries and financial institutions, including banks, cotton magazines, and manufacturers of machinery, chemicals and other inputs used in cotton production, processing and marketing. With this effective partnership of agribusiness firms and the cotton industry through The Foundation, greater strength is marshalled on important cotton problems.

The goal of The Foundation is to enhance markets for the benefit of the U.S. cotton industry as well as its corporate suppliers. Funds granted to The Foundation go entirely to support research and educational programs. Staffing is provided by the National Cotton Council and offices are in the Council's building in Memphis, Tennessee.

The Foundation is pleased to initiate a program to publish a series of cotton reference books with this volume, **COTTON PHYSIOLOGY**, being the first. Second and third books in the series, **WEEDS OF COTTON: Characterization and Control** and **COTTON INSECTS AND MITES: Characterization and Management**, are in early developmental stages. Plans are to publish several others in this series.

The Cotton Foundation  
1918 North Parkway  
Memphis, Tennessee 38112

## ACKNOWLEDGEMENT

Publication of this book was made possible by a grant to The Cotton Foundation from BASF Corporation. BASF is a major supplier to the cotton industry and supports programs for cotton through The Cotton Foundation.

BASF Corporation is a diversified chemical company with a strong tradition of technological excellence. The firm is part of the worldwide BASF Group. Based in West Germany, the BASF Group of 111 companies ranks among the world's largest in the manufacture and marketing of inorganic and organic industrial chemicals, coatings, paints, vitamins, dye-stuffs, pigments, pharmaceuticals, plastics, magnetic recording media and other specialty chemicals. Total annual sales are in excess of \$15 billion.

The BASF commitment to agriculture is typified by the company's 1911 development of the Nobel prize-winning technique that allows mass production of affordable fertilizers. Following the establishment of BASF Corporation in the U.S., the company developed the first plant regulator available to American cotton growers. Cotton plants treated with Pix® plant regulator are more compact, resulting in interrelated benefits of higher boll numbers, early maturity, reduction of boll rot and control of rank growth. In addition, BASF Corporation manufactures Poast® herbicide, a postemergence product for grass control that offers cotton growers added flexibility in their weed control programs.

BASF Corporation is proud to be a member of The Cotton Foundation and sponsor of **COTTON PHYSIOLOGY**, the first book in The Cotton Foundation's cotton reference book series. The sponsorship is a reflection of the company's belief that continued support of the development of technologies and materials that promote the production of more cost-effective, higher yielding cotton, will make a stronger cotton industry.

# **COTTON PHYSIOLOGY**

*Editors*

**JACK R. MAUNEY AND JAMES McD. STEWART**

*Executive Editor and Publishing Coordinator*

**JAMES M. BROWN**

*Number One*

**THE COTTON FOUNDATION  
REFERENCE BOOK SERIES**

**The Cotton Foundation, Publisher**

**Memphis, Tennessee, U.S.A.**

**1986**

**COPYRIGHT © 1986 by The Cotton Foundation.**

The Cotton Foundation has copyrighted this book as a collective work and does not own copyrights for individual chapters. Requests for permission to reproduce parts of individual chapters should be addressed to the authors.

The citation of trade names and/or names of manufacturers in this publication is not to be construed as an endorsement or as approval by The Cotton Foundation, the National Cotton Council, U.S. Department of Agriculture, any state university or any other federal or state agency nor imply to approval to the exclusion of other suitable products.

The Cotton Foundation  
1918 North Parkway  
Memphis, Tennessee 38112, U.S.A.

**Library of Congress Cataloging-in-Publication Data**

Cotton physiology.

(The Cotton Foundation reference book series; no. 1)

Includes bibliographies and index.

I. Cotton—Physiology. I. Mauney, Jack R., 1928- II. Stewart, James McD., 1941- III. Series.

SB249.C7938 1986 583'.17 86-16698

ISBN 0-939809-00-1 (The Cotton Foundation Reference Book Series)

ISBN 0-939809-01-X (Number One)

**Published 1986; reprinted 1987, 1991**



Photograph by James McD. Stewart



Photograph by William E. Barksdale

# TABLE OF CONTENTS

	<b>Page</b>
FOREWORD.....	xxii
PREFACE.....	xxiv
CONTRIBUTORS.....	xxvi

## **Chapter 1. Ecological Adaptations of Gossypium Species..... Paul A. Fryxell**

Introduction.....	1
Habitats.....	1
Temperature.....	2
Precipitation.....	2
Sunlight.....	3
Soils.....	3
Biotic Factors.....	3
Adaptations.....	4
Summary.....	7

## SECTION I

### DEVELOPMENT OF THE PLANT

## **Chapter 2. Vegetative Growth and Development of Fruiting Sites..... Jack R. Mauney**

Introduction.....	11
Morphological Development.....	11
Vegetative Growth.....	13
Initiation of Flowering.....	15
Flower Development.....	16
Prime Sites of Flowering.....	19
Earliness.....	24
Vegetative Reproductive Ratio.....	26
Growing-Degree Day Summations.....	27
Summary.....	28

## **Chapter 3. Growth of Roots..... Bobby L. McMichael**

Introduction.....	29
The Anatomy of the Cotton Root.....	29
Methods for Measuring Root Growth in Cotton.....	31
The Development of the Cotton Root System.....	33
Factors Affecting Cotton Root Growth.....	34
Soil Temperature.....	34



Soil Strength.....	35
Soil Aeration.....	36
Soil Water.....	36
Root—Shoot Relationships.....	37
<b>Chapter 4. Influence of Atmospheric Parameters on Growth and Development .....</b>	<i>Meryl N. Christiansen</i>
Introduction.....	39
Flower Initiation .....	39
The Nature of Flower and Fruit Abscission.....	40
Photosynthesis and Respiration Response to Environment.....	41
Light, Temperature or Gaseous Stress Effect on Hormone Status .....	42
Basic Effects of Environment on Abscission.....	43
Effects of Environment on Fruiting.....	43
Environmental Stress and “Cut Out” .....	45
Summary .....	46
<b>Chapter 5. Temperature Effects on Growth, Development and Fiber Properties .....</b>	<i>Jack R. Gipson</i>
Introduction.....	47
Germination and Emergence.....	47
Vegetative Growth and Fruiting.....	48
Fruiting Limb Initiation and Flowering .....	49
Nodal Position of the First Fruiting Limb.....	50
Boll Development.....	51
Fiber Elongation.....	51
The Secondary Wall.....	52
Boll Maturation Period .....	54
Fiber Properties.....	54
Summary .....	56
<b>Chapter 6. Effects of High Temperatures and Controlled Fruiting on Cotton Yield.....</b>	<i>Carl F. Ehlig</i>
Introduction.....	57
Temperature .....	57
Controlled Fruiting.....	60
Summary .....	62
<b>Chapter 7. Water Deficits and Reproduction .....</b>	<i>Wayne R. Jordan</i>
Introduction.....	63
Control of Fruiting Processes.....	64
Soil Water Availability and Vegetative Growth.....	64
Water Deficit-induced Abscission.....	68
Summary .....	71

<b>Chapter 8. Source-sink Relations as Affected by Water Stress</b>	
<b>During Boll Development.....</b>	<i>Daniel R. Krieg &amp; J.F.M. Sung</i>
Introduction.....	73
Response to Water Stress.....	74
Source Response.....	74
Sink Response.....	76
Summary.....	77
<b>Chapter 9. Effects of Nutrient Elements on Fruiting Efficiency.....</b>	<i>Howard E. Joham</i>
Introduction.....	79
Nutrient Element Balance.....	79
Measurements of Fruiting, Fruiting Efficiency and Earliness.....	79
Effects of Nutrient on Flowering and Fruiting.....	81
Elements Effecting the Vegetative-Fruiting Ratio.....	81
Elements not Affecting Fruiting Indices.....	87
Summary.....	89
<b>Chapter 10. The Nitrogen Stress Syndrome.....</b>	<i>John W. Radin &amp; Jack R. Mauney</i>
Introduction.....	91
Photosynthesis.....	91
Leaf Expansion and Hydraulic Conductivity.....	94
Responses to Water Stress.....	96
Integration of Nitrogen Effects.....	98
Prospects for Crop Improvement.....	103
Summary.....	104
<b>Chapter 11. Salinity and Fruiting.....</b>	<i>James L. Fowler</i>
Introduction.....	107
General Plant Response to Salinity.....	108
Cotton Tolerance to Salinity.....	108
Specific Effects of Salinity on Cotton.....	109
Physiological Functions of Cotton Influenced by Salinity.....	110
Summary.....	111
<b>Chapter 12. Hormonal Relations During Reproduction.....</b>	<i>Gene Gunn</i>
Introduction.....	113
Flower Initiation.....	113
Fruit Abscission.....	115
Enzymes Involved in Abscission.....	116
Hormonal Effects.....	117
Other Substances.....	121
Cutout.....	123

Sequential Changes and Interactions .....	127
Exogenous Modification .....	131
Summary .....	135

**Chapter 13. Use of Plant Growth Regulators for Crop**

**Modification.....** *George W. Cathey & Robert O. Thomas*

Introduction.....	137
Reproductive Development.....	137
Vegetative Development.....	139
Crop Termination.....	141
Summary.....	142

**Chapter 14. Physiology of Defoliation in Cotton Production.....** *George W. Cathey*

Introduction.....	143
The Nature of Defoliation.....	143
Hormonal Effects.....	146
Exogenous Chemical Defoliation.....	149
Summary.....	153

## SECTION II

### PHOTOSYNTHATE PRODUCTION & DISTRIBUTION

**Chapter 15. The Biochemistry of Photosynthesis.....** *Richard Jensen*

Introduction.....	157
Morphology of Higher Plant Chloroplasts.....	157
Fundamental Energy Processes in Photosynthesis.....	159
Role of the Pigment Systems.....	159
Spatial Orientation of the Photosystems.....	160
Flow of Electrons in Light.....	161
Photosystem II and Evolution of Oxygen.....	162
Photosystem I and the Reduction of $\text{NADP}^+$ .....	163
Intermediates of Electron Transport.....	164
Photophosphorylation.....	165
Carbon Metabolism During Photosynthesis.....	167
Photosynthetic Carbon Reduction Pathway (Calvin cycle).....	167
Regulation of $\text{CO}_2$ Fixation.....	169
Ribulose- $\text{P}_2$ Carboxylase/Oxygenase.....	169
Other Enzymes Regulated by Light.....	172
Storage of Energy by Starch Accumulation.....	173
Photorespiration and Its Requirements.....	174
Biochemical Limitations of Whole Plant Photosynthesis.....	180
Summary.....	181

**Chapter 16. Carbohydrate Production and Partitioning in the Canopy**..... *Jack R. Mauney*

Introduction.....	183
Crop Growth Rate.....	183
Carbohydrate Formation.....	183
Maximum Growth Rates.....	184
Sunlight Interception.....	186
Boll Loading and Biomass Accumulation.....	187
Carbohydrate Distribution.....	188

**Chapter 17. Photosynthesis, Dry Matter Production and Growth in CO<sub>2</sub> Enriched Atmospheres**..... *Donald L. Krizek*

Introduction.....	193
CO <sub>2</sub> Enrichment of the Atmosphere.....	194
Controlled Conditions.....	194
Field Conditions.....	195
Metabolic Effects of CO <sub>2</sub> Enrichment.....	197
Photosynthesis.....	197
Carbohydrate Metabolism and Feedback Control of Photosynthesis.....	203
Growth and Dry Matter Production.....	209
Transpiration and Stomatal Activity.....	214
Reproductive Development.....	218
Senescence and Abscission.....	218
Interaction of CO <sub>2</sub> and Other Environmental and Morphological Factors.....	222
Water Stress.....	222
Air Pollution.....	223
Implications of Projected Global Increases in Atmospheric CO <sub>2</sub> .....	223
Summary.....	224

**Chapter 18. Feedback Control and Stress Effects on Photosynthesis**..... *Daniel R. Krieg*

Introduction.....	227
The Photochemical Conversion of Light to Chemical Energy.....	229
The Physical Processes Controlling the Transfer of CO <sub>2</sub> from the Atmosphere to the Illuminated Chloroplast.....	230
The Biochemical Conversion of CO <sub>2</sub> to CH <sub>2</sub> O and Its Disposition.....	232
Stress Effects on Photosynthesis.....	236
Direct Effects.....	237
Summary.....	242

**Chapter 19. A Conceptual Model of Stress Effects**.... *Donald N. Baker & Basil Acock*

Introduction.....	245
Carbohydrate Stress.....	252

Water Stress.....	254
Nitrogen Stress .....	256
Summary .....	257

### SECTION III

## BOLL DEVELOPMENT

#### **Chapter 20. Integrated Events in the Flower and Fruit .....***James McD. Stewart*

Introduction.....	261
Square Period and the Flower .....	261
Square .....	261
Ovary.....	263
Stamen .....	267
Anthesis.....	269
The Boll Period.....	272
Seed and Boll Set.....	272
Dry Matter Distribution .....	275
Relative Weight Distribution and Developmental Events .....	275
Environmental Influences.....	287
Competitive Interactions .....	293
Summary .....	297

#### **Chapter 21. Mineral Compartmentation Within the Boll .....***Harry R. Leffler*

Introduction.....	301
Major Elements.....	303
Nitrogen .....	303
Phosphorous .....	303
Potassium .....	304
Minor Elements.....	305
Calcium.....	305
Magnesium.....	307
Dynamic Relationships of Nutrient Compartmentation .....	307
Summary .....	309

#### **Chapter 22. Carbohydrate Distribution in Bolls .....***A. Michael Schubert, C.R. Benedict, & Russell J. Kohel*

Introduction.....	311
Assimilate Supply .....	311
Sink Strength .....	314
Source-to-Sink Proximity .....	317
Duration of Assimilate Transport to Bolls.....	323
Summary .....	323

**Chapter 23. Lint Development** ..... *Edmond A.L. Delanghe*

Introduction..... 325

Fiber Initiation..... 326

Fiber Elongation ..... 327

    Morphogenetic Aspects ..... 327

    Ultrastructural Aspects..... 329

    The Nucleolus: A Driving Force..... 329

    The Substrate Supply..... 331

The Primary Wall and its Extension..... 332

    Chemical Composition ..... 332

    The Microfibril..... 332

    Primary Wall Extension..... 333

The Overlapping Phase ..... 336

    Simultaneous Elongation and Wall Thickening ..... 336

    Gradual and Abrupt Changes in Wall Composition ..... 336

    The S<sub>1</sub>-layer ..... 337

The Secondary Wall..... 339

    Physical Composition ..... 339

    Chemical Composition ..... 340

    Process of Secondary Wall Formation..... 341

    The Cytoplasm..... 342

    Cellulose Biosynthesis..... 342

Dehydration of the Fiber..... 344

Fiber Population..... 344

    Normal Distribution of Fiber Length..... 344

    Morphogenetic Relation Between Lint Characteristics ..... 346

Lint Production and Lint Quality..... 347

    Environmental and Genetic Stresses ..... 347

    The Need for Lint Quality-Generating Models ..... 348

Summary ..... 349

**Chapter 24. Stress Influences on Fiber Development** ..... *Harmon H. Ramey, Jr.*

Introduction..... 351

Morphological Properties..... 351

    Mineral Nutrients..... 352

    Temperature..... 352

    Moisture..... 354

    Light Intensity ..... 354

    Pests and Pesticides..... 355

    Growth Regulators ..... 355

    Genotype Interaction..... 355

Mechanical Properties ..... 356

Discussion..... 358

Summary ..... 358

**Chapter 25. Hormonal Influences in Fiber**

**Development** ..... *K. Kosmidou-Dimitropoulou*

Introduction.....	361
Methods Used in the Hormonal Research.....	361
Effect of Hormones on Fiber Initiation .....	363
Hormonal Influences on Fiber Differentiation.....	363
Fiber Nucleolus Evolution and Hormones.....	365
Effect of Hormones on Fiber Elongation.....	368
Effect of Hormones on Secondary Wall Formation.....	371
Summary .....	373

**Chapter 26. The Outer Epidermis of the Cottonseed** ..... *Jerry D. Berlin*

Introduction.....	375
Morphology of the Outer Epidermal Layer.....	376
Light Microscopy.....	376
Electron Microscopy.....	383
Autoradiographic Analyses of the Epidermal Layer.....	403
Thymidine .....	403
Uridine .....	405
Amino Acids .....	407
Phenylalanine.....	408
The Seed Surface.....	410
Summary .....	413

**Chapter 27. Chemistry and Biology of Cottonseed**

**Globulins**..... *Julius W. Dieckert, Robert W. Wallace & Mary C. Dieckert*

Introduction.....	415
Chemistry of Acalin A and Acalin B.....	416
Possible Homologies.....	418
A Provisional Model.....	422
Summary .....	422

**Chapter 28. Differential Gene Activity in Cotton Embryogenesis** ..... *Glenn A. Galau*

Introduction.....	425
Analysis of Global Gene Activity in Embryogenesis.....	427
Storage Protein Messenger—RNA's.....	433
Late Embryo-abundant (Subset 5) mRNA's.....	436
Further Directions in the Study of Differential Gene Activity.....	438

**Chapter 29. Synthesis and Compartmentation of Enzymes During**

**Seed Maturation** ..... *Richard N. Trelease,  
Jan A. Miernyk, John S. Choinski, Jr. & Stephen J. Bortman*

Introduction.....	441
-------------------	-----

Methods .....	443
Growth and Selection of Plants .....	443
Organelle Isolation and Enzyme Assays .....	443
Embryo Culture .....	444
Enzyme Development and Organelle Localization .....	444
In Germinating Seeds .....	444
In Maturing Embryos .....	447
In Cultured Embryos .....	456
Summary .....	460

## SECTION IV

### SEED AND GERMINATION

#### **Chapter 30. Developmental Aspects of Planting Seed Quality .....** *Harry R. Leffler*

Introduction .....	465
Chronology of Seed Development .....	466
Effects of Date of Bloom on Seed Development .....	469
Estimations of Planting Seed Quality .....	470
Production of Quality Planting Seeds .....	472
Summary .....	474

#### **Chapter 31. Weathering: Changes in Planting Seed Quality Between Ripening and Harvest .....** *John M. Halloin*

Introduction .....	475
Increases in Vigor and Germinability .....	476
Decreases in Vigor and Germinability .....	476
Changes in Seeds Associated with Weathering .....	476
The Influences of Environmental Factors on Weathering .....	477
The Contribution of Biological Processes to Weathering .....	477
Resistance to and Avoidance of Weathering .....	480
Summary .....	480

#### **Chapter 32. Post-Harvest Factors Affecting Seed Quality .....** *James C. Delouche*

Introduction .....	483
Mechanical Damage .....	484
Harvesting .....	485
Ginning and Mechanical Delinting .....	486
Handling and Conveying .....	489
Mechanical Properties of the Cottonseed Coat .....	489
Consequences of Mechanical Damage .....	493
Delinting .....	495
Flame Delinting .....	495
Acid Delinting .....	496



Acid Delinted vs Mechanically Delinted Seed .....	499
Conditioning .....	502
Storage.....	504
Seed Quality.....	507
Evaluation of Seed Quality.....	509
Dormancy.....	514
Improving Seed Quality .....	515
Summary.....	517
<b>Chapter 33. Techniques to Evaluate Planting Seed Quality .....</b>	<i>Charles C. Baskin,</i>
	<i>Norman W. Hopper, Gordon R. Tupper, &amp; Otto R. Kunze</i>
Introduction.....	519
Seed Storage .....	520
Hygroscopic Equilibrium .....	520
Seed Quality—Moisture—Temperature Relationship .....	521
Variation in Seed Moisture Content.....	522
Presence of High Moisture Foreign Material .....	522
Storage in Trailers .....	524
Storage in the Field.....	524
Drying and Aeration .....	524
Evaluating Seed Quality.....	525
Tetrazolium Evaluation.....	526
Electrical Conductivity.....	527
Relation of Density and Weight to Seed Quality .....	531
Separation of Seed Using the Density Factor .....	533
<b>Chapter 34. Germination and Stand Establishment.....</b>	<i>Meryl N. Christiansen &amp;</i>
	<i>Randy Rowland</i>
Introduction.....	535
Cottonseed Germination .....	535
Enzymology of Germination .....	536
Environmental Effects on Germination.....	537
Temperature.....	537
Oxygen Requirements .....	539
Mineral Deficiencies and Toxicities.....	540
Chemical Aids to Germination and Stand Establishment .....	540
Stand Improvement .....	541
<b>Chapter 35. Seed Quality and Stand Establishment.....</b>	<i>Luther S. Bird</i>
Methods.....	543
The Seed Quality Curve.....	543
Application to Genetic Improvement.....	547
<b>Chapter 36. Field Environment and Stand Establishment.....</b>	<i>Donald F. Wanjura</i>

Introduction.....	551
Physical Factors.....	551
Planting Factors.....	552
Post-Planting Factors.....	552

## SECTION V

### SPECIAL TOPICS

**Chapter 37. Food and Feeding Quality of Cottonseed** ..... *John P. Cherry,  
Russell J. Kohel, Lynn A. Jones, & William H. Powell*

Introduction.....	557
Past Research Efforts on Seed Quality (1900-1970).....	557
Seed Quality Research in the Early 1970's.....	565
Seed Quality Research on Glandless Cottonseed.....	566
Comparison of Seed Quality Data Developed Through the Years.....	571
Recent Cottonseed Quality Research.....	571
Results by Locations.....	572
Other Factors Affecting Cottonseed Quality.....	583
Pink Bollworm Contamination.....	583
Module Storage of Seed Cotton.....	584
Cottonseed Maturity, Closed-Boll Harvesting and Artificial Drying of Cottonseeds.....	584
Wild <i>Gossypium</i> Species.....	587
Improving Cottonseed Use in Feed and Food.....	589
Discussions.....	590
Geneticists Viewpoint.....	590
Industry Viewpoint.....	592
Summary.....	595

**Chapter 38. Physiology of Secondary Products** ..... *Alois A. Bell*

Introduction.....	597
Phenolic Acids.....	597
Flavonoids.....	599
Flavonols.....	599
Flavones and Anthocyanins.....	604
Flavanols (Tannins).....	605
Terpenes.....	609
Volatile Terpenes.....	609
Sesquiterpenoid Naphthols and Ketones.....	611
Terpenoid Aldehydes.....	614
Unique Fatty Acids and Lipids.....	619
Summary.....	621

**Chapter 39. Organ and Tissue Cultures in Cotton**.....*James McD. Stewart*

Introduction..... 623  
Embryo Culture..... 623  
Ovule Culture..... 624  
    Culture for Seed and Fiber Development..... 625  
    *In Ovulo* Embryo Culture..... 626  
    *In Vitro* Fertilization..... 627  
Tissue Culture..... 627  
    Callus Induction and Culture..... 627  
    Suspension Cell Culture..... 628  
    Anther and Microspore Culture..... 629  
    Protoplast..... 630  
    Regeneration of Plants..... 630

**Chapter 40. The Interface Between Plant Physiology and Genetics**.....*Jerry E. Quisenberry*

Introduction..... 633  
Plant Physiology..... 633  
Plant Genetics..... 634  
Physiological Genetics..... 634  
Summary..... 639

LITERATURE CITED..... 641  
INDEX..... 767

## FOREWORD

From virtually every aspect, cotton is one of the most interesting higher organisms in the plant kingdom. It is rather unique in that it produces both fiber and food.

In its wild state, cotton is basically a perennial woody shrub in a semi-desert habitat. As an economic crop, it is now grown in the United States as a herbaceous annual under both semi-arid and humid conditions. Cotton also has been grown commercially as a perennial in areas of this country with mild winters. Only a few years ago about 50,000 acres of stub cotton were grown in Arizona. It has since been banned because it intensifies boll weevil and pink bollworm problems. However, in some parts of the world, some cotton is still grown commercially as a perennial.

Cotton belongs to the genus *Gossypium* which is in the Malvaceae or Mallow family. Other members of this family include okra, hollyhock, rose of sharon, and even such plants as teaweed, spurred anoda, and velvetleaf that are weed pests in cotton. The 39 species in the genus *Gossypium* are quite diverse. Only four of them produce commercial-type lint. *G. hirsutum*, to which the upland varieties belong, and *G. barbadense*, which includes the extra long staple or Pima varieties, are the only ones grown commercially in the United States.

Even though cotton is grown as an annual, its reproductive and growth habits are controlled by a "perennial" physiological system programmed for maximum seed production and survival over a number of years rather than just one.

Compared with most crop plants, cotton adapts quite well to adverse conditions. For example, it is considerably more tolerant to high salinity soils than corn. Cotton's vegetative and fruiting balance adjusts both during and after periods of stress (moisture stress, light stress, etc.) preserving the potential for good yield if sufficient growing season remains.

One interesting physiological aspect of cotton is the way fibers begin and develop. A single epidermal cell of the seed gives rise to a fiber. Some cells produce lint fibers and others shorter fuzz fibers. A relatively small percentage of the epidermal cells on a seed develop into fiber even though they all have the same genetic makeup. What controls which ones develop into fibers? What determines which fibers will be lint and which will be fuzz fibers? Someday we will have the answers to these and other questions about cotton. With such knowledge, we may be able to trigger initiation of fibers from more of the epidermal cells. This presumably projects to higher yields, but other factors such as inadequate photosynthate might limit the expression of more fibers per seed to higher yields.

There are numerous other interesting facets about cotton's physiology. For example, a lint fiber's elongation period lasts up to about 18 to 20 days postanthesis. After elongation ceases, deposition of secondary fiber wall material begins. Also, at about 18-20 days postanthesis, the endosperm begins to disappear. It is completely gone by the time the boll opens.

With some varieties, the lint and fuzz fibers are restricted to specific and sometimes separate areas of the seed surface. With the so-called naked seed varieties, the fuzz fibers are totally absent. Some wild species produce no fibers.

The physiological and biochemical events that take place in cotton's growth and development are highly regulated—much as if cotton is programmed by a highly sophisticated, built-in computer.

It is no wonder that many scientists working with cotton get caught up in its mystique and become deeply dedicated to unlocking its mysteries by finding the correct physiological/biochemical keys.

The National Cotton Council is pleased to have played a significant role in initiating The Cotton Foundation Reference Book Series and is particularly happy that the first book in the series is on cotton physiology.

The usefulness of **COTTON PHYSIOLOGY** as a reference book goes beyond the traditional researcher, teacher, and student users. Private agricultural consultants and representatives of the agricultural chemicals industry will find it to be a valuable source of information. Modern-day cotton producers also will find this book useful. Today's educated and innovative producers want to know more than just "what to do" and "when to do it." They want to know the reasons for doing things at certain times. They are interested in the cotton plant's fruiting and vegetative development as related to environmental conditions, cultural practices, etc. They realize that the more that is known about the cotton plant, the more successful they will be in culturing it as a commercial crop.

The National Cotton Council and The Cotton Foundation are indebted to Drs. Jack R. Mauney and James McD. Stewart, two outstanding scientists who have dedicated so much time and effort as editors in bringing this book to fruition. The Council and Foundation also recognize the major contributions of the 48 other scientists who were authors of the 40 chapters.

James M. Brown  
Manager, Production Technology  
National Cotton Council

## PREFACE

The cotton plant is unique among major agricultural crops in the number of its actual and potential uses. Not only does it produce the fiber with which everyone is intimately familiar as a consumer, but it also produces a high quality oil and a protein meal equivalent to or better than soybean. The cotton plant is also unique for its service as a multifaceted experimental system. Notable in this vein are: (1) the early work on abscission, defoliation and the discovery of abscisin; (2) studies on the physics and biochemistry of cellulose deposition in fibers; (3) mathematical simulation of crop growth and productivity; (4) the ultramicrographic description of pollen tube growth and fertilization; (5) the *in vitro* culture of ovules and fibers; and (6) the *in ovulo* culture of interspecific hybrid embryos. Cotton continues to be used as a model plant in the molecular biology of embryogenesis and gene regulation, in crop modeling, in cellulose synthesis and in cell differentiation. Many individuals have spent their careers studying various aspects of cotton growth and production, but progress has been slow and many perplexing problems remain.

Cotton does not readily yield its secrets. Anecdotally, it is said that there are two types of individuals who have worked with cotton. There are those who start a research program and become so frustrated with the crop that they will never work with it again. Then, there are those who become so fascinated with the peculiarities and idiosyncracies of the plant that they will never work with anything else.

It is in the spirit of and for the enthusiasts that we have attempted to create this book which is the culmination of several years of effort, hope and frustration. The inception of the idea for a comprehensive treatise on cotton physiology began in early 1978 during informal discussions among Earl King, who was USDA's Research Leader for Cotton Physiology at Stoneville, Mississippi, Jim Brown of the National Cotton Council, and the two of us. We recognized that there was a large body of information on cotton physiology, but that there was no source or reference from which one could readily obtain information. Those discussions led to the decision to conduct a series of symposia that would concentrate on specific aspects of the life history of the cotton plant. The intent was to generate a series of review and research papers that would provide the bulk of a reference book.

The format of the symposia conducted over a four-year period as a part of the Cotton Physiology Conference program during the Annual Beltwide Cotton Conferences strongly influenced the character of the book. Each year, three or four individuals considered as experts in the specific topic areas were asked to make major presentations. They, in turn, selected 2 to 4 additional researchers to provide expertise in related areas that deserved emphasis. All individuals submitted manuscripts covering their assigned topics. Our decision was to make each contribution a chapter. Consequently, considerable variety in length and content will be found in the various texts. At the end of the fourth symposium, all authors were given an opportunity to update their contributions. Since there were obvious

deficiencies in the subjects covered, we asked for additional chapters from experts in the deficient areas. The final result is contained herein.

We hope this book will serve as a background resource and starting point for future research into the physiology of the cotton plant. Its physical bulk and its more than 2200 citations should be an eloquent testimony to the complexity of the developmental processes in the cotton plant and, by inference, all plants. Attempts to reduce this plant to simplistic experiments and unequivocal statements about its behavior are naive at best and foolhardy at worst. In the truest sense, the crop is a four-dimensional entity. There is an immediacy of its daily reaction, but it has a distinct "memory" of its past (both recent and evolutionary) which is the basis for its future. Until physiologists and agronomists can integrate those reactions in the same way the plants do, our understanding will lack the dimension of time which has such a profound impact on the productivity of the crop.

Though the primary use of symposia books of this type is as a reference gathering dust until a specific question is asked, we think that it can serve usefully as a mystery story read from cover to cover. The mystery is, "What is a cotton plant?" In much the same way as the blind professors describing the elephant, each author experiences the cotton plant from a different perspective. Collecting their accounts so that a composite picture of the whole emerges is the purpose of this treatise. All who want to know the plant completely should be anxious to read every facet.

We are indebted to the many authors who contributed their time and expertise without compensation to make the symposia so successful. Ultimately, this resource volume is a tribute to them and to cotton physiology.

Jack R. Mauney  
James McD. Stewart  
*Editors*

## CONTRIBUTORS

### Current Address if Different

Dr. Basil Acock  
Plant Physiologist  
USDA, Agricultural Research Service  
Crop Simulation Research Unit  
Mississippi State University  
Mississippi State, MS 39762

Dr. Donald N. Baker  
Agronomist  
USDA, Agricultural Research Service  
Crops Simulation Research Unit  
Mississippi State University  
Mississippi State, MS 39762

Dr. Charles C. Baskin  
Associate Professor and Extension Specialist  
Department of Agronomy  
Mississippi State University  
Mississippi State, MS 39762

Dr. Alois A. Bell  
Pathologist  
USDA, Agricultural Research Service  
National Cotton Pathology Research  
Laboratory  
P.O. Drawer JF  
College Station, TX 77841

Dr. C.R. Benedict  
Professor  
Department of Plant Sciences  
Texas A & M University  
College Station, TX 77843

Department of Biochemistry &  
Biophysics  
Texas A & M University  
College Station, TX 77843

Dr. Jerry D. Berlin  
Professor  
Department of Biology  
Texas Tech University  
Lubbock, TX 79423

Dr. Luther S. Bird  
Professor  
Department of Plant Sciences  
Texas A & M University  
College Station, TX 77843

(Retired)



Stephen J. Bortman  
Graduate Student  
Department of Botany & Microbiology  
Arizona State University  
Tempe, AZ 85287

Dr. James M. Brown  
Manager, Production Technology  
National Cotton Council  
P.O. Box 12285  
Memphis, TN 38182

George W. Cathey  
Plant Physiologist  
USDA, Agricultural Research Service  
Cotton Physiology & Genetics Research  
Delta States Research Center  
P.O. Box 225  
Stoneville, MS 38776

Dr. John P. Cherry  
Chemist  
USDA, Agricultural Research Service  
Southern Regional Research Center  
1100 Robert E. Lee Boulevard  
New Orleans, LA 70179

Director  
Northeastern Regional Research Center  
600 E. Mermaid Lane  
Philadelphia, PA 19118

John S. Choinski, Jr.  
Graduate Student  
Department of Botany & Microbiology  
Arizona State University  
Tempe, AZ 85287

Assistant Professor  
Department of Biology  
University of Central Arkansas  
Conway, AR 72032

Dr. Meryl N. Christiansen  
Plant Physiologist  
USDA, Agricultural Research Service  
Plant Physiology Institute  
Agricultural Research Center  
Beltsville, MD 20705

(Retired)

Prof. Edmond A.L. DeLanghe  
Lab. Tropische Plantenteelt  
Katholieke Universiteit Leuven  
Kardinaal Merierlaan, 92  
3030 Heverlee, BELGIUM

Dr. James C. Delouche  
Professor & Director of State  
Seed Laboratory  
Department of Agronomy  
Mississippi State University  
Mississippi State, MS 39762

Dr. Julius W. Dieckert  
Professor  
Dept. of Biochemistry and Biophysics  
Texas A & M University  
College Station, TX 77843

Department of Plant Pathology  
& Microbiology  
Texas A & M University  
College Station, TX 77843

Mary C. Dieckert  
Research Associate  
Texas A & M Research Foundation  
Texas A & M University  
College Station, TX 77843

Dr. Carl F. Ehlig  
Plant Physiologist  
USDA, Agricultural Research Service  
4151 Highway 86  
Brawley, CA 92227

(Retired)

Dr. James L. Fowler  
Associate Professor  
Department of Crop & Soil Sciences  
New Mexico State University  
Las Cruces, NM 88003

Dr. Paul A. Fryxell  
Botanist  
USDA, Agricultural Research Service  
Cotton & Grain Crops Genetics Research  
P.O. Drawer DN  
College Station, TX 77840

Dr. Glenn A. Galau  
Assistant Professor  
Department of Botany  
University of Georgia  
Athens, GA 30602

Dr. Jack R. Gipson  
Associate Professor  
Department of Plant & Soil Science  
Texas Tech University  
Lubbock, TX 79413

Dr. Gene Guinn  
Plant Physiologist  
USDA, Agricultural Research Service  
Western Cotton Research Laboratory  
4135 E. Broadway Rd.  
Phoenix, AZ 85040

Dr. John M. Halloin  
Plant Physiologist  
USDA, Agricultural Research Service  
National Cotton Pathology Laboratory  
P.O. Drawer JF  
College Station, TX 77841

Dr. Norman Hopper  
Associate Professor  
Department of Plant & Soil Science  
Texas Tech University  
Lubbock, TX 79409

Dr. Richard Jensen  
Professor  
Department of Biochemistry  
University of Arizona  
Tucson, AZ 85721

Dr. Howard E. Joham (Retired)  
Professor and Head  
Department of Plant Sciences  
Texas A & M University  
College Station, TX 77843

Dr. Lynn A. Jones  
Director, Research & Education  
National Cottonseed Products Assoc., Inc.  
P.O. Box 12023  
Memphis, TN 38112

Dr. Wayne R. Jordan  
Professor  
Texas Agricultural Experiment Station  
Blackland Research Center  
Temple, TX 76501  
Director  
Water Resources Institute  
Texas A & M University  
College Station, TX 77843

Dr. Russel J. Kohel  
Geneticist  
USDA, Agricultural Research Service  
Cotton and Grain Crops Genetic Research  
P.O. Drawer DN  
College Station, TX 77840

Dr. K. Kosmidou-Dimitropoulou  
Plant Physiologist  
Hellenic Cotton Board  
150 Syngrou Ave.  
Athens (404). GREECE

Dr. Dan R. Krieg  
Professor  
Department of Plant & Soil Science  
Texas Tech University  
Lubbock, TX 79409

Dr. Donald T. Krizek  
Plant Physiologist  
USDA, Agricultural Research Service  
Plant Stress Laboratory  
Agricultural Research Center  
Beltsville, MD 20705

Dr. Otto R. Kunze  
Professor  
Department of Agricultural Engineering  
Texas A & M University  
College Station, TX 77843

Dr. Harry R. Leffler  
Plant Physiologist  
USDA, Agricultural Research Service  
Cotton Physiology & Genetics Research  
Delta States Research Center  
Stoneville, MS 38776

DeKalb-Pfizer Genetics  
3100 Sycamore Rd.  
DeKalb, IL 60115

Dr. Jack R. Mauney  
Plant Physiologist  
USDA, Agricultural Research Service  
Western Cotton Research Laboratory  
4135 E. Broadway Rd.  
Phoenix, AZ 85040

Dr. Bobby L. McMichael  
Plant Physiologist  
USDA, Agricultural Research Service  
Plant Stress & Water Conservation  
Research  
Southern Plains Cotton Research  
Laboratory  
Rt. #3  
Lubbock, TX 79401

Dr. Jan A. Miernyk  
Graduate Student  
Department of Botany & Microbiology  
Arizona State University  
Tempe, AZ 85287

Chemist  
USDA, Agricultural Research Service  
Northern Regional Research Center  
1815 N. University St.  
Peoria, IL 61604

Dr. William H. Powell  
Agronomist  
National Cottonseed Products Assoc., Inc.  
P.O. Box 12023  
Memphis, TN 38112

3147 South Fairfield Drive  
Tempe, AZ 85282

Dr. Jerry E. Quisenberry  
Geneticist  
USDA, Agricultural Research Service  
Cropping Systems Research Laboratory  
Rt. #3  
Lubbock, TX 79401

Dr. John W. Radin  
Plant Physiologist  
USDA, Agricultural Research Service  
Western Cotton Research Laboratory  
4135 E. Broadway Rd.  
Phoenix, AZ 85040

Dr. Harmon H. Ramey, Jr.  
Geneticist  
USDA, Agricultural Research Service  
Cotton Quality Laboratories  
University of Tennessee  
Knoxville, TN 37996

Chief, Fiber Technology Branch  
USDA, AMS, Cotton Division  
4841 Summer Avenue  
Memphis, TN 38112

Dr. Randy Rowland  
Plant Physiologist  
USDA, Agricultural Research Service  
Plant Physiology Institute  
Agricultural Research Center  
Beltsville, MD 20705

Dr. A. Michael Schubert  
Assistant Professor  
Department of Plant Sciences  
Texas A & M University  
College Station, TX 77843

Associate Professor  
Plant Disease Research Station  
Texas A & M University  
Yoakum, TX 77995

Dr. James McD. Stewart  
Plant Physiologist  
USDA, Agricultural Research Service  
Department of Plant & Soil Science  
University of Tennessee  
Knoxville, TN 37996

Professor & Altheimer  
Chair for Cotton Research  
& Development  
Department of Agronomy  
University of Arkansas  
Fayetteville, AR 72701

J.F.M. Sung  
Research Associate  
Department of Plant & Soil Science  
Texas Tech University  
Lubbock, TX 79409

Agronomy Department  
Nat'l. Chung Hsing University  
Taichung, TAIWAN  
Republic of China

Dr. Robert O. Thomas  
Plant Physiologist  
USDA, Agricultural Research Service  
Delta States Research Center  
Stoneville, MS 38776

(Retired)

Dr. Richard N. Trelease  
Professor  
Department of Botany & Microbiology  
Arizona State University  
Tempe, AZ 85281

Dr. Gordon R. Tupper  
Agricultural Engineer  
Delta Branch Experiment Station  
P.O. Box 96  
Stoneville, MS 38776

Robert W. Wallace  
Research Associate  
Dept. of Biochemistry and Biophysics  
Texas A & M University  
College Station, TX 77843

Department of Pharmacology  
University of Alabama  
College Station  
Birmingham, AL 35294

Dr. Donald F. Wanjura  
Agricultural Engineer  
USDA, Agricultural Research Service  
Cropping Systems Research Laboratory  
Rt. 3  
Lubbock, TX 79401

## Chapter 1

ECOLOGICAL ADAPTATIONS OF  
GOSSYPIUM SPECIES

Paul A. Fryxell  
USDA—ARS  
College Station, Texas

## INTRODUCTION

*Gossypium* is a large genus, comprising almost 40 species, that encompass a notably wide range of diversity. Several species are well known in cultivation as the world's commercial cotton crop. The majority, however, are less well known and occur as elements of the indigenous vegetation in various parts of the world. Among these wild species (from Australia, Africa, Mexico, and elsewhere) a great range of ecological variation is found, including various morphological and physiological adaptations to the diverse habitats in which they occur.

It may be argued that an understanding of the physiology of the (cultivated) cotton plant is not complete without a knowledge of the range of variation exhibited by these (wild) related species. This is true in a dual sense: (1) that an understanding of the phylogenetic milieu from which the cultivated species originated in a historico-evolutionary sense is important; and (2) that a knowledge of the physiological spectrum of variation that is inherently available in the genus and therefore potentially available in the cultivated species through selective breeding and germplasm manipulation is also important. The present chapter is offered in such a context.

Many detailed physiological studies of the cultivated cottons have been made (witness this volume), whereas relatively few such studies have been made of their wild relatives. Consequently, a comparative presentation at this level is essentially impossible. Instead, attention will focus here on their ecology and particularly on their adaptations to ecological factors from which physiological inferences may be drawn. There is, of course, an evolutionary dimension to such a study, evolution not only of the plants themselves but also of the climatic situations in which they occur.

## HABITATS

The wild cottons are generally confined to subtropical and tropical regions, although there are some instructive exceptions. They tend to occur in relatively arid habitats, sometimes in extremely arid habitats. These climatic factors, coupled with edaphic factors, have a controlling effect on the entire vegetation of a

given region, and in turn the associated vegetation (or vegetation type) is itself a significant ecological factor for each of the wild species of *Gossypium*.

Climate is generally regarded as an integrated expression of temperature, moisture, prevailing winds, and amount of sunshine for a given locality, including cyclical aspects of the changing seasons. These (and other) variables are interrelated in complex ways and, in fact, are not independent of the vegetational cover itself. Therefore, it must be understood that statements about the relation of a particular climatic variable to the ecology of the plants of the region are generally oversimplifications to a greater or lesser degree.

## TEMPERATURE

Temperature is, of course, a key climatic factor. As already noted, the wild cottons generally occur in the tropics and subtropics, that is to say in frost-free areas. There are exceptions to this statement (to be discussed below), but the general fact is that the protoplast in most species of *Gossypium* is sensitive to, and is killed by, freezing temperatures.

A second observation to be made about temperature in the habitats where the wild species of *Gossypium* occur is that maximum temperatures are often very high, especially in the relatively arid regions where insolation rates are very high. For example, maximum temperatures in excess of 45C are characteristic of the shores of the Gulf of California (Rzedowski, 1978) where four species of *Gossypium* are indigenous. Similar extremes presumably occur in such areas as the Arabian peninsula and the deserts of southwestern Africa, where other species occur.

In addition to extremes of temperature, attention should also be given to fluctuations of temperature, whether diurnal or seasonal. In certain maritime climates (e.g. Hawaii), wild cottons are adapted to highly stable temperature regimes, with diurnal and seasonal fluctuations of only a few degrees. In other regions (e.g. western Mexico) average diurnal fluctuations of 20C are the rule. This variation no doubt has implications for physiological responses such as floral induction (See Chapter 4), and the unique ways in which particular species are adapted to the particular regions where they occur. Similarly, annual temperature fluctuations are quite variable and are to some extent a function of latitude. Such fluctuations may be measured in various ways, one of which is the difference between the monthly mean temperatures for the hottest and the coldest months. Using this metric, values as high as 20C are characteristic of a high-latitude (for *Gossypium*) area like Arizona, whereas a fluctuation of 4-5C characterizes a tropical area like Oaxaca.

## PRECIPITATION

Rainfall patterns of wild *Gossypium* habitats vary in their total amount and in their seasonal distribution. Certain extremely arid regions (the Arabian peninsula, central Australia, Baja California) have such restricted amounts of annual



rainfall (often less than 50 mm annually) that patterns of seasonal distribution are of minimal ecological significance. More commonly, wild cottons grow in areas of less extreme aridity, but the annual rainfall is still less than 500 mm in most cases. However, where the total amount of rainfall is higher, the seasonality becomes of greater significance. Many parts of the tropics are characterized by wet-season, dry-season cycles, often with an extreme contrast between the two seasons. In such regions, the total amount of rainfall is an imperfect index to the climatic impact of precipitation on vegetation. The wild cottons have adopted different strategies to enable them to survive the aridity and to evolve in the different regions in which they occur, as will be discussed subsequently.

### SUNLIGHT

Prevailing wind patterns are rarely a significant factor in the ecology of species of *Gossypium*, but the amount of insolation, on the other hand, appears to be a very important factor. It is, of course, closely (and inversely) related to the precipitation patterns. Those species that grow where rain rarely falls are exposed to high incidences of sunlight. Most of the regions where wild cottons are indigenous have relatively high rates of insolation. Moreover, *Gossypium* species either grow in very open types of vegetation or have arborescent growth habits that rise above the associated vegetation. They typically grow fully exposed to the incident light and not in the shade of other plants, with the exception of *G. longicalyx* from East Africa and several species from northern Australia.

### SOILS

General statements about the soil types typical of *Gossypium* habitats are difficult to make because few data are available. Apparently a majority of the species grow on well-drained soils, however, often on relatively steep slopes with excellent drainage. Some desert species show a preference for growing in dry or intermittent stream beds (arroyos), often in nearly pure sand, where water is preferentially available on the relatively rare occasions when rain falls (often flash floods), but where water nevertheless quickly drains away.

### BIOTIC FACTORS

The place of biotic factors in the ecological milieu is clear enough but dealing with them in any depth becomes too complex for present purposes. It will suffice to enumerate some of the more important factors. Reference has already been made to the influence of the associated vegetation on the ecology of individual species. This influence involves such obvious factors as crowding and shading and such less obvious factors as mycorrhizal association or parasitism by mistletoes, about which little is known at the present time. Allelopathic interactions with other species may exist, but have not been studied in *Gossypium* to my knowledge. Also important are biotic interactions with various pests and diseases such as nematodes, chewing and sucking insects, fungal and other pathogens, etc.

Where host-specificity is relatively precise (as in the cotton rust disease, for example) the interactions can have considerable ecological significance.

## ADAPTATIONS

Ecological adaptations of the various species of *Gossypium* (or of any other plants) may be discussed in either of two different ways. On the one hand, a reductionist approach may be adopted, and individual morphological, physiological, or other factors may be conceptually isolated and emphasized. Alternatively, a holistic approach may be used, discussing individual species or groups of similar species in terms of the integrated constellations of adaptations they possess. In view of the complexity of these adaptational phenomena and relationships, and in view of the limited knowledge we have for the wild species of *Gossypium*, I believe the subject can be more profitably approached here from the latter (holistic) point of view. Accordingly, I will discuss species or species-groups in terms of the more outstanding adaptational patterns they exhibit.

The first group I wish to discuss comprises three Mexican species, *G. aridum* (Rose & Standl.) Skov., *G. lobatum* Gentry, and *G. laxum* Phil. & Clem. These three arborescent species are closely related and occur principally along the west-central coast of Mexico in the short-tree forest that is subject to extreme wet-season, dry-season fluctuation. The wet season extends from about May to September and the dry season from about September to May. The life cycles of these trees are closely adapted to this climatic cycle. When the wet season begins and moisture again becomes available, the plants leaf out and begin active vegetative growth, which continues as long as moisture is available. When the rains cease and residual soil moisture begins to decline at the beginning of the dry season, the leaves senesce and abscise, and blossoming occurs. Flowering thus reaches a peak when the plants are leafless. Fruit maturation follows during the height of the dry season, when the plants are otherwise dormant, and indeed when the vegetation of the area generally is dormant as a result of the severity of the drouth at this season.

The flowering cycle of *G. aridum* is described by Mauney (1968) as follows: It is photoperiodic and begins initiating flower buds when the photoperiod is shorter than 12 hours. The first squares are borne in short, one-node fruiting branches, and are dormant. The buds become progressively less dormant as the season progresses. Thus, the first blossom to expand, at about the time of severe drought and defoliation, is the top-most bud. Subsequently, the buds break dormancy and blossom from the top downwards on the stems.

Interestingly, the adaptation to severe drouth in these species does not involve morphological factors for limiting water loss. Instead, these plants have adapted their life cycles to take advantage of the wet season with typical mesomorphic growth but to endure or escape the dry season with dormancy. The flowering and fruiting pattern is deferred until the onset of the dry season.

A second group of species includes three shrubby species, *G. harknessii* Brandg., *G. armourianum* Kearn., and *G. turneri* Fryx., from extremely xeric habitats around the Gulf of California in western Mexico. These species are subject to high temperatures, high insolation, and low rainfall through most of the year. They have evolved adaptations of xeromorphic nature than permit them to withstand these extreme conditions. These adaptations include a compact growth habit, the shrubs being broader than tall and the branching pattern intertwining; small leaves with a suberized epidermis to minimize water loss; a double palisade layer (with spongy mesophyll in between) to retain photosynthetic capacity while minimizing water loss; and deciduous involucre bracts, which possibly are also an adaptation for minimizing water loss. Contrary to the preceding group, this group does not have a dichotomy between its vegetative and reproductive phases, but flowers and fruits when in leaf and metabolically active.

Species such as *Gossypium populifolium* (Benth.) von Muell. ex Tod. from the northwestern part of Australia also have relatively small leathery leaves. Its nearest relatives from the same general area, *G. pilosum* Fryx., *G. costulatum* Tod., and *G. cunninghamii* Tod., *G. pulchellum* (Gard.) Fryx., and several undescribed species have similar though less extreme morphology. All of these species die back more or less to ground level during the dry season and then resprout from the perennial rootstock during the subsequent wet season.

Two species from central and western Australia, *G. sturtianum* J.H. Willis and *G. robinsonii* von Muell. have evolved glaucous, heavily suberized foliage as a means of limiting water loss. This feature is more fully developed in the former species, which also has the capacity to fold its leaves inward when subjected to water stress. *G. robinsonii*, on the other hand, is less xeromorphic but apparently grows preferentially directly in the beds of the intermittent watercourses of its desert habitat and thus has direct access to available moisture during the brief season (December-February) when rain falls. This tendency to prefer dry stream beds subject to flash floods is also characteristic of *G. raimondii* Ulbr. (coastal Peru), *G. thurberi* Tod. (southern Arizona and Sonora), *G. incanum* (Schwarz) Hillcoat and *G. areysianum* Deff. (southern Yemen; cf. Hearn, 1968), to some extent *G. gossypioides* (Ulbr.) Standl. (Oaxaca), and probably also *G. somalense* (Gurke) Hutch. and *G. anomalum* Wawr. & Peyr. (Somalia and Sudan). These species show few xeromorphic adaptations (except for dense pubescence in some species) but manifest their xerophytism principally in their choice of microhabitat and presumably also in an aggressive root system.

*Gossypium triphyllum* (Harv.) Hochr. occurs in the severe deserts of southwestern Africa. It has evolved a deeply divided (trifoliolate) leaf that limits transpirational water loss, a feature presumably enhanced by its fine close tomentum. Little ecological information is available for this species, however, other than the knowledge that it is adapted to one of the more extreme deserts of the world.

*Gossypium longicalyx* Hutch. & Lee is unusual in being an understory shrub (trailing or scandent), growing in shady situations with *Acacia*, *Terminalia*, *Combretum*, and similar vegetation. It occurs in East Africa (Uganda, Tanzania) in a region of more than 500 mm annual rainfall. Its preference for shaded habitats is unusual for *Gossypium*, although this preference is shared with some of the northern Australian species, as previously noted.

Two species show extreme expressions for *Gossypium* in tolerating low temperatures, but in two different ways. *Gossypium thurberi* is the northernmost species of *Gossypium*, reaching southern Arizona. Since it occurs at elevations as high as 2000 meters, it is growing in a temperate zone climate, the only *Gossypium* to do so. It achieves this adaptation by undergoing leaf senescence and abscission (simultaneously with fruit maturation) in the autumn, and becoming fully dormant by the winter months. In this case, the move toward dormancy is not triggered by declining moisture supplies in the soil, but rather by the advancing season (daylength, temperature regime, or some combination of factors). The dormant plants are fully capable of withstanding hard freezes, and do so regularly, resprouting the following year (when moisture permits) from old stems several feet above ground level. This hardiness is a physiological capacity that no other *Gossypium* possesses.

The other type of cold tolerance is exhibited by *Gossypium sturtianum*, the southernmost species of the genus, from central and southern Australia. This species cannot withstand hard freezes, but has the capacity, when in full leaf, to tolerate temperatures at freezing or a few degrees below freezing, without adverse effect. The protoplast of this species thus has some physiological characteristic not shared with other species of the genus. Hexaploids involving *G. sturtianum* and *G. hirsutum* L. (Muramoto, 1969) retain at least some of the cold tolerance of the *G. sturtianum* parent.

Most of the world's species of *Gossypium* occur in relatively arid habitats, as discussed previously. In general, these habitats tend to be inland habitats or, if near the coast, not a part of the littoral vegetation (Fryxell, 1965, 1979). Some of the wild tetraploid species, on the other hand, are principally found in the littoral vegetation or derived from it, most notable the indigenous forms of *G. hirsutum* found in coastal habitats around the Gulf of Mexico, the Caribbean Sea, and in parts of the South Pacific. Such localities are habitats of relatively high salinity, resulting in part from the continuous bombardment by salt spray characteristic of coastlines, and from the results of occasional severe storms that inundate and drench the soil with sea water, thereby increasing soil salinity. There are, of course, strong physiological parallels between aridity and salinity, both being agents of water stress. The point to emphasize here is that these coastal cottons are adapted physiologically to relatively saline habitats, and that this adaptation is one of their distinctive characteristics.

The preceding discussion of ecological adaptations of *Gossypium* spp. is largely anecdotal and inferential in nature, because ecological knowledge of these species

and of their habitats is quite limited, since field studies have been made of relatively few of them.

## SUMMARY

The almost 40 species of *Gossypium* occur in many parts of the world and are adapted to a variety of habitats, many of them arid. The present study considers this ecological spectrum from a holistic point of view, discussing individual species or species groups in terms of the integrated constellations of adaptations they possess. This viewpoint is considered important in two respects: (a) It is important to understand the evolutionary origins of the cultivated species; and (b) it is important to understand the spectrum of variation that exists in the genus which may be exploited in the cultivated species through germplasm manipulation.

*SECTION I*

**DEVELOPMENT OF THE PLANT**

## Chapter 2

# VEGETATIVE GROWTH AND DEVELOPMENT OF FRUITING SITES

Jack R. Mauney  
USDA-ARS  
Phoenix, Arizona

## INTRODUCTION

The cotton plant has perhaps the most complex structure of any major field crop. Its indeterminate growth habit and sympodial fruiting branch cause it to develop a four dimensional occupation of space and time which often defies analysis. The research reported in this review is representative of the attempts to quantify the physiology of the production of the fruiting sites which ultimately lead to lint and seed. Though the older studies used obsolete cultivars and cultural practices, the data may be taken as indicative of the trends in modern cultivars and practices. However, caution is appropriate in the use of field data about fruiting patterns. No research has been conducted in fields of cotton which were free of insects and diseases; no such fields exist. Therefore, to some extent these stresses always confound our interpretations of the physiological processes which produce fruiting sites. However, awareness and caution should reduce our chances for confusion.

## MORPHOLOGICAL DEVELOPMENT

The morphological development of the cotton plant leading to production of flower buds (squares) was reviewed by Hector (1936) Tharp (1960) and Mauney (1968, 1984a). The essentials of this process are that the primary axis of the plant remains vegetative throughout the life of each individual plant. Axillary branches differentiate at the base of each leaf on the plant and these branch axes are responsible for all vegetative limbs (monopodia) and reproductive branches (sympodia). Schematic representation of typical branch structures is shown in Figure 1.

There are usually two branch buds at the base of each leaf. Mauney and Ball (1959) designated the more-prominent of the buds the "first" axillary and the slower-developing one the "second" axillary. They studied the anatomical relationship of these buds and found the second axillary to be a branch off the first axillary. This relationship is important because it influences the tendency of the

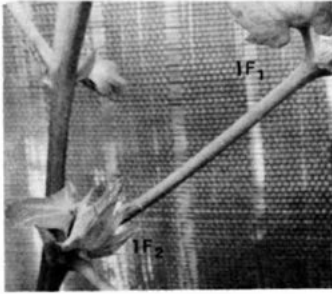

UPPER NODES: EXCEPTIONAL FRUITING

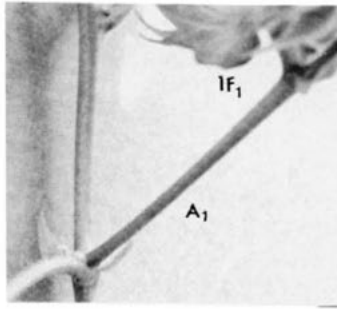
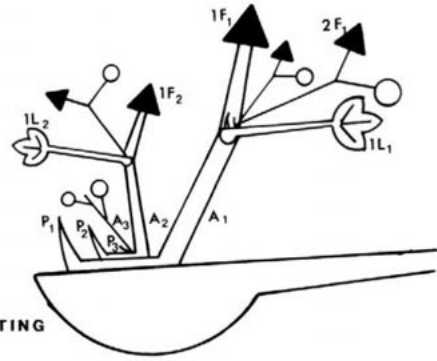

INTERMEDIATE NODES: TYPICAL FRUITING

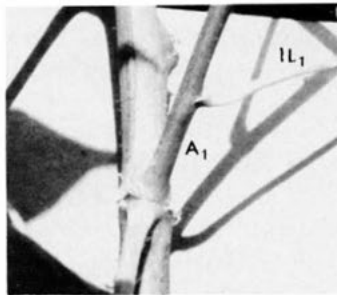
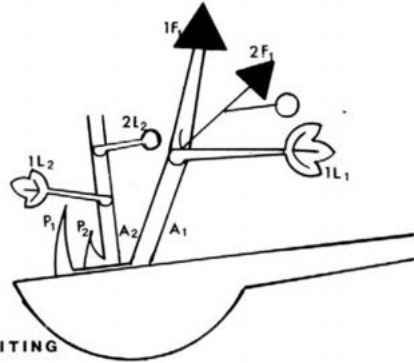

LOWER NODES: VEGETATIVE

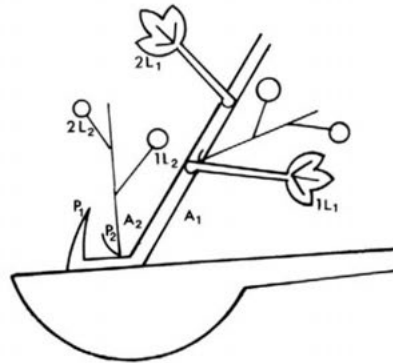





Figure 1. Photographic and schematic representations of vegetative and fruiting axillary branches from low, intermediate and upper nodes of a plant.

 —expanded true leaves (L),  —unexpanded true leaves (L),  —prophylls (P),  —flower buds (squares) (F). Numerals refer to the position of the organ along the branch, subscripts refer to whether the organ is on a first ( $A_1$ ), second ( $A_2$ ), or third ( $A_3$ ) axillary. Thus,  $1L_1$  is the first true leaf of the first axillary,  $2F_2$  is the second flower of the second axillary, etc.



buds to produce flowers. At low nodes on the main stem the first axillaries are vegetative and may elongate into vigorous vegetative limbs (Figure 1 Vegetative). When the plant is induced to flower, the first axillary becomes a fruiting branch and the second axillary remains vegetative and usually dormant (Figure 1 Typical Fruiting). Once induced, the plant seldom reverts to producing vegetative buds at the first axillary position. This does happen, however, and occasionally there will be one or more vegetative limbs above the first fruiting branch.

At higher nodes the plant may become vigorous in reproductive development and produce floral branches at both the first and second axillary (Figure 1. Exceptional Fruiting). Although these second axillary floral branches are usually short spurs which produce only one flower, they are potentially important sites for additional bolls. The second axillary position at the base of each square on the sympodium may also develop into a square. Thus, in vigorously-flowering plants, each sympodium may bear twice as many squares on a given number of nodes as in less-vigorous plants.

### VEGETATIVE GROWTH

Since all reproductive branches arise at the base of vegetative leaves, the initiation and the rate of formation of sympodia are partially dependent upon vegetative growth. Mauney (1966), Zaitzev (1928), and Hesketh *et al.*, (1972) have shown that the rate of vegetative growth prior to onset of flowering is temperature-dependent. Hesketh *et al.* (1972) observed that the plastochron (days between successive organs) for leaves was three times as long at 18C as at 30C. At 30C they found the leaf plastochron to be 2.2 days.

Though the rate of production of new vegetative leaves—and therefore new fruiting branch sites—is highly dependent on temperature, it is also very sensitive to water stress. For that reason the rate of vegetative leaf growth cannot continue the exponential increase which it exhibits during the seedling and juvenile stages of plant development. At some point the leaf area begins to exceed the capability of the root system to explore new soil volume or to absorb and transport water to the stomates. The point at which growth reduction will be observed will depend on complex soil, weather, and plant interactions, but it is certain to occur. The familiar sigmoid growth curves of all organisms are based on the certainty that an exponential increase in size can continue for only a relatively short period before some resource becomes limiting. In the case of cotton seedlings, uptake of water probably becomes that limiting factor (Mutsaers, 1983b; also see Chapter 10).

Upon germination the root system of the seedling develops more rapidly than the leaf area which is limited to cotyledon expansion. True leaf expansion is delayed by the fact that cotton has no plumule above the cotyledons in the germinating seed (Mauney, 1984a). The root system continues to expand during the 7 to 10 days in which the true leaves differentiate and develop up to expansion of the first true leaf. The first five true leaves are progressively larger in mature area. Thus, the leaf area equivalent for each node of the stem increases as growth

continues. Branch primordia are more active at about the fifth node, and first vegetative and then fruiting branches form secondary leaves. This means that the leaf area equivalent for each stem node increases from the first to about the tenth node. (Mutsaers, 1983b)

Assuming that the roots are growing into a soil profile at field capacity, at some point in the progression of seedling growth the root area/leaf area ratio will reach a maximum and then decline to a level at which root expansion into wet soil matches leaf area expansion. If additional water is then added to the soil through rain or irrigation there will be a temporary increase in growth. Growth cannot exceed the capability of roots to absorb and transport water. Significantly, in a glasshouse experiment (Mauney *et al.*, 1978) growth, as measured by rate of addition of primary leaves, began to decline two weeks prior to appearance of the first blossom (Figure 2). These plants were never visibly stressed for water or

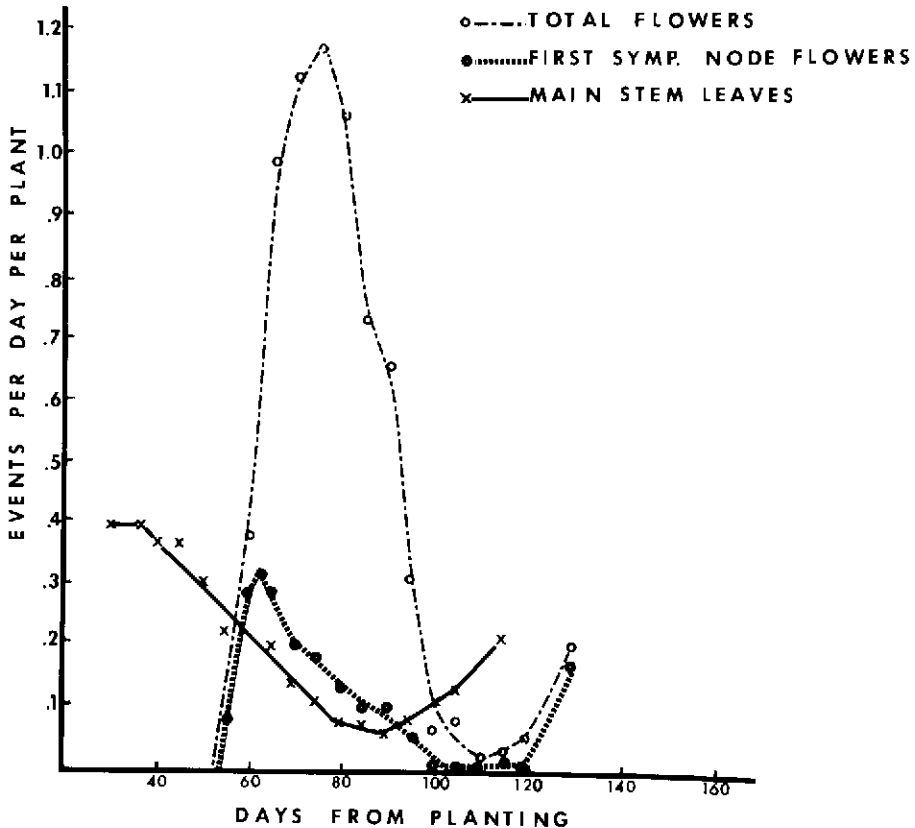

Figure 2. Rate (expressed as number appearing per day) of leaf and flower development with age of cotton plants grown under glasshouse conditions in Arizona (see Mauney *et al.*, 1978 for conditions).

mineral nutrients. As seedlings they achieved the plastocron predicted by Hesketh *et al.* (1972) but declined in growth rate long before carbohydrate competition by bolls became a factor.

Guinn and Mauney (1983a) observed that delaying the first irrigation until two weeks after the first square was visible did not reduce the initial rate of flowering in Arizona. This water stress did reduce the rate of vegetative growth but in some years the number of flowers in the first two weeks of flowering was greater in the water stressed treatments than in the well-watered plots. The increase in early flowering was in years in which there was a significant population of plant bugs (principally *Lygus* species). They concluded that fewer squares were shed in the water stressed plots because the plants were less attractive to plant bug feeding.

Restrictions in growth due to severe water stress after onset of flowering have generally been found to reduce yield (Grimes *et al.*, 1970; Guinn and Mauney, 1983b). Although water stress caused some square shedding and a reduction in boll retention, Guinn and Mauney (1983a) found that the principal cause of reduction of yield was the reduction in numbers of flowers three weeks after the severe water stress. The reduction in flower numbers is a measure of the effect of water stress on vegetative growth and production of new fruiting branches.

## INITIATION OF FLOWERING

Though initiation of flowering in modern cultivated cottons is not significantly influenced by photoperiod (Mauney and Phillips, 1963), there are environmental influences on the process. Mauney (1966) observed that differentiation of the first floral bud could begin as early as 10 to 14 days after emergence. At this stage of growth the plant will have two or three expanded true leaves. The removal of these leaves will delay flowering (Mauney, 1963). The day and night temperature and the quality and intensity of light during this stage of plant development can change the placement of the first fruiting node.

The length of time between planting and development of the first square and flower depends also upon the node at which the first fruiting branch appears (NFB). At lower temperatures the NFB is lower (Mauney, 1966; Moraghan *et al.*, 1968; Low *et al.*, 1969; Hesketh *et al.*, 1972). NFB was 6 when plants were grown at 26C/23C (day/night) but was 10 when plants were grown at 32C/29C. Because of the complex interaction of growth rate and node of initiation, the time from emergence to first square may be shorter at certain cool temperature regimes than at higher temperatures.

In field plantings, however, cool temperature is a primary reason for delay in both first square and first flower. Constable (1976) found that a 4-week delay of planting caused only a 1-week delay of the date of first flower (DSF). This was due primarily to the shorter time from seedling emergence to first square at the higher temperatures of the later plantings. He calculated the growing degree days (GDD) for the period of planting to first flower. Using 14C as the base, his GDD for this period was 647. Bilbro (1975) also observed that DSF was not delayed

equally with a shift in planting date. DSF was delayed only 2 days because of a 3-week delay of planting. He calculated a GDD of 621 using a base temperature of 14C. Mahon and Low (1972) used 10C as the base for their calculations and found GDD to be 880-900 from planting to first flower. This converts to about 650 if the base is 14C. Anderson (1971a) found that delay of emergence by low temperature was poorly correlated ( $r^2 = .25$ ) with the number of days to first square in five varieties which differed markedly in maturity classification.

### FLOWER DEVELOPMENT

After initiation, the continuation of flowering is, of course, a function of vegetative growth which produces sites for additional fruiting branches and of

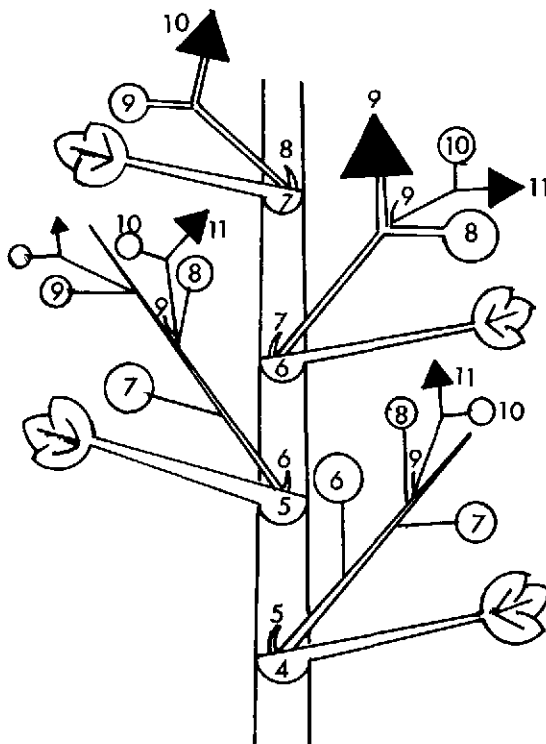





Figure 3. Schematic representation of a main stem axis in transition from vegetative branching to reproductive branching. This plant had the first flower from the branch at node 6. The numerals represent succession of leaf units (true leaves, ; prophylls, ; and bracts of squares, ). Though the leaf units are not precisely equal in time length (isophase), they are approximately 2.5 to 3.0 days. Events with the same leaf unit number should occur within a few days.

formation of additional nodes on existing branches. Both of these rates of node production are temperature dependent (Hesketh *et al.*, 1972): the rate at 30C was three times faster than it was at 18C. The base rate at 30C for successive initiation of additional fruiting branches, vertical flowering interval (VFI), was 2.0. The rate of adding successive nodes along a fruiting branch, horizontal flowering interval (HFI) was 6.0. Other workers have observed VFI to range between 2.2 and 4.0 and HFI to range from 5.8 to 8.5 (McClelland and Neely, 1931; McNamara *et al.*, 1940; Kerby and Buxton, 1978). Zaitzev (1928) argued that a relationship which he termed "isophases" should exist between the HFI and the VFI. Most observers have calculated the ratio HFI/VFI to be near 2.5 (Mutsaers, 1983a).

The reason that HFI is more than twice VFI can be seen by examining the net number of morphological events which separate the flowers in these two planes. Figure 3 shows development of a plant in the transition zone in which the plant shifts from vegetative branching to floral branching. By counting the sequence of developmental structures we see that there is a net of only one structure, the main stem internode, between successive flowers in the vertical plane. This is because all structures at successive nodes along the main stem can develop simultaneously, separated in age only by the time required to develop the internode. In the horizontal plane, on the other hand, both the prophyll and the subtending leaf must develop prior to differentiation of successive flowers. This means that at least two events separate flowers in the horizontal plane. The fractional nature of the prophyll event may account for the fact that the ratio of HFI to VFI does not calculate to an even number as Zaitzev expected that it should.

With onset of fruiting, an additional growth factor complicates the rate of addition of new sympodia. The plant slows production of main stem leaves, presumably because of the competition for carbohydrate from the developing bolls.

Baker *et al.* (1972; also see Chapter 19) developed computer simulations of cotton plant growth in which the supply:demand ratio for carbohydrate controlled the growth rate of the various plant parts. Using this program they were able to simulate the decline in growth of main stem nodes (MSN) which occurs with onset of fruiting.

Unpublished data from the glasshouse experiments described by Mauney *et al.* (1978) illustrate the decline of vegetative growth (Figure 2). These observations were made in maximal sunlight, optimum temperature (35C/22C, day/night, throughout) and no water or nutrient stress. In this optimum environment the rate of production of new MSN (and therefore additional sympodia) began decreasing with the onset of squaring. Shortly after the onset of blossoming the rate of flower opening (inverse of VFI) exceeded the rate of new leaf formation. The inevitable result of this excess of flower opening over new leaf and sympodia formation was that the flowers opened at nodes closer and closer to the apex of the stem. In time, the plants expended the positions available and flowering stopped. Renewed

growth of the vegetative apex then produced new floral sites and blossoming resumed—after a hiatus.

Cessation of flowering is, of course, cut-out. The fact that it occurs even in the absence of environmental stress indicates that it is a basic pattern of growth for the cotton plant. However, genetic background and environmental stress undoubtedly influence the magnitude of the excess of flower opening to new leaf and sympodium formation and, thus, both the timing and the severity of the cut-out phenomenon.

In field experiments, Kerby and Buxton (1978) observed a slight increase in VFI during the first 30 days of flowering. In Figure 5 their data are plotted with VFI observations from our glasshouse study and additional (unpublished) data from field plantings in 1976 in Arizona. The trend in each of these experiments was the same, toward greater VFI as the season progressed.

Temperature is a confounding factor in field observations and might largely account for the differences in average VFI among years. However, the increases in VFI with seasonal progression in the field are very much like those observed in the glasshouse where temperatures did not change throughout the experiment. This suggests that the greater VFI is due to a slowing of growth in the field which is similar to that observed in the glasshouse.

The fact that the total flowers per plant per day also reaches a peak and then decreases to near zero (Figure 2) implies that the sympodia are limited in length

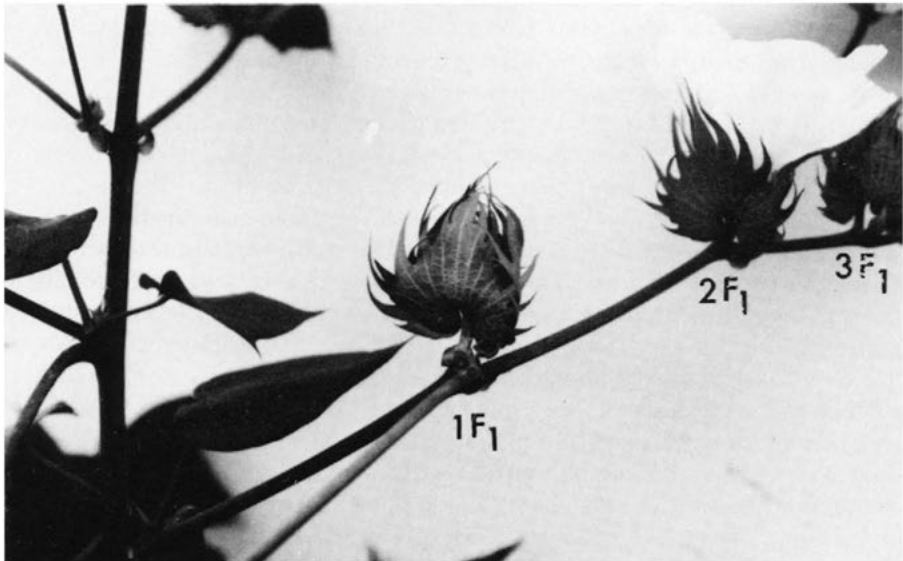

Figure 4. Prime sites for harvestable bolls are the first three flowering positions along each branch. Shown here are a boll at the first node ( $1F_1$ ), a flower at the second node ( $2F_1$ ) and a square at the third node ( $3F_1$ ).

and that HFI becomes greater as the season progresses. This was observed to be the case (Figure 5 HFI-GH). For comparison, the data of Kerby and Buxton (1978) and unpublished data from this laboratory from field plantings in 1976 are plotted in Figure 5. The failure of Kerby and Buxton (1978) to observe a significant shift in HFI may be due to the longer initial HFI which they observed (due apparently to low temperature, particularly in 1974). Further, their observations did not extend into the latter portion of the flower production season when increased HFI is most apparent.

Hesketh *et al.* (1972) reported temperature effects on rate of square maturation (square period) which were similar to those calculated for other organs. i.e. the rate at 39C was three times that at 18C. The square period at 30C was 22.5 days. Other workers have observed square periods of 23 days, (Martin *et al.*, 1923), 22-30 days (Beckett, 1927) and 20-23 days (Brown, 1938).

Since a longer square period could account for some of the increase in VFI and HFI plotted in Figure 5, I have examined unpublished data from the glasshouse experiments described by Mauney *et al.* (1978). In these experiments, in which average daily temperature was 29C, the square period was 21.6 days and did not change significantly from the first to the last square produced. Matthews (1978) reported that, in Arizona, squares produced on sympodia at main stem node 10 took 5 days longer to mature into blossoms than those from branches at main stem node 15. Increasing temperatures in June may have influenced the shorter square period of the higher nodes. Hintz and Green (1954), on the other hand, observed that squares appearing in August in Oklahoma had about 1 day longer square period than those appearing in July. Lower August temperature was probably the cause of this slower growth.

The implication of these findings is that, although production of squares up to visible size (*ca.* 3mm.) is a function of vegetative growth (which, in turn, is sensitive to boll load as well as temperature and other stresses), the growth of the square after it becomes visible is not sensitive to growth of the vegetative organs of the plant. This conclusion further implies that visible squares are either photosynthetically self-sufficient or are sufficiently powerful as sinks that the limited amount of carbohydrate needed for their growth can be supplied by the plant even during stress. The conclusion of Hearn (1969) that sympodial growth is limited by competition for light would seem to indicate that squares (at least those several nodes out on sympodia) are not able to draw carbohydrate from distant leaves. Although these data are not definitive, they would seem to favor the hypothesis that squares are primarily self-sufficient. (See Chapter 20 for other aspects of square development).

### PRIME SITES OF FRUITING

Tharp (1962) calculated that in 10 weeks from the first bloom a cotton plant could produce 156 flowers without considering vegetative branches. This estimate is too high for several reasons. The principal error was the assumption that

fruiting branches would continue to elongate indefinitely. The longest branches in Tharp's model had 12 nodes. This number of nodes is seldom observed in field plantings. In dense stands the first fruiting branches soon become shaded and either cease growing or shed a large proportion of the squares or fruit which are initiated.

Table 1 lists observations of the placement of harvestable bolls covering more than 50 years of experimentation on widely differing cultivars and locations. Invariably, greater than 80 percent of all yield has been found at the first (1F<sub>1</sub> in Figure 4) and second (2F<sub>1</sub> in Figure 4) nodes on the fruiting branches. The agreement among these data indicates a basic physiological limitation of the positions beyond the first two nodes on each fruiting branch. Mathews (1978) and Kerby and Buxton (1981) have observed a somewhat greater tendency of the 2F<sub>1</sub> position to retain a harvestable boll if 1F<sub>1</sub> has been lost. However, in no case did

Table 1. Placement of harvestable yield by percentage at each node on fruiting branches.

Reference	Location	Yield at fruit branch node			Lint yield (kg/ha)
		1F <sub>1</sub>	2F <sub>1</sub>	Other	
McNamara <i>et al.</i> (1940)	Texas	56	26	18	ca.300 <sup>1</sup>
Munro (1971)	Africa	62	32	6	1030
Mauney <i>et al.</i> (1978)	Greenhouse	43	32	19	1740
Mauney—unpubl—1976	Ariz.	71	26	3	
Mauney—unpubl—1977	Ariz.	76	20	4	
Mauney—unpubl—1978	Ariz.	74	22	4	900
Mauney—unpubl—1980	Ariz.	76	18	6	1200
Mauney—unpubl—1981	Ariz.	59	25	16	1850
Kerby & Buxton (1981)	Ariz.	76	16	8 <sup>2</sup>	
Kerby—unpubl—1982	Calif.	69	27	4	

<sup>1</sup>Yield from variety tests at Greenville, Texas 1931-38

<sup>2</sup>Includes all bolls matured on vegetative branches as well as at nodes three and greater on fruiting branches.



this compensation change  $2F_1$  into a boll retention pattern characteristic of  $1F_1$ .

Kerby and Buxton (1981) included all bolls on vegetative branches with those at positions greater than  $2F_1$  on fruiting branches. They placed only 8 percent of harvestable yield in this category (Table 1). Mauney (unpublished) observed about 10 percent of harvestable bolls located on vegetative branches and that bolls on vegetative branches were almost exclusively at the  $1F_1$  position. A photograph of bolls on a vegetative branch published by Hubbard (1931) shows all bolls located at  $1F_1$  positions.

Hearn (1969) observed that as the density of planting increased the average number of fruiting points per main stem node decreased. At about 18,000 plants per acre he observed two nodes per sympodium of an indeterminate variety (BAR x L) and about three nodes per sympodium on a more rapidly fruiting determinate variety (Wild's Early). At a density of about 9,000 plants per acre, he observed about the same number of nodes per sympodium but about 50 percent more total squares per main stem node. Since his notation of squares per main stem node included all squares on vegetative limbs, he concluded that the principal effect of plant density was on the development of the vegetative limbs rather than on the length of sympodia. He contended that competition between adjacent plants determines the number of vegetative limbs and competition within each plant determines the length of fruiting branches. Apparently, after sympodia have developed three nodes, they are stressed by self shading and perhaps by nitrogen partitioning (see Radin and Mauney, Chapter 10) so that additional growth is limited and site productivity reduced to nil.

The number of sympodia which plants make in a season is influenced not only by the characteristics of the season, but also by the rapidity of new leaf development (leaf plastochron) and by the growth habit of the cultivar. Even relatively indeterminate cultivars such as DPL 16 begin to lengthen plastochron with onset of fruiting (Figure 5). Under ideal growing conditions in glasshouses Mauney *et al.* (1978) found that flowering reached a peak and then dropped to nil in about 60 days. Under such conditions, the plants produced 18 sympodia (unpublished data). Under less-favorable growing conditions, the initial flush of flowering may last longer, but plastochron will be longer and the total number of sympodial nodes will be changed very little. Matthews (1978) observed few sympodia at main stem nodes higher than 25 under irrigated conditions in Arizona. With severe temperature, nutritional, or moisture stresses, the growth of the plants will be restricted so that fewer sympodia will be produced.

If we accept that the first three nodes on each sympodium are the most likely sites for mature bolls, then 18 sympodia will produce about 50 prime square positions since the last few sympodia to develop will not have time to mature all three nodes. If 50 percent, 30 percent, and 10 percent of the squares at sympodial nodes  $1F_1$ ,  $2F_1$ , and  $3F_1$  respectively, mature into open bolls with 1.5 gms. lint per boll, 30,000 plants per acre would produce 1500 lbs. of lint per acre. Under favorable conditions this level of yield can be achieved before cut-out.

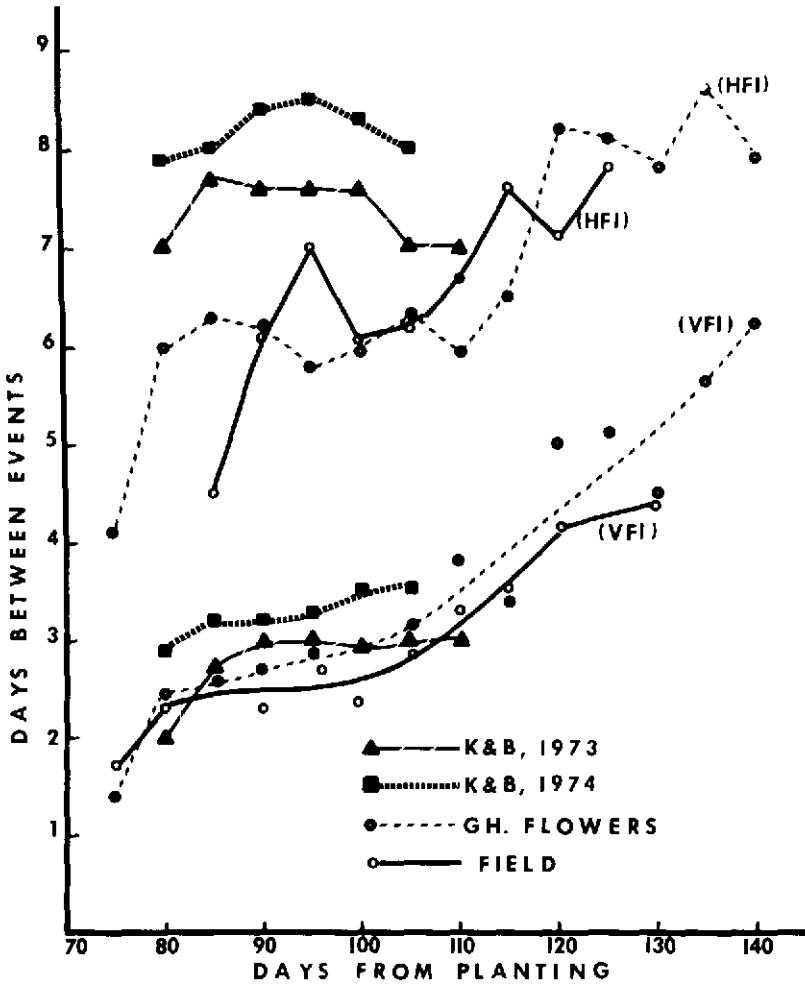

Figure 5. Rate (expressed as days between events) of flower development with age of cotton plants in field and glasshouses in Arizona. Vertical flower interval (VFI) in days between flower at the first node of successive fruiting branches. Horizontal flower interval (HFI) in days between flowers at successive nodes of the same fruiting branch. K&B is data from Kerby and Buxton (1978). Other data unpublished data of Mauney.

Graphic representations of average plants from plantings yielding 1000 and 2000 kg/ha (or lbs/ac) lint are shown in Figure 6 (Mauney, 1984b and unpublished). This representation depicts placement of bolls from field plantings in Arizona, but I believe it is fairly representative for other locations as well. The greater yield of the 2000 kg/ha planting was achieved by a greater number of main-stem nodes rather than utilization of more nodes per branch.

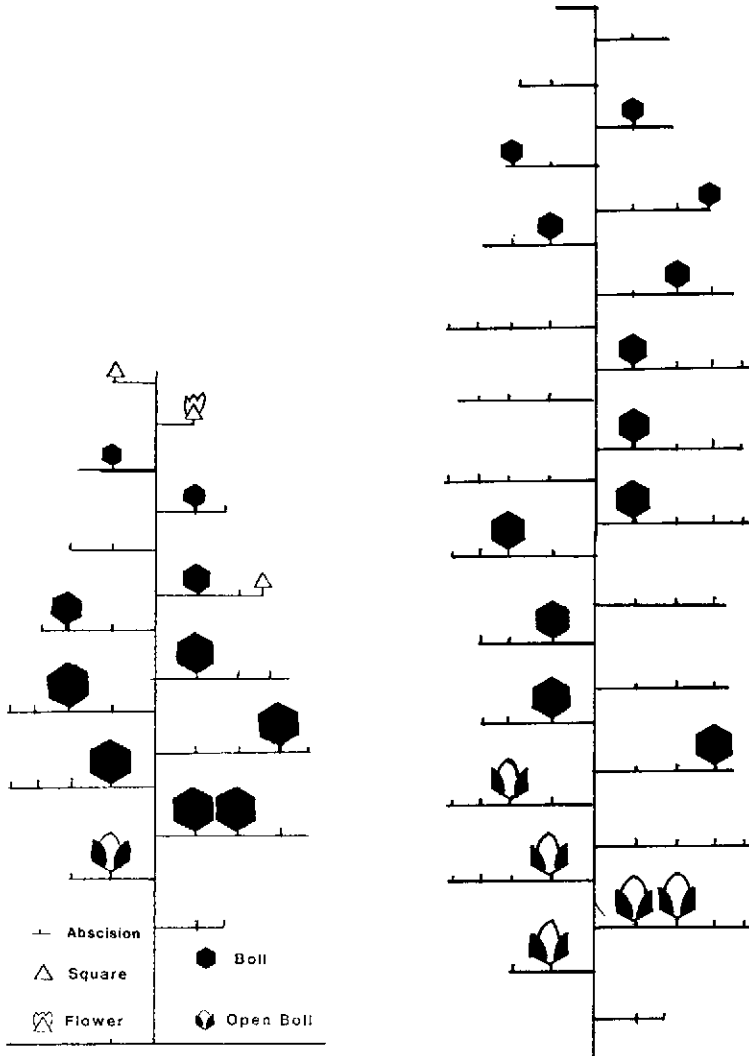

Figure 6. Schematic representation of boll locations on average plants from plantings yielding 1000 kg/ha (left) and 2000 kg/ha lint (right).

## EARLINESS

“Earliness” in a cotton crop has several possible definitions. One that has been used is that of a high proportion of the crop harvested at first pick (Richmond and Radwan, 1962; Ray and Richmond, 1966). This definition has advantages when comparing varieties at a specified location, but it is obviously subject to extreme variation among locations and years.

Another definition of earliness is reaching an acceptable yield potential in the shortest time from planting. This concept was used by Munro (1971). He analyzed the components that would contribute to fewer days from planting to production of 30 fruiting points. The components of earliness he examined were DSF, NFB, VFI and HFI. In his analysis he used DSF=70, NFB=5, VFI=3.5 and HFI=10. He concluded that producing 30 fruiting points 9 days earlier could be accomplished by (1) advancing the DSF by nine days, (2) lowering the NFB by 2.0 nodes, (3) shortening the VFI by 1 day or, (4) shortening the HFI by 9 days. While changes of this magnitude are not practical for some of these characteristics, combinations of these changes would, of course, be additive in their effect on earliness.

Munro (1971) also observed that seven additional flowering positions on vegetative branches, reduction of fruiting point shedding from 60 to 46 percent or shortening the boll period by 9 days would similarly shorten the period for acceptable yield by 9 days. He considered that the most useful characters to modify by breeding were DSF and the boll maturation period. He analyzed the data of Mooseberg (1969) and found that more than half the earliness of an improved variety was due to these two characters.

In his analysis Munro did not consider one source of earliness that is under both genetic and cultural control; that is, the production of second axillary squares at nodes of the sympodia. From the previous discussion of the morphological relationships of the axils of both vegetative and sympodial leaves, it is obvious that these positions are available for differentiation into flower buds. There is genetic variability in the tendency of the second axillary to develop into a square or remain a dormant vegetative bud. *G. barbadense* varieties are more likely to develop second axillary flowers than are *G. hirsutum* varieties (King, 1930). There are also cultural and environmental influences. In glasshouse experiments on the effects of photosynthetic rate upon yield (Mauncy *et al.*, 1978) we observed (unpublished data) that the plants in a CO<sub>2</sub>-enriched glasshouse had more second axillary squares than the plants in the control glasshouse. In view of the fact that, if fully expressed, this trait could produce twice as many fruiting positions in a given time, the trait appears to offer a powerful method of achieving earliness.

Unfortunately none of these second axillary sites are prime sites as defined here. The squares are at least one HFI unit later in blossoming than the first axillary flower at that node (Figure 7). Perhaps because of the competition for nutrients for growth, two bolls at a branch node is a rare event.



Figure 7. Branch on which a second axillary flower ( $1F_2$ ) has developed. Relative timing of this position is shown by the fact that blossoming of the  $1F_2$  position occurred at the same time as the second position on the first axillary ( $2F_1$ ). The boll at the first node of the first axillary ( $1F_1$ ) was shed from this branch.

Namken *et al.* (1978) described a genetically determined trait which causes a high percentage of plants to have one or more pairs of sympodia in an opposite configuration on the main stem rather than the typical alternate pattern. They named the trait "side-by-side". This trait shortens the VFI by an average of 0.3 to 0.5 days and significantly improves earliness.

Most reports describing efforts to breed earlier-maturing varieties have indicated that the length of time from planting to first square is well correlated with the length of time to harvesting the majority of the pickable lint. Anderson (1971b) measured a correlation coefficient of  $r^2 = .45$  ( $P < 0.001$ ) between days to 50 percent first squares and days to 85 percent of seedcotton pickable. While there was no attempt to examine the components of this earliness according to the categories of Munro, it is likely that vigor of vegetative growth, initiation of first fruiting branches at lower nodes and shortening of the VFI would contribute to this correlation.

Baker *et al.* (1973) observed that increased photosynthetic efficiency would not only increase yield but also earliness. Hearn (1969) found that varieties differed not only in the node of first sympodium but also in the HFI. He found no differences in VFI among the varieties he studied. It is apparent that several

mechanisms for earliness exist among the varieties of the world and that analysis is required to determine the components of earliness in each selection situation.

## VEGETATIVE—REPRODUCTIVE RATIO

The data quantifying flower site production and interactions with environmental factors appear relatively complete. However, none seems to answer clearly the persistent question of why there are situations in which excessive square shedding or extreme vegetative growth produces tall, relatively barren plants.

The ratio of vegetative structure of each plant to the reproductive sites is a function of the number of vegetative nodes below the NFB, the vigor of vegetative limbs and the number of flower sites on each sympodium. Hearn (1969) found that plant density was a primary determinant of the number of vegetative limbs and that the number of flower sites per sympodium was determined by the genetics and internal competition among branches of each plant. Thus, in the basic sense only the number of nodes below NFB is variable for environmental and cultural control of vegetative/reproductive ratio (V/R). After floral initiation and development of the first sympodium, the morphological V/R has been fixed. In practice, however, growers observe non-productive plants and non-productive years which they attribute to cultural or weather-induced excessive vegetative growth. However, since each main stem node above NFB produces a sympodium with the potential for at least three fruiting sites, the poor V/R must be the result of excessive square shed rather than excessive vegetative growth. Without bolls to compete for carbohydrate, the vegetative main stem continues rapid proliferation of new leaves and the result is tall, unproductive, "stag" plants.

There is general belief among growers that excessive V/R tends to be self-perpetuating unless they apply cultural stresses such as delay of fertilization or irrigation schedules. Based on the growth and flowering rate relationships shown in Figure 2, I suggest the following about self-perpetuating square shed. If Figure 2 is the normal course of vegetative growth for productive plants, what is the effect of loss of the first bolls which are effective carbohydrate sinks? The rate of MSN development would remain high, and instead of the open blossoms approaching the plant apex more and more closely, they would remain 10 to 12 nodes below the apex within the canopy. Guinn (personal communication) has observed that young squares are very susceptible to shedding under conditions of shade. If, as I suggested earlier, they are primarily photosynthetically self-sufficient, the shading of the rapidly developing terminal might be sufficient to induce square shedding. To pursue this logic further, perhaps one reason that high plant populations are more likely to be "vegetative" is that self shading of squares occurs in dense stands when the plants are at an early stage of development.

Self-perpetuating square-shed may also be induced by excessive insect damage. Leigh *et al.* (1974) observed that plant bugs were a more severe problem in well-

watered, rapidly growing, closely spaced stands than in stressed and relatively open plantings.

Whatever the exact interactions which result in high V/R, the implication of the hypothesis is that the importance of setting the early bolls far outweighs their direct contribution to yield. When the first few sympodia are loaded with active carbohydrate sinks, the productive pattern represented by Figure 2 follows its natural course. Without these sinks, stem elongation, self shading, and perhaps excessive insect injury can result in tall, barren plants which are difficult to manage culturally.

## GROWING-DEGREE-DAY SUMMATIONS

Because growth and maturation of the cotton plant is temperature dependent, many workers (Bilbro, 1975; Mahon and Low, 1972; Anderson, 1971a; Kerby *et al.*, 1985; Sevacharian and El-Zik, 1983) have suggested that the progress of the crop could be monitored by summations of the growing-degree-days (GDD). Fry (1983) examined the various methods of calculating average GDD summations for individual days. Most calculations seem to use 15.3C (60F) as a base temperature and no upper threshold. Kerby *et al.* (1985) suggested that use of 38C (100F) as an upper threshold would improve the correlation of GDD with growth stages.

While GDD summations can be used as a rough guideline to growth stage expectation during a season (Sevacharian and El-Zik, 1983), the summations must be qualified for cultivar, location, and year. Table 2 shows the range of values which have been assigned to aspects of crop development. Correlations would be expected to fit poorly when water or nutrient stress, insect infestations or physical damage by weather or chemicals produced an unusual plant stress.

Table 2. Range of published GDD (base 15.3C) summations for individual phases of crop growth and maturation and the seasonal sum at which these phases have been found to occur.

Growth phase	Growing degree days	
	Phase	Seasonal sum
Emergence (stand establishment)	45-130	45-130
Appearance of first square	350-450	480-530
Square period	250-500	
Appearance of first flower		740-1150
Peak blooming rate	200-800	850-1625
Boll period	910-950	
First open boll		1690-2050
Defoliation		2550-4600

## SUMMARY

Because the flowering habit of cotton, *Gossypium hirsutum* L., is complex and extends over a long period of time, considerable research has been directed at describing and quantifying the production of fruiting sites by the plant. The first flower buds are borne on fruiting (sympodial) branches at the fifth to tenth main stem node. Flower buds open as blossoms about 3 weeks after they are first visible. After the first fruit (bolls) are set, the growth rate of the main stem slows, then eventually stops. For a time, blossoms open at a faster rate than new floral branches are formed. When all floral bud sites formed in the initial vegetative growth phase have matured into blossoms, there is a hiatus in flowering known as cut-out. Subsequently, the resumption of vegetative growth produces new floral sites and a second flush of flowering occurs. Though sympodia are morphologically indeterminate, they ordinarily are limited to three active floral nodes in field plantings.

All processes leading to square, blossom and boll initiation and maturation are temperature-dependent. The rate of development at 30C is three times faster than that at 18C. In favorable sunlight, temperature, moisture and nutrition environment each plant will produce about 15 to 20 sympodia and about 50 flower buds which will blossom over a period of 60 days. From these, 10 to 15 bolls can be expected to mature into harvestable lint and seed. In order to produce the same number of bolls in a shorter season the plant must begin sympodial development at a lower node, have more rapid floral organ growth, produce more flowers from a specified number of sympodial nodes or retain a higher percentage of the sites to maturity.



## Chapter 3

## GROWTH OF ROOTS

B.L. McMichael  
USDA-ARS  
Lubbock, Texas

## INTRODUCTION

The growth, development and function of plant roots in relation to plant productivity has been very difficult to evaluate, especially in natural field situations. Weaver (1926) and co-workers stated over 50 years ago that "An exact knowledge of the root development of crop plants, of their position, extent and activity as absorbers of water and solutes at various stages of growth is of paramount importance to a scientific understanding of plant production." The accumulation of this knowledge becomes more important as more crops are grown under adverse conditions and the need for production efficiency increases.

This portion of the treatise on cotton physiology will concentrate specifically on providing a general overview of root growth and development in cotton, methods of measurement, some factors affecting cotton root growth, and root/shoot relationships that affect productivity.

## THE ANATOMY OF THE COTTON ROOT

The cotton root system as described by Brown and Ware (1958), Hayward (1938), and Tharp (1965) consists of a primary or 'tap' root which may grow for several days after germination without branching. When branching does occur the lateral root primordia develop generally about 12 cm behind the primary root apex with tertiary roots developing about 5 cm behind the secondary root apex (Mauney, 1968). If the primary root happens to become injured, there generally is an increase in the number of secondary roots one of which may take over and act as the primary root.

The anatomy of the cotton root has been described in some detail by Hayward (1938) and others (Spieth, 1933; Baranov and Maltzev, 1937). In general, the epidermis of the cotton root is a single layer of cells surrounding the cortex which is made up of spongy parenchyma cells usually 10-12 cells thick. The endodermis is another single cell layer that encloses the stele which consists of a cell layer called the pericycle as well as the xylem and phloem elements along with other parenchyma cells in the central part of the stele. The xylem elements are arranged into distinct bundles usually in a tetrarch (four separate bundles) with the younger protoxylem located at the outer radii and the older metaxylem near the center

of the stele. Hayward (1938) states that it is possible for the primary root to be a pentarch with five distinct vascular bundles present. Recent work by McMichael *et al.* (1983) confirms this in several cotton strains (Figure 1). They also de-

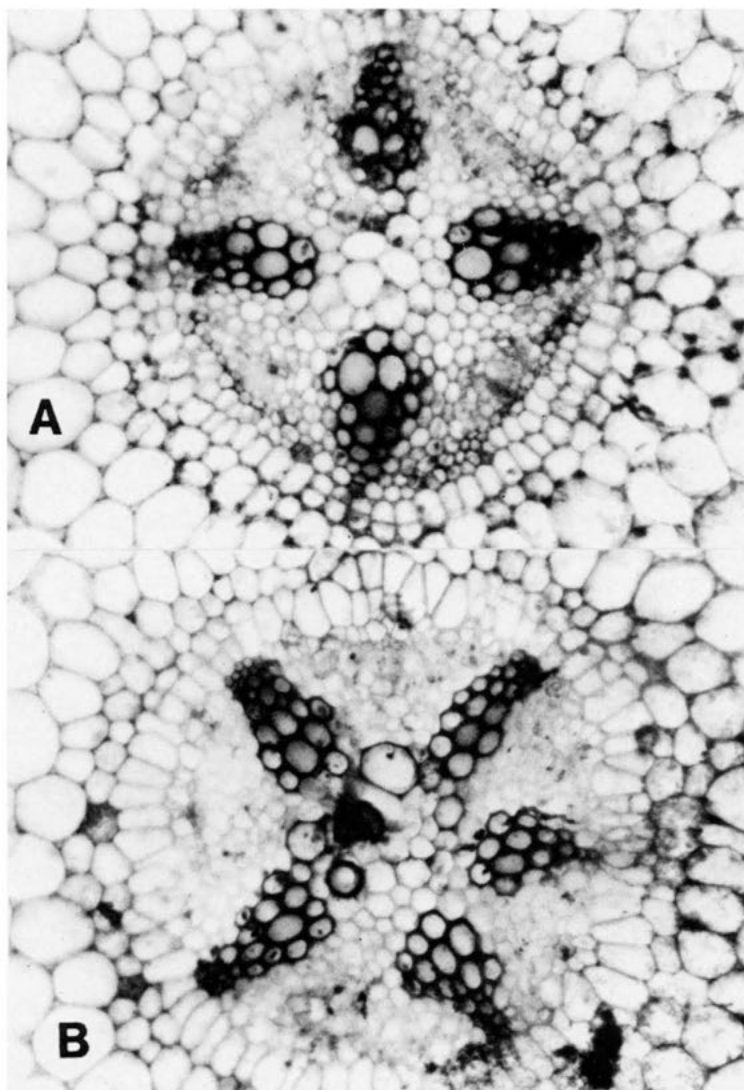

Figure 1. Xylem pattern in primary roots of *G. hirsutum* cv. DPL-16 (A) and *G. hirsutum* cv. T25 (B). The tetrarch arrangement (A) is typical of cultivated cottons. The pentarch arrangement (B) has been found in drought tolerant types. (X100)

scribed a hexarch pattern in some primary roots of other cotton strains. They suggested that the number of vascular bundles in cotton may be an inherited trait of some importance in determining differences in root morphology that have been observed.

The proto-phloem is located between the radii of the vascular bundles and eventually gives way to formation of the sieve tubes and companion cells. As the root grows and secondary thickening takes place, the epidermal and cortical cells disappear while the pericycle remains to protect the mature root. During the seedling stage rings of sieve tubes and xylem vessels are formed along the outer edges of the stele as one moves along the root toward the junction of the hypocotyl and as the root ages (Speith, 1933).

## METHODS FOR MEASURING ROOT GROWTH IN COTTON

In recent years measurement techniques have been described for investigating root growth and development in cotton as well as other crops, particularly in field situations. In addition, screening techniques for accurate evaluation of genetic diversity in root growth have been developed. Rapid technological advancements in related fields such as engineering, soil physics, and plant physiology have made it possible to accurately estimate root growth and development, and scientists have become more aware of the importance of root activity to plant productivity. It is therefore important to discuss the methods used to evaluate the growth of root systems to give some idea how specific problems associated with root research may be approached.

Bohm (1979) and Heen (1980) described a number of methods that have been and are currently being used to evaluate plant root systems in both the greenhouse and field situations. They also describe several techniques for washing roots from soil samples and make recommendations as to which techniques may be most useful in helping to answer specific questions. Bohm (1979) groups and classifies the various methods for studying root growth. These range from the more tedious and time-consuming excavation, monolith, and auger methods to such techniques as root observation laboratories (rhizotrons), other glass wall methods, and more indirect methods such as radioactive tracers. Each method, as Bohm (1979) points out, has certain advantages and disadvantages depending on the research objective and the resources available. Excavation methods, for example, are not only extremely labor intensive, but also require that a large amount of field plot area be disturbed and rendered unusable for similar studies for a number of years. The glass wall methods, on the other hand, allow root studies to be conducted in somewhat natural, undisturbed situations in the same area for repeated seasons. Greenhouse methods for studying root systems range from growing plants in small pots and washing out the roots to growing plants in much deeper and larger diameter containers to simulate the volume of soil a plant might occupy in a field environment.

Since it is impractical to discuss in detail here all of the methods for measuring root growth, I will briefly outline two methods we are currently using in our laboratory to measure root growth in cotton both in the greenhouse and in the field.

The greenhouse method we are using to evaluate differences in root growth in different cotton germplasm is similar to that described by Reicosky (1972). Large polyvinyl chloride (PVC) tubes 20 cm in diameter and 180 cm long are first cut into sections 15 cm long to a total length of 1 m and into 30 cm sections for the remaining length of the tube. The tube is then re-assembled and the seams of each section taped with heavy duty tape. A 2 cm window is also cut into each section and re-taped to facilitate periodic sampling of the soil in each section for water content. One end of the tube is covered with a wire mesh screen and the assembly is placed in a larger diameter container. The space remaining in the container is filled with coarse gravel to maintain the tube in a free-standing upright position. Coarse gravel is placed in the bottom of each tube to a depth of 4-6 cm to insure proper drainage. Each tube is filled with soil and packed to a known bulk density. Water is applied to fill the profile to 'field capacity'. Seeds are planted and the plants thinned to one plant per tube when the plants reach the first true leaf stage. The treatments for a particular experiment are imposed when the plants reach the desired stage of growth. Root samples are collected at various times during the experiment by removing the tape from each section and slicing through the bottom of the section with a metal cutting tool to obtain only the volume of soil and roots contained in that section. The roots in each section are washed free of soil and the total root length and root length density determined by the methods described by Newman (1966). The total dry weight of the roots in a particular section as well as the total profile is measured. The tubes may then be re-assembled and used again in other experiments.

The method we are using to evaluate the growth of cotton roots in the field involves the use of a glass wall observation tube called a minirhizotron (Bohm, 1979). This technique was first proposed by Bates (1937) as a less costly alternative to the glass wall observation trenches. Waddington (1971) and Bohm (1974) also described this technique. The method basically consists of drilling or augering a hole in the soil to the desired depth (usually 1.5 to 2 m in our studies). The diameter of the hole is only slightly larger than the diameter of the tube to be inserted to insure a good contact between the tube and the soil with minimum air gaps. We have been using 10 cm diameter tubes in our studies that are installed in the row at approximately 30 degrees from the vertical to prevent roots from striking the soil-glass interface and growing down the tube as might be the case if the tubes are installed vertically. Waddington (1971) and others used glass tubes for their minirhizotrons, but more recently Plexiglas tubes have been substituted for the glass tubes (Sanders and Brown, 1979). We are currently using Plexiglas tubes for the minirhizotrons in our cotton studies. The tubes are etched with a grid

system before being inserted into the soil. The grid not only indicates depth but also serves as the system for measurement of root length and root length density by counting the number of roots crossing the horizontal transects of the grid.

Waddington (1971) used a fiber-optic technique for observing root growth in the minirhizotrons. Bohm (1974) later used a mirror attached to a pole equipped with a light source to observe root growth in his system. Recently Sanders and Brown (1979) utilized a fiber-optic technique by attaching a 35-mm camera to a fiber-optic scope allowing photographs of the roots intersecting the transparent walls to be taken and later evaluated using an image analysis system. We are using a borescope apparatus equipped with a light source and a low-light sensitive television camera to record the images of each section inside the tube on video tape. The tape is replayed in the laboratory and intersections of roots in each scene are counted on a Newman (1966) grid superimposed on a television monitor. This technique allows measurements to be made on total root length and root length density in cotton throughout a profile during the entire season in a relatively natural undisturbed field situation.

## THE DEVELOPMENT OF THE COTTON ROOT SYSTEM

The general development of the cotton root system has been described by Balls (1919), Baranov and Maltzev (1937), Collins and Warner (1926), Pearson (1974), Brown and Ware (1958), Hayward (1938), and Taylor and Klepper (1978). The depth of penetration of the primary root and the formation, number, and depth of penetration of lateral roots may vary according to the variety of strain, soil type, soil water content, and other soil and plant related factors. The influence of some of these factors on root growth will be discussed later, but in general the primary root may penetrate to depths of over three meters under some conditions (Balls, 1919a) while the lateral roots may remain fairly shallow—less than one meter (Hayward, 1938). Thus the root distribution within a soil profile (usually expressed as cm of root per cubic cm of soil or root length density) may vary considerably depending on the conditions to which a particular plant is subjected. The rate of root elongation in soil may range from as much as six cm per day (Taylor and Ratliff, 1969) to considerably less than one cm per day depending on the conditions. The lateral roots extend outward from the taproot sometimes to a horizontal length of over two meters (Taylor and Klepper, 1978). The total root length continues to increase as the plant develops until the maximum plant height is achieved and fruit begins to form (Taylor and Klepper, 1974, 1978; Pearson and Lund, 1968). The root length then begins to decline as plant height stays the same and older roots die.

The total volume of soil explored by a cotton root system for water and ions, hence the development of root density, is related to the ability of the root system to produce secondary roots. The more fibrous the root system the greater the potential for increased rooting density. The lateral root primordia arise from the

cambial region of the stele and are arranged in rows along the primary root. The number of rows correspond to the number of vascular bundles present in the stele (Brown and Ware, 1958). McMichael *et al.* (1982) presented evidence to indicate that those cotton lines that possess five or six vascular bundles also have the potential for producing five and six rows of lateral roots respectively. If the number of lateral roots are increased due to the increased number of primary root vascular bundles, it is possible for those plants to have a greater root density, explore a greater soil volume, and have increased capacity for water and nutrient uptake up to some maximum density necessary to deplete the soil profile. It is interesting to note that roots with an increased number of vascular bundles also should have an increase in the amount of phloem present and thereby an increased potential for movement of material into the system to promote root growth.

The genetic control of root growth in cotton has been alluded to (Taylor and Klepper, 1978), but little work on the evaluation of available cotton germplasm for differences in root growth or specific rooting patterns has been conducted. The evaluation of several exotic photoperiodic strains of cotton for several characteristics including taproot growth and lateral root development was conducted by Quisenberry *et al.* (1981) using 35-day old greenhouse grown plants. They found significant differences in the taproot length and the number of lateral roots between a number of the strains. They suggested these differences may be associated with differences observed in adaptation to drought conditions. McMichael *et al.* (1982) evaluated a number of the exotic cotton strains for differences in root development using other techniques. They evaluated the growth patterns of the taproot and the lateral roots of young seedlings that were growing under constant temperatures in small polyethylene growth pouches filled with nutrient solution. The taproot length, lateral root length, and number of laterals were measured daily for seven days. The results showed significant differences as found by Quisenberry *et al.* (1981) in older plants. This technique allowed a large number of entries to be evaluated over a relatively short period of time. Additional studies need to be conducted on genetic differences in rooting patterns and the inheritance of specific traits associated with root development and plant productivity.

## SOME FACTORS AFFECTING COTTON ROOT GROWTH

Most of the factors that directly affect root growth in cotton are soil related (Pearson, 1974; Carson, 1974) although above ground processes in the plant such as photosynthesis, fruiting, and development of leaf area interact to influence root development. For the purposes of this portion of the discussion, only soil related factors will be mentioned.

### SOIL TEMPERATURE

The temperature of the soil is generally lower than that of the air and less subject to rapid fluctuations during the season (Nielsen, 1974). The temperature

at which roots of most plants exhibit maximum growth rates is lower than that for aerial organs. It appears from several different studies that the optimum soil temperature for cotton root growth is somewhere between 28°C and 35°C (Pearson, 1970; Bloodworth, 1960; Letey, 1961; Taylor, 1972). When the soil temperature deviates significantly from the optimum a number of things may occur. At low temperatures root growth is reduced and less branching occurs (Brouwer and Hoagland, 1964). Water uptake is also reduced (Nielsen, 1961) and nutrient uptake is altered (Nielsen and Humphries, 1966). Christiansen (1963) states that subjection of cotton roots to low temperatures may cause death of the root cortex tissue. Guinn and Hunter (1968) reported a buildup of sugar in plant roots exposed to low temperatures.

The exposure of cotton roots to temperatures higher than the optimum also has an adverse effect on growth. More branching seems to occur (Nielsen, 1974) and enzymatic activity and metabolism is reduced (Nielsen, 1974). Taylor (1983) and Arndt (1937) indicate that the overall rate of cotton root elongation is reduced at high temperatures. Thus, the changes in root growth and activity as a function of temperature may have an effect on both root length and root length density, but, as Taylor (1983) points out, reliable field data to determine to what extent this occurs is generally lacking. This information is important, however, since there are many problems with things such as stand establishment in much of the cotton growing areas of the country which are affected by the low soil temperatures at planting time (Wanjura, 1972; and Chapter 36).

## SOIL STRENGTH

The growth of cotton roots through compacted soil layers such as plow pans or through areas of very high bulk densities may present severe problems in many soils where cotton is grown. Taylor (1974) gives an excellent review of the effects of changes in soil strength on the growth of root systems of cotton as well as other crops.

In general, studies with penetrometers (devices used to measure soil strength) have shown that as the soil resistance increases root elongation rates decrease (Grimes, 1975; Taylor and Ratliff, 1969; Grimes, 1972; Pearson, 1970). Since differences in soil strength are closely related to soil water content (Taylor and Ratliff, 1969; Grimes, 1972), the decrease in root growth and penetration into lower depths of a profile could mean that there would be less total water available to the plant. This could also mean that the plant would extract water from only a very limited area of the total soil volume (Grimes, 1972).

Changes in root morphology also may occur when plants are grown in soil with high strength characteristics. Taylor (1963) found that cotton grown in soil of high strength had roots with small diameters (<0.9 cm) which contributed to significant yield reductions. Mathers (1967) found that xylem and phloem cells were much smaller in cotton roots that were grown in soil with restricted layers than roots that had not been subjected to high strength layers. The manifestation

of these responses in root growth in high strength layers has been suggested by some to be hormone mediated (Russell and Goss, 1974).

Many of the effects of changes in soil strength on root growth are not documented. In some cases roots may find their way through the high strength layer by means of worm holes or cracks so that differences in top growth may not be evident (Taylor, 1983).

### SOIL AERATION

The concentrations of the soil gases, particularly oxygen and carbon dioxide, or the balance of the levels of the two in the soil may significantly reduce or enhance root development.

In general, the soil air is about 20 percent oxygen, 79 percent nitrogen, and <1 percent carbon dioxide at a depth of about six inches (Stolzy, 1974). These concentrations may vary considerably - to <5 percent oxygen and as much as 20 percent carbon dioxide. Cannon (1925) reported oxygen concentrations of 7-8 percent in the soil he was studying. Clements (1921) stated that the carbon dioxide levels in the soils in his experiments ranged from <1 percent to 15 percent depending on the conditions.

The concentration of the soil atmosphere is influenced by a number of factors including soil temperature and soil water content. Cannon (1925) reported that temperature had an effect on soil atmosphere composition by its direct influence on the partial pressures of the gases. Russell and Appleyard (1915) stated that the oxygen concentration in a waterlogged soil fell to as little as 2 percent with little change in the carbon dioxide level. Similar results have been reported elsewhere (Stolzy, 1974).

Cotton roots respond to changes in the composition of the soil air. Their growth does not seem to be hindered by carbon dioxide levels that significantly reduce root growth in other plant species (Kramer, 1969). Cotton roots do seem to be highly sensitive to changes in oxygen concentrations. The elongation of the taproots was reduced when they were exposed to 5 percent oxygen levels for a short period of time and were killed within three hours after the soil air was purged of oxygen (Huck, 1970). These results are not surprising since oxygen is required for root respiration and growth. Whitney (1941) studied the effects of changes in the composition of the soil air on water absorption by a number of crops including cotton. He concluded that water uptake was reduced by either the toxic effects of carbon dioxide reducing root cell permeability, or the reduction of respiration due to the low oxygen levels, or an interaction between the two effects. The latter is likely to be the case under most field situations.

### SOIL WATER

The changes in water content of the soil affects the growth and productivity of plant tops via changes that occur in absorption of water by plant roots to replace transpirational water losses and maintain plant turgor for growth. Soil water



content also may have a direct effect on the growth rates and distribution of roots within a soil profile. There have been excellent reviews and articles written dealing specifically with the absorption of water by plant roots, the resistances encountered as water moves along the water potential gradient to the leaves, and interactions between water and nutrient uptake by roots (Russell, 1977; Taylor and Klepper, 1978; Newman, 1974; Taylor and Klepper, 1975; Gardner and Ehlig, 1962; Rose and Stern, 1967; Gardner, 1964; Hillel *et al.*, 1975). The reader is referred to these works for more in-depth study of these subjects. This portion of the discussion will be limited to the more direct effects of changes in soil water on the overall growth rates and distribution of cotton roots.

The distribution of cotton roots may be altered by changes in soil water content, particularly as the soil dries out (Taylor, 1983). Rooting depth may be increased in drying soil (Klepper, 1973) while root elongation rates may be significantly decreased (Taylor, 1983). Taylor and Klepper (1974) also show that root density in cotton decreases as soil water content decreases. There may or may not be significant alterations in root activity as the soil dries since root proliferation may occur at lower depths to maintain water uptake rates and the growth of plant tops (Browning, 1975; Taylor and Klepper, 1974). Root densities may decrease to 0.2 cm per cubic cm and still be effective in water extraction (Jordan, 1983). Taylor and Klepper (1971) have shown that the water extraction per unit root length in cotton does not change with depth so that a root may be as effective, for example, in extracting water at 100 cm as it would be at 10 cm. McMichael (1980) observed that the root length density increased significantly at the lower depths and decreased at the upper soil layers (<30 cm) in several commercial cottons during a period when the soil was allowed to dry. The root length density of plants in irrigated plots was always greatest in the upper part of the soil profile (<30 cm). He also observed that total root length reached a peak about 80-85 days after planting when maximum plant height was achieved. Taylor and Klepper (1974) noted that root length did not increase in a soil layer when the water content of that layer fell below 0.06 cubic cm/cubic cm or a soil water potential of about -1 bar. They also showed that when a dry soil was rewetted both plant height and root length resumed growth and continued to increase.

Thus, changes in soil water content and soil water potential may change rooting patterns and may or may not change root activity in relation to top growth if the changes in soil water status are gradual so that the root systems can adapt to the changing environment.

## ROOT-SHOOT RELATIONSHIPS

The root and shoot environment interact with growth processes in a plant to modify the genetic potential of the plant and influence productivity. The relation between root growth and shoot growth is therefore very complex and depends on many factors acting simultaneously within the plant system. Aung (1974), in his

extensive review of root-shoot relationships, emphasizes this complexity and views the plant as an integrator of many environmental influences.

In general, root growth in cotton (namely total root length development) increases as the plant develops until fruiting begins (McMichael, 1980). The total root length reaches a peak at peak plant height and reproductive growth commences. There is a linear increase in the shoot-root ratio, however, up until that time. Eaton (1931) and Eaton and Joham (1944) in earlier studies, showed that the defruiting of cotton plants caused an increase in the size of the root system as well as the carbohydrate content of the roots. Crowther (1934a; 1941) showed also that nitrogen and water applications to cotton plants stimulated the growth of the above-ground parts of the plant but suppressed root growth.

The root-shoot ratio is generally reduced, as stated above, as reproductive growth occurs since the overall growth rate of the roots is reduced (McMichael, 1980; Aung, 1974). McMichael and Quisenberry (unpublished) observed similar results in fruiting and non-fruiting lines of cotton they investigated. The shoot-root ratio may also be altered by the influence of factors other than fruiting such as changes in soil temperature, soil moisture, and alteration in the top growth such as changes in total plant leaf area (Aung, 1974; Russell, 1977). Russell (1977) also points out that the control mechanisms for partitioning of dry matter into roots or shoots may be hormone mediated since evidence for the role of plant hormones in promoting or inhibiting growth processes has been documented in recent years. Regardless of the actual control mechanisms conditions favoring early root growth are desirable to establish a root system capable of supporting the growth of the above ground portion of the plant during periods of stress or other adverse growing conditions.

## Chapter 4

# INFLUENCE OF ATMOSPHERIC PARAMETERS ON GROWTH AND DEVELOPMENT

Meryl N. Christiansen  
USDA-ARS  
Beltsville, Maryland

## INTRODUCTION

The genus, *Gossypium*, evolved in tropical, drier parts of the world. In spite of man's efforts to alter the species from a nominally Mediterranean climate-adapted, photoperiodic perennial to a temperate annual, it still bears the attributes of its tropical origins in that it is somewhat drought tolerant and prefers warm temperatures and sunshine. Alteration of the major climatic variables of temperature, water, light, photoperiod, and mineral nutrition can drastically alter initiation and retention of fruit forms and plant senescence.

## FLOWER INITIATION

The initiation of fruiting branches is influenced primarily by day length and temperature. The number of fruiting branches can be influenced by plant spacing or defruiting. Many of the tropical stocks of the geographic race *latifolium* are photoperiodic (Tomar, 1965; Mauney and Phillips, 1963); however, commercial American upland cottons which were derived from *latifolium* are essentially insensitive to day length. Many of the wild *latifolium* strains do show response to temperature and water balance in addition to day length (Hutchinson, 1959). In their natural habitat, the wild cottons normally produce leaves, flower, and set fruit following the wet summer season, and then defoliate and mature the fruit during the dry winter season.

Mauney and Phillips (1963) studied floral initiation in 36 lines representing 24 species. Day neutral and both short and long day photoperiodic types were noted. Commercial upland varieties initiated flowering with little or no evidence of photoperiodic response. However, they recorded as much as three nodes delay in fruiting branch initiation in both *G. hirsutum* and *G. barbadense* on 14-hour days as compared to 10-hour days. Low *et al.* (1969) also investigated the effects of

day length, radiation, and temperature levels on commercial varieties of *G. hirsutum* and *G. barbadense*. Their results parallel those of Mauney (1966). High temperatures raised node number of the first fruiting branch, particularly those of late or indeterminate *G. barbadense* lines. Longer day length delayed fruiting in both species but more so in *G. barbadense*. Low temperature promoted earliness in fruiting, but there was considerable influence by genotype.

A greater effect on flower initiation is shown by high temperature. Earlier reports (Dastur, 1948) indicate that lower night temperature favors vegetative branching. More recent studies by Mauney (1966) indicate the reverse; i.e., that high night temperatures (25C) delay flowering in upland regardless of day temperature. A day temperature of 25C combined with a lower (20C) night level enhanced flowering. *G. barbadense* (Pima) was also delayed in flowering by high day-night levels but the day temperatures exerted greater control.

A number of researchers at Texas A&M University (Kohel and Richmond, 1962; Kohel *et al.*, 1965; Kohel and Lewis, 1970; Lewis and Richmond, 1957; Waddle *et al.*, 1961; Kohel *et al.*, 1974) studied the inheritance of flowering response to environment in *G. hirsutum* and *G. barbadense*. In *G. barbadense* flowering is controlled by only a few genes with photocontrol dominant to day neutral. In photoperiodic *G. hirsutum*, flowering is controlled by the cumulative effect of multiple genes. Delays in flowering were noted in crosses between *G. hirsutum* day neutral and *G. hirsutum* non-flowering (presumably photocontrolled) (Kohel *et al.*, 1974).

The plant growth stage, when temperature treatment is applied, has some influence. Germination temperature can alter flowering branch initiation one node. The temperature after seedling emergence (7 days of germination) is of major importance in differentiation of the first fruiting branch. Thus, lower night temperatures during the immediate post emergence period can be instrumental in lowering the node of first fruiting. Chilling temperatures during germination can markedly delay time to first flower (Christiansen and Thomas, 1969) but does not alter the node level of first flowering branch. The chilling effect is on overall plant growth and development.

Recent greenhouse experiments show little or no effect of ambient air polluting oxidants on the initiation of flowering in eight commercial varieties of cotton, including seven uplands and one *G. barbadense* variety (Heggestad and Christiansen, 1978). Apparently, there has been little work directed at the role of light intensity or quality in relation to fruiting induction. Nor has there been any definitive research with increased CO<sub>2</sub> to enhance flower induction. One might conjecture that improvement of reserve metabolites in developing plants might speed the induction of flowering.

## THE NATURE OF FLOWER AND FRUIT ABSCISSION

Two major theories have been developed to explain the incidence and variation in fruit set in cotton. The hormone theory, as set forth by Addicott and Lynch (1955), involves a balance of auxin and growth retarding or anti-auxin hormones on proximal and distal sides of a potential abscission site. As boll load increases, production of anti-auxins increase and set of new fruit forms is reduced. An alternate theory holds that the organic nutritional status of the plant determines the quantity of fruit set. As an increasing number of bolls is added to a plant, the supply of carbohydrate lessens and new fruit forms are dropped (Chapter 12). A part of the evidence to support either the nutritional or hormone theory of fruit retention control lies in an examination of the response of photosynthesis, respiration, and plant hormone status to light, temperature, and gaseous environment.

### PHOTOSYNTHESIS AND RESPIRATION RESPONSE TO ENVIRONMENT

A treatise concerned with the effect of varying light quantity and quality, temperature and CO<sub>2</sub>, O<sub>2</sub>, and air pollutants on fruit retention should be concerned with the relationship of photosynthesis and plant nutritional status. Each of these environmental parameters directly influence photosynthesis and respiration and, therefore, may be controlling factors in establishing carbohydrate status of the plant.

**Temperature**—Temperature dependency of photosynthesis follows a normal curve with an optimal range and minima at each end of the temperature range. Cotton is moderately tolerant to heat. Photosynthesis is depressed 40 percent after 15 minutes at 46C (Esipova, 1959) as compared to a 95 percent depression of *Phaseolus vulgaris* in 5 minutes (Lyutova, 1952). No data are available for minimum temperature suppression but one would conjecture that 12-15C would be restrictive. Respiration is drastically reduced at 8C in cotton leaves (Amin, 1969). Most chilling sensitive species, including cotton (Amin, 1969; Stewart and Guinn, 1971) display greatly reduced respiration at temperatures below 10-12C (Lyons and Raison, 1970). Net photosynthesis (P<sub>n</sub>) for cotton shows a broad temperature optimum ranging from 25-45C with a total extinction point near 55C (El-Sharkawy and Hesketh, 1964). These data were collected from greenhouse plants cultured at relatively high temperatures. The responses were obtained from turgid, light saturated, detached leaves. The authors suggest that under such experimental conditions, P<sub>n</sub> optima tend to be higher than when whole plants are used.

**CO<sub>2</sub> and O<sub>2</sub>**—Throughton (1975) reported environmental effects on CO<sub>2</sub> uptake in cotton. Temperature exerted little effect or was not limiting to the initial photosynthetic rate at 100 ppm CO<sub>2</sub> or less. At higher CO<sub>2</sub> levels, uptake was restricted by temperatures of 12-18C. At 23, 26, and 33C, CO<sub>2</sub> level increased the photosynthetic rate at a linear rate to 300 ppm CO<sub>2</sub>. Oxygen exerted an inhibitory effect on CO<sub>2</sub> uptake; e.g., uptake photosynthesis maximized in the absence of O<sub>2</sub> at 150 ppm CO<sub>2</sub>. If oxygen was 22 percent, CO<sub>2</sub> fixation maximized at 300 ppm; at 44 percent O<sub>2</sub> the maximum CO<sub>2</sub> uptake at 400 ppm CO<sub>2</sub> was approximately 60 percent of the zero oxygen level (Chapter 17).

**Air Pollutants**—Oxidants in general suppress photosynthesis in higher plants as does fluoride and SO<sub>2</sub> if the pollutant levels are sufficiently high to induce chlorosis. Ozone, the most common air pollutant, has perhaps the most immediate effect on gaseous exchange in plants. When leaves are exposed to ozone, the stomate guard cells quickly lose turgidity, stomates close, and gas exchange is greatly reduced (Bennett, 1969). There is little direct information on cotton published, but there is ample evidence with many species to show that sub-lethal dosages of ozone markedly reduce photosynthetic activity. Although cotton is listed among the crops resistant to ozone (Hill *et al.*, 1961), recent studies by Heggstad and Christiansen (1978) indicate considerable genetic variation in sensitivity. Sensitive varieties respond with reduced fruit set, lower yields, and earlier cut out. Studies by Dugger *et al.*, (1966) on many species including cotton have demonstrated that ozone exposure causes a significant reduction in total carbohydrate, but an increase in reducing sugars and respiration, the latter perhaps as a consequence of readily metabolizable hexose sugar. Bennett (1969) reported an inhibition of starch synthesis by ozone. Possibly ozone inhibition of photosynthesis coupled with stimulated respiration causes tissue starvation, premature senescence, leaf abscission and early cut-out. Controlled studies with ozone while keeping temperature, humidity, water, and mineral conditions at optimum could perhaps serve to elucidate the nutrition-hormone relations of fruit drop. Unfortunately, ozone stress likewise induces ethylene, and thus the nutritional and hormone situation is again unseparable.

### **LIGHT, TEMPERATURE, OR GASEOUS STRESS EFFECT ON HORMONE STATUS**

A considerable volume of information has developed in the past decade concerning stress induction of abscisic acid (ABA) and ethylene in plants. A number of papers relate water stress (Allaway and Mansfield, 1970; Little and Eidt, 1968; Wright and Hiron, 1964) and osmotic stress (Mizrah *et al.*, 1970) with increases in ABA. Ethylene induction also is related to a wide array of injuries and stresses including insect injury (Williamson, 1950), warm nights (Guinn, 1976), low temperatures (Vines *et al.*, 1968), drouth (McMichael *et al.*, 1977; Jordan *et al.*, 1972), virus infection (Ross and Williamson, 1951), fungus disease (Wiese and

DeVay, 1970), mechanical injury (Abeles, 1973) and low light (Guinn, 1976). A secondary effect of ABA induction may well be increases in ethylene (Abeles, 1967).

## BASIC EFFECTS OF ENVIRONMENT ON ABSCISSION

Normal, healthy, well-nurtured leaves or fruit forms do not abscise. Injury, disease or senescence normally predates development of abscission. Variation in environmental factors to the point of stressing the plant can contribute to induction of the "abnormal" condition conducive to abscission. A number of aerial environmental factors including temperature, light, CO<sub>2</sub>, O<sub>2</sub>, and pollutants are known to affect abscission in controlled and field conditions.

In general, response to temperature by the abscission process is similar to other vital plant responses. Low temperature reduces the rate of action and a higher temperature stimulates activity (Yamaguchi, 1954). Extreme temperatures in the nature of chilling, freezing, or heat stress incite abscission as an injury response. Extreme temperature stresses which kill plant tissue usually prevent abscission because the abscission process is dependent upon viable tissue. A short photoperiod is generally correlated with induction of abscission (Garner and Allard, 1923). Autumn leaf fall is, thus, thought to be triggered by day length in certain species (Olmstead, 1951).

The gaseous environment can alter abscission under controlled conditions. For example, increased oxygen levels stimulate abscission of bean explants (Carns *et al.*, 1951) over a range of 0 to 50 percent; and increases of CO<sub>2</sub> tend to retard abscission in explants. The ability of ethylene, a natural air contaminant, to induce abscission is well documented (Abeles, 1967). Present evidence indicates that ethylene operates to decrease auxin in the petiole (Morgan and Durham, 1975) and increase enzymes that are involved in the activation of the abscission zone. Considerable information indicates that abscisic acid (ABA) induces ethylene which in turn induces abscission (Craker and Abeles, 1969; Abeles *et al.*, 1971). We (unpublished data) noted an inhibitory effect of rhizobotoxin (an inhibitor of ethylene synthesis) on ABA induction of abscission in cotton explants. This strongly suggests that environmental stress can exert an effect through induction of ABA, which induces ethylene, which in turn triggers abscission. Other non-hormone air pollutants such as ozone, SO<sub>2</sub> or NO<sub>x</sub> are noted for ability to hasten senescence of leaves.

## EFFECTS OF ENVIRONMENT ON FRUITING

Much of the early research to elucidate the factors contributing to fruit abscission pointed to plant nutrition or to the theories that "the cotton plant only retains bolls that it can feed." The early work of King and Loomis (1932) and Hawkins (1933) supported the nutritional idea as did that of Wadleigh (1944). In many

studies, low carbohydrate status was correlated with abscission. For example, application of sucrose retarded or reduced abscission in certain species (Went and Carter, 1948; Brown and Addicott, 1950), and girdling of plant stems to prevent downward translocation of sugars, so they would accumulate above the girdle, reduced abscission in fruit (Chandler, 1925).

In contrast to the above supportive evidence, Eaton and Ergle (1953) noted little difference in the mid-August carbohydrate status of early (high shedding rate) and late plantings (low shedding rate). They presented contradictory data from sugar applications and girdling studies to refute the involvement of nutritional status in boll shed.

Gibson and Joham (1968) found that low night temperature favored increased flowering and fruit set but reduced boll development. In complimentary research at the same location, sugar levels in developing bolls were monitored (Krieg *et al.*, 1968). Maximum sugar concentration (7 mg/g tissue) was found in 10-day old bolls at 25C night temperature. At lower temperatures (10-15C and 20C), sugars maximized after 15 days at about 60 percent of the level of the 25C treatment but remained at 4-5 mg/g tissue for up to 30 days boll age, while the 25C treatment dropped to 2 mg/g tissue or less. The simple sugars predominated in early boll development and sucrose gradually increased to predominate at 30-35 days of boll age. The dominate sugar during early boll development was fructose. The idea that high night respiration will deplete simple sugars and induce abscission is not supported by the data of Krieg *et al.*, (1968) in that fructose was highest at 25C and lower at 10-15-20C.

In recent years, Guinn (1974a, 1976a, 1977) has presented definitive data to support the nutritional thesis and to relate nutritional status with increases in ABA and ethylene and thus with theories regarding hormonal (especially ethylene) control of fruit abscission. Using low light and temperature manipulation to alter carbohydrate status, Guinn correlated ethylene evolution with carbohydrate status and related both to fruit set in cotton. He concluded that "the nutritional and hormonal theories of shedding are not mutually exclusive because a nutritional stress may increase ethylene evolution enough to promote abscission."

In a greenhouse comparison of filtered and non-filtered air, Heggstad and Christiansen (1978) reported prolonged growth, delayed senescence, and greater boll set on plants cultured in filtered air. Genetic differences in pollution tolerance were shown with Acala varieties being most tolerant and Paymaster 202 most sensitive. Brewer and Ferry (1974) reported a two-year study in California on the field assessment of pollution effects. They noted yield increases from 10 to 30 percent by cotton grown in filtered air in plastic enclosed field plots as compared to cotton grown in non-filtered air in comparable enclosures. Senescence was delayed several weeks by filtered air and boll set was increased at two locations (Parlier and Hanford) in the San Joaquin Valley. Much of the increased yield was attributed to prolongation of the flower-set period and delay of senescence. Ting and Dugger (1968) related ozone sensitivity in cotton to leaf age, finding that immature leaves were most susceptible to damage, and that older leaves were



insensitive to ozone. Taylor and Mersereau (1963) induced marked symptoms of early senescence and early leaf fall with controlled ozone treatments.

High temperature and high relative humidity are cited as major factors in reduced fruit retention in cotton. Meyer (1969) reported an increase in sterile anthers at temperatures above 38C with a time lag of about 15 days between exposure to heat and expression of sterility. Sarvella (1966) noted adverse effects of wind, high evaporation conditions, and high solar radiation on pollen viability. Stress occurring two to three weeks prior to anthesis induced the sterility. Fisher (1973) has negatively correlated minimum temperature with boll set in Arizona. Humidities in extremes of 21 and 90 percent reduced boll retention while 40-65 percent was favorable (Hoffman and Rawlens, 1970). Ehlig and LeMert (1973) conducted extensive field studies attempting to correlate ambient temperatures and humidities with fruit retention under various defruiting treatments. They noted little effect of high temperature on boll retention *per se*. Although they do not preclude the possibility that high temperature or high or low humidity affect boll retention, their field data indicate that boll load is the major contributor to fruit drop. They observed brief periods of unusually high (48-49C) temperature that affected fruit set, but they suggest that such conditions are not common. They also noted that brief periods of low solar radiation adversely affected boll retention. (See Chapter 20)

## ENVIRONMENTAL STRESS AND "CUT OUT"

Mason (1922) regarded the slowing of late season growth and the ultimate cessation of terminal activity (cut out) as due mainly to the diversion of carbohydrates to developing bolls. Heath (1932) observed that plant development to first flower was relatively constant; after first flower the growth rate declined. Crowther (1934a) related cessation of growth to a diversion of plant nitrogen (N) from the growing points to accompany carbohydrate transfer to developing bolls. He noted a drop in root N uptake to zero and ascribed reduced root development to reduced carbohydrate supply to the roots.

General observations by many researchers relate most environmental stresses with retardation of growth in cotton and to induction of senescence of leaves and inactivation of terminals. The presence of bolls, as indicated by defruiting studies, has an accelerating effect dependent upon the quantity present on the plant.

Excessively high or low temperature, reduced light, noxious air pollutants (ozone) or a restriction of water or nutrients will greatly hasten "cut out." Relief of boll load and amelioration of the stress usually stimulate a resurgence of growth. This sort of habit is perhaps retained from cotton's Mediterranean climate ancestors in which vegetative growth, flowering, fruiting, and seasonal quiescence were regulated by the wet season—dry season habitat. Breeders have managed to isolate genetic lines less affected by environment and thus indeterminate in growth and fruiting. Very determinate types also have been developed that respond by "cut out" to boll load and environmental stress. The ultimate effect of fruit retention is to suppress terminal bud activity.

## SUMMARY

The presently available literature supports the following: Extremes of the aerial environment including high or low temperature, low light, short days, long nights (especially at warm temperatures), air pollutants including ozone, SO<sub>2</sub>, NO<sub>x</sub>, or ethylene can alter initiation of flowering, reduce retention of fruit, and hasten the time to senescence of the cotton plant. The impact of environmental stress is accentuated if plants are well fruited.

Each of the above adversities also have been related to reduction or alteration of carbohydrate levels in the plant, with induction of ABA and/or ethylene by stress or injury which can be related to fruit drop. The recent definitive data of Guinn (1976a) provides the most persuasive argument that the nutritional and hormone theories can be blended into a single description of the sequence of events controlling fruiting and senescence.

Although ethylene increases and abscission may be induced with little alteration of carbohydrate status, there appears to be a continuation of events from stress → ABA → ethylene → abscission that includes a drop in carbohydrate. Whether alteration of carbohydrate is a salient circumstance brought on by stress closure of stomates or a driving force is not clearly elucidated by present data, although the large volume of data on low light effect on carbohydrate decreases and abscission increase is supportive.

The present information framework has certain deficiencies but when the entire structure is complete, I think that it will include both nutritional and hormonal control mechanisms.

## Chapter 5

# TEMPERATURE EFFECTS ON GROWTH, DEVELOPMENT, AND FIBER PROPERTIES

Jack R. Gipson  
Texas Tech University  
Lubbock, Texas

## INTRODUCTION

Cotton in its native state grows as a perennial shrub in a semi-desert habitat, and as such requires warm days and relatively warm nights. The cultivated species grown throughout the world today are classic examples of plant domestication, but even so, the requirement for high temperatures has probably not been altered appreciably in well over a hundred years of breeding and selection.

In the classic work of Balls (1919a), he stated that cotton in the field seemed to grow best around 32C in Egypt, while prolonged temperatures above 35C were harmful. During the following decade a number of other researchers working with cotton in the field made observations that drew attention to the possible role of temperature in cotton growth, development, and production (Martin, Ballard and Simpson, 1923; Ballard, 1925; Loomis, 1927; Buie, 1929; Hawkins and Serviss, 1930; Hubbard, 1931). Later as the commercial production of cotton gradually moved into areas where temperatures were not optimal, interest in the role of temperature in all phases of cotton production steadily increased. During the last quarter-century a substantial body of definitive information relating to the influence of temperature on cotton growth and development, fruiting, and quality parameters have been accumulated.

## GERMINATION AND EMERGENCE

In many areas of the Cotton Belt, cotton planted in early season is subjected to unstable weather conditions with extreme temperature fluctuations common, particularly in the northern regions of the Belt. As a consequence, many investigators have studied the influence of temperature on the germination and emergence of cotton. Ludwig (1932) found the minimum temperature for germination to be about 12C. Arndt (1945) grew cotton seedlings in darkness on agar at temperatures ranging from 18 to 39C and concluded that minimal temperatures for germination were below 18C, that the optimum was 33 to 36C, and that the

maximum was above 39C. Marani and Dag (1962b) noted a pronounced difference in the ability of different cotton varieties to germinate at low temperature. Generally *G. barbadense* varieties germinated better than *G. hirsutum* at 12C (Marani and Dag, 1962a).

With regard to seedling emergence in the field, rate of emergence is generally a function of temperature. Holekamp *et al.* (1960) reported a higher correlation between emergence percentage and the 10-day average minimum temperature at 20 cm (8 inches) in the soil, than between emergence percentage and planting date. A rule-of-thumb recommendation was derived from this research to describe the earliest practical planting date on the Texas High Plains. The "rule" specifies that soil temperature should average 15.5C for a 10 day period at the 20cm depth before planting is initiated. It has been used successfully for almost 25 years. Similar "rule-of-thumb" recommendations have resulted from studies in other areas. Riley *et al.* (1964) determined the relationships between minimum, maximum, and average seed level temperatures, and days from planting to first emergence for the Mid-South. They recommended soil temperatures should average 20C or higher during germination and emergence. McQuigg and Calvert (1966) studied time and average soil temperature effects at planting depth on cotton emergence in growth chambers. From their data they plotted a graph which provided an estimate of the amount of emergence to expect under various soil temperature-duration patterns (See also Chapters 34 and 36).

Low soil temperatures during cotton seed germination has both immediate and long-term effects. The immediate effects were described by Christiansen (1963, 1964) and consist of two types; A) radicle tip abortion induced by chilling at the onset of seed hydration and B) root cortex disintegration induced by chilling the seedling after elongation of the embryonic axis has commenced. These effects are manifest at temperatures below 10C (Christiansen, 1963, 1964, 1967), and there are apparently two periods of chilling hypersensitivity during germination. These are discussed by Christiansen and Rowland in Chapter 34.

The effect of chilling temperatures on germinating cotton can have far-reaching effects. In addition to the immediate effect on emergence rate and stand development, chilling may also alter growth and the fruiting pattern throughout the season (Christiansen and Thomas, 1969). It appears that, in the final analyses, total yield could be significantly affected. Wanjura *et al.* (1969) have determined that the first plants emerging have the highest survival rates, and the emergence time exerts a dominant influence on yield. For example, their data showed that relative yield averaged 100, 46, and 29 percent for plants with 5, 8, and 12-day emergence dates.

## VEGETATIVE GROWTH AND FRUITING

In some areas of the Cotton Belt, earliness is considered a desirable characteristic. It provides one mechanism by which the detrimental effects of low tempera-

ture on boll development in late season may be avoided. The degree of earliness of a given cultivar is associated with the length of the prefruiting period and the nodal position of the first sympodium (fruiting limb). Ray and Richmond (1966) found these two characters to be highly correlated, which implies that the nodal position of the first fruiting branch may be used as a criterion for selection in breeding for earliness. Both characters are influenced by temperature.

### FRUITING LIMB INITIATION AND FLOWERING

The first scientific investigations relating temperature to cotton growth, development, and fruiting were initiated early in the 20th century. One of the first was a study by Ewing (1918) on certain environmental factors influencing the fruiting of cotton. His data showed a 2-day lag period between the application of low temperature (below 18.3C) and a subsequent reduction in the opening of flowers. This suggested that temperature had a modifying effect on flowering. Martin *et al.* (1923) then noted a lengthening in the interval between appearance of squares as the season advanced. Four years later, Loomis (1927) reported the same observations. In each case the effect was probably due to lower temperature. At about the same time McNamara *et al.* (1927) reported that the number of days from planting to first square was reduced by delaying planting until warm weather. Several years later Waddle and his coworkers (Waddle, 1954; Waddle *et al.*, 1961) noted that a certain strain of *Gossypium hirsutum* race *latifolium* flowered and set fruit in the field at Shafter, California, but would not flower at College Station, Texas. Day lengths were slightly longer at Shafter, but temperatures were also cooler. Mean monthly minimums at Shafter were 8C lower for May and June and mean monthly maximums were 1 to 5C lower. Based on these differences at the two locations they correctly surmised that temperature was interacting with photoperiod to induce flowering at Shafter. Moraghan *et al.* (1968) studied 11 cotton strains under 7 different day-night temperature regimes. They found that the earliest squares were produced at the intermediate ranges of 27/22 and 30/25C. Squares were formed significantly later under extremely high (36/32C) and extremely low (18/13C) day-night temperature regimes. They also found variation among diverse cotton strains in the effects of both temperature and day length on the time of squaring.

Gipson (1974) studied the effect of temperature and methyl parathion on vegetative development and fruiting of two varieties of cotton. He maintained night temperatures at 10, 15, 20 and 25C with day temperatures ambient. Plants grown under 20 and 25C nights were not significantly different in days to first square or days to first bloom, indicating night temperature above 20C was not a limiting factor. As temperature was decreased below 20C, however, there was an appreciable increase in both time periods. Depending on the cultivar and treatment, the date of first square was increased by 2 to 5 days under 15C nights and by 11 to 15 days under 10C nights, as compared to the time required at 20 or 25C. Using 20 and 25C as the basis of comparison, the increase in days to first bloom

ranged from 12 to 17 days under 15C nights to 28 to 34 days under 10C nights.

### NODAL POSITION OF THE FIRST FRUITING LIMB

The first definitive studies conducted under controlled conditions on the role of temperature in determining the nodal position of the first floral bud was by Mauney and Phillips (1963). They studied the effects of both temperature and photoperiod on flowering, and on the nodal position of the first square in several *Gossypium* species, including a number of cultivars within the *G. hirsutum* and *G. barbadense* species. They noted an interaction between temperature and day-length in some species and cultivars, but not in others. With one exception, the *G. hirsutum* strains observed were classified under short-day flower control groups. Cool nights (15C) enhanced flowering in these types. Warm nights increased bud abscission in three strains, and no effect of either temperature or daylength on flower development was noted in the other seven *G. hirsutum* accessions. Mauney (1966) later studied floral initiation in a cultivar of *G. hirsutum* L., M-8, and found that in general, night temperatures above 28C resulted in a higher nodal position. The effect was greatly enhanced by high (28-32C) day temperatures. The converse was true with low night temperatures (20-22C). In conjunction with low night temperatures, high day temperatures resulted in a lower nodal position of the first sympodium. The enhancement of flowering by high day and low night temperatures was manifested not only in the lower nodal position of the first floral branch, but also in a shorter time from planting to floral initiation (See Chapter 2).

Low *et al.* (1969) obtained an increase of several nodes between the day-night temperature regimes of 24/19 and 33/28C. They found that *G. hirsutum* varieties responded to only one week of 24/19C, suggesting that earliness can be induced at a very early stage.

Studies by Gipson (1974) and Gipson and Ray (1974) lend credence to the idea that temperatures prevailing during the period between emergence and visual appearance of the first true leaf exert a modifying influence on the nodal position of the first fruiting limb. In the first study, conducted during the 1971 growing season (Gipson, 1974), night temperature treatments of 10, 15, 20 and 25C were initiated at emergence, with day temperatures ambient. The nodal positions of the first squares were essentially the same under 15 and 20C nights, but either a reduction of night temperature to 10C or an increase to 25C resulted in significantly higher nodal positions. In the second study, however, (Gipson and Ray, 1974) which was conducted during the 1972 and 1973 growing seasons with night temperatures of 13, 25 and 37C initiated at the first true leaf stage and day temperatures ambient, the night temperature treatments had no effect on the node of first square. Apparently nodal position of the first sympodium had already been determined between emergence and the appearance of the first true leaf.

Gipson (1974) also studied the influence of night temperature on number of

fruiting and vegetative limbs per plant, utilizing two cultivars, Gregg 35 and Deltapine 16. Of the two, Gregg 35 was the more determinate. Total number of limbs per plant was relatively constant across cultivars and temperature treatments (10, 15, 20 and 25C nights), but the ratio changed between fruiting and vegetative limbs. At 10 and 25C the number of vegetative limbs increased at the expense of fruiting limbs. Gregg 35 produced the maximum number of fruiting limbs at 15C and Deltapine 16 produced the maximum at 20C. There was also a positive relationship between the number of vegetative limbs and the total nodal position of the first fruiting forms. The treatments that raised the nodal position of the first forms increased the number of vegetative limbs.

## BOLL DEVELOPMENT

Both fiber and seed development proceeds simultaneously during the boll growth and maturation period, or between anthesis and boll (capsule) dehiscence. This time interval is referred to as the "boll period." It is initiated at anthesis and terminates with dehiscence which is manifest by desiccation and subsequent "cracking" of the boll at carpel sutures.

The fiber cells are differentiated from epidermal cells of the seedcoat, and their subsequent growth and development occurs in two distinct phases. The first is a period of cell elongation, and the second a period of secondary cell wall thickening (Balls, 1919b). The details of these two phases are given in Chapters 23 and 26.

## FIBER ELONGATION

Both temperature and variety influence the rate of fiber elongation. Hawkins and Serviss (1930) noted that temperatures which were suboptimum for plant growth also retarded fiber elongation. O'Kelley and Carr (1953) obtained a marked decrease in rate of fiber elongation as temperature was decreased from 21.8 to 14.7C. They concluded 14.7C was approaching the minimum temperature required for elongation. Hessler *et al.* (1959) found that fiber length decreased as the season progressed, indicating a temperature deficiency for elongation. In Uganda, Morris (1962) found the time required for fiber cells to attain maximum length varied only slightly from season to season, despite marked differences in rainfall and temperature. He did note, however, that the maximum length obtained was reduced under the cool temperatures. Stockton and Walhood (1960), in a study of boll temperatures, found that as boll temperature increased above 32C fiber length was reduced.

Gipson and Joham (1969a) studied the influence of four different night temperature regimes on two varieties of field grown cotton during two consecutive seasons. Elongation of fiber was found to be closely associated with both temperature and variety. As night temperatures were lowered from 26.6 to 12.8C the first season and from 27.2 to 10.0C the second season, fiber elongation rates decreased and fiber elongation periods increased for both varieties. Rate of elongation was

not uniform over the entire elongation period, but was dependent upon fiber age and night temperature. Maximum growth rates were obtained between 10 and 15 days after anthesis with night temperature levels of 21.1C or above. Temperature coefficients of elongation decreased with increased fiber age and night temperature, indicating the initial stages of fiber elongation (up to 15 days age) was extremely sensitive to temperature, whereas after 15 days age, fibers tended to become temperature independent. Gipson and Ray (1969a) then studied fiber elongation rates in five varieties of cotton as influenced by night temperature. Temperatures below 20C reduced fiber length; and generally the reduction was greater in varieties having the longer fibers. Lowering the night temperature also slowed the fiber growth rate and increased the fiber elongation period (Table 1). Temperature coefficients of elongation were in agreement with the previous study (Gipson and Joham, 1969a), indicating extreme temperature sensitivity up to 15 days age, at which time the coefficients of elongation quickly approached one, indicating temperature independence.

Table 1. Effect of night temperature on fiber elongation periods and on mean elongation rates.

Variety	Temperature, C							
	10	15	20	25	10	15	20	25
	<i>Days</i>				<i>mm/day</i>			
Acala 1517 BR-2	35	30	30	28	.71	.87	.93	1.00
Stoneville 7A	35	30	26	25	.66	.80	.96	1.00
Lankart 57	31	27	27	23	.77	.83	.85	.92
Stripper 31	30	26	26	22	.70	.81	.85	.88
C.A. 491	38	35	26	21	.53	.60	.81	.95

Source: Gipson, J.R. and L.L. Ray (1969a).

## SECONDARY WALL THICKENING

In the second phase of fiber development, i.e., secondary wall thickening, cellulose is deposited layer on layer, one inside the other, within the primary wall at the expense of the lumen. This layering was first shown to correspond to number of days of growth by Balls (1919b). Later Kerr (1937b) confirmed the findings of Balls and showed that each layer (fiber growth ring) was actually made up of two layers: one compact and the other porous; the first associated with warm periods of growth during daylight and the second with growth during cool night hours. With night temperatures below 20C the porous zones were distinct from the dense lamella; whereas, with night temperatures above 22C, the porous zones were not well differentiated. Anderson and Kerr (1938) later indicated that the distribution and thickness of growth rings could be manipulated by varying temperature and light. They also found that walls of cotton fiber maturing early in the season were generally thicker than late maturing fibers, but the late



maturing fibers possessed the greater number of growth rings. They attributed the differences to cooler temperatures in late season. Grant *et al.* (1966) later found the diurnal ring structure within the fiber was related entirely to fluctuations in temperature, and was not associated with alternating periods of light and darkness.

Gipson and Joham (1968b) studied the rate of cellulose synthesis as reflected by the increase in fiber weight per boll per day under four night temperature regimes. They found rate of cellulose synthesis was directly related to night temperature. As mean night temperature increased between the interval of 8.1 and 25.3C, gain per boll per day increased by 64 percent for the variety Acala 1517 BR-2, and by 46 percent for the variety Paymaster 101. In a study of five

Table 2. Effect of night temperature on the boll maturation period, the rate of cellulose production, and the micronaire value of five cultivars grown under four night temperature regimes (data reflects seasonal means).

Night temperature, °C	Acala 1517 BR-2	Stoneville 7A	Lankart 57	Stripper 31	C.A. 491
Number of days of boll period					
27	50.5	53.3	55.3	53.6	50.8
21	66.2	66.0	62.3	64.6	56.3
15	87.3	88.5	84.2	79.5	68.5
11	95.9	94.6	92.6	86.4	81.8
S.E. <sup>1</sup>	+1.16	+1.37	+1.59	+1.68	+1.70
Cellulose production, mg. per boll per day (excluding fiber elongation period)					
27	45.4	31.6	49.9	30.1	27.6
21	39.8	30.4	39.9	30.8	27.1
15	22.6	19.4	24.6	22.6	19.4
11	18.8	11.5	22.4	17.7	14.4
S.E. <sup>1</sup>	+1.81	+1.63	+2.25	+1.26	+0.94
Micronaire values					
27	4.08	4.28	4.44	5.33	3.88
21	4.08	3.89	3.71	5.70	3.46
15	3.13	2.94	3.65	4.57	3.57
11	2.51	2.44	3.08	3.36	2.85
S.E. <sup>1</sup>	+0.13	+0.13	+0.19	+0.20	+0.10

<sup>1</sup> Standard error of the mean calculated from a minimum of 5 samples per mean.

Source: Gipson, J.R. and L.L. Ray (1970).

cultivars grown under four night temperature regimes, Gipson and Ray (1970) also obtained pronounced differences in the rate of cellulose synthesis among cultivars and across temperatures. Data on cellulose production from their study is shown in Table 2.

### BOLL MATURATION PERIOD

Length of the boll period is a function of both the rate of fiber elongation and the rate of cellulose deposition on the secondary wall. Since both phases are temperature dependent, one might expect temperature to be the overriding factor in controlling length of the boll maturation period. In practice, this appears to be the case. A number of early cotton researchers noted that the maturation period of bolls lengthened with the advance of the growing season (Martin *et al.* 1923; Buie, 1929; Hawkins and Serviss, 1930).

Gipson and Joham (1968b) found the rate of boll development to be inversely related to both day and night temperature. Night temperature was the dominant factor. They concluded that high day temperatures could not compensate for low night temperatures in the boll development process. Gipson and Ray (1970) studied the effect of four night temperature regimes on five cultivars and obtained pronounced increases in boll periods with decreasing night temperatures. Their data exemplifies the influence of temperature on boll periods and is shown in Table 1.

More recently, Young *et al.* (1980) in a field study at El Paso, Texas involving five planting dates found that number of days from planting required to produce open bolls decreased as planting temperatures approached an optimum, then increased for the last planting date as maturity was forced into the cooler days of fall. They noted that numbers of day-degree units (daily maximum minus 12.8C) and heat units (average daily temperature minus 12.8C) were negatively correlated with length of the boll period. The number of day-degree units gave a better estimate of boll period by harvest week than the number of heat units.

### FIBER PROPERTIES

The effect of environment on the fiber properties and spinning performance of cotton was well documented in the mid 40's (USDA, Bureau of Plant Industry, 1947; see also Chapter 24) but the only research conducted on the topic was inspired by academic interest. By the mid 50's, the cotton trade recognized that more rigid standards must be set for official spot cotton market values. So, the New York and New Orleans Cotton Exchanges added a requirement that contract cotton would have micronaire readings incorporated, and that the base staple length would be increased to one inch in future contracts. Shortly thereafter, interest began to increase in the role of environment in cotton quality parameters. In the mid 60's micronaire readings were incorporated on the "green" (loan cards) and producers became aware of the importance of quality.

Over the years a number of physical and chemical properties have been found to be associated with the temperature prevailing during the fiber development period. Physical properties implicated include length, strength, and micronaire. Chemical properties affected are percent cellulose, degree of crystallinity, and degree of polymerization.

Hessler *et al.* (1957) studied a number of these properties utilizing cotton fiber grown under progressively lower seasonal temperatures on the Texas High Plains. From earlier to later blooms, or from blooms on August 8 to blooms on September 5, they found: micronaire decreased from 4.1 to 2.6; percent cellulose from 94.8 to 90.0; degree of polymerization from 7564 to 6090; crystallinity from 86.3 to 78.6; and strength (Pressley Index) from 74.7 to 68.7 (X 1000). This was a strong indictment on the role of temperature in fiber quality. Hessler *et al.* (1959) then studied fiber properties under increasing temperature deficiency as the season progressed. As the temperature deficiency increased in the colder late season, cellulose synthesis decreased, and sugars increased, indicating temperature dependence for cellulose synthesis. They obtained high correlations between cellulose and crystallinity and between crystallinity and strength.

Gipson and Joham (1968b) found night temperatures exerted a very significant influence on both physical and chemical properties of cotton fiber. Of the physical properties measured, micronaire was affected to the greatest extent by low night temperatures. Gipson and Ray (1970) obtained similar results. Their data on micronaire values for five cultivars grown under four different night temperature regimes are shown in Table 2. Within a given cotton cultivar, a trend toward finer fibers is characteristic of under-development and results from insufficient cellulose deposition on the secondary wall. Thus, low micronaire values obtained under low temperatures indicate a reduction in fiber development under these conditions. This is substantiated by the rate of cellulose synthesis for these same cultivars (Table 2).

In both studies (Gipson and Joham, 1968b; Gipson and Ray, 1970) fiber length was curvilinear within the temperature limits studied. In each case, maximum length was achieved with night temperature levels of about 19 or 20C (fitted curves). It was apparent, however, that the optimum varied with cultivar.

Strength (Pressley Index) was determined in both the previous studies, but the differences obtained due to temperature was minimal. This was probably due to the "bundle principle." The Pressley tester measures the breaking load of a bundle of fibers in arbitrary units divided by the weight in milligrams of a constant length of that bundle. Since there are more fine fibers than coarse fibers in a bundle of the same weight, the weakness of individual immature fibers cannot be detected by this method.

The data presented in this review implicates temperature as a primary component in the control of plant emergence, growth, development, fruiting, and boll development. It is obvious that low temperature is one of the greatest deterrents to optimum fiber development. Depending on the degree of development achieved,

the spinning utility of fibers produced under suboptimal temperature conditions may be impaired.

## SUMMARY

Cotton requires warm days and relatively warm nights for optimum growth and development. In many areas of the Cotton Belt, however, suboptimum temperatures may occur in both early and late season. As a consequence plant germination, emergence, growth, and development may be retarded in early season, and fiber development, maturity, and quality reduced in late season.

Minimum, optimum and maximum temperatures vary with the stage of plant development, the physiological process in question, and the cultivar concerned. The role of temperature has been defined and limits established for many phases of plant growth and fiber maturity, but a number of questions remain unresolved.

Some progress has been achieved in the development of cold tolerance, particularly in early season, but other areas are open for exploitation.

## ACKNOWLEDGEMENTS

Personal research cited by the author was conducted under the auspices of the Texas Agricultural Experiment Station and was funded in the initial stages by Plains Cotton Growers; Lubbock, Texas, and the Cotton Producers Institute (now Cotton Incorporated). Later funding was provided entirely by Cotton Incorporated.

The author extends thanks to these fine organizations and to the many individuals with whom he worked at the TAES, at Cotton Incorporated, and at Plains Cotton Growers.

## Chapter 6

# EFFECTS OF HIGH TEMPERATURE AND CONTROLLED FRUITING ON COTTON YIELD

Carl F. Ehlig  
USDA-ARS  
Brawley, California

## INTRODUCTION

The fruit load is the primary cause for mid-season decreases in fruit retention and flower production—commonly called cut-out. (Ehlig and LeMert, 1973; Tugwell and Waddle, 1964). Temperature affects the rate of fruit development by determining metabolic rates and, in turn, the interval between flower opening and boll opening. This chapter addresses two factors: (1) the limiting effects of high temperature on the fruiting capacity of cotton (*Gossypium hirsutum* L.) and (2) studies on lengthening the boll retention period by limiting cotton fruiting to maintain a constant rather than cyclic fruiting pattern.

## TEMPERATURE

With increases in average daily temperature, the plant metabolic rate increases and the time interval between flower opening and boll opening decreases. In the High Plains of Texas, Gipson and Joham (1968a) showed that low night temperatures or a combination of low night and low day temperatures increased the time for development and fruiting of cotton. Their primary concern was with the adverse effects of low temperatures on lengthening the fruit development period (See Chapter 5). In the Imperial Valley, the primary concern is with the adverse effects of high temperatures on shortening the boll development time and, thereby, limiting the fruiting capacity.

For the first fruiting cycle of cotton, the average time interval between flower opening and boll opening is about 60 to 65 days in the Texas High Plains, 50 to 55 days in Mississippi or California's San Joaquin Valley, and 40 to 45 days in California's Imperial Valley. During this period a boll must gain its entire dry weight and mature the seed and lint.

In Figure 1, a typical relationship between boll dry weight and time for three

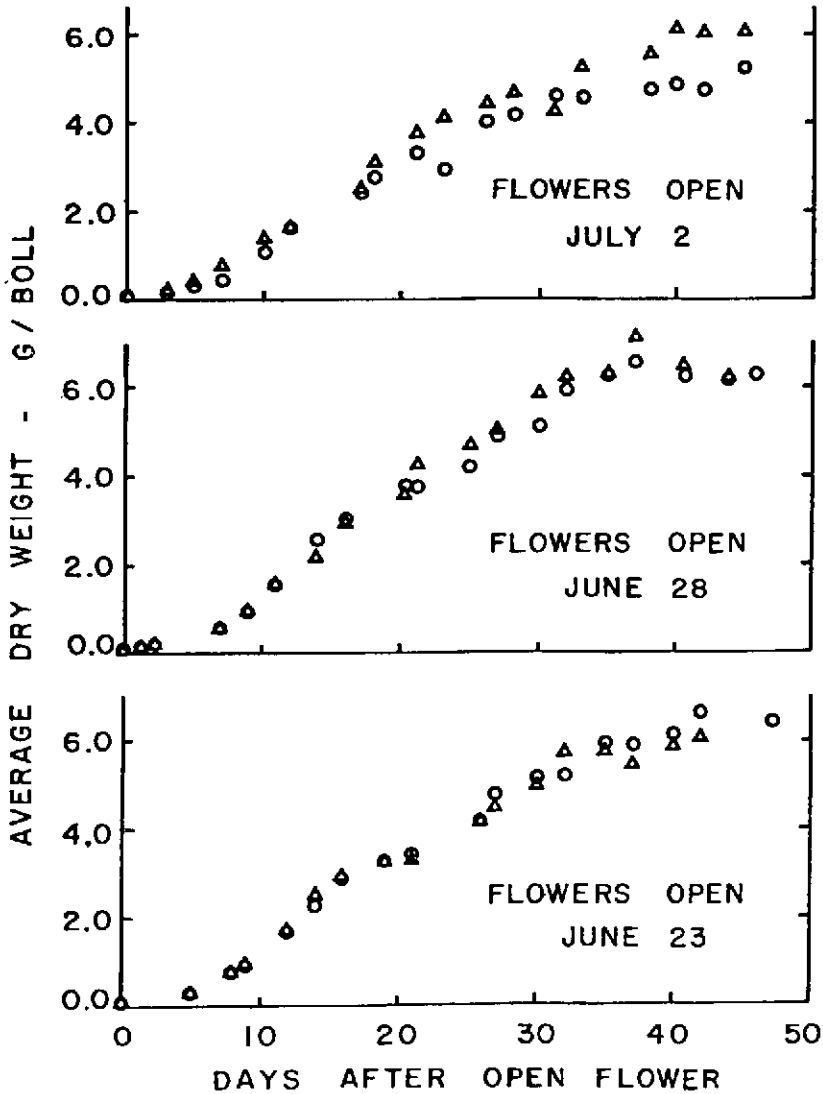

Figure 1. Average boll dry weight, in grams, as a function of days after flower opening for Deltapine 16 cultured on single (o) and double ( $\Delta$ ) row beds. (Proceedings 1972 Beltwide Cotton Production Research Conferences, pg. 42).

flowering dates is shown for Deltapine 16 at Brawley California. Boll dry weight gain was similar for double or single row beds with 1 meter between centers. The three dates bracketed the ranges in medium to high flowering rates and high to

low boll retention rates. For an individual cotton boll, the daily gain in dry weight was greatest and nearly constant between days 6 and 32. Baker and Hesketh (1969) showed a similar type relationship with Deltapine Smooth Leaf in Mississippi, except that the time period was longer. In our tests, about 80 percent of the final boll dry weight was seed cotton and 20 percent was carpel and receptacle tissue.

The shorter the time period between flower opening and boll opening, the more photosynthate is required per day per unit of boll or fruit production. Since potential solar irradiation is very similar across the Cotton Belt during the major period of boll production, the maximum potential fruit load is inversely related to the photosynthate required/boll/day or with the average daily temperature. Based on the photosynthate required/boll/day, the upper limit of cotton fruiting capacity during the first fruiting cycle seems to be about 2240 to 2520 kg/ha (4 to 4½ bales/acre) in the Texas High Plains, 1960 to 2240 kg/ha (3½ to 4 bales) in the San Joaquin Valley and Mississippi, and 1400 to 1680 kg/ha (2½ to 3 bales/acre) in southeastern California and southwestern Arizona (See Chapter 16). This assumes that plants completely cover the soil surface before the fruit load completely represses vegetative growth. The highest yields from the first fruiting cycle in the Imperial Valley have occurred when early spring temperatures were higher and late spring and early summer temperatures were lower than normal.

In past years, valleys in southeastern California and southwestern Arizona have recorded yields of 2240 to 2520 kg/ha (4 to 4½ bales/acre), but this was for total yield from two fruiting cycles, and it was before the current pink bollworm (*Pectinophora gossypiella*) invasion and subsequent secondary problems with cotton leaf perforator (*Bucculatrix thurberiella*) and tobacco budworm (*Heliothis virescens*).

Researchers have studied, and are currently studying, cultural practices to complete cotton production by early September and, thereby, minimize the numbers of overwintering diapausing larvae of the pink bollworm. Present emphasis is to alter the spacial planting configurations from standard practices to obtain early coverage of plants over the soil surface and obtain earlier crop maturity of the first fruiting cycle.

What is really needed to increase yields in the lower elevation valleys of southeastern California and southwestern Arizona is an additional 10 to 20 days in the time interval for development from flower opening to boll opening to fully utilize the long summer season. Such a cultivar would produce a potential yield of 2240 kg/ha (4 bales/acre), or more, from one fruiting cycle and still permit termination of pink bollworm-susceptible fruiting structures by early September. It would also delay cut-out until September, which would limit the number of fruiting structures produced during the critical diapausing period for pink bollworm and would discourage farmers from attempting to obtain a second fruiting cycle. This suggested cultivar would only be adapted to hot climates like the lower elevation valleys of California and Arizona. It should also possess the same

efficiency for converting photosynthate to seed cotton and lint as present cultivars.

I am not aware of a sufficient range in genetic variability for this character, nor have I heard of a chemical treatment that will decrease the boll development rate without adversely affecting photosynthate conversion efficiency. Plant breeders should seek a genetic factor or factors for this character.

### CONTROLLED FRUITING

During 1968 to 1970, studies were conducted to test a hypothesis that seed cotton and lint yield would be increased by limiting boll retention during the early period of high boll retention and thereby lengthen the period of boll retention. This would prevent mid-season cessation in fruiting and flowering, or at least delay it, with resultant higher early season yields.

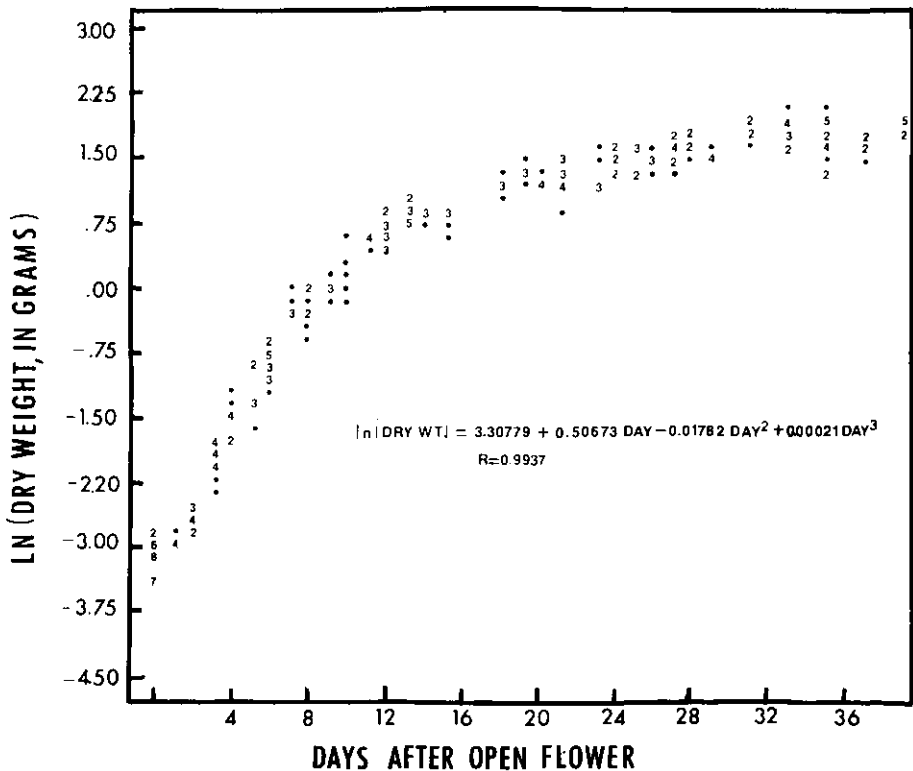

Figure 2. Ln (boll dry weight, in grams) as a function of time after flower opening during the first fruiting cycle for Deltapine 16 cultured at Brawley, California, in 1969, 1970, and 1971. (Numbers within the graph indicate the number of samples with the same average).



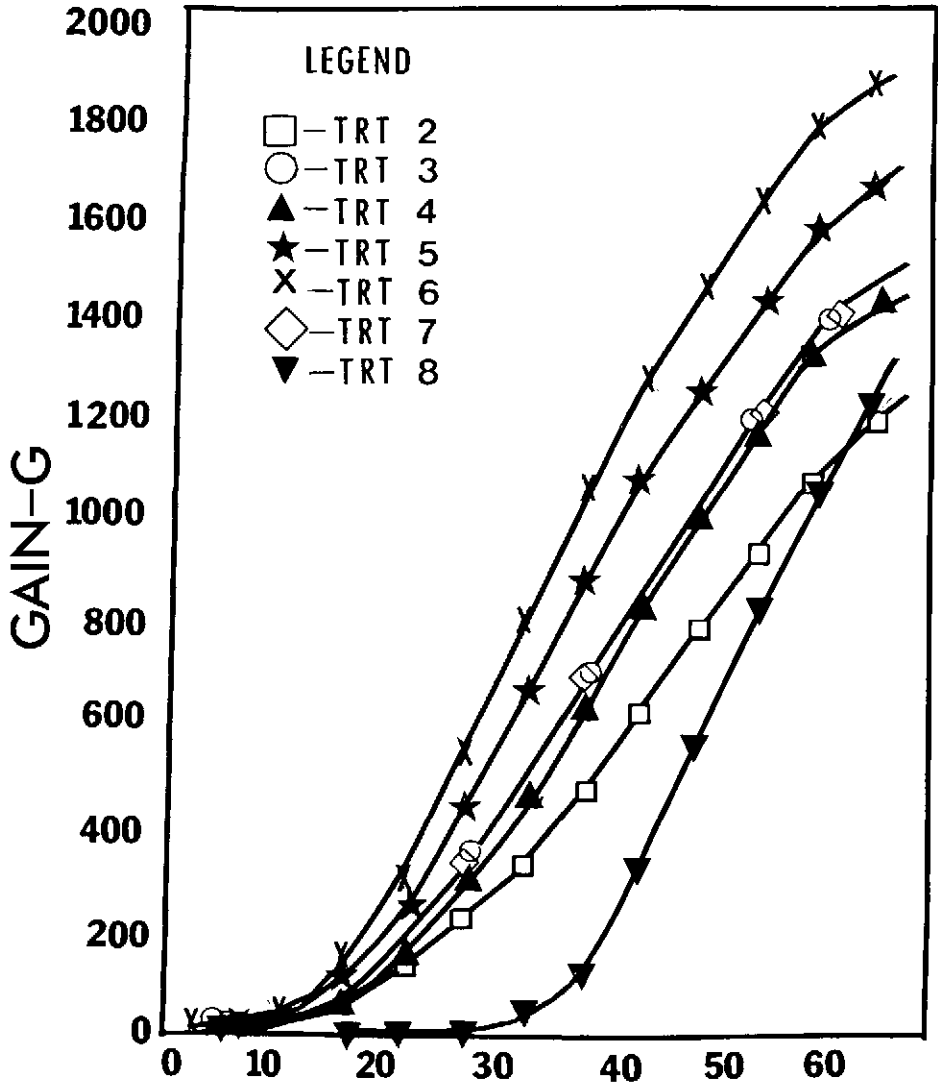

Figure 3. Average cumulative gain in boll dry weight in a 4-m length of Deltapine 16 under seven different fruiting treatments in 1969. Fruiting was graded from normal in treatment 6 to the most limited in treatment 2. Treatments 7 and 8 were alternate weekly flower removal and delayed date to first fruit retention, respectively.

Open flowers were counted daily and either tagged or removed (by hand) to obtain different levels of fruit loading. Retained bolls were counted after opening

and each boll's date for flower opening was recorded to obtain curves for daily boll retention and cumulative boll retention for each treatment. A logarithmic regression between net dry weight gain and time after flower opening was determined. (Figure 2). From this relationship, estimated daily net dry weight gain and cumulative dry weight gain were computed for each treatment. Sample data from the 1969 studies illustrated the general conclusions for the project. Deltapine 16 was planted in single-row beds on one meter centers. Fruiting was graded from most limited in Treatment 2 to normal on Treatment 6. Treatments 7 and 8 were variations of alternate weekly flower removal and time to first retention. First flowers occurred in early June.

For the first 60 days after initial flower opening, cumulative boll retention was highest with normal fruiting and decreased with increase in fruit limiting. Net dry weight gain in fruit was increasingly depressed by limiting fruiting. The highest net fruit gain per day was about 140 kg/ha (125 pounds/acre) on the normal fruiting treatment. Cumulative dry weight gain was greatest with the natural cyclic fruiting pattern of Treatment 6 (Figure 3). In general, each increase toward smoothing the fruiting pattern was at a cost in lint yield. In 1970 a constant flowering and fruiting pattern was achieved, but with a considerable reduction in yield.

In 1969, massive insecticide applications prevented continued tagging beyond 63 days after initial flowering, but the tests were long enough that the hypothesis could be evaluated. Plants with normal fruiting started their second flowering cycle by about day 70. Hence, the cumulative gain for altered fruiting cycles should have exceeded that for normal fruiting by day 70. This could not have occurred. Had the tests favored limited fruiting, a genetic or chemical means would have been sought to control fruit retention.

## SUMMARY

High temperatures limit the fruiting capacity of cotton in hot climates like southeastern California and southwestern Arizona. The high temperatures increase the plant metabolic rate, increase the photosynthate requirement per day per unit of ultimate yield, and decrease the time interval between flower opening and boll opening. Higher seedcotton yields per fruiting cycle appear obtainable from cultivars with 10 to 20 additional days between flower and boll opening.

Studies were conducted to determine if seedcotton yields could be increased by limiting daily fruit retention so that plants did not cease vegetative growth and fruiting during mid-season, as occurs naturally. Altered fruiting patterns prevented mid-season cessation of vegetative growth and fruiting but also produced lower seed cotton yields than the natural fruiting cycle.

## Chapter 7

# WATER DEFICITS AND REPRODUCTION

Wayne R. Jordan  
Texas A&M University  
College Station, Texas

## INTRODUCTION

Soil water availability is one of the primary edaphic factors which act to influence, and perhaps even control, production of potential fruiting points, retention of squares and bolls and yield of cotton. The role of soil water availability is both direct, in the sense that it may influence the internal plant water balance, and indirect, in that it may alter mineral nutrient availability, soil-borne pathogen and insect activities, and soil temperature. In this Chapter only the direct effects of soil water availability on plant water deficit, and the attendant effects on production, retention, and growth of fruiting forms are considered, but it must be pointed out that seldom are the indirect interactions observed or quantified. More comprehensive discussions of water relations and water management are found in recent reviews by Hearn (1979) and Jordan (1983).

## CONTROL OF FRUITING PROCESSES

The production of fruiting forms is discussed in detail by Mauney in Chapter 2 and will not be repeated herein except to emphasize certain important points. The first point is that production of potential fruiting forms is dependent upon vegetative growth. Actual numbers of potential fruiting forms depend upon the rate of production of successive nodes and upon the ratio and location of vegetative and fruiting branches. Reductions in vegetative growth rates associated with low soil water availability are often reported; therefore, production of total fruiting forms must also be reduced.

A second point relates to the balance between vegetative and reproductive growth. Numerous reports relating square and boll shed to periods of drought or irrigation cycles suggest that the retention of immature reproductive structures is extremely dynamic and responsive to brief perturbations in water supply. These environmental disturbances are manifest in the growing plant as either alterations of the current nutritonal status of the plant and/or as disruptions in the hormonal balance such that the flow of hormones necessary for normal maintenance of the abscission zone is interrupted. Neither explanation alone fully

accounts for the accelerated loss of young squares and bolls in crops subjected to prolonged or periodic water deficit. It is likely that the history of soil water availability throughout the growth of the crop may influence the operative mechanism in square and boll shed.

The discussion above regarding the role of available soil water in control of vegetative growth provides a convenient introduction to the topic of control of fruiting and yield in the contrasting situations of dryland versus irrigated production. Plant water deficits arising from the inability of the crop to extract soil water in sufficient quantities to match transpiration are commonly reported to occur in both production systems. However, significant differences in the timing, duration, magnitude and rates of development of plant water deficits do occur between the two systems and bear heavily on yield-related processes. Much of the following discussion is speculative, since little documented evidence exists upon which to base a critical evaluation of the role of water deficits directly on the fruiting process.

## SOIL WATER AVAILABILITY AND VEGETATIVE GROWTH.

Dryland production areas are characterized by extreme variations in the total water supply available to the growing crop. Since large variations occur both within and among seasons, seldom do repeatable patterns of soil water deficit occur. In these situations, many years of field data are required to establish even crude relationships between soil water supply and yield. The effect of increasing amounts of available soil water at planting time on yield are amply illustrated in the reports of Fisher and Burnett (1953) and Bilbro (1974) for the Rolling and High Plains of Texas, respectively, but these reports shed little light on the reasons for reduced yield, i.e. reduced potential fruiting points, loss of fruiting forms or reduced boll sizes. Since low yields under dryland conditions often reflect a small total above ground biomass, an examination of the relation of vegetative growth to soil and plant water status may provide a means to evaluate the primary causes of low yields. Several reports bear on this topic.

In an early report by Hancock (1941), evidence was presented that yield was closely associated with the rate of increase in plant height during the period of maximum growth rate. Later reports by Bruce and Shipp (1962), Bruce and Romkens (1965), and Rijks (1965) substantiated this height-yield association and provided additional information which illustrated that production of total fruiting points and fruits was quantitatively related to plant height (Figure 1). A single curve (Figure 1a) adequately described the square production per plant for two levels of soil water management (mean matric potentials of -0.3 bars and -0.6 bars in the 15-45 cm soil zone for treatments A and B, respectively), illustrating that the production of total fruiting points (squares) exhibited the same or greater sensitivity to soil water deficit as vegetative growth. The total fruit load also

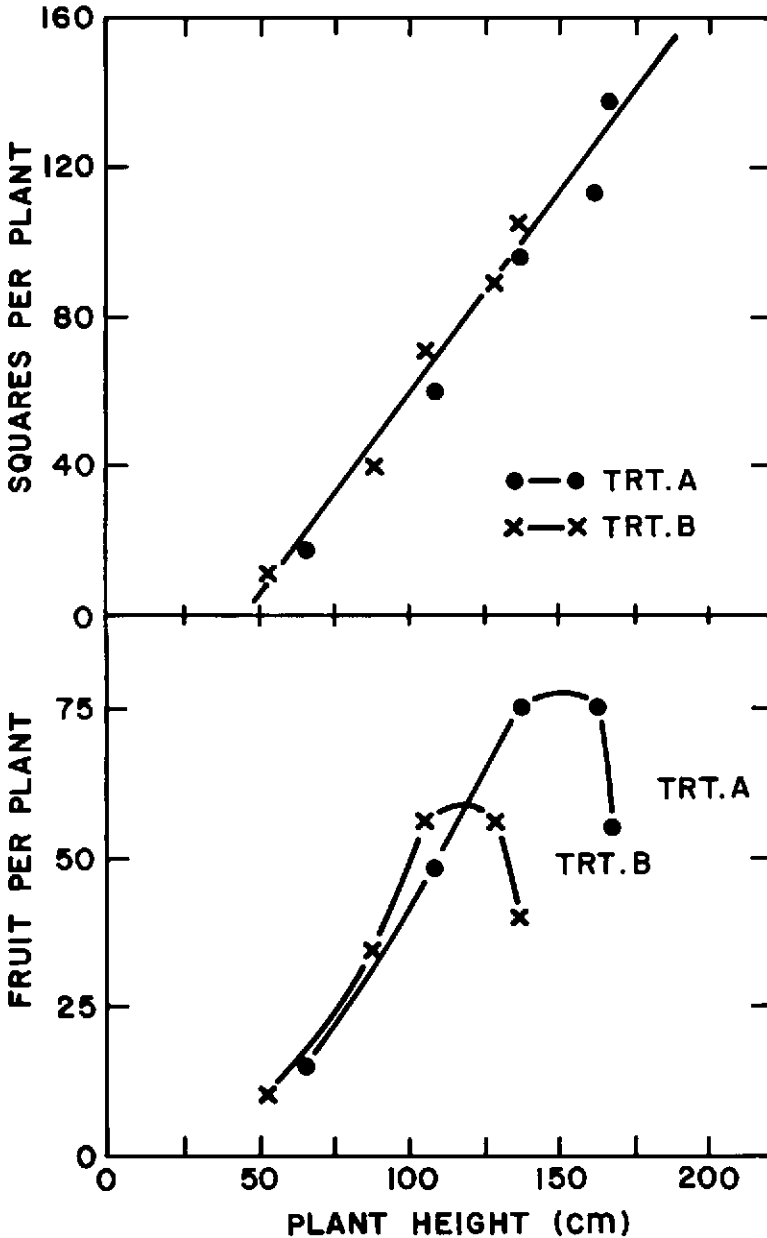

Figure 1. The relation between plant height and (upper) square production, and (lower) fruiting as influenced by two levels of soil moisture. Moisture levels A and B, corresponding to soil matric potentials of -0.03 to -0.06 MPa in the 15-45 cm soil zone, were maintained throughout the study. (Data from Bruce and Romkens, 1965).

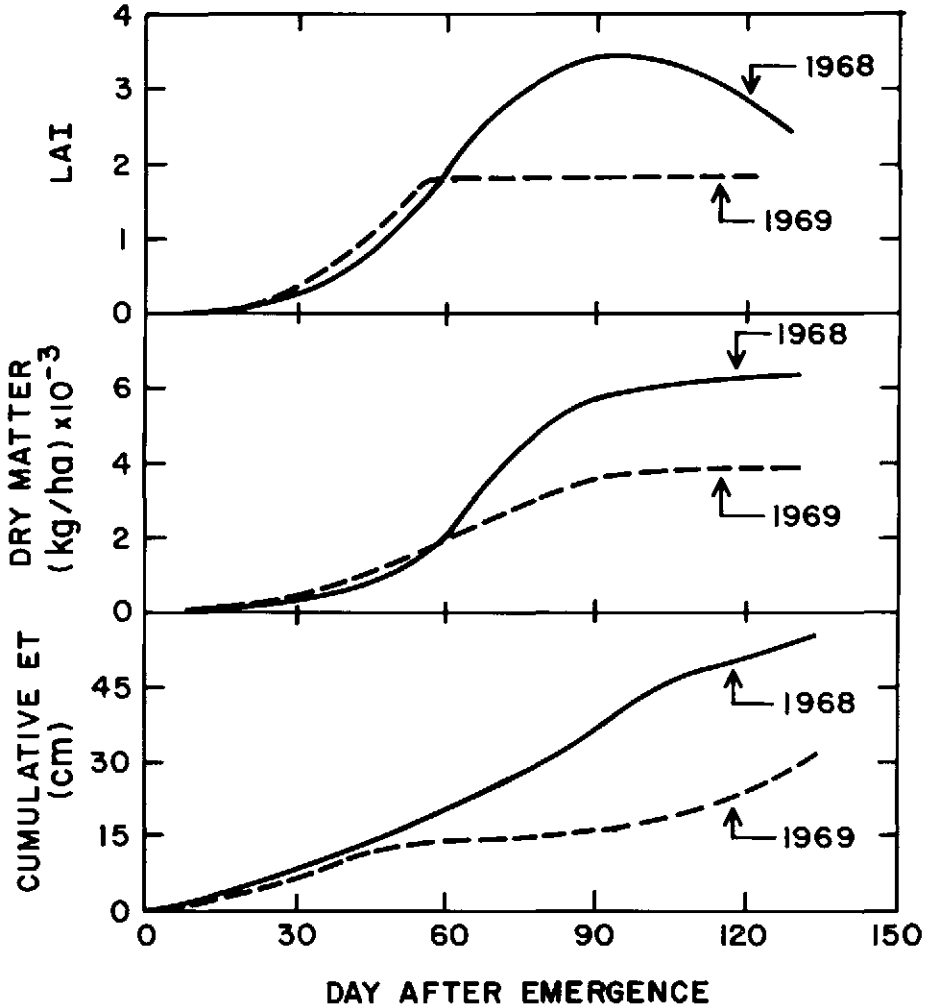

Figure 2. Changes in (top) leaf area index (LAI), (middle) total above ground dry matter, and (bottom) cumulative evapotranspiration (ET) with time after planting for cotton crops produced under rain-fed conditions at Temple, TX in 1968 and 1969. (Redrawn from Ritchie and Burnett, 1971).

exhibited a nearlinear relation to plant height during early fruiting (Figure 1b), but a peak in fruit load was reached about four weeks after first bloom regardless of soil water level. The total fruit load was reduced by the lower soil water treatment (TRT B).

Vegetative growth, water use and dry matter accumulation for upland cotton

(Lankart 57) grown under rain-fed conditions at Temple, Texas are shown in Figure 2 (Ritchie and Burnett, 1971). These results may be considered typical for many regions which depend upon stored soil water plus substantial summer rainfall to achieve satisfactory yields. Total crop growth was greatly reduced in 1969 relative to 1968 because of a prolonged period without rain in June and July. By 60 days after emergence (DAE), increases in leaf area for the 1969 crop had stopped and further increases in dry matter were probably associated with boll growth (i.e., 'cutout'). The harvest index (lint wt./total above ground dry wt.) for 1968 and 1969 was 0.078 and 0.073, respectively. Under conditions where plant water deficits developed gradually, the partitioning of dry matter between above-ground vegetative matter and lint remained relatively stable. Similar results were also reported by Eaton (1955). Bolls which developed from early flowers comprised 100 percent of the yield in 1969; late season rainfall was ineffective because of the cessation of active vegetative growth and late season insect pressures.

The importance of early boll retention to yield under water-limited conditions is illustrated clearly by the data of Rijks (1965) for plants grown on stored soil water (Table 1). Plants grown with low water supply (140 mm) produced fewer nodes, fewer fruiting branches and fewer fruiting forms, but retained a high

Table 1. Growth and boll load characteristics of cotton plants grown with increasing amounts of available soil water. Based on data from Rijks (1965). Data are expressed on a per plant basis except for lint yield.

Character	Available soil water (mm)			
	140	340	460	670
Total nodes	21	28	38	39
Total fruiting branches	6	10	19	24
Bolls				
Total	6	18	35	50
At 1st fruiting position	5	9	13	21
Squares shed	2	7	42	58
Boll retention (%)	75	72	45	46
Boll position ratio (%) <sup>1</sup>	83	50	37	42
Lint yield (kg ha <sup>-1</sup> )	160	439	732	1030

<sup>1</sup>The ratio of bolls at the first fruiting position on fruiting branches to total bolls.

percentage of squares (75 percent). Since growth of fruiting branches was also restricted by water deficit, a high percentage of bolls were located at the first fruiting position, illustrating the importance of high fruit set from early flowers for water-limited situations. Failure to control insect pests early in the season results in additional yield reductions and lower water use efficiency in terms of lint per unit water used. Reported water use efficiencies for rainfed crops range between 0 and 0.45 kg lint per m<sup>3</sup> water, but most values fall in the range of 0.1 to 0.3 kg/m<sup>3</sup> (Hearn, 1979).

Several additional insights were gained through an intensive study of the water balance of the 1969 crop. Data presented in Figure 2 provided evidence that, even though vegetative growth (leaf area) had ceased by 60 days after emergence (DAE), transpiration and total dry matter continued to increase for several weeks. This finding suggests a differential sensitivity existed between the plant water deficit required to inhibit growth and that required to cause stomatal closure (Hsiao, 1973; Jordan, 1970; Wadleigh and Gauch, 1948). A similar conclusion was reached by Hearn (1979). A detailed diurnal study conducted on July 17-18 (82 DAE) revealed that stomates of upper leaves remained open throughout the day even though leaf water potentials were reduced to -27 bars (Jordan and Ritchie, 1971). Since, for greenhouse and chamber grown plants, the threshold leaf water potential for stomatal closure commonly occurs about -15 bars (personal observations and Jordan and Ritchie, 1971), we concluded that the long period of exposure to plant water deficit allowed the field plants to become acclimated to successively lower potentials. This finding was subsequently confirmed and extended (Brown *et al.*, 1976; Cutter and Rains, 1977; Thomas *et al.*, 1976) and is now generally accepted as one manifestation of osmoregulation that occurs in many crop species in response to drought (Begg and Turner, 1976). Recent work by Radin and coworkers (1981, 1982) suggests N-nutrition may also play an important role in regulating plant response to water deficit (See Chapter 10).

## WATER DEFICIT-INDUCED ABSCISSION

Characteristics of plant water deficit patterns which develop in irrigated cotton are usually quite different from those experienced by a rain-fed crop. Plant water deficits associated with irrigation cycles are usually developed rapidly, relatively short in duration, and frequently severe enough to result in wilting for several days. Numerous studies during the past 50 years have addressed the question of optimum timing for application of supplemental water. No attempt will be made to summarize these reports; however, several common results are pertinent to this topic and will be discussed below. The stated or implied objective of most of these studies was to optimize the efficient use of applied water in terms of yield of marketable lint and seed.

As a point of departure into this topic, it is desirable to restate an earlier observation, i.e. within limits, the production of potential fruiting points must be closely allied with vegetative growth. Because of high soil water availability, the rate and maximum extent of canopy development in the irrigated crop is usually much greater than for rain-fed areas. Maximum leaf area indices (LAI) for rain-fed cotton are often near 3 and may range from 1 to 4, while for a fully irrigated crop values over 5 are common (Ashley *et al.*, 1965; Ritchie and Burnett, 1971). Rapid canopy development is also associated with higher rates of soil water use since the crop will use water at rates equal to the potential evapotranspiration



after an effective full canopy ( $LAI = 3$ ) is reached and so long as water remains fully available to the roots (Ritchie and Burnett, 1971). Since the water holding capacity of many soils in areas under full-season irrigation is quite low, and extraction rates are high, plant water deficits may develop over a period of only a few days in contrast to several weeks in rain-fed areas. Wilting is commonly observed near the end of irrigation cycles and, in fact, is used to time water applications in some areas.

The detailed studies of Grimes *et al.* (1969, 1970) and Stockton *et al.* (1961) serve to illustrate the influence of irrigation frequency on plant growth, flowering and boll retention in situations considered typical for irrigated cotton production. Grimes *et al.* (1970) reported that a severe plant water deficit imposed during the peak flowering period reduced yield more than a comparable deficit occurring either earlier or later in the flowering period. Water deficits early in the flowering period increased shedding of squares before they flowered, while late stress reduced flowering rate and boll retention.

These results were similar to a more extensive earlier study by Stockton *et al.* (1961) covering a period of four years. Intermediate irrigation frequencies resulted in production of fewer flowers, but the numbers of bolls retained was equal to treatments receiving twice as many irrigations. Only on infrequently irrigated plots was vegetative growth reduced. The concomitant reduction in flower production resulted in fewer bolls per plant even though a higher percentage of bolls were retained (see also Table 1 and Hancock, 1941). The pattern of boll set in relation to irrigation frequency was variable. No discernable pattern was found for the most frequently irrigated treatment; however, a definite tendency for increased boll retention was associated with the day of irrigation in the two less frequently watered treatments. For the most infrequently watered treatment nearly three times as many bolls were set on the day of irrigation as on the day midway between water applications.

The cyclic nature of boll set for infrequently irrigated plots is suggestive of a shedding mechanism controlled not only by plant water deficit, but also by the number of bolls set per day. In this study (Stockton *et al.*, 1961) both stimuli were evident. Midway between irrigations plant water deficits predominated as the causative agent in boll abscission. Immediately following water additions there were periods of high boll set followed by a period of high boll shed before water deficit recurred.

The study discussed above provides a possible basis upon which to evaluate the nutritional and hormonal hypotheses of fruit shed outlined in the review by Eaton (1955) and more recently summarized by Guinn (1982b and Chapter 12). In the absence of other external limitations, the balance of growth between vegetative and reproductive structures is closely regulated by the carbohydrate and nitrogen status of the plant. The balance is achieved by overproduction of fruiting forms which are then shed in numbers necessary to match the carrying capacity of the plant at a specific time. The dynamic nature of this form of control is illustrated

by the rapid increase in fruit shed associated with cloudy weather or artificial shading (Eaton, 1955; Guinn, 1974a, 1976a). Stockton *et al.* (1961) speculate that the resumption of shedding after irrigation cannot be explained on the basis of nutrition since even a high retention of young bolls (1-3 days old) would not constitute a substantial sink for photosynthate. However, the resumption of active leaf expansion following irrigation may constitute an additional sink of major importance. Also, the interpretation by Stockton *et al.* (1961) regarding demand by bolls set on the day of irrigation may be questioned. While it is true that sink strength of 1-3 day old bolls is not great, these bolls would have been several days older midway between irrigations and may have constituted an appreciable demand for photosynthate. The total demand for carbohydrate and nitrogen to support renewed vegetative growth as well as additional numbers of young bolls may be sufficient to trigger shedding, especially if photosynthetic rates do not recover as quickly as turgor. Fry (1972) reported that Hill reaction activity of chloroplasts isolated from stressed leaves showed a steady decline of about 1.8 percent per bar as leaf water potential decreased from -0.9 to -3.0 MPa. Ackerson *et al.* (1977) observed that rates of net photosynthesis declined dramatically during drought even though stomatal conductance decreased only slightly. Reduced chloroplast activity and net photosynthetic rates may both be related to the loss of chloroplast integrity and increased hydrolytic activity associated with dehydration, as discussed by Vieira da Silva (1976). The rate of recovery of chloroplast integrity or net photosynthetic rates is not known for cotton, but results from other crops suggest turgor and transpiration recover more quickly.

The possibility that plant water deficits may directly act to induce shedding must also be considered. Assuming the sequence of events is the same in fruit abscission as in leaf abscission, plant water deficits may act to trigger several changes in the balance and rate of supply of phytohormones to the abscission zone. Briefly stated, the hormonal theory of abscission deals with the rate of supply of juvenile (principally auxin) and aging or senescence hormones from the leaf blade or fruit to the abscission zone (Beyer and Morgan, 1971; Carns, 1966; Eaton, 1955; Guinn, 1982b). The separation layer in this zone is maintained in a normal 'healthy' state so long as the juvenile hormone activity predominates, but should the balance shift in favor of the aging or senescence hormones, then irreversible changes are triggered in these cells which result in eventual separation.

Changes in concentrations of several phytohormones are associated with development of plant water deficits of a magnitude known to induce leaf and boll abscission (Guinn, 1976b; McMichael *et al.*, 1972b). Ethylene production increases (Guinn 1976b; Jordan *et al.*, 1972; McMichael *et al.*, 1972a) as does the concentration of abscisic acid (ABA) (Davenport *et al.*, 1977a; Jordan *et al.*, 1975). Ethylene appears to play multiple roles in abscission including reduction in auxin transport to the abscission zone (Beyer and Morgan, 1971), induction of hydrolytic enzyme synthesis and secretion of these enzymes into walls of cells in

the separation layer (Abeles, 1969; Abeles *et al.*, 1971). It is unclear at this time if all actions are manifest by plant water deficit-induced ethylene production. Recent evidence suggests a strong association between plant water deficit and reduced auxin transport (Davenport *et al.*, 1977b), but whether this effect is independent of ethylene action is not known. Transport of other growth regulators (ABA, kinetin, gibberellic acid) does not appear to be affected by plant water deficit (Davenport *et al.*, 1977a; 1979) in young seedlings.

## SUMMARY

In summary, the roles of plant water deficit in regulation of production and retention of reproductive structures of cotton appear to be manifest in two general ways. Plant water deficits induced by low available soil water and/or high evaporative demand reduce the total number of potential fruiting points as a result of a general reduction in shoot growth. Provided these deficits are developed gradually over a long period of time, a stable balance between vegetative and reproductive growth is maintained. Deficits imposed early in the growth of the crop and maintained throughout much of the fruiting period may result in early cutout, if the plant water deficit falls below that needed to support positive cellular turgor necessary for growth. Photosynthesis may continue for a time even though growth is inhibited because the stomatal apparatus may acclimate through osmoregulation. Thus, dry matter accumulation and boll growth may continue even though vegetative growth has stopped. Stress-induced cutout may therefore be a qualitatively different process from normal cutout resulting from high nutritional demand by developing fruit (Eaton, 1955; See also Chapter 2).

Plant water deficits that occur rapidly near the end of irrigation cycles appear to exert effects on fruiting and flowering apart from a general reduction in growth. Rapid development of deficits may limit the capacity of the plant to acclimate and results in an alteration of the normal hormone balance of the abscission zone. In this regard, deficit-induced stimulation of ethylene production and reduced auxin transport appear to be most important, but rates of production of auxin and abscisic acid may also be altered. Once induced, abscission requires active growth of cells near the separation layer which may explain differences in abscission patterns between field and pot studies. Cellular growth requires turgor which is normally reestablished each night in field-grown but not in pot-grown plants (Jordan and Ritchie, 1971; McMichael *et al.* 1972a,b). If abscission-inducing levels of water deficit are encountered during the day, nighttime rehydration allows necessary growth, and abscission occurs during the drying cycle. Since overnight recovery does not normally occur in severely stressed plants grown in pots with limited soil volumes, abscission is often not observed until the pots are rewatered. Shedding then occurs rapidly during the next few days.

While an explanation of abscission in response to rapid water stress may be based on changes in the normal hormone balance, a nutritional explanation may

also be offered. A cessation of vegetative growth would likely accompany any water stress sufficient to induce shedding. While cell expansion may be inhibited, cell division may continue, thereby creating a sink for growth substrates when rehydration occurs. This vegetative sink may be sufficient to reduce substrates available for boll growth and shedding of young fruit may result. Even though possible, a few problems may exist with this explanation. Cell division and cell expansion may have different thresholds and sensitivities to plant water deficit, but since severe deficits may occur rapidly for irrigated plants, it is questionable whether a great deal of cell division would occur after expansion is inhibited. Also, since photosynthesis may continue at deficits where expansion is reduced, a higher supply of carbohydrate would be available in leaves to support resumed growth, thereby minimizing the effect on young fruit. These conflicts remain to be resolved.

## Chapter 8

# SOURCE-SINK RELATIONS AS AFFECTED BY WATER STRESS DURING BOLL DEVELOPMENT

Daniel R. Krieg and J.F.M. Sung  
Texas Tech University  
Lubbock, Texas

## INTRODUCTION

Cotton (*Gossypium hirsutum* L.) like most agronomic seed plants produces photosynthate in green leaves (sources) and then exports some of the assimilate photosynthate to other tissues (sinks) that are not capable of self support. In addition, cotton, having an indeterminate growth habit, has both vegetative and reproductive growth occurring simultaneously during a large portion of its life cycle. Numerous studies have described leaf development and associated photosynthetic activity of the cotton plant, transport of the assimilate to various sinks, and utilization of the assimilate by that sink. In general, during leaf development, photosynthetic activity increases to a maximum rate about 20 days after unfolding, maintains a high rate for a relatively brief period of time (10 to 20 days) and then declines as the leaf ages until senescence occurs (Muramoto *et al.*, 1967). Of the daily assimilate, the leaf retains a relatively high percentage for its own use, (Brown, 1968; Ashley, 1972). The exported assimilate is distributed to various sinks depending upon leaf type, position on plant and growth stage (Ashley, 1972; Brown, 1968, 1973).

After flowering, the developing boll receives assimilate from its associated bracts, the subtending leaf and the vegetative leaf subtending the sympodium (Ashley, 1972; Benedict *et al.*, 1973; Benedict and Kohel, 1975; Brown, 1968, 1973). As the plant develops, closure of the canopy increases the shading associated with bolls on the lower sympodia. Photosynthetic activity is greatly reduced in the leaves primarily associated with the developing bolls in the lower canopy. The bolls then receive assimilate from upper canopy leaves on the same side of the plant (Brown, 1973).

## RESPONSE TO WATER STRESS

It is widely recognized that plant productivity is adversely affected by water stress. Although cotton is not considered to be a highly drought resistant plant, it is often grown in environments where water stress commonly occurs. The plant response to water stress is very dependent upon timing, rate of development, intensity, and duration. Our program has been largely concerned with developing an understanding of the effects of water stress on the production and utilization of assimilate during the boll development period. We specially want to know whether the stress is directly affecting the source or the sink. Experiments have been conducted under both field and glasshouse conditions.

### SOURCE RESPONSE

Source activity is a function of effective leaf area times the photosynthetic rate per unit leaf area. Relatively moderate water stress reduces whole plant leaf area of cotton largely through reductions in leaf numbers rather than through reductions in leaf size (Table 1). Main stem leaf numbers were reduced only 10 percent (22 nodes versus 20 nodes); however, sympodial leaf numbers were greatly reduced. The reduction in leaf number was due to reduced initiation rather than loss of existing leaves through senescence. Photosynthetic rate per unit leaf area began to be significantly affected when the leaf water potential declined from a mid-day value of -20 bars (Figure 1). The reductions in photosynthetic rate, when coupled with the reductions in leaf area, resulted in significant reductions in whole plant assimilation rates. Leaf age effects on photosynthetic rates were evident at equivalent irradiance and temperature conditions similar to the results of Muramoto *et al.* (1967).

Individual source leaves retain a significant proportion of their daily assimilate for their own use (Chapter 22). Twenty two hours after exposing individual leaves to  $^{14}\text{CO}_2$ , as much as 40 percent of the initially incorporated  $^{14}\text{C}$  remained in the leaf (Table 1). Significant differences were observed due to stress with only minor differences due to leaf position within the canopy when retention is expressed as a percentage of daily assimilation. However, on the basis of leaf dry weight, significant differences were observed between young tissue and older tissue, reflecting differences in growth and maintenance functions. Additionally, water stressed leaves consistently retained a higher amount of the daily assimilate per unit dry weight, suggesting maintenance costs may be increased.

The rate of disappearance of the  $^{14}\text{C}$  from the treated leaf was used to estimate translocation of assimilate from the leaf (Figure 1). In  $\text{C}_3$  plants  $^{14}\text{C}$  loss with time after exposure reflects not only translocation but also photorespiration losses. Our efforts do not indicate that water stress affects photorespiration directly, and thus the differences in  $^{14}\text{C}$  loss from treated leaves reflects an effect of water stress on

the translocation rate. Expressing the loss of  $^{14}\text{C}$  as a function of that initially assimilated resulted in an effect due to water stress as the leaf water potential declined from -22 or -23 bars (Figure 1). As previously stated, the photosynthetic rate was affected by stress resulting in leaf water potentials of -20 bars. The

Table 1. Source-sink activity of cotton as affected by water stress during boll filling.

Plant parameter	Growth condition	
	Nonstressed	Stressed
I. Leaf area		
Whole plant	22 dm <sup>2</sup>	10 dm <sup>2</sup>
Single blade	.48 dm <sup>2</sup>	.37 dm <sup>2</sup>
II. Leaf number		
whole plant	47	27
III. Avg. daily net photosynthetic rate (mg CO <sub>2</sub> .dm <sup>2</sup> .hr <sup>-1</sup> ) (single leaf basis)	25	20
IV. Daily assimilate retained by leaf (%)	30	40
V. Bolls per plant	7	5
VI. Bolls/dm <sup>2</sup> leaf area	.36	.50
VII. Boll dry weight (g lint/boll)	1.53	1.47
Nonstressed = irrigated plots	avg. $\Psi_L$ = -15 bars.	
Stressed = dryland plots	avg. $\Psi_L$ = -20 to -22 bars during boll filling period	

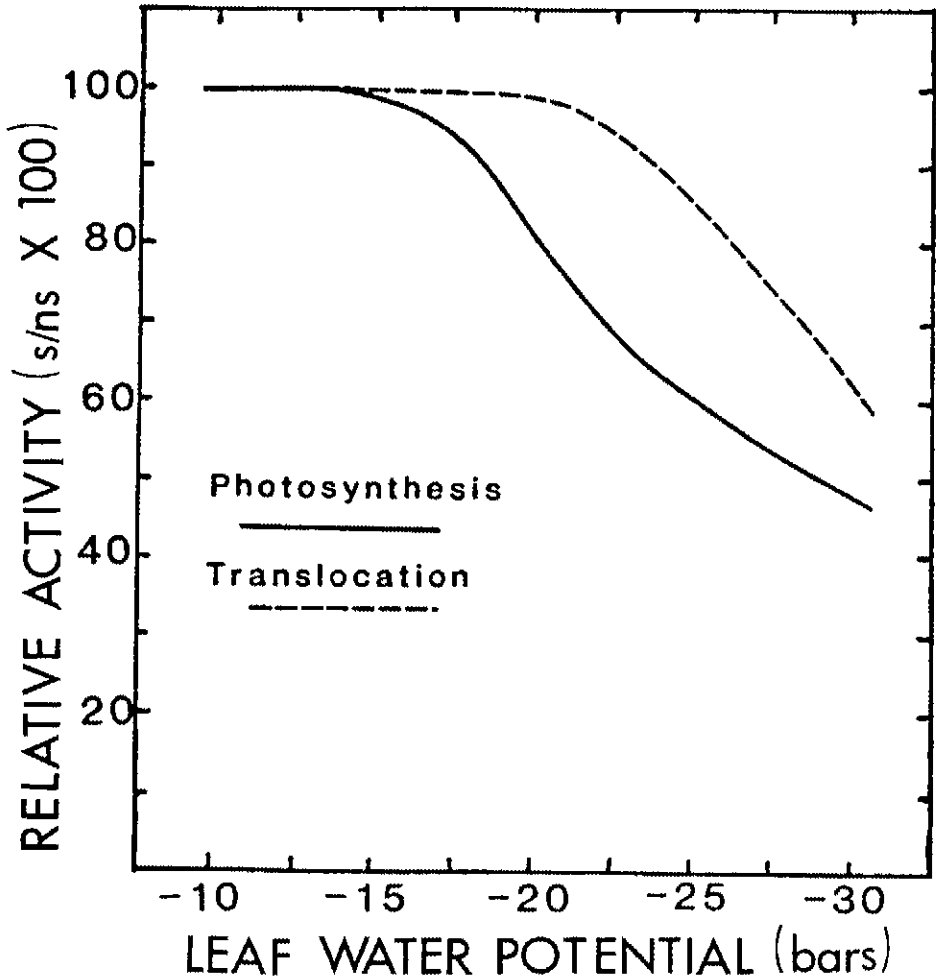

Figure 1. Relative activity of photosynthesis and translocation in cotton leaves as a function of leaf water potential. (s = stressed; ns = nonstressed)

translocation rate response would indicate that photosynthetic C assimilation is more sensitive than translocation.

#### SINK RESPONSE

The distribution of the exported  $^{14}\text{C}$  was also examined 24 hours after exposure of various source leaves to evaluate changes in sink type or strength. The fruiting forms on the sympodium directly associated with the treated leaf received the greatest proportion of the exported  $^{14}\text{C}$ . In all cases, water stress increased the



percentage of exported  $^{14}\text{C}$  accumulated by the developing fruit. Upper canopy leaves on the main stem allocated a larger portion of the exported assimilate to vegetation and fruiting forms below the treated leaf; whereas, lower canopy leaves directed more assimilate toward the shoot than toward the roots. Water stress changed the allocation pattern for the upper canopy leaves but not for the lower canopy leaves.

The partitioning of assimilate within a sympodium was also examined. The boll attached to the first nodal position received the majority of assimilate produced by leaves on that sympodium. This boll was 25 days old, whereas the second boll was 18 days old and the third boll 8 days old. These data clearly indicate that the direction of assimilate flow is under the influence of sink strength. The pattern of assimilate flow was not affected by water stress.

Water stress imposed on the cotton plant after flowering began resulted in significant abortion of small fruit. Of the bolls produced, no significant differences in dry weights existed between non-stressed and stressed plants in this experiment (Table 1). Our data indicate that fruit load is manipulated so that the reduced amount of available assimilate can be utilized most efficiently. The intrinsic abortion mechanism is probably controlled by hormones (Heilman *et al.*, 1971); however, the decrease in photosynthetic productivity may trigger the hormonal changes (Guinn, 1974a; chapter 12).

## SUMMARY

The results of these experiments suggest that the primary effect of water stress resides in reduced photosynthetic activity due to leaf area and photosynthetic rate reductions, confirming our previous work (Ackerson *et al.*, 1977). Some reallocation of exported assimilate from various source leaves is also apparent with the changes being associated with various sink strengths. The major effect was on source activity not sink activity.

## ACKNOWLEDGEMENTS

Our research was supported by the Science and Education Administration of the USDA under grant number 5901-0410-8-0095-0 from the Competitive Research Grants Office and from USDA-ARS under agreement numbers 58-7B30-0-160 and 58-7B30-9-107 and from the State of Texas through Texas Tech University and the Texas Agricultural Experiment Station.

## Chapter 9

# EFFECTS OF NUTRIENT ELEMENTS ON FRUITING EFFICIENCY

Howard E. Joham  
Texas A&M University  
College Station, Texas

## INTRODUCTION

### NUTRIENT ELEMENT BALANCE

In order to understand the influence of nutrient elements on flowering and fruiting, it is helpful to review the concept of nutrient element balance as proposed by Shear *et al.* (1946). According to their hypothesis, when all other environmental factors are at optimum conditions, plant growth is a function of two variables of nutrition; intensity and balance. Intensity is the concentration of individual nutrient elements as reflected in the tissue concentration at a given stage of growth. Balance refers to the relation of the concentration of one element to the concentration of all of the other essential nutrient elements. At any given level of intensity (concentration) for one element, the highest yield will be obtained only when all of the other nutrient elements are brought to a level of optimum balance. Maximum yield, which is perhaps a figment of our imaginations, is obtained only upon the coincidence of optimum intensity and balance for all the essential elements. A substantial decrease or an increase of any essential element from its concentration at optimum intensity for a given balance will result in a decrease in yield. A new yield peak is possible only when the concentrations of all the other nutrient elements are adjusted to bring about a new balance. Thus, a change in the accumulation of one element may or may not be in the direction of improving balance. In any respect, that change will be reflected in growth, yield, and sometimes the appearance of other visual symptoms.

### MEASUREMENTS OF FRUITING, FRUITING EFFICIENCY, AND EARLINESS

The term, yield, needs clarification since it may refer to vegetative or fruit production depending upon the crop in question. With cotton, we are concerned only with fruit (boll) production and, more often, only a portion of the fruit, the fiber. When a nutritional stress is applied, either intentionally or unintentionally,

the effect of that stress may be measured in vegetative and/or fruiting growth. Through the years, several indices have been developed which provide useful information concerning the efficiency of a cotton plant in supporting a boll load.

Eaton (1945) coined the term, relative fruitfulness, and defined it as the number of green bolls per 100 grams of fresh stem and leaves. He used this ratio as an indication of the efficiency of the cotton plant to support a fruit load. Measurements of relative fruitfulness can be made under field conditions with very simple equipment. When using relative fruitfulness to compare varieties, one needs to be aware of the difference in boll size between varieties. Joham (1955) used the ratio dry weight of bolls to dry weight of stems plus leaves to describe fruiting efficiency and termed this ratio the fruiting index. Fruiting index gives a more reliable comparison between varieties than relative fruitfulness, but is more difficult to measure since the plants must be taken to the laboratory for oven drying before weighing. Fruiting index is similar to harvest index (dry weight of grain/total dry weight of plant) commonly used in cereal crops.

Both indices, relative fruitfulness and fruiting index, are measurements of fruiting efficiency and are related to the ability of the vegetative portion of the cotton plant to support a fruit load. One must be aware that neither relative fruitfulness or fruiting index is a measure of yield. Small and large plants may have the same relative fruitfulness or fruiting index measurements, but the yield of the large plant will be much greater than that of the small plant. Depending upon the treatment, plants of equal size may differ considerably in their relative fruitfulness or fruiting index measurements. In this case, the indices are directly related to yield.

Relative fruitfulness and fruiting index may be characteristics which are primarily under genetic control, but we have ample evidence that environmental factors play major roles in the expression of these characteristics. Variations in light intensity, going from shaded conditions to light saturation, are associated with marked increases in relative fruitfulness of cotton. Increases in temperature, from suboptimal to optimal, promote increases in relative fruitfulness and fruiting index. The role of moisture is much more difficult to evaluate, but we know of effects of moisture stress on flowering and square shedding which in turn would influence the indices of fruiting efficiency (Chapter 7). Thus, light intensity, temperature, and moisture are major environmental factors influencing measurements of fruiting efficiency. Within this framework, the supply of nutrient elements plays an important role in the partition of vegetative and fruiting growth.

By using fruiting index or relative fruitfulness, one is able to examine the association of the nutrient element with vegetative or fruiting growth. When this is done, we find we may classify the essential elements into two broad groups. The first group consists of those elements in which a deficiency of the element causes a decrease in fruiting index or relative fruitfulness. Such nutrient elements seem to play a more direct role in flowering or fruiting. A deficiency of such an element limits fruit production to a greater extent than it does vegetative growth. Ele-

ments which fall within the above group are P, K, Ca, Mg, B and possibly Zn. The second group are those elements in which a deficiency has little or no effect on the fruiting index or relative fruitfulness. This is not to say that a deficiency of such an element does not decrease yield, but rather the deficiency restricts vegetative and fruiting growth to an equal extent. This group is comprised of N, S, Mo and Mn.

*Within the concept of nutrient element balance, we may study the effect of each nutrient element on vegetative and fruiting growth for that particular nutritional environment we impose on our experiment. With all other elements at what we hope is an optimum balance, we then vary the level of our test element and observe the effects of that treatment on growth and fruiting.*

Another important aspect of growth and differentiation is earliness. This term has different meanings depending upon the background of the authors and their use of the term. From a physiological point of view, a measure of earliness should involve the changes from vegetative growth to flower and fruit production. Appearance of first squares, open flowers or nodal position of the first fruiting branch might well be yardsticks of earliness in the physiological sense. From an agronomic point of view, earliness may refer to crop production and be measured by the percent of the crop harvested at first picking and the number of days from planting to first harvest. As the flowering period progresses, there is a tendency for flower production to reach a peak and then decline rapidly and even stop. The point at which flowering stops is referred to as cutout. Determinate cotton varieties have short flowering periods with clearly marked cutout points while indeterminate varieties are apt to continue flowering over much longer periods. Eaton (1955) points out that determinateness may be primarily under genetic control, but it is influenced by environmental factors. Temperature and moisture play major roles in expression of determinateness and in some cases, nutrient supply is of equal importance.

## EFFECTS OF NUTRIENTS ON FLOWERING AND FRUITING

### ELEMENTS AFFECTING THE VEGETATIVE-FRUITING RATIO

Certain nutrient elements have very marked effects on fruiting efficiency, the partition of vegetative and fruiting growth. Changes in the substrate concentration of these elements, especially as their concentrations approach deficient levels, are accompanied by decreases in relative fruitfulness and fruiting index. These elements may or may not have an influence on the various measurements of earliness. Even so, we group these elements together as elements controlling fruiting efficiency.

**Phosphorus**—A deficiency of phosphorus (P) decreases relative fruitfulness and fruiting index of cotton. In a greenhouse experiment, Ergle and Eaton (1957)

varied the P content of nutrient solutions supplied to Empire cotton grown in sand. The nutrient solution designated as low P was supplied 1.4 or 7.8 ppm P on alternate days. The high P supply was maintained as 24 ppm throughout the experiment. The low P treatment caused a 97 percent reduction in yield (dry weight of bolls) of 87-day-old cotton plants. Relative fruitfulness was 4.5 and 1.0 for the high and low P treatments, respectively. Sorour (1963) determined the fruiting index of normal and P deficient Deltapine 15 plants at 130 days after planting. The fruiting index, 0.92 for the normal plants, was reduced to 0.25 by P deficiency (Table 1).

Brown and Pope (1939) studied the influence of P supply on earliness of cotton. They varied the N, P, and K supplied to cotton in a five year field study. Phosphorus was varied from 0 to 144 pounds  $P_2O_5$ /acre. Their P treatment had a small effect on yield. The increase from 2061 to only 2268 pounds seed cotton per acre was probably insignificant. Even though P had little effect on yield, increasing P promoted earliness as measured by percent of seed cotton at first picking and percent blooms during the first two weeks of flowering (Table 1).

Table 1. Effect of phosphorus on relative fruitfulness,<sup>1</sup> fruiting index<sup>2</sup> and earliness of cotton.<sup>3</sup>

P supply (ppm)	Fresh weight (g.) leaves & stems	Boll count	Relative fruitfulness
1.4-7.8	71	0.7	1.0
31.0	544	24.5	4.5
	Dry Weight (g.)		Fruiting index
	Leaves & stems	Bolls	
3.1	53	13	.25
31.0	107	98	.92
$P_2O_5$ (lbs/acre)	Seed cotton (lbs/acre)	% Seed cotton first picking	% Blooms 1st 2 weeks
0	2061	48	29
144	2268	67	40

<sup>1</sup>Data from Ergle and Eaton (1957).

<sup>2</sup>Data from Sorour (1963).

<sup>3</sup>Data from Brown and Pope (1939).

**Potassium**—Variations in the potassium (K) supply of the substrate are associated with marked changes in the fruiting index. In a greenhouse experiment (Joham, 1955) in which cotton plants were grown for 45 days in complete nutrient solution and then for an additional 45 days in nutrient solution with and without K the fruiting index was 0.89 for the plus K treatment as compared to 0.34 for the

Table 2. Effect of potassium on fruiting index<sup>1</sup> and earliness<sup>2</sup> of cotton.

Nutrient treatment	Dry weight (g.)		Fruiting index
	Leaves & stems	Bolls	
Control	28.7	25.4	.89
-K	36.4	12.5	.34
-K+Na	28.5	24.0	.84
K (lbs/acre)	Seed cotton (lbs/acre)	% Seed cotton first picking	% Blooms 1st 2 weeks
0	1998	62	33.4
72	2454	56	33.4

<sup>1</sup>Data from Joham (1955).

<sup>2</sup>Data from Brown and Pope (1939).

K deficient series (Table 2). The minus K (-K) plants produced considerably more vegetative dry weight than did the plus K plants, but the -K treatment caused a 51 percent reduction in boll load. When considering the influence of K on fruiting, one must be aware of the sodium (Na) content of the nutrient medium. A number of investigators have reported that the addition of Na on K deficient soils increases yield of cotton (Cooper *et al.*, 1953; Lancaster *et al.*, 1953; Marshall and Sturgis, 1953). Joham (1955) and Joham and Amin (1965) demonstrated the partial substitution of Na for K in the nutrition of cotton under controlled conditions. When Na was added to K-deficient nutrient solution, the fruiting index was increased to a level equal to the control plants (Table 2). It is interesting to note that the -K plants produced more vegetative dry weight than the control or -K+Na series. Thus, in K deficiency the addition of Na promoted fruiting.

In the field study conducted by Brown and Pope (1939), K did not influence earliness. Even though they obtained a significant 456 lbs/acre increase in seed cotton when K<sub>2</sub>O supply was raised from 0 to 72 lbs/acre, there was no difference in the percent seed cotton harvested the first picking nor the percent blooms produced the first two weeks of flowering (Table 2).

**Calcium and Magnesium**—Deficiencies of either calcium (Ca) (Joham, 1955) or magnesium (Mg) (Helmy *et al.*, 1960) decrease relative fruitfulness and fruiting index. In an experiment in which calcium supply was drastically restricted during the flowering period, flowering and fruiting was almost completely stopped and fruiting index fell from 0.89 for the control plants to 0.06 for the -Ca treated plants (Table 3). It is reasonable to ask, if under a different set of circumstances, where the deficiency of Ca was not so severely limiting, would we observe a similar effect on fruiting index?

Calahan (1977) varied the calcium content of his nutrient solution and record-

ed yield and fruiting index of Deltapine 16 cotton. His lowest Ca level (1 me/L) was sufficient to promote good growth and fruiting. Increasing Ca from 1 to 10 me/L increased yield and fruiting index. With an additional increase in substrate Ca, yield remained essentially constant, but a further increase in fruiting index was recorded. Thus, the effect noted by Joham (1955) was shown (Calahan, 1977) to be valid for the more normal ranges of Ca nutrition. Under Ca deficient conditions, the addition of modest amounts of Na increased the fruiting index.

Helmy *et al.* (1960) found a positive association between substrate Mg levels and both relative fruitfulness and fruiting index of Stoneville Z106 (Table 3). A similar trend was noted in Pima S-1 cotton, but the experiment was not conducted over a sufficient period to collect reliable data from the Egyptian-type cotton. Helmy noted that Mg deficiency delayed flowering of the Pima S-1 plants. His data show that the control plants started flowering 55-58 days after planting while the first flowers were noted on the Mg deficient plants some 20 days later. There is good evidence that Ca and Mg are active in controlling the vegetative-fruiting growth ratio, but we do not have sufficient data on either element to firmly establish their relationships to earliness.

Table 3. The influence of calcium<sup>1</sup> and magnesium<sup>2</sup> on relative fruitfulness and fruiting index of cotton.

Ca level	Dry weight (g.)		Fruiting index
	Stems & leaves	Bolls	
Control	28.6	25.4	.89
-Ca	23.2	1.1	.06
-Ca + Na	24.9	10.3	.41

Relative Mg level	Relative fruitfulness	Fruiting index
1	3.2	.40
1/4	2.7	.28
1/16	1.9	.26
1/64	1.8	.18

<sup>1</sup>Data from Joham (1955).

<sup>2</sup>Data from Helmy *et al.* (1960).

**Micro Nutrients Boron and Zinc**—Eaton (1932, 1944) grew Acala cotton plants in gravel supplied with nutrient solutions. He varied the boron (B) content of the solutions from a trace (< .5ppm) to 25 ppm and measured growth and fruit production. From his data, it is possible to calculate both relative fruitfulness and fruiting index. Yield increased with increasing B to 10 ppm then decreased as B was raised to 25 ppm (Table 4). Both relative fruitfulness and fruiting index increased sharply when B was raised from a "trace" to 1 ppm. Further increases in B caused a small rise in the relative fruitfulness with the highest reading

Table 4. Growth and fruiting of cotton as influenced by boron<sup>1</sup>.

Boron ppm	Dry weight (g/plant)		Relative fruitfulness	Fruiting index	% Open bolls
	Stems & leaves	Bolls			
Trace	47.0	4.0	1.6	.09	0
1	78.3	37.3	5.4	.48	25
5	108.5	39.5	5.8	.36	13
10	136.5	56.5	6.2	.41	12
15	78.8	31.0	6.7	.39	13
25	93.3	37.5	4.6	.40	21

<sup>1</sup>Data From Eaton (1932, 1944).

coming at the 15 ppm B level, a point which was just past the point of maximum yield in Eaton's experiment. No consistent trend was noted in fruiting index when B was increased above the 1 ppm level. Thus, in the deficiency range, a "trace" to 1 ppm, B played a major role in the partition of vegetative and fruiting growth.

Eaton (1932) implied that B plays an important role in earliness. From his data we can calculate the percent of mature crop at harvest (about 150 days). Plants grown in the "trace" treatment had only green bolls at harvest while 25 percent of the crop was mature on plants treated with 1 ppm B (Table 4). Eaton's comment that the "plants in the '0' bed shed most of their floral buds and bolls . . . no bolls set previous to October were retained" supports the data on percent mature crop. In a field test, Anderson and Boswell (1968) applied B at the rates of 0.0, 0.45, and 0.89 kg/ha as a side dressing to cotton. Over a three year period the 0.45 kg/ha rate of B caused a 7.3 percent increase in cotton harvest at the first picking. Thus, we do have some information supporting a relationship between B and earliness of cotton.

In controlled experiments involving variations in zinc (Zn) supply and mini-

Table 5. The effects of zinc supply and early season temperature control on yield and fruiting index of cotton<sup>1</sup>.

Zn ppm	15C		19C		23C	
	Dry wt. (g.) bolls/ plants	Fruiting index	Dry wt. (g.) bolls/ plants	Fruiting index	Dry wt. (g.) bolls/ plants	Fruiting index
1	49.9	.35	90.0	.70	115.8	.69
5	62.1	.46	115.6	.88	—	—
25	82.7	.71	111.3	.96	109.4	.73
75	—	—	—	—	106.0	.75
125	4.7	.17	6.4	.24	—	—

<sup>1</sup>Data from Joham and Rowe (1975).



imum temperature, Joham and Rowe (1975) noted that the Zn treatments had a marked influence on the partitioning of vegetative and fruiting growth, and this relationship was influenced by temperature. With a 15C early season minimum temperature, increasing substrate Zn from 1 to 25 ppm was associated with an increase in fruiting index (Table 5). When the minimum temperature was raised to 23C, the effect of Zn on fruiting index was eliminated. In the above experiment increasing substrate Zn to the 25 ppm level increased yield at the two lower temperatures, but there was no effect on earliness as measured by appearance of first flowers. When Zn was raised to a toxic level, yield was reduced and flowering was delayed. Increasing Zn levels and temperature influenced flowering, causing a shift from an indeterminate to a more determinate flowering pattern. It is reasonable to assume that severe deficiencies of Zn would delay flowering and fruiting, and such has been reported by Brown and Wilson (1952). In a critical study of the Zn nutrition of several species of cotton, the above authors reported that Zn deficient *G. barbadense* plants did not produce any squares and *G. hirsutum* and *G. arboreum* plants produced only a few squares, all of which shed at or during anthesis.

At this point, one may speculate as to the association of the above nutrient elements (P, K, Ca, Mg, B, Zn) in control of vegetative-fruiting growth. Eaton (1955) stated that the notable effect of B on controlling relative fruitfulness was understandable due to the role of B in control of carbohydrate translocation. We now know that Ca (Joham, 1957, 1974; Joham and Johanson, 1973) K (Ashley and Goodson, 1972), and Mg (Helmy *et al.*, 1960) function in the control of carbohydrate translocation. With deficiencies of each of these elements, carbohydrate movement from the leaves of cotton plants is restricted both in rate and distance moved. Such a restricted flow of carbohydrates could have an influence on the number and size of the bolls formed. Even so, this leaves unanswered the question as to why a deficiency of these elements causes a greater reduction in fruiting than in vegetative growth. Curtailment of carbohydrate flow out of the leaves should and does cause a decrease in vegetative growth. Perhaps the answer lies in a proximity of the growing points to the leaves and in the relative polarity of carbohydrate movement to the vegetative or fruiting points. Phosphorus and Zn have not been shown to control carbohydrate translocation in cotton, yet, they exert profound effects on the indices of fruiting. The effects of P are similar to those of light and temperature in promoting fruiting and earliness, and these effects may be mediated through the well-known association of P in energy reactions. Auxin may inhibit or stimulate flowering depending upon its concentration in the plant. Thus, the effect of Zn on the partition of vegetative-fruiting growth may be brought about by the requirement of Zn for tryptophan synthesis (Tsui, 1948) and the role of Zn in maintaining auxin in an active state (Skoog, 1940).

## ELEMENTS NOT AFFECTING FRUITING INDICES

**Nitrogen**—Eaton and Rigler (1945) studied the influence of nitrogen (N) levels on growth and fruiting of Stoneville 2B cotton. The range of nitrogen varied from a deficient to an excessive level (Table 6). Even though they obtained an excellent

Table 6. The influence of nitrogen treatment on growth and fruiting of cotton<sup>1</sup>.

Nitrogen Me/L	Fresh wt. (g.)		Relative fruitfulness	Fruiting index
	Stems & leaves	Bolls		
1	107	170	1.59	6.8
4	382	458	1.20	6.4
16	367	468	1.28	6.4
64	252	370	1.47	7.6

<sup>1</sup>Data from Eaton and Rigler (1945).

curvilinear yield response, fruiting index and relative fruitfulness remained essentially constant over the entire range of nitrogen levels studied. In a later article, Eaton (1955) noted that "Both the low and high nitrate levels depressed growth and increased relative fruitfulness". An examination of his data indicates that the changes in relative fruitfulness associated with nitrogen level were small, and in all probability, they were not significant. The results of Eaton and Rigler (1945) agree with those presented earlier by Wadleigh (1944); thus, we have ample evidence indicating that nitrogen deficiency reduces vegetative and fruiting growth to the same extent (see Chapter 10).

There seems to be a general misconception that increasing nitrogen levels causes a delay in fruiting and an increase in the vegetative character of the plant. No such effect was observed by either Eaton and Rigler (1945) or Wadleigh (1944). In their field study, Brown and Pope (1939) increased the yield of seed cotton from 1662 lbs/acre for the zero N plots to 2292 lbs/acre for plots receiving 48 lbs N/acre. There was no change in earliness as measured by percent seed cotton harvested at first picking and percent blooms the first two weeks of flowering. The above observations were supported by the data of Perkins and Douglas (1965). Wadleigh (1944) recorded flowering as influenced by a wide range in N treatment. Regardless of N treatment, all plants started flowering on about the same date. Nitrogen had a marked influence on the termination of flowering; thus, nitrogen deficient plants exhibited a very determinate flowering pattern. High nitrogen treated plants flowered over a much longer period and produced a flowering pattern characteristic of indeterminate cotton.

**Sulfur**—Ergle and Eaton (1951) varied the sulfur (S) content of nutrient solutions supplied to Stoneville 2B cotton grown in the greenhouse. Increasing sulfur had no effect on relative fruitfulness. Growth and yield increased with each increment of substrate sulfur but the partition between vegetative and fruit production remained nearly constant.

**Manganese**—Joham and Amin (1967) studied the influence of a wide range of manganese (Mn) concentrations on the growth and fruiting of cotton (Table 7). Fruiting index remained essentially constant when Mn was increased from 1 to 27 ppm. Although yield (dry weight bolls) decreased over the same Mn range, the difference was small and not significant. When substrate Mn was increased to 81 ppm, an obviously toxic level, there were sharp reductions in growth, yield, and fruiting index. Taylor (1965) extended the observation on Mn into the deficiency range. With concentrations of Mn in nutrient solutions of 0.005 and 0.5 ppm, he obtained a 10-fold increase in yield while the fruiting index measured 0.50 and 0.51 respectively. Below 0.005 ppm the plants did not survive.

Joham and Amin (1967) reported that increasing Mn from 1 to 27 ppm increased earliness. The 27 ppm plants produced one flower per plant four and nine days earlier than the 9 ppm or the 3 ppm and 1 ppm plants, respectively. Anderson and Boswell (1968) obtained field data which support the observations on the effect of Mn in promoting earliness. In their study, Mn applied at 2.23 Kg/ha gave a 22.2 percent increase in cotton harvested at the first picking.

Table 7. Growth and fruiting of cotton as influenced by manganese<sup>1</sup>.

Manganese ppm	Dry weight (g.)		Fruiting index
	Stems & leaves	Bolls	
1	51.4	30.0	.58
3	60.3	27.1	.44
9	45.6	26.6	.58
27	49.2	23.3	.47
81	7.1	0.7	.10

<sup>1</sup>Data from Joham and Amin (1967).

**Molybdenum**—Although the evidence is not complete concerning the influence of molybdenum (Mo) on the partition of vegetative and fruiting growth in cotton, it seems likely that wide variations in Mo supply do not affect fruiting index. In a greenhouse experiment employing complete nutrient solutions, Joham (1952) supplied Mo at rates varying from 0 to 35 ppm to cotton plants grown in sand. Since the salts employed in his experiment were not purified, the 0 treatment actually contained about 1 ppm Mo, which was sufficient to promote good growth and fruiting. The 35 ppm Mo treatment approached a toxic level and caused a 22 percent reduction in growth. In a later experiment Amin and Joham (1960)

extended their observations into the Mo deficiency range. Using highly purified salts, they grew cotton plants in nutrient solutions containing <1.5 ppb Mo. The low Mo supply caused a 20 percent reduction in seed cotton yield. Thus, in experiments in which the Mo supply was varied from mild deficient to near toxic levels, the fruiting index of cotton remained nearly constant (Table 8).

Table 8. Growth and fruiting of cotton as influenced by substrate molybdenum level.

Mo supply	Dry weight (g.)		Fruiting index
	Stems & leaves	Bolls	
Hydroponics experiment <sup>1</sup>			
<1.5 ppb	45.1	21.9	.49
1.0 ppm	52.5	27.3	.52
Sand culture experiment <sup>2</sup>			
0 ppm	83.2	41.5	.50
5	77.1	42.5	.55
15	83.3	43.1	.52
25	71.5	35.5	.49
35	62.7	34.6	.55

<sup>1</sup>Data from Amin and Joham (1960).

<sup>2</sup>Data from Joham (1952).

## SUMMARY

In this paper we have covered the influence of most of the nutrient elements on the partition of vegetative and fruiting growth. Two indicators of plant efficiency in relation to the vegetative-fruiting partition were presented and discussed. Fruiting index and relative fruitfulness are measurements of the relationship between vegetative and fruiting growth. Certain nutrient elements (P, K, Ca, Mg, B, Zn) have marked effects on the indices of fruiting efficiency. Increases in the substrate level of the above elements, going from deficient to near toxic levels, cause corresponding increases in fruiting index or relative fruitfulness. It is interesting to note that four of the above elements (K, Ca, Mg and B) have been closely implicated with translocation of carbohydrates and that deficiencies of these elements cause carbohydrates to accumulate in the leaves. Other nutrient elements (N, S, Mn, Mo) seem to have little or no influence on the partition of vegetative and fruiting growth. For example, a deficiency of N causes a reduction in both vegetative and fruiting growth, and as a result the fruiting index or relative fruitfulness remains unchanged.

Five elements (P, Mn, B, Zn and possibly Mg) have been shown to play a role in earliness. The means used to measure earliness varies from paper to paper and may refer to days to first flower or percent of crop harvested at first picking. Both P and Mn have been shown to promote earliness under field conditions. It might well be that other elements, when brought into proper balance, will be shown to have an influence on earliness.

Notably absent from our list are references to iron, copper and chlorine. Work is needed to establish the effect of these elements on the partition of vegetative-fruited growth and earliness.

## Chapter 10

# THE NITROGEN STRESS SYNDROME

John W. Radin and Jack R. Mauney

USDA-ARS

Phoenix, Arizona

## INTRODUCTION

This paper will present and discuss some basic physiological effects of nitrogen (N) nutrition in the cotton plant. The general thesis will be that N deficiency generates several related, yet discrete and experimentally identifiable, effects. Overall, these effects are integrated at the whole-plant level to produce systematic alterations in growth, yield, earliness, and other agronomic characteristics.

Because the benefits or detriments of a particular level of N nutrition are conditional—dependent upon other factors—the concept of N deficiency must be defined closely here. By deficiency we mean a level of N nutrition which allows less than maximum dry matter production without regard to the nature of that dry matter. Thus, to the extent that N nutrition alters partitioning between vegetative and reproductive dry matter, a deficiency could actually be desirable. Indeed, this argument is made for cotton grown under certain conditions and probably is valid for indeterminate crops in general.

There are three primary responses by plants to N deficiency which can explain most or all of their observed differences in growth and performance. These three effects are: (1) altered photosynthetic rate; (2) altered leaf expansion resulting from changes in hydraulic conductivity; and (3) altered responses to water stress. The first effect has received by far the most attention, presumably because chlorophyll depletion is the most obvious visual symptom of N deficiency. All three effects, however, contribute to alterations of whole-plant behavior. In fact, except for severe deficiency, the second and third effects may be the most important. Each of the three effects is discussed in a separate section of this paper, and an integrative overview is presented in the final two sections.

## PHOTOSYNTHESIS

The literature is replete with studies of the relationship between plant N status and photosynthetic rate. There is little need to review this literature extensively. Ojima *et al.* (1967) present a typically strong correlation between leaf photosyn-

thetic rate and leaf N concentration. Natr (1975) examined this subject and concluded that photosynthetic rate per unit leaf area was closely related to leaf N concentration.

There is little reason to doubt an effect of N on photosynthesis, although Radin (1983a) argued that photosynthetic inhibition is secondary to other effects of N deficiency as a determinant of growth in cotton (and other dicotyledonous plants). In cereals, growth effects of N deficiency were much more closely tied to photosynthesis (Radin, 1983a). Because most of the leaf N is in the chloroplasts (Stocking and Ongun, 1962) and most of the chloroplast N is in the enzyme RuBP carboxylase (Kleinkopf *et al.*, 1970), various authors have concluded that N regulates photosynthesis through its gross effects on the extractable activity of this enzyme (Natr, 1975; Medina, 1970). The evidence for this conclusion remains weak because it remains strictly correlative (*e.g.*, Motta and Medina, 1978). The critical data (*e.g.*, increased concentrations of RuBP, the substrate, and decreased concentrations of PGA, the reaction product) under N deficiency have not yet been published.

Photosynthesis can be considered to consist of "dark reactions" and "light reactions" (see Chapter 15). The former (which include the CO<sub>2</sub> fixation step catalyzed by RuBP carboxylase) are generally believed to limit photosynthetic rate in high light, but not in dim light. Some work suggests that N deficiency inhibits photosynthesis in low light to about the same extent as in high light (Nevins and Loomis, 1970; Osman and Milthorpe, 1971; Natr, 1970; Andreeva *et al.*, 1971 cited in Natr, 1975). Thus, it seems unlikely that carboxylation would be the only step influenced by N deficiency. Again, these observations are not supported by critical work to identify the presumed limiting step in the light reactions. Although chlorophyll levels are obviously affected by N, there is no reason to conclude that they become insufficient for normal photosynthesis (Benedict *et al.*, 1972).

Another possible interpretation of these data is that N deficiency might alter the activation level of RuBP carboxylase. This enzyme is activated by binding CO<sub>2</sub> and Mg (Jensen and Bahr, 1977). Recent evidence suggests that low light limits photosynthesis by regulating the degree of activation of RuBP carboxylase; its activity remains rate-limiting despite the low light (Perchorowicz *et al.*, 1981). The possible relationship between N nutrition and RuBP carboxylase activation remains unexplored.

Medina (1971) showed that N deficiency in *Atriplex patula* caused large accumulations of starch which were correlated with loss of photosynthetic activity. He suggested a possible causal role of the starch in photosynthetic inhibition. Deleterious effects on photosynthesis under some conditions have frequently been attributed to starch (*cf.* reviews by Neales and Incoll, 1968; Guinn and Mauney, 1980). Nafziger and Koller (1976) attributed starch effects to an increased diffusion pathlength for CO<sub>2</sub> within the chloroplast, but there is no direct evidence for this or any other mechanism. A possible role of starch in N-deficient

plants has not been followed up. It is worth pointing out that this proposed effect of N is fundamentally different from the others discussed earlier—inhibition by starch, an end product of photosynthesis, implies that photosynthetic changes occur fairly late in the progression of N deficiency. Obviously, other effects of N must first cause the accumulation of starch before photosynthetic effects could be seen.

Effects of N on photosynthesis at the chloroplast level are evidenced by changes in the mesophyll resistance to CO<sub>2</sub> diffusion. The well-known model of Gaastra (1959) envisions sequential resistances in the pathway for CO<sub>2</sub> uptake, *i.e.* stomatal and mesophyll resistances in series. Recently, Wong *et al.* (1979) reported that these two resistances were closely related under a variety of conditions, including N deficiency. Thus, in analyzing limitations to photosynthesis, one must consider effects on the entire diffusion pathway. The spectacular advances in plant biochemistry of the last 20 to 30 years have tended to focus attention on the chloroplast, but studies of photosynthesis involving the stomata have not kept pace. Nonetheless, some work has appeared which implicates them in the effects of N deficiency. Childers and Cowart (1935) early showed that N deficiency sharply curtailed transpiration rate along with photosynthetic rate of apple leaves. Ryle and Hesketh (1969), Nevins and Loomis (1970), and Ludlow and Ng (1976) much later demonstrated increased stomatal resistance due to N deficiency in corn, sugarbeet and *Panicum maximum*, respectively. The changes paralleled those of the mesophyll resistance to CO<sub>2</sub> uptake. Further convincing evidence for N effects on stomata was provided by Ishihara *et al.* (1978, 1979a,b) in rice. Although their use of stomatal aperture measurements instead of stomatal resistances largely precluded any precise partitioning of N effects into stomatal and mesophyll components, it is clear that stomatal closure caused a substantial part of the N-related changes in photosynthesis. However, Medina (1970, 1971) found no evidence for a stomatal component of the N effects in *Atriplex patula*.

Are the N effects on stomatal and mesophyll resistances independent or coupled, and if coupled, what is the mechanism? Teleologically it makes sense for stomata to close partially when the mesophyll resistance increases, for this would minimize the expenditure of water per unit of photosynthesis (Wong *et al.*, 1977; Cowan and Farquhar, 1977). The most commonly proposed coupling mechanism involves CO<sub>2</sub>. Stomata often are found to close as intercellular CO<sub>2</sub> concentration increases (Meidner and Mansfield, 1968; Sheriff, 1979). Farquhar *et al.* (1978) proposed that photosynthesis (which depletes the intercellular pool of gaseous CO<sub>2</sub>) and stomatal resistance (which controls the rate of replenishment of that pool) interact to stabilize the intercellular CO<sub>2</sub> concentration. This hypothesis has found wide acceptance, although it is not universally applicable because stomata are not always CO<sub>2</sub>-sensitive (Zelitch, 1969).

Raschke and coworkers (Raschke, 1975; Raschke *et al.*, 1976; Dubbe *et al.*, 1978) demonstrated that in several species, stomatal sensitivity to CO<sub>2</sub> depends



upon abscisic acid (ABA). Radin and Ackerson (1981) confirmed this in cotton. Neither N-deficient nor normal plants showed stomatal sensitivity to CO<sub>2</sub> unless the leaves had been sprayed with ABA or unless the plants were subjected to water stress. The effects of water stress on stomatal sensitivity to CO<sub>2</sub> persisted for at least a day after rewatering (Radin, unpublished). Presumably water-stressed plants were responding to endogenous ABA, which accumulated as a result of the water stress (Radin and Ackerson, 1981). However, the situation is complicated by the discovery that in N-deficient cotton, stomata began to show CO<sub>2</sub> sensitivity very early in the stress cycle and long before the leaf wilted or displayed any other visual symptoms of water stress (Radin and Ackerson, 1981). Thus, N-deficient plants, which are apparently well-watered, might or might not be entering a water stress-induced phase of stomatal CO<sub>2</sub> sensitivity. Based upon these results, it is impossible to judge whether the N effects on stomata discussed earlier all resulted simply from CO<sub>2</sub> homeostasis. The acceptance of this hypothesis for N-deficient leaves should be accompanied by specific tests of CO<sub>2</sub> sensitivity.

Other types of possible N effects on stomata, such as changes in elasticity of guard cell walls, have not been proposed or investigated. Presumably any such structural effects would be possible only if N were deficient during leaf (and guard cell) development. In experiments of Ryle and Hesketh (1969) and Nevins and Loomis (1970), N was withdrawn after leaves were mature, and such a mechanism presumably could not account for the results. However, it should be noted that N deficiency during leaf enlargement greatly decreased the elasticity of mesophyll cell walls (Radin and Parker, 1979a).

## LEAF EXPANSION AND HYDRAULIC CONDUCTIVITY

It has long been known that N nutrition affects the partitioning of plant resources into tops and roots. Turner (1922) found large differences in top:root ratio due to N availability, and he cited several similar findings from the middle of the 19th century. The recognition that this resulted from a more or less specific effect of N on leaf area is often credited to Watson (1952), who used growth analysis to separate leaf area development from dry matter accumulation. However, the same phenomenon was clearly shown earlier by others, for example Crowther (1934). Similar differences between N effects on leaf area growth and photosynthesis or dry matter increases have since been shown by Bouma (1970) and De Jong and Phillips (1981). Responses of cotton to N are typical (Figure 1). In plants grown on nutrient solutions in an artificial environment, dry matter accumulation per unit leaf area (net assimilation rate) was much less sensitive to N availability than was leaf area increase per unit leaf area (relative leaf area growth rate). These changes correspond to dry matter partitioning into leaves of about 65 percent at the highest N level and 45 percent at the lowest N level. Obviously this is a very substantial difference in photosynthate translocation

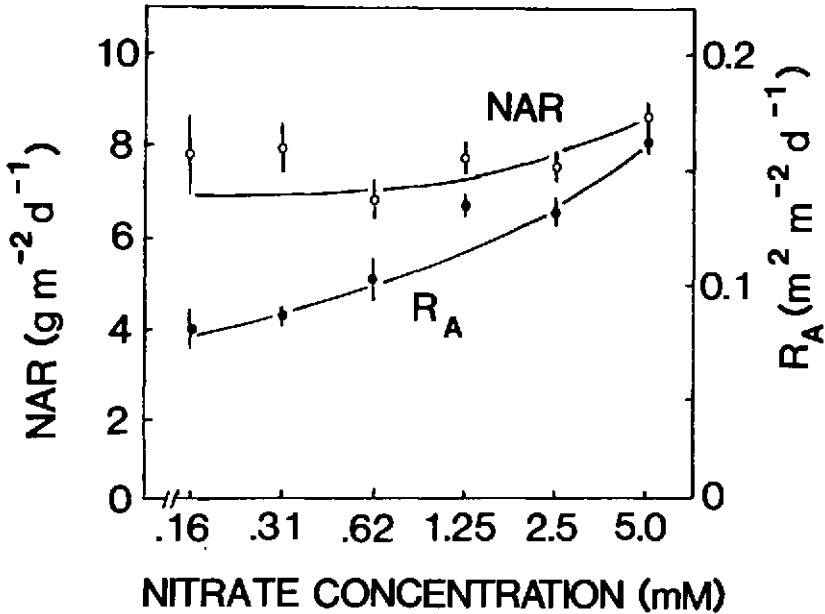

Figure 1. Net assimilation rate (NAR) and relative leaf growth rate ( $R_A$ ) of cotton plants grown on nutrient solutions containing different concentrations of nitrate. (The data were derived from dry weights [tops only] and leaf areas measured at three weeks and six weeks after germination. Values shown  $\pm$  standard errors).

from source to sink. Hartt (1970) concluded that in sugarcane, effects of N nutrition on translocation were subsidiary to overall effects on plant growth.

Morton and Watson (1948) and, much later, Radin and Parker (1979a) showed that N effects on leaf area were mediated mostly by differences in leaf cell expansion. This process has recently been studied in more detail in sunflower (Radin and Boyer, 1982). They found that N deficiency markedly decreased plant hydraulic conductivity (ability to transport water from soil to the leaves), thereby increasing the water deficit in the expanding leaves. During the day, when the leaves were transpiring, the water deficit was great enough to lower cell turgor below the critical point for expansion. At night, when transpiration was minimal, cell expansion in N-deficient plants proceeded at almost control rates. Radin and Boyer (1982) also showed that the metabolic aspects of growth ("wall loosening") were unaffected by N deficiency. This means that N metabolism *per se* was not sufficiently altered to have any direct growth consequences.

These surprising data show that N deficiency in sunflower inhibits leaf expansion primarily by altering plant water relations. A very similar conclusion can be reached for cotton, in which N deficiency also decreased hydraulic conductivity (Radin and Parker, 1979a), increased sensitivity of leaf expansion to water stress

(Radin and Parker, 1979b), and inhibited expansion primarily during the daylight hours (Radin, 1983a). Control of cotton leaf expansion by hydraulic conductivity is attractive because it provides a means to explain some otherwise puzzling observations. Radin and Parker (1979b) found strong interactions between temperature and N nutrition on leaf expansion. These data are consistent with effects of temperature on hydraulic conductivity (Markhart *et al.*, 1979a,b) and can be interpreted in such terms.

There are obvious parallels between the effects of N deficiency and the effects of water stress on leaf expansion. In the case of water stress, leaf expansion is inhibited more than photosynthesis (Boyer, 1970; Acevedo *et al.*, 1971). The photosynthate, which normally would support rapid leaf expansion, becomes available for other purposes such as increased root growth (Cutler and Rains, 1977), osmotic adjustment (Turner, 1979), accumulation of starch and other carbohydrates (Ackerson and Hebert, 1981; Ackerson, 1981) and even increased cell wall thickening (Cutler *et al.*, 1977b). Altered partitioning during N deficiency also enhances the root:shoot ratio (Radin *et al.*, 1978), accumulation of starch and other carbohydrates (Medina, 1971; Radin *et al.*, 1978; Wadleigh, 1944; Eaton and Rigler, 1945) and cell wall dry matter (Radin and Parker, 1979a; Shimshi, 1970b). Soluble sugars accumulated in both roots and shoots of N-deficient cotton (Radin *et al.*, 1978). Accumulation of such solutes in the leaves caused a small decrease of about 2 bars in osmotic potential (Radin and Parker, 1979a). These striking similarities between water stress and N deficiency undoubtedly arise because each stress decreases turgor in expanding leaves and thereby inhibits turgor-dependent growth. It is important to note that water stress-induced changes are believed to acclimate plants to further stress (Ackerson and Hebert, 1981; Cutler and Rains, 1977, 1978; Cutler *et al.*, 1977a,b; Radin, 1983b). To the extent that N deficiency parallels water stress, then it too should promote water stress tolerance (Radin and Parker, 1979a). That it does not do so will be discussed later.

## RESPONSES TO WATER STRESS

Most experiment stations in the world have some data in their files concerning the interaction of N fertilization and water stress on crop productivity. Some, such as the investigations of Crowther (1934a) in the Sudan, are classic pieces of work. However, little has been done over the years to elucidate some of the basic physiology of these N-water interactions. Our interest in this subject was stimulated by the realization that many developmental effects of N deficiency mimic those of water stress (see preceding section on LEAF EXPANSION AND HYDRAULIC CONDUCTIVITY). Surprisingly, some simple experiments quickly established that N deficiency in cotton causes stomatal closure at abnormally high water potentials (abnormally high plant water status) (Radin and Parker, 1979b). This change is opposite to that caused by water stress acclimation. The most unusual and interesting aspect was that the N-deficient leaves

were not close to wilting when stomata closed. Thus, N deficiency seemed to convert leaves into "water-savers" at the expense of photosynthetic production during a stress cycle. This early stomatal closure was not simply from increased intercellular  $\text{CO}_2$  (see earlier PHOTOSYNTHESIS section) but resulted from water stress *per se*, acting through ABA (Radin and Ackerson, 1981).

Data consistent with these observations were reported by McMichael and Elmore (1981) for cotton, Shimshi (1970a) for beans, and Nagarajah (1981) for tea. Similar behavior was found in both sunflowers and soybeans (Radin, unpublished). Ludlow and Ng (1976) reported similar effects in *Panicum maximum* plants grown in controlled environments but not in those grown outdoors.

The importance of this altered stomatal reaction to water stress cannot be overemphasized. The "water-saving" N-deficient plants tend to meter out the available water relatively slowly, thereby prolonging survival considerably after the onset of drought (Radin and Parker, 1979b). This occurs even if the canopy has achieved full cover (Mauney *et al.*, 1982), or if leaf area and soil moisture supply are matched across the N treatments. Furthermore, the slower development of soil moisture stress allows fuller exploration of the soil for stored water. Thus, the trait would seem to have some survival value when water supply is limiting or irregular. Of course, the decreased photosynthesis associated with N deficiency is disadvantageous when water is nonlimiting. These principles are clearly illustrated by Shimshi and Kafkafi (1978). They found that N fertilization greatly decreased stomatal conductance and leaf water potential of dryland wheat, but increased stomatal conductance and only slightly decreased leaf water potential in irrigated wheat. Presumably the fertilized dryland plants had less stomatal control over water loss, and thus quickly reached the point that severe water stress caused stomatal closure. The unfertilized plants, on the other hand, depleted available water more slowly and were less stressed after the same time interval. In the irrigated crop, water stress never developed, and the fertilized plants maintained greater stomatal conductance as described earlier in the section on PHOTOSYNTHESIS. A similar interaction of N and water was seen in the transpiration rates of coffee (Tesha and Kumar, 1978) and tea (Nagarajah, 1981), although water potentials were not reported.

The theoretical complexity of N effects on leaf water potentials can be easily appreciated. On the one hand, N deficiency decreases hydraulic conductivity, a change which would lower leaf water potential when all other factors are unchanged. On the other hand, it promotes early stomatal closure and limits leaf area, changes which tend to increase leaf water potential. Thus, one would expect either positive or negative effects on leaf water potential, depending upon time after last irrigation, evaporative demand, etc. In practice, the change in hydraulic conductivity is frequently overridden by the other effects, even in well-watered crops, and a negative effect of N deficiency on water status of mature leaves is seldom seen (Shimshi and Kafkafi, 1978; Tesha and Kumar, 1978; Nagarajah, 1981).

Another plant reaction to water stress is the senescence and abscission of the lower leaves (Jordan *et al.*, 1972). As with stomatal closure, N deficiency raised the water potential for initiation of senescence (Radin, 1981). However, senescence (or rather the loss of protein and chlorophyll, which represents an advanced stage of senescence) did not seem to be directly related to stomatal closure because the two processes occurred at very different water potentials. In leaf discs, senescence was apparently controlled by variations in both tissue ABA concentration and sensitivity to ABA (Radin, 1981).

## INTEGRATION OF NITROGEN EFFECTS

The title of this chapter suggests the existence of specific alterations in plant characteristics which are identified with growth limitation by N. We have examined three such alterations which might underlie the more obvious changes in growth and production, i.e. photosynthesis, hydraulic conductivity, and stomatal sensitivity to water stress. What are the relationships of these three characteristics to each other and to overall crop performance? If there are causal relationships, how might they be useful to an agronomist?

It seems quite clear that photosynthesis per unit leaf area is not nearly as sensitive to N deficiency as the other factors examined. Studies reviewed in the section on LEAF EXPANSION AND HYDRAULIC CONDUCTIVITY point to much earlier effects on leaf growth rate. The accumulation of carbohydrates in N-deficient plants also suggests strongly that excess photosynthate is available for growth. Thus, we feel that decreased photosynthetic rate cannot be the primary deleterious effect of N deficiency. Clearly the factor controlling leaf expansion rate is hydraulic conductivity, and we will examine it in more detail.

The limiting resistance to transpiration flux of water is found in the roots (Kramer, 1969; Graecen *et al.*, 1976; Blizzard and Boyer, 1980). Furthermore, the site of greatest resistance within the root is believed to be in the endodermis or in the stelar parenchyma (see Chapter 3) where water must pass through the membranes of living cells to reach the xylem vessels (Newman, 1974; Graecen *et al.*, 1976). Markhart *et al.* (1979a,b) have presented compelling evidence that a membrane governs variations in hydraulic conductivity (resistance is the reciprocal of conductivity). This conclusion is consistent with data of Oosterhuis and Weibe (1980) who estimated that 76 percent of root resistance in cotton is radial (i.e., in the water pathway between epidermis and xylem vessels) and only 24 percent is axial. It is therefore to be expected that N deficiency, which alters the fatty acid composition of root cell plasma membranes (Rivera and Penner, 1978), should also alter hydraulic conductivity.

Another possible reason for N effects on hydraulic conductivity is raised by work of Richards and Passioura (1981a,b). They showed a marked dependence of calculated root conductivity on the diameter of xylem vessels of wheat roots and a less marked dependence upon number of branches. In sunflower, N deficiency

decreased overall root diameter by 10 percent but had little effect on total root surface area; xylem vessels were not studied but were presumably narrower in N-deficient plants (Radin and Boyer, 1982). The argument that N alters hydraulic conductivity by altering cell size tends toward circularity, in that it requires that the primary event be a change in cell expansion. Changes in cell expansion, on the other hand, have been shown to depend upon hydraulic conductivity, at least in the shoot (Radin and Boyer, 1982; Radin, 1983a). Whether the control of cell expansion in growing roots is fundamentally different from that in shoots has not been addressed.

Interestingly, the N effects on stomatal sensitivity to water stress can also be analyzed in terms of cell membranes. When stomata close, there is concomitant accumulation of ABA in the leaf and secretion of ABA into the apoplast (Ackerson, 1982). However, the accumulation and secretion occur after the stomata are mostly closed (Ackerson, 1982; cf. Trewavas, 1981, for an excellent discussion). Trewavas suggests that changes in guard cell sensitivity to ABA (i.e., changes in the number of ABA receptor sites on the guard cell membranes) control stomatal response. Indeed, Davies (1978) and Ackerson (1980) previously showed that water stress increases stomatal sensitivity to ABA. Lurie and Hendrix (1979) reported that ABA inhibited a plasma membrane ATPase from the epidermis (presumably from the guard cells) of tobacco leaves but had little effect on ATPase activity from the mesophyll membrane preparation. Thus, one seemingly has direct access to the ABA receptor site. This presages rapid progress in understanding environmental effects on stomatal behavior.

What are the agronomic consequences of the N effects described here? One salient feature of the nitrogen stress syndrome is the greater inhibition of growth than of photosynthesis. Presumably the carbohydrates which accumulate could be put to good use supporting yield, so long as the deficiency remains mild. In cotton, this possibility of improved fruiting efficiency under N deficiency has largely been discounted since the work of Eaton and Rigler (1945), and this work therefore bears some detailed examination. Eaton and Rigler grew cotton plants on nutrient solutions containing a series of four nitrate concentrations (1, 4, 16, and 64 mM) ranging from deficient to slightly toxic. Plants were harvested at the time of first boll opening. With increasing N levels, the number of bolls per 100 g fresh weight leaves plus stems (relative fruitfulness) was 6.8, 6.4, 6.4 and 7.6 in open air in the summer, and 4.5, 3.8, 3.4 and 4.1 in a winter greenhouse under a shade. This has long been interpreted to mean that N did not affect relative fruitfulness. However, Eaton (1955) himself viewed the evidence differently because he stated, "Both the high and low nitrate levels depressed growth and increased relative fruitfulness in both tests." He further stated in the same article, "Weight of bolls was less suitable than the number of developing bolls in measuring relative fruitfulness in these tests because of the more determinate growth and higher average weights of the developing bolls in plants on low nitrate at the time the plants were harvested, i.e., only the earliest bolls were retained." This means

that the yield of the low-N plants was set very early; the small advantage in relative fruitfulness shown above would be transformed into a large advantage if only the very early crop were desired.

Wadleigh (1944) also grew cotton plants on a series of four nitrate concentrations and found similar results. Eaton (1955) calculated Wadleigh's relative fruitfulness indexes at 3.6, 3.5, 2.8, and 3.5, going from lowest to highest levels of N.

Radin (unpublished) grew cotton plants on 1 mM (low) or 5 mM (high) nitrate in a greenhouse and followed growth, boll numbers, and partitioning for 139 days after planting. The relative fruitfulness index used by Eaton and Rigler (1945) could not be calculated because fresh weights were not measured. However, number of bolls per unit leaf area provided a similar measure of fruiting efficiency. Table 1 shows that at 75 days after planting, low-N and high-N plants had the same number of bolls, but at 135 days after planting the high-N boll load had increased to three times the boll load of the low-N plants. However, the low-N

Table 1. Boll numbers of upland cotton plants grown on two levels of N nutrition. (Data are means of 12 plants, 6 from each of two cultivars—Acala SJ-4 and Paymaster 909).

Days after planting	Bolls per plant		Bolls per dm <sup>2</sup> leaf area	
	1 mM N	5 mM N	1 mM N	5 mM N
75	2.0	2.1	0.30	0.12
105	2.4	5.3	0.44	0.34
135	3.0	9.3	0.46	0.53

plants were much more efficient in terms of early boll load per unit leaf area. At 75 days after planting the low-N plants carried 2.5 times more bolls per unit leaf area, and the high-N plants did not surpass the low-N plants until 135 days after planting. The fruiting index (boll dry weight as a percentage of total plant dry weight) at 135 days was 41 percent for low-N plants and 27 percent for high-N plants (Table 2). This difference was significant at the 95 percent confidence level. The effects of N on earliness in these experiments are very apparent.

In N-sufficient field plantings in Arizona, the relative fruitfulness at 75 days was 6 to 7 bolls per 100 g fresh weight of stems and leaves (Mauney, unpublished). However, as the plants continued to set bolls and the growth rate was reduced after 75 days, the ratio increased to more than 9 at 100 days. Thereafter, vegetative regrowth reduced the ratio to 6 to 7 at 130 days, after which the ratio increased once again to greater than 9 at 150 days (see Chapter 16).

These two examples from the greenhouse and field show that an index such as relative fruitfulness is not a static quantity during the season. The comparison of low-N and high-N cotton plants therefore depends strongly upon the age and

Table 2. Dry weights and partitioning of cotton plants grown on two levels of N nutrition. (Data are means of 12 plants, 6 from each of two cultivars—Acala SJ-4 and Paymaster 909. Fruiting index is defined as boll dry weight as a percent of total plant dry weight).

Days after planting	Dry weight per plant (g)		Fruiting index (%)	
	1 mM N	5 mM N	1 mM N	5 mM N
68	8.6	21.9	6	3
96	15.3	38.7	34	25
139	24.3	56.8	41	27

yield structure of the crop. For this reason, a single-harvest comparison such as that of Eaton and Rigler (1945) is inadequate. Our presentation of the data shows that low N has little effect on the number of early bolls per plant and improves partitioning of dry matter during that early boll set. However, this advantage in efficiency is lost as the season progresses. Wadleigh (1944) reported very similar results.

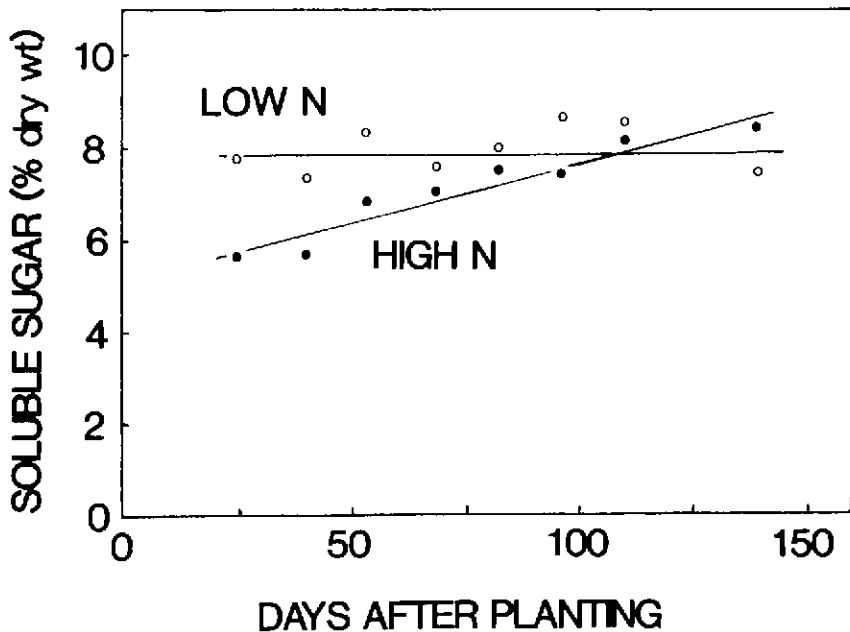

Figure 2. Soluble sugar concentrations in stems plus leaves of the cotton plants described in Tables 1 and 2. (Sugars were determined colorimetrically with the phenol-H<sub>2</sub>SO<sub>4</sub> test against glucose as the standard).



Table 3. Fruiting sites and boll retention at each fruiting branch node of plants grown on three levels of N. (Data are from Table 17 of Wadleigh, 1944. Wadleigh's designations of series A, B and D correspond to 0.56, 1.7 and 15.6 mM NO<sub>3</sub>N in the nutrient solution, respectively).

Treatment	Fruiting branch node					Total
	1	2	3	4	5	
<b>A</b>						
Flowers/plant	10.0	6.9	3.0	0.3	0	20.2
Bolls/plant	4.7	0.6	0	0	-	5.3
% Retention	47	9	0	0	-	26
<b>B</b>						
Flowers/plant	13.7	10.2	6.8	2.1	0.2	33.0
Bolls/plant	7.2	2.3	0.6	0	0	10.1
% Retention	53	23	9	0	0	31
<b>D</b>						
Flowers/plant	18.9	14.6	12.3	8.1	2.5	56.4
Bolls/plant	11.4	5.9	4.3	1.5	0	23.1
% Retention	60	40	35	19	0	41

Plants from the greenhouse experiments described earlier (Table 1) were analyzed for soluble carbohydrates. During the vegetative stage of growth, low-N plants contained considerably higher concentrations of soluble carbohydrates than high-N plants. By about 110 days after planting, however, their positions had become reversed as the early fruit load quickly drained the smaller low-N plants of their reserves (Figure 2). This inability to support all the sinks suggests that N deficiency should also increase shedding. Plant maps of Wadleigh (1944) support this deduction. Nitrogen deficiency slightly increased the percent shed at the first nodes of fruiting branches and drastically increased the percent shed at all subsequent nodes (Table 3). In terms of flower production and boll shedding, the second node of severely N-deficient plants (series A) closely resembled the third node of moderately deficient plants (series B) and the fourth node of N-sufficient plants (series D). Both plant size (number of fruiting positions) and shedding contributed about equally to the change in boll number per plant.

We have also observed that low N greatly suppresses fruiting branch development (Radin and Mauney, unpublished). This suppression resembles the cessation of growth typically observed in high-N plants, except that it occurs much earlier. The similarities in growth and shedding patterns suggest that even in "N-sufficient" plants, limitation of branch length and reduced boll retention at distant nodes along fruiting branches may be from localized N stresses caused by N partitioning among competing growth centers.

The developmental effects of N nutrition are summarized in Table 4. From this table, derived from Wadleigh (1944) and from this chapter, one can draw the

following useful generalization: N nutrition does not alter morphogenetic patterns. Examples of morphogenetic characters include node of first flower (also

Table 4. Summary of effects of N nutrition on growth and development of cotton plants.

---

<b>CHARACTERISTICS AFFECTED BY N</b>
1. Growth Rate
2. Leaf Area
3. Earliness
4. Boll Shedding
5. Seed and Lint Weight per Boll
6. Stomatal Response to Water Stress
<b>CHARACTERISTICS NOT AFFECTED BY N</b>
1. Node of First Flower
2. Node of First Open Boll
3. Flowering Interval
4. Seeds per Boll

---

time to first flower), flowering interval (both horizontal and vertical), etc. Nitrogen nutrition does alter processes which depend upon partitioning of assimilates. Examples of this type of character include growth rates of leaves and stems, boll shedding, seed and lint weight, etc. The lone response to N which does not obviously fit this pattern is stomatal response to water stress. Preliminary data (Radin, unpublished) suggest that even this response may depend upon leaf carbohydrate levels. If this suggestion should be true, then stomatal behavior would also fit the generalization.

## PROSPECTS FOR CROP IMPROVEMENT

Clearly N deficiency has several consequences, some of which can be advantageous and some of which can be disadvantageous. By limiting leaf area, slowing growth, and increasing stomatal sensitivity to water stress, N deficiency increases drought resistance (drought avoidance in the terminology of Levitt, 1972.) Because cotton is ancestrally a desert perennial, this effect of N presumably once had ecological significance—especially because desert soils are typically low in organic matter and N (West and Klemmedson, 1978). The induced drought avoidance may similarly have significance in areas of dryland culture where chronic water stress prevents attainment of the yield potential. Peterschmidt and Quisenberry (1981) identified a drought-avoiding genotype of cotton. It was superior to other genotypes in dry matter production under dryland conditions but was inferior under irrigation (Quisenberry *et al.*, 1981). It is therefore relevant

that N applications across the Cotton Belt vary with the degree of water stress expected, with much more N applied in the irrigated West than in the dryland areas of west Texas and Oklahoma (Tucker and Tucker, 1968).

The problem for an agronomist or a plant breeder is to add N to support yield, yet retain the benefits of low N on efficiency and drought avoidance. It may be possible to select for enhancement of individual characters of the N stress syndrome. The drought-avoiding genotype of Peterschmidt and Quisenberry (1981) is a good example, assuming that the selection was not inadvertently based upon differences in N status of the plants. Quarrie (1980) has also found genetic differences in drought avoidance of wheat based largely upon differences in root:shoot ratio. In corn, hydraulic conductivity has been shown to be genetically controlled (Dube *et al.*, 1975; Harris and Heath, 1981). Passioura (1972) showed that wheat plants with decreased hydraulic conductivity were better able to conserve soil moisture until grain filling. Thus, this character may be equal in importance to stomatal responses in improving dryland performance.

Altered cultural practices might also improve the suitability of a plant for its environment. Based on the preceding discussion, it seems logical that late applications of N (starting perhaps at first flower) might partially separate the positive effects of N on yield from the negative effects on drought resistance. Gardner and Tucker (1967) studied timing of N applications in irrigated cotton in Arizona. They found that late or split applications tended to increase yields even though plant size, number of flowers, and number of bolls tended to be slightly less. Recent emphasis on water conservation by withholding irrigation water during vegetative growth (Guinn *et al.*, 1981) would make timing of N applications even more critical than previously suggested. A movement toward short-season cotton for reasons of integrated pest management (Mauney *et al.*, 1972) would also emphasize the need for efficiency in the early fruiting period. Other approaches to control of N fertilization, e.g., slow-release fertilizers, combinations of conventional and slow-release fertilizers, or even foliar fertilization, have not yet been carefully explored.

## SUMMARY

Low nitrogen fertility is associated with several alterations of crop development in cotton (*Gossypium hirsutum* L.), including slower growth and smaller leaves, greater root:shoot ratio, increased earliness, greater shedding percentage, and increased drought resistance. We have identified three basic physiological responses of cotton plants to low nitrogen fertility which underlie all these effects. These three (collectively called the nitrogen stress syndrome) are: (1) decreased photosynthetic rate; (2) decreased hydraulic conductivity; and (3) increased stomatal sensitivity to water stress. Decreased hydraulic conductivity severely limits growth, allowing reserve carbohydrates to accumulate before flowering despite the lowered photosynthesis. These reserve carbohydrates are utilized

during early boll set but soon become depleted. Thus, the late yield is largely lost from N-limited plants as a result of the low photosynthetic rate. Increased stomatal sensitivity to water stress tends to promote a “water-saving” mode of drought avoidance in N-limited plants, leading to better acclimation to dryland conditions (where yield limitation by N is unimportant because of the greater yield limitation by water). Recognition of the basic physiological mechanisms underlying field behavior may allow enhancement of drought resistance and earliness, either by improved management of nitrogen fertility or by genetic selection for altered physiological responses to nitrogen.

## Chapter 11

## SALINITY AND FRUITING

James L. Fowler  
New Mexico State University  
Las Cruces, New Mexico

## INTRODUCTION

Salinity may be defined simply as the presence of excessive concentrations of soluble salts (U.S. Salinity Lab Staff, 1954). Soils are regarded as saline if they contain soluble salts in such quantities that they interfere with the growth of most crop plants. Chloride, sulfate and bicarbonate salts of sodium, calcium and magnesium contribute in varying degrees to soil and water salinity.

Millions of hectares of land throughout the world are too saline to produce economic crop yields, and more land becomes nonproductive each year because of salt accumulation. Salinity problems in agriculture are usually confined to arid and semi-arid regions where rainfall is not sufficient to transport salts from the plant root zone. Salinity is a hazard on about half of the irrigated area of the western United States (Wadleigh, 1968) and crop production is limited by salinity on about 25 percent of this land (Thorne and Peterson, 1954; Bower and Fireman, 1957; Wadleigh, 1963). Soil salinity problems may also occur on non-irrigated croplands and rangelands. For example, Carter *et al.* (1964) reported that approximately 25 percent of the non-irrigated land in the lower Rio Grande valley of Texas is highly saline. The saline soils are interspersed among non-saline soils, so that farmers must plant and cultivate saline areas along with non-saline areas. Thus, farmers may actually harvest only about 75 percent of the land area they farm.

Salinity of irrigation water is also a problem and is becoming an increasingly serious one as water of less and less desirable quality is exploited for irrigation and as greater intensity of water use leads to degradation. Similarly, river waters have become more highly regulated. Water evaporating from reservoirs concentrates the salts, and new irrigation projects aggravate the salinity problem for downstream users.

Several of the major cotton producing regions of the United States are located in the semiarid and arid southwestern and western states where saline soils and irrigation waters are common. In these regions, salinity impacts directly upon cotton production by reducing yield and requiring the use of costly management practices to maintain productivity.

## GENERAL PLANT RESPONSE TO SALINITY

The primary salinity factors influencing plant growth are the kind and concentration of salts in the soil solution (or irrigation water). Most plants respond to salinity as a function of the total salt concentration or osmotic potential of soil water without regard to salt species present (Maas and Hoffman, 1977). Where ratios of the predominate soluble ions are extreme, specific ion toxicities may occur. Some herbaceous plants and most woody species are susceptible to specific ion toxicities. In some cases, salinity induces nutritional imbalances or deficiencies causing decreased growth and plant injury for which osmotic effects alone cannot account.

Although salinity affects plants in many ways physiologically, overt injury symptoms seldom occur except under extreme salination (Mass and Hoffman, 1977). Salt-affected plants usually appear normal, although they are stunted with plant parts such as leaves, stems and fruits usually smaller than normal, and may have darker green leaves which, in some cases, are thicker and more succulent. The most common salinity effect is a general stunting of plant growth. As salt concentrations increase above a threshold level, both the growth rate and ultimate size of most plant species progressively decrease. Not all plant parts are affected equally. Top growth is often suppressed more than root growth. Salinity may also increase the leaf:stem ratio and may affect vegetative growth more than yield of seed or fiber. Salinity often restricts plant growth severely without the development of any acute injury symptoms. When this happens, it may lead to considerable loss of yield and the grower may not realize that salinity is responsible.

## COTTON TOLERANCE TO SALINITY

The only agronomically important criterion for establishing salt tolerances of crops is the effects on economic yield. Salinity for the purposes of establishing crop tolerance is conveniently measured by determining the electrical conductivity (EC) in millimhos/cm at 25C of irrigation drainage water or soil extract (U.S. Salinity Lab Staff, 1954). One millimho is the approximate equivalent of 640 ppm salt. Four divisions for classifying salinity tolerance of crops have been established based upon the electrical conductivity of the soil extract ( $EC_e$ ) and the effect of salinity upon crop yield. These classifications are sensitive, moderately sensitive, moderately tolerant and tolerant. Cotton is classified as a salt tolerant crop (U.S. Salinity Lab Staff, 1954; Bernstein, 1955; Ayers and Westcot, 1977). A threshold salinity level at which initial yield decline has been observed is 7.7 millimhos ( $EC_e$ )/cm with a 50 percent reduction in yield observed at an  $EC_e$  of 17.0 millimhos (Ayers and Westcot, 1977).

The range of genetic variability to salt tolerance among species of *Gossypium* is apparently unknown. Among upland cotton varieties (*G. hirsutum*) tested by the

U.S. Salinity Laboratory, according to one report (Bernstein, 1955), most had similar salt tolerance with the exception of Hopi-Acala 46-124 and Arizona 124-68 which tended to tolerate higher salinities than a group characterized by Acala 4-42. From another study at the U.S. Salinity Laboratory, Hayward and Wadleigh (1949) reported a wide variation in relative salt tolerance among 12 varieties evaluated in sand culture over a 3-year period. The American-Egyptian (*G. barbadense* L.) varieties, SXP, Amsak and Sakel, and the upland varieties, Acala 1517 and Acala P-18, had consistently good salt tolerance. Stoneville strains also produced good relative yields on saline cultures but always displayed noticeable symptoms of salt toxicity. Other strains evaluated—Coker 100-6, Deltapine 14 and Delfos 9252—did not show any distinctive degree of salinity tolerance. Hayward and Wadleigh (1949) also stated that the long staple Egyptian types were more tolerant to salt than the upland types.

In a more recent screening test of seven upland varieties, genotypic differences in salt tolerance were also observed (Lauchli *et al.*, 1981). Differences in tolerance at various growth stages were also readily apparent as Paymaster 303 and Acala SJ-2 were relatively salt tolerant during germination and seedling emergence, while Acala SJ-5, Coker 310, Stoneville 825 and Tamcot SP37H displayed poor germination and low emergence at high salinities. At later stages of vegetative growth, Acala SJ-2 and Stoneville 825 were two of the most tolerant varieties with Deltapine 61 and Coker 310 showing the least tolerance.

## SPECIFIC EFFECTS OF SALINITY ON COTTON

Very little data appear in the literature on the specific effects of salinity on the fruiting of cotton. Some work has apparently been done with reference to yield and salt tolerance of specific varieties which is not readily accessible in the literature.

In most crops studied, fruit yields tend to parallel declining vegetative growth as salinity increases. In studies with cotton, exceptions have been noted, however. Bernstein and Hayward (1958) reported a marked decline in vegetative growth and vigor of cotton in response to increasing levels of salinity with little effect on yield of seed cotton. Ehlig (1969) observed that salinity reduced cotton plant height, number of main stem nodes and internode length but did not always reduce the number of flowers. These reductions in vegetative growth without corresponding reductions in reproductive growth undoubtedly occurred at salinity levels lower than the threshold level listed by Ayers and Westcot (1977) and Maas and Hoffman (1977) for the initial yield decline in cotton of 7.7 mmhos/cm ( $EC_c$ ). The salinity threshold for the initial yield reduction in cotton probably depends on several factors, however, as Thomas (1980) observed an initial yield decline on soils with mean  $EC_c$ 's in the range of 3 to 5 mmhos/cm. This discrepancy is apparently due to the differences in the experimental conditions under

which the values were obtained (Maas and Hoffman, 1977; Thomas, 1980) but also may reflect differences in the level of salt tolerance of the experimental plant material. The level of salinity at which yield reduction occurs may be influenced by other environmental conditions such as temperature (Magistad *et al.*, 1943) and humidity (Nieman and Paulsen, 1967) as well as the composition of solutes in the soil solution (Callahan and Joham, 1974).

Decreases in fruit yield associated with salinity are usually the result of decreases in both fruit number and size (Bernstein and Hayward, 1958). Also, as salinity has a retarding effect on vegetative growth, it would be expected to delay the onset of flowering. But by reducing vegetative growth in a crop with an indeterminate fruiting habit, such as cotton, salinity may increase earliness of crop maturity, thereby hastening final harvest (Bernstein and Hayward, 1958; see also Chapter 7).

## PHYSIOLOGICAL FUNCTIONS OF COTTON INFLUENCED BY SALINITY

Certain physiological functions of cotton are affected by salinity. The effects of salinity on these functions may indirectly affect fruiting of cotton. Transpiration, and thus water requirement, of cotton decreased progressively with increasing concentrations of NaCl, NaNO<sub>3</sub>, KCl, KNO<sub>3</sub>, CaCl<sub>2</sub> and Ca(NO<sub>3</sub>)<sub>2</sub> salts in the soil (Meyer, 1931; Hoffman *et al.*, 1971).

The photosynthetic functions of leaves is altered in several ways when plants are grown in saline conditions. Boyer (1965) observed a 25 percent reduction in both photosynthesis and respiration in cotton grown at NaCl levels corresponding to -8.5 bars. Resistance to CO<sub>2</sub> diffusion did not increase at high solute concentrations. On the other hand, Gale *et al.* (1967) could not repeat Boyer's results. They concluded from their data that salinization to -4.5 bars increased stomatal resistance to CO<sub>2</sub> and water but that the major reason that salinity reduced photosynthesis was its effect on the light reactions of the process.

Hoffman and Phene (1971) observed a decrease in both photosynthesis and transpiration when salinity was increased. This would indicate an effect of the salinity on stomatal aperture. Their observation that salinized plants had lower water-use-efficiency would indicate a greater effect of salinity on CO<sub>2</sub> uptake than on transpiration.

The work of Longstreth and Nobel (1979) showed that salinity can increase both stomatal and mesophyll resistance in cotton leaves and that the effect is reversible. They found that cotton leaves grown in saline medium had more succulent leaves. That is, the ratio of mesophyll cell area to leaf area ( $A^{\text{mes}}/A$ ) was greater under saline conditions. This increase in  $A^{\text{mes}}$  partially compensated for the great decrease in CO<sub>2</sub> uptake per cell. Thus, when salinity was less than 0.1 molal NaCl, no change in mesophyll resistance was observed. Therefore, the



conditions of the experiment and the length of time the plants had for compensation might be expected to produce differing results.

## SUMMARY

The physiology of cotton response and adaptation to salinity is relatively unexplored. The high salt tolerance of most varieties of cotton evaluated suggests that this factor in itself may be the reason why the physiology of salt adaptation in cotton and the specific effects of salinity on cotton functions have not been studied more thoroughly. Another factor involved is that much of the research effort directed toward salinity problems has been expended in manipulating the environment—the soil and water—to suit the crop. However, reclamation and drainage projects are exceedingly expensive operations in terms of dollars, energy and good water. As competition for water increases from the non-agricultural sectors of the economy, pressure will increase on the agricultural community to increase the efficiency of water use and exploit lower quality waters for agricultural purposes. And, as the world population grows, the demand for increased agricultural production will force us into utilizing less desirable land and water resources in an effort to increase production. The impetus for selecting and breeding salt-tolerant crops is already upon us. Development of salt-tolerant crops should be reinforced by physiological research into the nature of salt tolerance in plants. Cotton as well as other salt tolerant crops are prime candidates for such breeding programs; and cotton, undoubtedly, will be one of the crops selected for use under moderate levels of salinity.

## Chapter 12

# HORMONAL RELATIONS DURING REPRODUCTION

Gene Guinn  
USDA-ARS  
Phoenix, Arizona

## INTRODUCTION

Plant growth substances have been implicated in the regulation of flower initiation, fruit abscission, and cutout. Many of the results are inconclusive, inconsistent or contradictory, especially in the case of flower initiation. Factors that regulate fruit retention or abscission are more firmly established. Publications on abscission are extremely numerous, but there is still some uncertainty about the roles of abscisic acid, gibberellins and cytokinins. Beyond the fact that an increasing percentage of fruit abscission is one aspect of cutout, very little has been published on the hormonal regulation of cutout. In this chapter I will attempt to review the current knowledge of flower initiation, fruit abscission, and cutout, and point out some areas that need additional research.

## FLOWER INITIATION

Information on hormonal control of flower initiation in cotton is almost nonexistent. Most of the research has been done with flower initiation in photoperiodic plants, or plants that require vernalization to flower. Although ancestral cottons are short-day plants (Mauney and Phillips, 1963), most of the cultivated cottons are day-neutral and, therefore, could be classed as self-inductive. Perhaps because most cultivated cottons flower readily, few investigators have included cotton in their research on floral induction. Halevy (1972) did review the literature on the roles of phytohormones in the regulation of flowering of self-inductive plants, but he was concerned only with horticultural crops and did not mention cotton. He concluded that there is no reason to assume that the very complicated and variable process of flowering is regulated by a single, universal, and unique organ-forming hormone.

Mauney (1966) investigated the effects of day and night temperatures and photoperiod on flowering of a day-neutral cotton but did not investigate possible hormonal effects. Flowering was induced at a lower node by low night temperatures or by low day temperatures when the night temperature was 32C. Flowering

also occurred at lower nodes under 14-hr than 8-hr days, perhaps because of increased photosynthate supply. The promotive effect of low night temperatures also suggests an effect of carbohydrate availability because dark respiration would be greater at the higher temperatures. Hesketh and Hellmers (1973), however, found that increased  $\text{CO}_2$  did not lower the position of the first fruiting branch, but raised it. They concluded that floral initiation is a bit more complex than can be explained on the basis of photosynthate supply.

Searle reviewed the physiology of flowering in 1965. At that time much effort had been given to proving the existence of a postulated flowering stimulus named "florigen." The production of florigen was presumed to be controlled by the balance between the red and the far-red absorbing forms of phytochrome. Because certain nucleic acid antimetabolites inhibited flowering, florigen was thought to act in gene activation or gene derepression. Chailakhyan (1968) suggested that florigen consists of two groups of hormonal substances: (a) gibberellins, which induce stem formation and growth, and (b) anthesins, which induce flower initiation. Neither anthesins nor florigens have ever been isolated or identified; evidence for their existence is based on experiments designed to show transmission of the flowering stimulus from induced to noninduced tissue. According to Chailakhyan (1968), gibberellins stimulate stem growth in both long-day and short-day plants, but stimulate flowering only in long-day species.

So many exceptions can be found that it is dangerous to generalize about the roles of phytohormones in flower induction. In the preface of a book on the induction of flowering that he edited, Evans (1969) commented, "Such diversity is only too apparent in the flowering processes of higher plants, to the frustration of reviewers and to the confusion of readers." Therefore, it is probably futile to use results obtained with other plants in an attempt to predict the effect of various hormones on flowering in cotton.

Zeevaart (1976) reviewed the physiology of flower formation and stated that all efforts to identify the floral stimulus have met with failure. He reviewed the effects of ethylene, cytokinins, gibberellins and abscisic acid (ABA). The effects of each of these hormones varied with different plants.

A few workers have investigated the effects of gibberellins (GA) on flowering in cotton. Dransfield (1961) found that five applications of 10 ppm GA, approximately 7 days apart, increased the number of flowering points, but higher concentrations decreased the number of flowering points, especially when applied early. The higher the concentration, the greater was the inhibition. A single application of 100 ppm GA decreased the number of flowering points. He concluded that GA application is of no practical benefit to cotton in northern Nigeria.

Jackson and Fadda (1962) obtained similar results. An application of 100  $\mu\text{g}$  of GA per plant retarded flowering of young plants. Application of 100 and 500  $\mu\text{g}$  of GA per plant 34 days after planting delayed flowering by 6 and 11 days, respectively. At 61 days after planting most of the differences had disappeared; the authors recorded averages of 6.7, 8.6, 6.9 and 1.7 squares per plant on plants

that had been treated with 0, 10, 100, and 500  $\mu\text{g}$  of GA, respectively.

Ethylene may stimulate flowering of cotton. During two seasons Hall *et al.* (1957) observed a field of cotton that was near a polyethylene plant in Texas. Ethylene that escaped from the plant caused malformation of leaves, loss of apical dominance, and earlier and more profuse flowering than normal. Plants produced up to 400 squares each, but most of the squares abscised because ethylene was continually present as an air pollutant. The profuse squaring may have resulted, at least in part, from a lack of any boll load. In other tests, they noted that cotton plants did not produce a significant amount of ethylene until initiation of the reproductive stage. Evans (1969, p. 475) noted that, under non-inductive photoperiods, "Flowering in several short-day plants can be evoked by a temporary stress to growth—by drought, transplanting, nutrient stress, low temperatures, or the application of growth retardants or abscisin." It appears to be a rather common belief in irrigated areas that flowering of cotton can be induced or stimulated by withholding water early in the growing season. A preflowering stress has been observed to increase subsequent rates of blooming (Singh, 1975; Mauney *et al.*, 1980; Kittock, personal communication) and yield (Singh, 1975; El-Zik *et al.*, 1977). Water deficit increases ethylene production in petioles (McMichael *et al.*, 1972) and abscisic acid content of leaves (Milborrow, 1974). Although these results are suggestive, more research is needed to establish a causal role for ethylene and ABA in the induction of flowering in cotton.

Drought may sometimes increase early flowering through an effect on insects. Mauney *et al.* (1980) reported that early flowering was increased about 25 percent when the first post-emergence irrigation was delayed by two weeks. Plant bug populations were lower and square shedding was less in the plots in which irrigation was delayed. They also measured total fruiting positions and found that they were not increased by delaying the first irrigation (unpublished). They concluded that reduced insect damage was the major cause of the increased rate of early flowering in stressed plots.

## FRUIT ABSCISSION

Once the cotton plant starts producing flower buds (squares) it usually continues doing so until cutout (see Chapter 2). In most cases a careful examination of plants that have "gone vegetative" will reveal that they have not reverted to producing monopodial (vegetative) branches. Rather, they are still producing sympodial (fruiting) branches, but a large percentage of the squares or young bolls are shedding. The internodes may be longer and the leaves larger than those of normally fruited plants, and the plants themselves may be taller. They appear vegetative because few squares and bolls are present at the fruiting sites. However, poor soil conditions and extremely high temperatures may cause some cultivars to actually revert to the production of monopodial branches in Pakistan (M.N.A. Malik, personal communication). I have never observed this kind of

reversion from sympodial to monopodial branch production in field-grown cotton in Phoenix even at temperatures up to 47C (117F). Excessive shedding of squares and bolls is the most likely situation in plants that have "gone vegetative."

### ENZYMES INVOLVED IN ABSCISSION

Most of the research on the biochemistry and anatomy of abscission has been conducted with explants (small sections of stem plus petiole tissue with leaf or cotyledon blades removed).

Enzymic dissolution of the middle lamella and portions of the primary wall of cells in the abscission zone usually precedes abscission (Webster, 1973). Insoluble pectates, mainly calcium pectate, in the middle lamella are hydrolyzed to pectic acid. Increased pectinase activity usually precedes abscission (Yager, 1960; Zaitlin and Coltrin, 1964; Morr , 1968; Riov, 1974) but pectin esterase apparently has little or no effect (Ratner *et al.*, 1969; Moline *et al.*, 1972). Although pectinase activity may be sufficient to cause abscission (Morre, 1968), cellulase activity in the abscission zone also increases prior to abscission in most plants (Abeles, 1969; Ratner *et al.*, 1969; Lewis and Varner, 1970). These two enzymes, pectinase and cellulase, digest the middle lamella and soften portions of cell walls of cells in the abscission zone, thereby greatly weakening the petiole or peduncle at that point (Morr , 1968; Webster, 1973). Separation may not occur immediately even after break strength declines to a minimum (Morr , 1968), probably because of vascular tissue that has to be broken by mechanical forces. Enlargement of cells on the proximal side (the stem side of the abscission zone) and shrinkage of cells on the distal side (the leaf or fruit side) cause shear and tension forces that eventually break the vascular connections (Morr , 1968; Leopold, 1971; Osborne, 1973). This may explain the observation that abscission does not normally occur during the period of drought stress and that separation does occur after plants are rewatered (Osborne, 1974). Increased turgor and resultant swelling of proximal cells could increase the tensile forces on vascular elements through the abscission zone and cause them to break.

Evidence indicates that pectinase and cellulase are synthesized *de novo* before abscission (Abeles, 1968; Ratner *et al.*, 1969; Lewis and Varner, 1970; Abeles *et al.*, 1971; Riov, 1974) and that the cellulase is different from cellulase already present in cells (Lewis and Varner, 1970; Reid *et al.*, 1971; 1974). Because the sites of action of pectinase and cellulase are the middle lamella and the primary cell wall, and the site of synthesis of these enzymes is within the plasmalemma, they must be secreted before they can cause abscission (Morr , 1968; Abeles and Leather, 1971; Abeles *et al.*, 1971b; Gilliland *et al.*, 1976; Addicott and Wiatr, 1977). If pectinase and cellulase are required to dissolve the middle lamella and weaken the primary cell wall of cells in the abscission zone, as appears to be the case, then an explanation of inhibition or promotion of abscission by environmental and hormonal factors must eventually tie these factors to regulation of synthesis, secretion and activity of these hydrolytic enzymes.

## HORMONAL EFFECTS

Plant hormones apparently interact to control abscission. Auxin generally inhibits abscission (but there are exceptions); ethylene promotes abscission; and ABA, cytokinins and gibberellins have variable effects, depending upon concentration, site of application and tissue involved. In the following discussion, the hormones will be considered separately insofar as possible. However, because of interactions, it will be necessary to mention more than one hormone under each heading.

**Auxins**—It has been known for many years that auxins such as indole-3-acetic acid (IAA) and naphthalene acetic acid (NAA) inhibit abscission when applied to petiolar stumps of explants (Addicott and Lynch, 1955). However, when applied to the stem portion of the explant (proximal side of the abscission zone), IAA stimulated, rather than inhibited, abscission. This response caused Addicott and co-workers to propose the auxin-gradient theory of abscission control (Addicott *et al.*, 1955). According to this theory, the relative concentrations of auxin on each side of the abscission zone (the auxin gradient) are more important than the absolute auxin concentration. Rubinstein and Leopold (1963) found that time of auxin application was just as important as concentration. When they applied NAA immediately after deblading, the NAA inhibited abscission; if they waited 6 hours or longer, however, NAA then promoted abscission. Chatterjee and Leopold (1963) extended these results to IAA and the synthetic growth regulators, 2, 4-dichlorophenoxyacetic acid (2, 4-D), 2,4,5-trichlorophenoxyacetic acid (2,4,5-T) and others. These data provided the basis for the "two-stage" theory of auxin action. (For a discussion of the auxin-gradient, the two-stage, and other theories to that time, see review by Carns, 1966).

The discoveries by Morgan and Hall (1962, 1964) that 2,4-D and IAA stimulate ethylene production in plant tissue provided a basis for explaining the observations that abscission is regulated by the auxin gradient and that auxins can either inhibit or promote abscission, depending upon site and time of application. Abeles (1967) explained the auxin-gradient effect on the basis of auxin stimulation of ethylene production, the polar movement of auxin, and the opposing effects of auxin and ethylene in inhibiting and promoting abscission, respectively. When applied distally, auxin moves into the abscission zone and inhibits abscission. When applied proximally, however, auxin is unable to move rapidly into the abscission zone (against its normal direction of polar movement). Ethylene can move in any direction and its promotive effect becomes dominant when auxin is applied to the proximal side of the abscission zone. The time-dependent effect of auxin in either inhibiting or promoting abscission was reviewed and explained by Leopold (1971). During stage I, the period during which auxin inhibits abscission, the tissue is relatively insensitive to ethylene. After deblading or excision, the tissue soon becomes sensitive to ethylene. During this stage II, auxin no longer inhibits abscission but may promote it because the applied auxin stimulates

ethylene production, and the tissue is now sensitive to the abscission-promoting effects of ethylene. Auxin tends to prolong stage I when applied soon enough.

Despite the vast amount of research that has been done on auxin, the exact mechanism by which it inhibits abscission has not been elucidated. Treatment with auxin prevented the increase in the specific cellulase that apparently causes abscission (Abeles, 1969; Ratner *et al.*, 1969; Lewis and Varner, 1970), but it is not clear whether the effect was due to a direct inhibition of synthesis of abscission-promoting cellulase or to an indirect effect (e.g., prevention of changes that result in senescence). The fact that the increase in cellulase activity was also suppressed by application of cycloheximide (Abeles, 1969; Ratner *et al.*, 1969) indicates that the increased cellulase activity was due to synthesis of new enzyme rather than to activation of pre-existing enzyme. Although speculative, another mechanism by which auxin might inhibit abscission is through an effect on membranes. Auxin has been reported to maintain membrane integrity and selective permeability (Sacher, 1957; Abeles, 1968; Helgersson *et al.*, 1976) and, therefore, may tend to prevent secretion of pectinase and cellulase through the plasma membrane. There is no direct experimental evidence to support such an hypothesis, however.

**Ethylene**—Although its role as a natural regulator of abscission was questioned in the 1950's, ethylene is now firmly established as a potent abscission-promoting hormone. Two mechanisms of action have been established: (a) slower transport and increased destruction of auxin, and (b) stimulation of synthesis of pectinase and cellulase in the abscission zone.

Morgan and Hall (1962), Hall and Morgan (1964), and Morgan *et al.* (1968) showed that ethylene stimulates IAA-oxidase activity and decarboxylation of IAA in cotton. Morgan and co-workers also showed that ethylene slows auxin transport (Morgan and Gausman, 1966; Morgan *et al.*, 1968; Beyer and Morgan, 1969, 1970, 1971) and that inhibition of auxin transport promotes abscission (Morgan and Durham, 1975). Because auxin prevents or delays abscission, both the destruction and the slowed transport of auxin should promote abscission by decreasing the amount of auxin that reaches the abscission zone.

Perhaps an even more direct action of ethylene is its stimulation of synthesis of pectinase (Riov, 1974) and cellulase (Horton and Osborne, 1967; Abeles, 1968, 1969; Ratner *et al.*, 1969; Reid *et al.*, 1971) in the abscission zone. Not only does ethylene stimulate the synthesis of cellulase, it also promotes the release or secretion of cellulase through the plasma membrane and into the cell wall (Abeles and Leather, 1971; Abeles *et al.*, 1971). Without such secretion the enzyme could not, of course, digest the cell wall.

Thus, ethylene promotes abscission in at least two ways. It decreases the auxin content of the abscission zone, and it stimulates the synthesis of enzymes that weaken the middle lamella and cell wall.

**Abscisic Acid (ABA)**—The actions of ABA and ethylene are similar in many respects. ABA slows growth (Rehm and Cline, 1973), hastens senescence (De la Fuente and Leopold, 1968), decreases basipetal (toward the base) movement of IAA (Chang and Jacobs, 1973), promotes ethylene production and an increase in cellulase activity (Craker and Abeles, 1969; Jackson and Osborne, 1972), and may cause abscission (Craker and Abeles, 1969; Davis and Addicott, 1972; Cooper and Horanic, 1973; Varma, 1976). These similarities caused Addicott (1970) to suggest that ABA might function as a “non-volatile ethylene” in abscission.

Even though ABA was isolated and purified on the basis of its ability to stimulate abscission, its importance as a natural regulator of abscission has been questioned. Milborrow (1974b) reviewed the evidence to 1974 and concluded that ABA is not closely involved in the regulation of leaf abscission but probably does regulate fruit abscission. More recent evidence has cast doubt on its role as a direct regulator of fruit abscission. The situation is complicated by the fact that ABA can stimulate ethylene production in at least some tissues (Craker and Abeles, 1969; Abeles *et al.*, 1971; Jackson and Osborne, 1972; Sagee *et al.*, 1980). Therefore, its effects could be indirect (through increased ethylene) rather than direct. Some evidence suggests that ABA does have direct effects that are not dependent upon increased ethylene production. Craker and Abeles (1969) reported that ABA increased cellulase activity in both bean (*Phaseolus vulgaris* L.) and cotton explants above that caused by a saturating level of 10 ppm ethylene. Further, they found that ABA caused cellulase activity to appear about 4 hours sooner than with ethylene alone in bean, but not in cotton, explants. Cooper and Horanic (1973) used low pressures to remove ethylene from treated citrus. Hypobaric pressures prevented the fruit drop that normally occurs after spraying the fruit with cycloheximide, thereby implicating ethylene in the abscission induced by cycloheximide. However, hypobaric pressures did not prevent fruit drop after treatment with ABA, indicating that ABA did not depend upon ethylene to cause abscission. However, results obtained by Sagee *et al.* (1980) with citrus (*Citrus sinensis* L. Osbeck) leaf explants provided convincing evidence that ABA promoted abscission by stimulating ethylene production in that tissue. The addition of aminoethoxyvinyl glycine (AVG), an inhibitor of ethylene biosynthesis, prevented the increase in cellulase and polygalacturonase activity, and prevented a stimulation of abscission by ABA. AVG did not prevent an increase in the activity of these enzymes or of abscission when ethylene was supplied, thus indicating that the inhibition by AVG was specifically due to its effect in preventing ethylene biosynthesis. ABA stimulated ethylene production, cellulase and polygalacturonase activity, and abscission only in the absence of AVG.

The role of ABA in cotton boll abscission remains controversial. Dale and Milford (1964) and Cognée (1975) questioned the effectiveness of ABA in causing boll shedding because application of boll extract (Dale and Milford) or ABA (Cognée) did not stimulate abscission in their tests. Application of 2 or 10  $\mu\text{g}$  of



ABA to the calyx cup the day after anthesis caused no change in abscission rate (Cognée, 1975). Addition of 6.6  $\mu\text{g}$  of ABA to the calyx cup stimulated abscission only when plants were stressed by a water deficit (Guinn, unpublished). In contrast, Varma (1976a) reported a stimulation of abscission by much less ABA, 0.66 and 0.13  $\mu\text{g}$  per boll. Because ultraviolet light causes a rapid destruction of ABA (Johnson and Ferrell, 1982), it may be broken down before it is absorbed. To decrease this possibility, Guinn (unpublished) injected 25  $\mu\text{l}$  of 1 mM ABA directly into 3- and 4-day-old bolls. Injection of ABA caused no more abscission than the solvent alone (4% methanol in water). Most of the evidence for a role of ABA in stimulating boll abscission is either circumstantial or was obtained with explants.

**Gibberellins**—Gibberellins have been reported to increase abscission (Carns *et al.*, 1961; Valdovinos and Ernest, 1967; Wittenbach and Bukovac, 1973; Morgan and Durham, 1975; Varma, 1976; Chatterjee, 1977) and conversely, to decrease abscission (Walhood, 1957; Carns *et al.*, 1961; Bhardwaj and Dua, 1972; Bhardwaj *et al.*, 1975; Varma, 1976). In general, GA appears to promote abscission of explants, except at low concentration applied proximally to the abscission zone (Carns *et al.*, 1961), and to retard abscission of intact fruits (review by Addicott, 1970; Varma, 1976). These apparently conflicting effects probably result from indirect effects of GA, some of which may promote, and others retard, abscission. Gibberellins may retard abscission of intact fruit by mobilizing nutrients to that fruit and by stimulating growth (Addicott, 1970). When Walhood (1957) applied GA directly to some cotton fruits, the treated fruits did not abscise, but untreated fruits on the same plant showed increased abscission. When Johnson and Addicott (1967) treated all fruits on a plant with GA, the treatment did not increase retention. These results suggest an increase in the competitive ability of GA-treated cotton fruits. Such a mechanism could not operate in explants, and other effects of GA might then stimulate abscission. Two such effects are the stimulation of ethylene production by GA observed by a few workers (cf. review by Abeles, 1973) and the enhancement of ethylene action (Morgan and Durham, 1975). Another consideration is the fact that there are many gibberellins and they may not all have the same effects.

Most results suggest, however, that GA retards abscission of young cotton bolls. Walhood (1957) was able to increase boll set by treating with GA. Bhardwaj and Dua (1972) found unusually low concentrations of auxins and gibberellins in seeds of 'H 14', a high-shedding cultivar. Application of GA<sub>3</sub> alone or with IAA or IAA and kinetin even caused retention of bolls that developed from emasculated flowers (Bhardwaj *et al.*, 1975). Although GA promoted abscission of buds and boll explants, it retarded the shedding of intact bolls and counteracted the abscission-promoting effect of applied ABA. According to Varma (1976a), GA was more effective than naphthalene acetic acid (NAA) in counteracting the effect of ABA. In contrast, Cognée (1975) found that NAA was completely ineffective in preventing boll abscission; only gibberellin or mixtures containing

*gibberellin* were effective. *Gibberellin* content remained low in bolls destined to abscise and increased in retained bolls (Cognéc, 1975). Rodgers (1981c) reported maximum *gibberellin* activity at about 2 and 15 days after anthesis, ages at which he found relatively little boll abscission (Rodgers, 1980a).

**Cytokinins**—The role of cytokinins in regulating abscission appears to be indirect. They may either inhibit or promote abscission, depending upon time and site of application (cf. review by Addicott, 1970). Cytokinins delay or prevent senescence and promote the ability of an organ to compete for metabolites (Letham, 1967). These effects are probably related because the ability to accumulate the metabolites necessary for growth would tend to prevent senescence. Because senescence increases the sensitivity of an organ to the abscission-promoting effects of ethylene (De la Fuente and Leopold, 1968; Leopold, 1971), any hormone that prevents senescence should also prevent or retard abscission. Bhardwaj *et al.* (1975) suggested that seeds promote boll retention through their production of auxins, *gibberellins* and cytokinins.

Exogenous applications of cytokinins can promote, rather than retard, abscission. Varma (1976a) reported that cytokinin treatments promoted boll abscission except those applied directly to the abscission zone, which decreased boll shedding. These results agreed with earlier results obtained with explants of bean by Osborne and Moss (1963) who interpreted these results as indicating that mobilization of nutrients away from the abscission zone would cause senescence there and lead to abscission.

Rodgers (1981b) measured cytokinin activity in retained and abscised bolls. Retained bolls contained slightly higher concentrations of cytokinin activity at 7 and 10 days after anthesis than abscised bolls. Retained bolls contained much more cytokinin per boll because they were much larger than abscised bolls. He postulated that, because cytokinins are involved in mobilization of metabolites, weak fruits do not have as much capacity for cytokinin synthesis or accumulation as strong fruits. Therefore, they are not able to compete as well for nutrients and do not grow as much as strong fruits. Slow growth is typical of bolls that are destined to abscise (Cognéc, 1975; Rodgers, 1980a).

## OTHER SUBSTANCES

Senescence usually precedes abscission (Abeles *et al.*, 1968; Burg, 1968; Leopold, 1971). An increase in ethylene production accompanies senescence, but it is not clear which is cause and which is effect. Apparently, an increase in ethylene production can both cause (Burg, 1968; Abeles *et al.*, 1971b; Chatterjee and Chatterjee, 1972; Mayak *et al.*, 1977) and result from (Hulme *et al.*, 1968; Osborne *et al.*, 1972; Beutelmann and Kende, 1976) aging and senescence. A loss of membrane integrity coincides with senescence (Osborne *et al.*, 1972; Ferguson and Simon, 1973; Beutelmann and Kende, 1976). Osborne *et al.* (1972) obtained evidence that the loss of membrane integrity stimulated ethylene evolution and abscission. They obtained a material from aqueous diffusates from senescent

petioles and leaf blades that stimulated ethylene evolution by, and abscission of, explants. This substance, which they called senescence factor (SF), was acidic and nonvolatile, but did not have the chromatographic properties of ABA. This SF leaked from senescent tissue and could be extracted from green healthy tissue with ethanol. They postulated that SF is of general occurrence in plants and that it functions as a regulator of ethylene production. They also postulated that SF is normally kept separate from the site of ethylene biosynthesis by membrane compartmentation, but that wounding or senescence could modify membrane permeability and permit SF to diffuse to the site of ethylene biosynthesis. This concept, if shown to be valid, would provide an explanation for many environmental causes of abscission. Any condition which increases membrane permeability or causes loss of membrane integrity would stimulate ethylene production and abscission.

A few other workers have attempted to determine the properties of an endogenous senescence factor. Chang and Jacobs (1973) extracted a SF from *Coleus blumei* Benth, and reported that it decreased the basipetal movement of IAA in explant petioles. It also accelerated abscission. The effects and properties of their SF were similar to those of ABA. Prakash (1976) attached senescent and non-senescent petioles and leaves of *Catharanthus roseus* [(L.) G. Don] to explants. The senescent tissue promoted abscission of the explants, but nonsenescent petioles and, especially, nonsenescent leaves retarded abscission. However, membrane compartmentation of SF in nonsenescent tissue would have prevented movement of SF into the explant. Diffusion of auxin from the healthy tissue may have retarded abscission. Guinn (1977) extracted a heat-stable material from cotton bolls, after destroying membranes by freezing, which stimulated ethylene evolution in healthy bolls. Injection of various organic solvents into young cotton bolls increased leakiness of membranes (as indicated by discoloration, a water-soaked appearance, and increased electrical conductivity) and greatly stimulated ethylene evolution. The stimulation of ethylene evolution was generally proportional to membrane damage (Guinn, 1977).

In the absence of isolation, purification and chemical identification, it is impossible to know whether the senescence factors investigated by various workers are indeed the same substance. The acidic, nonvolatile SF of Osborne *et al.* (1972) and the heat-stable stimulator of ethylene biosynthesis extracted from bolls (Guinn, 1977) may have been 1-aminocyclopropane-1-carboxylic acid (ACC). Adams and Yang (1979) and Lürssen *et al.* (1979) obtained evidence that ACC is an immediate precursor of ethylene.

Various amino acids have been reported to stimulate abscission; these include alanine, glutamic acid, serine, glycine, aspartic acid, phenylalanine, methionine, glutamine and histidine (Rubinstein and Leopold, 1962; Chatterjee, 1977). At least two possible explanations can be given for the stimulation of abscission by amino acids. First, certain amino acids such as serine, cysteine, glycine and alanine promote senescence, presumably by stimulating the synthesis of proteases

(Martin and Thimann, 1972). Secondly, methionine is the precursor of ethylene in higher plants (Lieberman and Mapson, 1964; Lieberman *et al.*, 1966; Baur *et al.*, 1971; Owens *et al.*, 1971). A third possible reason suggested by Addicott (1969, 1970) implicates the amino acids in the synthesis of hydrolytic enzymes, such as cellulase, in the abscission zone. Addicott also suggested that amino acids could contribute methyl groups for the methylation of calcium pectate and thus render the pectins in the middle lamella more soluble. However, Rubinstein and Leopold (1962) found a poor correlation between methyl donor activity and stimulation of abscission.

Ascorbic acid has been investigated by a few workers, but the results appear inconsistent (cf. review of Addicott, 1970). Varma (1976a) reported that ascorbic acid decreased cotton boll abscission and counteracted the promotive effects of ABA. The inhibitory effects of ascorbic acid might be due to its antioxidant activity. Auxin can be destroyed by IAA oxidase activity. Further, the production of ethylene requires oxygen (Baur *et al.*, 1971), but, to my knowledge, it has not been shown that ascorbic acid inhibits ethylene production.

As we have seen, many substances can affect abscission, but few directly control the synthesis, secretion and activity of pectinase and cellulase in the abscission zone. Auxin, ethylene and ABA appear to be the hormones most directly involved. Other hormones and substances can affect abscission indirectly through their effects on growth, mobilization of metabolites, auxin synthesis, auxin transport, senescence and promotion of synthesis of ethylene and, possibly, ABA. The control of abscission does not reside in any one hormone, other substance, or environmental factor, but is regulated by the complex interaction of hormones, nutrients and the environment.

## CUTOUT

Strictly speaking, cotton is an indeterminate plant because it flowers and sets fruit over an extended period. However, breeders have developed cultivars that fruit early and stop growing and flowering sometime during the season. We refer to such cultivars as determinate even though, botanically speaking, they too are indeterminate. The differences between "determinate" and "indeterminate" cottons are not absolute, but cover the entire range from the most to the least indeterminate. The differences between "determinate" and "indeterminate" cottons are not absolute but cover the entire range from the most to the least at a lower node (Ray, 1972), shed fewer early squares, and require fewer days between fruiting positions on each branch and between successive branches (Namken *et al.*, 1975). As the boll load increases, fruit abscission rates increase and rates of growth and blooming slow and may eventually stop (Eaton, 1955; Ehlig and LeMert, 1973; Verhalen *et al.*, 1975; Patterson *et al.*, 1978). This hiatus in growth and fruiting is commonly referred to as "cutout". If the season is sufficiently long, growth and fruiting resume after some of the bolls open. Inde-

terminate cultivars set fruit at a more leisurely pace, and the boll load may never be heavy enough to cause the plants to cut out. Although the existence of cutout has been recognized for many years, its causes are not completely understood.

Soil, insect and climatic factors affect the genetic expression of determinacy and cutout (see Chapters 4 and 7). Ewing (1918) noted that, "It is a matter of common observation that the cotton plant will generally fruit much more rapidly and that the crop will mature earlier on sandy or loam soils than on clay soils, or on well-drained than on poorly drained land." Adequate soil moisture delays cutout; whereas, drought hastens it (Crowther, 1934a; McNamara *et al.*, 1940; Hearn, 1975). Nitrogen deficiency causes early cutout, whereas adequate nitrogen prolongs growth and fruiting (Tucker and Tucker, 1968; Hearn, 1975; see also Chapter 10).

Insects can delay cutout by decreasing the rate at which plants set bolls. Removal of squares or blooms stimulates subsequent fruiting and delays cutout. Eaton (1955) reviewed several experiments that showed stimulation of subsequent fruiting after early squares or blooms were removed. Ehlig and LeMert (1973) removed no flowers from the control plots and removed all flowers from treated plots until June 26, July 15, July 30 or August 14. Flower removal delayed boll shedding and cutout in proportion to the delay in boll loading. They concluded that fruit load, rather than high temperature or humidity, was the primary cause of low boll retention and cutout. Patterson *et al.* (1978) compared partial defruiting treatments in which they left all flowers on the plants (control) or left one flower per plant every 2, 3, 4 or 5 days. Defloration increased the number of blooms produced, decreased boll abscission and delayed cutout in proportion to the number of blooms removed. Deltapine Smooth Leaf (a relatively determinate cultivar) responded more than Acala 44-10 (a less determinate cultivar). They concluded that boll load exerts a large influence on fruiting behavior and is the major controlling factor of cutout (see Chapter 6).

Developing bolls are strong sinks for carbohydrates and nitrogen, and this competition is apparently a factor in cutout. Sink strength increases with boll age and reaches a maximum about 20 to 30 days after anthesis (Pinkhasov and Tkachenko, 1981). Bolls that were 27 days old incorporated far more radioactivity from <sup>14</sup>C-labelled leaves near the tops of plants than did 7- and 10-day-old bolls, even though the younger bolls were much closer to the source leaves. Counting from the base, mainstem source leaves were at nodes 10, 11 and 12. The bolls were at the first sympodial node of branches at mainstem nodes 5, 9 and 10 for bolls that were 27, 10 and 7 days old, respectively. The older bolls, therefore, were able to attract photosynthate from leaves that were at least 5 mainstem nodes away. Because older bolls are such powerful sinks their presence probably deprives growing points, younger bolls and roots of needed sugars.

A higher rate of photosynthesis should delay cutout by providing more sugars. Mauney *et al.* (1978) reported that enrichment of the atmosphere with CO<sub>2</sub> increased the rate of photosynthesis and delayed cutout by about 10 days. Plants

in high  $\text{CO}_2$  produced twice as many bolls as plants in normal  $\text{CO}_2$  before they cut out. Earlier work (Guinn *et al.*, 1976) had shown that plants in high  $\text{CO}_2$  used more nitrate than those in normal air, and the full benefits of high  $\text{CO}_2$  were obtained only when the supply of inorganic nutrients was doubled.

A heavy boll load might induce a nitrogen deficiency by competing for nitrogen and by restricting root growth and activity through competition for sugars. Bolls appear to be stronger sinks than roots because the presence of developing bolls greatly restricts root growth; defruiting caused almost a 3-fold increase in root weight (Eaton, 1931; Eaton and Joham, 1944). Crowther (1934a) postulated that bolls so dominated the plant that roots stopped growing and absorbing nitrogen. Thus, according to Crowther, nitrogen uptake is interrupted just when the demand is greatest. The limitation on root growth might also decrease the uptake of other nutrients and water. Thus, direct competition by developing bolls for sugars and nitrogen and indirect effects on nutrient and water uptake by roots would probably restrict the growth of shoot meristems.

Hormones have functions that should affect growth, fruiting and cutout. Auxin increases cell wall plasticity and water uptake, and these effects are probably major factors in stimulation of cell elongation by auxin (Galston and Purves, 1960). Auxin also enhances the synthesis of RNA and protein (Sacher, 1969), maintains differential permeability of membranes (Galston and Purves, 1960), increases assimilate mobilization (Patrick and Wareing, 1976), and delays senescence (Sacher, 1969). The role of auxin in suppressing abscission was discussed earlier.

Cytokinins are the most effective senescence retardants known (Letham, 1967). They promote the synthesis of RNA, protein and lipid; inhibit nuclease and protease activities; promote the transport, accumulation and retention of metabolites; promote cell division and enlargement; and delay senescence (Osborne, 1962; Letham, 1967; Skoog and Armstrong, 1970). The retardation of senescence appears more directly related to the role of cytokinins in maintaining nucleic acid and protein levels than to mobilization of metabolites (Osborne, 1962; Adedipe and Fletcher, 1971).

Gibberellins stimulate IAA production in some plants (Anderson and Muir, 1969; Jones, 1973) and this complicates the interpretation of their action. They also cause an increase in phospholipid synthesis (Koehler and Varner, 1971, 1973) that may relate to maintenance of selective permeability of membranes (Jones, 1973). Gibberellins promote substrate mobilization, cell elongation and division, and growth of dormant buds (Jones, 1973). Walhood (1957) reported that application of gibberellins to the apical buds of cotton plants in all stages of cutout was followed by an immediate resumption of growth.

Abscissic acid counteracts many of the actions of auxins, cytokinins and gibberellins. ABA inhibits the synthesis of protein, RNA and DNA; inhibits growth; and prolongs bud dormancy (Addicott and Lyon, 1969; Rehm and Cline, 1973; Milborrow, 1974). It also causes stomatal closure (Milborrow, 1974b) and, thus, should inhibit photosynthesis.

As mentioned earlier, ethylene increases abscission and, thus, probably is a factor in the increasing rate of boll abscission that occurs with increasing boll load. Ethylene also inhibits cell elongation and growth (Abeles, 1973). However, unlike ABA which prolongs bud dormancy, ethylene apparently breaks bud dormancy. Hall *et al.* (1957) reported that high concentrations of ethylene caused loss of apical dominance.

Environment and boll load probably cause hormonal changes that affect cutout. According to Ewing (1918), Balls ascribed the cessation of growth and flowering to self-poisoning. Eaton (1955) stated that, "A demonstration of the existence and mode of action of a mobile growth regulating material (anti-auxin) from developing cotton bolls would go far toward explaining some of the growth behaviors of the cotton plant." The isolation of abscisic acid from cotton bolls established the existence of such a material, because it was shown to have anti-auxin activity (Carns *et al.*, 1955). If ABA produced in bolls is translocated, or if boll load causes the production of ABA elsewhere in the plant, ABA could be an important hormone in causing cutout. Creelman and Sabbe (1976) reported that foliar application of ABA decreased terminal growth. They also stated, on the basis of Creelman's dissertation (Creelman, 1975), that boll-produced ABA is translocated to fruiting branch terminals. They postulated that the ABA activity could reduce the rate of elongation of the fruiting branch, reduce the production of fruiting sites, and be a factor in cutout.

Limitation of root growth, because of competition by developing bolls, could also affect hormonal balance. Evidence obtained with a number of plants indicates that roots produce cytokinins and, probably, gibberellins for transport to the shoot (Torrey, 1976). Roots may also affect IAA content of shoots. Guinn (unpublished) found measurable amounts of tryptophan, a precursor of IAA, in xylem sap but not in leaves of cotton. If restricted root growth results in a water deficit, ABA content of shoots may be increased, and cytokinin content may be decreased (Vaadia, 1976). A nitrogen deficit might also decrease the cytokinin and IAA content of shoots because these hormones contain nitrogen. Sattelmacher and Marschner (1978) reported that nitrogen deficiency decreased the cytokinin activity in root exudate and shoots of potato (*Solanum tuberosum* L.) plants. Conversely, a nitrogen deficit might increase ABA content of shoots. Mizrahi and Richmond (1972) reported an increase in ABA content of tobacco (*Nicotiana rustica* L.) leaves after they transferred the plants from nutrient solution to distilled water. Goldbach *et al.* (1975) showed that a nitrogen deficiency increased the ABA content of sunflower (*Helianthus annuus* L.) leaves; and Radin and Ackerson (1981) showed the same thing for cotton leaves.

From the preceding examples, we can see that there are probably complex interactions between hormones and competition for organic and inorganic nutrients. Hormonal balance can both affect and be affected by competition for organic and inorganic nutrients. Auxins, cytokinins, and gibberellins promote

growth, whereas ABA and ethylene inhibit growth, and ABA promotes bud dormancy. Ethylene also stimulates boll and, possibly, square abscission. The balance between the growth-promoting hormones on the one hand and ABA and ethylene on the other probably mediates growth, fruiting, abscission and cutout in cotton.

## SEQUENTIAL CHANGES AND INTERACTIONS

Work with other plants indicates that auxin production increases after pollination and that young developing embryos are a source of IAA (Addicott and Lynch, 1955; Crane, 1964). Dale and Milford (1964) extracted a growth promoter from cotton bolls of various ages that may have been IAA; it had Rf values similar to those for IAA in the eight solvent systems used. Their promoter was present in relatively small amounts for the first 5 days after anthesis. It then increased slightly to a small peak on day 8, declined somewhat the following 2 days, and then increased gradually to a second and higher peak 26 days after anthesis. Rodgers (1981a) estimated the auxin content of bolls (by bioassay) from anthesis until the bolls were 50 days old. He found peaks of activity at 3 and 15 days, and a smaller peak at 30 days, after anthesis (Figure 1). Auxin content of lint plus seed followed a similar pattern except that the concentration was higher. His results do not agree very well with those of Dale and Milford (1964), possibly because of differences in cultivar and environment.

Davis and Addicott (1972) determined the ABA content of two Acala cultivars as influenced by boll age and time during the season. The ABA content increased with boll age to a maximum at 10 days after anthesis, declined to a very low level at 20 days, remained at a low level until 30 days, and then increased to a second maximum at 50 days after anthesis. Rodgers (1980b) obtained similar results, although he found the highest concentration of ABA-like material on the day of anthesis. This declined to a minimum at day 3 and then increased to a second, but lower, maximum 7 days after anthesis (Figure 2) rather than at 10 days as reported by Davis and Addicott (1972). Fruit walls contained much higher concentration of ABA than lint plus seed except at 40 days after anthesis (Davis and Addicott, 1972; Rodgers, 1980).

Lipe and Morgan (1972a, 1973b) determined the rate of ethylene production in bolls of different ages. They reported (Lipe and Morgan, 1972a) that ethylene production reached a maximum on the day of anthesis and then declined to low values 4 days later. In a later paper (Lipe and Morgan, 1973b), they reported that ethylene production increased in bolls "during a period of considerable fruit abscission." Maximum rates of ethylene production either preceded or coincided with boll abscission. They noted a daily fluctuation in rate of ethylene production with the minimum rate occurring at night.

Guinn (1976a) and Guinn *et al.* (1978) noted that ethylene production by young bolls was low early in the season when boll abscission rates were low and



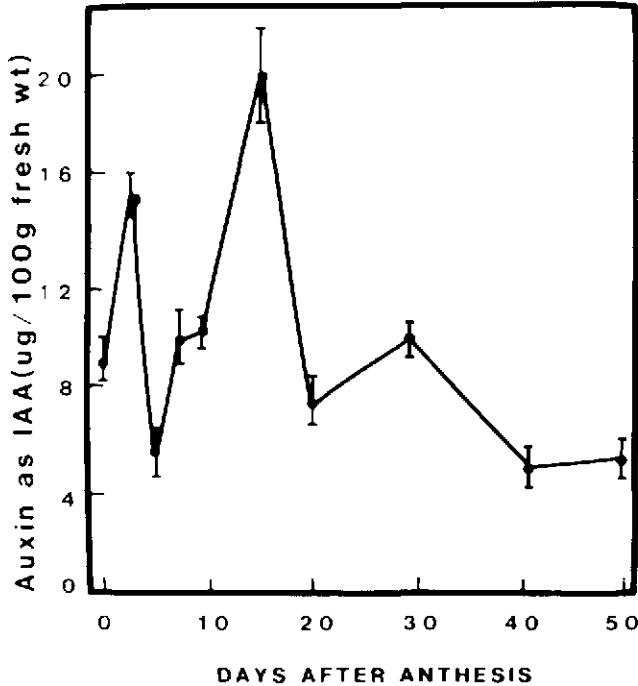

Figure 1. Variation in auxin concentration during the development of retained cotton fruit. (Each point is the average of 3 replications and the vertical lines represent  $\pm$  SE. Data of Rodgers, 1981a, by permission).

then increased during the season and between irrigations as boll abscission rates increased. Guinn (1982a) investigated the changes in ethylene evolution with boll age and in response to dim light and wounding. Peak rates of ethylene evolution occurred at 4 days after anthesis in control bolls (Figure 3) and at 6 days in bolls of plants exposed to dim light. Dim light caused a considerable increase in ethylene evolution and 100 percent abscission of bolls up to 6 days old. Both ethylene evolution and rate of boll abscission were lower in bolls that were older when exposed to dim light. Wounding, caused by slicing the bolls, induced very high rates of ethylene evolution, but the rate declined markedly with boll age. These results suggest that the capacity for ethylene production declines with boll age, and this may be one factor that causes older bolls to be more resistant to shedding. Changes in other hormones and an increase in woodiness of the peduncle are also likely factors in causing a decrease in abscission with increasing boll age.

Cognée (1975) estimated the gibberellin content of bolls for the first 4 or 5 days after anthesis. He found minimum amounts at or 1 day after anthesis and maxi-

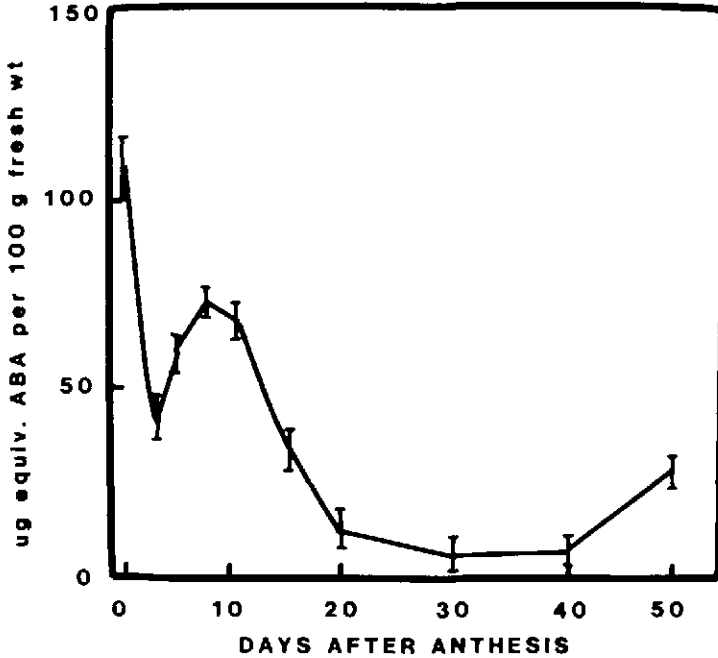

Figure 2. Changes in the concentration of ABA-like activity during the development of cotton fruit. (Data are averages of 3 tests and standard errors are shown. Data of Rodgers, 1980b. by permission).

imum amounts 2 to 5 days after anthesis. Rodgers (1981c) measured gibberellin activity at intervals from anthesis to 50 days later. He found maximum concentrations at 3, 15 and 50 days and minimum concentrations at 7 and 40 days after anthesis (Figure 4).

Cytokinin content of bolls also increases after anthesis. Sandstedt (1971) separated the cytokinins from cotton bolls by paper chromatography into two fractions. One fraction increased to a maximum 5 to 6 days after anthesis and then disappeared by the time bolls were 15 days old. The other fraction remained constant at a relatively low level through day 6 and then declined to unmeasurable amounts by day 18. Rodgers (1982b) reported peaks of cytokinin activity at 5 and 15 days after anthesis (Figure 5). His results differed from those of Sandstedt (1971) in that Sandstedt did not find high cytokinin activity 15 days after anthesis.

Boll abscission rate not only changes with boll load, it also changes with boll age (Guinn, 1982a). To obtain more precise data on changes in abscission rate with boll age, we tagged flowers at anthesis during July, 1981. Abscised bolls were gathered daily, except for Saturdays and Sundays, and counted. Mondays were

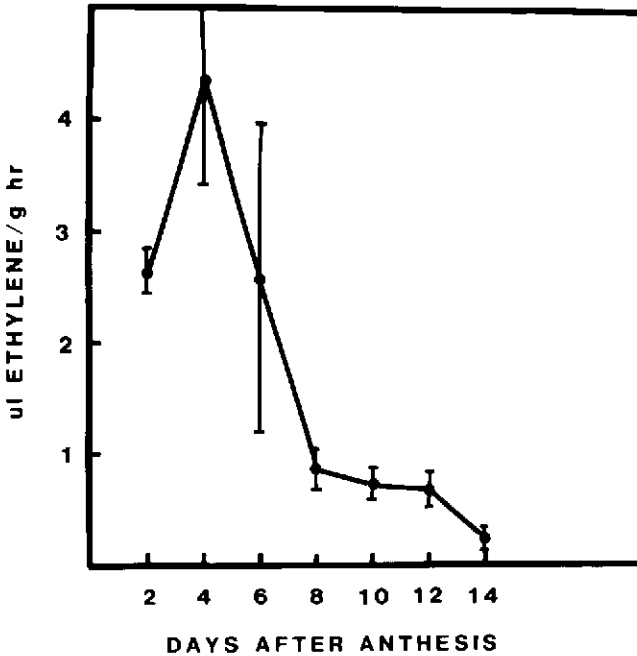

Figure 3. Ethylene evolution from young cotton fruits as influenced by fruit age. (Data are averages of 4 replications of two or more fruits per sample and standard errors are shown. Data of Guinn, 1982).

treated as a cleanup day. Boll abscission was calculated as a percentage of all bolls in that age group which abscised at that age. Abscission rate was very low the day after anthesis but increased rapidly to a peak at 5 to 6 days after anthesis (Figure 6). The rate declined as bolls became older and reached a very low level at 18 days after anthesis. Rodgers (1980a) reported similar results except that he found peak rates of shedding at 5 and 10 days after anthesis.

If one assumes that the abscission process requires a day or two for completion, it seems logical to assume that the effective growth regulator should show a change before a change in abscission rate. The peak rate of ethylene production preceded the peak rate of abscission (cf. Figures 3 and 6), and the rates then declined in parallel. ABA content reached a maximum after the peak abscission rate (cf. Figures 2 and 6). Low concentrations of auxins and gibberellins coincided with high rates of boll abscission (Figures 1, 4 and 6). Except for the large peak at 15 days after anthesis, cytokinin-like activity was at a maximum at the boll age of maximum abscission (cf. Figures 5 and 6).

The interaction of plant growth regulators may be more important in controlling boll abscission than the concentration of any one alone. High concentrations of auxin (Rodgers, 1981a) and gibberellins (Rodgers, 1981c) at 3 days after anthesis (Figures 1 and 4) may counteract the abscission promoting effects of

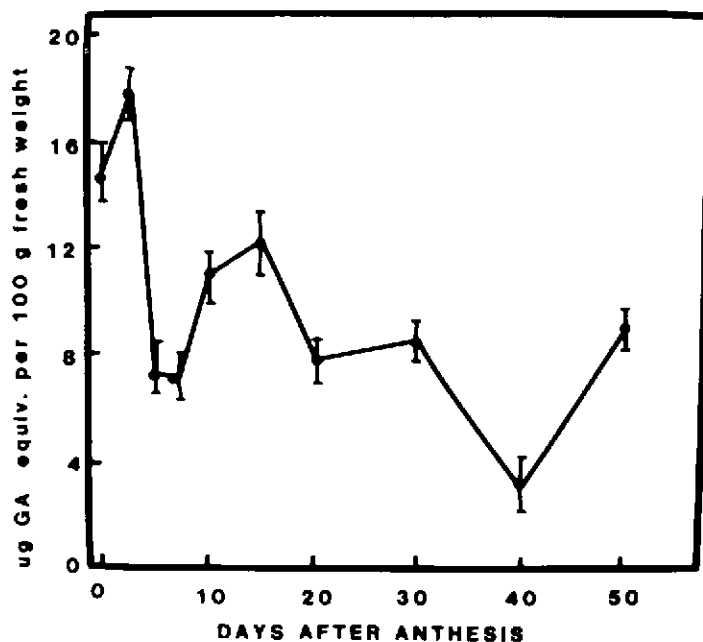

Figure 4. Changes in the levels of GA-like substances during development of the cotton fruit. (Each point is the mean of 3 values and vertical bars represent standard errors of the means. Data of Rodgers, 1981c, by permission).

relatively high ethylene evolution at, and shortly after, anthesis (Lipe and Morgan, 1972a). High concentrations of auxin (Rodgers, 1981a), gibberellins (Rodgers, 1981c) and possibly cytokinins (Rodgers, 1981b) at 15 days after anthesis, in addition to a declining concentration of ABA (Davis and Addicott, 1972; Rodgers, 1980b; Guinn, 1982a) and a declining capacity for ethylene production (Guinn, 1982), may combine to contribute to the marked decline in boll abscission rate at that age (Figure 6).

More information is needed on sequential changes and interactions of hormones during the season as they influence cutout, not only in fruits but also in growing points. We also need more information on effects of environment on hormonal balance and on possible differences between determinate and indeterminate cultivars.

## EXOGENOUS MODIFICATION

In addition to greenhouse, growth chamber and laboratory tests on effects of various growth regulators, several investigators have tested growth regulators on field-grown cotton. The goals of these tests have been to increase boll retention

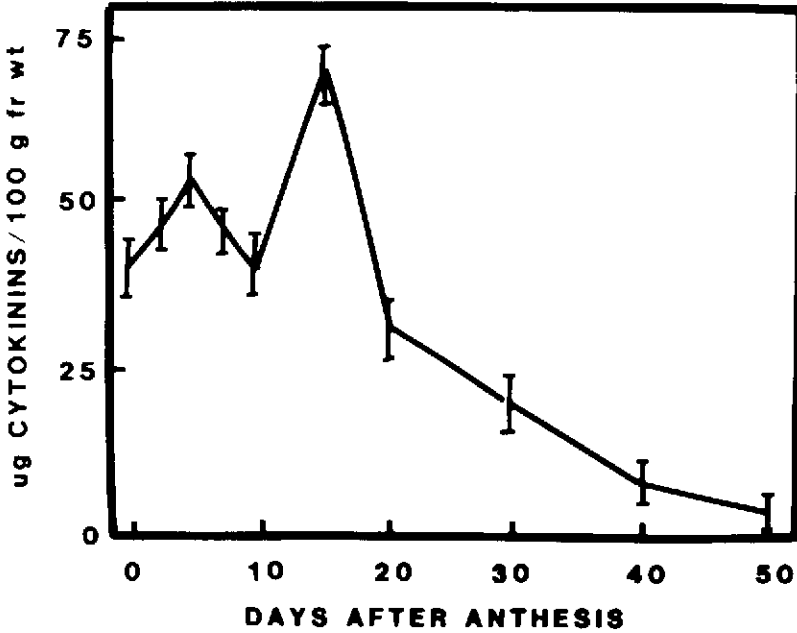

Figure 5. Changes in the concentration of cytokinin-like substances in lint and seed of developing cotton fruit. (Each point is the mean of 3 replications and standard errors of the means are indicated by vertical bars. Data of Rodgers, 1981b, by permission).

and yield, to limit growth of plants, or to remove squares and young bolls and terminate growth and fruiting activities (see Chapter 13).

Freytag and Coleman (1973) applied 2, 3, 5-triiodo-benzoic acid (TIBA) to two cultivars of cotton during 2 years in a field test at Lubbock, Texas. Application of TIBA tended to lower the position of the first fruiting node, increase boll size and increase the number of bolls per plant. After combining the data for both cultivars for both years, they calculated yield increases of up to 16 percent for the most effective treatment, 5g/ha applied five times. They postulated that TIBA inhibited auxin (IAA) transport and decreased endogenous ethylene concentration. However, inhibition of auxin transport should promote, rather than inhibit, abscission.

Application of gibberellins (GA) directly to open flowers or young bolls increased the percentage of bolls retained (Walhood, 1957, 1958). The optimum concentration appeared to be about 100 ppm. Attempts at increasing yields by field applications of GA have been disappointing. Lane (1958) reported that plants treated with GA on the Texas High Plains seemed somewhat larger, but their yield was slightly less than that of the controls. Walhood (1958) applied GA

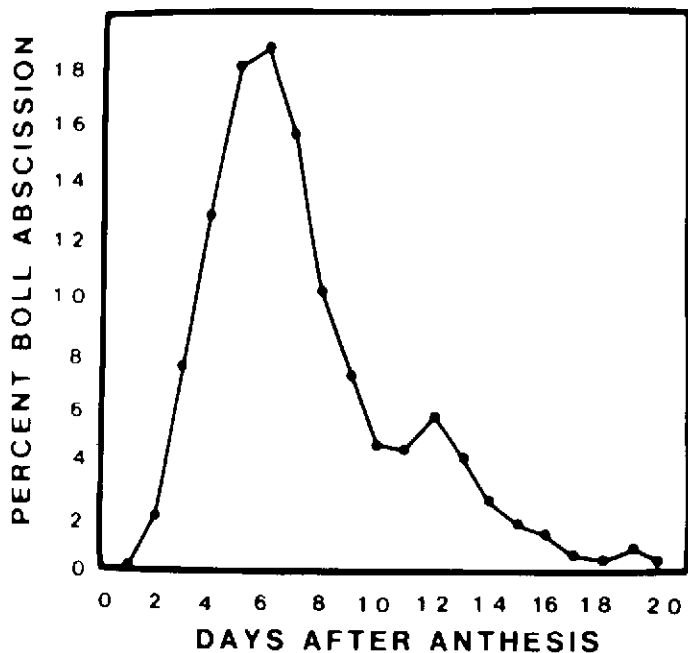

Figure 6. Fruit abscission rates during July as a function of fruit age. (Each point represents a population of 1,460 to 4,480 fruits. Previously unpublished data of Guinn).

by airplane and by hand in California. Application by plane gave slightly higher yields in some cases, but the results were erratic and showed no relationship between rate of application and yield increases. He applied GA at the rate of 0.61 g/ha directly to the growing points of plants either once or several times during the fruiting season. Application of GA to the growing points increased plant height and the number of bolls produced, but the bolls were smaller. Application of GA increased yields on a light soil where the untreated plants quit growing and fruiting during mid-summer but did not affect yield on a heavier soil where plants grew and fruited for a longer time. The beneficial effect may have been related to stimulation of growth and delay of cutout. Walhood (1957) reported earlier that application of GA to the terminals of cotton plants that had cutout caused them to resume growth. Subbiah and Mariakulandai (1972) found that GA and naphthalene acetic acid (NAA) decreased abscission of squares and bolls, but they were unable to increase yields by spraying cotton plants with GA and NAA. Their untreated controls produced the highest yields.

A few reports indicate that NAA may increase boll retention and yield. Negi and Singh (1956) applied NAA at 5, 10 and 20 ppm and reported an increase in

the number of bolls and yield in the first picking. Their data show an 8 to 9 percent yield increase with 10 ppm NAA applied as foliar spray but a slight decrease the number of bolls and yield in the first picking. Their data show an 8 to 9 percent yield increase with 10 ppm NAA applied as foliar spray, but a slight decrease with 20 ppm NAA. Murty *et al.* (1976) claimed a 50 percent decrease in boll shedding and a 20 to 35 percent increase in yield after spraying cotton plants with 10 and 30 ppm NAA. They concluded that spraying with 30 ppm NAA at the initiation of flowering and again at the time of peak flowering would decrease boll shedding and increase yields. Varma (1976) reported that application of NAA to flower buds, bolls or boll explants completely counteracted the abscission-promoting effects of ABA.

Many reports have shown that application of IAA or NAA to explants distal to the abscission zone delays and inhibits abscission, but proximal applications usually promote abscission unless applied at rather high concentrations (Addicott and Lynch, 1955; Addicott, 1970). It is possible that foliar application of IAA or a synthetic auxin, such as NAA, may indirectly affect abscission and yield by stimulating photosynthesis. Turner and Bidwell (1965), Bidwell and Turner (1966) and Tamas and co-workers (1972, 1974) obtained evidence that IAA stimulated photophosphorylation and CO<sub>2</sub> fixation in isolated chloroplasts and leaves.

Growth retardants have been used in an attempt to limit excessive vegetative growth of cotton. Singh (1970) applied (2-chloroethyltrimethylammonium) chloride (also known as CCC, Cycocel, and chlormequat) to three cultivars of *G. hirsutum* and one cultivar of *G. arboreum* growing in field plots in Punjab, India, where excessive vegetative growth was a problem. Application of CCC 70 to 80 days after planting retarded growth and increased the number of bolls per plant, boll weight and yield. Sprays of 40 ppm CCC increased yield of the *G. hirsutum* cultivars by 18 to 45 percent and sprays of 160 ppm CCC increased the yield of *G. arboreum* 15 to 34 percent. Singh also found evidence that CCC promoted drought resistance at Abohar.

Other workers were able to limit growth with CCC but did not find any yield increases; on the contrary, early application or high rates decreased yield (Thomas, 1964, 1967, 1975; Zur *et al.*, 1970, 1972; Marani *et al.*, 1973). Marani *et al.* (1973) applied CCC at 50 and 100 g/ha and applied N-dimethyl-N-β-chloroethyl-hydrazone chloride (CMH) at 480 and 720 g/ha. Both growth retardants significantly decreased the growth rate. When applied at the beginning of flowering, neither CCC at 50 g/ha nor CMH at either rate decreased lint quality or yield. El-Baz *et al.* (1971) and Thomas (1972) were also able to limit plant height with CCC without causing significant yield reductions. Application of CCC at 100 g/ha did decrease yield, possibly because of decreased boll retention (Marani *et al.*, 1973). Thomas also reported decreased boll set (1964, 1975) on plants treated with CCC.

Another growth retardant, 1,1-dimethylpiperidinium chloride (also known as mepiquat chloride or Pix), has been tested rather extensively in recent years. Most of the results have been reported at the Beltwide Cotton Production Re-

search Conferences and published in the Proceedings. Pix rather consistently decreases plant height and leaf area, and causes leaves to be thicker (e.g., Walter *et al.* 1980). It sometimes increases yield but yield responses have not been consistent. Yield increases may result from more favorable light penetration when plants would grow tall and rank without the growth retardant. Application of Pix also tends to promote earliness in some cases (Briggs, 1981) but not in others (Crawford, 1981).

Under some circumstances it may be desirable to delay first bloom or to decrease the percentage of squares that produce blooms. Pinkas (1972) used (2-chloroethyl) phosphonic acid (ethephon) to cause abscission of first squares in order to raise the position of the first bolls on Pima S-4. This facilitated mechanical harvesting in an area where this cultivar tended to fruit close to the ground. Prokeřev *et al.* (1977) reasoned that less assimilate would be lost if superfluous fruits were abscised as young squares rather than young bolls. They treated plants with 2-mercaptoethanol (MET) and N, N-dimethylmorpholinium chloride (DMC) to prevent the formation of excess fruits or to destroy them at the stage of rudimentary buds. Treatment with 0.1 and 0.5 percent MET decreased yield, but treatment with DMC increased earliness and yield. They reported that spraying with DMC increased yield in the first picking by 66 to 73 percent, increased boll weight about 1 gram, and increased total yield 26 to 30 percent. The lowest concentration was almost as effective as the highest over the range tested, 0.046 to 0.45 percent.

Kittock and Arle (1977) used CCC and other growth regulators to terminate fruiting. Their goal was to remove squares and small bolls late in the season to deprive pre-diapausing pink bollworm larvae of a food supply. They identified two types of action: fast-acting nonpersistent and slow-acting persistent. A mixture of growth regulators with each type of action gave the most effective chemical termination of fruiting. The slow-acting persistent regulators included CCC and chlorflurenol (methyl 2-chloro-9-hydroxyfluorene-9-carboxylate). The fast-acting growth regulators included 2,4-D (2, 4-dichlorophenoxyacetic acid) and 3,4-dichloroisothiazole-5-carboxylic acid.

## SUMMARY

Modern varieties of cotton flower readily without special photoperiods or hormonal modification. Therefore, little research has been done on the role of hormones in flowering and little is known about their effects on flower induction.

Much more is known about the roles of hormones in abscission. In order for abscission of cotton bolls to occur, cell walls in the abscission zone must be weakened by the hydrolytic enzymes pectinase and cellulase. The abscission-promoting hormones, ethylene and abscisic acid, have been reported to stimulate synthesis of cellulase and to decrease the basipetal movement of auxin (indole-3-acetic acid) to the abscission zone. Auxin normally delays or prevents abscission,



possibly because it prevents the synthesis and secretion of the specific cellulase involved in abscission. Gibberellins promote abscission of explants (isolated portions of plants) but inhibit abscission when applied to cotton flowers or young bolls. Cytokinins have variable effects and may either promote or retard abscission, depending upon time and site of application. The effects of gibberellins and cytokinins may be due mainly to their ability to mobilize nutrients to the site of their application or natural distribution.

Relatively little is known about hormonal control of cutout, but based on established effects of the hormones, we can speculate that auxin, cytokinins and gibberellins promote growth and delay cutout. ABA, on the other hand, probably promotes cutout because it inhibits growth and prolongs bud dormancy. Ethylene increases boll abscission and may restrict growth, but it probably does not prolong bud dormancy. Bolls may affect cutout by producing ABA and by competing with shoot and root growing points for sugars and nitrogenous compounds. This competition could affect hormonal balance by affecting the production of hormones and by decreasing the uptake of water and inorganic nutrients from the soil. A decrease in nitrogen content of roots and shoots could decrease the synthesis of auxin and cytokinins and increase the production of ABA. ABA content has been shown to increase in response to water and nitrogen deficits.

Various growth regulators have been applied to cotton in attempts to set more bolls, limit vegetative growth, or terminate fruiting. When boll load is limited by carbohydrate supply, exogenous modification of hormonal balance to increase boll set may be futile. More bolls may be set, but they will probably be smaller and the plants may cut out sooner. If, however, the growth regulators stimulate photosynthesis, boll set and yield may be increased. Hormonal control of plant height is possible and may be a useful practice when rainy weather and insect pests cause excessive growth that can result in lodging and boll rots. Hormonal termination of growth and fruiting appears to be a useful method of depriving prediapause insect pests of food and, thereby, of limiting the number that survive the winter.

Short-season techniques are currently being promoted to decrease production costs and minimize late-season and overwintering insect problems. The ability to control flowering, fruiting and cutout is essential, if maximum yields are to be obtained. A more detailed and thorough understanding of the physiology of the cotton plant should enable us to do a better job of tailoring plant performance to fit specific needs and situations.

## Chapter 13

# USE OF PLANT GROWTH REGULATORS FOR CROP MODIFICATION

George W. Cathey and Robert O. Thomas  
USDA-ARS  
Stoneville, Mississippi

## INTRODUCTION

The cotton plant is exposed to a multitude of chemicals during the course of its growth and development. Many of these may alter some phase of the physiology of the plant and could have some effect on subsequent growth and development. The effect of any one chemical may be slight and not be apparent in terms of yield and quality, but the effect could possibly be altered through an interaction with other chemicals or with one or more environmental factors and cause a significant change in growth and development. Efforts have been made in recent years to determine the physiological effect on the cotton plant of several of the pesticide chemicals that are used as standard cotton production practices. In addition, investigations into the feasibility of using synthetic growth regulator chemicals to manipulate the vegetative and reproductive development of cotton have increased significantly in recent years. Much of the earlier plant growth regulator research was reviewed by Guinn (Chapter 12) and, therefore, will not be included in this section.

## REPRODUCTIVE DEVELOPMENT

The use of synthetic growth regulator chemicals to improve yield and quality of cotton has been researched by numerous investigators. In addition to the traditional efforts of using chemicals to increase yield through increased boll-set, other approaches such as chemical alteration of plant processes are being investigated. But attempts to increase fruitfulness by exogenous applications of growth regulator chemicals have been less successful than in other areas of growth manipulations.

A regulatory mechanism within the cotton plant causes an unusually large percentage of the fruiting forms to shed, and the plant frequently matures bolls from less than half the flowers produced. The exact nature of this mechanism is not entirely understood, but it could conceivably be either nutritional as suggested

by Eaton (1955) or hormonal as proposed by Horowitz (1962). More likely an interplay of both theories is involved. Work by Varma (1978) suggests that the cotton fruit retention:abscission ratio depends on the balance between nitrogen and the endogenous growth regulators, gibberellic acid (GA) and abscisic acid (ABA) within the plant tissue. He reported the GA and ABA levels to be low in retained fruit as compared to abscising ones, and nitrogen levels to be high in retained bolls and low in those abscising. Work by Rogers (1980b) also suggests that the retention:abscission ratio of cotton fruit depends more on the balance between ABA levels and other hormone levels than on the absolute amount of ABA present. Ergle (1958) reported that gibberellins produced taller plants, but caused no effect on agronomic performance. In a similar study, Bird and Ergle (1961) found that cotton cultivars differ in their response to GA<sub>3</sub>, and they suggested that cultivars may vary in levels of natural gibberellins. This variability may help to account for the erratic results obtained by investigators in their attempt to improve yields by exogenous applications of GA.

Cytokinins delay or prevent senescence and promote the ability of organs to compete for metabolites (Letham, 1967). Rogers (1981b) made comparative analyses of retained and naturally abscising cotton fruits and found that abscission was negatively correlated with the concentration of cytokinins. Numerous formulations that contain cytokinins are marketed as plant growth stimulants for a wide range of crops. Several of these have been tested for yield enhancement in cotton production, but the authors are unaware of any reports in the literature of significant yield increases resulting from their use. Cothren and Cotterman (1980) tested one such product for two years in Arkansas and found trends toward increased yields in the cytokinin-treated plots, but the differences were not significant. They reported significant decreases in transpiration and nitrogen loss from treated leaves which suggest that cytokinins may alter metabolism of cotton plants in favor of increased yields.

When insecticides are used as test chemicals for plant growth regulation, it is often difficult to distinguish between plant response to the chemical *per se* and response to relief from insect damage; however, there is ample evidence that some insecticide chemicals can have physiological effects on flowering, fruiting and cutout. Hacskeylo and Scales (1959) reported that flower formation, boll set and plant growth were retarded and plant maturity hastened when cotton grown under insect-free conditions was sprayed with dieldrin (1,2,3,4,10,10-hexachloro-6,7-epoxy-1,4,4a,5,6,7,8,8a-octahydroendo-exo-1,4,5,8-dimethanonaphthalene) and DDT [1,1,1-trichloro-2,2-bis(4-chlorophenyl)-ethane]. Conversely, plants sprayed with azinphosmethyl [0,0-dimethyl-S-[4-oxo-1,2,3-benzotriazin-3(4H)yl]-methyl]phosphorodithioate] produced more flowers and more bolls and had a longer maturation period than the controls.

Brown *et al.* (1961, 1962) used multiple applications of toxaphene-DDT, calcium arsenate, and methyl parathion [0,0-dimethyl *o*-(*p*-nitrophenyl) phosphorothioate] to determine insecticide effects on plant growth and development

of field cotton. Treatments with toxaphene-DDT increased boll production each year, but a concurrent reduction in boll size during the first year offset the boll number advantage, and yield was not affected. Yield was increased the second year in the toxaphene-DDT plots. Treatments with calcium arsenate reduced boll production and yield in each test. Roark *et al.* (1963) reported no effect on plant growth and development from treatments with toxaphene, DDT, or toxaphene-DDT mixtures. Methyl parathion apparently has no effect on boll numbers or seed cotton yield, but tends to increase average node number of the first fruiting branch; delay square and flower production; increase average boll period; and delay plant maturity (Brown *et al.*, 1962; Roark *et al.*, 1963; Beasley, 1969; Thomas, unpublished).

Major beneficial effects on initiation and retention of cotton fruit were reported by Phillips *et al.* (1977) when field plants in Arkansas were sprayed with chlordimeform [N-(4-chloro-*o*-tolyl)-N,N-dimethyl formamidine]. However, no differences in flowering rate, boll production, or yield were detected in similar studies conducted in a relatively insect-free environment at Stoneville, Mississippi (Cathey, unpublished). Conflicting results have also been obtained from the use of acephate (*O,S*-dimethyl acetylphosphoramidothioate) to alter plant growth and development (Cathey *et al.*, 1981a). Multiple applications of acephate to field plants in 1977 caused an increase in flowering rate, boll production, boll size and yield. Similar treatments in 1978 and 1979 resulted in no effect on any of the parameters measured. In addition, growth and development of greenhouse cotton plants were not affected by acephate treatments. <sup>14</sup>C-labeled acephate, however, has been shown to translocate from treated leaves to all parts of the cotton plant and to accumulate in areas of rapid growth when multiple applications were made (Cathey *et al.*, 1981b). The fruiting forms and plant terminals appear to be the main sinks.

## VEGETATIVE DEVELOPMENT

Early attempts to alter plant size were made by various mechanical treatments. None of these ever proved entirely satisfactory, however, and efforts were then directed toward chemical treatments to accomplish the same objective. The plant growth retardant, 2-chloroethyltrimethyl-ammonium chloride (CCC or cycocel), has been used in many areas of the world to significantly reduce plant height. However, significant reductions in yields are frequently reported when this chemical is used. In addition, fiber and seed quality may be adversely affected. Thomas (1964) was able to reduce plant height significantly with spray applications of CCC to greenhouse cotton, but yield was reduced by about the same percentage as plant height. He reported only minor reductions in flowering, but significant reductions in boll-set two to five weeks after treatment. In a more recent study Thomas (1972) was able to reduce plant height by 16 inches without a significant reduction in yield. De Silva (1971) reported that cotton in Uganda

responded to CCC with a reduction in both plant height and yield. Reduced yields resulted from excessive fruit shed toward the end of the season. Similar results were obtained in Arizona (Kittock *et al.*, 1974) and in Mississippi (Thomas and HacsKaylo, 1974; Thomas, 1975). Singh (1970) reported that applications of CCC 70 to 80 days after planting retarded growth and increased the number of bolls per plant, boll weight and yield. Sprays of 40 to 160 ppm CCC increased yields 15 to 45 percent. TIBA (2,3,5-triiodobenzoic acid) was used by Thomas (1967) to reduce plant size and dry weight, but the chemical also significantly reduced seed cotton yield. Similar treatments with CCC in the same experiment reduced plant size without affecting yield.

The experimental growth regulator chemicals, BAS 0660W (dimethyl-morpholium chloride) and BAS 0640W [dimethyl-N-( $\beta$ -chloroethyl) hydronium chloride], caused significant reductions in plant height, increases in early flowering, early maturity, and lint percent (Follin, 1973). These two chemicals were forerunners of the plant growth regulator 1,1-dimethyl piperidinium chloride (also known as Pix<sup>®</sup> or mepiquat chloride). Under conditions of luxuriant moisture and fertility a 20 to 30 percent reduction in plant height can be expected from treatments with mepiquat chloride (Heilman, 1981). Similar reductions in lateral branch length also occur. Walter *et al.* (1980) found a 22 percent reduction in canopy width of mepiquat chloride-treated plants. Bolls per plant were reduced, but boll weight was increased so that yield was not affected. Conversely, Feaster *et al.* (1980) found that bolls were smaller and yields reduced on mepiquat chloride-treated plants. Erratic yield responses to this chemical were also reported by Briggs (1981) in Arizona. He concluded that environmental factors have a major role in determining the final yield response to mepiquat chloride.

In addition to modification of plant growth and development *per se*, growth regulator chemicals may have effects that indirectly influence production. For example, TD-1123 (potassium 3,4-dichloro-5-isothiazole carboxylate) was shown to cause male sterility in cotton flowers without significantly reducing female fertility (Olvey *et al.*, 1981). This might increase the feasibility of producing hybrid cotton seed. Erwin *et al.* (1979) reported that the growth retardants, CCC and mepiquat chloride, mitigated symptom expressions of *Verticillium* wilt and increased yield of cotton grown on wilt-infested land. Snow *et al.* (1981) found that boll rots were reduced in mepiquat chloride (Pix<sup>®</sup>)-treated plots in Louisiana during years of abundant moisture. Boll rot damage in Mississippi was also reduced by mepiquat chloride (Pix<sup>®</sup>) treatments in 1981 (Cathey and Minton, unpublished).

Yield and quality of cotton might also be affected by alterations in fiber properties. For example, elongation and secondary wall thickening of fibers overlap in time (Schubert *et al.*, 1973), so if the duration of either process is extended, the total yield or the quality of the fiber might be improved. Bhatt *et al.* (1972) reported that low concentrations of cycocel gave coarser fibers without affecting other fiber characters; whereas, higher concentrations increased length

and fineness but decreased strength, maturity and yield. Cycocel was also shown to cause a significant number of abnormal bolls with coarser fiber to be produced. Bhatt *et al.* (1972) also found that IAA improved fiber length and fineness and that low concentrations of NAA increased fineness but had the reverse effect at higher concentrations. Gibberellic acid was shown to significantly increase fiber length in one variety of cotton in India (Bhatt and Ramanujam, 1972). In a separate study, however, GA had no effect on any fiber property of another Indian variety (Sitaram and Abraham, 1973).

## CROP TERMINATION

A relatively new concept in cotton production in many areas is the use of growth regulator chemicals to induce "cutout" or force the termination of vegetative and reproductive growth. Much of this work was done by Kittock *et al.* (1973, 1974, 1975, 1977, 1979) in Arizona and Thomas *et al.* (1964, 1967, 1972, 1973, 1975, 1979) in Mississippi. The primary objectives of the two groups have been reductions of late-season insect populations and earlier harvest. The chemicals most extensively tested as cotton growth terminators include CCC, TD-1123, Chlorflurenol (methyl 2-chloro-9-hydroxyfluorene-9-carboxylate), ethephon [(2-chloroethyl)phosphonic acid], dicamba (3,6-dichloro-*o*-anisic acid), glyphosate [N-(phosphonomethyl)glycine], DPX-1840 [3,3a-dihydro-2-(*p*-methoxyphenyl)-8*H*-pyrazolo[5,1-*a*] isoindol-8-one], 2,4-D [(2,4-dichlorophenoxy) acetic acid], and thidiazuron (N-phenyl-N'-1,2,3-thiadiazol-5-ylurea). Most of these have been evaluated separately, in various combinations, and in sequential applications, and classified as fast-acting nonpersistent and slow-acting persistent (Kittock *et al.*, 1974). The most satisfactory results were obtained with combinations of chemicals represented by both groups, either as a combined treatment or applied in sequence (Kittock *et al.*, 1973, 1974, 1975; Thomas and Hacskaylo, 1974; Thomas, 1975). Chlorflurenol (slow-acting) and TD-1123 (fast-acting) combinations gave the most satisfactory results. Regardless of the chemical or combination used, the optimum time of treatment, in terms of effective crop termination with minimum yield reductions, appears to be sometime between mid-August and early-September.

Thomas and Hacskaylo (1973) found that DPX-1840 was readily absorbed and translocated to stem tips, and retarded growth without serious effects on boll development. This chemical was more effective than CCC in this respect (Thomas, 1972). Similar results were obtained when various combinations of chlorflurenol and TD-1123 were applied in late August and early September (Thomas *et al.*, 1979). Leaves, squares, small bolls, and insect populations were significantly reduced with only minimal yield reductions. Hopkins and More (1980) used low rates of the defoliant chemical thidiazuron (Dropp®) to reduce feeding sites and insect populations without adversely affecting yield or quality. The herbicide glyphosate (Roundup®) might also suffice as a crop terminator on cotton. It was

shown to inhibit regrowth development for extended periods after application (Cathey and Barry, 1977). In addition to reduced late-season insect populations, significantly earlier harvests may be obtained from some crop termination treatments (Cathey, 1980; Wolfenbarger and Davis, 1976). Sequential treatments of mepiquat chloride, chlorflurenol and TD-1123 advanced harvests in one Mississippi test by 14 days with no significant effect on yield (Cathey, 1980). Similar results were obtained in Texas when combination treatments of chlorflurenol and 2,4-D were used (Wolfenbarger and Davis, 1976). Crop termination and early harvest may also be obtained by the use of high ethephon rates (1 to 2 lbs/acre). When used at these rates, this chemical stops terminal growth, accelerates boll dehiscence and induces abscission of leaves and immature fruiting forms (Singh and Kumar, 1978; Cathey and Luckett, 1980; Cothren, 1980; Cathey *et al.*, 1982).

## SUMMARY

The primary objectives of recent plant growth regulator work in cotton production have been: a) improved balance between reproductive and vegetative growth; b) suppression of undesirable late-season fruiting forms; and c) earlier maturity and harvesting. The literature and assessment of unpublished reports indicate that these goals can be realized without serious effects on productivity. The degree of success apparently is determined by choice and concentration of chemicals, timing of applications, condition of plants at time of application and environmental factors subsequent to treatment. Although the attempts to increase the fruitfulness of the cotton plant by exogenous applications of growth regulator chemicals have, in general, given negative results, a considerable amount of success has been attained with growth suppression, abscission of late-season fruiting forms, forced cutout and increased earliness. In addition, physiological effects on cotton plant growth and development have been observed when certain insecticides, fungicides and herbicides were used as standard production practices.

## Chapter 14

# PHYSIOLOGY OF DEFOLIATION IN COTTON PRODUCTION

George W. Cathey  
USDA-ARS  
Stoneville, Mississippi

## INTRODUCTION

The cotton plant is inherently a deciduous perennial with a natural mechanism for shedding its mature leaves. During the growing season the leaves function to supply photosynthates to the developing fruit and shed only when the leaf or plant undergoes a stress such as drought, disease, starvation or frost. Once the entire crop is mature, however, the leaves serve no useful purpose, and their removal can be beneficial for mechanical harvesting. Reducing the large amounts of foliage in preparation for harvest has become an important step in the production of high-quality fiber.

Chemical defoliation is a cultural practice which induces abscission of cotton foliage earlier than normal (National Cotton Council, 1949). The practice received its greatest impetus with the advent of mechanical harvesters during the 1940's and is now considered one of the major beltwide practices. Defoliant chemicals are applied to half or more of the cotton grown annually in the United States to facilitate mechanical harvest. For spindle picking, the complete removal of all leaves without killing any of the remaining plant becomes the desirable condition. The machine itself may operate with high efficiency if only a small percentage of leaves remain, but succulent green leaves may stain the lint, and dead dry leaves will fracture to become "pepper" trash in the ginned lint (National Cotton Council, 1950).

Cotton leaf abscission is a physiological process that involves an active separation of living tissue from the plant. An understanding of the basic aspects of the process is essential to successful defoliation of cotton with exogenous chemicals. This topic is the subject of a number of recent articles and reviews (Addicott, 1970; Addicott and Wiatr, 1977; Carns, 1966; Guinn, 1979; Rubinstein and Leopold, 1964; Walhood and Addicott, 1968).



## THE NATURE OF DEFOLIATION

Leaf abscission in cotton is usually a result of maturity, senescence or injury. The maturity or senescence state of development, however, is not always related to age in days or months but is more often a reflection of the conditions under which the plant develops. Leaves can become senescent and shed from the plant through the influence of a number of stress situations. Such stresses, however, may be considered as injuries or unfavorable alterations of vital plant processes. The application of chemicals for defoliation merely involves the use of an applied injury that ultimately induces the plant to abscise its leaves. Abscission, whether due to natural or induced senescence, is usually preceded by a variety of senescent changes. These include: a loss of chlorophyll; increased anthocyanin; reduced levels of proteins, carbohydrates and inorganic ions (Walhood and Addicott, 1968; Addicott, 1969); and alterations in hormone concentrations (Addicott and Lynch, 1955; Carns, 1966; Burg, 1968; Addicott, 1969; Del la Fuente and Leopold, 1968).

The cotton leaf petiole has an area near its base that is structurally distinguishable and characterized by a structural line of weakness where abscission occurs (Figure 1). Toward the end of the senescence process, there is a dramatic increase in metabolic activity within this abscission zone. The increased activity results from alterations of the hormone levels of the leaf blade which in turn alter the hormone levels within the abscission zone (Rubinstein and Leopold, 1964; Abcles, 1967; Leopold, 1971; Webster, 1973; Osborne, 1974; Addicott and Wiatr, 1977). Thus, abscission is controlled by an interaction of hormones. These hormonal interactions cause cells within the abscission zone to secrete hydrolytic enzymes that degrade the cell wall, especially the pectic substances of the middle lamella and cell walls, to permit the leaf to fall from the plant. Although a number of enzymes are recognized as increasing in activity within the abscission zone in correlation with abscission (Addicott and Wiatr, 1977), pectinase and cellulase have been investigated most extensively (Durbin *et al.*, 1981; Horton and Osborne, 1967; Lewis and Varner, 1970; Morr , 1968; Reid *et al.*, 1974; Riov, 1974). These enzymes are synthesized in the plasmalemma and secreted into the middle lamella region where they digest the middle lamella and hydrolyze portions of the primary cell wall (Sexton and Hall, 1974). The weakened cell walls eventually permit separation, and the leaf falls from the plant. Abscission may not occur immediately, however, because the vascular tissue is not affected by the enzyme activity but must be broken by mechanical forces. These forces are supplied by the weight of the leaf blade plus a shear and tension action created by cell division and enlargement on the stem side of the abscission zone and cell shrinkage on the leaf side (Morr , 1968; Leopold, 1971; Osborne, 1973). The cell division on the stem side also produces a corky protective layer across the leaf scar (Walhood and Addicott, 1968). The differential cell growth across the abscission

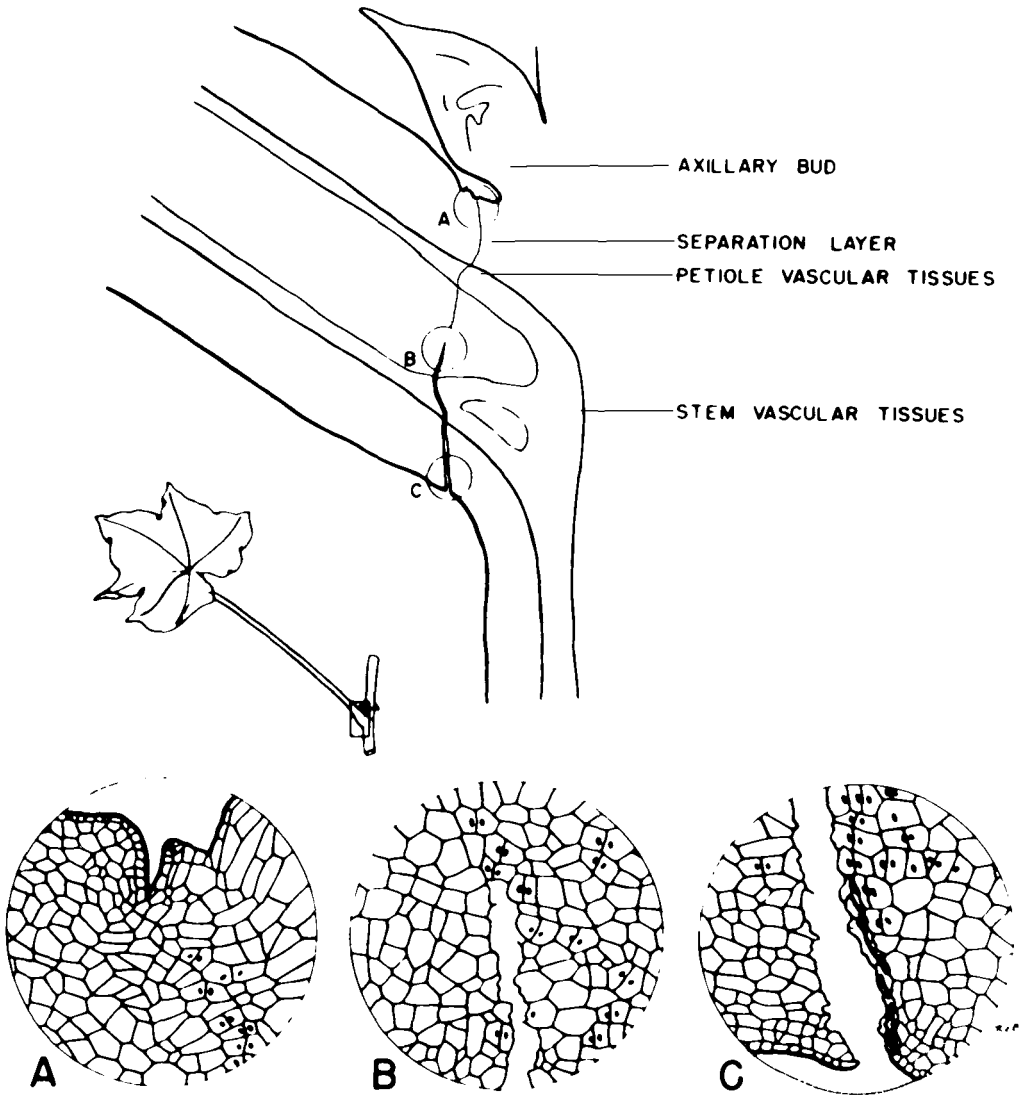

Figure 1. Diagram of the leaf base of cotton during process of defoliation. Circles A-C correspond with the drawings which show relationship of cell divisions to separation layer. Separation occurs between dividing cells on the distal side of the abscission zone. Cell divisions, followed by separation, commence at the lower edge of the abscission zone and progress upward. (By Katharine C. Baker)

zone may explain observations reported by McMichael *et al.* (1973) and Osborne (1974). They reported that leaves failed to abscise during periods of water deficit, but that abscission occurred readily after the deficit was relieved by watering. Both of these observations lend support to the suggestion of Addicott and Lynch (1955) that actual leaf separation is a growth process that requires turgor.

Although leaf abscission results from enzymatic dissolution of cells in the abscission zone, the process is influenced by hormone levels within the leaf blade and external environmental factors. Defoliant chemicals are used to alter the hormonal balance and induce abscission; however, the efficacy of most defoliant chemicals may be influenced by environmental factors as well as the hormone levels within the plant.

## HORMONAL EFFECTS

The major hormones that are known to have one or more important influences on abscission include indole and naphthalene acetic acid (IAA and NAA), abscisic acid (ABA), gibberellic acid (GA), ethylene (ETH) and cytokinin (CK) (Addicott and Wiatr, 1977). In addition, the literature contains evidence that several other endogenous substances such as amino acids, senescence factors (SF) and ascorbic acid may affect abscission (Addicott, 1970; See also chapters 12 and 13). Generally the auxins (IAA and NAA) retard abscission while the plant hormones, ABA and ETH, are promotive. The influences of GA and CK are variable depending on interactions with several other factors. The exact mechanism by which plant hormones regulate abscission is not fully understood; however, several theories have been advanced. These are discussed in detail in the reviews by Carns (1966) and Rubinstein and Leopold (1964).

The auxin-gradient theory of abscission control proposed by Addicott *et al.* (1955) states that relative concentrations of auxin on each side of the abscission zone are more important than the absolute auxin concentration. The theory is based on observations that IAA inhibits abscission when applied to the petiole side of the zone, and stimulates abscission when applied to the stem side (Addicott and Lynch, 1955; Addicott *et al.*, 1955). They proposed that abscission is initiated only after a shift in auxin gradient across the abscission zone is favorable to the stem side. They also suggested that decreased auxin production by leaf blades during the process of growth and maturation caused a gradual auxin gradient shift to occur and initiate abscission in senescent leaves. This may help to explain the observed increased responsiveness of mature leaves to defoliant chemicals.

More recently Rubinstein and Leopold (1963) proposed the "two-stage" theory of abscission control by auxin. They suggested that abscission response to auxin can be divided into an inhibitory stage followed by one of promotion. The theory was based on observations that time of auxin application to petiole stumps was just as important as concentration. They found that the abscission effect of auxin shifted from inhibition to promotion as the time between deblading and

application increased. Similar results were obtained from stem applications. While the theory was based on results obtained with NAA, similar results were obtained with IAA (Chatterjee and Leopold, 1963).

The function of ABA in abscission is primarily promotive, and as suggested by Addicott and Wiatr (1977), may be associated with all abscission. The effect may be indirect, however, since it has been shown to stimulate ETH production (Cracker and Abeles, 1969; Jackson and Osborne, 1972), hasten senescence (Del la Fuente and Leopold, 1968), and decrease auxin transport (Chang and Jacobs, 1973). Direct effects of ABA have also been reported. Cracker and Abeles (1969) found that ABA increased the cellulase enzyme activity in the abscission zone of both cotton and bean (*Phaseolus vulgaris*) explants.

Ethylene has long been known as a potent abscission-promoting hormone. Its effect is similar to that of ABA in that the effect can be either direct or indirect. Direct effects include stimulated synthesis of pectinase (Riov, 1974) and cellulase (Horton and Osborne, 1967; Abeles, 1969; Ratner *et al.*, 1969; Reid *et al.*, 1974) in the abscission zone. In addition, ethylene causes increased secretion of enzymes into cell walls to enhance cell wall digestion (Abeles *et al.*, 1971).

Addicott and Wiatr (1977) suggested that the promotion of abscission by ETH may come more from its influence on the levels of other hormones than from direct effects. Morgan and Hall (1962) showed that ETH increased decarboxylation of IAA and stimulated the activity of the IAA-oxidase system. These events suggest a mechanism for reducing auxin concentrations in the leaf tissue and would tend to promote abscission. In addition, ETH has been shown to decrease or inhibit auxin transport (Morgan and Gausman, 1966; Beyer and Morgan, 1969, 1971) which in itself tends to promote abscission (Morgan and Durham, 1975). Thus, the combined effect of IAA degradation in the leaf tissue and the auxin transport inhibition through the petiole decreases the amount of auxin that reaches the abscission zone, and abscission is promoted.

The auxin-ethylene interaction has also been used to explain the auxin-gradient and "two-stage" theories of abscission control. Auxin stimulates ETH production in plant tissue (Morgan and Hall, 1962), and according to Abeles (1967), when applied to the stem side of the abscission zone, the ETH moves more rapidly than the auxin to the separation layer and promotes abscission. But, when auxin is applied to the petiole side, the auxin moves faster than the ETH, and abscission is inhibited. Leopold (1971) explains that during stage I of the "two-stage" theory the tissue is relatively insensitive to ETH, and auxin inhibits abscission. However, during stage II the tissue becomes sensitive to ETH, and the auxin inhibiting effect is overridden by the abscission-promoting effect of ethylene.

The effects of gibberellins on abscission are considered as moderately promotive, although conflicting reports are contained in the literature. The effect imposed by GA apparently depends to a large extent on application site and interactions with several other factors. Brian *et al.* (1959) sprayed the foliage of deciduous woody plants with GA and observed delayed senescence, renewed shoot

growth, and retarded abscission. Walhood (1958) obtained similar results when cotton foliage was sprayed with GA. Addicott and Wiatr (1977) reported that GA had a promotive effect when applied to the abscission zone and an inhibitory effect when applied to the leaf. The GA tended to promote vigor in the treated leaf and indirectly inhibited abscission. In more sensitive tests where explants were used as test material, GA was found to accelerate abscission when applied to either side of the abscission zone (Carns *et al.*, 1961). Chatterjee and Leopold (1963) obtained similar results with a wide range of concentrations of GA. They concluded that GA served to accelerate stage I of the "two-stage" response theory. GA has also been shown to enhance ETH activity (Morgan and Durham, 1975).

Cytokinin has a moderate retarding effect on abscission when applied to either the abscission zone or leaf blade (Addicott and Wiatr, 1977). Rogers (1981b) made comparative analyses of retained and naturally abscising cotton plant organs and found that abscission was negatively correlated with CK concentration. Apparently the effect of CK is indirect and is caused by prevention or delay of senescence in plant organs; delayed senescence reduces the sensitivity to the abscission-promoting effects of ETH (Del la Fuente and Leopold, 1968; Leopold, 1971). Evidently the delayed senescence and retarded abscission are related to increased ability of the organs to compete for metabolites (Letham, 1967). Cothren and Cotterman (1980) reported significant decreases in transpiration and nitrogen loss from CK-treated leaves. They suggested that the CK altered metabolism in favor of delayed senescence.

In addition to the well-established plant hormones that regulate abscission, there is beginning to be some evidence of one or more special senescence-promoting hormones. (Noodén and Leopold, 1977). The chemical nature of the material is still somewhat obscure, so it is referred to as "senescence factor" (SF). Osborne *et al.* (1972) postulated that it functions as a regulator of ETH production, thereby tending to initiate abscission. It is considered of general occurrence in plants but is separated from the site of ETH biosynthesis by membrane compartmentation and released only after injury or senescence.

Since amino acids in high amounts are found in leaves and petioles prior to abscission (Leinweber and Hall, 1959b), they may be important regulators of natural leaf abscission. A number of amino acids were found to promote abscission when applied to explants and de-bladed petioles; these include alanine, glutamic acid, serine, glycine, aspartic acid, phenylalanine, methionine, glutamine and histidine (Rubinstein and Leopold, 1962). Most of these have been reported to function during stage II of the "two-stage" response theory (Rubinstein and Leopold, 1963). Abscission enhancement apparently results from increased senescence (Martin and Thimann, 1972), enhanced ETH production (Rubinstein and Leopold, 1964) and increased hydrolytic enzyme synthesis (Addicott, 1969, 1970).

It becomes apparent from reviews of reports in the literature that the mechanism of leaf abscission involves the complex actions and interactions of many

substances that control the activity of the pectinase and cellulase enzymes within the abscission zone. The plant hormones most directly involved include IAA, NAA, ABA, and ETH. Other substances, however, may have indirect effects through their effects on synthesis and transport of these hormones and other plant metabolites.

## EXOGENOUS CHEMICAL DEFOLIATION

After the accidental discovery of exogenous chemical defoliation of cotton in the late 1930's, research indicated that it was feasible to remove leaves from a cotton crop before it was harvested (National Cotton Council, 1949). Since then, numerous chemicals have been screened in search of efficient defoliant materials. Most, however, have been discarded because of cost, poor field performance, or other disadvantages. Results from much of this work have been reported at the annual Beltwide Cotton Defoliation and Physiology Conferences (now named Beltwide Cotton Physiology Conference) (National Cotton Council, 1947-82). The search continues and a few promising chemicals are being tested at present under experimental label.

Formulations of magnesium and sodium chlorate were among the earliest products used extensively as cotton defoliants, and both are still in widespread use across the Cotton Belt. They are relatively inexpensive products and are very effective, especially when leaves are fully matured; they have little effect on immature leaves or on regrowth vegetation. Both chemicals are equally effective when applied at equivalent active ingredient rates. The two organophosphorus compounds (S,S,S-tributyl phosphorotrithioate, DEF; and S,S,S-tributyl phosphorotrithioate, merphos, Folex) are highly efficient defoliants and frequently cause leaf fall before excessive drying occurs. They often will remove immature leaves and are relatively effective in removing regrowth vegetation. Cacodylic acid (hydroxydimethylarsine oxide) is formulated as sodium cacodylate and is used extensively as a cotton defoliant in the western United States where leaves are consistently tougher than those further east. Limited testing of the product in Mississippi indicates a tendency towards excessive desiccation of leaves in the terminal portion of the plant (Cathey, 1979).

Two of the more recently developed defoliant chemicals are Harvade® (dimethipim) (2,3-dehydro-5,6-dimethyl-1,4-dithiin-1,1,4,4-tetraoxide) and Dropp® (thidiazuron) (N-phenyl-N'-1,2,3-thiadiazol-5-ylurea). The two chemicals are about equal in their effect on cotton leaf abscission, and the effect is comparable with that caused by either the chlorates or the phosphates (Ames, 1981; Taylor, 1981). Both chemicals, however, are superior to either the chlorates or the phosphates in the inhibition of regrowth (Hopkins and Moore, 1980).

The effect of defoliant chemicals on cotton leaves is similar to that of leaf blade removal, *i.e.*, the hormone balance is altered so that the auxin supply to the abscission zone is insufficient to inhibit initiation of the abscission process (Carns,

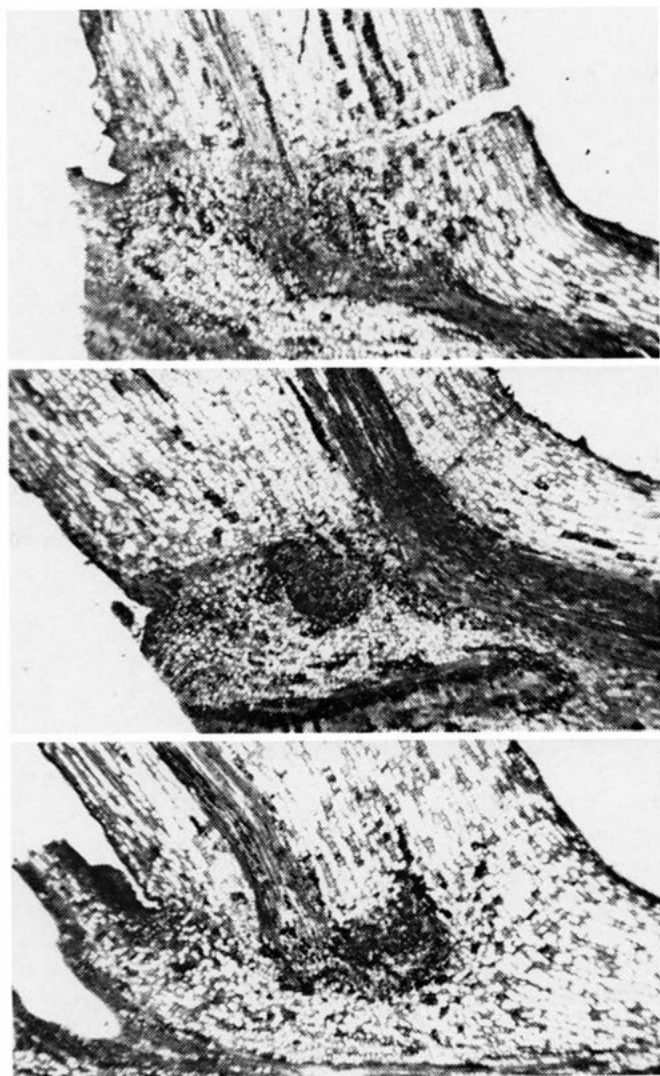

Figure 2. Photomicrographs of abscission zone of cotton illustrating abscission response to a defoliant chemical. At the bottom is shown a cross section of the abscission region before defoliant application. The center photo shows growth of the separation layer after application, while in the top picture, the leaf petiole begins to separate from the stem. (Photos by Vernon L. Hall)

1966). It appears unlikely, however, that chemically-induced defoliation results from any specific physiological action by the defoliant chemical, since there is such variance in their chemical structure and in the injury produced. Not all chemicals that injure cotton leaves are capable of stimulating abscission, and even with the most effective defoliants the degree of injury must be properly regulated (cf. Walhood and Addicott, 1968). Excessive injury may kill the tissue in the abscission zone and prevent the vital processes required for abscission. Conversely, low levels of injury may fail to initiate the process. The degree of injury induced by most defoliant chemicals varies with plant condition, defoliant concentration and environmental factors. Defoliant chemical injury is usually visible on the leaf blade within 48 to 72 hours of application, and the separation layer in the abscission zone becomes visible 1 or 2 days later (Figure 2). Under normal field conditions the defoliation process is complete in 7 to 14 days, but in some situations may be delayed for as long as 30 days.

The condition of the plant and the prevailing weather at time of application are the major factors that limit efficiency of the defoliation process. In general, efficiency is highest when plants have become vegetatively dormant and reproductively mature; when moisture content of the leaf is high; and when both temperature and humidity are high (National Cotton Council, 1950). Before abscission can take place, the leaf must be in a condition of activity that will allow the proper degree of reaction to the defoliant. There also must be sufficient activity to allow for the biological processes that initiate the abscission process. An ample moisture supply helps to ensure adequate leaf physiological activity. Under conditions of prolonged drought the leaves frequently become toughened and are reduced in physiological activity. The cells in the blade and petiole of such leaves fail to react properly to the defoliant chemical and defoliation is inadequate (McMichael *et al.*, 1973; Osborne, 1974).

While an ample supply of both moisture and nutrients is desired throughout the growing season for uniform growth and development, the supply of each should be almost exhausted at defoliation time. Defoliation is especially enhanced when the nitrogen supply is low or depleted (Addicott and Lynch, 1955). In addition, excessive supplies of these elements late in the season tend to promote renewed vegetative development that responds poorly to defoliant chemicals. The newly developed leaves have not developed the state of senescence required for rapid abscission. Defoliation efficiency has been found to be directly related to age of leaves when plants have been in a continuous state of growth (Brown and Rhyne, 1954). Usually the lower leaves and the leaves subtending mature bolls are more responsive to most defoliant chemicals than are the leaves of the newer growth (Addicott, 1968; Thomas, 1965).

Weather conditions at the time of application or for 3-5 days afterwards can have an important influence on plant response to defoliant chemicals. Defoliants are most active when temperature, sunlight intensity, and relative humidity are high. A night temperature above 16C is particularly important. Under controlled



conditions Lane *et al.* (1954) found that plant response to a defoliant doubled for each 10 degree rise between 15C and 35C. They reported that only 40 percent of the leaves had fallen from plants after 21 days in a constant 15C temperature regime. When the diurnal temperature average was 24C, the abscission rate was rapid and a high percentage of the leaves fell.

A high relative humidity is also best for defoliant action, because it contributes to leaf surface conditions that allow optimum reaction to the chemical (National Cotton Council, 1950). With high relative humidity, evaporation and transpiration are reduced, the internal moisture of the leaf remains relatively high, and the chemical is retained in a liquid state on the leaf surface for a longer period of time. These conditions promote absorption of the chemical into the leaf, which is necessary to begin the physiological process of abscission.

The response to defoliant chemicals is reduced during periods of cloudy weather. The nature of the reduced effect is not fully understood, although, usually lower temperatures are associated with cloudy weather. Brown and Hyer (1954), however, reported that extended dark periods reduced the effectiveness of defoliants on plants grown under controlled conditions. This suggests that more factors than temperature are involved.

Although the use of chemicals to prepare cotton for harvest has been commercially successful for over 40 years, there are still many failures. Most of the failures are related to either plant or environmental conditions that are not conducive to maximum plant response to the defoliant chemical. In efforts to increase plant response to defoliants under these adverse conditions, numerous components have been used as additives to the defoliant mixture. These additives include various surfactant-type chemicals as well as products that have senescent and/or abscission-inducing properties. The effectiveness of many of these additives has not been well established, however.

Brown (1957) reported that surfactants increased the effectiveness of defoliant chemicals in Arizona, but results in Mississippi have been inconsistent, even when used in adverse environments (Cathey, 1979). The addition of an endothall [7-oxabicyclo-(2.2.1)heptane-2,3-dicarboxylic acid] formulation usually causes slightly earlier leaf drop, but by the seventh day after application results are similar to those from the defoliant treatment alone (Ford *et al.*, 1970; Cornelius *et al.*, 1970). There is a possibility, however, of a synergistic effect when endothall is used in combination with defoliants (Davis *et al.*, 1972; Sterrett *et al.*, 1973). The addition of small quantities of paraquat (1,1'-dimethyl-4,4'-bipyridinium ion) to defoliant chemicals, applied after adverse weather conditions develop, has increased abscission of juvenile leaves in plant terminals (Kirby and Stelzer, 1968; Cornelius *et al.*, 1970). Morgan and Durham (1975) used gibberellic acid to enhance ethylene-induced abscission and suggested that GA might improve the performance of several of the defoliant chemicals.

The experimental growth regulator chemical TD-1123 (potassium 3,4-dichloro-isothiazole-5-carboxylate) was used successfully to induce senescence in

cotton leaves and caused an increased response to subsequent defoliant treatments (Arle, 1976; Cathey, 1978). Defoliation was increased by as much as 25 percent, without an adverse effect on yield or quality, when TD-1123 was applied 10 days before the regular defoliant treatment. Sequential treatments of TD-1123 and the defoliant have an apparent synergistic effect on several physiological events that occur during the abscission process (Elmore *et al.*, 1978; Cathey *et al.*, 1981c). For example, most parameters that are affected by a defoliant chemical are not altered by TD-1123 but become more pronounced and occur earlier in sequentially treated leaves. Relatively low rates of defoliant chemicals have been used to accomplish effects similar to those caused by TD-1123 (Thomas, 1965; Cathey and Hacskaylo, 1971). This is not a widespread practice, however, because of inconsistent results and an occasional excess of premature leaf fall (Thomas, 1965). Sequential treatments with defoliant chemicals apparently increased defoliation by affecting both states of the "two-stage" abscission process. Cathey and Hacskaylo (1971) reported consistent improvements in defoliation when a given quantity of a defoliant chemical was applied in sequential applications rather than as a single treatment.

## SUMMARY

Cotton leaf abscission is a physiological process that involves an active separation of living tissue from the plant. As leaves become senescent because of age, stress or injury, the process is initiated and leaf fall follows. Separation occurs in a specialized area of the leaf petiole located near its base and is characterized by a line of weakness across the petiole. The mechanism of leaf abscission involves complex actions and interactions of many substances within the plant as well as various external factors. The abscission process is the result of increased pectinase and cellulase activity within the abscission zone that degrades the walls and middle lamella of cells of the separation layer. This enzyme activity, however, is regulated by the hormone balance within the plant. The major hormones involved include IAA, ABA, ethylene, GA and cytokinin. The auxins IAA and NAA are strong inhibitors of abscission while ABA and ethylene are primarily promotive; gibberellic acid and cytokinin have variable effects depending upon concentration, site of application and tissue involved.

Exogenous chemical defoliation is a cultural practice used to induce abscission of cotton foliage earlier than normal. It has become an important practice in the production of high quality fiber and is considered a necessary aid to machine harvesting when yields are high and plants have green succulent foliage. Defoliant chemicals are used to induce sufficient leaf injury that will alter the hormone balance of the plant and initiate the abscission process. Several products are commercially available that have this ability; however, their effectiveness varies with plant and environmental conditions that prevail at application time. Maximum efficiency with most defoliant require that the plants be uniformly devel-

oped and have a large percentage of the leaves relatively mature and free of moisture stress. In addition, atmospheric temperature and humidity should be relatively high. A few products have been developed for use as additives to defoliant chemicals to enhance defoliation under adverse plant and environmental conditions. Their effectiveness is questionable, however, and none of these products are in widespread use.

*SECTION II*

**PHOTOSYNTHATE PRODUCTION  
& DISTRIBUTION**

## Chapter 15

# THE BIOCHEMISTRY OF PHOTOSYNTHESIS

Richard G. Jensen  
University of Arizona  
Tucson, Arizona

## INTRODUCTION

The unique and important feature of plants is their ability to grow using sunlight as the source of energy and  $\text{CO}_2$  from the air as the carbon source with water and elements coming from the environment or soil. The process of photosynthesis with light capture, coupled with  $\text{O}_2$  evolution and  $\text{CO}_2$  fixation, occurs in the chloroplast. This organelle operates in a semi-autonomous fashion with many of its metabolic processes apparently independent of direct cytoplasmic control. In the light the chloroplast generates its own ATP and reducing power with which  $\text{CO}_2$  is assimilated. The carbon is either exported as triose phosphates to the cytoplasm or stored in the chloroplast as starch. In the dark, reducing power can be generated by a hexose monophosphate shunt in the chloroplast.

## MORPHOLOGY OF HIGHER PLANT CHLOROPLASTS

The chloroplast, as it appears in most published electron micrographs, usually has a characteristic lens shape with a length of 4 to 10 picometers (pm). There are three major structural regions of the chloroplast: the double outer membrane or envelope; the mobile stroma containing the soluble enzymes for metabolism, protein synthesis and starch storage; and the highly organized internal lamellar membranes containing chlorophyll and involved in the biophysical reactions of energy capture and conversion (Figure 1). The internal membranes are shaped like discs and are often stacked together like a pile of coins to form a granum. Each disc is vesiculated or saclike and is termed a thylakoid. If sectioned in a plane parallel to the thylakoid membrane, both the chloroplast and the membranes appear disc-shaped. The outer envelope is a selectively permeable double membrane that regulates the movement of carbon intermediate products, reducing power and adenylates in and out of the chloroplast, while retaining starch for degradation at night. The stroma is mostly protein, consisting of about 50 percent of "fraction 1 protein" or ribulose-1,5- $\text{P}_2$  carboxylase/oxygenase.

The thylakoid membranes of most higher plants such as cotton are structurally

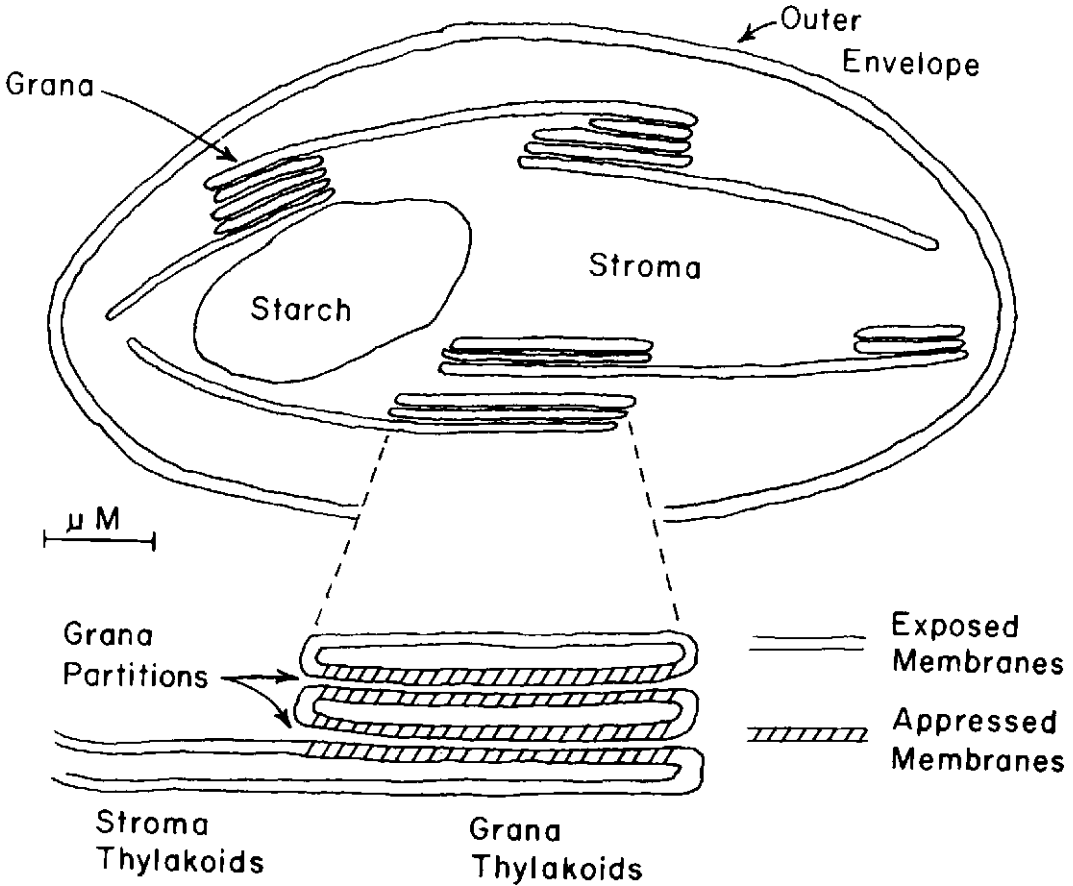

Figure 1. Diagram of the compartments typical of a higher plant chloroplast. An enlargement is shown to depict the grana and stroma thylakoid membranes. Photosystem I particles are mostly located in the exposed membrane regions (stroma thylakoids and exposed ends of the grana thylakoids) while photosystem II particles are enriched in the oppressed membrane regions (grana partitions). (Anderson, 1981).

organized into a network of closely contacting appressed membranes, the grana thylakoids, which are interconnected with single, unstacked membranes, the stroma thylakoids (Figure 1). The innersurface of these thylakoid membranes encloses a space which is continuous between the grana and stroma thylakoids. The thylakoids have two distinct membrane regions called exposed and appressed membranes. The exposed thylakoids whose outer surfaces are in direct contact with the stroma, include stroma thylakoids and the end membranes of the grana

stacks. In contrast the outer surfaces of the appressed membranes of the grana partitions have limited access to the stroma.

## FUNDAMENTAL ENERGY PROCESSES IN PHOTOSYNTHESIS

*Photosynthesis as it operates in the chloroplast has two phases, the light reactions, which are directly dependent on light energy, and the dark reactions, which can occur without the direct influence of light. Research over the last 30 years has heavily concentrated on the light reactions of photosynthesis. They are primarily responsible for converting light energy into chemical energy in the form of ATP and NADPH. These compounds in turn bring about the reduction of carbon dioxide to sugar and other products. The light reactions require the cooperative interactions of two kinds of photosystems, known as photosystem I and photosystem II.*

Early observations indicated that the rate-limiting step in plant photosynthesis takes place in the dark (Myers, 1971). When photosynthetic organisms are subjected to intermittent illuminations with short flashes of light (milliseconds or less) followed by dark intervals of varying duration, evolution of  $O_2$  after a single flash of  $10^{-5}$  s was maximal, if it was followed by a much longer dark period (greater than 0.06 s). The term "dark reactions" does not mean that they take place only in the dark; in living plants they function together with the light reactions in light. At night while the leaf respire many of the dark reactions of photosynthesis are inoperative. As explained later, the "dark reactions" communicate with the action of the light reactions not only by utilization of ATP and NADPH but by light-generated pH and  $Mg^{2+}$  gradients in the stroma in the presence of a reducing environment.

### ROLE OF THE PIGMENT SYSTEMS

The various photosynthetic pigments involved in light absorption from higher plants can be classified into two main groups: chlorophyll and carotenoids. The function of these pigments is to provide the plant with an efficient system of absorbing light throughout the visible spectrum (Vernon and Seely, 1966). This energy is then transferred to reaction centers where it is utilized in a photochemical reaction. The bulk of the pigments are light-harvesting pigments involved in the process of light absorption and subsequent energy transfer.

There are two kinds of chlorophyll in higher plants, chlorophyll *a* and chlorophyll *b*. Chlorophyll *a* (Chl *a*) is the major pigment and is found in all photosynthetic organisms that evolve oxygen. In the plant, Chl *a* has various forms with different absorption maxima, due to unique environments, e.g., Chl 660, 670, 680, 685, 690 and 700-720 nanometers (nm). The evidence for the existence of these various forms comes from derivative spectrophotometry, low-temperature absorption measurements and the action spectra of various photochemical reac-

tions. The short-wavelength Chl *a* forms are fluorescent and are predominantly present in photosystem II. The long-wavelength forms are weakly fluorescent and are mostly present in photosystem I.

Chlorophyll *b* (Chl *b*), also present in higher plants, has a major absorption maxima at 650 nm, with a minor component in some species at 640 nm. The major portion of Chl *b* is present in photosystem II.

Chlorophyll *in vivo* is noncovalently bound to protein in the thylakoid membrane. Upon treatment with organic solvents, the weak interactions between chlorophyll and the membrane components are eliminated, and its absorption maximum shifts to a lower wavelength, depending on the solvent-chlorophyll interactions.

The carotenoids are the yellow and orange pigments found in most photosynthetic organisms. The two classes of carotenoids are (1) carotenes absorbing blue light, of which  $\beta$ -carotene is the most common; and (2) carotenols or alcohols, commonly called xanthophylls. Most of the carotenes are present in photosystem I while the xanthophylls are located in photosystem II. Both of these carotenoid pigments function by absorbing light, mostly in the regions of the spectra not absorbed by chlorophyll, and transferring the energy to Chl *a*. They also help protect chlorophyll from photo-oxidation.

## SPATIAL ORIENTATION OF THE PHOTOSYSTEMS

Anderson (1981) has proposed that there is a large heterogeneity in the distribution of photosystem I and photosystem II in thylakoids of higher plants. Freeze-fracture electron microscopy has revealed a difference in the size, shape and density of particles located in appressed and exposed membranes (Figure 1) (Arntzen, 1978; Arntzen and Briantais, 1975; Staehelin, 1976). This suggests a difference in the distribution of macromolecular complexes of thylakoid membranes in the two regions. This striking difference of the structural organization of the thylakoids is also substantiated by a differentiation of function. The fractionation of thylakoids into grana and stroma thylakoid fractions either by detergent or mechanical methods has yielded fractions derived from the appressed membranes enriched in photosystem II while small vesicles derived from the stroma thylakoids are enriched in photosystem I. Few if any photosystem I complexes are present in the appressed membranes at the grana partitions. In this model of the spatial separation of photosystem I and II, it appears that plastoquinone, as part of the electronic transport chain, is the most likely candidate for the mobile electron carrier between the two photosystems.

As each photosystem is supplied by about 300 antenna Chl, each electron transport chain may pass a pair of electrons once every 20 ms in well-operating chloroplasts. Were a single Chl molecule to drive the reaction, there would not be enough light quanta to suffice, even if the molecule were exposed to bright sunlight. An average Chl molecule absorbs one quantum of light per 100 ms under bright sunlight, one per second under diffused daylight, and only one per 10 s



on a cloudy day. An organized pool of Chl with several energy transfers occurring simultaneously is essential to match the rather low absorption rate of quanta per Chl to the higher rates of electron transport. A typical thylakoid disc from a mature spinach chloroplast contains at least  $10^5$  Chl molecules and its membrane is covered by at least 200 electron transfer chains.

### FLOW OF ELECTRONS IN LIGHT

Light quanta absorbed by the chlorophyll and carotenoid pigments are funneled into specific photochemical reaction centers. The efficiency of this energy transfer is high, implying that the probability for transfer of a quantum between two neighboring pigments is higher than the probability for any competing process such as fluorescence emission, formation of metastable states, wasteful photochemistry and radiation-less deactivation. As these processes usually occur within nanoseconds, the transfer through the whole light-harvesting antenna pigment system to a reaction center must occur in a much shorter time. Rapid transfer of energy occurs via dipolar coupling between pigments which are tightly packed and communicate by resonance. Because energy transfer is enhanced when the absorption spectra of neighboring pigments overlap, it is not unusual to note that the reaction centers have absorption maxima at longer wavelengths (lower energy).

The end result of photosynthetic electron flow in the chloroplast is the evolution of oxygen and the formation of ATP and NADPH necessary for the assimilation of  $\text{CO}_2$ . The currently accepted representation of photosynthetic electron transport is one of a cooperative interaction of two light reactions. This model originated with Hill and Bendall (1960). A representative of their hypothesis, as it has evolved today, is presented in Figure 2 (Barber, 1977; Govindjee, 1975; Trebst and Avron, 1977). Their formulation was proposed primarily to account for three major experimental observations: (1) the decline in efficiency of photosynthesis at long wavelengths (greater than 685 nm) and the synergistic effect of shorter wavelengths on the photosynthetic action of far red illumination; (2) the presence in green tissues of two cytochromes, cytochrome *f* (Cyt *f*) and Cyt  $b_6$ , whose characteristic potentials differed about 400 mV, as did their light-induced absorption changes; and (3) the stimulation of electron flow to  $\text{NADP}^+$  when ATP formation occurred concurrently. According to the model (Figure 2), photosystem II oxidizes water to free  $\text{O}_2$  and reduces Q, while photosystem I reduces a low potential electron acceptor X and oxidizes P-700. Q may be equivalent to a component producing an absorbance change at 550 nm, referred to as C-550. Similarly, X appears to be a pigment having an absorption change at 430 nm and is referred to as P-430. Oxidized P-700 is reduced by reduced Q via exergonic electron transport reactions that are coupled to the phosphorylation of ADP to ATP. The oxidation of water also provides protons and a membrane potential to run a second phosphorylation of ADP. These two steps of ATP production occur during noncyclic electron flow and are called noncyclic photophosphorylation.

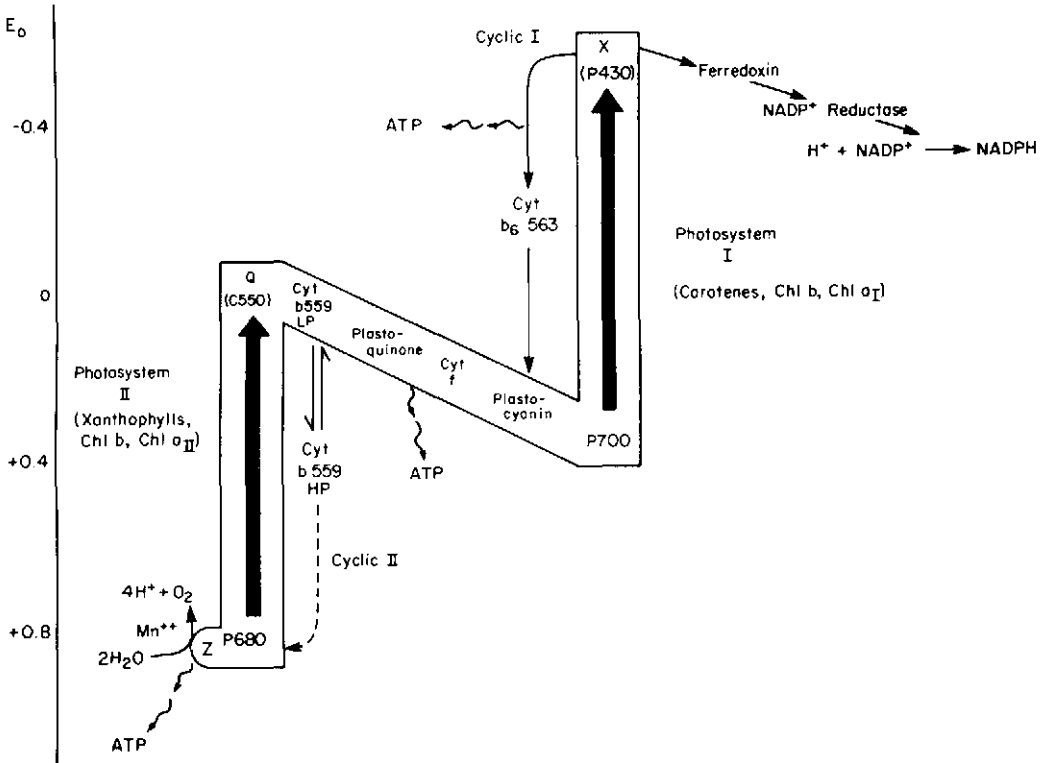

Figure 2. The Z-scheme for photosynthetic electron transport including sites of coupling for photophosphorylation. This model originated with Hill and Bendall (1960).

The carriers catalyzing the electron flow reactions are Cyt b-559 (low potential), plastoquinone (PQ), Cyt f, and plastocyanin (PC), in that order. The site of phosphorylation is probably between PQ and Cyt f.

The low potential electron acceptor X for photosystem I can transfer energy to form NADPH via a ferredoxin reducing substance, ferredoxin (Fd) and the ferredoxin-NADP<sup>+</sup> reductase. Alternatively, energy from the primary acceptor X can cycle back to Cyt f or PC by way of Cyt b<sub>6</sub>. In this latter instance the electron transport traces a closed circuit utilizing only photosystem I. It is referred to as cyclic electron transport and the accompanying formation of ATP is designated cyclic photophosphorylation. The amount of cyclic photophosphorylation that occurs *in vivo* is still uncertain.

## PHOTOSYSTEM II AND EVOLUTION OF OXYGEN

Photosystem II of higher plants is associated with oxygen evolution to provide

electrons for the subsequent reductive processes mediated by the electron transport chain and photosystem I. The pigment-enzyme complex of photosystem II is located mostly on the appressed membranes of the grana thylakoids where it exhibits a high degree of structural and organizational integrity. The trap Chl of photosystem II exists in a reaction center complex with a primary electron donor Z and a primary acceptor Q (Velthuys, 1980). When the reaction center complex is in the proper redox state, the trapping of an exciton by the chlorophyll pool is funnelled to the trap Chl *a* (P-680). This creates a photochemical product by separation of charge between Z and Q. Oxidized Z ( $Z^+$ ) can then receive an

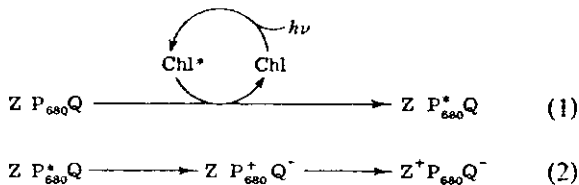

electron by oxidation of water comprising a multistep procedure. The chemical nature of the primary Z complex is unknown at present. Tightly bound  $\text{Mn}^{2+}$  appears to be associated with Z, with  $\text{Cl}^-$  also shown to be essential.

Little is known about the biochemical mechanism of  $\text{O}_2$  evolution. One of the functional problems is to understand how four photoreactions, which correspond to the transfer of four electrons, are able to cooperate to produce one  $\text{O}_2$  molecule. Most of our present knowledge comes from kinetic studies. When dark-adapted chloroplasts were submitted to a series of short saturating flashes ( $10^{-5}$  s), the amount of  $\text{O}_2$  evolved per flash oscillated with a periodicity of four. From these experiments Joliot and Kok (1975) concluded that the cooperation between four photoreactions occurs at the same photocenter with each photocenter being independent of the other.

### PHOTOSYSTEM I AND THE REDUCTION OF $\text{NADP}^+$

Photosystem I has a characteristically longer absorption maximum than photosystem II. It is involved in moving electrons to reduce  $\text{NADP}^+$  or to provide for cyclic electron flow to give extra ATP without net electron transport. It has been hard to identify the primary electron acceptor for photosystem I. In 1971, a spectroscopic component, P-430, was discovered that exhibited properties necessary for the primary acceptor (Hiyama and Ke, 1971). The chemical identity of this component has been speculated to be bound Fd. At least one to two bound nonheme iron sulfur centers exist at the reducing end of photosystem I, and a large amount of nonheme iron or Fd is bound to the thylakoid membrane. Studies with enriched photosystem I particles indicate a large pool of iron-sulfur protein of four to five times the amount of P-700, PC or Cyt f. The rest of the reducing side of photosystem I is one of the best understood segments of the photosynthetic electron transport pathway (see Malkin, 1982). There are two soluble proteins involved in the direct transfer of electrons from the reducing membrane-bound P-

430 to  $\text{NADP}^+$ . The first is soluble Fd which has been shown to be photoreduced by isolated chloroplasts. Ferredoxin is a reddish brown protein having a potential of  $-430$  mV. It contains 2 moles of nonheme iron and acid-labile sulfur per mole of protein and functions as a one-electron carrier, as shown by the ability of 1 mol of  $\text{NADP}^+$  to oxidize 2 moles of reduced Fd. A second protein, ferredoxin- $\text{NADP}^+$  oxidoreductase, is necessary for the collection and transfer of electrons, one at a time, from ferredoxin to the two-electron reduction of  $\text{NADP}^+$ . This enzyme contains one bound FAD per molecule. Reduced X and/or reduced ferredoxin also appear to regulate the activities of some of the enzymes involved in carbon flow during photosynthesis.

P-700 is the primary donor of photosystem I. Its concentration in the chloroplast is about 1 per 400 Chl. Redox titrations have established it as a single electron carrier with a potential of 450 mV. Most likely P-700 itself is a chlorophyll localized in a special environment. Because its absorbance band is at a slightly longer wavelength than the bulk light-harvesting chlorophylls, most of the excitation energy captured by the bulk chlorophyll will be funneled to P-700. P-700 has been isolated in a Chl  $\alpha$ -P-700 protein complex with 40 Chl  $\alpha$  per P-700 and 90,000 MW.

## INTERMEDIATES OF ELECTRON TRANSPORT

Identification of the primary electron acceptor of photosystem II (Q or C-550) has been complicated partially by the confusion concerning the roles of Cyt b-559 and P-680. It appears that Cyt b-559 can exist as two forms: a low potential form Cyt b-559, with a potential of about 80 mV interconvertible to a high potential form of 350 mV. The exact physiological role of these two forms is not clear, but it seems likely that the low potential form interacts with the electron transport chain between the two photosystems via plastoquinone, while the high potential form is involved in a cyclic flow of electrons around photosystem II.

Plastoquinone (PQ) is the name given to a mixture of related electron transport quinone intermediates—the principle component is PQ A. The concentration of plastoquinone is much higher than that of the other electron transport intermediates. It is normally present in a concentration equal to 5-10 percent of the total chlorophyll or 10-14 molecules per photosystem I or photosystem II unit. The rate-limiting step for photosynthetic electron transport is the oxidation of reduced plastoquinone by plastocyanin through Cyt f with a half-time of 20 ms (Witt, 1975). At least 10 photosystem II reaction centers are interconnected by the plastoquinone pool.

Cytochrome f is the best known of the photosynthetic cytochromes. It can be released by gentle procedures from the photosynthetic membranes of several higher plants. It has a characteristic absorption peak for the reduced form of 554 nm, with a redox potential of 365 mV. Although called Cyt f, it is actually a c-type cytochrome. Because of its association with the green part of the plant, f, for the latin *folium* (leaf), was used.

Plastocyanin (PC) is the electron donor to P-700. It is thought to mediate electron transfer from Cyt *f*, plastoquinone and photosystem II to feed photosystem I. It is a copper protein with a characteristic blue color in the oxidized form. Chloroplasts contain a Chl/plastocyanin ratio of about 300 with plastocyanin accounting for one-half the total copper in the chloroplast. The redox potential of spinach plastocyanin is 370 mV.

The second b-type cytochrome in photosynthetic tissue is Cyt *b<sub>6</sub>* or *b-563*. It has a potential of about zero volts and is auto-oxidizable. Although originally proposed to function in the main electron transport flow, it has now been shown to mediate cyclic flow between X and the electron transport chain. Its interaction is probably with Cyt *f* or plastocyanin, or possibly even through the large plastoquinone pool.

### PHOTOPHOSPHORYLATION

Part of the absorbed light energy is conserved in the formation of ATP. Chloroplasts in the light are capable of high rates of ATP formation. This process is very similar to the coupled conservation of energy during respiration with electron transport in mitochondria. In plants this light-activated process is called photophosphorylation.

Both electron transport and photophosphorylation are said to be "coupled." No phosphorylation will occur unless electron transport is proceeding. Conversely, there should be no electron transport unless ADP and Pi are present to permit simultaneous phosphorylation. Actually, isolated chloroplasts always have a small amount of electron transport in the absence of added ADP or inorganic phosphate due to leaks in the system. Investigations with isolated chloroplasts suggest that the coupling of phosphorylation to electron transport may not be tight (Krause and Heber, 1976). The photosynthetic apparatus appears to adjust itself to lower values when lower stoichiometric amounts are needed for photoreduction, *i.e.*, the chloroplast *in vivo* operates with a flexible  $P/2e^-$  ratio. The control of this flexible ratio may involve the concentration of ADP or the breakdown of the proton gradient across the thylakoid.

Photophosphorylation occurs in intact thylakoids with an aqueous phase inside and out and whose membrane is relatively impermeable to protons or hydroxide ions. The electron transport intermediates are embedded anisotropically across the membrane. The hydrogen carriers are believed to be so oriented in the membrane that when an electron is passed the necessary proton to complement it comes from outside the vesicle. In turn, when giving up the electron it is to an electron acceptor on the inside with a complementary proton released on the inside. In this way, due to the geometry, electron transport through the chain is coupled obligatorily to vectorial proton translocation across the membrane. The first internal protons are those released from water splitting, and this constitutes site II for energy conservation. The second coupling site, site I, operates during the sequential reduction, with the reoxidation of plastoquinone (PQ). Because PQ

is a pool of molecules, the shuttle may actually involve transfer between several or many molecules before complete oxidation and reduction across the pool has occurred.

The membrane-bound enzyme that is involved directly in photophosphorylation is called chloroplast coupling factor one ( $CF_1$ ). It sits on the exposed surface of the thylakoid membrane and can be released by dilute EDTA. With an approximate 325,000 MW, it is composed of five different polypeptide subunits. It can move laterally in the membrane since antibodies make the knobs clump together. There appears to be one  $CF_1$  per 500-850 Chl. The  $CF_1$  acts as a proton translocator and, as well, as an ATP synthetase. There is no indication that  $CF_1$  protein penetrates all the way through the membrane although the protons must move completely through. Apparently, there are highly hydrophobic proteins in the membranes which, as intrinsic components of the membrane, serve as a point of attachment of the  $CF_1$  to facilitate ATP synthesis.

For many years when the maximum  $P/2e^-$  ratios in intact chloroplasts were thought to be below 1.5, additional electron transfer steps for synthesis of extra ATP were considered. One of the most important has been cyclic phosphorylation supported by cyclic electron flow in photosystem I (Figure 2). There is no compelling evidence to show that cyclic photophosphorylation plays a significant role in higher plants under natural aerobic conditions. Rather, in intact leaves or in chloroplasts,  $O_2$  does readily react with an electron carrier beyond photosystem I. In an  $N_2$  atmosphere intact leaves exhibit strong chloroplast shrinkage under far-red illumination (which excites preferentially photosystem I) indicative of photophosphorylation by cyclic electron transfer. As very low levels of  $O_2$  (0.1 percent) reversed this effect, it seems that  $O_2$  can easily drain electrons from the cyclic pathway and thereby inhibit cyclic photophosphorylation. Yet, oxygen does support photophosphorylation in light using both photosystems. Apparently, electrons transferred through the two photosystems will either move to  $NADP^+$  or, if this is reduced, can be transferred to molecular  $O_2$  (Mehler reaction). In this reaction,  $H_2O_2$  could leave the chloroplast by diffusion and be decomposed by catalase in the peroxisomes. Such a system would be self regulating with respect to photophosphorylation, as  $NADP^+$  has a much greater affinity as the terminal electron acceptor than  $O_2$ . There are several indications that this regulation occurs in intact plants. During induction of  $CO_2$  fixation, ATP can become limiting whereupon NADPH accumulates and less  $NADP^+$  is available for reduction. Electrons are then diverted to oxygen which results in additional photophosphorylation without  $NADP^+$  reduction. This process is termed pseudocyclic electron transport, or Mehler reaction, as oxygen evolution and oxygen uptake balance each other and no net  $O_2$  change is observed.

## CARBON METABOLISM DURING PHOTOSYNTHESIS

The light-produced intermediates, ATP and NADPH, are utilized in the chloroplasts to fix  $\text{CO}_2$  and reduce it to the level of carbohydrates. Parts of the reduced carbon remains as starch in the chloroplast for utilization at night, while the rest is transported to the cytoplasm to form sucrose and organic and amino acids. Those products, which are formed in the chloroplast and transported to the cytoplasm, are two and three-carbon compounds: glycolate, 3-phosphoglycerate (glycerate-3-P), and the triose phosphates (triose-P), dihydroxyacetone phosphate and glyceraldehyde 3-phosphate (glyceraldehyde-3-P). Depending on needs of the plant, 25-50 percent of the fixed carbon is stored as starch in the chloroplast.

### PHOTOSYNTHETIC CARBON REDUCTION PATHWAY (CALVIN CYCLE)

The only pathway for net  $\text{CO}_2$  fixation resulting in carbon incorporation into hexoses is the reductive photosynthetic carbon cycle (Bassham and Calvin, 1957). Even though  $\text{C}_4$  plants initially fix  $\text{CO}_2$  into oxaloacetate which is converted into malate and aspartate, these must be decarboxylated so that the  $\text{CO}_2$  released can be refixed by way of the photosynthetic carbon cycle. Many of the reactions of the photosynthetic carbon cycle are similar to steps of the glycolytic pathway and the hexose monophosphate shunt and consist of three different phases of carbon metabolism (Figure 3). The first phase is the production of ribulose-1,5-bisphosphate (ribulose- $\text{P}_2$ ) and its carboxylation, steps that are unique to the photosynthetic carbon cycle. The second is the reduction of glycerate-3-P to the level of an aldehyde, glyceraldehyde-3-P. The third phase involves the disproportionation of triose-P to produce pentose monophosphates, the precursors for ribulose- $\text{P}_2$ , by way of tetrose, hexose and heptose phosphates.

$\text{CO}_2$  is incorporated by carboxylation of ribulose- $\text{P}_2$ , catalyzed by ribulose 1,5-bisphosphate carboxylase/oxygenase (ribulose- $\text{P}_2$  carboxylase). The initial products are two molecules of glycerate-3-P. The ribulose- $\text{P}_2$  carboxylase catalyzes a second important reaction whereby molecular  $\text{O}_2$  reacts with ribulose- $\text{P}_2$  to form phosphoglycolate (P-glycolate) and glycerate-3-P. P-glycolate phosphatase releases glycolate which diffuses from the chloroplast to be the substrate for photorespiration.

In the presence of ATP, glycerate-3-P is phosphorylated to glycerate-1,3- $\text{P}_2$  by action of glycerate-3-P kinase. Glycerate-1,3- $\text{P}_2$  is reduced by NADP-glyceraldehyde-3-P dehydrogenase and NADPH with release of inorganic phosphate to give glyceraldehyde-3-P. Glyceraldehyde-3-P quickly equilibrates with dihydroxyacetone phosphate by triose-P isomerase. These two triose phosphates are combined by aldolase to form fructose 1,6-bisphosphate (fructose- $\text{P}_2$ ). Then, fructose 6-phosphate (fructose-6-P) is formed by the action of fructose- $\text{P}_2$  1-phosphatase, a regulatory enzyme which controls the flow of carbon to subsequent pathways.

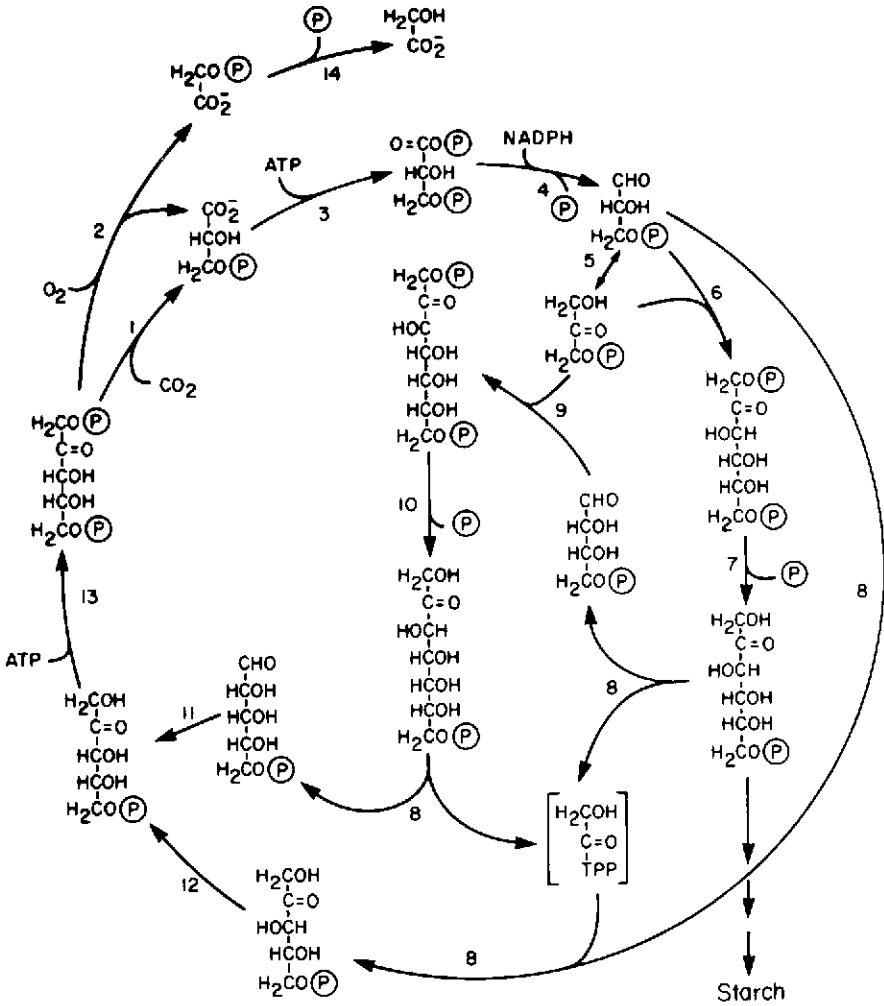

Figure 3. Photosynthetic carbon reduction pathway or Calvin cycle. The enzymes involved are (1,2) ribulose- $\text{P}_2$  carboxylase/oxygenase; (3) glycerate-3- $\text{P}$  kinase; (4) NADP-glyceraldehyde-3- $\text{P}$  dehydrogenase; (5) triose- $\text{P}$  isomerase; (6) aldolase; (7) fructose- $\text{P}_2$  1-phosphatase; (8) transketolase; (9) aldolase; (10) sedoheptulose- $\text{P}_2$  1-phosphatase; (11) ribose-5- $\text{P}$  isomerase; (12) ribulose-5- $\text{P}$  epimerase; (13) ribulose-5- $\text{P}$  kinase; (14) P-glycolate phosphatase.



The reverse step in glycolysis, by way of phosphofructokinase is also present in the chloroplast, but probably does not operate in the light. Fructose-6-P can be converted to glucose 6-phosphate (glucose-6-P), glucose 1-phosphate (glucose-1-P), and eventually starch. For continuation of the photosynthetic carbon cycle, transketolase cleaves fructose-6-P into erythrose 4-phosphate (erythrose-4-P) and an enzyme-bound glycoaldehyde-thiamine pyrophosphate adduct. Erythrose-4-P and dihydroxyacetone phosphate combine to produce sedoheptulose 1,7-bisphosphate (sedoheptulose-P<sub>2</sub>) which is split by sedoheptulose-P<sub>2</sub> 1-phosphatase to form sedoheptulose 7-phosphate (sedoheptulose-7-P). In a second reaction catalyzed by transketolase, sedoheptulose-7-P is split to ribose-5-phosphate (ribose-5-P) and another bound glycoaldehyde-thiamine pyrophosphate. This activated aldehyde is transferred by transketolase to glyceraldehyde-3-P to produce xylulose 5-phosphate (xylulose-5-P). Ribose-5-P, by way of an isomerase, and xylulose-5-P, by way of an epimerase, are both converted to ribulose 5-phosphate (ribulose-5-P). Lastly, the cycle is completed by the ribulose-5-P kinase forming ribulose-P<sub>2</sub> from ATP and ribulose-5-P.

The net result of the photosynthetic carbon cycle is to fix CO<sub>2</sub> to the oxidation level of a carbohydrate. This requires 3 ATP and 2 NADPH per CO<sub>2</sub> reduced. Thus, to produce one hexose from 6 CO<sub>2</sub>, 18 ATP and 12 NADPH are required.

### REGULATION OF CO<sub>2</sub> FIXATION

Many factors are involved in regulating the rate of photosynthetic carbon assimilation. Under saturating irradiance, CO<sub>2</sub> is limiting for photosynthesis in the atmosphere, and this condition is corrected by growing plants in enriched concentrations of CO<sub>2</sub>. The usual atmospheric level of CO<sub>2</sub> is about 330 ppm, while more than 600 ppm CO<sub>2</sub> with cotton is necessary to saturate photosynthesis (Radin and Ackerson, 1981). The level of CO<sub>2</sub> at the site of carboxylation may be considerably less than 320 ppm, but equal or greater than the CO<sub>2</sub> compensation point (about 50 ppm with C<sub>3</sub> plants). This is due to limitations on CO<sub>2</sub> diffusion by the stomata and mesophyll cell resistances.

Recently it has been noted in this laboratory that photosynthesis with plants using air levels of CO<sub>2</sub> and O<sub>2</sub> is often not limited to regeneration of the carboxylation substrate, ribulose-P<sub>2</sub>. Indeed a comparison of the effects of irradiance on CO<sub>2</sub> exchange rate show that at low, limiting irradiances, the amount of available ribulose-P<sub>2</sub> is high and saturating even though the CO<sub>2</sub> exchange rate is only 10 to 25 percent of maximal. The increase in photosynthesis at higher irradiances is due to increased activity of the carboxylation enzyme, ribulose-P<sub>2</sub> carboxylase/oxygenase, rather than increased concentration of the substrate, ribulose-P<sub>2</sub>, as provided by NADPH and ATP of the light reactions and the Calvin cycle.

### RIBULOSE-P<sub>2</sub> CARBOXYLASE/OXYGENASE

The ribulose-P<sub>2</sub> carboxylase often comprises more than 50 percent of the protein in the chloroplast stroma. It is a protein of high molecular weight (560,000) existing as an aggregate of two types of subunits, large and small

( $L_4S_8$ ). The larger of the two subunits has a molecular weight of 51,000 to 58,000 while the smaller subunit is 12,000 to 18,000 daltons. The large subunit is catalytically active even in the absence of the small subunit. The function of the small subunit might well be regulatory, but how this is accomplished in the molecule remains to be determined (see Jensen and Bahr, 1977). The structure of crystalline tobacco ribulose- $P_2$  carboxylase consists of a two-layered structure each having four large and four small spherical masses. The two layers are arranged about a fourfold axis with four twofold axes perpendicular to it. When viewed down the fourfold axis, the molecule is square (Baker *et al.*, 1977).

The problem of how the ribulose- $P_2$  carboxylase operates and is regulated at air levels of  $CO_2$  *in vivo* is now of considerable research interest. From earlier kinetic studies, it was apparent that the activity of the isolated enzyme, as exhibited by its apparent affinity for  $CO_2$ , was too low to account for the observed rates of photosynthetic  $CO_2$  fixation. The  $K_m(CO_2)$  for the purified ribulose- $P_2$  was reported to be high, between 70 and 600  $\mu M$ . In intact isolated spinach chloroplasts, the apparent  $K_m(CO_2)$  for  $CO_2$  fixation is of the order of 10-20  $\mu M$ . Water, in equilibrium with 1 atm air with 0.03 percent  $CO_2$ , has 10  $\mu M$   $CO_2$  at 25C.

The  $K_m(CO_2)$  of the ribulose- $P_2$  carboxylase assayed upon lysis of chloroplasts was 11-18  $\mu M$  at pH 7.8, which is comparable to that for light-dependent  $CO_2$  fixation by intact chloroplasts. At low  $CO_2$  concentrations, the kinetics of the ribulose- $P_2$  carboxylase is not stable after release from the chloroplast. During assays up to 10 min a lower steady rate is obtained after 3 min, which eventually displays a  $K_m(CO_2)$  value of about 500  $\mu M$ , comparable to that seen in most previous work with the purified carboxylase. Incubation of the enzyme in buffer alone or buffer plus ribulose- $P_2$  before adding  $CO_2$  and  $Mg^{2+}$  hastens the decline in activity. In addition it appears that the ribulose- $P_2$  carboxylase, while still in the intact chloroplast, is not fully activated, and this degree of activation can be altered by incubating chloroplasts with various  $CO_2$  concentrations.

As the rate of carboxylation of ribulose- $P_2$  in the plant defines the rate of gross photosynthesis, the rate of ribulose- $P_2$  oxygenation is the major determinant for glycolate production for photorespiration.  $O_2$  has been shown to be a competitive inhibitor of carboxylation, as  $CO_2$  is of oxygenation. The relative rates of the two reactions are regulated by the concentration of  $O_2$  and  $CO_2$ . Where both reactions have been measured under the same conditions, effector metabolites such as NADPH, gluconate-6-P and glycerate-3-P activate or inhibit both reactions to the same extent.

The time-dependent and order of addition-dependent kinetics of ribulose- $P_2$  carboxylase are a result of the activating effects of  $Mg^{2+}$  and  $CO_2$  and the inactivating effects of ribulose- $P_2$ , in addition to their roles as substrates (Figure 4). The initial activity of the enzyme responds to the concentration of  $CO_2$  and  $Mg^{2+}$  during preincubation, indicating the reversible formation of an active enzyme- $CO_2$ - $Mg^{2+}$  complex. Kinetic analyses have indicated that the enzyme is activated by a slow, but reversible, initial binding between enzyme and  $CO_2$  followed by a rapid reaction with  $Mg^{2+}$ . The amount of activation is a function of

both  $\text{CO}_2$  and  $\text{Mg}^{2+}$  concentration and the final degree of activation at fixed  $\text{CO}_2$  and  $\text{Mg}^{2+}$  is sharply pH dependent with a distinctly alkaline  $\text{pK}_A$ . The relationship between  $\text{CO}_2$  and  $\text{Mg}^{2+}$  concentrations and pH during activation suggests that the protonated enzyme does not react with  $\text{CO}_2$ . When the enzyme is first incubated with ribulose- $\text{P}_2$  and the reaction is initiated with  $\text{Mg}^{2+}$  and  $\text{CO}_2$ , a marked lag is observed in the course of product formation.

Activation of the carboxylase followed by reaction with either  $\text{CO}_2$  to give two molecules of glycerate-3-P or  $\text{O}_2$  to give P-glycolate and glycerate-3-P is shown in the scheme of Figure 4.  $\text{Mg}^{2+}$  and  $\text{CO}_2$  are necessary for enzyme activation with the first  $\text{CO}_2$  separate from the  $\text{CO}_2$  involved in catalysis. When spinach chloroplasts are lysed in the presence of saturating amounts of ribulose- $\text{P}_2$ ,  $\text{Mg}^{2+}$  and

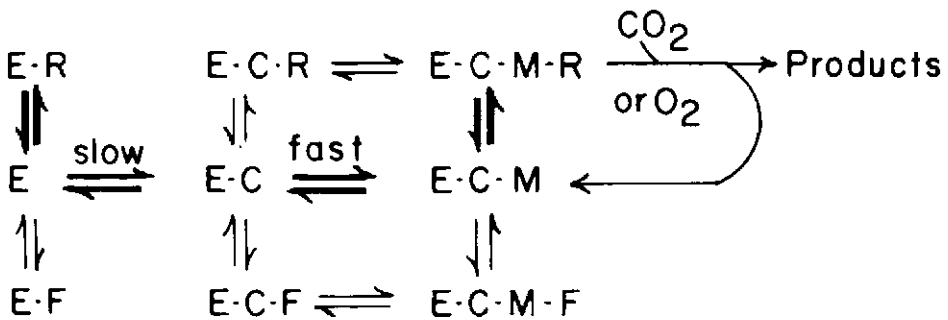

Figure 4. Mechanism of activation of the ribulose- $\text{P}_2$  carboxylase/oxygenase (E) by  $\text{CO}_2$  (C) and  $\text{Mg}^{2+}$  (M). The active form,  $\text{E} \cdot \text{C} \cdot \text{M}$ , when bound to ribulose- $\text{P}_2$  (R) reacts with either  $\text{CO}_2$  or  $\text{O}_2$  to form products. Other effector metabolites (F) can also bind with the enzyme to influence its kinetics.

$\text{CO}_2$ , the initial rate of  $\text{CO}_2$  fixation can be about  $200 \mu\text{moles/mg Chl} \cdot \text{h}$ . If upon lysis the extract is allowed to activate in the presence of  $\text{Mg}^{2+}$  and bicarbonate, then ribulose- $\text{P}_2$  added, the rate of fixation can be  $300\text{--}400 \mu\text{moles/mg Chl} \cdot \text{h}$ . The amount of activation measured corresponds to the amount of the enzyme that exists as the  $\text{E} \cdot \text{C}$  and  $\text{E} \cdot \text{C} \cdot \text{M}$  forms.

The activity of ribulose- $\text{P}_2$  carboxylase can be variable while the enzyme is in the chloroplast. Incubation of chloroplasts in high  $\text{CO}_2$  levels activates the enzyme, as does illumination. This can be reversed by removing the  $\text{CO}_2$  and/or by dark. The light activation is inhibited by electron transport inhibitors, such as DCMU or uncouplers for photophosphorylation such as CCCP. The chloroplast carboxylase is inactivated in the dark under conditions where the  $\text{E} \cdot \text{C}$  complex can dissociate in a  $\text{CO}_2$ -deficient media. Light activation and dark inactivation can be explained by light-dependent changes of  $\text{Mg}^{2+}$  and pH in the chloroplast (Bahr and Jensen, 1978).

As stated above, with higher plants growing with air levels of  $\text{CO}_2$ , the levels of the substrate, ribulose- $\text{P}_2$ , can be high and saturating under most irradiances. Under these conditions the rate of photosynthetic  $\text{CO}_2$  fixation appears to be

controlled by the activity of the ribulose- $P_2$  carboxylase. In dark, ribulose- $P_2$  drops to less than 10 percent of the amount in light which stops photosynthesis. The mechanisms which control the activity of the ribulose- $P_2$  carboxylase in light most likely involves light mediated changes in the  $Mg^{2+}$  and pH in the chloroplast stroma. In this manner the light reactions exert control over the rate of  $CO_2$  fixation by regulating the activity of the ribulose- $P_2$  carboxylase (Perchorowicz *et al.*, 1981).

### OTHER ENZYMES REGULATED BY LIGHT

Many other reactions of the Calvin cycle are influenced in the chloroplast by light. This influence is not a direct effect of light on the enzyme but is an effect of changing conditions in the chloroplast stroma to cause enzyme activities to increase or decrease. The enzymes which appear to be increased in activity in the light include: NADP-glyceraldehyde-3-P dehydrogenase, glycerate-3-P kinase, fructose- $P_2$  1-phosphatase, sedoheptulose- $P_2$  1-phosphatase and ribulose-5-P kinase. Although not involved in the Calvin cycle, glucose-6-P dehydrogenase becomes inactive in the light. The ribulose-5-P kinase has been shown to become practically inactive in the dark, whereas the other regulated enzymes are stimulated two to eight fold in the light.

The major mechanism for light activation of these enzymes involves transfer of photosynthetically generated reducing power from photosystem I to the reduction of exposed thiol groups on the enzyme protein. One attractive mechanism involves the transfer of electrons from photosystem I to ferredoxin which then reduces a small molecular weight intermediate, thioredoxin, by way of the ferredoxin-thioredoxin reductase. The reduced thioredoxin then interacts with the thiol groups of the enzymes to modulate activity of the enzyme during photosynthesis (Buchanan, 1980). A number of different forms of thioredoxin, each relatively specific for the enzyme being regulated, have been reported. Of interest, not all of these forms are located in the chloroplast.

Complementary to the soluble system described above, activation of these enzymes by thylakoid membrane-bound components has been proposed. These membranous reductants (designated "light effect mediators" or LEMS) are thiol containing components that occur in the oxidized (disulfide) state in the dark and in the reduced (sulfhydryl) state in the light. There are two different LEM components. Both are reduced photochemically by noncyclic electron transport at different sites on the oxidizing side of photosystem I. LEM I is reduced directly by the electron acceptor of photosystem I while LEM II receives reducing power through ferredoxin from photosystem I (Anderson, 1979).

The significance of regulation of photosynthesis by light-mediated activation is self-evident. When light is on there is need to produce ribulose- $P_2$  for carboxylation. However, once the level of this substrate is saturating, modulation of these enzymes still regulates photosynthesis by regulating the products. Modulation at the fructose- $P_2$  and sedoheptulose- $P_2$  1-phosphatases regulates whether carbon

leaves the chloroplast as triose-P or remains in the chloroplast to be stored as starch. Regulation of the NADP-glyceraldehyde-3-P dehydrogenase and glyceralate-3-P kinase control whether glyceralate-3-P leaves the chloroplast or the triose phosphates leave the chloroplast as carbon sources to support sucrose biosynthesis in the cytoplasm.

### STORAGE OF ENERGY BY STARCH ACCUMULATION

The rate of leaf photosynthesis appears to respond proportionately to the rate at which the photosynthetic products are transported and utilized. CO<sub>2</sub> fixation during photosynthesis is often reduced when high accumulations of starch occur in the leaf chloroplast. This led to the hypothesis of product inhibition on photosynthesis. If a cold night prevents the breakdown and translocation of starch, photosynthesis the next day is decreased. If the plants have a greater need for utilization or greater sink requirements, then little starch will accumulate during the day, and the photosynthetic rates will be higher than those with less sink requirements (see Chapter 16). This relationship suggests that photosynthesis may be indirectly inhibited by accumulation of starch, if translocation is limited. However, endogenous sucrose in leaves appears to have little adverse effect on the photosynthetic rate, most likely because sucrose is not formed nor located in the chloroplast where photosynthesis occurs. However, if leaves suspended in solution are fed sugars such as mannose or glucose, the starch content does increase in the light. This increase does not appear to be due to direct glucose incorporation into starch, but rather the results of sequestering cytoplasmic inorganic phosphate (Walker, 1976; Herold, 1980).

The drop in photosynthesis with high starch content in the chloroplast is proposed to be due to the physical distortion of the chloroplast by the starch grains. A chloroplast, largely free of starch grains, is an extremely thin organelle in the living cell. The accumulation of starch between the thylakoids can distort the chloroplast so that it approaches the shape of a sphere. This could increase the *effective path length of CO<sub>2</sub> diffusion or tend to bind Mg<sup>2+</sup>*, and thus reduce the activity of the ribulose-P<sub>2</sub> carboxylase. The actual regulatory mechanisms by which chloroplast starch accumulation limits photosynthesis are still quite speculative and require more investigative research.

Starch biosynthesis in the chloroplast operates by the following reaction:

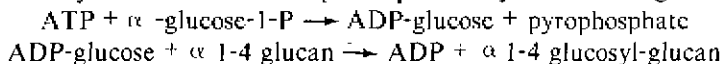

The first step catalyzed by ADP-glucose pyrophosphorylase primes the synthetic route by formation of ADP-glucose. Metabolic regulation of starch formation apparently occurs by control of this allosteric enzyme. The second step is catalyzed by an  $\alpha$  1-4 glucan (starch) synthetase and adds a glucosyl residue to the glucan primer. Usually, the enzyme is intimately associated with the starch granule (Preiss and Levi, 1980).

Another enzyme, starch phosphorylase, is also capable of synthesizing starch:

$$\alpha\text{-glucose-1-P} + \alpha\text{ 1-4 glucan} \rightleftharpoons \alpha\text{ 1-4 glucosyl-glucan} + \text{phosphate}$$

The phosphorylase is most likely involved only in the degradation or breakdown of starch rather than in synthesis because of the high ratio of inorganic phosphate to glucose-1-P in the chloroplast. With isolated chloroplasts, the levels of inorganic phosphate have been measured from a low value of around 4 mM to over 100 mM.

Most studies on the path of starch synthesis and breakdown have been deduced from experiments with purified chloroplast enzymes. They suggest that regulation resides with the ADP-glucose pyrophosphorylase. This enzyme is allosterically affected by intermediates of the photosynthetic carbon cycle, with positive activation by glycerate-3-P and inhibition by inorganic phosphate. Indeed, with isolated chloroplasts, higher amounts of inorganic phosphate in the suspending media do reduce the amount of carbon going to starch. If glycerate-3-P is increased, then there is an increase in starch synthesis. Photosynthesis is also inhibited by high orthophosphate and reversed by glycerate-3-P and triose phosphates. The phosphate inhibition could be caused by a loss of intermediates of the carbon cycle including glycerate-3-P with depletion of the ribulose-P<sub>2</sub> pool. When triose phosphates are added, the phosphate-induced loss of sugar phosphates from the chloroplast is reversed, glycerate-3-P increases, and starch synthesis is enhanced (Heldt *et al.*, 1977).

The control of starch metabolism by levels of inorganic phosphate in the cytoplasm appears to be operating in the leaf. Processes which increase inorganic phosphate in the cytoplasm, such as the hydrolysis of sucrose phosphate to sucrose, facilitate export of triose phosphates from the chloroplast in exchange for inorganic phosphate. When mannose was added to leaf discs of spinach beet, phosphate was sequestered in the cytoplasm as mannose-6-phosphate. Starch formation in these leaf discs was increased tenfold, yet the starch formed was not synthesized from the mannose carbon but from CO<sub>2</sub> (Herold *et al.*, 1976).

Starch stored in the chloroplast during the day is mobilized to soluble products and exported from the chloroplast at night. Isolated chloroplasts loaded with <sup>14</sup>C-starch in the light will remobilize this starch in the dark into glycerate-3-P and maltose as the major products (Peavey *et al.*, 1977; Stitt and Heldt, 1981). This mobilization is promoted by phosphate and inhibited by glycerate-3-P. Comparisons of enzyme activities of cytoplasm with chloroplast fractions of pea suggest that maltose comes from action of maltose phosphorylase rather than β-amylase during starch degradation. The results are consistent with phosphorylytic mechanism of chloroplast starch breakdown.

## PHOTORESPIRATION AND ITS REQUIREMENTS

Photorespiration is the uptake of oxygen and the formation of CO<sub>2</sub> in the light during the metabolic processes associated with photosynthesis. The exchange of oxygen and CO<sub>2</sub> and energy loss from photorespiration occur simultaneously with photosynthesis. Therefore, net photosynthesis is measured as the difference be-

tween the gross or true  $\text{CO}_2$  fixation rate minus the rate of photorespiration. The magnitude of photorespiration as estimated from  $\text{CO}_2$  gas exchange varies among plants from a low and almost immeasurable value for  $\text{C}_4$  plants to high values of 25 to 50 percent of the photosynthetic rate in  $\text{C}_3$  plants. Photorespiration increases with increasing light intensity, temperature and oxygen concentration and with decreasing  $\text{CO}_2$  availability. Gaseous measurements of  $\text{CO}_2$  and  $\text{O}_2$  exchange during photorespiration are generally underestimations since the opposite exchange of photosynthesis masks the true magnitude of the metabolic turnover of photorespiration. At the  $\text{CO}_2$  or  $\text{O}_2$  compensation point, no net  $\text{CO}_2$  or  $\text{O}_2$  exchange between the leaf and its environment is observed because of equal and counterbalancing rates of gas diffusion between photosynthesis and photorespiration. Respiration during the light also adds somewhat to the value estimated as photorespiration. The term "photorespiration" as used today is mostly equivalent to the "Warburg" effect as described for the inhibition of photosynthesis by oxygen (Gibbs, 1969). A few of the many reviews about photorespiration are by Zelitch (1971), Chollet and Ogren (1975), Schnarrenberger and Fork (1976) and Tolbert (1980).

A great number of factors regulate total photosynthetic activity, but when most of these such as water, temperature, nutrient availability and light are optimum, photosynthesis is still limited by the low  $\text{CO}_2$  and high  $\text{O}_2$  content in air (0.33 percent  $\text{CO}_2$  and 21 percent  $\text{O}_2$ ). The light intensity over the upper part of a leaf canopy during the middle of a summer day generally exceeds that which can be used for  $\text{CO}_2$  fixation. Under these optimum conditions the rate of photosynthesis by a cotton plant is limited by the availability of  $\text{CO}_2$ . The rate can be nearly doubled by increasing the  $\text{CO}_2$  content until  $\text{CO}_2$  is no longer limiting or by decreasing the  $\text{O}_2$  content to 2-5 percent to reduce photorespiration. Under this low oxygen the measured rate of  $\text{CO}_2$  gas exchange of photosynthesis is approximately the gross  $\text{CO}_2$  fixation rate.

The low  $\text{CO}_2$  content in the atmosphere provides a severe limitation on the rate of photosynthesis. With high light and high oxygen the plant is quite sensitive to photoinhibition and appears to be protected by the photorespiratory process. Photorespiration consumes or eliminates the excess photosynthetic assimilatory power (ATP,  $\text{NADPH}_2$  or reduced ferredoxin). The main function of photorespiration seems to protect the photosynthetic apparatus and regulate the growth by utilizing excess energy. Photorespiration appears to serve as a protective mechanism against light and oxygen toxicity.

The  $\text{C}_4$  plants utilize a large part of their excess photosynthetic energy to trap and concentrate the  $\text{CO}_2$  in the bundle sheath cells where carboxylation takes place under much higher  $\text{CO}_2$  levels. In a  $\text{C}_4$  plant the true and apparent rate of photosynthesis are about the same, even though there is some internal photorespiration. The photosynthetic rates observed in  $\text{C}_4$  plants are not stimulated by decreasing the  $\text{O}_2$  concentration but they may be increased by higher  $\text{CO}_2$  and light.

The biochemistry and carbon metabolism of photorespiration and photosynthesis are intimately related so that photosynthesis does not occur in air without photorespiration. While the metabolic processes of photosynthesis occur only in the chloroplast, different parts of the photorespiratory pathway occur in the chloroplasts, peroxisomes, mitochondria and cytoplasm. Although photorespiration has no direct photochemical involvement, the process is called photorespiration because it only occurs in the light as a consequence of the excess reducing capacity generated during photosynthetic electron transport.

The pathway of carbon during photorespiration begins with the biosynthesis of glycolate and its eventual metabolism with loss of  $\text{CO}_2$ . This complex pathway, as detailed in Figure 5, can be divided into five different segments which occur in the chloroplast, peroxisomes and the mitochondria. These processes have collectively been referred to as the "glycolate pathway", the " $\text{C}_2$  pathway", or the "photorespiratory carbon oxidation cycle". The photorespiratory pathway has been elaborated along with the Calvin photosynthetic carbon cycle by the use of  $^{14}\text{CO}_2$  tracers and by isolation of enzymes and identification of their compartmentation at each step (Tolbert, 1973). Later experiments using  $^{18}\text{O}_2$  analyzed by mass spectrophotometry indicated that one atom of  $^{18}\text{O}_2$  is incorporated into the carboxyl group of glycolate (Berry *et al.*, 1978). This incorporation occurs during activity of the ribulose- $\text{P}_2$  carboxylase/oxygenase.

**Glycolate Biosynthesis in the Chloroplast**—Carbon is shunted to the photorespiratory pathway by action of the ribulose- $\text{P}_2$  carboxylase/oxygenase and oxygen. The product formed is P-glycolate which comes from carbon atoms 1 and 2 of ribulose- $\text{P}_2$  and  $\text{O}_2$  attacks the bound ribulose- $\text{P}_2$  on the carboxylase/oxygenase enzyme. P-glycolate phosphatase hydrolyzes P-glycolate to glycolate which then is transported to the peroxisomes. Other mechanisms for glycolate biosynthesis have been proposed in the chloroplast, but none seem to fit the complete requirements of high oxygen and low  $\text{CO}_2$  to support photorespiration.

**Glycolate Oxidation and Formation of Glycine in Peroxisomes**—In the peroxisome, glycolate is irreversibly oxidized to glyoxylate by glycolate oxidase. This reaction takes in  $\text{O}_2$  to form glyoxylate plus  $\text{H}_2\text{O}_2$ , which is broken down to water and  $\text{O}_2$  by catalase. The glyoxylate is converted to glycine through the action of several physiologically reversible aminotransferases. Two aminotransferases in leaf peroxisomes are highly specific for glyoxylate and/or the respective amino donor, glutamate or serine. The serine-glyoxylate aminotransferase is a more active enzyme and allows the serine formed to go on to hydroxypyruvate while converting glyoxylate to glycine. However, the formation of one serine requires a conversion of two glyoxylates to two glycines. Thus, a second glyoxylate aminotransferase is necessary, and it is linked to glutamate in the peroxisome. The glutamate is the eventual acceptor of the released  $\text{NH}_3$  in the mitochondria during the conversion of two glycines to one serine.



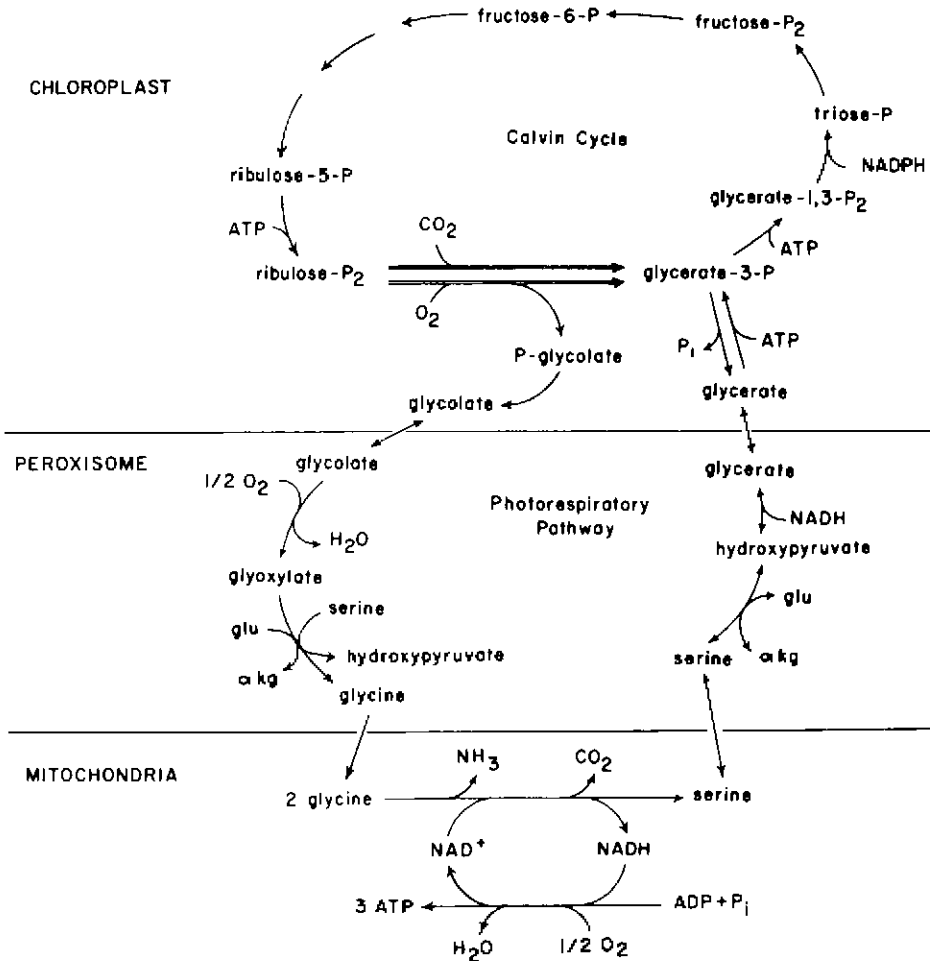

Figure 5. Integration of carbon metabolism between the Calvin cycle of photosynthesis and the photorespiratory pathway.

**Two Glycines Oxidized to CO<sub>2</sub>, NH<sub>3</sub> and Serine in Mitochondria**—Upon transfer of glycine to the mitochondria, serine is formed. This conversion is catalyzed by glycine decarboxylase and serine hydroxymethyl transferase which produces the major source of CO<sub>2</sub> lost during photorespiration. Woo and Osmond (1976) showed that glycine decarboxylation occurs in the intermembrane space of the mitochondria and that rates of glycine decarboxylation approach those required for rates of CO<sub>2</sub> evolution during photorespiration. The oxidative decarboxylation of glycine is coupled to the cytochrome electron transport and oxidative phosphorylation system of the mitochondria. Indeed, the mitochondria of C<sub>3</sub> leaves are

especially adept at oxidizing glycine with rates of  $O_2$  uptake being equal to those with malate or succinate. The mechanism involves the release of  $CO_2$  and ammonia with the trapping of the carbon two of glycine as  $N^5, N^{10}$ -methylene tetrahydrofolate. This is transferred to a second glycine to form serine. During the action of these two enzymes two electrons are available, which after passing through the electron transport pathway, produce ATP by oxidative phosphorylation with the uptake of  $O_2$ . The released  $NH_3$  is retrapped by the GOGAT system which forms glutamine and eventually glutamate. As much  $NH_3$  is released as  $CO_2$  so that an effective recycling of  $NH_3$  is operative. The formation of two glycines from two glyoxylates requires two amino donors, a serine and a glutamate. An amino group from the serine is conserved within the glycolate pathway by the formation of one serine from two glycines.

**Transamination of Serine and Reduction to Glycerate in Peroxisomes**—This pathway between serine and glycerate is a reversible pathway which can include glycerate-3-P during photorespiration. In plants and animals serine can be produced from glycerate-3-P. During photorespiration serine is converted to hydroxypyruvate by the serine-glyoxylate aminotransferase with glyoxylate generated during photorespiration. This aminotransferase is irreversible, and since the glyoxylate is only formed during photorespiration, other serine aminotransferase reactions are also prevalent in leaf peroxisomes. The reversible interconversion between glycerate and hydroxypyruvate is catalyzed by a NAD-linked dehydrogenase known as NADH-hydroxypyruvate reductase. This reaction requires a source of NADH which probably occurs through a shuttle of reducing power originating in the chloroplast. This shuttle may well involve malate being shuttled in and oxidized to oxalacetate to produce NADH. During photorespiration this shuttle of reducing power results in additional energy loss to the chloroplast during photosynthesis.

**Phosphorylation of Glycerate to Glycerate-3-P in Chloroplast**—To reenter the Calvin cycle, glycerate coming from the peroxisome is phosphorylated by glycerate kinase, an enzyme observed in isolated chloroplasts.

Note then, that of the four carbons from the two glycolates which produce one serine, one carbon is lost as  $CO_2$ . If the rate of photorespiratory  $CO_2$  release is one fourth of the rate of apparent photosynthesis, it is easy to see that the rate of carbon flowing through glycolate equals the rate of carbon flow during apparent photosynthesis under conditions prevailing in the atmosphere.

Photorespiration is an exothermic, irreversible process whereby energy is lost. A mole of  $O_2$  uptake occurs during ribulose- $P_2$  oxidation in the chloroplast for each P-glycolate formed. Net uptake of another 0.5 mole of  $O_2$  occurs during glycolate oxidation in the peroxisomes. How much  $O_2$  uptake occurs in the mitochondria during glycine oxidation depends upon how the NADH formed is used. If it supplies electrons to the electron transport pathway to form ATP by

oxidative phosphorylation, another 0.5 moles of  $O_2$  would be utilized. If the NADH were used to refix the  $NH_3$  by the GOGAT system no  $O_2$  uptake would occur in the mitochondria. During serine conversion to glycerate, the NADH consumed for reduction of hydroxypyruvate may have been the result of photosynthetic  $O_2$  evolution. Thus, during photorespiration for each two glycines converted to one serine, one  $CO_2$  would be evolved and at least three  $O_2$  would be taken up with this ratio depending upon the origin of the electrons. There is no net energy conservation as net ATP or NADH formation in any part of photorespiration; there is only energy loss. When one considers the evolution of  $O_2$  during photosynthesis and the oxidative utilization of  $O_2$  during photorespiration, a rapid internal cycling of  $O_2$  occurs.

Since photorespiration occurs because of insufficient  $CO_2$ , much of this  $CO_2$  evolved by photorespiration is refixed photosynthetically by ribulose- $P_2$  carboxylase. The measured amount of  $CO_2$  evolved in the light is thereby an underestimation of photorespiration. Several methods have been used to estimate the magnitude of photorespiration. The degree of inhibition of photosynthesis by 21 percent  $O_2$  (air) is about 20-25 percent of the rate in  $N_2$ . Thus, it has been estimated that the rate of photorespiration is 20-25 percent of the rate of photosynthesis. That means that 20-25 percent of the  $CO_2$  fixed is released during photorespiration. Using a value of 25  $\mu$ moles  $CO_2$  fixed/ $m^2 \cdot s$ , the photorespiratory rate of  $CO_2$  release is about 5  $\mu$ moles  $CO_2$  released/ $m^2 \cdot s$ . Dark respiration rates are about 1 to 2 percent or about .05  $\mu$ moles/ $m^2 \cdot s$ . Although an estimate, it appears that photorespiration has a potential of being about 10 times faster than dark respiration.

Photorespiration, by wasting the assimilatory power of photosynthesis, competes with and reduces secondary synthetic processes. Oxygen in the atmosphere at levels above ambient, in addition to decreasing  $CO_2$  fixation, changes the main products of photosynthesis from sucrose to glycine and serine. Since sucrose is the product of photosynthesis used by other parts of the plant, the reduction of its synthesis, even in air by photorespiration, means that the growth of plants is also inhibited in air by photorespiration. Bjorkman *et al.* (1968) and others have grown young plants in 2-5 percent  $O_2$  and found an increase in mass about twice as fast as those grown in air. Two to five percent is sufficient to saturate the mitochondrial requirement for oxygen, but as the ribulose- $P_2$  carboxylase/oxygenase and the glycolate oxidase have a much lower affinity for  $O_2$ , they are not even saturated by 100 percent  $O_2$ . When plants are grown at higher levels of  $O_2$  than air, their growth rate slows and ceases around 30-40 percent  $O_2$ , depending on the plant. Increasing the  $O_2$  concentration increases photorespiration until a level of  $O_2$  is reached with air levels of  $CO_2$  where photorespiration and photosynthesis are equal.

The main factor regulating photorespiration is the competition between photosynthesis and photorespiration by the competitive substrate availability of  $CO_2$  and  $O_2$  for the carboxylase versus oxygenase activities with bound ribulose- $P_2$ . This competition was well demonstrated *in vivo* as well as with the isolated

enzyme by Bowes and Ogren (1972). With whole plants the competition is shown upon determining the  $\text{CO}_2$  compensation point. This is the condition when the net exchange of  $\text{CO}_2$  due to photosynthesis and photorespiration is zero. Most often  $\text{CO}_2$  compensation points are determined by putting a plant or leaf in a closed chamber with light and temperature control and measuring the final steady state level of  $\text{CO}_2$  in the chamber.

Photorespiration increases with increasing light, temperature and pH. All of these factors can be explained by the availability of  $\text{CO}_2$  versus  $\text{O}_2$  for the ribulose- $\text{P}_2$  carboxylase/oxygenase in the leaf. Photorespiration increases more rapidly as temperature increases than does photosynthesis so that at elevated temperatures (between 35 and 45C) the  $\text{CO}_2$  compensation point is approached even in air. This phenomenon can be attributed, at least in part, to a faster decrease in  $\text{CO}_2$  solubility than  $\text{O}_2$  solubility in water with increasing temperature (Ku and Edwards, 1977). Other than temperature effects which affect solubility of  $\text{CO}_2$  and  $\text{O}_2$ , there does not appear to be methods to regulate oxygenase activity versus carboxylase activity. Increased carboxylase activity will give also increased oxygenase activity. Because carbon during metabolism is committed to either photorespiration or photosynthesis by action of the ribulose- $\text{P}_2$  carboxylase/oxygenase, the regulation of photorespiration is most difficult and elimination appears impossible and not safe for the plant.

## BIOCHEMICAL LIMITATIONS OF WHOLE PLANT PHOTOSYNTHESIS

Many conditions in the environment affect the role of photosynthetic  $\text{CO}_2$  uptake. One approach for considering the cellular limitations is to ask what limits the action of the ribulose- $\text{P}_2$  carboxylase. Enzyme studies as well as chloroplast and leaf measurements show that, if the substrates,  $\text{CO}_2$  and ribulose- $\text{P}_2$ , are present and the ribulose- $\text{P}_2$  carboxylase is active, then  $\text{CO}_2$  fixation must occur. Those conditions which result in limiting the availability of  $\text{CO}_2$ , the regeneration of ribulose- $\text{P}_2$  or the amount of active ribulose- $\text{P}_2$  carboxylase can be considered as the biochemical limitations of whole plant photosynthesis.

For the level of 0.032-0.035 percent  $\text{CO}_2$  in the atmosphere, photosynthesis is limited by  $\text{CO}_2$  availability. The internal  $\text{CO}_2$  is still less as it is restricted by stomatal aperture. The presence of  $\text{O}_2$  also competes with  $\text{CO}_2$  for the bound ribulose- $\text{P}_2$  on the carboxylase. Limits on photosynthesis by limiting  $\text{CO}_2$  occurs also under high temperature (solubility of  $\text{CO}_2$ ) as well as increases in atmospheric  $\text{O}_2$ .

The action of light on the photosynthetic apparatus provides energy to regenerate the  $\text{CO}_2$  acceptor, ribulose- $\text{P}_2$ . If ribulose- $\text{P}_2$ , which is only found in the chloroplast, is not available, then  $\text{CO}_2$  fixation stops. This occurs in the dark where ribulose- $\text{P}_2$  drops to almost zero. When light is present, ATP and NADPH are used to form ribulose- $\text{P}_2$  from other sugar phosphates. The lack of carbon to

regenerate ribulose- $P_2$  occurs following high rates of photorespiration or after long periods of darkness where starch and other carbohydrate reserves have been exhausted. Other sugar phosphates are known to compete with ribulose- $P_2$  for binding on the carboxylase further reducing fixation especially when ribulose- $P_2$  is low. Regeneration of ribulose- $P_2$  is also limited by the availability of inorganic phosphate to produce ATP.

When  $CO_2$  and ribulose- $P_2$  are available, photosynthetic  $CO_2$  assimilation can still be limited by the amount of active ribulose- $P_2$  carboxylase/oxygenase (Perchorowicz *et al.*, 1981). Under some conditions the amount of the available enzyme protein is limiting, or the amount of active enzyme compared to inactive enzyme is low. In low light the enzyme becomes inactive due to suboptimal levels of  $Mg^{2+}$  and pH in the chloroplast stroma. This parameter can be measured and a good approximation made of the availability of activated ribulose- $P_2$  carboxylase (Perchorowicz *et al.*, 1982). Other environmental conditions such as heat and water stress can indirectly limit activity of the ribulose- $P_2$  carboxylase in the chloroplast. Under limiting cell water many of the binding sites of the ribulose- $P_2$  carboxylase may not be available or may already be bound with other intermediates.

Laboratory research to directly determine the factors limiting photosynthesis is becoming more prevalent. One can easily determine  $CO_2$  availability by measuring stomatal resistance with a dew point hygrometer. Techniques for measuring the substrate, ribulose- $P_2$ , are well developed, although they usually underestimate the amount by at least 10 percent (Perchorowicz *et al.*, 1981). As activation of the carboxylase involves a slow conformational change in the protein, this can apparently be determined by kinetic measurements after chilling the leaves to ice temperature and making leaf extracts (Perchorowicz *et al.*, 1982). The use of these approaches should help to define the actual biochemical limitations on photosynthesis as caused by different environmental stresses.

## SUMMARY

Photosynthesis is the essential process whereby plants utilize radiant energy to synthesize their biomass from  $CO_2$ , while  $O_2$  is evolved. Most of this process operates in the chloroplast where both the pigmented photosystems and the required enzymes are located. The pigment systems, which are organized as two photosystems, are imbedded in lamellar membranes and contain mostly chlorophyll and some carotenoids. Light radiant energy is trapped by the pigments and, with the assistance of electron transfer mediators (mostly quinones and cytochromes), is converted to chemical energy as ATP and NADPH to drive the photosynthetic carbon reduction pathway. Ribulose 1,5-bisphosphate is generated by this metabolic pathway and serves as the initial acceptor for  $CO_2$  during photosynthesis. This carboxylation produces 3-phosphoglycerate which, upon reduction in the chloroplast, serves eventually as the carbon and energy source for

sucrose production in the cytoplasm. Some of the fixed carbon remains in the chloroplast as starch.

A major control of carbon assimilation during photosynthesis occurs at the carboxylation step where the activity of the ribulose 1,5-bisphosphate carboxylase is regulated. Further controls regulate the regeneration of ribulose 1,5-bisphosphate by modifying the activity of other enzymes of the photosynthetic carbon reduction pathway. Because the carboxylase also catalyzes a competing reaction with oxygen, a second pathway for carbon flow occurs called photorespiration. This process returns three of the four carbons which are diverted into photorespiration back to the photosynthetic pathway. The fourth is evolved as  $\text{CO}_2$ .

Biochemical limitations on photosynthesis can be viewed as limitations on  $\text{CO}_2$  fixation. Reduction in photosynthesis is caused by either limiting  $\text{CO}_2$  availability or ribulose bisphosphate regeneration or by reduced activity of the carboxylase enzyme. Current research promises to eventually increase photosynthetic productivity by determining how these limitations can be overcome.

### ACKNOWLEDGEMENTS

Support for research in the authors laboratory came from the USDA/SEA under Grant 5901-0410-8-0114-0, Competitive Research Grants Office, NSF Grant PCM 77-26284 and the Monsanto Co. Helpful suggestions were gratefully given by Dr. John T. Perchorowicz.

## Chapter 16

# CARBOHYDRATE PRODUCTION AND DISTRIBUTION IN COTTON CANOPIES

Jack R. Mauney  
USDA-ARS  
Phoenix, Arizona

## INTRODUCTION

The photosynthetic fixation of  $\text{CO}_2$  by leaves of the canopy and the distribution of that carbohydrate among growing organs is, of course, the basis for crop productivity. The description of the carbohydrate distribution has been a very active area of research since Eaton and Rigler (1945) made a very comprehensive study of the interaction between light intensity and nitrogen nutrition with the growth, fruiting, and carbohydrate status of cotton plants. The most comprehensive versions of the modern computer simulations of the cotton crop are COT-CROP (Jones *et al.*, 1980) and GOSSYM (Baker *et al.*, 1984). These materials-balance models simulate carbohydrate production and use by the developing canopy. Reduction of the carbohydrate supply by stresses of various kinds (see Chapter 19) and the distribution of that carbohydrate in respiration and organ development are calculated by these dynamic models in attempts to simulate the performance of the crop. The fact that GOSSYM requires a computer with large (128 K) memory indicates the complexity of the dynamics of known chemical and physical interactions which produce a cotton crop. Perhaps it is remarkable that production is as reliable as it is. This chapter will outline the parameters which have been observed for carbohydrate production and utilization within field stands of the crop.

## CROP GROWTH RATE

### CARBOHYDRATE FORMATION

The single leaf rate of  $\text{CO}_2$  uptake (CER) for cotton is in the upper range of the  $\text{C}_3$  group. Values as high as  $50 \text{ mg CO}_2/\text{dm}^2/\text{hr}$  have been reported (Muramoto *et al.*, 1965), but most reports have been in the range of 35 to  $45 \text{ mg CO}_2/\text{dm}^2/\text{hr}$  (Patterson *et al.*, 1977; Elmore *et al.*, 1967; Mauney *et al.*, 1978). The conditions of growth for the leaves to be analyzed have pronounced influence on the values obtained in this measurement. Hesketh (1968) and Patterson *et al.* (1977) noted

that leaves grown under intense sunlight had a higher photosynthetic capability than those grown at lower light intensity. This effect was primarily the result of the intensity at which light saturation was observed. Leaves grown in maximum sunlight saturate at light intensity above sunlight, whereas leaves grown in shade saturate at a lower intensity.

The range of light experience for each leaf in the canopy is so varied that, even though there are adequate data to describe the light response curve of  $\text{CO}_2$  uptake for individual leaves (Patterson *et al.*, 1977), the calculation of the canopy activity from single leaf data is inappropriate. Baker *et al.* (1978) pointed out that not only is the canopy made up of leaves with varied light intensity responsiveness, but also of widely varying leaf angles, sunflecks and photosynthetic organs other than leaves which contribute to the total  $\text{CO}_2$  fixation.

Constable and Rawson (1980a,b) studied the translocation pattern in the cotton plant by determining the carbohydrate supply from each branch and comparing that supply with the demands of bolls present on the branch. They concluded that a major portion of the sink demand of maturing bolls must be met by import of carbohydrate from leaves elsewhere on the plant. The major contributors to this carbohydrate pool is apparently the mainstem leaves because of their large size and direct attachment to the vascular system of the mainstem (Constable and Rawson, 1980b).

## MAXIMUM GROWTH RATE

Loomis and Williams (1963) calculated the maximum carbohydrate production by a canopy utilizing all the incident radiation to be 77 g dry matter/ $\text{m}^2/\text{day}$ . This value included a correction of 33 percent for respiratory loss. They felt that plant canopies with "several layers of leaves" should be able to achieve this potential growth rate even with the observed rates for  $\text{CO}_2$  assimilation of 20 to 25 mg  $\text{CO}_2/\text{dm}^2/\text{hr}$ . They observed growth rates for dense stands of maize to be 51 g/ $\text{m}^2/\text{day}$ . Maximum crop growth rates for  $\text{C}_3$  plants seldom exceed 40 g/ $\text{m}^2/\text{day}$  (Jones *et al.*, 1980). Baker and Hesketh (1969) made calculations of the maximum crop growth rate (CGR) of a cotton stand using weather information for July to October, 1966, in Mississippi. They used a value of 10 percent for maintenance respiration and a value of 56 percent for growth respiration. They calculated a CGR at 42 g/ $\text{m}^2/\text{day}$  on July 15 decreasing to 10 g/ $\text{m}^2/\text{day}$  on September 3 and increasing again as vegetative regrowth occurred. With all of this growth rate assigned to boll loading, they placed the maximum yield capability of that stand at 2850 kg/ha (5.9 bales/acre). If they assumed cloudless weather, their model predicted a maximum yield of 3650 kg/ha (7.6 bales/acre).

Maximum growth rates approaching these calculated values have been observed. Data taken in 1981 in Phoenix by Mauney (unpublished) are shown in Figure 1. These plots yielded 2380 kg/ha and had a maximum growth rate of the above-ground crop of about 25-30 g/ $\text{m}^2/\text{day}$  from July 25 to August 15. The 1981 growing season in Phoenix was characterized by rapid seedling growth due to



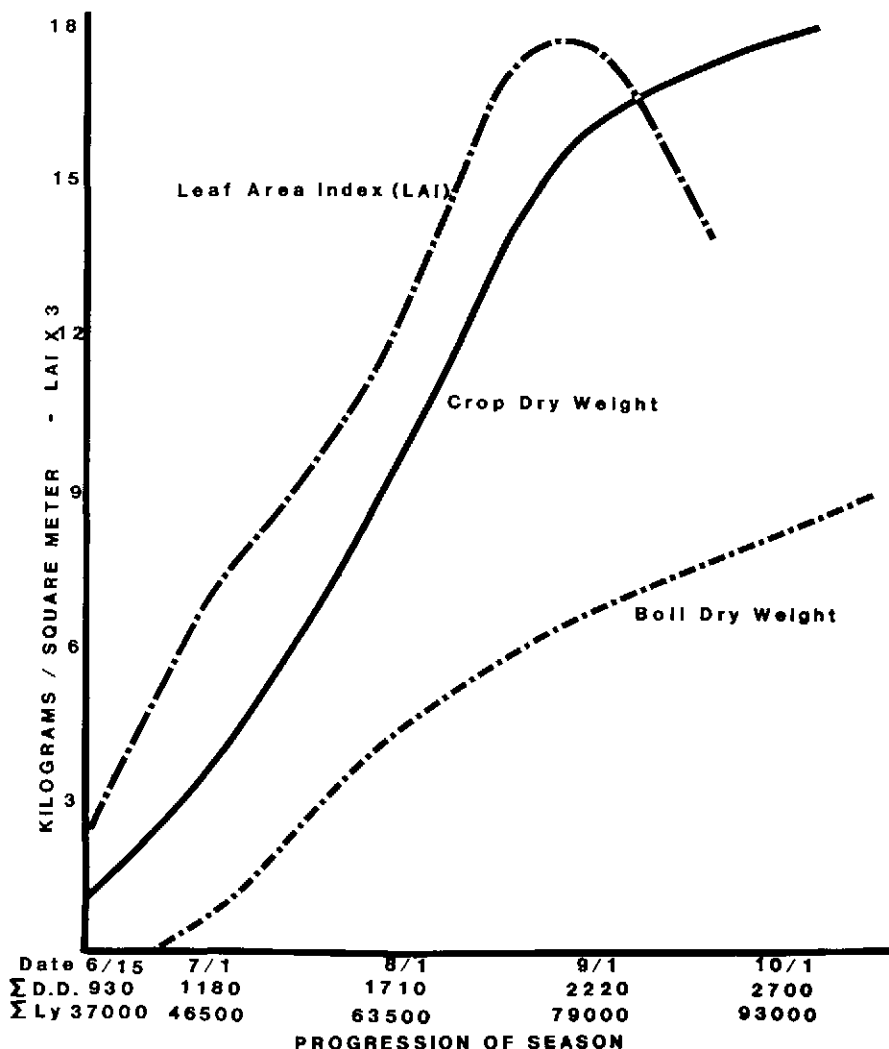

Figure 1. Relationships of crop dry weight accumulation above ground to leaf area index (LAI) and boll dry weight accumulation in Phoenix, Arizona, in 1981. This field produced a harvested yield of 5780 kg/ha seed cotton. Curves are smoothed average of six replications made at 7- to 10-day intervals and include abscised leaves, flowers and bolls. Heat units are in degree days (DD) with a 12.8C minimum and a 30C maximum using the triangulation method of averaging (Fry, 1983). Sunlight accumulation is in Langley's (ly) as measured by the U.S. Weather Bureau located 5 miles away. Sunlight and heat-unit accumulations are calculated from date of emergence, 4/10/81. Crop was *G. hirsutum* cv. DPL 70 at a density of 80,000 plants/ha.

unusually high temperatures in April and May. The summation of heat units shown in Figure 1 are about 200 degree days (DD) higher at each date during July and August than the average year in Phoenix.

Canopy CO<sub>2</sub> fixation rates can be calculated from these growth data. Growth and maintenance respiration have been estimated by Baker and Hesketh (1969) and by Hesketh *et al.* (1971). The carbohydrate conversion efficiency is in the range .55 to .66 for both leaves and bolls. Therefore, 30 g/m<sup>2</sup>/day CGR requires 30 x 1.65 x 1.47 = 73 g CO<sub>2</sub>/m<sup>2</sup>/day = 730 mg CO<sub>2</sub>/dm<sup>2</sup>/day where 1.65 is the reciprocal of carbohydrate conversion efficiency and 1.47 is the CO<sub>2</sub>/CH<sub>2</sub>O conversion factor. This rate is similar to the maximum CO<sub>2</sub> uptake measured by Baker and Myhre (1968) who reported values greater than 700 mg CO<sub>2</sub>/dm/day on cloudless days in Mississippi.

**SUNLIGHT INTERCEPTION**

A principal determinant of the canopy carbohydrate production is sunlight interception. Walhood (1976) correlated the yield of variably-spaced plantings in California with the degree of sunlight interception during early season. When plant population was held constant at 84,000/ha and row spacing was 25, 50 or 100 cm, light interception changed dramatically in early season. On July 5, the 25 cm rows intercepted about 70 percent of sunlight while the 100 cm rows intercept-

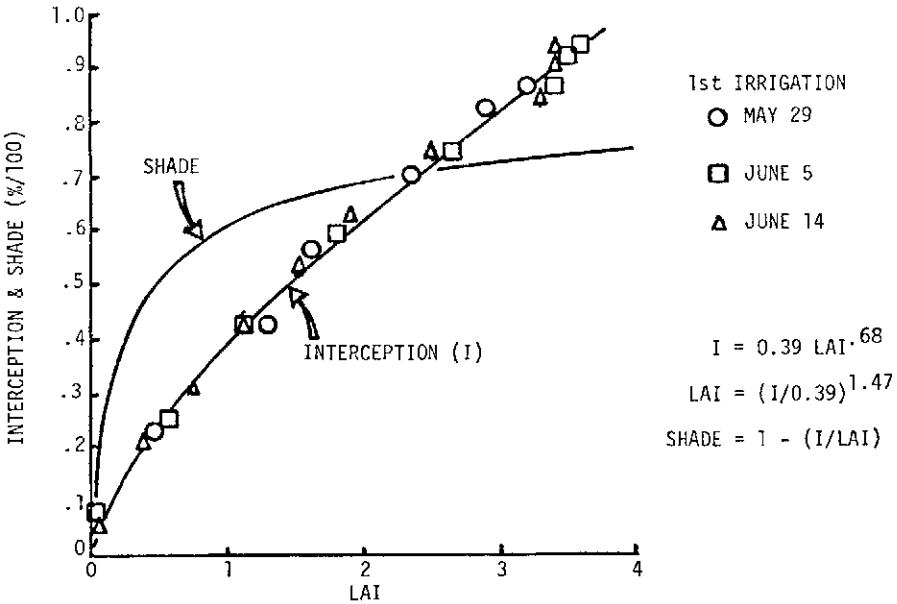

Figure 2. Percentage of light interception and shade for increasing leaf area index (LAI). From Fry (1980), used with permission.

ed 32 percent. As expected, the early-season and final yield in his short-season cultural practice correlated with the sunlight interception. The 25 cm rows had 42 percent more yield.

Fry (1980) correlated the midday sunlight interception with LAI (Figure 2) as the crop developed under several irrigation regimes. The regression line shown in Figure 2 is similar to that of Baker and Meyer (1966) who used row spacing and row orientation as the variables.

Until the canopy completely covers the furrow between rows, the row spacing causes a pronounced minimum in the daily interception curve at solar noon (Baker and Meyer, 1966). Because sunlight intensity is increasing while interception is decreasing, they observed a plateau in CER from 3 hours prior to 3 hours after noon. The regression between short-wave energy interception by the canopy and the uptake of  $\text{CO}_2$  was linear (Hesketh and Baker, 1967). The heliotropic movement of cotton leaves (Lang, 1972) allows more of the leaf area to be normal to the sun than the calculations of deWit (1978) assumed. For this reason, when estimating the effects of row orientation on yield, Baker and Meyer (1966) measured interception directly rather than make a conversion from LAI. They concluded that the increase in interception due to North-South orientation of rows (compared to East-West) was not a significant factor in improving canopy efficiency.

## BOLL LOADING AND BIOMASS ACCUMULATION

In view of the observation (Mauney et al., 1978) that starch accumulation can be a feedback mechanism for limiting CER when there is insufficient growth capacity to utilize all the carbohydrates leaves produce, one can speculate that the presence of bolls as sinks might enable greater carbohydrate translocation. This might result in higher canopy CER than if bolls were absent. This logic would hold however, only if stem, leaf and root growth were limited in sink capacity. And, as I remind myself and colleagues frequently, "Logic will get you nowhere" unless supported by data. The question of whether vegetative growth can absorb all available canopy carbohydrate has not been conclusively answered. In Table 1 are listed four experiments in which the flower buds were removed from plants and the change in total dry weight measured. All possibilities, i.e. increase (Dale, 1959), no change (Malik *et al.*, 1981; Nagarajah, 1975) and decrease (Eaton and Rigler, 1945) have been observed. Apart from the difference in outcome caused by the length of the experiments (Table 1), the different plant types, cultural conditions, and climate under which the observations were made could explain the lack of agreement. Dale (1959) explained the significant increase in weight of the disbudded plants by noting that the fruited plants ceased to grow when flowering began and gained only 8 grams of dry weight in the 84 days prior to final harvest, while the disbudded plants continued to grow vegetatively and add dry weight for 245 days. He, thus, called attention to the lack of simultaneous

Table 1. Response of cotton to the removal of all flower buds.

Growth period (days)	Plant weight (g/plant)		Reference
	Control	Disbudded	
92	835 <sup>1</sup>	566 <sup>1</sup>	Eaton and Rigler (1945)
105	50 <sup>2</sup>	51 <sup>2</sup>	Nagarajah (1975)
125	190 <sup>2</sup>	226 <sup>2</sup>	Malik <i>et al.</i> (1981)
245	150 <sup>2</sup>	318 <sup>2</sup>	Dale (1959)

<sup>1</sup>Fresh weight basis.

<sup>2</sup>Dry weight basis.

vegetative and reproductive growth in the cultivars he was studying. From his plant density (1 plant/ft in 36" rows), the dry weight accumulations can be converted to 1230 g/m<sup>2</sup>, about .6 the weight of the stand shown in Figure 1.

Further analysis of the data in Figure 1 may add some understanding to the question of photosynthetic potential of the crop during boll-loading. In Figure 3 are graphed the crop growth rates of several portions of the stand as well as the total crop weight above ground. These data indicate that the maximum crop growth rate (30 g/m<sup>2</sup>/day) was attained only when leaves and stems were adding weight at near maximal rate and bolls were being filled. A possible explanation for this may be that the canopy was not fully intercepting all sunlight until early August (Figure 3). The rate of dry weight accumulation in the crop is roughly proportional to the fraction of light intercepted at solar noon. The coincidence of slightly higher crop growth rate per unit of sunlight intercepted during the rapid boll-filling period of July 1 to 15 may indicate an enhancement of crop CER by developing bolls. Those data are far from conclusive, however. During the prime period of dry weight accumulation (Aug. 1-15, Figure 3), the vegetative and reproductive organs each appear to be sinks adequate for deposit of the full carbohydrate output of the canopy. Since it is easy to imagine that a different climate might produce a different partitioning pattern (for instance, greater rate of leaf area expansion in a location with higher atmospheric humidity than Phoenix), the conclusive statement about the effect of boll loading on canopy carbohydrate fixation awaits data sets of the type shown in Figures 1 and 3 from widely dispersed locations.

## CARBOHYDRATE DISTRIBUTION

The crop dry weight distribution shown in Figure 1 represents a crop which was similar in yield to the highest reported for furrow-irrigated cotton. Though yields of 2700 kg/ha have been reported from drip-irrigated fields (Briggs *et al.*, 1983), lint yields greater than 2200 kg/ha are observed only rarely under furrow irrigation.

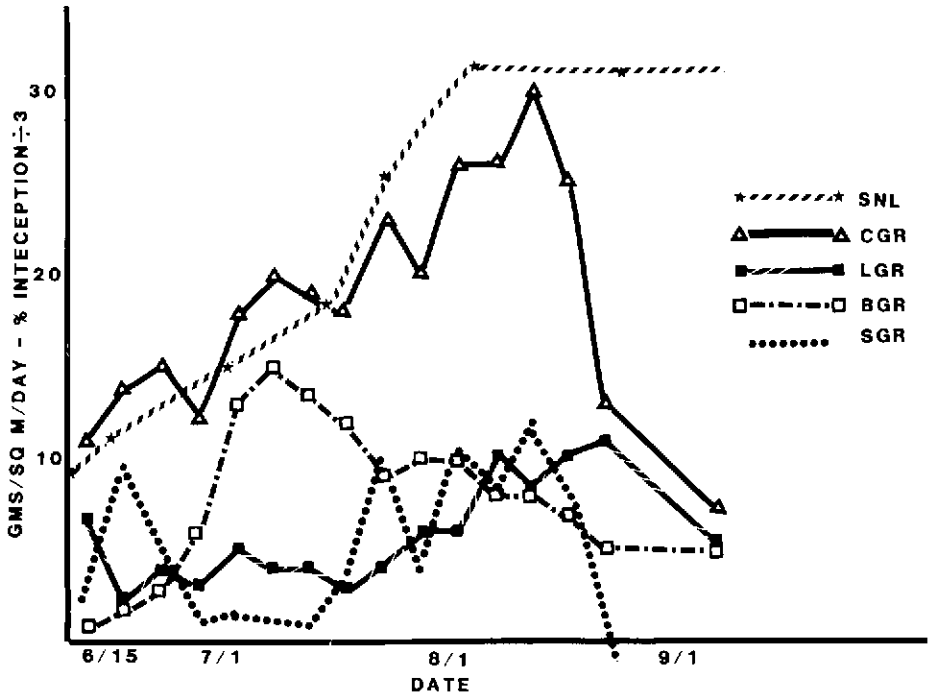

Figure 3. Rate of dry weight accumulation in portions of the standing crop described in Figure 1 and the percentage sunlight (SNL) intercepted at noon as estimated from Figure 2. Increases in crop weight (CGR), boll weight (BGR), and leaf weight (LGR) are from direct measurement. Changes in stem weight (SGR) were calculated by subtracting BGR and LGR from CGR.

Examination of Figure 4 shows that partitioning of the dry weight into fruits occurred in two cycles. From the onset of flowering until July 10, almost all the dry weight accumulation could be accounted for by increase in boll weight. From mid-July to mid-August, the dry weight increase was primarily in stems and leaves. After September 1, all dry weight increase was in bolls. This two-phase cycle of growth and reproductive partitioning is typical of irrigated southwestern areas with long, warm growing seasons. These areas have the highest productivity per hectare in the United States.

Baker and Hesketh (1969) assumed that for maximum productivity a vegetative canopy would be established by July 15, and that subsequently all dry weight accumulation would be in fruits.

This is not the strategy employed by highly productive real crops. Vegetative and reproductive growth occur simultaneously. It is significant that in the data of Figure 1 about 700 g/m<sup>2</sup> dry weight accumulated in the vegetative structure

subsequent to July 18 (when LAI of 3.0 was achieved). If this dry weight had been allocated to fruit, then the boll dry weight would have been 1500 g/m<sup>2</sup> for a lint yield of about 3600 kg/ha (7.5 bales/ac.). This is very close to the 3650 kg/ha estimated by Baker and Hesketh (1969) as the maximum potential for a cloudless season.

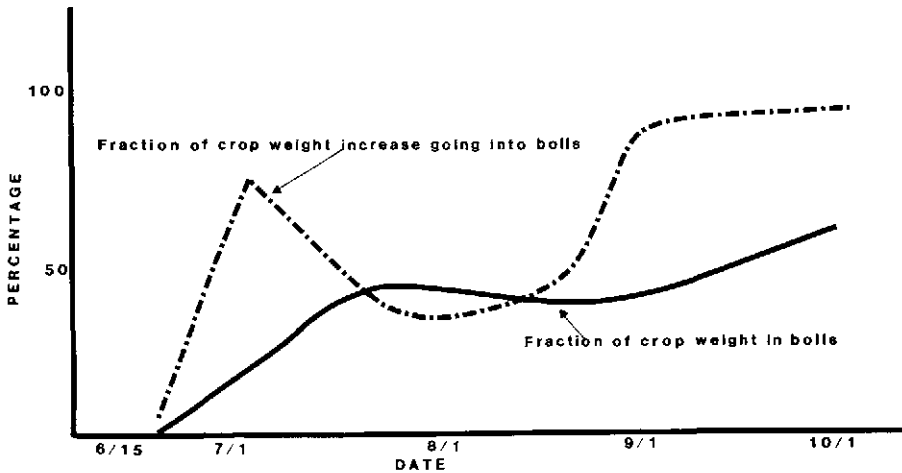

Figure 4. Distribution of dry weight accumulation into bolls during 1981 in Phoenix, Arizona (see Figure 1).

From this analysis it is apparent that the “inefficiencies” of the cotton plant are associated with the simultaneous vegetative and reproductive growth. The most productive canopies are those which allocate sufficient carbohydrate to vegetative growth to provide precisely the number of fruiting sites to absorb the remaining carbohydrate (see Chapter 2). In no instance would there be sufficient flowering sites on July 15 to enable all additional carbohydrate to be invested in fruits. A boll which matures on October 1 is the result of a blossom which opened on August 15 and was not visible as a square until July 25. Though the dry weight of the flower and fruit prior to anthesis is small (.2 g; Baker and Hesketh, 1969), leaf and stem development associated with each flower is the basis for the large non-boll dry weight investment.

The partitioning mechanisms which determine the fraction of dry weight assigned to vegetative and fruit growth are complex. The genetic tendencies of the crop for internode length, leaf size and shape, number of flowers per fruiting branch, etc., form a basis for partitioning. The water and nutrient status of the crop (Chapter 10) and environmental parameters such as temperature, sunlight and relative humidity change the capability of the crop to utilize carbohydrate for stem elongation and leaf expansion. The proximity of active source leaves to actively growing organ sinks appears to play a major role in determining the fate

of the carbohydrate from that source (Chapter 22). The growth habit of the plants in a cotton canopy is opportunistic. Those organs genetically and environmentally capable of growth which have favorable proximity to active leaves will be the organs to receive the majority of the available carbohydrate. The resultant of all the individual partitioning equations is the dry weight balance of the crop. Genetic and cultural strategies to improve the partitioning efficiency of the crop must take into account the dynamic nature of the interaction.

## Chapter 17

# PHOTOSYNTHESIS, DRY MATTER PRODUCTION AND GROWTH IN CO<sub>2</sub>—ENRICHED ATMOSPHERES

Donald T. Krizek  
USDA-ARS  
Beltsville, Maryland

## INTRODUCTION

The physiological basis of yield in cotton and other crops has been the subject of intense interest (Hesketh, 1963; Eastin *et al.*, 1969; Hesketh and Baker, 1967; Thorne, 1971; Evans, 1975). Despite the obvious importance of carbon dioxide (CO<sub>2</sub>) as a limiting factor in photosynthesis (van den Honert, 1930; Moss, 1962; Hesketh, 1963; Wareing *et al.*, 1968; Burris and Black, 1976; Allen, 1979; Wittwer, 1983) most texts on cotton and literature reviews on cotton physiology contain little or no mention of this parameter (Brown, 1927; Hector, 1936; Eaton, 1950, 1955; Brown and Ware, 1958; Dastur, 1959; Dastur and Asana, 1960; Tharp, 1965; Carns and Mauney, 1968; Elliott *et al.*, 1968; Arnon, 1972; Prentice, 1972; McArthur *et al.*, 1975).

The objective of this article will be to review the literature on CO<sub>2</sub> enrichment of cotton and other important species under growth chamber, greenhouse and field conditions, to describe some metabolic effects observed, and to discuss some of the factors influencing CO<sub>2</sub> utilization by the plant.

The benefits of CO<sub>2</sub> enrichment under controlled environments are not confined to greenhouse-grown crops. Results with field crops such as potato, wheat, and sugar beet under controlled environments have been equally striking (Gaastra, 1959, 1963; Wittwer and Robb, 1964; Wittwer, 1970a,b, 1983). Agronomic crops investigated under enhanced CO<sub>2</sub> conditions in controlled environments include: corn (Moss *et al.*, 1961; Moss and Peaslee, 1965; Ford and Thorne, 1967; Sionit and Strain, 1982); soybeans (Brun and Cooper, 1967; Cooper and Brun, 1967; Saminy, 1967; Hardman and Brun, 1971; Clough and Peet, 1981; Clough *et al.*, 1981; Finn and Brun, 1982; Sionit *et al.*, 1982; Jones *et al.*, 1983; Sionit, 1983); barley (Ford and Thorne, 1967); sugar beet (Ford and Thorne, 1967; Wittwer, 1970a,b; Wyse, 1980; Sionit *et al.*, 1982); grain sorghum (Al-Kawas, 1967; Mauney *et al.*, 1978); wheat (Wittwer, 1970a,b; MacDowell, 1972;



Krenzer and Moss, 1975; Fischer and Aguilar, 1976; Gifford, 1977, 1979 a,b; Neales and Nicholls, 1978; Sionit *et al.*, 1980; Sionit *et al.*, 1981 a,c,d); potato (Collins, 1976); tobacco (Thomas *et al.*, 1975); and white clover (Masterson and Sherwood, 1978).

The beneficial effects of CO<sub>2</sub> enrichment on crop productivity can be regarded as a composite effect, with many plant processes contributing to the increase in productivity (Gaastra, 1966; Enoch, 1978b; Enoch and Hurd, 1979). CO<sub>2</sub> enrichment of C<sub>3</sub> plants has been shown to increase the quantum yield (Ehleringer and Bjorkman, 1977), the net photosynthesis rate (Enoch and Hurd, 1977; Ho, 1977; Kramer, 1981), the internal transport of carbon (Ho, 1977), the salt tolerance (Enoch *et al.*, 1973) and the optimum leaf temperature for net photosynthesis (Enoch, 1978a; Enoch and Sachs, 1978).

Relatively few CO<sub>2</sub> enrichment studies have been conducted on cotton plants under controlled environments (Leonard and Pinckard, 1946; Guinn, 1973, 1974a; Hesketh and Hellmers, 1973; Chang, 1975; Mauney *et al.*, 1978, 1979; Wong, 1979, 1980). Most of these studies indicate that cotton is responsive to CO<sub>2</sub> enrichment. Cotton has a relatively high CO<sub>2</sub> compensation point (60-120  $\mu\text{l l}^{-1}$ ); it is consistent in its growth response to enhanced CO<sub>2</sub> levels; and it reaches light saturation at levels below those of full sunlight (Hesketh and Baker, 1966; Zelitch, 1971; Harper *et al.*, 1973b; Wittwer, 1978 a). However, Baker *et al.* (1972) observed that the canopy was not light saturated at full sunlight (see also Chapter 16). Harper *et al.* (1973b) measured a 26 percent increase in canopy uptake of CO<sub>2</sub> when carbon dioxide was released into a field-grown crop.

## CO<sub>2</sub> ENRICHMENT OF THE ATMOSPHERE

The possibility of using CO<sub>2</sub> enrichment of the atmosphere as a means of increasing crop yield was investigated by numerous researchers during the past century (Brown and Escombe, 1902; Cummings and Jones, 1918; Wittwer and Robb, 1964; Monteith, 1965; Krizek *et al.*, 1968, 1970 a, 1971, 1974; Krizek, 1969, 1970, 1974; Waggoner, 1969; Bailey *et al.*, 1970; Enoch *et al.*, 1970; Wittwer, 1970a,b, 1978a,b, 1980, 1981, 1982a,b, 1983; Madsen, 1971b, 1973, 1974, 1976, 1979; van Bavel, 1972b; Moss 1976; Lemon, 1977; McCoy, 1978; Strain, 1978a,b; Allen *et al.*, 1971; Strain, 1978a,b; Tibbitts and Krizek, 1978; Allen, 1979; Pallas, 1979; Baker *et al.*, 1981; Carlson and Bazzaz, 1980, 1982; Kimball, 1982; Strain and Sionit, 1982). The adverse effects of high CO<sub>2</sub> in the soil atmosphere caused by waterlogging have also been reported by many workers (see review by Krizek, 1982).

### CONTROLLED CONDITIONS

Dramatic increases in vegetative growth and flower and fruit development under CO<sub>2</sub>-enriched atmospheres in controlled environments were reported for a wide range of species (Kimball, 1982). Vegetables responsive to CO<sub>2</sub> enrichment

include lettuce, tomato, cucumber, (Wittwer and Robb, 1964; Newton, 1966; Hurd, 1968; Wittwer, 1970a,b; Kretchman and Howlett, 1970; Hand and Postlethwaite, 1971; Hand and Soffe, 1971; Madsen, 1973, 1974, 1976; Knecht and O'Leary, 1974; Krizek *et al.*, 1974; Calvert and Slack, 1975; Frydrych, 1976; Hinkleton and Jolliffe, 1978; Kimball and Mitchell, 1978, 1979, 1981; Nilwik *et al.*, 1982; Knecht and O'Leary, 1983; Nilsen *et al.*, 1983); potato (Aoki and Yabuki, 1977); okra (Sionit *et al.*, 1981 b); pepper (Enoch *et al.*, 1970); and radish (Knecht, 1975; Sionit *et al.*, 1982). Ornamental crops accelerated in their growth and development by CO<sub>2</sub> enhancement include petunia, ageratum, marigold, snapdragon, rose, carnation, chrysanthemum, and many others (Krizek *et al.*, 1968; Bailey *et al.*, 1970; Holley, 1970; Purohit and Tregunna, 1974; Enoch and Hurd, 1977, 1979; Mortensen and Moe, 1983a,b).

Carbon dioxide enrichment under controlled environments also increases growth of a number of woody species. These include tea, crabapple (Krizek *et al.*, 1971; Zimmerman *et al.*, 1970; paper birch (Krizek, 1972); guayule (Backhouse *et al.*, 1979) and a number of species of pine and spruce (Funsch *et al.*, 1970; Yeatman, 1971; Tinus, 1972; Green and Wright, 1977; Rogers *et al.*, 1982b). Several investigators also obtained accelerated growth of rooted cuttings under CO<sub>2</sub> enhancement (Laiche, 1978; Lin and Molnar, 1982).

## FIELD CONDITIONS

The potential for CO<sub>2</sub> enrichment of crops under field conditions has been examined only to a limited extent (Johansson, 1932; Chapman and Loomis, 1953; Kretchman, 1969, 1970; Enoch *et al.*, 1970; Yoshida, 1972; Moss, 1976; Wittwer, 1978a; Allen, 1979, 1982; Arteca *et al.*, 1979; Rogers *et al.*, 1980, 1981, 1982a,b,c). Plant response to CO<sub>2</sub> enrichment in the field depends on the kind of crop, the meteorological conditions, the distribution of CO<sub>2</sub> flux into the vegetation (Anderson, 1975; Wittwer, 1978a; Allen, 1979) and the stage of development (Krenzer and Moss, 1975).

Carbon dioxide enrichment of vegetable crops in the field has increased yields about 12 percent (Kretchman, 1969, 1970; Allen 1979). Enrichment of soybeans, peanuts and peas with CO<sub>2</sub> in open-top enclosures increased yields of these crops presumably by increasing the supply of photosynthate available to symbiotic nitrogen-fixing bacteria (Havelka and Hardy, 1976; Hardy and Havelka, 1973, 1975, 1977; Hardy, 1978; Allen, 1979).

For vegetable crops and most agronomic crops the economic costs of CO<sub>2</sub> enrichment in the field have been considered excessive (Kretchman, 1969, 1970; Anderson, 1975; Wittwer, 1978a; Allen, 1979). Experimental evidence and model predictions led Allen (1979) to conclude that CO<sub>2</sub> enrichment under field conditions is inefficient, since the maximum increase in CO<sub>2</sub> uptake is only about 6.5 percent of the CO<sub>2</sub> enrichment. In his opinion, even turbulent diffusion barriers do not increase the capture of CO<sub>2</sub> sufficiently to make field-scale enrichment feasible. Carbon dioxide enrichment experiments conducted on cot-

ton in the field by Baker (1965), Harper (1971), and Harper *et al.* (1973a,b,c), were viewed by Wittwer (1978a) as economically promising.

A cotton crop in Mississippi enriched with CO<sub>2</sub> at a controlled release rate of 222.6 kg ha<sup>-1</sup>hr<sup>-1</sup> (198.6lb acre<sup>-1</sup>hr<sup>-1</sup>) provided mean CO<sub>2</sub> concentrations of 450 to 500 μl l<sup>-1</sup> maintained at three-fourths the plant height (Harper *et al.*, 1973 b). Fluctuations of CO<sub>2</sub> within the canopy varied with meteorological conditions. Photosynthetic assimilation of CO<sub>2</sub> was calculated for crops grown in the open and in a semi-enclosed plexiglass chamber. Seven to 33 percent of the CO<sub>2</sub> applied was calculated to be recovered as photosynthate over a range of solar radiation levels of 205 to 1095 W•m<sup>-2</sup>. Net biomass production on a daily basis was increased by an estimated 35 percent. Based on these tests, Harper (1971) concluded that CO<sub>2</sub> enrichment of cotton and other field crops in Mississippi may be economically feasible. It should be noted, however, that in studies reported by Baker and McKinion (1971), elevated CO<sub>2</sub> levels were not found within the canopy.

Harper *et al.* (1973b) found that CO<sub>2</sub> enhancement was especially beneficial in dense plantings of cotton, particularly in warm bright weather when conditions for minimal restraints on growth and distribution of photosynthate prevailed. They concluded that for maximum recovery of CO<sub>2</sub> in a cotton field the crop should be fully expanded (for maximum interception of photosynthetically active radiation, PAR), and that solar irradiance should be high.

Certain crops (corn) are less responsive to CO<sub>2</sub> enrichment in the field than others (cotton). Even with a 45-fold increase in CO<sub>2</sub> content at the soil level, Lemon *et al.* (1971) obtained little change in CO<sub>2</sub> concentration in the upper part of the canopy. They estimated only a 10-20 percent increase in photosynthesis with the high CO<sub>2</sub> enrichment levels.

Because of the inherent limitations of measuring photosynthetic rates in the field, measurements of photosynthesis under CO<sub>2</sub>-enriched atmospheres are often difficult to evaluate. Some of these limitations include a cuvette effect, caused by non-standardization of the leaf microenvironment (energy budget), self-shading effects, humidity effects on the infra-red gas analyzer and sampling problems. Since most cuvette systems are air conditioned to prevent overheating, significant differences in photosynthetic activity caused by variations in ambient air and leaf temperature may not be detected (Anderson, 1975). Under field conditions there may also be serious limitations in the time response of CO<sub>2</sub>-measuring instruments (Sestak *et al.*, 1971). Bingham *et al.*, (1978) have recently developed a miniature, rapid-response CO<sub>2</sub> sensor at the Lawrence Livermore Laboratory which they believe will accurately measure real-time fluctuations in ambient CO<sub>2</sub> concentrations of 0.25 μl l<sup>-1</sup>. The rapid-response and open cell design promises to have research applicability in aerodynamic transfer investigations and canopy photosynthesis studies.

METABOLIC EFFECTS OF CO<sub>2</sub> ENRICHMENT

## PHOTOSYNTHESIS

Species differ greatly in their response to CO<sub>2</sub> enrichment (Tables 1 and 2). In general C<sub>3</sub> plants show a greater increase in photosynthetic rate (P<sub>n</sub>) than do C<sub>4</sub> plants (Moss, 1962, 1967; Moss and Rawlins, 1963; El Sharkawy and Hesketh, 1965; El Sharkawy *et al.*, 1965; Jolliffe and Treguna, 1968; Menz *et al.*, 1969;

Table 1. Comparative photosynthesis rates (P<sub>n</sub>, mg CO<sub>2</sub> dm<sup>-2</sup> hr<sup>-1</sup>) under normal CO<sub>2</sub> and under CO<sub>2</sub>-enriched atmospheres. (Data from El-Sharkawy and Hesketh, 1965).

Species	P <sub>n</sub> CO <sub>2</sub> μl l <sup>-1</sup>		
	300	1600	4750
Corn	60	103	71
Sunflower	45	100	90
Cotton	45	70	95
Oats	33	—	66
Tobacco	27	67	—
Hibiscus	27	66	—
Soybean	25	56	—

Table 2. Influence of CO<sub>2</sub> concentration (330 and 660 μl l<sup>-1</sup>) on CO<sub>2</sub> uptake (P<sub>n</sub>), leaf area (LA), and dry weight (DW) accumulation in cotton, soybean, sunflower, and sorghum grown under greenhouse conditions. LA and DW measurements were taken after 12 weeks of growth. (Data from Mauncy *et al.*, 1978).

Species	Year	P <sub>n</sub> (nmol cm <sup>-2</sup> s <sup>-1</sup> )		LA/plant (dm <sup>2</sup> ) CO <sub>2</sub> μl l <sup>-1</sup>		DW/plant (g.)	
		330	630	330	630	330	630
		Cotton	1975	2.96	3.34*		
	1976	2.08	2.39*	153	292**	320	670
Soybean	1975		3.59				
	1976	1.38	1.95**	100	280**	85	410
Sunflower	1975		3.40				
	1976	2.64	2.83	120	290**	500	800
Sorghum	1975	3.90	4.28				
	1976	3.78	3.84	20	23	85	100

\*, \*\* Value significantly different at the 5% and 1% level, respectively.

Akita and Moss, 1972, 1973; Akita and Tanaka, 1973; Buchanan and Schurmann, 1973; Ito, 1973, 1976; Chollet and Ogren, 1975; Hofstra and Hesketh, 1975; Imai and Murata, 1976, 1977, 1978a,b, 1979a,b; Ho, 1977; Bahr and Jensen, 1978; Enoch, 1978; Enoch and Sachs, 1978; Goudriaan and van Laar, 1978; Powles, 1979; Wong, 1979, 1980; Farquhar *et al.*, 1980; Patterson and Foint, 1980; Downton *et al.*, 1981; Rosenberg, 1981; Strain and Sionit, 1982; Gates *et al.*, 1983; Wittwer, 1983) (Table 2). The current level of CO<sub>2</sub> in the atmosphere is believed to be rate limiting for most C<sub>3</sub> plants (Rogers *et al.*, 1980, 1981, 1982b; Sionit *et al.*, 1981; Wittwer, 1983). Under stress conditions imposed by air pollutants and adverse temperature, moisture and radiation conditions, both C<sub>3</sub> and C<sub>4</sub> plants may benefit from CO<sub>2</sub> enhancement (Allen, 1979; Strain, 1978a,b; Tolbert and Zelitch, 1982; Wittwer, 1982a, 1983). Under N stress, however, the stimulatory effects of CO<sub>2</sub> enrichment on P<sub>n</sub> are greatly reduced (Wong, 1979, 1980). This is especially so in a C<sub>3</sub> species such as cotton (Table 3).

Table 3. Influence of CO<sub>2</sub> concentration and nitrogen nutrition on the rate of CO<sub>2</sub> assimilation (P<sub>n</sub>, in  $\mu\text{mol CO}_2 \text{ m}^{-2} \text{ s}^{-1}$ ) in cotton, a C<sub>3</sub> plant and in maize, a C<sub>4</sub> plant. (Data from Wong, 1980).

Plant	CO <sub>2</sub> $\mu\text{l l}^{-1}$	Nitrate mM NO <sub>3</sub> <sup>-</sup>	P <sub>n</sub> CO <sub>2</sub>		
			330 $\mu\text{l l}^{-1}$	660 $\mu\text{l l}^{-1}$	
Cotton	330	24.0	35.6	52.8	
	330	12.0	32.1	49.2	
	330	4.0	28.3	42.8	
	330	0.6	19.8	24.5	
	660	24.0	29.0	51.5	
	660	12.0	20.4	34.5	
	660	4.0	15.6	25.8	
	660	0.6	9.4	15.2	
	Maize	330	24.0	52.0	65.9
		330	12.0	43.3	54.8
		330	4.0	40.6	50.2
		330	0.6	27.3	32.5
660		24.0	51.3	66.3	
660		12.0	40.8	54.6	
660		4.0	32.8	40.3	
660		0.6	23.2	26.8	

Wong (1980) and other workers (see review by Carns and Mauney, 1968) have reported a linear increase in photosynthesis of leaves of cotton as CO<sub>2</sub> concentration is increased to 600 μl l<sup>-1</sup> (Figure 1). In short-term experiments on alfalfa, sugar beet, and tomato, Thomas and Hill (1949) obtained a linear increase in P<sub>n</sub>

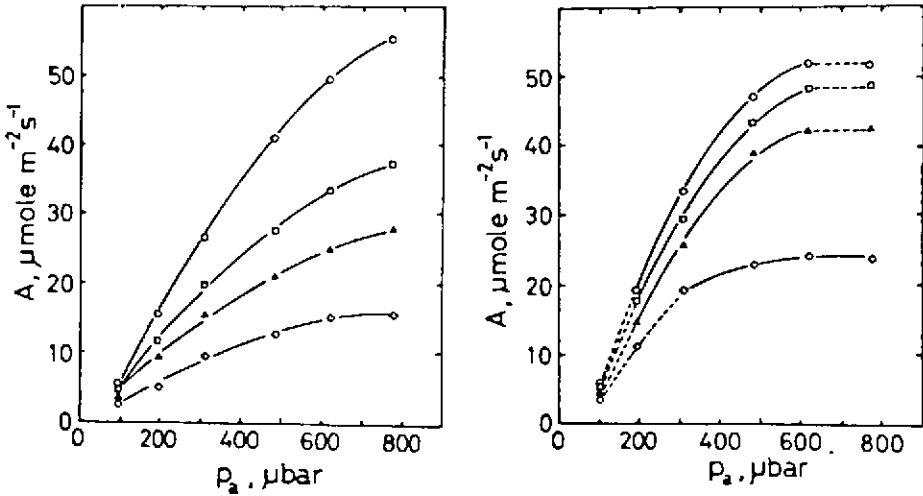

Figure 1. Rate of CO<sub>2</sub> assimilation (A) in cotton as influenced by CO<sub>2</sub> concentration and nitrogen nutrition. Measurements were made at 2000 μmol m<sup>-2</sup> s<sup>-1</sup> of PPF, 30C, and a vapor pressure difference of 20 mbar. The plants were grown at 330 μl l<sup>-1</sup> (μbar) (left) or 660 μl l<sup>-1</sup> of CO<sub>2</sub> (right), and under four levels of nitrogen nutrition: ◇, 0.6 mM NO<sub>3</sub><sup>-</sup>; ▲, 4 mM NO<sub>3</sub><sup>-</sup>; □, 12 mM NO<sub>3</sub><sup>-</sup>; and ○, 24 mM NO<sub>3</sub><sup>-</sup>. The solid lines are linear or quadratic functions defined by least squares regression. (Data from Wong, 1980).

with increasing CO<sub>2</sub> concentration up to 3500 μl l<sup>-1</sup> in full sun. Baker (1965) and Bierhuizen and Slatyer (1964, 1965) showed an interaction between photosynthetically active radiation (PAR) and maximum CO<sub>2</sub> concentration. At 10.8 klx (1000 ft-c) net photosynthesis increased with exposures up to 1000 μl l<sup>-1</sup> CO<sub>2</sub>. However, at PAR levels of 64.6 klx (6000 ft-c) little increase in P<sub>n</sub> occurred above 600 μl l<sup>-1</sup> CO<sub>2</sub>. These investigators suggested that the higher PAR levels caused the stomates to open wider, decreasing stomatal resistance to CO<sub>2</sub> diffusion. The higher PAR level would also reduce the so-called "mesophyll" resistance to CO<sub>2</sub> uptake (which is infinite in the dark) to several times the mathematical equivalent of the diffusive resistance offered by open stomata to CO<sub>2</sub> exchange at high PAR levels.

Brun and Cooper (1967) reported a four-fold increase in P<sub>n</sub> in soybean plants grown in a greenhouse at ambient CO<sub>2</sub> and then exposed to a CO<sub>2</sub> concentration of 1670 μl l<sup>-1</sup> in the laboratory. Green and Wright (1977) working with branches

of conifers enclosed in cuvettes, obtained an 87 percent increase in  $P_n$  at  $\text{CO}_2$  concentrations of 450 to 500  $\mu\text{l l}^{-1}$ .

Kramer (1981) pointed out that photosynthetic measurements made over short periods of time do not necessarily provide reliable information concerning what occurs when plants are grown at high  $\text{CO}_2$  concentrations for several weeks or longer. Mauney *et al.* (1978) exposed cotton, sorghum, soybean, and sunflower plants to 330 or 630  $\mu\text{l l}^{-1}$   $\text{CO}_2$  during daylight hours in air conditioned greenhouses in Phoenix, Arizona for 12 weeks or more during the period of May to August in 1975 and 1976. They measured the rate of photosynthesis per unit of leaf area at frequent intervals on single leaves during this period and obtained an average increase in  $P_n$  of 15 percent for cotton, and 41 percent for soybean, but only 2 percent for sorghum, and 7 percent for sunflower, compared to the  $P_n$  of these species at 330  $\mu\text{l l}^{-1}$   $\text{CO}_2$ . These differences in  $P_n$  were not statistically significant for sorghum and sunflower.

Aoki and Yabuki (1977) grew cucumber plants for up to three weeks in chambers under sunlight conditions at  $\text{CO}_2$  concentrations from 300 to 5500  $\mu\text{l l}^{-1}$ . Measurements of photosynthesis were then made at the  $\text{CO}_2$  concentrations at which the plants were grown. Although initially the photosynthetic rates at the high  $\text{CO}_2$  concentrations (1200, 2400, and 5500  $\mu\text{l l}^{-1}$ ) were nearly twice those at the control level (300  $\mu\text{l l}^{-1}$ ), they decreased rapidly thereafter. In 5 days the photosynthetic rates at 2400 and 5500  $\mu\text{l l}^{-1}$  had dropped below the control rate; and within 15 days the  $P_n$  rate at 1200  $\mu\text{l l}^{-1}$  was below the control rate.

Raper and Peedin (1978) exposed two cultivars of tobacco to 400 and 1000  $\mu\text{l l}^{-1}$  of  $\text{CO}_2$  for 35 days after transplanting. At the end of this time, the leaf area of the plants grown under high  $\text{CO}_2$  was larger, but the rate of photosynthesis per unit of leaf area of the high  $\text{CO}_2$  plants was only 70-80 percent of the  $P_n$  of plants maintained at low  $\text{CO}_2$ . Hicklenton and Jolliffe (1980b) reported that in *Pharbitis nil* the rate of photosynthesis per unit of leaf area of plants kept for 14 days in 1.0 percent  $\text{CO}_2$  was lower than the  $P_n$  of plants kept at 0.03 percent.

In making  $P_n$  measurements at 0.03 percent  $\text{CO}_2$ , Krizek and Carlson (1968, unpublished results) found that the  $P_n$  of petunia plants grown for two weeks at high  $\text{CO}_2$  (2000  $\mu\text{l l}^{-1}$ ) was lower than that of plants grown at low  $\text{CO}_2$  (400  $\mu\text{l l}^{-1}$ ). This was true, even though the  $\text{CO}_2$ -enriched plants had greater dry weights, were better branched, and flowered 2-3 weeks sooner (Krizek *et al.*, 1968). Because of the possible feedback inhibition of  $P_n$  caused by  $\text{CO}_2$  enrichment, it is important, therefore, to know whether  $P_n$  measurements were made at ambient or enhanced  $\text{CO}_2$  levels before interpreting data on  $\text{CO}_2$  enrichment effects on  $P_n$ .

Crough *et al.* (1981) noted that the  $P_n$  of high sink soybeans maintained at 1000  $\mu\text{l l}^{-1}$  of  $\text{CO}_2$  declined steadily over a 20-day period, while the  $P_n$  of high sink plants kept at 350  $\mu\text{l l}^{-1}$  remained constant for 15 days before beginning to decline. In this study, however, the absolute  $P_n$  was always greater in plants at 1000  $\mu\text{l l}^{-1}$  than 350  $\mu\text{l l}^{-1}$ .

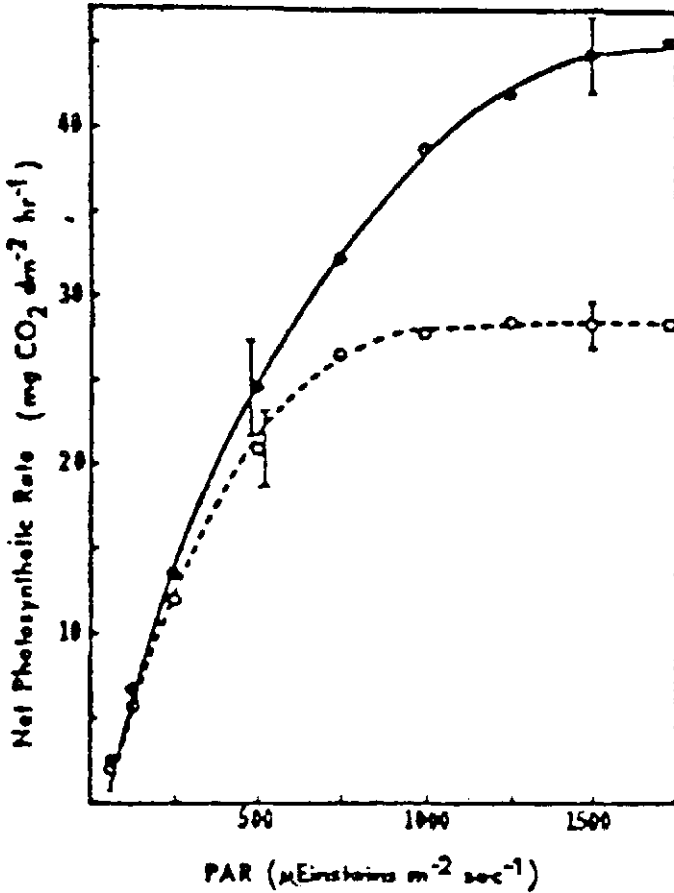

Figure 2. Relation between net photosynthetic rate per unit leaf area and photosynthetically active radiation (PAR, 400-700 nm) in cotton plants grown in the growth chamber (dotted line) and in the field (solid line). Vertical bars indicate the SE of the mean. Each point is an average of four observations. (From Patterson *et al.*, 1977).

Previous studies have shown that maximum  $P_n$  in cotton are often greater in field-grown plants than in those grown in the greenhouse (El-Sharkawy *et al.*, 1965; Elmore *et al.*, 1967; Bazzaz, 1973). However, comparisons of  $P_n$  between field-grown and growth chamber-grown plants have seldom been made (Hesketh, 1968; Patterson *et al.*, 1977). Hesketh (1968) found that cotton plants grown in a growth chamber under 32.3 klx (3000 ft-c) of fluorescent light had  $P_n$  similar to winter-grown greenhouse plants. When the chamber-grown plants were given



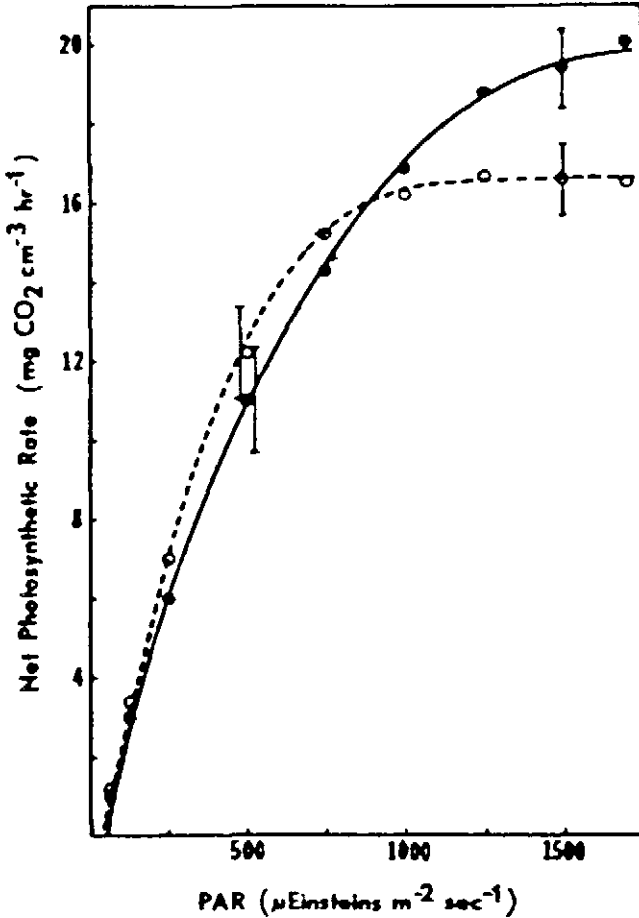

Figure 3. Relation between net photosynthetic rate per unit mesophyll volume and photosynthetically active radiation (PAR, 400-700 nm) in cotton plants grown in the growth chamber (dotted line) and in the field (solid line). Vertical bars indicate the SE of the mean. Each point is an average of four leaves. (From Patterson *et al.*, 1977).

supplemental higher intensity incandescent light during their growth, the  $P_n$  was increased to the level of summer-grown greenhouse plants. These studies illustrate the importance that differences in photosynthetically active radiation (PAR) level and spectral quality during growth may have on measurements of  $P_n$  and indicate the difficulty of using photosynthetic data obtained from plants grown in different environments in making a comparison of the photosynthetic efficiencies of different species and cultivars.

Patterson *et al.* (1977) found differences in *in situ*  $P_n$  between cotton plants grown under ambient conditions in the field and those grown in a growth chamber in the Duke University Phytotron. Measurements of the response of  $P_n$  to changes in PAR level were made under standard conditions in the laboratory to determine whether the differences observed *in situ* were related to the plant material itself or to differences in the ambient PAR conditions. Exposed canopy leaves on field-grown cotton plants had *in situ*  $P_n$  per unit leaf area nearly two times greater than rates determined *in situ* for similar leaves on chamber-grown plants. Average PAR levels measured in the field (2000-2200  $\mu\text{mol m}^{-2} \text{s}^{-1}$ ) during the period of vegetative growth (May through early August) were approximately three times greater than in the growth chamber (600-700  $\mu\text{mol m}^{-2} \text{s}^{-1}$ ) (Figures 2 and 3).

Stomatal diffusive resistance, leaf anatomy and chloroplast lamellar characteristics were studied as possible explanations for the differences observed in  $P_n$ . Light saturated stomatal resistances did not differ in cotton leaves of similar age and exposure on field-grown and chamber-grown plants. Lower  $P_n$  in leaves of chamber-grown plants was associated with greater mesophyll resistance. Differences in  $P_n$  were related to differences in leaf thickness. When the  $P_n$  was expressed per unit of mesophyll volume or per unit of chlorophyll (Figure 3), differences between field-grown and chamber-grown plants were much less than when rates were expressed per unit leaf area (Figure 2). Thus, total chlorophyll content may be a better indicator of photosynthetic potential than leaf area. Characterization of the chloroplast lamellar proteins indicated that the leaves of plants grown in the field had smaller photosynthetic units than those from chamber-grown plants. Since the field leaves also contained more chlorophyll per unit area, this resulted in a much larger number of photosynthetic units per area than in the chamber leaves. Thus, the basis chosen to express photosynthetic rates is important in extrapolating the results from growth chamber studies to the field (Patterson *et al.*, 1977) and in constructing and applying photosynthetic models (Shawcroft *et al.*, 1974).

## CARBOHYDRATE METABOLISM AND FEEDBACK CONTROL OF PHOTOSYNTHESIS

Several investigators suggest that the decrease in  $P_n$  following prolonged CO<sub>2</sub> enhancement is caused by an accumulation of starch in the leaves (Brown and Escombe, 1902; Smith, 1944; Madsen, 1968; 1971a, 1976; Ito, 1973; Downs and Hellmers, 1976; Hoffstra and Hesketh, 1975; Thomas *et al.*, 1975; Apel, 1976; Mauney *et al.*, 1979; Cave *et al.*, 1981; Wulff and Strain, 1982). Brown and Escombe (1902) were among the first to note an increase in starch content in CO<sub>2</sub> enriched plants of *Fuchsia* spp., *Cucurbita pepo*, and *Impatiens platypetala*.

Madsen (1976) reported that the starch content in tomato leaves from plants grown at 2200  $\mu\text{l l}^{-1}$  CO<sub>2</sub> increased nearly seven-fold; there was no further increase when the CO<sub>2</sub> content in the atmosphere was increased up to 5000  $\mu\text{l l}^{-1}$ . So much starch accumulated at 1000  $\mu\text{l l}^{-1}$  or more of CO<sub>2</sub> that the chloroplasts

and leaves became severely deformed and leaves began to wither. The starch content showed a pronounced variation between day and night. The content was greatest during the last part of the afternoon (1.9 percent in control leaves and 12.5 percent in leaves from plants grown at  $2200 \mu\text{l l}^{-1} \text{CO}_2$ ) and lowest from midnight until sunrise (1.0 percent in control leaves and 7.3 percent in leaves from  $\text{CO}_2$ -enriched plants). The starch content also increased with age of the plants. Leaves from 19-day-old tomato plants in  $2200 \mu\text{l l}^{-1} \text{CO}_2$  contained 9.1 percent starch while those from 23-day-old plants contained 10.3 percent starch.

The content of glucose and sucrose increased with an increase in  $\text{CO}_2$  concentration up to  $1000 \mu\text{l l}^{-1}$ , above which no further increase was observed (Madsen, 1976). In comparison to control plants,  $\text{CO}_2$ -enriched tomato plants contained a 50 percent increase in glucose and sucrose. The content of glucose did not vary during a 24-hour period but the sucrose content varied greatly. The content was higher in daylight when photosynthesis was active and lower at night. This variation was particularly noticeable in plants given  $\text{CO}_2$  enhancement. Bishop and Whittingham *et al.* (1968) also found an increase in the content of soluble carbohydrates when  $\text{CO}_2$  was added to the atmosphere. Ito (1973) obtained an increase in the reducing, as well as in the non-reducing carbohydrates, and in the starch content in leaves, stems and roots of several vegetable species grown under  $\text{CO}_2$  enhancement. Starch accumulation in the leaves of tomato plants was particularly high in the afternoon in a  $\text{CO}_2$ -enriched atmosphere. Starch content showed a high negative correlation with  $P_n$ . Removal of fruits decreased  $P_n$  more at  $1065 \mu\text{l l}^{-1}$  than at  $300 \mu\text{l l}^{-1} \text{CO}_2$ .

Several workers have reported a characteristic chlorosis and increase in thickness and brittleness of leaves taken from  $\text{CO}_2$ -enriched plants (Madsen, 1968, 1976; Downs and Hellmers, 1975; Cave *et al.*, 1981). These changes have been accompanied by a decrease in chlorophyll content and changes in starch grain structure (Cave *et al.*, 1981). Immature leaves of clover plants grown in the growth chamber under  $1000 \mu\text{l l}^{-1}$  of  $\text{CO}_2$  contained significantly less total chlorophyll content per unit dry weight and a significantly lower chlorophyll a:b ratio than plants grown at  $350 \mu\text{l l}^{-1} \text{CO}_2$ . Fully expanded mature clover leaves partially overcame the deficit in chlorophyll content; however, the chlorophyll a:b ratio still remained much lower in these high  $\text{CO}_2$ -enriched plants (Cave *et al.*, 1981). Electron micrographs of  $\text{CO}_2$ -enriched clover plants taken by these investigators revealed a large amount of starch accumulated as irregularly shaped grains. This accumulation of starch was thought to disrupt the normal chloroplast structure of these plants. This in turn was reflected in a large decrease in chlorophyll content per dry weight contributing to chlorosis of the leaves.

Mauney *et al.* (1979) conducted  $\text{CO}_2$  enrichment studies in sealed, air-conditioned greenhouses in Phoenix, Arizona in cloudless weather in May to August, 1975 and 1976 to determine the correlation between photosynthetic rate and carbohydrate accumulation. Species were chosen that varied in their tendency to accumulate starch in the leaves: sorghum (low starch, high  $P_n$ ); cotton (high

Table 4. Influence of CO<sub>2</sub> enrichment on photosynthetic CO<sub>2</sub> uptake (P<sub>n</sub>) and sugar and starch content of 14 to 18 day old leaves of four species grown under high CO<sub>2</sub> (630 μl l<sup>-1</sup>) or low CO<sub>2</sub> (330 μl l<sup>-1</sup>) and measured as grown or 2 to 4 hours after transfer to the other environment. Correlation coefficients (r) for starch and P<sub>n</sub> were calculated for all leaves measured in high or low environment. Plants were 55 to 125 days old at time of measurement. (Data from Mauney *et al.*, 1979).

Species	Year	Measured at high CO <sub>2</sub>							Measured at low CO <sub>2</sub>							
		Grown at low CO <sub>2</sub>			Grown at high CO <sub>2</sub>				r	Grown at low CO <sub>2</sub>			Grown at high CO <sub>2</sub>			
		P <sub>n</sub> nmol cm <sup>2</sup> s	Sugar mg•g <sup>-1</sup>	Starch mg•g <sup>-1</sup>	P <sub>n</sub> nmol cm <sup>2</sup> s	Sugar mg•g <sup>-1</sup>	Starch mg•g <sup>-1</sup>	P <sub>n</sub> nmol cm <sup>2</sup> s		Sugar mg•g <sup>-1</sup>	Starch mg•g <sup>-1</sup>	P <sub>n</sub> nmol cm <sup>2</sup> s	Sugar mg•g <sup>-1</sup>	Starch mg•g <sup>-1</sup>	r	
Cotton	1975	5.2	43	74	3.3	30	256	-0.34	3.0	43	99	2.0	43	302	-0.73**	
	1976	2.6	57	137	2.4	61	314	-0.32	2.1	57	87	1.6	56	251	-0.68**	
Soybean	1975	3.8	42	40	3.6	49	136	-0.41	-	-	-	-	-	-	-	
	1976	1.7	47	133	2.0	55	229	0.37	1.3	50	112	1.3	51	187	0.01	
Sunflower	1975	4.7	75	185	3.4	86	181	-0.12	2.2	62	-	-	-	-	-	
	1976	3.1	66	90	2.9	74	117	0.55**	2.6	58	90	2.0	81	75	0.35	
Sorghum	1975	4.2	78	8	3.9	88	12	0.61	4.3	46	11	3.5	49	15	-0.63	
	1976	3.7	66	57	3.8	69	74	0.30	3.8	58	36	3.5	91	39	0.36	

\*,\*\* Value for r statistically significant at the 0.05 and 0.01 level, respectively.

starch, intermediate  $P_n$ ); soybean (intermediate starch, intermediate  $P_n$ ); and sunflower (intermediate starch, high  $P_n$ ). Measurements were made of average  $\text{CO}_2$  uptake ( $P_n$ ), and average sugar and starch content of 14- to 18-day-old leaves of the four species grown in high  $\text{CO}_2$  ( $630 \mu\text{l l}^{-1}$ ) or low  $\text{CO}_2$  ( $330 \mu\text{l l}^{-1}$ ) and measured as grown or 2 to 4 hours after transfer to the other environment (Table 4). High  $\text{CO}_2$  increased the starch concentration in all species, but neither  $\text{CO}_2$  level significantly altered the amount of soluble sugars. In no case was there a significant correlation between sugar concentration and  $P_n$ . Carbon dioxide enrichment caused large increases in starch content of cotton and soybean leaves but relatively small increases in sunflower and sorghum leaves (Table 4). The  $P_n$  of sorghum, a  $\text{C}_4$  plant, was relatively insensitive to  $\text{CO}_2$  enrichment, and its leaves always contained low concentrations of starch. Starch content of cotton leaves, on the other hand, increased to levels as high as 50 percent of their dry weight after a few days in high  $\text{CO}_2$  (Guinn and Mauney, 1980; Mauney *et al.*, 1979). When cotton plants were moved from normal to high  $\text{CO}_2$ , the  $P_n$  increased 45 percent in the first 2 hours after transfer and then declined as starch accumulated, until the

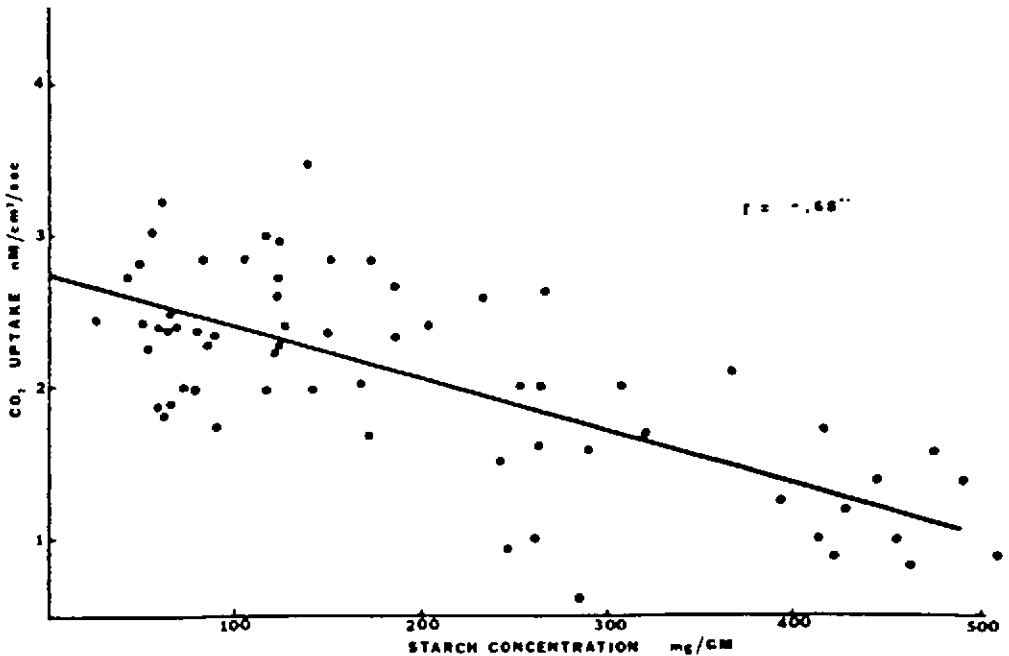

Figure 4. Correlation of leaf starch concentration and  $\text{CO}_2$  uptake ( $P_n$ ) in leaves of greenhouse-grown cotton. Plants were grown and measured at  $330 \mu\text{l l}^{-1}$   $\text{CO}_2$  or grown at  $630 \mu\text{l l}^{-1}$   $\text{CO}_2$  and measured at  $330 \mu\text{l l}^{-1}$   $\text{CO}_2$ . (From Mauney *et al.*, 1979 and Guinn and Mauney, 1980).

$P_n$  was only 15 percent greater for leaves in high CO<sub>2</sub> than in normal CO<sub>2</sub>. When these plants, high in starch, were returned to 330  $\mu\text{l l}^{-1}$  CO<sub>2</sub>, the  $P_n$  fell below that of plants kept in normal air.

Significant negative correlations were obtained between starch content and photosynthetic rates measured in ambient CO<sub>2</sub> (Figure 4). The poorer negative correlation between  $P_n$  and starch in cotton leaves measured in high CO<sub>2</sub> was not anticipated by these workers since a higher starch content generally was expected to cause a greater inhibition of  $P_n$  (Mauney *et al.*, 1970; Guinn and Mauney, 1980). They proposed that starch inhibits  $P_n$  by interfering with diffusion of CO<sub>2</sub> to fixation sites (Mauney *et al.*, 1979) in line with an earlier hypothesis developed by Kriedemann *et al.* (1976) and Nafziger and Koller (1976). Guinn and Mauney (1980) suggested that the CO<sub>2</sub>-induced buildup of starch may affect photosynthesis via stomatal effects since it is known that CO<sub>2</sub> enhancement causes partial closure of stomata. Nafziger and Koller (1976) and Mauney *et al.* (1979) attempted to circumvent this effect by allowing 30 minutes and 2 hours respectively, for stomatal adjustment after transferring plants to different CO<sub>2</sub> concentrations before determining  $P_n$ . Hofstra and Hesketh (1975) exposed two soybean cultivars to 800-1000  $\mu\text{l l}^{-1}$  CO<sub>2</sub> and found that the  $P_n$  was negatively correlated with mesophyll resistance, starch content of the leaves and specific leaf weight. However, they found no correlation between apparent photosynthesis and stomatal resistance, indicating that the inhibition of apparent photosynthesis at high starch levels was not a stomatal effect.

Nafziger and Koller (1976) treated soybean plants with 50, 300, and 2000  $\mu\text{l l}^{-1}$  CO<sub>2</sub> for 12.5 hours and then measured  $P_n$  at 300  $\mu\text{l l}^{-1}$  CO<sub>2</sub>. Carbon dioxide enrichment had no effect on sugar content, but increased the starch level. The  $P_n$  decreased with increasing amounts of starch. The difference in  $P_n$  was largely attributed to increased mesophyll resistance which increased more than stomatal resistance with increase in starch content of the leaves. This effect was observed only at starch levels greater than 1 mg cm<sup>-2</sup> (about 200 mg g<sup>-1</sup>) which, as they point out, may explain why some workers fail to observe an inhibition of  $P_n$  by starch.

Evidence for end-product inhibition of photosynthesis has been presented (Neales and Incoll, 1968; Guinn and Mauney, 1980). At the time of Neales and Incoll's review in 1968, the evidence for feedback control of photosynthesis was largely circumstantial and primary emphasis was on sugars. There was little evidence or concern for the role of starch in end-product inhibition of photosynthesis. Since that time most of the evidence for feedback regulation of photosynthesis has involved starch rather than sugars. Results with sugars have been largely negative (Guinn and Mauney, 1980).

Demonstration of end-product inhibition of photosynthesis is difficult to obtain. In a number of studies on CO<sub>2</sub> enrichment (Clough and Peet, 1981; Hicklenton and Jolliffe, 1980 a) there was no evidence obtained for feedback inhibition of either photosynthesis or net assimilation rate (NAR) in high CO<sub>2</sub> grown plants.

Demonstration of a negative correlation between photosynthesis and assimilate supply is complicated by the fact that assimilates are themselves products of photosynthesis. Thus, as pointed out by Guinn and Mauney (1980), higher photosynthetic rates should cause the production of more assimilates and result in a positive, rather than in a negative correlation. Failure to demonstrate a negative correlation does not prove the absence of end-product inhibition when accumulation of assimilates and measurement of  $P_n$  are not separated in time.

In addition to  $\text{CO}_2$  enrichment, other approaches have been used to investigate the question of feedback control of photosynthesis. These include alteration of temperature, photoperiod and source-sink relations; exogenous application of sugars and plant growth regulators; and examination of diurnal, seasonal or ontogenic changes in carbohydrates,  $P_n$ , specific leaf weight and other growth parameters (Mason, 1928a,b; Maskell and Mason, 1930; Wardlaw, 1968; Wareing *et al.*, 1968; Gifford, 1980; Guinn and Mauney, 1981; Gifford and Evans, 1981).

Attempts to demonstrate end-product inhibition of photosynthesis with various experimental approaches vary in their success rate depending upon the species. Some species, such as sugarbeet, sugarcane and sorghum do not accumulate much starch, and therefore show no evidence of end-product inhibition. On the other hand, species such as alfalfa, cotton, pangolagrass, soybean and tomato accumulate starch and thus exhibit end-product inhibition. Alfalfa and pangolagrass are able to accumulate inhibitory amounts of starch under natural conditions, while cotton, soybean and tomato require  $\text{CO}_2$  enrichment to show statistically significant evidence of end-product inhibition. Approximately 200 mg of starch per gram dry weight of leaves is required before any end-product inhibition of  $P_n$  is observed in soybean and cotton (Nafziger and Koller, 1976; Mauney *et al.*, 1979; Guinn and Mauney, 1980).

According to Guinn and Mauney (1980), the starch content of cotton leaves in full sunlight and normal  $\text{CO}_2$  increases from a low of about 50 mg to a high of about 150 mg per gram dry weight of leaves during each day. Carbon dioxide enrichment increases the rate of starch synthesis but not its breakdown; consequently starch accumulates. The starch content of older, shaded leaves on field-grown leaves is much lower (Guinn, unpublished results as cited by Guinn and Mauney, 1980). Thus, only young leaves in full sunlight are likely to accumulate enough starch to inhibit  $P_n$ , and then only for a portion of each day. However, if the predicted increases in  $\text{CO}_2$  content of the atmosphere occur, starch would be expected to accumulate to superoptimal levels in several species (Guinn and Mauney, 1980). Outlaw and Manchester (1979) quantitatively related starch content of the guard cells to stomatal aperture. Changes in organic acids also are implicated in stomatal movement (Pallas and Wright, 1973).

Several investigators have observed that chlorosis of plants under  $\text{CO}_2$  enhanced atmospheres can be avoided by increasing the nutrient supply (Krizek, 1966, unpublished results; Wittwer, 1967; Downs and Hellmers, 1975). Hesketh

(personal communication, 1972, as cited by Downs and Hellmers, 1975) reported that increasing the day temperature from 31 to 35C was effective in preventing high starch accumulation and chlorosis in cotton.

From studies to date, it is clear, that in some species, photosynthetic rates can be controlled by the balance between supply of, and demand for, photosynthates. Some results suggest primary control by end-product inhibition (chiefly by starch), while others indicate hormonal control. Sinks such as developing fruits can stimulate photosynthesis by either type of control mechanism (Guinn and Mauney, 1980). In some cases, both types of regulation may occur in the same plant, either independently or as primary and secondary events (Guinn and Mauney, 1980). Although elaborate models of cotton growth have been developed (Hesketh *et al.*, 1972; Guinn *et al.*, 1976; Gifford and Jenkins, 1981; Jones *et al.*, 1980), it is clear that much more research is needed to elucidate the mechanism of feed-back control of photosynthesis and the role of CO<sub>2</sub> in this process. The influence of plant growth regulators, *e.g.*, abscisic acid (ABA), auxins, gibberellins, cytokinins and brassinosteroids (Tognoni *et al.*, 1967; Zhur *et al.*, 1970, 1972; Thomas, 1975; Raven and Rubery, 1982; Krizek and Mandava, 1983a,b) in photosynthetic partitioning, stomatal regulation, reproduction, senescence, abscission and other physiological processes must also be investigated in greater detail. In view of the possible and complex effects and interactions of these substances and assimilates such as sugars and starch, it is understandable that findings to date appear contradictory and confusing (Guinn and Mauney, 1980).

Recent techniques using <sup>14</sup>C-labeled CO<sub>2</sub> provide a rapid and convenient method for studying carbon allocation in plants (Manuson *et al.*, 1982; Fares *et al.*, 1983; Strain and Nelson, 1983). The role of sucrose phosphate synthetase in partitioning of carbon in leaves has also attracted considerable interest (Huber 1981a,b, 1983). This enzyme provides a biochemical basis for partitioning of carbon between starch and sucrose in soybean (Huber and Israel, 1982). Studies are in progress to determine the activity of this enzyme under CO<sub>2</sub>-enriched atmospheres (Huber *et al.*, 1982).

## GROWTH AND DRY MATTER PRODUCTION

The effects of CO<sub>2</sub> enrichment on vegetative growth and dry matter production are summarized in various publications (Wittwer and Robb, 1964; Bailey *et al.*, 1970; Kretchman and Howlett, 1970; Krizek *et al.*, 1970; Pettibone *et al.*, 1970; Wittwer, 1970, 1983; Strain, 1978; Allen 1979; National Academy of Sciences, 1979; Wong, 1979; Kramer, 1981). Wittwer and Robb (1964) reported large increases in fresh weight of cucumber, lettuce and tomato plants grown in CO<sub>2</sub> enriched greenhouses. Similar results were obtained by Krizek (1969, 1970, 1974) and Krizek *et al.* (1968, 1970a,b, 1974) for a wide range of vegetable, woody and ornamental species under controlled-environment conditions. Ten to fifty-fold increases in fresh and dry weights of young seedlings were obtained



under CO<sub>2</sub>-enriched atmospheres in the growth chamber when the PAR level and temperature were elevated as well as the CO<sub>2</sub> concentration and high relative humidity and nutrient levels were maintained.

In general, the best time to begin CO<sub>2</sub> enrichment is at the seedling stage. In some cases, even greater acceleration in growth can be obtained by direct seeding under CO<sub>2</sub> enhanced-atmospheres (Krizek *et al.*, 1970b). The growth habit of the plant also appears to be an important determinant of CO<sub>2</sub> sensitivity. Indeterminate plants such as cotton and soybean are more responsive to CO<sub>2</sub> enrichment

Table 5. Influence of CO<sub>2</sub> enrichment in the greenhouse on growth and development of DPL 16 cotton plants. Plants were grown in nutrient solution and were harvested shortly after they started blooming. (Data from Guinn, 1972a).

Parameter	CO <sub>2</sub> conc.	
	350 $\mu\text{l l}^{-1}$	1000 $\mu\text{l l}^{-1}$
Node number of:		
First fruiting position	5.2	5.1
First square	6.5	5.8
Squares/plant, no.	9.7	14.0
Blooms/plant, no.	0.8	0.2
Squares shed, %	29.7	15.4
Fresh wt., g/plant	105.0	115.0

Table 6. Components of yield of cotton plants as influenced by CO<sub>2</sub> and nutrient concentration. (Data from Mauney *et al.*, 1978).

Yield component	Year and nutrient conc.					
	1975, normal		1975, 2x,		1976, 2x	
			CO <sub>2</sub> conc. $\mu\text{l l}^{-1}$			
	330	630	330	630	330	630
LA, dm <sup>2</sup> /plant					195	260
Dry wt, g/plant					650	950
Blooms/plant, no.	67	86	69	105	69	110
Bolls/plants, no.	39	59	42	75	37	80
Percent boll retention	66	78	61	71	54	74
Boll wt, g/boll					4.7	5.5
Lint yield, g/plant					61	170
Seed yield, g/plant					114	274
Percent yield increase due to:						
Increase in blooms/plant		60		77		47
Increase in retention		40		23		29
Increase in lint/boll						24

Table 7. Influence of CO<sub>2</sub> concentration on growth analysis of cotton plants at different stages of growth and development. RGR, relative growth rate; NAR, net assimilation rate; DW, dry weight. (Data from Mauney *et al.*, 1978).

Stage growth	Duration days	CO <sub>2</sub> $\mu\text{l l}^{-1}$	RGR g/g/day	NAR mg/dm <sup>2</sup> /day	DW g/plant
Juvenile	10-30	630	0.28	280	29
	10-30	330	0.23	187	11
Reproductive	30-70	630	0.07	100	480
	30-70	330	0.07	88	200
Maturation	70-110	630	0.02	52	1100
	70-110	330	0.03	48	550

than are determinate plants such as corn, sorghum, sunflower, tobacco and Alaska pea (Kramer, 1981).

Typical effects of CO<sub>2</sub> enrichment on vegetative growth in cotton are shown in Tables 5, 6, and 7. Mauney *et al.* (1978) obtained significant increases in the rate of leaf initiation and in leaf area development in cotton grown under CO<sub>2</sub>-enriched atmospheres (Figures 5 and 6). In 40-day-old cotton plants grown in a greenhouse at 630  $\mu\text{l l}^{-1}$  CO<sub>2</sub>, there was a 2-fold increase in dry weight and a 1.6-fold increase in leaf area as compared with plants grown under ambient CO<sub>2</sub>. A decrease in nitrogen level in the nutrient solution gave a proportional decrease in the dry weight and leaf area. The assimilation rate increased 1.5-fold when the plants were grown with high nitrogen and high CO<sub>2</sub>. This increase was less at lower levels of nitrate in the nutrient solution (Wong, 1979). Cotton plants grown in high CO<sub>2</sub> had a lower assimilation rate in ambient CO<sub>2</sub> than plants grown at ambient air. The difference was due to the reduction in RuBPCase activity (Wong, 1979).

Studies to date indicate that the relationship between P<sub>n</sub> and responsiveness to CO<sub>2</sub> enhancement is rather poor. Consequently high photosynthetic rates alone under CO<sub>2</sub> enriched atmospheres may not be the crucial factor in determining yield. In many plants, there is a poor correlation between P<sub>n</sub> per unit leaf area and growth rate, total dry matter production or seed yield (Baker *et al.*, 1973; Evans, 1975; Peet *et al.*, 1977; Elmore, 1980; Wong, 1979).

The relationship between P<sub>n</sub> and yield depends on the developmental stage and many other factors (Muramoto *et al.*, 1965; Nagarajah, 1975a; Guinn *et al.*, 1977; Mauney, 1978; Elmore, 1980, see also Chapters 2 and 16). In dry bean (*Phaseolus vulgaris* L.), only at pod set, when P<sub>n</sub> was highest, were significant correlations found between P<sub>n</sub> and biological and seed yield in eight of nine field-grown cultivars (Peet *et al.*, 1977). In wheat, Krenzer and Moss (1975) found that CO<sub>2</sub> enhancement during floral initiation or grain development increased yield but had no effect if applied prior to flowering. In soybean, Hardman and Brun (1971) obtained no effect of CO<sub>2</sub> enrichment (1200  $\mu\text{l l}^{-1}$ ) on either total

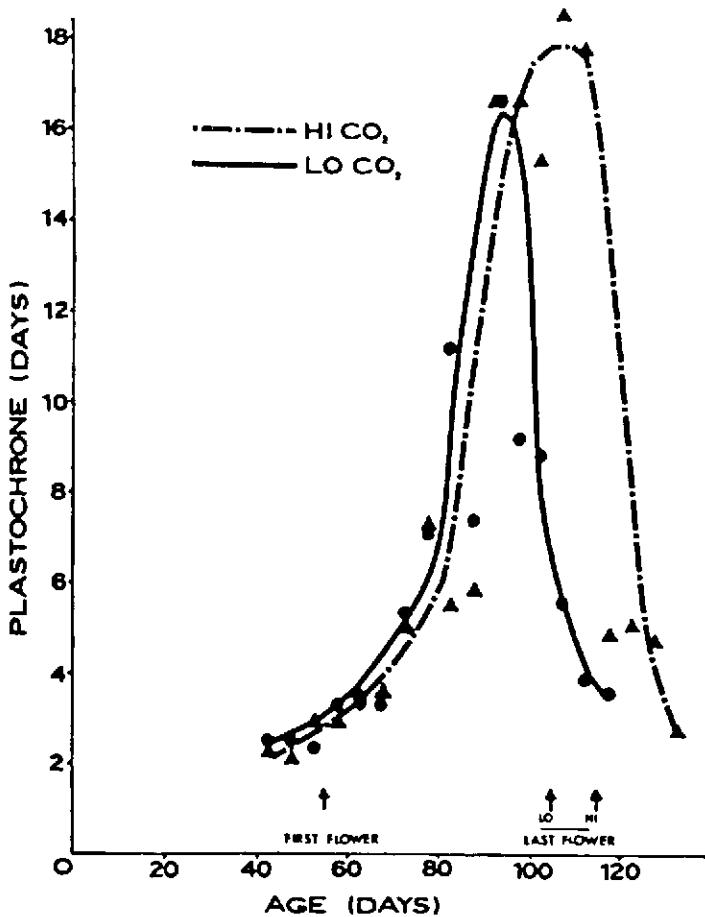

Figure 5. Rate of initiation of primary leaves of cotton as measured by plastochron (days between leaves) for plants grown at  $330 \mu\text{l l}^{-1} \text{CO}_2$  (Lo) or  $630 \mu\text{l l}^{-1} \text{CO}_2$  (Hi) from 45 days of age. (Data from Mauney *et al.*, 1978).

dry matter or yield, if given for a 5-week period during the vegetative stage prior to flowering. Carbon dioxide enrichment given for a 5-week period during flowering increased node number, leaf and stem dry weight, and pod number, but had no effect on seed yield. However,  $\text{CO}_2$  enhancement given for a 5-week period during pod filling caused a marked increase in pod weight and seed yield at maturity but had no effect on vegetative growth.

Time of  $\text{CO}_2$  enrichment in the field, may, therefore, be of considerable importance in cotton culture. Carbon dioxide enrichment during the juvenile state resulted in the maximum increase in cotton growth based on measurements of relative growth rate (RGR) and net assimilation rate (NAR) (Mauney *et al.*,

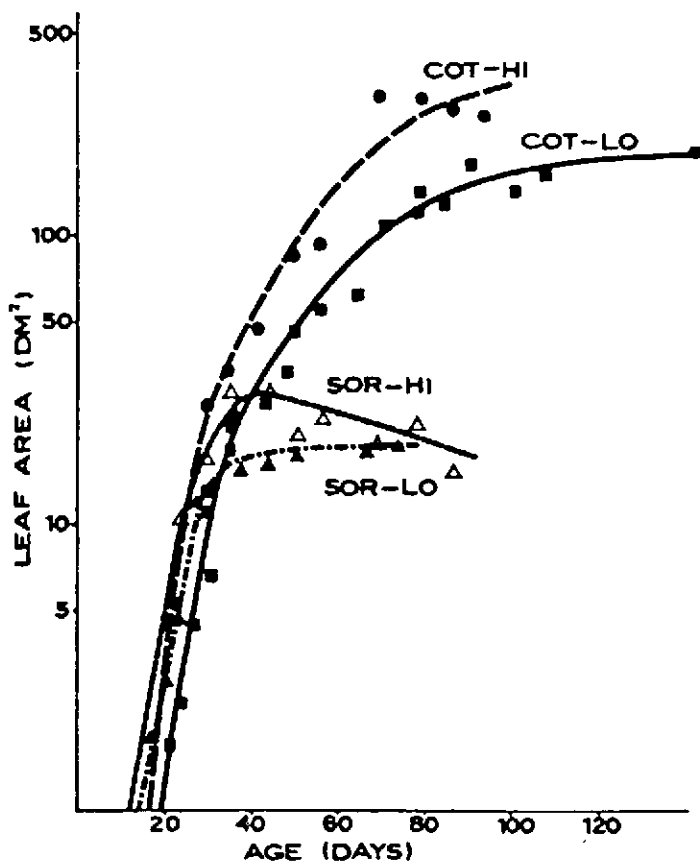

Figure 6. Leaf area development of cotton (COT) and sorghum (SOR) plants grown from germination in the greenhouse under  $330 \mu\text{l l}^{-1} \text{CO}_2$  (Lo) or  $630 \mu\text{l l}^{-1} \text{CO}_2$  (Hi). (Data from Mauney *et al.*, 1978).

1979). The frequency of CO<sub>2</sub> application may also be important (Clough and Peet, 1981).

Compared to leaves of other species, the cotton leaf is able to photosynthesize quite rapidly (Table 2) and compares well with other efficient species in the rate of CO<sub>2</sub> fixation based on the amount of leaf surface exposed to PAR (El Sharkawy *et al.*, 1965; El Sharkawy and Hesketh, 1965; Carns and Mauney, 1968; Zelitch, 1971; Wittwer, 1978a,b). However, cotton does not translocate as much photosynthate into new leaf surfaces as do other species with comparable  $P_n$ . As a result, it does not accumulate plant dry weight as rapidly as sunflower, corn, and

soybean (Carns and Mauney, 1968). Carns and Mauney (1968) have pointed out that in view of the rapid photosynthetic rate in cotton, increased dry weight accumulation could be achieved best through changes in the transport of photosynthate to the leaf surface and partitioning of the photosynthate. Because of the compound interest accretion of leaf growth, a high proportion of photosynthate translocated to new leaf development early in the growing season would be especially important, since the increased foliar surface forms the basis for additional CO<sub>2</sub> fixation.

Whether source or sink is the more critical factor in controlling abscission of flowers, squares and bolls in cotton is difficult to establish since the demand for assimilates for fiber and seed production can have a marked feedback effect on the rate of photosynthesis (Hawkins *et al.*, 1933; Brown, 1968; Evans, 1975; Wareing and Patrick, 1975; Saleem and Buxton, 1976; Ho, 1978; Harrocks *et al.*, 1978; Treharne, 1982). Photosynthetic rates in individual leaves may differ strikingly with ontogenetic changes in the plant. Photosynthetic rates in soybean leaves are much higher during filling of the pods than during flowering, even under water stress, presumably due to increased demand at a later stage (Evans, 1975). Studies by Cock and Yoshida (1973) and Yoshida *et al.* (1971) showed that CO<sub>2</sub> enrichment in the field can change source and sink relationships in rice. Evans (1975) pointed out that in cotton, leaves supporting large bolls may have relatively low rates of photosynthesis due to the withdrawal of nitrogen from them by the boll.

The allocation of photosynthate is the result of complex interactions between competitive sinks for available assimilate (Yoshida, 1973). In sugarbeet, increasing the concentration of CO<sub>2</sub> to 1000  $\mu\text{l l}^{-1}$  increased P<sub>n</sub> by as much as 50 to 100 percent in one study (Ford and Thorne, 1967). In another study (Wyse, 1980), CO<sub>2</sub> enrichment for 10 days increased total dry weight production of sugarbeet seedlings by 180 percent. However, decreasing the oxygen concentration from 21 to 5 percent to reduce the rate of photorespiration had no significant effect on biomass production. The primary effect of low O<sub>2</sub> was to enhance root diameter and leaf number but had little effect on other growth parameters.

One of the most striking effects of CO<sub>2</sub> enrichment in plants is an increased branching response (Krizek *et al.*, 1968, 1971, 1974). Axillary branches of cotton plants can be greatly stimulated at 30C under CO<sub>2</sub> enriched atmospheres or other conditions conducive to a rapid supply of photosynthate (*e.g.*, intense solar radiation) (Evans, 1975). Other investigators have also reported marked effects of CO<sub>2</sub> enrichment on apical dominance (Poez *et al.*, 1980).

## TRANSPIRATION AND STOMATAL ACTIVITY

One of the primary benefits of CO<sub>2</sub> enhancement is to increase the water-use efficiency (Figure 7) of plants by partial closure of stomates and a concomitant decrease in transpiration (Figure 8 and Table 8) (Heath, 1948, 1949, 1950, 1959; Heath and Milthorpe, 1950; Heath and Russell, 1954; Stalfelt, 1959; de Wit,

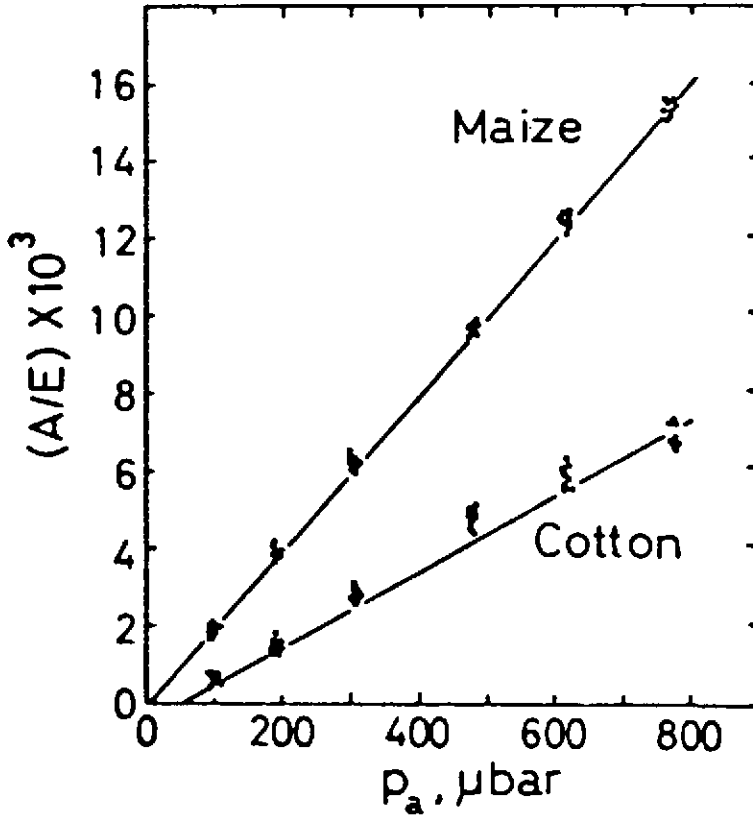

Figure 7. Water use efficiency ( $A/E$ ) (mol CO<sub>2</sub>/mol H<sub>2</sub>O) of cotton and maize plants as influenced by CO<sub>2</sub> concentration ( $\mu\text{l l}^{-1}$  or  $\mu\text{bar}$ ). The straight lines were theoretical relationships as described by Wong, 1980, assuming a vapor pressure difference of 20 mbar. The dots are actual experimental values.

1958; Pallas, 1965; Jarvis, 1971; Raschke, 1972, 1974, 1975a,b, 1976, 1979; van Bavel, 1972a, 1974, van Bavel *et al.*, 1973; Farquhar and Cowan, 1974; Tinus, 1974; Takami and van Bavel, 1975; Raschke *et al.*, 1976; Goudrian and van Lear, 1978; Enoch and Hurd, 1977, 1979; Farquhar *et al.*, 1978; Gifford, 1979a,b; Carlson and Bazzaz, 1980; Louwense, 1980; Sionit *et al.*, 1980, 1981d; Wong, 1979, 1980; Heath and Meidner, 1981; Rosenberg, 1981; Farquhar and Sharkey, 1982; Björkman and Pearcy, 1982; Wittwer, 1983). The ratio of CO<sub>2</sub> taken up in photosynthesis to the water lost in transpiration is termed photosynthetic water-use-efficiency (Björkman and Pearcy, 1982). Water-use-efficiency may also be expressed in terms of the amount of biomass gain for the amount of water lost in a given period of time. One of the direct effects of CO<sub>2</sub> enhancement on photosyn-

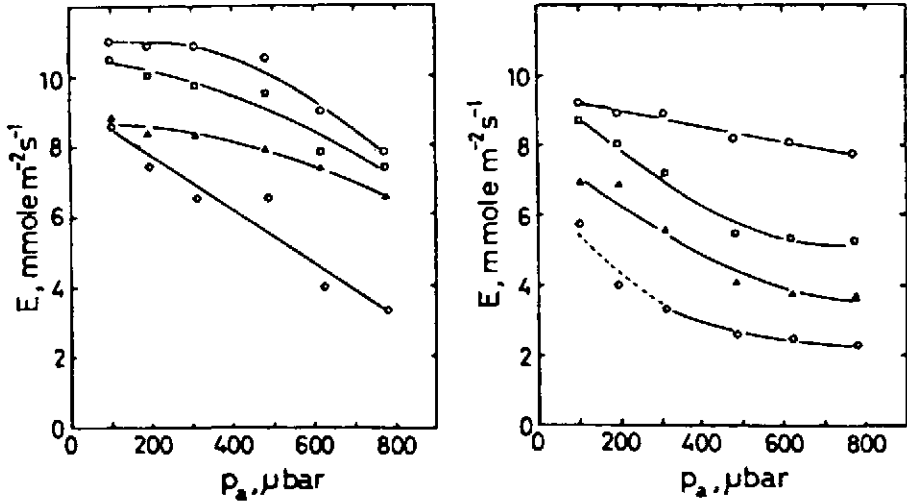

Figure 8. Rate of transpiration ( $E$ ) in cotton as influenced by  $\text{CO}_2$  concentration. The plants were grown at  $330 \mu\text{l l}^{-1}$  ( $\mu\text{bar}$ ) (left) or  $660 \mu\text{l l}^{-1}$   $\text{CO}_2$  (right) and under four levels of nitrogen nutrition. Details as in Figure 1. (Data from Wong, 1980).

Table 8. Transpiration rate of 40-day old cotton plants and 30-day old maize plants as influenced by  $\text{CO}_2$  concentration and nitrogen nutrition. (Data from Wong, 1980).

Nitrogen $\text{mM NO}_3^-$	Transpiration rate ( $\text{mmol m}^{-2} \text{s}^{-1}$ )			
	Cotton		Maize	
	$\text{CO}_2$ ( $\mu\text{l l}^{-1}$ )			
	330	660	330	660
24.0	1.79	2.12	1.52	0.99
12.0	1.33	2.25	1.08	0.89
4.0	1.05	0.97	1.64	0.24
0.6	0.29	0.21	0.26	0.11

thesis in  $\text{C}_3$  plants is increased photosynthetic water-use-efficiency. Water-use-efficiency was doubled in both cotton and maize plants grown at high  $\text{CO}_2$  irrespective of the nitrate level in the solution. This increase in water-use-efficiency was due primarily to reduced transpiration in some treatments and to increased assimilation in others (Wong, 1979). According to Björkman and Pearcy (1982) photosynthetic water-use-efficiency in  $\text{C}_3$  plants would be expected to double with a doubling of  $\text{CO}_2$  in the atmosphere. In a  $\text{C}_4$  species this effect would likely be smaller but still significant. In a mixture of  $\text{C}_3$  and  $\text{C}_4$  species, the  $\text{C}_3$

crops would likely benefit to a greater extent from an increase in atmospheric CO<sub>2</sub> concentration (Wittwer, 1983). From a model of CO<sub>2</sub> uptake of carnation plants, Enoch and Hurd (1979) estimated that the water-use-efficiency (net photosynthesis rate/transpiration rate) would increase by 40-50 percent during the next 50 years assuming a global increase in atmospheric CO<sub>2</sub> level to 600  $\mu\text{l l}^{-1}$ .

Stomatal conductance decreases with increasing CO<sub>2</sub> concentration in both C<sub>3</sub> and C<sub>4</sub> species (Wittwer, 1983). Increasing the CO<sub>2</sub> content of the atmosphere in controlled-environment chambers to 400  $\mu\text{l l}^{-1}$  reduced the transpiration rate of corn and sorghum and to a lesser extent, that of cotton, soybean and tomato plants by causing the stomata to close. Stomata of the two monocots, corn and sorghum, closed when the CO<sub>2</sub> concentration was at 2000 and 3000  $\mu\text{l l}^{-1}$  respectively. Cotton, soybean and tomato stomata, on the other hand, did not close completely even at CO<sub>2</sub> concentrations up to 4000  $\mu\text{l l}^{-1}$  (Pallas, 1965).

On the basis of natural fluctuations in CO<sub>2</sub> level in crop stands (about 5 percent) one might conclude that the antitranspirant action of CO<sub>2</sub> in open field culture might be insignificant. However, if one accepts the premise that it is the internal concentration of CO<sub>2</sub> rather than the external concentration that regulates stomatal behavior, the role of CO<sub>2</sub> as an antitranspirant may have greater significance than is generally appreciated (van Bavel, 1974).

Because of the close connection between CO<sub>2</sub>, abscisic acid (ABA), ethylene and water stress, their role in stomatal regulation needs to be considered when conducting CO<sub>2</sub> studies on cotton and when developing models of cotton productivity (Zelitch, 1963, 1965; Whiteman and Koller, 1967; Meidner and Mansfield, 1965, 1968; Meidner, 1969; Horton, 1971; Kriedemann *et al.*, 1972; Hiran Kriedemann, 1974; Beardsell and Cohen, 1975; Davenport *et al.*, 1977; Loveys, 1977; Dorffling *et al.*, 1977, 1980; Dubbe *et al.*, 1978; Mansfield *et al.*, 1978; Korner *et al.*, 1979; Malloch and Fenton, 1979; Schulte and Dorffling, 1981; Fenton *et al.*, 1982; Ackerson and Radin, 1983; Paez *et al.*, 1983). The role of water stress and ABA in inducing stomatal closure is well known (Milthorpe and Spencer, 1957; Dale, 1961; Slatyer and Bierhuizen, 1964a,b; Allaway and Mansfield, 1967; Slatyer, 1967; Cowan and Milthorpe, 1968; Milthorpe, 1969; Mittelheuser and Van Steveninck, 1969, 1971; Jordan, 1970; Cowan and Troughton, 1971; Cummins *et al.*, 1971; Jordan and Ritchie, 1971; Hsiao, 1973; Sharpe, 1973; Milborrow, 1974a,b, 1979, 1980; Turner, 1974; Raschke, 1975a,b; Mansfield, 1976; Ackerson *et al.*, 1977; Cowan and Farquhar, 1977; Walton *et al.*, 1977; Ackerson and Hebert, 1981; Henson, 1981; Sionit *et al.*, 1981d; Ackerson, 1980, 1982; Cowan *et al.*, 1982).

Slatyer and Bierhuizen (1964b) and Holmgren *et al.* (1965) reported that the stomatal resistance of leaves of cotton grown under controlled conditions increased with age. Jordan *et al.*, (1975) obtained evidence to suggest that stomatal closure on lower leaves of cotton plants subjected to water stress was associated with leaf age as well as with PAR effects. The nature of the age-related changes is unknown. The effect of age on stress-induced stomatal closure was not associated



with a loss of potassium from the older leaves. Increases in both the free and bound forms of ABA were observed in water-stressed plants, but the largest accumulation of ABA was found in the youngest leaves. Thus, the pattern of ABA accumulation in response to water stress did not parallel the pattern of stomatal closure induced by water stress.

Goudriaan and van Laar (1978) observed that the stomatal conductance of corn and bean, but not sunflower, was reduced by an increase in CO<sub>2</sub>. They attributed this to a greater efficiency in utilization of water in corn than in sunflower. Reports of increased water-use-efficiency under CO<sub>2</sub> enriched atmospheres have also been published for cotton (Ehrler *et al.*, 1966), wheat (Gifford, 1979a,b) and carnation (Enoch and Hurd, 1979).

### REPRODUCTIVE DEVELOPMENT

Typical effects of CO<sub>2</sub> enrichment on flower initiation, boll production, lint and seed yield, and other parameters of reproductive development are summarized in Tables 5, 6 and 9. In experiments reported by Mauney *et al.* (1978), cotton plants grown under CO<sub>2</sub> enriched atmospheres of 630  $\mu\text{l l}^{-1}$  set twice as many bolls as plants exposed to 330  $\mu\text{l l}^{-1}$  CO<sub>2</sub>. Similar increases in yield were obtained by Guinn (1972a, 1974) at 1000  $\mu\text{l l}^{-1}$  CO<sub>2</sub>. In addition to increasing the number of squares, Guinn (1972a) also observed that increasing the CO<sub>2</sub> level in the greenhouse from about 350  $\mu\text{l l}^{-1}$  to 1000  $\mu\text{l l}^{-1}$  lowered the node number of the first boll (Table 5). In contrast, warm nights (30C) and short photoperiods raised the node number of the first boll (Guinn, 1973).

Table 9. Influence of atmospheric CO<sub>2</sub> level in the greenhouse on total number of fruiting positions (FP), percentage of the total fruiting positions that abscised their fruiting forms (Percent FP abscised), and on number of squares, blooms, and bolls remaining on DPL 16 cotton plants at time of harvest (No. FP retained). Means and their standard errors are based on 40 plants per treatment. (Data from Guinn, 1974a).

CO <sub>2</sub> conc. $\mu\text{l l}^{-1}$	Total No. fruiting positions	Percent FP abscised	No. FP retained
First test: <sup>1</sup>			
350	14.3 $\pm$ 0.5	30.9 $\pm$ 2.3	9.9 $\pm$ 0.6
1000	16.8 $\pm$ 0.6	16.4 $\pm$ 2.2	14.2 $\pm$ 0.7
Second test: <sup>2</sup>			
350	37.2 $\pm$ 1.5	25.6 $\pm$ 1.6	28.4 $\pm$ 1.5
1000	36.9 $\pm$ 1.3	17.1 $\pm$ 1.4	30.8 $\pm$ 1.4

<sup>1</sup>Plants were harvested as soon as the first squares reached the bloom stage.

<sup>2</sup>Plants were permitted to set some bolls before they were harvested.

## SENESCENCE AND ABSCISSION

Numerous studies concerning the influence of CO<sub>2</sub> and O<sub>2</sub> on abscission or senescence in intact plants are available (Hall, 1958; Abeles and Gahagan, 1968; Widholm and Ogren, 1969; Davis and Addicott, 1972; Addicott and Lyon, 1973; Hesketh and Hellmers, 1973; Guinn, 1973, 1974a; Osborne, 1974; Chatterjee, 1977; Chatterjee and Chatterjee, 1972; Chang, 1975; Warma, 1976a,b,c,d; Vaughan and Bate, 1977; Nooden, 1980; Satler and Thimann, 1983; Thimann, 1978; Thimann and Satler, 1979; St. Omer and Horvath, 1983a,b). In general, CO<sub>2</sub> retards abscission while O<sub>2</sub> promotes it (Carns, 1951; Yamaguchi, 1954; Abeles and Gahagan, 1968; Addicott and Lyon, 1973; Kozlowski, 1973). Abeles and Gahagan (1968) reported that a few percent of CO<sub>2</sub> in air reduced the rate of explant abscission appreciably. However, in mixtures of CO<sub>2</sub> and O<sub>2</sub> Yamaguchi (1954) found that more than 15 percent CO<sub>2</sub> was needed to reduce abscission rates to half those observed in pure O<sub>2</sub>.

There is increasing evidence that ethylene is involved in the shedding of various plant parts (McAfee and Morgan, 1971; Lipe and Morgan, 1972a,b, 1973; Abeles, 1973; Kozlowski, 1973). Ethylene promotes abscission in at least two ways. It decreases the auxin content of the abscission zone, and it stimulates the synthesis of lytic enzymes (*viz.*, pectinase and cellulase in the abscission zone) that weaken the middle lamella and cell wall (Guinn, Chapter 12). Virtually any environmental stress can induce ethylene production in cotton plants (Guinn, 1974b, 1976a,b, 1979, 1982). These include water stress (McMichael *et al.*, 1972; Jordan *et al.*, 1972), chilling injury (Abeles, 1973; Guinn, 1979) and other stresses.

Ethylene has been shown to interact strongly with both O<sub>2</sub> and CO<sub>2</sub> (Yamaguchi, 1954; Abeles and Gahagan, 1968; Lipe and Morgan, 1972b; Abeles, 1973; Marynick, 1977). Depending on the tissue, CO<sub>2</sub> can inhibit, promote, or have no effect on ethylene (Abeles, 1973). Except for rice, low concentrations of oxygen typically inhibit ethylene production. The inhibition of ethylene production under anaerobic conditions has been observed by many investigators for a wide range of tissues.

A literature review of CO<sub>2</sub> action on various ethylene-mediated processes indicates that in most cases CO<sub>2</sub> blocks or retards ethylene action (Dhawan *et al.*, 1981). A few exceptions include growth promotion of respiration in lemon, and removal of astringency from persimmons. In these cases, CO<sub>2</sub> had the same effect as ethylene (Abeles, 1973). Cracker and Abeles (1969) reported that ABA stimulated ethylene production by cotton and bean explants, but the stimulation was small and evident for cotton only at the highest concentration (0.5 nM) of ABA tested.

Lipe and Morgan (1972a,b) found that fumigation of detached cotton fruits with 10 percent CO<sub>2</sub> readily delayed dehiscence. The CO<sub>2</sub> effect was duplicated by placing the fruits under reduced pressure (200 mm mercury) to promote the escape of ethylene from the tissues. Dehiscence was delayed in both detached and

attached fruits. By varying the mixture of CO<sub>2</sub> and ethylene, they were able to vary the rate of dehiscence in cotton fruits. A combination of 13 percent CO<sub>2</sub> and 1.0  $\mu\text{l l}^{-1}$  of ethylene resulted in a competitive balance in which fruits dehiscid at the same rate as control fruits.

The influence of hormonal and environmental factors on boll shedding in cotton has been reported by various investigators (Lloyd, 1920; Mason, 1922; Dunlap, 1943, 1945; Saad, 1951; Eaton and Ergle, 1953, 1954; Goodman, 1955; King *et al.*, 1956; Dale, 1959; Johnson and Addicott, 1967; Heilman *et al.*, 1971; Jordan *et al.*, 1972; Abeles, 1973; Kozlowski, 1973; Guinn, 1972a,b, 1973, 1974a,b, 1976a,b; McMichael *et al.*, 1973; Osborne, 1974; Guinn and Fry, 1981). Hearn (1972) postulated that bolls are retained only if the demand for carbohydrates does not exceed the supply and that boll abscission is regulated by the balance between supply and demand. Cloudy weather (Mason, 1922; Goodman, 1955; Ehlig and Le Mert, 1973), low photosynthetically active radiation (PAR) levels (Dunlap, 1943, 1945), artificial shading with muslin (Sorour and Rassoul, 1974), close spacing (Brown, 1971) and partial (Eaton and Ergle, 1954a) or complete (Mason, 1922) leaf removal can also cause shedding of flowers, squares and bolls, presumably by reducing the amount of photosynthesis and carbohydrate supply (Guinn, 1978), but also by reducing the supply of growth regulators (Eaton and Ergle, 1953).

By increasing the CO<sub>2</sub> concentration of the atmosphere in a greenhouse from 350  $\mu\text{l l}^{-1}$  to 1000  $\mu\text{l l}^{-1}$ , Guinn (1973, 1974) was able to decrease shedding in DPL 16 cotton plants (Table 9) and increase the concentration of sugars (Table 10) in the leaves. Increasing the daily photoperiod from 8 to about 14 hours produced effects similar to those of CO<sub>2</sub> enrichment.

Table 10. Influence of CO<sub>2</sub> level and photoperiod on sugar content of leaves from DPL 16 cotton plants grown in the greenhouse. Means and their standard errors are based on 40 plants per treatment. (Data from Guinn, 1974a).

Treatment	Fructose	Glucose mg/g dry weight	Sucrose
CO <sub>2</sub> Conc.			
1000 $\mu\text{l l}^{-1}$	6.7 $\pm$ 0.4	17.4 $\pm$ 1.0	10.9 $\pm$ 0.4
350 $\mu\text{l l}^{-1}$	3.9 $\pm$ 0.4	9.3 $\pm$ 0.7	12.6 $\pm$ 0.6
Photoperiod			
long-day <sup>1</sup>	3.6 $\pm$ 0.4	16.3 $\pm$ 1.3	7.8 $\pm$ 0.4
8-hour day	1.9 $\pm$ 0.4	10.2 $\pm$ 0.6	6.8 $\pm$ 0.4

<sup>1</sup>Long-day conditions ranged from 14.4 hours at the beginning of the experiment to 12.5 hours at the end.

Warm nights (30C) and/or short photoperiods increased shedding and decreased starch content of the leaves (Guinn, 1973, 1974a). These results suggest

that fruiting and shedding in cotton are influenced by a balance between photosynthesis and respiration. Factors that decrease photosynthesis or increase respiration (low PAR, short photoperiod, low CO<sub>2</sub> and warm nights) tend to delay fruiting and increase abscission of squares and bolls while those conditions that increase photosynthesis or decrease respiration (high PAR, long photoperiods, high CO<sub>2</sub> and cool nights) tend to enhance fruiting and decrease abscission of reproductive structures (Guinn, 1974a).

The influence of brief periods of low PAR on shedding of cotton bolls was reported by Guinn (1973). He found a gradual depletion of sugars, starch and lipid-soluble phosphate in 6-day-old bolls when plants were transferred from the greenhouse to low PAR conditions. This shedding was preceded by a decreased rate of growth and lower protein and RNA contents.

Levels of PAR reaching the lower part of the plant canopy in high density populations (more than 100,000 plants per hectare) of cotton may, therefore, be severely limiting to photosynthesis (Guinn, 1974a). Since developing bolls obtain most of their photosynthate from subtending leaves, bracts and leaves one node removed (Ashley, 1972), low PAR levels in this position would probably limit boll retention there (Guinn, 1974a). Close spacing could also result in increased root competition or ethylene accumulation in the plant canopy (Heilman *et al.*, 1971).

The mutually compensating effect of PAR and CO<sub>2</sub> under field conditions for wheat (Imazu *et al.*, 1965) and in the greenhouse for horticultural crops (Hoppen and Ries, 1962) suggests that CO<sub>2</sub> enrichment in the field under cloudy conditions might be beneficial in reducing abscission in cotton by increasing the amount of assimilate and by reducing the substrate for photorespiration.

Guinn (1976a) pointed out that the nutritional and hormonal theories for the control of boll shedding in cotton are not necessarily contradictory or exclusive. His results indicate that nutritional stress increases the rate of ethylene evolution by young cotton bolls. The additional ethylene may be a causal factor in increasing boll abscission when cotton plants are subjected to nutrient stress.

Carbon dioxide and ethylene are generally antagonistic in their effects on abscission. Certain nutritional and other environmental stresses are known to promote ethylene production. Jordan *et al.* (1972) reported that 15 percent CO<sub>2</sub> could reverse the abscission-promoting effects of ethylene on cotyledonary leaves of Stoneville 213 cotton plants when given in combination with water stress at plant water potentials above -1.2 mPa but had no reversal effect at lower water potentials.

In many industrial areas (*e.g.*, the Los Angeles basin), ambient CO<sub>2</sub> levels can increase to 500  $\mu\text{l l}^{-1}$  and higher (Pallas, 1970). Since ethylene levels are also generally high in these same locations, it is hard to say whether any salutary effect of CO<sub>2</sub> enrichment on the yield of nearby cotton crops might result.

The potential use of CO<sub>2</sub> enrichment to increase cotton production will depend upon many environmental and morphological factors. Environmental factors include plant and soil water status, relative humidity, nutrient supply, tempera-

ture, light spectral quality and composition of other gases such as O<sub>2</sub>, ethylene and pollutants. Morphological factors include canopy structure, leaf shape and anatomy, boundary layer thickness, stomatal diffusive resistance, chloroplast lamellar characteristics, root development and endogenous rhythms.

## INTERACTION OF CO<sub>2</sub> AND OTHER ENVIRONMENTAL AND MORPHOLOGICAL FACTORS

The age of the plants and stage of development are also likely to be important factors based on results obtained with other crops (Krizek *et al.*, 1968, 1971; Zimmerman *et al.*, 1970; Yoshida, 1973; Krenzer and Moss, 1975; Wittwer, 1978a). Mauney *et al.* (1978) found that the greatest effect of CO<sub>2</sub> on net assimilation rate (NAR) in cotton was during the juvenile stage (Table 7). Careful studies—both under controlled-environment and field conditions—are needed to determine the optimum age, time, and duration of CO<sub>2</sub> enrichment. The type of substrate and irrigation system also are important in CO<sub>2</sub> enrichment studies (Plaut *et al.*, 1975; Lawson *et al.*, 1978; Nakayama and Bucks, 1980; Tarter, 1983).

Because of the vagaries of the field environment, it is often difficult to extrapolate findings from studies on CO<sub>2</sub> enrichment under controlled-environment conditions to those in the field. Temperature and moisture are perhaps the two most limiting environmental parameters in the field. Temperature effects on cotton production are discussed in Chapter 5, so they will not be discussed here. The role of water stress on the utilization of CO<sub>2</sub> and carbohydrate accumulation will only be covered briefly since this topic is addressed in Chapters 7, 8 and 10.

## WATER STRESS

The time of application and severity of water stress appear to be the main factors influencing yield in cotton. Severe moisture stress applied for 9 days during the peak flowering period reduced yield of Acala SJ-1 cotton in the San Joaquin Valley more than water stress periods of comparable duration applied either early or late in the flowering period (Grimes *et al.*, 1970). Severe water stress occurring early in the flowering period reduced yield by increasing shedding of squares before they flowered. Water stress late in the flowering period reduced flowering rate and retention of bolls. In some cultivars of cotton, soil moisture stress during the pre-flowering period was found to stimulate flower initiation and hence increase the number of bolls, while in other cultivars, boll size was increased (deBruyn, 1964; Singh, 1975).

The growth and development of the cotton plant is sharply curtailed during periods of water stress (Ergle, 1936, 1938; Eaton and Ergle, 1948; Jordan, 1970; Marin and da Silva, 1972; Marani and Levi, 1973). In cotton leaves, drought causes an increase in hexose sugars, variable effects on sucrose and large reductions in starch concentration. In stems and roots, however, there were always

moderate to large increases in the concentrations of hexoses, sucrose and starch (Eaton and Ergle, 1948). On the basis of averages of leaves, stems and large roots, these carbohydrates, for the plant as a whole, were doubled by protracted drought. Thus, drought appears to depress carbohydrate utilization to a greater extent than it does photosynthesis (Eaton and Ergle, 1948, see also Chapter 10).

In wheat, water stress during CO<sub>2</sub> enrichment under controlled environments was found to enhance the effects of CO<sub>2</sub> on grain yield (Gifford, 1979b). While similar effects are possible in cotton, one can only speculate at this time as to the comparative effects of CO<sub>2</sub> enrichment under water stress conditions.

### AIR POLLUTION

Air pollution has a significant effect on cotton yield (Ting and Dugger, 1968; Brewer and Ferry, 1974; Millican, 1976; Heggstad *et al.*, 1977; Heggstad and Christiansen, 1982). Most field studies have been conducted in open top chambers described by Heagle *et al.* (1973). Elevated levels of CO<sub>2</sub> in the atmosphere ameliorate the effects of SO<sub>2</sub> and other pollutants in both C<sub>3</sub> and C<sub>4</sub> plants (Mansfield and Majernik, 1970; Majernik and Mansfield, 1972; Hou *et al.*, 1977; Mansfield *et al.*, 1981; Carlson and Bazzaz, 1982; Carlson, 1983; Strain and Bazzaz, 1983). Since stomata provide the main routes for the entry of sulfur dioxide (SO<sub>2</sub>), ozone (O<sub>3</sub>) and other air pollutants into the leaves of higher plants, and CO<sub>2</sub> is known to reduce stomatal conductance, it is not surprising that increased CO<sub>2</sub> concentration should afford some protection against these pollutants (Mansfield, 1973; Unsworth *et al.*, 1973; Unsworth, 1981).

### IMPLICATIONS OF PROJECTED GLOBAL INCREASES IN ATMOSPHERIC CO<sub>2</sub>

Estimates as to the magnitude of increase in P<sub>r</sub> that might be expected in C<sub>3</sub> and C<sub>4</sub> plants with increased ambient levels of CO<sub>2</sub> vary widely (Bassham, 1977; Kramer, 1981; Baker and Enoch, 1982; Bjorkman and Percy, 1982; Kimball, 1982; Tolbert and Zelitch, 1982; Wittwer, 1983). Some reports suggest that a doubling in atmospheric CO<sub>2</sub> level may increase photosynthesis in C<sub>3</sub> plants by 50 percent, increase yield and dry weight by 20-45 percent and increase primary productivity by 40 percent (Baker and Enoch, 1982; Bjorkman and Percy, 1982; Bassham, 1977; Tolbert and Zelitch, 1982; Wittwer, 1983). Kimball (1982) tabulated and analyzed the results of more than 430 observations on the yields of 37 species grown under CO<sub>2</sub>-enriched atmospheres. These results were extracted from more than 70 reports published during a 64-year period. CO<sub>2</sub> enrichment increased the economic yield of all studied agricultural crops by an average of 28 percent (with a 99.9 percent confidence interval from 22 to 35 percent). Based on his analysis, a doubling in atmospheric CO<sub>2</sub> level was projected to increase yields by 33 percent (with a 99.9 percent confidence interval from 24 to 43 percent).

Kramer (1981), however, indicates that over the long term, exposure to high

CO<sub>2</sub> concentration often results in only a temporary increase in P<sub>n</sub>. The high P<sub>n</sub> observed in the seedling stage disappears, and the P<sub>n</sub> often falls below that of plants kept at ambient CO<sub>2</sub>. Kramer (1981) concludes that it is doubtful if a global doubling in CO<sub>2</sub> concentration will result in a large sustained increase in P<sub>n</sub> per unit of leaf surface, even though it may result in an increase in dry matter production of some species.

At the present rate of fossil fuel consumption, CO<sub>2</sub> concentration in the atmosphere is increasing on a global basis approximately 0.8 μl l<sup>-1</sup> per year. Background level of CO<sub>2</sub> concentration before the industrial revolution was about 258 μl l<sup>-1</sup> (Allen, 1979). If CO<sub>2</sub> concentration rises to 400 μl l<sup>-1</sup> by the year 2080 as some predict (Baes *et al.*, 1976), we might expect a 20 percent increase in photosynthesis rates of C<sub>3</sub> plants such as cotton, assuming no other factors are limiting (Allen, 1979).

Thus far, we have concerned ourselves only with the direct effects of CO<sub>2</sub> increases that are expected. However, because of the well-known greenhouse effect associated with CO<sub>2</sub>, any increase in global CO<sub>2</sub> concentration is also expected to result in an increase in surface temperature of the Earth (Kerr, 1977; Hoyt, 1979; NAS, 1979; Pearmon, 1980; Lockwood, 1982; Strain, 1982; Strain and Armentano, 1982). Such indirect climatic effects of CO<sub>2</sub> enhancement would be expected to have a significant impact on crop production under field conditions. Since this topic is beyond the scope of this chapter the reader is referred to the following references for further information on the long-term climatic effects of projected increases in CO<sub>2</sub> concentration: Keeling, 1970, 1977; Attiwill, 1971; Keeling *et al.*, 1976; Woodwell, 1978; Idso, 1980, 1983a,b; Gribbin, 1981; Hansen *et al.*, 1981; Kellogg and Schware, 1981; Clark, 1982; Kimball and Idso, 1982.

## SUMMARY

Most studies on CO<sub>2</sub> enrichment under greenhouse and growth chamber conditions have demonstrated the stimulatory effects of elevated CO<sub>2</sub> levels on the growth and development of cotton and other economically important plants. Recent tests involving CO<sub>2</sub> enrichment of cotton and other crops in the field are encouraging, but further studies are needed to determine whether or not the practice is economically feasible.

One of the most pronounced effects of CO<sub>2</sub> enrichment in cotton, tomato and other species is a large build-up in sugars and starches stored in the leaves. Increasing the CO<sub>2</sub> level from 330 μl l<sup>-1</sup> to 630-1000 μl l<sup>-1</sup> under controlled environments lowered the node number of the first flower, doubled boll production and delayed abscission of squares and bolls.

The metabolic consequences of CO<sub>2</sub> enrichment of cotton plants need to be examined in greater detail. Since CO<sub>2</sub> utilization can be influenced by a myriad of genetic, physiological, biochemical and morphological factors, careful studies are

required to determine the interaction of CO<sub>2</sub> with these factors. Because of the marked influence of CO<sub>2</sub> enrichment on water-use-efficiency through its effect on CO<sub>2</sub> assimilation, transpiration and stomatal regulation, special attention should be given to this area of research.

### ACKNOWLEDGEMENTS

Grateful acknowledgements are extended to Mr. Charles Bebee, National Agricultural Library, and Mr. Stephen Dubik, Mr. Roman Mirecki, and Mrs. Donna Peterman, Plant Stress Laboratory, for their helpful assistance.



## Chapter 18

# FEEDBACK CONTROL AND STRESS EFFECTS ON PHOTOSYNTHESIS

Daniel R. Krieg  
Texas Tech University  
Lubbock, Texas

## INTRODUCTION

In 1868, Boussingault first proposed the hypothesis "that the accumulation of assimilates in an illuminated leaf may be responsible for a reduction in the net photosynthetic rate of that leaf." To date, this hypothesis has not been conclusively proven nor disproven. Considerable activity continues to address the issue.

In this review, I want first to develop our current concept of the possible cause of feedback inhibition of photosynthesis in higher plants and then to discuss the photosynthetic response of cotton to environmental stress. The stress response will be related to direct versus indirect effects on the photosynthetic process.

The photosynthetic process consists of three distinct but integrated aspects, namely (1) the photochemical conversion of radiant energy to chemical energy, (2) the physical process controlling the transfer of  $\text{CO}_2$  from the atmosphere to the illuminated chloroplast and (3) the biochemical reactions involved in  $\text{CO}_2$  reduction. Therefore, if the products of the photosynthetic process inhibit the subsequent rate of carbon assimilation, the manifestations of the inhibition must reside in one of these three areas.

In 1968, Neales and Incoll reviewed the experimental evidence relevant to proving the end product inhibition hypothesis. They stated that in order to prove the hypothesis two conditions must be satisfied. First, a negative correlation between the measured photosynthetic rate and the concentration of assimilates in the leaf must exist, and second, a mechanism to explain the inhibition must be proposed. They concluded that experimental evidence was difficult to envisage which unequivocally confirmed the accumulation of assimilate in a leaf caused a decrease in the subsequent photosynthetic rate. Although evidence existed to indicate a negative correlation between assimilate concentration and photosynthetic rate, no mechanism to explain the response had been demonstrated.

Guinn and Mauney (1980) reviewed the literature developed largely since the 1968 review. They also concluded that demonstration of end-product inhibition is

difficult. The demonstration of a negative correlation between photosynthetic rate and assimilate concentration in a leaf is complicated by the fact that assimilates are the products of photosynthesis. Therefore, as photosynthetic rate increases, the production of assimilate increases and possibly results in a positive rather than a negative correlation. Failure to demonstrate a negative correlation does not prove the absence of end-product inhibition when accumulation of assimilate and photosynthetic rate are not separated in time.

The mechanisms proposed by Guinn and Mauney (1980) largely involved a physical disruption of normal chloroplast activities due to starch accumulation, and biochemical disruptions due to both simple and phosphorylated sugars (see Chapter 17). A hormonal control mechanism of photosynthesis was also suggested. The hormones were either produced by the leaves or translocated to the leaf tissue from other tissue such as developing fruits or roots. No definitive evidence was available to support the hormonal control hypothesis. To date, direct evidence is still non-existent, but much circumstantial evidence exists to suggest that the hormonal activity of a tissue may directly or indirectly influence the photosynthetic rate of green leaves (Geiger, 1976).

The current concept of plant growth rate being regulated by photosynthetic activity involves source-sink relationships. This concept implies that the source's ability to produce assimilate is directly related to the sink's ability to utilize assimilate for growth. Therefore, during the course of plant development, growth rates may be limited due to inadequate source activity, or due to inadequate sink activity, depending upon plant species, growth stage, and environmental conditions differentially affecting the source or the sink (see Chapter 16).

Efforts to demonstrate feedback inhibition of photosynthesis have largely been concerned with manipulations of source-sink ratios or with disruption of the translocation pathways. Many of these studies involved physical disruption of the normal source or sink size and, thus, wounding of the tissue. The results of these studies must be carefully interpreted with respect to subsequent metabolic activity on a whole plant basis. Alteration of normal source-sink ratios by nondestructive methods allows evaluation of not only the immediate responses of photosynthesis, but also the recovery potential upon return to the normal state. Techniques of nondestructive manipulation of source-sink ratios include reduction of effective leaf area by shading leaves and monitoring the unshaded leaves, altering sink activity by low temperature treatments, increasing external  $\text{CO}_2$  concentrations, and lengthening the photoperiod to alter total daily assimilate production. Other experiments did not manipulate the plant but monitored the diurnal or seasonal changes in photosynthetic rate and correlated this with assimilate concentration in the leaf as a function of normal source-sink activity changes. The preponderance of evidence, at this point in time, suggests that source activity is highly variable and subject to control by sink demand, strongly implying some type of feedback inhibition.

If end product inhibition of photosynthesis does exist, then the products must be interfering with one or more of the individual steps in the integrated process. Intermediates and products of the photosynthetic process include  $O_2$ , ATP, NADPH, simple and phosphorylated sugars, and starch. As previously stated, the photosynthetic process consists of three distinct aspects: (a) the photochemical conversion of radiant energy to chemical energy, (b) the physical processes controlling the transfer of  $CO_2$  from the atmosphere to the illuminated chloroplast and (c) the biochemical conversion of  $CO_2$  to  $CH_2O$  and its disposition. Current information concerning feedback inhibition will be discussed with respect to possible mechanisms involving each of these three components of the photosynthetic process.

## THE PHOTOCHEMICAL CONVERSION OF LIGHT TO CHEMICAL ENERGY

The light reaction involves the capture of photosynthetically active radiation by chlorophyll in the grana thylakoids and the subsequent transfer of electrons from  $H_2O$  to NADPH. The photooxidation of  $H_2O$  produces  $O_2$  and protons ( $H^+$ ), and the transfer of the electrons and protons across the thylakoid membrane results in an electrochemical gradient which provides the driving force for ATP synthesis (Chapter 15).

Guinn and Mauney (1980) emphasized the possible inhibitory effects of large starch granules in the chloroplast. The proposed mechanisms for feedback inhibition by starch were based on physical, rather than chemical effects. Accumulation of starch in the chloroplast could result in distortion of the grana, thereby altering the light absorption characteristics. However, Nafziger and Koller (1976) discounted this possibility because of the lack of response of photosynthesis to increasing irradiance when starch concentrations were high. Physical damage to the chloroplasts such as deterioration of the thylakoid membrane, absence of microbodies and leakage of chlorophyll results from large accumulations of starch (Ackerson and Herbert, 1981; De Silva *et al.*, 1974). However, excessive accumulation of starch is required to cause chloroplast damage.

A potentially serious problem associated with the photochemical conversion of solar energy to chemical energy is photoinhibition. Photoinhibition is defined as the photodestruction of the photosynthetic apparatus when photochemical energy cannot be dissipated in an orderly manner during normal  $CO_2$  fixation (Osmund *et al.*, 1980). In order for photoinhibition to be extensive, the internal  $CO_2$  concentration must be close to the  $CO_2$  compensation point and photorespiration must be inhibited (<1 percent  $O_2$ ). Photosystem II activity appears to be extremely sensitive to photoinhibitory damage; however, it is very unlikely that photoinhibition becomes a major limitation under normal environmental conditions.

## THE PHYSICAL PROCESS CONTROLLING THE TRANSFER OF CO<sub>2</sub> FROM THE ATMOSPHERE TO THE ILLUMINATED CHLOROPLAST

The total conductance of CO<sub>2</sub> can be partitioned into individual components as discussed by Nobel (1974). Stomatal conductance is similar for water vapor and CO<sub>2</sub> with a diffusion coefficient difference of 1.6 in favor water vapor at 20°C. Several reports suggest that stomatal conductance is altered by treatments which result in the accumulation of assimilate in the source leaf. Setter *et al.* (1980) reported that increased stomatal resistance was the cause of the reduced carbon exchange rate (CER) in soybeans which had been treated by altering the translocation system or by reducing sink size to increase assimilate concentration in the leaves. The stomatal response to the treatment was very rapid (0.5 hour with petiole girdling and 5 hours with pod removal) and coincident with CER reductions. These stomatal responses could also reflect alterations in the normal concentrations and activities of the leaf hormones (Geiger, 1976), especially abscisic acid (ABA) which is involved in stomatal control (Boveys and Kriedmann, 1974). Potter and Breen (1980) used an extended photoperiod treatment to alter sugar: starch concentrations in soybean and sunflower leaves. They observed stomatal conductance changes directly associated with CER reductions in both species. Older, essentially fully expanded, sunflower leaves were more responsive than were young, rapidly expanding leaves. Large accumulations of starch and soluble sugars were observed in all leaves but were not highly correlated with the photosynthetic rate changes. Peet and Kramer (1980) reduced source size by shading various soybean leaves. They reported that photosynthetic rates of the unshaded leaves increased, and the rate increase was associated with increases in both stomatal and mesophyll conductances. Thorne and Koller (1974), using similar techniques, found no change in soybean stomatal conductance as CER was increased. They did report that large reductions in mesophyll resistance accompanied the increased CER as sink demand increased relative to source activity. Additionally, the chloroplast starch concentrations were reduced tenfold; whereas, the soluble sugar concentrations were increased as CER increased. It is rather difficult to envision how solute accumulations can cause stomatal conductance changes, unless it is associated with altered hormonal relations of the leaf.

The increased length of the diffusion pathway for CO<sub>2</sub> around large starch grains has been proposed as an explanation for the increased mesophyll resistance by starch accumulation in the chloroplast. Based upon this assumption several studies evaluated CER in leaves with various starch concentrations generated in CO<sub>2</sub>-enriched atmospheres. As the external CO<sub>2</sub> concentration increases the effects of increased mesophyll resistance should lessen due to the steeper gradient from the external atmosphere to the site of carboxylation. Mauney *et al.* (1979) reported a negative correlation between net photosynthesis and starch concentrations when CER was measured at normal CO<sub>2</sub> levels (330 μ l l<sup>-1</sup> in cotton) (Figure

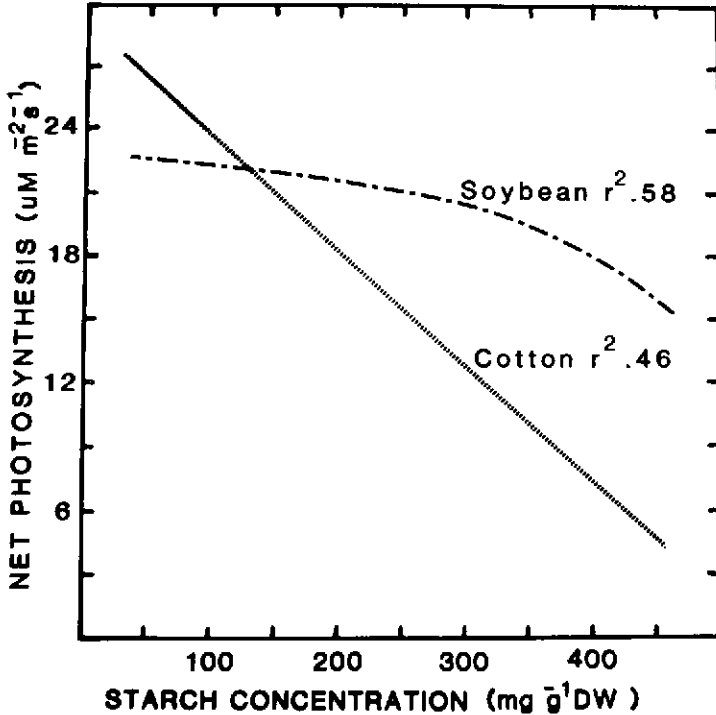

Figure 1. Net photosynthesis of cotton and soybean as a function of leaf starch concentration (adapted from Mauney *et al.*, 1979; Nafziger and Koller, 1976).

1). No significant correlation was found between soluble sugar concentrations and net photosynthetic rates in any of the four species examined. Nafziger and Koller (1976) suggested a curvilinear response of photosynthetic rate of soybean with leaf starch concentrations (Figure 1) as contrasted to a linear response proposed by Mauney *et al.* (1979) for cotton. In soybean, starch concentrations in excess of 1.5 mg cm<sup>-2</sup> were required to reduce the photosynthetic rate. In cotton, approximately a 10 percent reduction in net photosynthesis was observed for each 10 percent increase in starch concentration. Apparently the sensitivity of photosynthesis to leaf starch concentration is species and leaf condition dependent. Both groups indicated that starch concentrations greatly in excess of that normally observed in leaves were required to cause a significant reduction in the photosynthetic rate.

Nafziger and Koller (1976) also determined the CO<sub>2</sub> compensation point to differentiate between mesophyll resistance and carboxylation resistance. They found the CO<sub>2</sub> compensation point was not altered by increased starch concentration. They concluded that the intracellular transport of CO<sub>2</sub> (mesophyll resis-

tance) was the factor limiting photosynthesis when starch concentration was high.

The rate of diffusion of the  $\text{CO}_2$  molecule from the atmosphere to the site of carboxylation is reduced by accumulation of assimilate in the leaf. The primary cause of the increased resistance may be either stomatal or mesophyll depending upon species, leaf age or stage of development. The increased stomatal resistance observed in some species may be the result of altered hormonal relations in the leaf due to the type of treatment imposed to induce large concentrations of assimilate in the leaf. The mesophyll resistance increases are largely of a physical nature and excessive starch concentrations are required to significantly affect the photosynthetic rate.

## THE BIOCHEMICAL CONVERSION OF $\text{CO}_2$ TO $\text{CH}_2\text{O}$ AND ITS DISPOSITION

The reduction of  $\text{CO}_2$  to carbohydrate in the chloroplast occurs via the  $\text{C}_3$  photosynthetic carbon reduction (PCR) pathway essentially as described in the 1950's (Chapter 15). Although we recognize the existence of other pathways ( $\text{C}_4$  and CAM) responsible for the initial conversion of  $\text{CO}_2$  to organic compounds, they are subservient to the  $\text{C}_3$ -PCR pathway. We now recognize that the  $\text{C}_3$ -PCR pathway does not totally describe the path of carbon in the chloroplast under natural atmospheric conditions. Photosynthetic carbon metabolism can best be described as the integrated sum of the activities of two mutually opposing but interlocking cycles, the  $\text{C}_3$ -PCR cycle and the  $\text{C}_2$ -photosynthetic carbon oxidation (PCO) cycle (Figure 2). The  $\text{C}_2$ -PCO cycle is known as photorespiration. Ribulose biphosphate carboxylase/oxygenase (a bifunctional enzyme) serves to regulate carbon flow through these two competitive cycles through effects of  $\text{CO}_2$  and  $\text{O}_2$  concentrations and the kinetic properties of this enzyme (Latzko and Kelly, 1979). Several reviews address control of the activities of the two cycles and the resultant effect on net assimilation (Akazawa, 1979; Jensen and Bahr, 1977; Kelly and Latzko, 1976). Activation of RuBPC:Oase is a readily reversible process dependent on  $[\text{CO}_2]$ ,  $[\text{Mg}^{2+}]$ , pH and levels of sugar phosphates. (Bahr and Jensen, 1978; Jensen and Bahr, 1977; Lorimar *et al.*, 1979).  $\text{CO}_2$  is involved in both activation and catalysis. Several phosphorylated sugars are effectors of RuBPC:Oase. Fructose-6-P, ribulose-5-P, 6-P-gluconate, erythrose-4-P, and xylose-5-P, all at 1mM concentrations, function as activators of the carboxylase "*in vitro*" (Buchanan and Sherman, 1973). Inhibition of carboxylase activity has been demonstrated using fructose 1-6-BP, fructose-1-P and glucose-1-P. The role of the sugar phosphates in activation versus catalysis is not clearly established; however, the effectors probably act at a single site, the catalytic site for RuBP. Effectors such as 6-P-gluconate and NADPH stabilize the active form of the enzyme and possibly function *in vivo*, especially early in the light period. However, as the PCR cycle increases in activity, 6-P-gluconate disappears and probably

### PCR-PCO CYCLE

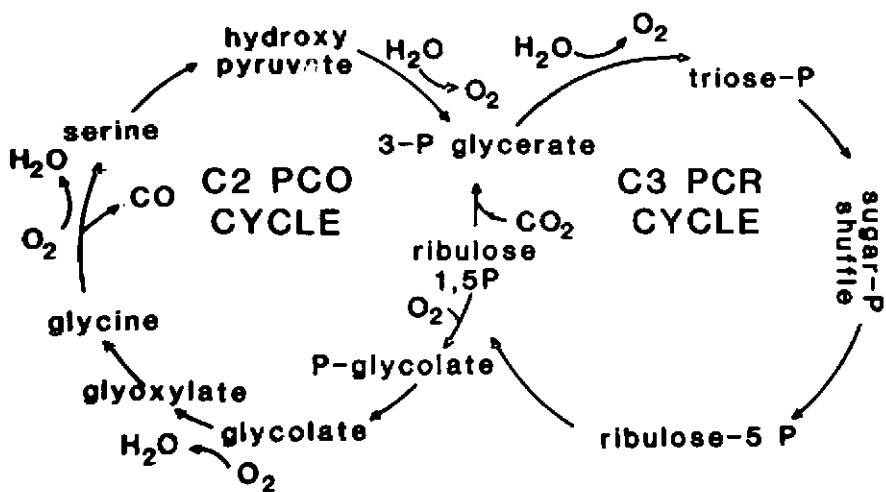

Figure 2. The photosynthetic carbon reduction-oxidation cycle existing in  $C_3$  plants.

has no further effect on RuBPC:Oase activity. The magnitude of the inhibitory and stimulatory effects of metabolites is generally not very great and also not very consistent among different investigators. Extensive research by Chollett and Anderson (1976) demonstrated that none of the chloroplast metabolites examined differentially regulate carboxylase/oxygenase activities. These results were as expected since the same active site serves the two opposing reactions.

Carbon dioxide and  $O_2$  compete for the same active site on this enzyme and control the ratio of carboxylation:oxygenation and thus the flow of carbon through the PCR versus the PCO cycles. Temperature plays a major role in determining  $CO_2:O_2$  concentrations in the chloroplast (Azcon-Bieto *et al.*, 1981; Bykov *et al.*, 1981; Tenhunen *et al.*, 1979). Since  $O_2$  is a product of the photochemical reaction, its concentration could be greater than that due to normal atmospheric conditions. Increases in net photosynthesis of 30 to 50 percent are observed in  $C_3$  species when the  $O_2$  content of the atmosphere is reduced from 20 percent to 1-2 percent (Laining *et al.*, 1974). In cotton, we estimated photorespiration as the difference between short time  $CO_2$  fixation rates and net carbon exchange rates (CER) of single leaves (Perry and Krieg, 1981; Perry *et al.*, 1983). At 25C photorespiration is minimal but increases rapidly with increasing temperature, reaching a maximum of 50 percent of net photosynthesis at 35-37C (Figure 3). Using a 2 percent  $O_2$  and  $340 \mu l l^{-1} CO_2$  gas mixture, we ascertained

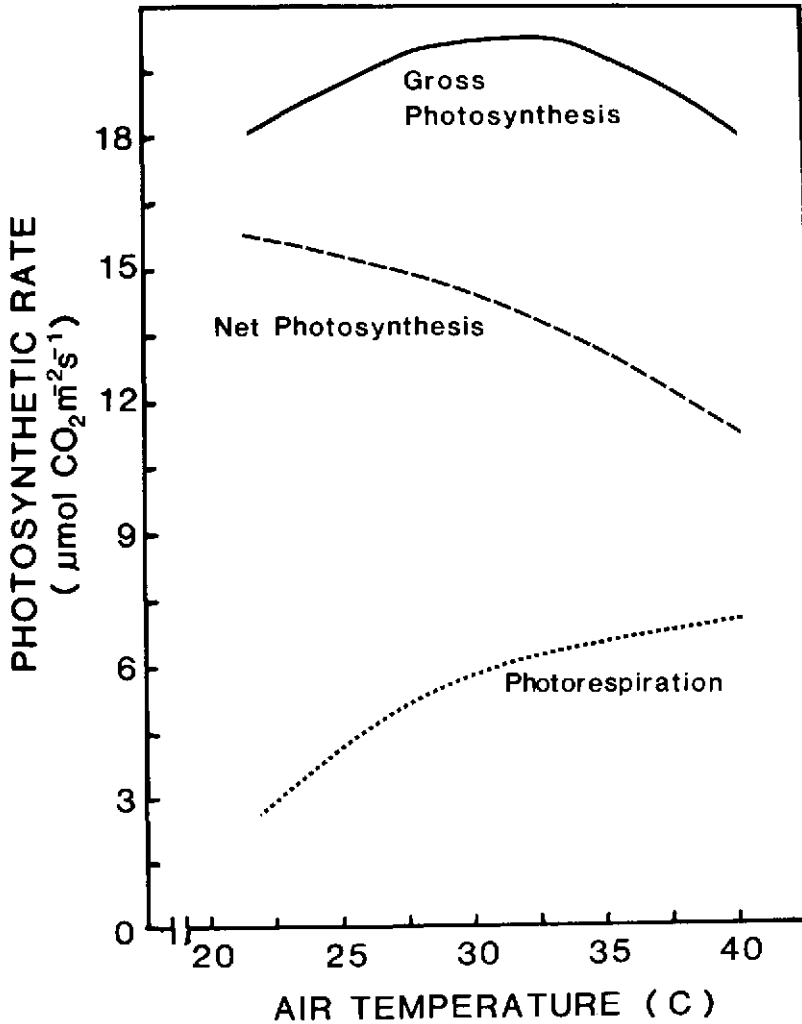

Figure 3. Photosynthetic responses of individual cotton leaves to increasing air temperature.

that essentially all of the difference between gross and net photosynthesis can be attributed to photorespiratory  $\text{CO}_2$  evolution. Dark respiration rates of 2-3  $\text{mg CO}_2$  evolved  $\text{dm}^{-2} \text{hr}^{-1}$  were measured on fully expanded leaves. The current opinion is that glycolytic and Krebs cycle activity are greatly reduced in the light due to the cytoplasmic energy charge and due to the high concentration of phosphorylated sugars favoring sucrose synthesis and inhibiting dark respiration.



CO<sub>2</sub> compensation concentrations increase with temperature, also reflecting the increased photorespiratory activity (Bykov *et al.*, 1981). This reduced the CO<sub>2</sub> concentration gradient and, thus, the rate of diffusion of CO<sub>2</sub> to the chloroplast. If stomatal or mesophyll resistance are simultaneously increased due to starch accumulations, net photosynthesis would be severely reduced. Nofziger and Koller (1976) indicated that at a given temperature, the CO<sub>2</sub> compensation point was not altered and attributed the reduction in net photosynthesis to increased mesophyll resistance. Based on the current evidence this response is as expected.

Zelitch (1979) proposed that certain metabolites such as L-glutamate, L-aspartate, phosphoenolpyruvate and glyoxylate are effective inhibitors of photorespiration. He suggested that alterations in the pool sizes of certain common metabolites can increase photosynthesis by inhibiting glycolate synthesis and thus photorespiration, probably by a feedback mechanism. Chemical or genetic regulation of some commonly occurring metabolites could possibly produce plants with higher rates of net photosynthesis through effects on photorespiratory inhibition, although the worth of this response remains to be demonstrated.

Only two other enzymes of the PCR pathway are subject to metabolic control and, thus, possible regulators of the rate of carbon flow through the cycle (Portis *et al.*, 1977). These are fructose 1-6 biphosphatase (FBPase) and sedoheptulose 1-7 biphosphatase (SBPase). These two enzymes hydrolyze the respective biphosphates at the C-1 position to yield an inorganic phosphate and fructose-6-P or sedoheptulose-7-P, respectively. FBPase has been studied most intensively. It has an alkaline pH optimum (8.5), is largely inactive below 7.8, and is highly dependent on Mg<sup>2+</sup>. The enzyme is activated by light largely due to pH and Mg<sup>2+</sup> changes in the stroma favoring activity. The activity of FBPase increases in a sigmoidal manner with increased FBP concentrations. One possible mechanism of control by this enzyme involves the sigmoidal dependence of FBPase activity on FBP concentrations. If the glyceraldehyde-3-P concentration were to decline due to export from the chloroplast, then the chloroplast levels of DHAP and FBP would also decline and affect FBPase activity. SBPase responds similarly to effectors and metabolite concentrations. An interesting side note is that at a pH of 8.8, FBPase dissociates into two halves which retain catalytic activity and are reported to acquire SBPase activity (Buchanan and Sherman, 1973). It remains to be clarified whether the SBPase of the PCR cycle is a specific SBPase or a dissociated FBPase. The correlation between FBPase activity and rates of CO<sub>2</sub> fixation with intact chloroplasts is close (Portis *et al.*, 1977), but whether FBPase or SBPase is rate-limiting the CO<sub>2</sub> fixation is still a valid question.

The triose phosphates produced by the PCR cycle can either be exported from the chloroplast and produce sucrose for export in the cytoplasm, or they can be converted to hexose phosphates in the chloroplast and stored as starch. Why would starch accumulate in the chloroplast, if it is inhibitory to photosynthesis through increased mesophyll resistance? Why aren't the triose phosphates exported to minimize starch accumulation and possible damage to the chloroplasts?

We now recognize that co-transport occurs in moving assimilate from the chloroplast to the cytoplasm (Bassham, 1979). An inorganic phosphorus (Pi) must be imported for each triose-P exported from the chloroplast. Therefore, if the translocator were not able to function as rapidly as triose phosphates were being produced, fixed carbon would be diverted to starch synthesis inside the chloroplast. The rate of translocation across the chloroplast membrane may be limited by translocator activity or due to inadequate pool size of Pi in the cytoplasm. The unavailability of Pi in the cytoplasm may result from sequestering by soluble sugars or by reduced sucrose synthesis. Starch synthesis is stimulated by low concentrations of Pi in the chloroplast and by increased concentrations of 3-PGA.

## STRESS EFFECTS ON PHOTOSYNTHESIS

The photosynthetic process is subject to control by both environmental and genetic factors. Complex control mechanisms (largely undefined) probably evolved to enable the plant to maintain a high degree of homeostasis when environmental conditions change or the demand from processes within the plant change. Lack of adequate supplies of soil water or excessive atmospheric demand for water frequently result in plant water deficits which constitute a growth-limiting stress to the cotton plant under field conditions. Usually accompanying the water stress is a high temperature stress which further confounds the plant response, especially the photosynthetic rate response. Several excellent books have addressed the developmental and physiological responses of plants to environmental stresses of water and temperature (Mussells and Staples, 1979; Turner and Kramer, 1980). Likewise, the photosynthetic process and the response to water and temperature stresses have been the subject of several recent reviews (Boyer, 1976a,b; Krieg, 1983 a,b). The water relations of the cotton plant and the response of select developmental and physiological processes to water deficits have been reviewed by Jordan (1983).

This effort is directed toward defining the possible control of the photosynthetic process in cotton due to end-product inhibition or the accumulation of assimilates. In order to accomplish this task one must be able to define and differentiate the responses of the source leaves, the translocation system and the various sinks to a range of stress intensities. No comprehensive experiments of this nature have been reported by my knowledge. Based upon the existing evidence, I will present my concept of the source-sink relations of the cotton plant and the possible control of photosynthetic rates by feedback inhibition.

As previously described the photosynthetic process consists of three major components, namely the photochemical process of energy conversion, the physical processes of diffusion controlling transfer of CO<sub>2</sub> from the external environment to the site of carboxylation, and lastly the biochemical process responsible for CO<sub>2</sub> reduction to CH<sub>2</sub>O and its subsequent disposition. Environmental stresses can directly affect the photosynthetic rate or they can indirectly affect the assimila-

tion process by directly affecting the sinks ability to process the assimilate, thus creating the possibility of feedback inhibition.

### DIRECT EFFECTS OF STRESS

Water stress was reported to directly affect the photochemical activity of isolated cotton chloroplasts (Fry, 1970, 1972). Hill reaction activity, as measured by ferricyanide reduction, was reduced approximately 2 percent per bar decline in osmotic potential of the bathing medium. This rate of reduction was fairly consistent using chloroplasts from cotton tissue subjected to stress in a number of different ways.

The literature is replete with examples of water stress inducing stomatal closure and thus greatly reducing gas exchange (Bielorai and Hopmans, 1975; Brown *et al.*, 1975; Davis, 1977; El Sharkawy and Hesketh, 1964; McMichael 1980; Troughton, 1969). Stomatal control is a function of guard cell water relations, and as stress increases and leaf water potential ( $\psi_L$ ) declines, the stomata begin to close. A linear correlation between stomatal conductance and photosynthetic rate has been reported for cotton between leaf water vapor conductance values of 0.1 and 0.7  $\text{cm s}^{-1}$  (McMichael, 1980). However, leaf conductances of field-grown cotton are often greatly in excess of 1.0  $\text{cm s}^{-1}$ , and values in excess of 2.0  $\text{cm s}^{-1}$  are not uncommon (Ackerson and Herbert, 1981; Ackerson and Krieg, 1977; Cutler *et al.*, 1977; Hutmacher and Krieg, 1981, 1983). Additionally, the stomatal response to declining leaf water potential is considerably different in field-grown cotton as compared with plants grown in controlled environment chambers (Ackerson and Herbert, 1981; Bielorai and Hopmans, 1975; Brown *et al.*, 1976; Davis, 1977; Troughton, 1969). Under field conditions, we observed the photosynthetic rate to be slightly more sensitive to decreasing leaf water potential than the stomatal conductance response (Figure 4). The leaf water potential at which reductions begin to occur is altered by leaf age and stress history. Older leaves and leaves developing under the influence of soil water deficits required lower leaf water potentials to initiate the inhibition. Numerous reports in the literature suggest nonstomatal control of photosynthesis, even though stomatal changes are evident as leaf water potential declines (Ackerson *et al.*, 1977; Hutmacher and Krieg, 1983; Karami *et al.*, 1980; Krieg, 1983, Sung and Krieg, 1979).

Troughton (1969) indicated that the mesophyll resistance to  $\text{CO}_2$  transport became a major factor when the relative water content (RWC) of the leaf declined below 75 percent. In field-grown cotton the leaf water potential-relative water content relationships during dehydration indicate that at a  $\psi_L$  of -20 bars the RWC would be approximately 75 percent (Cutler and Rains, 1978; Cutler *et al.*, 1977a). Whether the increased mesophyll resistance is due to increased starch concentrations is not know at this time. However, under stress conditions, the leaf tissue normally has less starch than the non-stressed leaves (Eaton, 1955; Eaton and Ergle, 1948; Tollervey, 1970).

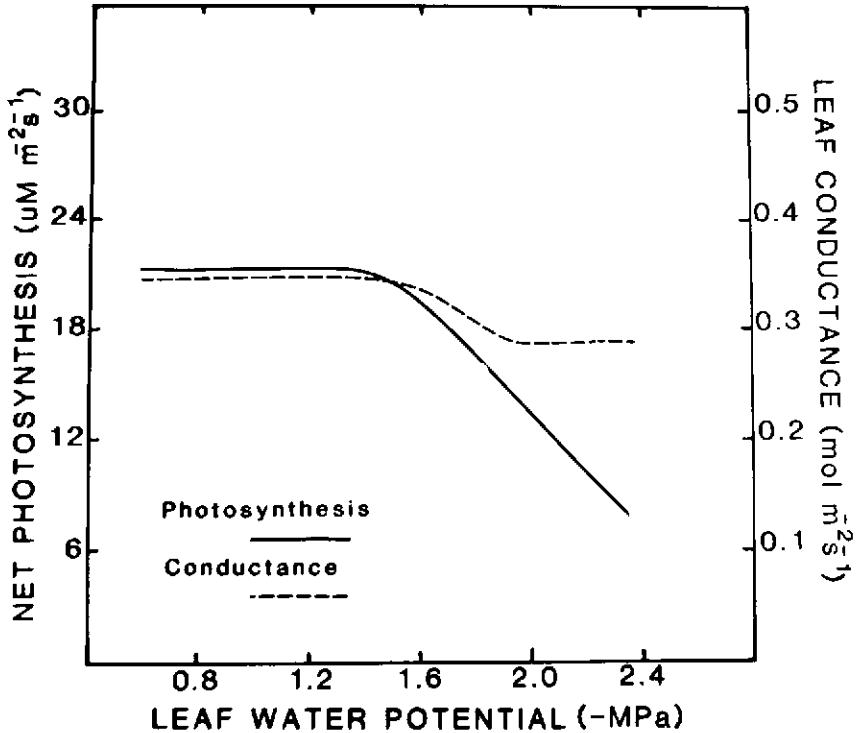

Figure 4. The influence of leaf water potential on photosynthetic rate and leaf conductance of water vapor for individual cotton leaves.

Direct effects of low water potential on carboxylation enzyme activity are not known at present. However, enzyme activities are determined *in vitro* in artificial environments. It is extremely difficult to determine the microenvironmental changes in the chloroplast as a result of low water potential and how these changes affect enzyme activity. Total RuBP carboxylase/oxygenase activity is subject to control by both biophysical and biochemical factors, and much remains to be done in defining the relative changes in these factors as stress progresses. Techniques are needed which will accurately reflect the "active" enzyme concentration in relation to "total" enzyme concentration.

The relative activity of RuBP carboxylase/oxygenase controls the rate of carboxylation versus oxygenation of RuBP and thus determines net photosynthesis. Our data indicate that the ratio of carboxylation to oxygenation is unaffected by increasing water stress to leaf water potentials of -24 bars (Perry and Krieg, 1983). Both gross and net photosynthesis begin to be affected as  $\psi_L$  declined from -20 bars (Figure 5). The constant ratio of gross photosynthesis to photorespiration in cotton implies stress effects on total enzyme activity. Previous reports of water

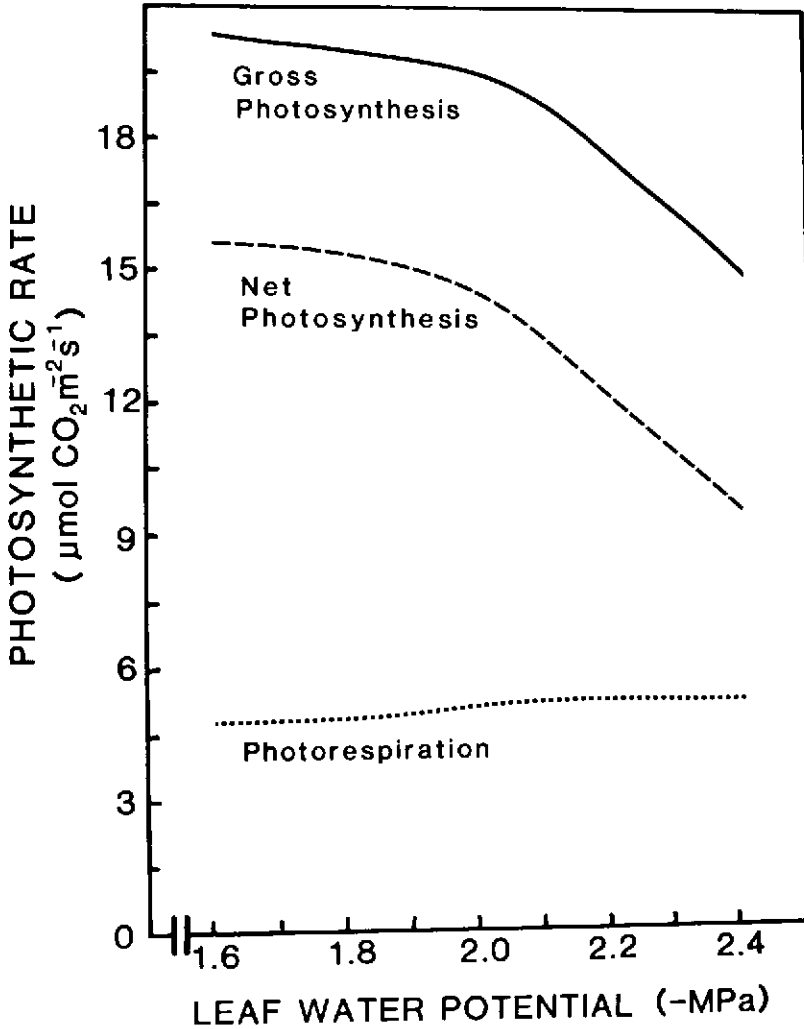

Figure 5. The influence of leaf water potential on photosynthesis-photorespiration rate responses of individual cotton leaves.

stress increasing photorespiratory activity of  $C_3$  plants may be confounded by the effects of temperature changes coincident with the leaf water potential.

The ratio of gross photosynthesis to net photosynthesis is very temperature-sensitive. Gross photosynthesis of cotton had a temperature optimum of 32 to 33C; whereas, net photosynthesis declined almost linearly from 25C to 37C (Perry and Krieger, 1983). Photorespiration represented approximately 50 percent of net photosynthesis at 35C and occurred at a rate of 11 to 12  $\text{mg CO}_2 \text{dm}^{-2} \text{hr}^{-1}$ .

Using 2 percent O<sub>2</sub> to essentially eliminate photorespiration, the difference between gross and net photosynthesis disappeared; thus the light-derived CO<sub>2</sub> evolution was from photorespiration. Temperature has a profound influence on gas solubility in aqueous solutions with CO<sub>2</sub> solubility reduced to a greater extent than O<sub>2</sub> solubility with increasing temperature (Tenhunen *et al.*, 1979). The CO<sub>2</sub> compensation point also increases linearly with temperature, reflecting increased photorespiratory activity (Bykov *et al.*, 1981). The increased CO<sub>2</sub> compensation point was a reflection of reduced total enzyme activity rather than a differential effect on carboxylase or oxygenase as evidenced by the response with different O<sub>2</sub> concentrations.

Cotton chloroplasts accumulate a rather large volume of starch during the course of the day which is attributed to carbon assimilation exceeding transport capacity (Eaton, 1955; Eaton and Ergle, 1948; Mason and Maskell, 1928a). Starch synthesis is involved in reducing the osmotica in the chloroplast and maintaining a more favorable water status (Ackerson, 1981). Cotton also contains a number of intrachloroplastic bodies that appear to be lipid (Berlin *et al.*, 1981a). The number and total volume of the intrachloroplastic granules increase under high light conditions, under water stress conditions and with increasing leaf age. At present, no reason for their occurrence is known; however, one possibility is discussed below.

Osmond *et al.* (1980) hypothesized that photorespiration in C<sub>3</sub> plants provides a means to dissipate excess biochemical energy when CO<sub>2</sub> reduction is impaired due to stomatal closure. In many temperate C<sub>3</sub> plants, such as soybean, photorespiration represents about 50 percent of net photosynthesis at temperatures as low as 25C (Laing *et al.*, 1974) In cotton, photorespiration is minimal at 25C but increases with temperature, representing about 50 percent of net photosynthesis at 35C (Perry and Krieg, 1983). If mesophyll resistance is increased due to starch accumulation or to declining tissue water content, the CO<sub>2</sub> concentration at the carboxylation site would be low and not capable of utilizing all the biochemical energy provided, unless the photochemical reactions were affected as suggested by Fry (1970, 1972). However, if lipids were synthesized rather than starch, mesophyll resistance changes would be minimized and excess energy could be dissipated in further reduction of the carbon compared with that in carbohydrate. A major problem in this scheme is that CO<sub>2</sub> is a catalyst for malonyl CoA synthesis from acetyl CoA in the initiation of fatty acid synthesis (Stumpf, 1976). As previously stated, this hypothesis is proposed as a means of dissipating excess biochemical energy when CO<sub>2</sub> reduction can't utilize the available supply. Therefore, circumvention of this basic prerequisite for CO<sub>2</sub> in malonyl CoA synthesis must occur. Shannon and others (deVillis *et al.*, 1963; Shannon *et al.*, 1963) indicated that the following reaction occurs in plant tissue:

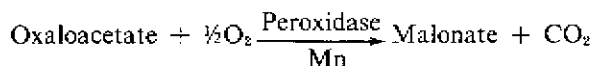

The malonic acid can form malonyl CoA by using ATP and CoASH, bypassing the need for CO<sub>2</sub> catalysis. Cutler *et al.* (1977a) indicated that malate concentrations increase by 60 percent during the course of the daylight hours, and the concentration is higher in water stressed tissue than in non-stressed tissue. These results support the idea that the substrate for production of malonic acid is present in rather significant quantities.

The production of lipid as compared with starch represents the use of one additional ATP and NADPH for each carbon stored. I suggest that the cotton plant might employ lipid synthesis in the chloroplast to minimize photoinhibition of the light harvesting apparatus due to undissipated biochemical energy and to maximize carbon conservation by minimizing photorespiration. This mechanism implies that changes in the microenvironment of the chloroplast enhance lipid synthesis and minimize starch synthesis. These changes would apparently be influenced by temperature or tissue water potential.

One must immediately ask "why would the chloroplast store starch (or lipid) rather than export the assimilate initially? Is the sucrose synthesis process rate-limiting? Or is the sink(s) activity, and thus the ability to process the assimilate, rate-limiting?" Based upon currently available information, one is led to the conclusion that the growth processes are more sensitive to environmental constraints such as water and high temperature stress and, therefore, are unable to process the assimilate into growth products as rapidly as they can be produced (see Chapters 7 and 10). Leaf expansion in cotton occurs at a greater rate in the dark than in the light (Bunce, 1977a; Krieg, 1981; Yimbo, 1980). This growth response is often attributed to inadequate turgor pressure in the expanding leaf during the day due to reduced leaf water potential. Simultaneously, growth rates of cotton fruit appear to be limited by internal processes rather than assimilate supply (Anderson and Kerr, 1943; Kirk and Krieg, 1981; Krieg and Sung, 1979; McArthur *et al.*, 1975). Boll growth rates have an optimum mean daily temperature of 27C and decline rapidly as the mean temperature increases (McArthur *et al.*, 1975). In much of the cotton-growing regions, the mean daily temperature is at least 27C during the boll development phase and in the semi-arid southwestern U.S. normally exceeds the optimum by several degrees. At present we do not know which assimilatory processes result in reduced boll growth rates when affected by temperature.

If assimilate demand is reduced by stress having a direct effect on the sink rather than the source, then photosynthate could accumulate and possibly inhibit its subsequent synthesis. Recent evidence indicates that cotton plants subjected to several cycles of mild water stress sufficient to reduce growth do have considerably greater leaf starch concentrations (Ackerson, 1981; Ackerson and Herbert, 1981). At high water potentials, the photosynthetic rates of the stress-adapted plants were lower than the nonadapted plants. The reduced photosynthetic rates could not be attributed to stomatal conductance differences, thus nonstomatal inhibitions are indicated. After 48 hours in the dark, the starch was depleted and

the plants were "de-adapted." Subsequent physiological responses of the de-adapted plants were identical to the control plants. These data suggest that starch accumulates under mild stress conditions due to sink activity being reduced more than source activity in the short term. Prolonged stress should result in a more steady-state condition where production is in accord with demand. Another interesting aspect of these studies on drought adaptation was the apparent absence of lipid-like bodies in the chloroplast and extremely large starch granules. The photosynthetically active radiation level was  $800 \mu\text{E m}^{-2} \text{sec}^{-1}$ . Under high light conditions, less starch and more intrachloroplastic lipid-like bodies were observed (Berlin *et al.*, 1981). This observation again supports the contention that lipid synthesis is a means of dissipating excess photochemical energy and simultaneously minimizing the need for photorespiration.

## SUMMARY

Crop growth represents a highly coordinated and integrated set of systems involved in assimilation of  $\text{CO}_2$ ,  $\text{H}_2\text{O}$  and minerals from the environment and their reduction and use in various growth processes which result in biomass. The primary assimilatory tissue is separated from the major centers of growth, so a translocation system is necessary. Both the source of assimilates and the sinks where assimilates are utilized are subject to genetic and environmental controls as to rate of activity. There is a high probability that the assimilation capacity exceeds the system's ability to process the assimilate in most green plants. This statement must be qualified with respect to species, growth stage and environmental conditions during plant development. The mechanisms responsible for regulating source-sink activities, or supply and demand, are many and can involve both biophysical and biochemical components. The controls imposed can be directly on the assimilatory process, or they may be indirect such as through some type of feedback inhibition.

The mechanisms involved in control of photosynthetic activity through feedback inhibition continues to escape thorough definition. Although one can artificially create conditions whereby large starch accumulations exist and restrict  $\text{CO}_2$  diffusion rates, the question of the significance of this type of inhibition under natural environmental conditions is still debatable.

Although sound experimental evidence is rare, I am of the opinion that the primary regulator of  $\text{CO}_2$  reduction resides in RuBP carboxylase activity. The activity of this enzyme is subject to numerous controls including inorganic and organic effectors. The active enzyme exists as a complex of eight large subunits and eight small units in the appropriate three-dimensional structure. Association and dissociation are a function of the chemical environment and the order of addition of activators. The complexity of this enzyme and its function in carboxylation and oxygenation make it the logical candidate for regulation of the rate of carbon reduction in green leaves. Techniques to measure "active" enzyme con-



centrations and microenvironmental conditions in the chloroplast stroma are rapidly evolving (Jensen and Bahr, 1977; Lorimar *et al.*, 1977; Sicher *et al.*, 1981) and should provide insight into regulation of RuBPC:Oase in the near future.

With respect to source or sink limitations in the cotton plant, my current opinion is that most commercially adapted cotton varieties are sink limited during the first half or more of the growing season. During the latter stages of development, during rapid boll filling, the plant probably becomes source limited. Source limitations during this stage are much more apparent if the plant experienced water stress which reduced leaf area more than fruit load. Complications due to nitrogen deficiencies, hormonal changes and other factors are apparent and greatly confuse the cause-and-effect interpretations.

It is imperative that we develop a thorough understanding of the major physiological limitations to cotton growth, development and productivity, and the control of the limiting systems. Efforts to define the physiological limitations to cotton productivity are underway at numerous locations throughout the cotton growing regions of the worlds. Through cooperative efforts and well-designed experimentation, good progress can be made toward this goal of minimizing the rate-limiting processes and maximizing productivity.

### ACKNOWLEDGEMENTS

Our research was supported by the USDA through both the Competitive Research Grants Program and cooperative agreements and from the State of Texas through Texas Tech University and the Texas Agricultural Experiment Station.

## Chapter 19

# A CONCEPTUAL MODEL OF STRESS EFFECTS

Donald N. Baker and Basil Acock  
USDA-ARS,  
Mississippi State, Mississippi

## INTRODUCTION

Optimum crop management requires an appropriate working definition of the term "stress." There are several kinds of stress, all of which affect yield by reducing the size and/or number of fruit produced. These stresses affect various physiological processes in different ways. A conceptual model relating plant processes to the external environment and to the various stress effects is presented here.

In most crops, including cotton, the number of plants per unit ground area, fruit size and the number of fruit per plant are the components of yield (Brevedan, *et al.*, 1978). In many species there are relatively narrow genetic limitations on fruit size. The maximum size often (as in the case of small grains and legumes) depends on the physical space available within the hull, and the minimum size is determined by seed viability considerations. On the other hand, plants generally initiate two to three times as many fruit as they can support. The remainder are aborted as a result of physiological stress. Thus, the number of fruit per plant is by far the most variable yield component.

Krizek (Chapter 17) notes that high photosynthetic rates alone may not be the crucial factor in determining yield. He cites several studies showing that the relationship between photosynthetic rate and yield depends on the developmental stage during which high photosynthesis occurs. In most cases increased yield is associated with enhanced photosynthesis during fruiting. Peet *et al.* (1977) found that photosynthetic rates at pod set in dry beans were positively correlated with yield in eight of nine varieties, but they found one variety in which high seed yield was associated with a very low photosynthetic rate. This variety happened to have a high harvest index. Evans (1975), in a careful consideration of carbon dioxide and other experimental variables, commented that there is little evidence of any positive relation between photosynthetic rate and yield, nor any instance where (cultivar) selection for a greater rate of photosynthesis has led to increase in yield. Any increase in photosynthate production must be accompanied by an adequate sink capacity, if it is to be beneficial. This may not always occur since plants have

very sensitive mechanisms to abort fruit in response to short term deficits of photosynthate. This chapter examines the connection between physiological stress and fruit numbers. The rates of morphogenesis and the abortion of fruiting structures in cotton plants can be simulated as responses to imbalances in the metabolite supply:demand ratio (Baker *et al.*, 1973, 1976, 1979b). Baker *et al.* (1972), Boyer (1970) and many others showed that potential organ growth (and thus metabolite demand level) depend on temperature and plant turgor. Here, we consider two classes of metabolites: carbohydrates, derived from photosynthesis; and nitrogenous compounds, with nitrogen supply depending largely on the entrainment of nitrogen in the transpiration stream. During fruiting, there is usually a source/sink imbalance, and actual growth can be simulated (Baker *et al.*, 1979a) on the basis of the supply/demand ratio.

Most of the CO<sub>2</sub> fixed in photosynthesis and the water lost in transpiration pass through the stomata. Several climatic variables and metabolic inhibitors have direct and indirect effects on stomatal aperture and on the exchange rates of these gases between the plant and the surrounding atmosphere. Light intensity greatly modifies transpiration through its effects on stomatal opening (Kramer, 1959; Baker, 1966; Pallas *et al.*, 1962). Zelitch (1965) lists the following factors controlling stomatal behavior: light, temperature, atmospheric CO<sub>2</sub> concentration, leaf water status and a number of metabolic inhibitors. Meidner and Mansfield (1965) confirm this list, and in an effort to develop a theory of stomatal action, they cite literature showing that both temperature and water stress produce closing responses which are causally related to the internal CO<sub>2</sub> concentration of the leaf. They also suggest that metabolic inhibitors cause stomatal closure by modifying the internal CO<sub>2</sub> concentration, either by their effect on respiration or on photosynthesis, or both. However, they also show that temperature and leaf water potential have direct effects on the guard cells independent of their effects on internal CO<sub>2</sub> concentration. The work of Fisher (1970) suggests a mesophyll effect in the recovery of stomatal action after water stress, attributable to substomatal CO<sub>2</sub> concentration. Lange *et al.* (1971) and Cowan (1977) report a direct effect of humidity on stomatal action.

We have summarized these findings to provide a background for considering the effects (direct and indirect) of environmental factors on physiological stress.

Baker *et al.* (1973), in an analysis of the relationship of photosynthetic efficiency and yield in cotton, were able to simulate the delays in plant development induced by metabolic stress. These delays were shown to cause the common sigmoid developmental pattern. They were also able to simulate the fruit abortion pattern of the crop. The variable used in indexing these morphogenetic delays and the fruit abscission rates was the ratio of carbohydrate supply to demand. This was, as far as we know, the first suggestion in the literature that both carbohydrate sink strength and carbohydrate supply levels are jointly involved in determining the growth and fruiting patterns of the plant. Although this model did not attempt to state explicitly the nature of the connection(s) between the metabolic

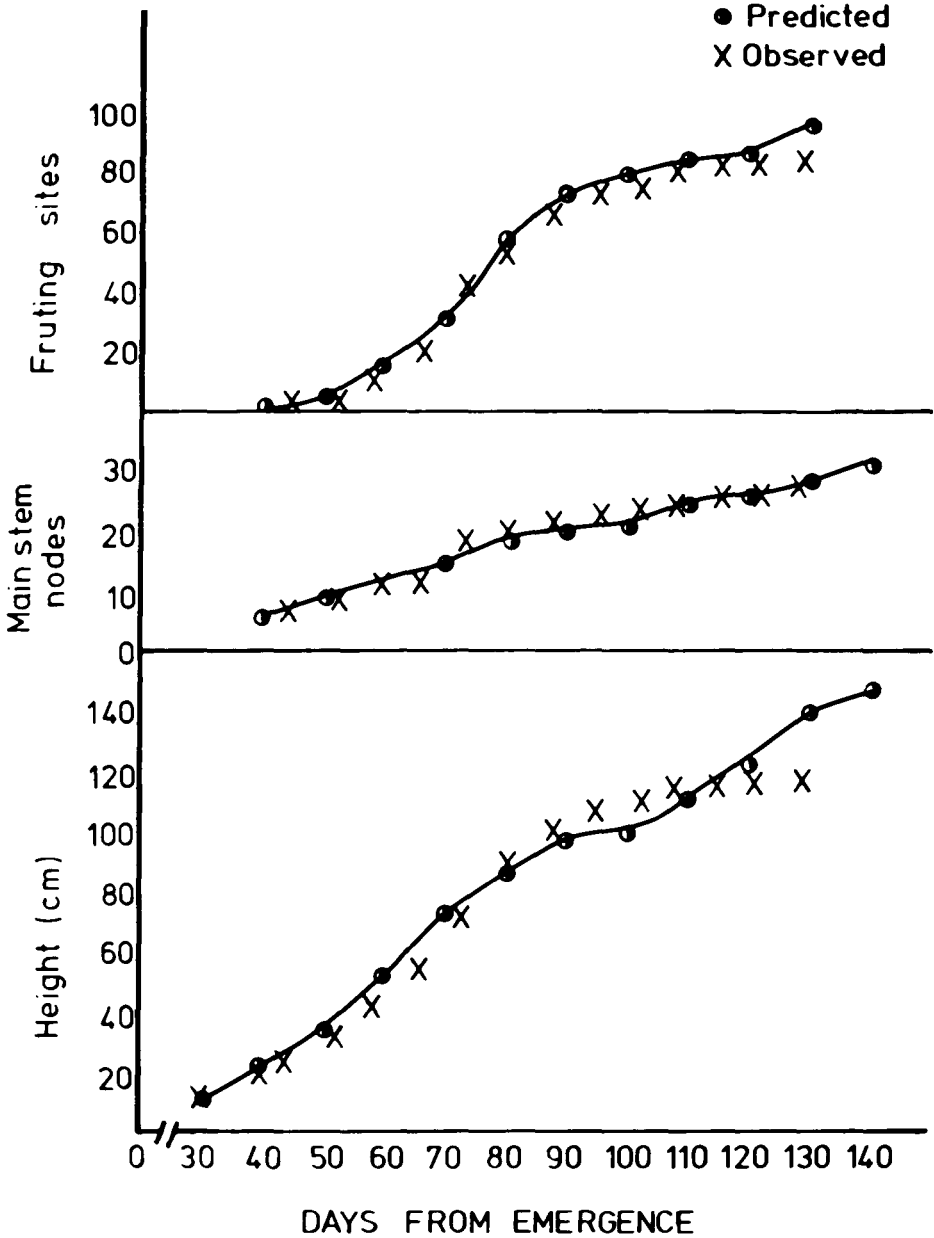

Figure 1. Field observations and model predictions of the seasonal time course of vegetative development in cotton.

pathways and the hormone systems within the plant, it did make the assumption that such connections exist and that they determine the balances of hormones in the plant. This concept was incorporated in a more advanced cotton simulation model, GOSSYM, (Baker *et al.*, 1976) along with a greatly improved data base for the physiological process rate equations (Baker *et al.*, 1972; Moraghan *et al.*, 1968; Hesketh *et al.*, 1972), as well as a detailed rhizosphere simulator, RHIZOS (Lambert and Baker, 1984). GOSSYM also has the capability to mimic the physiological effects of water stress and nitrogen stress in cotton. An example comparison of GOSSYM predictions and the field observations of fruiting sites, mainstem node numbers and plant height from Bruce and Römken (1965) are presented in Figure 1. Similar comparisons for numbers of unpollinated flower buds (squares) and bolls are presented in Figure 2. The data in Figure 1 show the simulation of the sigmoid developmental curve of the crop. The data in Figure 2 depict the abortion of fruit.

Cotton is an indeterminate woody perennial. Typically, after fruiting begins, as each mainstem node is formed a fruiting branch begins development (see Chapter 2). At each node of the fruiting branch is a leaf in whose axil a fruit is initiated. This simple developmental pattern makes cotton an ideal subject for the identification of the time courses of stress effects. When measured as the number of mainstem nodes (Figure 1), plant development was simply a function of temperature out to about day 72 when the first boll appeared. The carbohydrate shortages began to develop, and the rate of new mainstem node formation was reduced. Fruiting site formation was exponential up to that time because, while temperature remained more or less constant, the number of fruiting branches increased as mainstem nodes were added. After first bloom, however, fruiting site formation became linear and then leveled off as the boll load became large. The number of flower buds (squares) increased as sites were formed until first bloom and then abortion began. Squares and young bolls were aborted in response to carbohydrate stress. In this way the time courses of fruit initiation and abscission are both determined by carbohydrate stress. GOSSYM contains similar logic in which a nitrogen source:sink imbalance also results in morphogenetic delays and fruit abscission.

The model calculates these effects of source:sink imbalance by performing the following operations daily: (a) photosynthesis, respiration, nitrogen uptake and reserves are calculated to estimate carbohydrate and nitrogen supplies; (b) the potential dry matter growth of all the organs is estimated from the age of the organs, temperature and turgor levels; (c) the product of the carbohydrate and nitrogen supply:demand ratios (with the variable name FSTRES) is calculated; (d) delays in the formation of new mainstem and fruiting branch nodes are calculated as functions of FSTRES; (e) the time of formation of each new node is calculated from temperature with these delays added; (f) the number of fruit per plant to be aborted each day (FLOSS) is calculated from FSTRES.

The delay functions (in days) are presented in Figure 3. Delays in mainstem

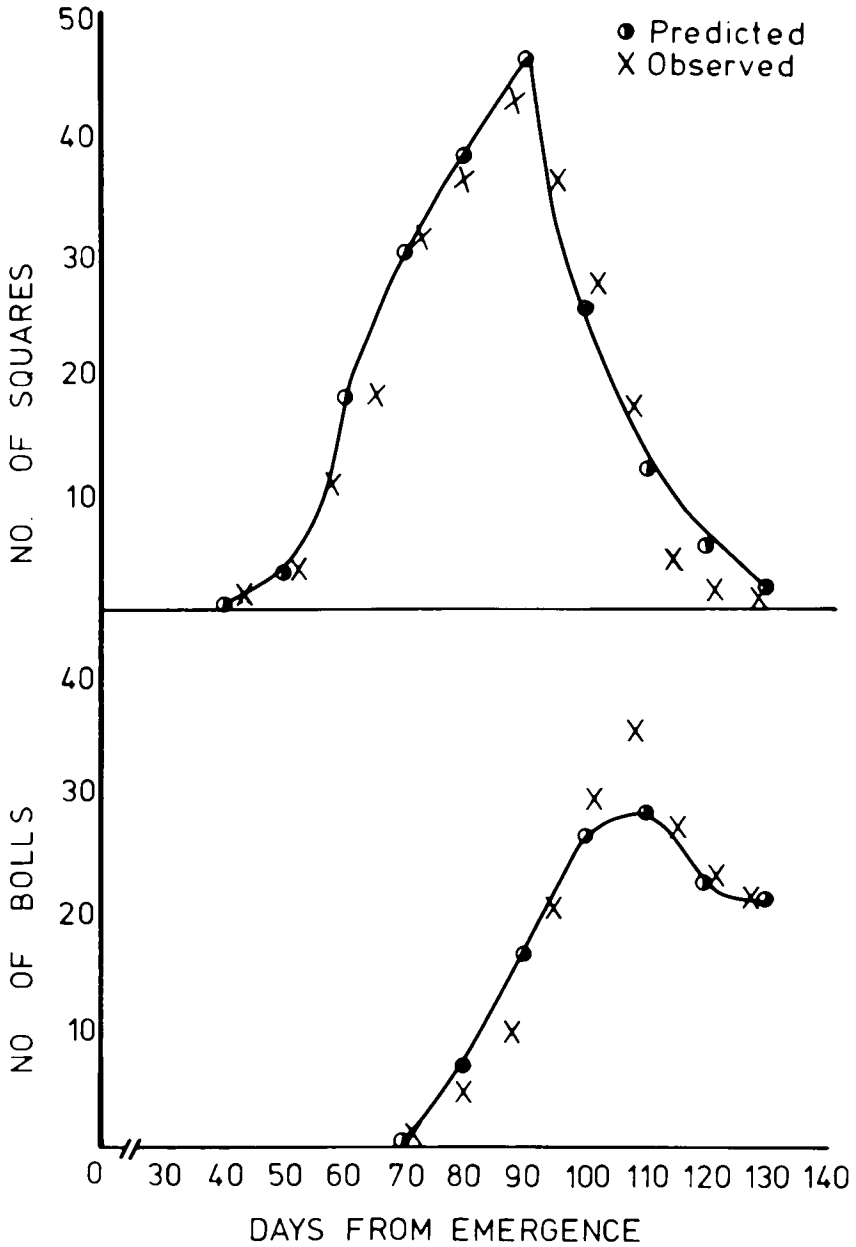

Figure 2. Field observations and model predictions of the seasonal time course of fruiting in cotton.

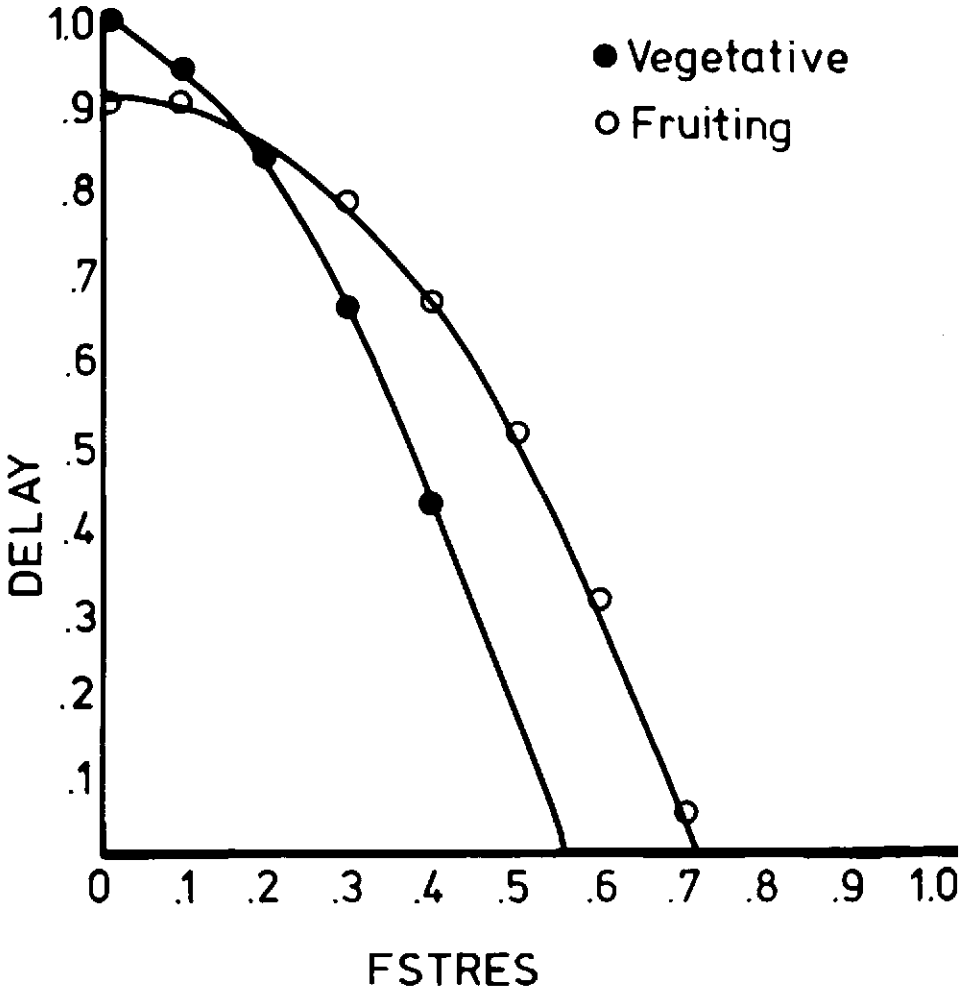

Figure 3. Morphogenetic delay functions (in days) in the cotton simulation model GOSSYM.

node formation only seem to occur under severe carbohydrate stress, and then they build rapidly. Delays in fruiting branch formation are noticeable when the metabolite supply:demand ratio is about 0.7. The fruit loss function (FLOSS) is graphed in Figure 4. This relationship provides the numbers of fruit per plant marked for abortion each day.

The GOSSYM model has now been validated with over 50 data sets from Israel, covering a wide range of climatic conditions and management practices, and with several data sets from Mississippi and Arizona (Marani and Baker,

1981; Reddy, 1981). The success of this model, using the carbohydrate supply:demand ratio to calculate developmental delays and "natural" fruit abscission, over the time course of crop growth under such a wide range of conditions, has reinforced our conviction that both the carbohydrate sink strength and the concentration of soluble carbohydrates in the system are involved in the determination of the plant's hormone balances and its decisions to delay morphogenesis and abort fruit. However, the biochemistry of this decision-making process is not clear in the literature, nor is it clear how the effects of drought and nitrogen shortage operate on growth, morphogenesis and fruit abscission (see Chapter 10). The GOSSYM model handles these effects, but probably with some unnecessary empiricism and redundancy. We know that research is needed to characterize the relative changes in photosynthesis and nitrogen uptake along with potential and actual organ growth and changes in hormone concentrations in various tissues under water stress. We are finding that comparable mechanisms explain tillering, fruiting and fruit abortion in wheat and fruiting and fruit abortion in soybean. We believe that we are approaching the point where we can advance an hypothesis about these interactions.

Numbers in the following discussion refer to the line numbers in Figure 5. Virtually all of the linkages presented here can be documented in the literature.

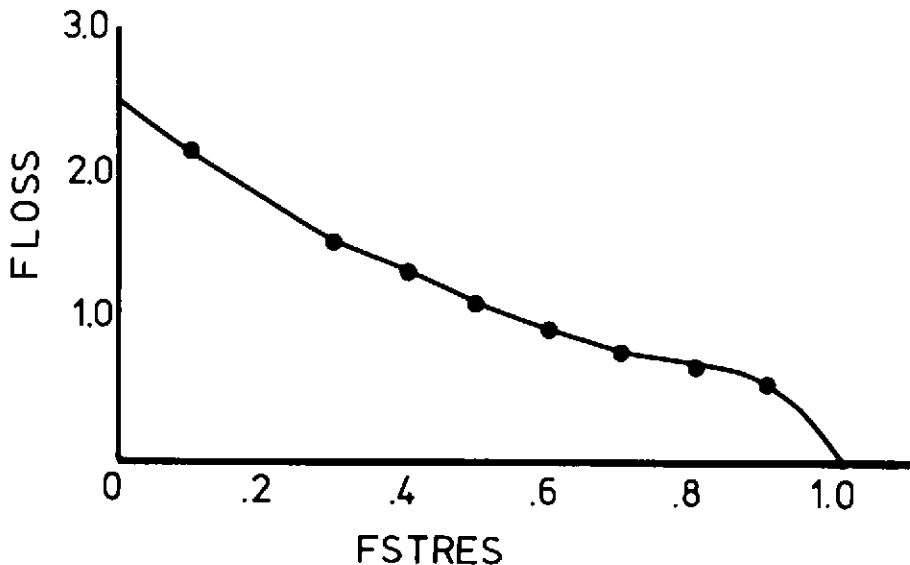

Figure 4. The fruit abortion function (fruit per plant) in the cotton simulation model GOSSYM.



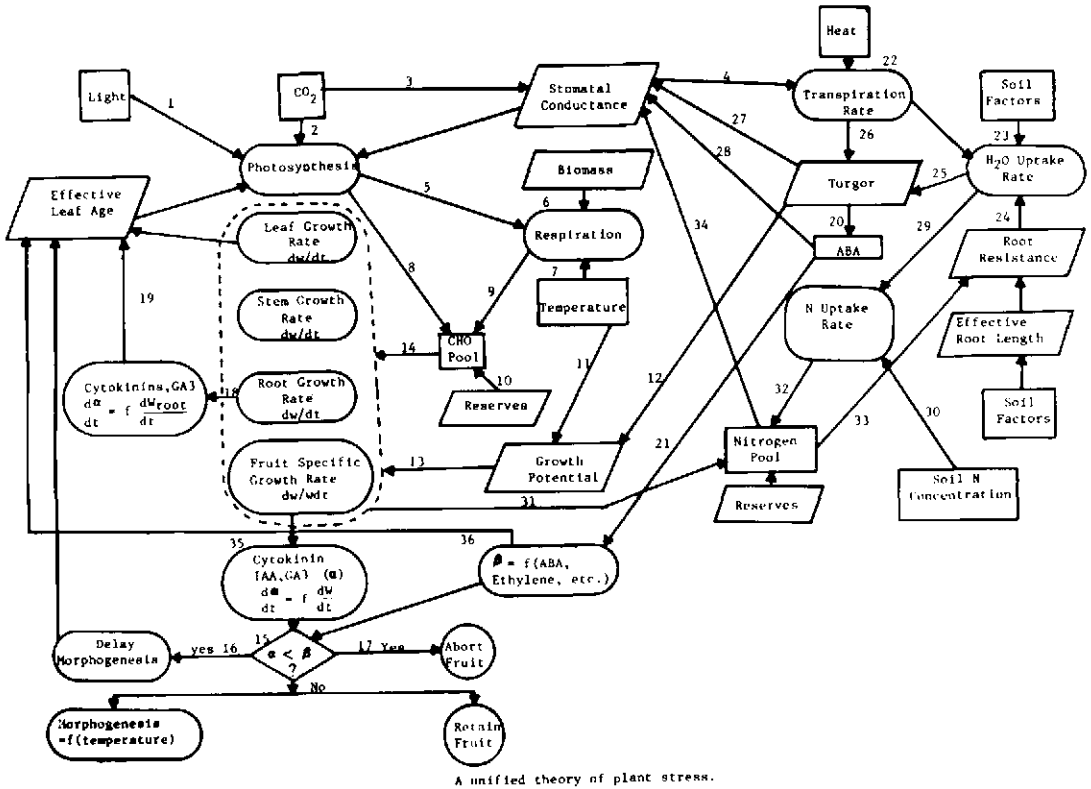

Figure 5. The major elements of a unified theory of plant stress.

### CARBOHYDRATE STRESS

Light intensity 1 and atmospheric CO<sub>2</sub> concentration 2 drive the photosynthetic process, with the latter directly affecting the CO<sub>2</sub> concentration gradient and the flux rate into the leaf. Also, CO<sub>2</sub> indirectly affects the flux rate by its effect on stomatal aperture 3. This latter effect also determines the transpiration rate 4. We might note here that other factors, including light, intensity and temperature also affect stomatal apertures.

Photosynthetic rate (in C<sub>2</sub> species) 5, biomass 6 and temperature 7 determine the respiration rate. The pool of carbohydrates available for growth depends on photosynthesis 8, respiration 9 and the quantity of labile carbohydrates held in reserves 10. Temperature 11 and tissue turgor 12 determine the potential dry matter accretion rate (sink strength) in a particular organ. Actual organ growth rate depends on the sink strength of the organ 13 and the supply of carbohydrates 14.

Several excellent reviews of hormone physiology have been written recently. Here we rely extensively on Moore (1979), Cognée (1976) and Guinn (Chapter 12). Much of the material concerns organ abortion in cotton. Also, much is known about the sources of hormones and the nature of their effects in plants. Osborne (1974) states that there are five specific compounds or classes of compounds in plants which act as "effector" substances regulating metabolic processes. These are abscisic acid (ABA), auxin (IAA), gibberellic acid (GA), cytokinins and ethylene. She notes that they all are present in all parts of the plant and all are involved in the control of abscission. Little is known about the physiological factors which determine the balances of hormones in plants, and little has been done to relate the processes of organ growth to hormone action in plants. From the hormone literature it is difficult to determine cause and effect. The plant appears able to sense a balance 15 between certain combinations of hormones involved in the stress-induced triggering of morphogenetic delay 16 and fruit abortion 17. For example, ABA and ethylene are implicated in the abscission process. Davis (1968) proposed that the abscission of cotton fruit is triggered by ABA above a threshold concentration. The data of Rodgers (1980) indicate that the threshold may be between 75 and 90  $\mu\text{g}$  equivalent ABA per 100g fresh weight of tissue. However, he suggests that in young fruit the amount of ABA available to the abscission zone is of less importance than its interaction with several growth hormones known to be present. He proposes a homeostatic mechanism. Davis and Addicott (1972) reported that young bolls abscising late in the season contained about twice as much abscisic acid as those abscising early in the season. The rate of ABA production is enhanced under conditions of low tissue turgor 20 (McMichael and Hanney, 1977). Guinn (1976) noted that the sensitivity of plant organs to ethylene varied with age, condition and the levels of other hormones. IAA and certain gibberellins seem to assure fruit retention. Because we are unsure of the hormone physiology here, for the sake of discussion, we refer to the factor contributing to fruit retention as  $\alpha$ , and the factor contributing to abscission as  $\beta$ . The rate of  $\alpha$  production is enhanced under conditions of rapid growth 35. Could it be that  $\alpha$  is a by-product of the growth process?

As noted earlier, the above rationale has been used successfully to simulate the seasonal time course of fruiting and morphogenesis. Those efforts suggest that, in cotton at least, the whole system is very dynamic. The metabolite pools are highly mobile and the abscission zones are very sensitive to the relative concentrations of  $\alpha$  and  $\beta$ . We have found that to simulate abscission and the developmental delays, it is necessary to assume that the carbohydrate reserves (up to 30 percent of leaf dry weight) are all available within a 24-hour period. Calculations show that with a heavy fruit load, demand always greatly exceeds supply. In other words, the plant is living on a single day's photosynthate production during much of the fruiting period. The trigger to abort may be reached over a very short time period, and is, of course, irreversible. Via this mechanism the plant balances fruit load against photosynthate supply. We assume that some background ABA level

exists, and that a carbohydrate stress which reduces fruit growth rate reduces the  $\alpha$  concentration and allows the ABA to trigger fruit abortion. ABA counteracts the effects of GA, auxin and cytokinin, probably by making the cell membranes permeable.

As Osborne (1974) noted, all of the five classes of hormones are found in all parts of seeds plants. However, there are large variations in concentrations between organs and between the major sites of production for the various hormones identified in Figure 5. Auxin is produced primarily by the shoot tips, but smaller amounts are found at all sites of meristematic activity (Moore, 1979). It is subject to basipetal polar transport in the plant. Its primary action is to loosen cellulose microfibrils in the cell wall so that cell expansion can take place (Moore, 1979). Cytokinin is produced primarily by root tips 18 and by young fruit (Sandstedt, 1971), but it is also found in all meristematic tissue. It is translocated in both xylem and phloem, but is immobilized in leaves and buds (Moore, 1979). Cytokinin enhances nucleic acid synthesis and protein synthesis. It, therefore, delays leaf senescence 19, presumably by maintaining the proteins in a good state of repair, and it facilitates cell division. Gibberellins also delay leaf senescence (Osborne, 1974). ABA (Radin, 1981; Friedrich and Huffaker, 1980) and the gibberellins have opposing physiological and biochemical effects, although gibberellins are synthesized in the chloroplasts (Moore, 1979), and ABA tends to accumulate there (Hartung *et al.*, 1981).

## WATER STRESS

As noted earlier, the CO<sub>2</sub> effect on stomatal aperture 3, together with the heat input to the leaf 22, at any specific humidity, determines transpiration rate, which along with soil water potential 23 and the hydraulic conductivity of the root system 24 determines the rate of water uptake by the plant (see Chapter 10). Any imbalance between water uptake rate and transpiration rate will reduce leaf turgor 25,26. The literature suggests that both turgor loss *per se* 27 and the increased ABA levels 28 associated with it will reduce stomatal apertures. However, Ackerson *et al.* (1977) reported numerous cases of visibly wilted leaves with reduced photosynthetic rates and little or no stomatal closure. We wonder if there is redundancy in the inclusion of the ABA stomatal closure connection 28 here. The feedback loop is closed in most cases, and the plant can conserve water. The suggestion of redundancy comes in the observation that if a plant is suddenly subjected to a high evaporative demand (little time for ABA buildup) turgor may be lost and the stomates may remain open.

The increase in ABA and ethylene associated with water stress seems to shift the hormone balance (  $\alpha / \beta$  ) toward fruit abortion and toward morphogenetic delay. This may be offset to some extent by the effect of turgor loss on potential growth rate 12 under conditions when growth is affected more than photosynthesis. Bruce and Römken (1965) observed that rainout shelter plants, grown in clay

soil, did not quickly resume vegetative growth and fruiting on rewatering after water stress treatments. In attempts to simulate the growth and development of these plants, we (Baker *et al.*, 1979a) found that the model GOSSYM, which predicted a restoration of photosynthate production and a relaxation of carbohydrate stress on rewatering, erroneously predicted a resumption of vegetative growth and a reduced rate of fruit abortion. We hypothesized that cell division and cell elongation were differentially affected by turgor loss, and we modified the model to accumulate the difference between potential (turgid) and actual organ growth under water stress conditions. This accumulated difference between actual and potential growth, during the drought, was added to potential growth on rewatering. Thus, in the model, on rewatering, an inordinate number of unexpanded cells contribute to the growth potential and to the total sink strength in the plant. This means that, even though rewatering may have enhanced photosynthate production, carbohydrate must be divided among more growing cells with the result that growth rate is curtailed in some. This offsets the enhancement of photosynthesis after rewatering and maintains the metabolic stress. With the inclusion of the logic, a good simulation of the Bruce and Römken's (1965) crops was obtained.

This rationale is somewhat controversial, and probably inadequate under conditions where osmoregulation occurs (Cutler and Rains, 1977). However, Radin and Parker (1979) have shown that growth can be inhibited by restriction in cell elongation while cell division continues, and Hsiao (1973) citing Slatyer (1967) and Slavik (1965) noted that it has often been stated that cell division appears to be less sensitive to water stress than cell enlargement. So there appears to be adequate justification for incorporation of this mechanism in a simulation model, at least under conditions of turgor loss.

An alternative explanation for the continued metabolic stress after irrigation, manifested in the Bruce and Römken's (1965) data, emerges from the experiments of Marani *et al.* (1984). They showed that when water stress develops over a considerable period of time, photosynthesis may not be fully restored for several days after rewatering. This effect may be mediated by root growth and cytokinin production. Apparently, cytokinin production is associated with root growth (Sitton *et al.*, 1967) in much the same way that IAA seems to be associated with shoot growth. Sitton *et al.* (1967) also have shown that the senescence rate of leaves is related to cytokinin levels. A powerful feedback effect may be set up in fruiting cotton subjected to water stress over a long period in which the reduction in root growth and the associated production of cytokinin enhances the rate of leaf senescence, aggravating the reduction in photosynthesis. On rewatering, the plants may have a low photosynthetic rate until the old, senescent leaves are shaded by a layer of new leaves.

The experiments of Marani *et al.* (1984) document the connection between effective leaf age and canopy photosynthesis (37 in Figure 5). They showed that water stress, as it typically occurs in the field during a drying cycle, decreases

photosynthesis through turgor effects on stomatal conductance, but it also affects leaf aging and the photosynthetic potential of the upper exposed leaves in the canopy in three ways. First, the rate of senescence of existing leaves is accelerated. Second, the rate of new leaf initiation is decreased. Third, the rate of growth and the ultimate size of new leaves is decreased. If the drought is long enough, these senescence effects on canopy photosynthetic efficiency may be quantitatively more important than the direct effects through leaf turgor and stomatal conductance. The effects are not simple, however. A vegetative plant may shift its dry matter partitioning to favor root growth. This tends to moderate the stress by allowing the plant access to more water, but also, if cytokinin production is associated with root growth, it may slow or moderate the drought effect on the leaf senescence rate. A fruiting plant, however, often lacks this option to shift partitioning in response to turgor loss in the leaves, and drought effects on canopy senescence and photosynthetic efficiency are profound. They can only be reversed with the initiation and growth of new leaves after rewatering.

## NITROGEN STRESS

The rate of nitrogen uptake by the plant depends on the water uptake rate 29 and the soil nitrogen concentration 30. The pool of available nitrogen depends on withdrawal by the plant in the growth process 31, the nitrogen uptake rate 32 and the reserves available. The GOSSYM model simulates nitrogen stress by reducing potential growth, *i.e.* the sink strength, on the assumption that if a certain minimum of nitrogen is not available for the elaboration of new tissue, the new tissue will not be elaborated.

It is possible that the mechanism of action of nitrogen stress on the rate of morphogenetic development and fruit abortion is through the same route as the effect of water stress. Radin and Mauney (Chapter 10) showed that a nitrogen-starved plant has a large resistance 33 to the radial flow of water through the root. This tends to unbalance the transpiration rate:water uptake rate to the detriment of plant turgor. This balance is restored to some extent, however, by the fact (Radin and Parker, 1979) that stomatal conductance in cotton is more sensitive to water stress 27 under nitrogen stress conditions. In many species there is a good relationship between leaf nitrogen concentration and photosynthetic efficiency (Boote *et al.*, 1978). It might be supposed that this is mediated by reduced stomatal conductance and that observed fruit abortion and morphogenetic delay, especially in indeterminate fruiting plants, is through reduced photosynthate supply. Thompson *et al.* (1976) reported that late season cotton leaf nitrogen concentrations fell below two percent under a range of nitrogen fertilizer application rates. We have conducted numerous full season canopy photosynthesis experiments (Baker, 1965; Baker *et al.*, 1972) in crops fertilized at rates in the range of the Thompson *et al.* (1976) experiments, and never observed any decline in photosynthetic efficiency until cold weather occurred. Thus, this mechanism

appears to operate only when leaf nitrogen concentrations fall below two percent.

We have proposed that cytokinins and gibberellins, which delay leaf and fruit senescence, are produced in the root system as by-products of root growth, and that IAA, cytokinins and perhaps, gibberellins are produced in the fruit as by-products of growth there. This hypothesis should be tested in experiments in which growth rates of these organs are varied in several ways while recording hormone concentrations in the organs. Root and fruit growth rates should be varied by adjusting photosynthate supply (atmospheric CO<sub>2</sub> concentration), temperature and turgor (water stress).

## SUMMARY

We have outlined the linkages between the major plant processes in a model which can mimic the whole plant responses to various types of stress by describing the various influences on carbohydrate, nitrogen and water supply and demand. We believe that the plant physiological processes and the linkages between them vary little among species. All fruiting plants seem to have the capability to adjust morphogenesis and fruit set to establish a balance between demand for and supplies of water, photosynthate and nutrients in a way that will ensure the development of viable seed. By constructing this model we hope to provide a conceptual framework for the dynamic simulation of whole plant growth and development. *The model defines stress as a imbalance within the plant which results in reduced growth rates.* The model predicts that stress delays morphogenesis, speeds senescence and causes fruit abortion. The model is capable of describing variations in dry matter and nutrient partitioning, and it provides an interpretation of observations of stomatal responses to water stress, photosynthetic responses to nitrogen stress, and the effects of these stresses on plant senescence. These shifts in hormone balances trigger premature senescence, delays in morphogenesis and organ abortion.

The simulation of plant stress requires a whole system model with soil and climate variables as inputs. Such a model must account for the fact that a plant grown in an elevated CO<sub>2</sub> atmosphere has an enhanced rate of photosynthesis which may increase organ growth rates, the cumulative (over the period of plant growth) indirect effects of which may go far beyond the immediate effects on photosynthesis and transpiration. For example, the model must account for the fact that an enhanced leaf growth rate will exponentially increase light capture and photosynthesis in many young crop canopies. It must account for the fact that a more rapidly growing root system will help the plant to escape drought, and if, as we have proposed here, cytokinin production is a by-product of this root growth, leaf senescence will be delayed, and the leaves will retain their photosynthetic efficiency longer. Such positive feedbacks can amplify the direct effects of enhanced photosynthesis. Simultaneously, the model must account for the higher fruit set resulting from the enhanced fruit growth rate. Finally, the model must

account for the partitioning of more dry matter into fruit and the effect of this on vegetative (especially root) growth.

The ability of this dynamic crop simulation model to predict crop growth should be tested by comparing its predictions with crops grown under controlled conditions in which photosynthesis, transpiration and growth can be varied independently.

*SECTION III*

**BOLL DEVELOPMENT**



## Chapter 20

INTEGRATED EVENTS IN THE  
FLOWER AND FRUIT

James McD. Stewart<sup>1</sup>  
USDA—ARS  
Knoxville, Tennessee

## INTRODUCTION

The Chapters of Section I present the parameters that influence flowering and production of fruit numbers such as time of flowering, sites of production and factors involved in fruit abscission. The cotton plant is regulated in such a way that fruit load is limited by abscission of square and young bolls when there is stress upon the plant. In this way, the impact of a stress upon individual bolls that remain often is ameliorated (Eaton, 1955; also, see Chapter 12).

During the square period and subsequent boll period many sequential steps occur which lead to the open flower with all its parts and eventually to the mature fruit with the seed and lint. Each stage of development of each part of the fruit is subject to modification by the environment and by the competition for photosynthate that prevails during that stage.

The purpose of this discussion is to show how the various events in boll development are interrelated during their development. Also where appropriate, discussions of the effect of environment on the interactions will be included.

## THE SQUARE PERIOD AND THE FLOWER

## SQUARE

**Development**—The development of the cotton fruit involves a complex series of events and interactions that begins with the formation of the flower bud (square). Unfortunately, less is known of the physiology of square formation and growth than any other part of the cotton fruiting cycle. Mauney (Chapter 2) reviewed some of the factors involved in square formation. Baranov and Maltzev (1937) and Joshi *et al.* (1967) described the morphological development of the square in the four cultivated species in *Gossypium*.

The structures that make up the flower are generally recognizable during square development. The earliest structure noted is the epicalyx which becomes the bracts of the mature fruit. Enclosed within the 3-sided "square" is the developing flower bud composed of the calyx, corolla, androecium and gynoecium.

<sup>1</sup>Presently with University of Arkansas, Fayetteville, Arkansas

cium. The last two are discussed in more detail below.

The development from just visible square to open flower generally takes 25-30 days under good growing conditions, so the actual stimulus to flower must start 10 to 15 days before this stage (Gipson and Ray, 1974; Hesketh and Low, 1968; Martin *et al.*, 1923; Quintanilha *et al.*, 1962). Elongation of the bud of *G. hirsutum* is linear until about a week before anthesis (Martin *et al.*, 1923; Quintanilha *et al.*, 1962). During the last week before bloom the rate of growth increases dramatically and the bud doubles in length. On the other hand, the diameter of the bud is strongly correlated linearly with days to anthesis (DeLanghe, 1973; Quintanilha *et al.*, 1962). DeLanghe (1973) also determined that the diameter of the preanthesis ovary was linearly related to the bud diameter, as one would expect.

The difference in correlations of age with bud length and with bud width results from the developmental sequence of the anatomical structures measured. Bud length is primarily a function of corolla development. Most likely, cell division (linear phase) ceases and cell expansion (exponential phase) begins in the corolla during the week before bloom. Cellular expansion culminates in the open petals on the morning of anthesis when full maturity of the corolla is attained. Width of the bud is related more to the growth of the carpels which continue active cell division past anthesis.

DeLanghe (1973) found that absence of the subtending leaf resulted in slow growth of the bud and early shedding of the young boll. Gibberellic acid (GA) applied to the debladed petiole replaced the growth-promoting effect of the leaf; therefore, the subtending leaf of a square probably provides the GA for growth of that bud.

**Response to Environment**—The response of a cotton plant in the square stage to the environment is of particular interest because of the close relationship of square and flower production to earliness of a cotton crop. Several authors (Eaton, 1955; McMichael, 1979; see also Chapters 2 and 7) discussed the tendency of young squares to abscise when the plant is subject to stress. McMichael and Guinn (personal communication, 1980), from their preliminary data and the data of others (Grimes *et al.*, 1970), suggest that the sensitivity of a flower bud to water stress stimulus is greatest during its first week after visibility. Flower numbers during the weeks subsequent to the relief of a water stress indicated that square abscission was highest in the young squares, with the rate declining more or less linearly to nil at flowering. There are no reports of flowers abscising. Clearly, the physiology of the developing fruit form changes in ways which we do not yet understand.

Square abscission is also the main plant response to other stress situations, such as nutritional stress induced by shading, prolonged cloudy weather, or competing boll load (Eaton and Rigler, 1945; Eaton and Ergle, 1954; Eaton, 1955; Ehlig and LeMert, 1973; see also Chapters 6 and 12). A high rate of abscission may also be

associated with high temperature. Data on *G. hirsutum*, presented but not discussed by Ehlig and LeMert (1973), indicated that the number of flowers per meter of row declined approximately 3 weeks after periods when the maximum temperature exceeded 42C. This effect was particularly notable during a period when the number of flowers would normally be increasing rapidly. The response to high temperature is frequently confounded by moisture stress.

Little information is available on the effects of moisture stress on squares that are retained. High temperature effects on retained squares have been noted and will be discussed below in relation to pollen development. Plants grown at a constant 29.4C in growth chambers produced abnormal flowers in which the corolla failed to open and anthers did not dehisce (Powell, 1969). Plants with an alternating high-low temperature cycle had normal flowers.

Suboptimal temperatures generally do not result in square abscission; in fact, moderately cool periods during the juvenile growth of the cotton plant may promote early square formation (Chapter 2). Square period lengthens as average (Hesketh and Low, 1968) or night temperature (Gipson and Ray, 1974) decreases. Growth of the squares generally stops when temperature falls below 15C. However, square development apparently is less sensitive to night temperature than is boll development. Hesketh and Low (1968) found that flowers, but no bolls, formed at a temperature regime of 18C/13C. The square period increased only 20 percent at a night temperature of 13C compared to 25C (33 days vs. 27.5 days) (Gipson and Ray, 1974). The day temperatures were not reported. Square periods in Pima cotton did not change with plant age or position, but some lengthening due to temperature occurred in the latter part of the season (Martin *et al.*, 1923).

## OVARY

**Carpel Number**—The ovary is compound in cultivated cottons, but the four cultivated species differ somewhat in the average number of carpels (locks) per ovary. *Gossypium arboreum* and *G. barbadense* average between 3 and 4, whereas *G. herbaceum* and *G. hirsutum* average 4 to 5. The average number of locks is strongly influenced by genetics, but environment also plays an important roll, both on potential locks per boll (carpels per flower) and on differential rates of shedding of bolls. Since the number of carpels per flower is determined very early in square formation (ca. 3-4 weeks preanthesis), the environment and physiological state of the plant prevailing during the "squaring" period will influence the ratio of 4 to 5 carpellate flowers in upland cotton.

Figure 1 shows the ratio of flowers with 4 and 5 carpels and the relative flowering rate of 'Acala' grown with and without adequate moisture (Beckett and Hubbard, 1932). The percentage of 5-carpel flowers increased to peak bloom and then declined. The decrease in carpel number was probably associated with the onset of flowering and accumulation of boll load that occurred during the fourth week prior to the declines. Surprisingly, the water stress conditions seemed to

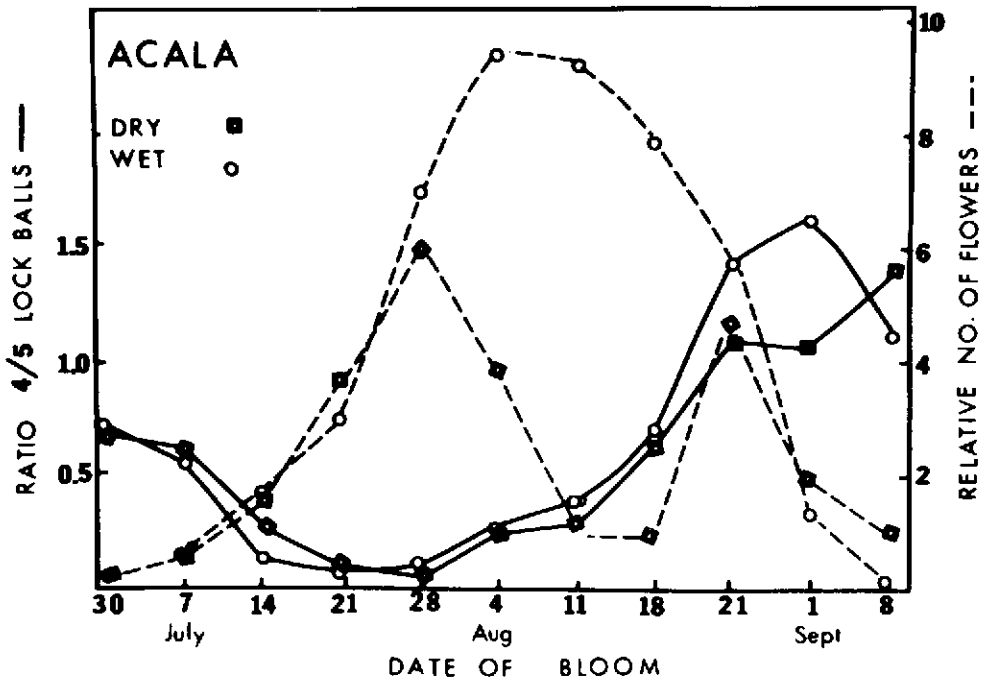

Figure 1. Ratio between Acala flowers with 4 and 5 carpels per ovary and the relative flowering rate during the bloom season as affected by water stress. Results are calculated from data presented by Beckett and Hubbard (1932).

have had only minor influences on the average number of carpels per flower (Beckett and Hubbard, 1932). In other experiments by the same authors (Beckett and Hubbard, 1932) Lone Star was grown at Greenville, Texas; although the flowering pattern differed from that of Acala in California, there were similar trends in the average number of carpels per flower with stage of development.

Leding and Lytton (1933), working with an unspecified variety of upland cotton in New Mexico, determined carpels per flower from peak bloom (late July) to late September under close spacing and moisture stress. In all cases, their results showed the same trend as shown in Figure 1 for corresponding periods. Moisture stress decreased the average number of carpels per flower slightly, but close spacing of plants had a major effect in reducing the average.

"Locks per boll" is primarily determined by carpels per flower, but differential shedding of 4 and 5 lock bolls has some influence. Beckett and Hubbard (1932) found that a great percentage of 5-lock bolls set under favorable growing conditions, but under moisture stress, the 5-lock bolls were consistently shed more often than 4-lock bolls. Johnson and Addicott (1967) found more 5-lock bolls after, than before, August 1 and speculated that 5-lock bolls were retained preferential-

ly. However, they assumed that the ratio of 4 to 5 carpellate flowers did not change, so their interpretation, which is contrary to the previous reports, may be invalid.

The tendency for the average lock number to decrease with increasing boll load, and the strongly negative response to close spacing (shading) suggest that the carbohydrate status of the plant influences the relative number of 4 and 5 carpellate ovaries produced. The effects of temperature on carpel number have not been definitively determined.

**Ovules**—The morphological development of cotton ovules has been described (Baranov and Maltzev, 1937; Joshi *et al.*, 1967; Stewart, 1975), but the physiology of ovule development before flowering has received only limited attention. Powell (1969) found that *G. hirsutum* plants maintained at a constant high temperature (29.4C) had very low fruit set, even when pollinated with pollen of known viability. An alternating high-low temperature regime resulted in normal fertility. A possible explanation is that the egg is inviable under constant temperature; however, failure of the stigma and style to support pollen germination and tube growth cannot be ruled out.

Hughes (1966) found seasonal and positional effects on the number of ovules per carpel in *G. barbadense* in Sudan. Flowers tended to have fewer ovules per lock the more distant they were from the main stem. The first sympodial node averaged the most ovules. Flowers produced very early and very late in the season averaged fewer ovules than those produced mid-season. The seasonal trend occurred on defruited as well as fruited plants, hence was independent of boll load. In general, flowers that have bloomed at the same time, regardless of position on the plant, tended to average the same number of ovules. Hughes (1966) also found that nitrogen fertilization produced a sizable increase in the average number of ovules/lock. Potassium gave a slight positive response, but phosphorus showed no effect.

Turner *et al.* (1977) found that as the bloom season progressed, the number of ovules per flower of *G. hirsutum* increased. Our unpublished data from these experiments showed that all of the 8 cultivars tested had an increase in ovules per carpel over the 5-week bloom-period observed. Thus, most of the increase in ovules per flower was due to an increase in ovules per carpel rather than carpels per flower (Figure 2). Others (Porter, 1936; Johnson, 1966) also observed an increase in ovules or seeds per boll (S/B) from early season to late season.

Pearson (1949a) noted vestigial structures which resulted in "false" notes in mature cotton. From my observations (unpublished), these structures, located at the base of the carpel, are incompletely developed ovules. Most likely, these structures reach full development in mid- and late-season squares of *G. hirsutum* and account for the increase in ovules per lock. Pearson (1949a) noted that false mote number declined from July 12 to August 9.

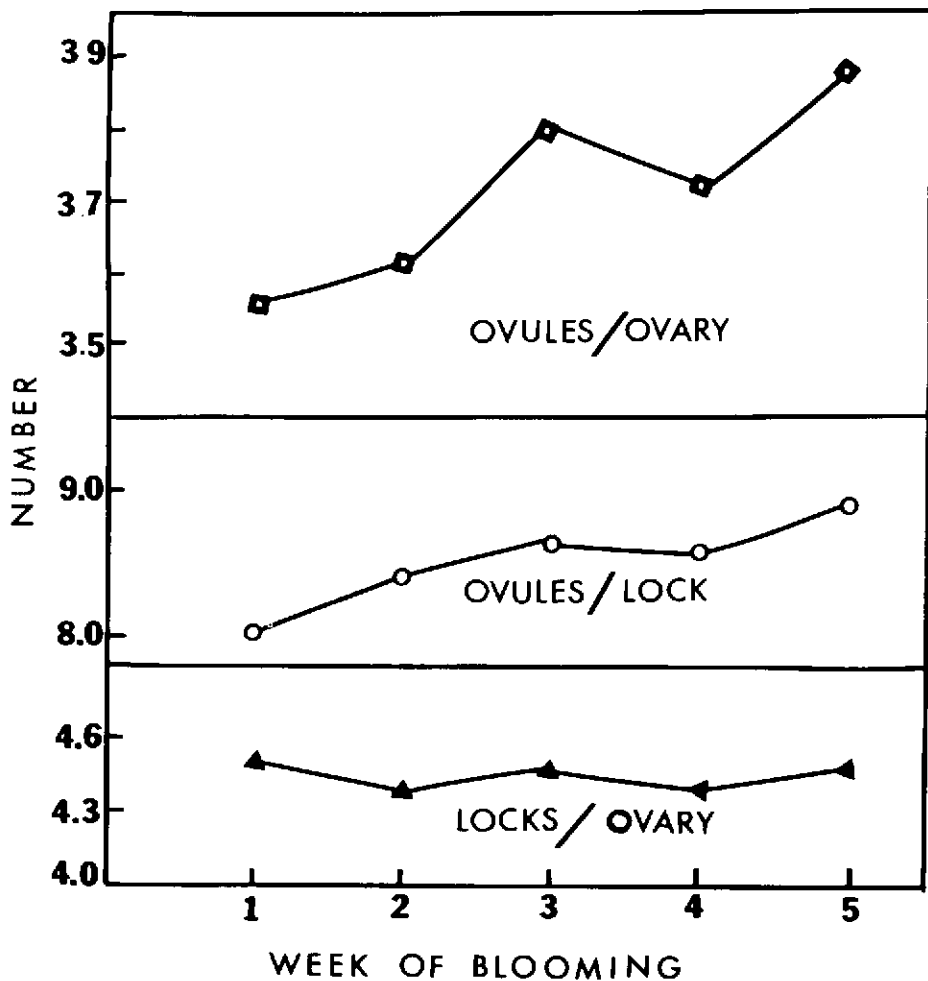

Figure 2. Influence of the week of blooming on the number of locks per ovary, ovules per lock and ovules/ovary. Average of 8 cultivars.

The influence of temperature on the number of ovules per flower has not been determined directly. However, the trends observed by Hughes (1966) in the Sudan and Turner *et al.* (1977) in the USA indicate that both cool temperatures and excessively hot temperatures during the formation of the square result in a lower number of ovules per lock.

## STAMEN

Information on cotton stamen development is generally limited to morphology and microsporogenesis (Beal, 1928; Baranov and Maltzev, 1937; Joshi *et al.*, 1967) rather than physiology, but some work has been done on the time of critical events. The microsporangia (anthers) develop very early in the square period and are established before the ovary obtains its complement of ovules (Quintanilha *et al.*, 1962). Meyer (1966) found that the number of anthers in *G. hirsutum* cv. M-8 was significantly and positively correlated with the mean relative humidity 22-23 days before anthesis. There was no correlation between anther number and temperature or absolute humidity. The 22-23-day-period corresponds approximately with the time of meiosis according to the time scale of Quintanilha *et al.* (1962). Meyer's (1966) results may indicate that anthers abort, since anther number is certainly determined considerably in advance of meiosis.

Continuous high or low humidity may have a negative influence in cotton production. Hoffman & Rawlins (1970) grew *G. hirsutum* plants in growth chambers which differed in relative humidities (R.H.). At constant low (25 percent) or high (90 percent) atmospheric relative humidity the anthers of the flower failed to dehisce. Also, the filaments were shorter at the extremes of R.H. compared to 40 or 60 percent R.H. The cause of indehiscence was not explored. Most likely, at high R.H. the anthers were normal, but could not dry sufficiently to dehisce, whereas at low R.H. the anthers were probably abnormal.

Structural variations within the developing anthers may influence subsequent events. Joshi *et al.* (1967) noted that anthers which failed to produce fibrous thickening in the endothelial layer did not dehisce, even though they contained mature viable pollen grains. Conditions responsible for the aberration were not explored. Also, genetic mutants occur where viable pollen is produced, but the anthers fail to dehisce (Murthi and Weaver, 1974).

**Microsporogenesis**—A detailed description of microsporogenesis is beyond the scope of this review; however, mention should be made of environmental influences during critical periods of development of the pollen. A number of reports (Sarvella, 1966; Meyer, 1969; Powell, 1969; McDonald and Stith, 1972) indicate that high temperature (32C+) 15-17 days before anthesis increases the sterility of pollen in temperature-sensitive male sterile stocks. Even fertile lines begin to show sterile anthers above 38C (Meyer, 1969). McDonald and Stith (1972) found simple correlations between maximum temperature at 17 days preanthesis and sterility. Multiple correlation analysis indicated an interaction at 19 days preanthesis also. In addition, these authors found that correlations existed between sterility and maximum humidity at 19 days (simple correlation) and 15 days (multiple correlation). Powell (1969) found that *G. hirsutum* grown at a constant temperature of 29.4C or above failed to produce viable pollen. Humidity was maintained at 70 percent. When the plants were grown with an alternating high-low temperature regime, the pollen was fertile. Fisher (1975) examined a

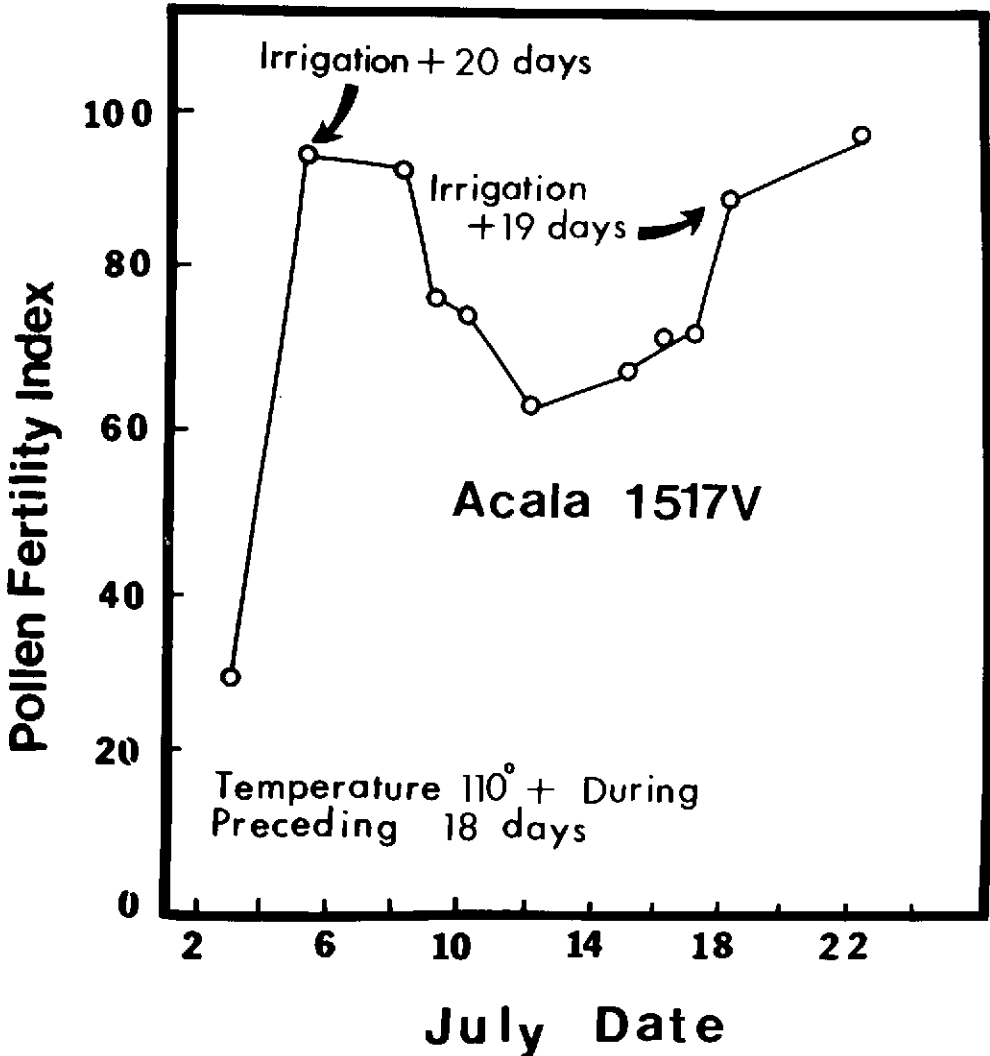

Figure 3. Influence of temperature on pollen fertility under production conditions. The temperature exceeded 43C each day during the 18 days prior to July 3. Irrigations, which reduce field temperature, were approximately 3 weeks before the days indicated by the arrows. Data from Fisher (1975).

number of cultivars under field conditions in Arizona and found that there were genetic differences in heat-sensitivity. Figure 3 is a graph of pollen fertility for one of the most heat-sensitive cultivars observed by Fisher (1975). The decreased level of pollen fertility could be attributed to high temperatures during the



preceding 3 weeks. The role of humidity could not be determined from the data; however, the cooling effect of irrigation (Stockton and Walhood, 1960) was probably sufficient to restore fertility.

Environmental factors such as temperature and humidity during critical periods of microsporogenesis apparently can induce pollen sterility and anther indehiscence. The exact stage of development at which the sensitivity occurs is not known; however, based on the time scale of Sarvella (1964) or Quintanilha *et al.*, (1962) it occurs after, rather than during, meiosis. Generally, in field plantings, the conditions must be extreme before a significant impact is noted and even then the genetic component is a major factor. If one considers the results of Powell (1969), it may be that pollen sterility is related to minimum temperatures rather than maximum temperature. That is, if during the critical period the night temperature does not drop low enough after a hot day, sterility results. This idea is supported by the results of Fisher (1973) who compared temperature and boll set over 7 years.

## ANTHESIS

**Flower Opening**—The culmination of the square period occurs with the opening of the flower. The cells of the petals expand rapidly during the 24-hours preceding anthesis, and by early- to mid-morning the corolla is fully expanded. Simultaneous with petal expansion is the elongation of the stigma-style and of the filaments of the stamens. Less evident, but well documented (Anderson and Kerr, 1938; Lang, 1938; Stewart, 1975; Ramsey and Berlin, 1976a,b), is the fact that cotton fiber expansion begins early on the day of anthesis. This phenomenon occurs independently of fertilization; hence, it is related to the hormonal balance associated with the developmental progression of the flower bud rather than the pollination event. The hormonal or biological control of cotton flower opening has not been studied, but it is reasonable to assume that the simultaneously expanding tissues of the flower (petals, style, filaments, fibers) are all under the same temporal hormonal stimulus. Work by Beasley (1973), DeLanghe *et al.* (1978), Dhindsa (1978a) and Kosmidou (Chapter 25) strongly indicate that the stimulus to fiber initiation is gibberellic acid, but auxins cannot be ruled out.

The actual expansion process is probably mediated by active transport of sugars and potassium and synthesis of malate. This is indicated indirectly by the fact that the opening of the flower is strongly related to temperature; cool temperatures may delay expansion by several hours. Moderate drought seems to have less influence on opening than low temperature (unpublished observations).

The opening of the flower is the stage of sexual maturity of the cotton reproductive system. The embryo sac within the ovule is fully developed and receptive to fertilization. Pollen is shed from the anthers and will germinate on appropriately receptive stigmas.

***In Vitro* Germination and Tube Growth**—Studies on cotton pollen have been limited by the extreme sensitivity of the pollen to moisture. Whenever the grains or tubes contact freely available water, they rupture. Approaches to circumvent this problem involve both non-aqueous methods and aqueous gels or solutions of high osmolarity. The non-aqueous method of Klyukvina (as reported by Miravalle, 1965) involved grains coated with refined castor oil and maintained at 100 percent R.H. Although the original author reported nearly complete germination, Miravalle (1965) obtained no germination by the method. Bronkers (1961) developed a method involving exposure of the pollen to acenaphthene vapors in a humid atmosphere. Miravalle (1965) confirmed that cotton pollen has a high percent germination under these conditions; however, the tube growth reported by both authors was limited to no more than 3 times the grain diameter.

Aqueous methods using high osmolar solutions have received more attention than non-aqueous methods. Hancock (1949) got high percent germination but no tube growth on 35 percent sucrose solidified with 1½ percent agar. Vasil (1958) used 40 percent sucrose with 0.01 percent boric acid without agar and obtained lower germination but longer tubes (up to 0.78 mm). Taylor (1972) used 25 percent sucrose, and in addition to boric acid, he included manganous sulfate and calcium nitrate. Also, he solidified his medium with 3.5 percent agar and then aged the germination plates for 2 days under refrigeration before applying pollen grains. Although germination averaged only 30 percent, tube length averaged 15 pollen grain diameters (1.65 mm) with some tubes reaching 30 diameters. Wauford (1979) used Taylor's medium as a starting control and made subsequent additions and modifications in a number of parameters. The changes most noticeably improving germination or tube growth were the addition of  $MgSO_4$  and a pH of 7.6. When  $MgSO_4$  and  $KNO_3$  were present, Ca was found to be nonessential or inhibitory. Govila and Roa (1969) also found beneficial effects on germination with the addition of magnesium and potassium. Wauford's (1979) best medium consisted of 25 percent sucrose, 3.5 percent agar, pH 7.6, 5.9 mM  $MnSO_4$ , 1.6 mM  $H_3BO_3$ , 1.0mM  $KNO_3$ , 0.8 mM  $MgSO_4$ , 1  $\mu$ M GA and 0.1 mM IAA. With this, he averaged 47 percent germination and 2.60 mm tube length.

Wauford (1979) also examined the influence of different sugars on germination and tube growth. No germination occurred on fructose and only about 12 percent occurred on raffinose. Glucose and sucrose each supported about 33 percent germination under the conditions used. Tube growth was greatest on sucrose (1.6 mm), less on raffinose (1.2mm) and very low on glucose (0.2mm). In most cases, tube growth ceased due to rupture of the tube.

Investigations concerning the influences of growth regulators on cotton pollen germination and tube growth are limited and conflicting. Taylor (1972) reported that IAA and GA did not help or were inhibitory, whereas Wauford (1979) found them to be beneficial. The latter author found also that the growth retardant, succinic acid-2, 2-dimethylhydrazide (SADH), inhibited both germination and tube growth. Tube growth was almost 3 times as sensitive to SADH as was

germination. IAA or GA could not relieve the inhibition. In a preliminary experiment (unpublished), we noted that pollen tube growth was insensitive to  $10^{-5}$  M 2-chloroethylphosphonic acid in the medium. Lipe and Morgan (1973a) found that anther and stigma-style tissues produce exceptionally high levels of ethylene. These data suggest that ethylene, although present, does not inhibit germination and tube growth. Whether it may serve as a promoter should be investigated.

Bronkers *et al.* (1972) used the method of Bronkers (1961) in their search for correlations between atmospheric conditions during growth of the parent plant and pollen germination percentage. No correlations were evident within the ranges of their climatic conditions. We noticed (unpublished data) that pollen germination and tube growth on artificial medium (Wauford, 1979) were influenced by the mineral nutrition of the parent plant.

The ultrastructure and some of the histochemistry of pollen cytoplasm were examined by Jensen and coworkers (Jensen *et al.*, 1968; Fisher *et al.*, 1968). They used Bronkers (1961) method for germinating pollen in their comparison of germinated and ungerminated pollen cytoplasm. The results of those studies indicate that mature pollen contains the reserves necessary for germination and early tube growth.

**Pollen Storage**—Cotton pollen generally cannot be stored for long periods (Govila & Rao, 1969). Wauford (unpublished data) obtained less than 5 percent germination of *G. hirsutum* pollen collected at 1:00 pm and then stored at room temperature for 24 hours. J.R. Barrow (personal communication) found that pollen collected at 8:00 am had only 1 percent viability at the end of the next day. However, buds collected the day before anthesis and stored under moderate refrigeration retain viability of the pollen for a few days. Harrison and Fulton (1934) reported that Pima pollen stored 4 days in a household refrigerator, where the lowest temperature was 4C, allowed 60 percent retention of bolls, but seed per boll (S/B) dropped from 13.2 to 11.6. I (unpublished data) and Barrow (personal communication) both observed that pollen will not survive freezing for 24 or 48 hours at -5C. It is likely that freezing for any length of time will kill cotton pollen.

**In Vivo Pollen Tube Growth**—Iyengar (1938), in the first systematic study of pollen tube behavior in *Gossypium*, found that pollen on the basal part of the style germinated much less readily than pollen placed at the top of the style. The pollen of both American and Asiatic cottons germinate within 30 minutes after contacting a receptive stigma (Pundir, 1972). The tubes extend between the papillate hairs of the stigma and penetrate into the conducting tissue. After grain germination, the generative cell divides to form the two sperm cells. These cells and the tube cytoplasm are described in detail by Jensen and Fisher (1968).

The growth rate of the pollen tubes is slow for the first 2 hours as they traverse the stigmatic tissue to the conducting tissue. The rate in *G. hirsutum* then

increases to a maximum of about 3 mm/hr. as the tubes pass through the style. As the tubes approach the base of the style, the rate declines. The lowest growth rate is in the ovary (Iyengar, 1938; Pundir, 1972). *G. arboreum* pollen tube growth follows the same pattern except at a slower rate. When *G. hirsutum* pollen is placed on *G. arboreum* flowers, a slower rate of tube growth results. Conversely, the rate of tube growth of *G. arboreum* in the style of *G. hirsutum* is greatly increased (Pundir, 1972). These results indicate that the nutritive-hormonal balance of the conducting tissue is important to tube growth.

Suy (1979) examined some of the effects of environment on pollen tube growth of *G. hirsutum*. Light intensity did not influence the rate of growth, but red light (6,500 Å) increased slightly (13 percent) the length obtained in 4 hours compared to white light. Relative humidity at 55 and 80 percent did not affect tube growth but 30 percent R.H. decreased growth. The most important factor was temperature. During the 4-hour test period adopted by Suy (1979), the rate of elongation was near zero below 19C and above 45C. Rate was linearly related to temperature up to 37C, but growth declined rapidly above that temperature. These results indicate that hot, dry conditions will inhibit pollen tube growth. If such conditions persisted, fertilization and seed set would be adversely affected.

At the opposite extreme, Pearson (1949b) observed that rain during morning hours decreased boll set and increased the number of unfertilized ovules in those bolls which did set. Her observations are, no doubt, a direct result of the moisture sensitivity of pollen grains.

## THE BOLL PERIOD

### SEED AND BOLL SET

**Fertilization**—The boll period of cotton traditionally is measured from the day of anthesis. Pollination occurs on the day the flower opens, but fertilization does not occur until 12 or more hours later. Many (Baranov and Maltzev, 1937; Constantine, 1964; Iyengar, 1938; Joshi *et al.*, 1967; Pundir, 1972) have described fertilization in cotton, but the work of Jensen and coworkers (Fisher *et al.*, 1968a,b; Jensen, 1965, 1968a, 1968b; Jensen and Fisher, 1967, 1968; Jensen *et al.*, 1968; Jensen *et al.*, 1977; Schulz and Jensen, 1977) has made cotton a model system for double fertilization. Only a brief summary will be given here. For details and ultrastructure the reader should refer to the above citations.

To accomplish fertilization, the pollen tube, by some unknown mechanism, grows toward and into the micropyle. Often, several tubes may enter a micropyle, but only one succeeds in penetrating one of the two synergids. This receiving cell begins to degenerate as a response to pollination and can be identified before the pollen tube reaches it. The sperm cells are discharged into the synergid through a lateral pore. The nucleus of one of the sperm cells enters the egg cell and begins fusion with the nucleus of that cell. The other sperm nucleus enters the polar cell

and fuses with one of the polar nuclei. This 2x nucleus then fuses with the remaining polar nucleus to form the 3x primary endosperm nucleus. Apparently, the nuclear fusions in the polar cell occur before the zygote is formed. The primary endosperm nucleus divides immediately and repeatedly, whereas the newly formed zygote shrinks in size and does not divide for about 72 hours.

**Seed Setting Efficiency**—The fertilization process is of primary importance to the production of the cotton crop. Any adverse factor during square development (discussed previously) which decreases egg or pollen viability or tube growth may adversely affect yield. Walhood and McMeans (1964) determined fruit retention as a function of seed number. To limit fertilization, they removed 50 percent or 90 percent of the stigma before pollination. Boll retention dropped from 68 percent in the control to 3.8 percent in the 10 percent stigma treatment. Within the bolls that set, seed number was reduced from 32 in the control to 10 in the 10 percent stigma. They concluded (Walhood and McMeans, 1974) that a high number of ovules must be fertilized to assure retention of a boll. The same conclusion was implied by Pearson (1949b).

The number of seeds in a boll is a function of ovules per flower and fertilization efficiency. The former is primarily a function of genetics but with an environmental component as discussed earlier. The reverse is true for fertilization efficiency. Turner *et al.* (1977) used the term "seed setting efficiency" (SSE) to designate the number of seeds produced compared to the number of ovules available for fertilization. When they determined SSE over a 5-weeks bloom period, they found that efficiency of fertilization declined late in the season one year but did not change the second year. In the 8 cultivars examined, the apparent SSE was approximately 90 percent. In reality, SSE was probably lower since more of the bolls with fewer seed would shed (Walhood & McMeans, 1964).

Small motes in mature cotton are ovules which were not fertilized (Pearson, 1949b). As such, the number of small motes in a boll can be used as an indication of fertilization efficiency. Rea (1929) found that mote content varied from 14 to 47 percent in 16 cultivars of upland cotton. High mote count was related to drought conditions. Pearson (1949b) examined several cultivars at 8 locations for 3 years and found that the influence of environment was much more important in the occurrence of motes than the influence of cultivar. Cultivars tended to retain their same rank regardless of when and where grown. Locational factors seemed to be more important in the occurrence of small motes than seasonal factors. On a day-to-day basis, the number of motes could be correlated with increases and decreases in maximum temperature or with rainfall during the morning hours. Pearson (1949b) concluded that high temperature was probably the most important determiner of mote number in a crop since few bolls set on rainy days. Hughes (1968) found that about 5 percent of the ovules of *G. barbadense* became motes. Under Sudan conditions, early bolls had more unfertilized ovules than later bolls, but the number increased again toward the end of the season. He found

no relationship between number of motes and weather or irrigation cycle.

There is disagreement concerning the ovule positions most likely not to be fertilized. Walhood and McMeans (1964) found that bolls with low S/B had the seed at the apex. Iyengar (1938) observed that the earliest pollen tubes reaching the ovary did not necessarily enter the top ovules. Order of entry did not depend on position. Rea (1928) and Porter (1936) reported a progressive increase in motes from the apex to the base of the boll. Hughes (1968) found 20 percent of the motes in the basal position with no differences between the other positions. On the contrary, Pearson (1949b) found that the apex position failed to get fertilized just as often as the basal position, if only one mote per locule occurred. When there were two or more motes per locule, or when the number of ovules per locule increased, the basal position was less likely to be fertilized. Taken together, the reports indicate that the basal position is least likely to be fertilized.

**Consequences of Fertilization**—Assuming adequate nutrition and moisture within the plant to support additional bolls, failure of the ovules to be fertilized results in abscission of the young boll. Lipe and Morgan (1972, 1973a,b) showed that ethylene production by young fruiting forms was sufficient to induce abscission. The process of fertilization supplies an additional stimulus that counters the action of ethylene and prevents the shed of the young boll. Cognee (1975), Walhood (1957) and Walhood and McMeans (1964) demonstrated that GA was nearly as effective as fertilization in promoting boll retention (see Chapter 23).

An interesting observation related to fertilization was made by Jensen *et al.* (1977). When unfertilized ovules were cultured with GA and IAA, the two polar nuclei of the embryo sac fused and divided several times. In addition, one of the synergids degenerated. Since these events occurred without actual fertilization, the question of hormone source under natural conditions is open. Must actual penetration by the sperm cells occur, or does the process of tube growth produce sufficient hormone to trigger the observed changes?

Some phenomena occur independently of fertilization but are accelerated, or will continue, only if fertilization is successful. For example, the decline and separation of the corolla, staminal column and style occur without fertilization, but growth of the pollen tube in the style accelerates the evolution of ethylene (Lipe and Morgan, 1973a) and the senescence of these structures. As noted earlier, the fiber initials begin to elongate on the day of anthesis and will continue elongation for a few days without fertilization occurring (Cognee, 1975; Quintanilha *et al.*, 1962; see Chapter 23); however, the stimulus associated with fertilization is necessary for the grand elongation of the fiber.

In practical terms, the subsequent processes and events of boll development are dependent upon the fertilization event. The various aspects of boll development which are discussed in detail in other chapters need not be repeated here. In subsequent discussion, I will attempt to point out the aspects of boll development that may be competitive or interrelated in some way. Also, the influence of environmental factors on some aspects of development will be included.

## DRY MATTER DISTRIBUTION

The development of a cotton boll with all of its components is an integrated process in which the various events occurring at any given time are under similar environmental, nutritional and hormonal influences. The distribution of available carbohydrate is controlled by the relative strength of the various competing sinks (Chapter 22). There are indications that some of the developing seed parts and constituents respond differentially to environmental changes; however, these phenomena have received only limited attention.

In *G. hirsutum* the ovary (bur) reaches full size and weight in 3-4 weeks (Leffler, 1976c) from anthesis. The seed reach their full volume and the fibers attain their maximum length (Schubert *et al.*, 1973) during this period also. The enlarging phase in *G. barbadense* takes somewhat longer (Schubert *et al.*, 1976). That most of the tissues expand simultaneously and then cease expansion at the same time seems more than coincidental. Conceivably, these tissues are under the same hormonal control to expand during the first 3-4 weeks postanthesis. During the third week the hormonal balance influencing the boll probably shifts to one which promotes accumulation rather than expansion.

**Typical Weight Distribution**—Figure 4 illustrates dry weight changes in various tissues of seeds of *G. hirsutum* cv. Coker 310. The seed were divided into the anatomical structures: fibers, outer integument, palisade, endosperm and embryo. Depending on age of the seed, the endosperm fraction included also the inner integument and nucellus, or in general, those tissues which support embryo growth. Fibers included fuzz fibers. For each of the two years, fiber weight increased up to about 16 days, at which time a decline occurred in the rate of increase. Thereafter, there was a resumption of rapid weight increase. The outer integument (not shown in Figure 4) increased in weight slowly for the first 2 weeks, but tripled in weight between 15 and 20 days postanthesis (DPA). The weight was constant or declined slightly (from 8 mg to 7 mg) for the next 2 weeks (36 DPA) then increased in weight slowly (to 10 mg) until opening. The palisade, which is formed from the outer epidermis of the inner integument, was evident and separable at about 14 DPA. The rate of weight increase in this structure was greatest between 20 and 30 DPA but a very slow increase in weight continued until opening. The endosperm tissue weight increased steadily up to 20 DPA and then declined in weight equivalent to the weight increase of the embryo. The weight of the embryo exceeded the weight of its supporting tissue at about 30-32 DPA. Beyond that, the rate of embryo weight increase was greatest. After 30 DPA, essentially all dry matter increase was in the fibers and embryo with the former accumulating cellulose and the latter accumulating oil and protein.

## RELATIVE WEIGHT DISTRIBUTION AND DEVELOPMENTAL EVENTS

**External vs. Internal Weight**—The relative distribution of dry weight during seed development is best illustrated by the ratios of weights versus time and by direct

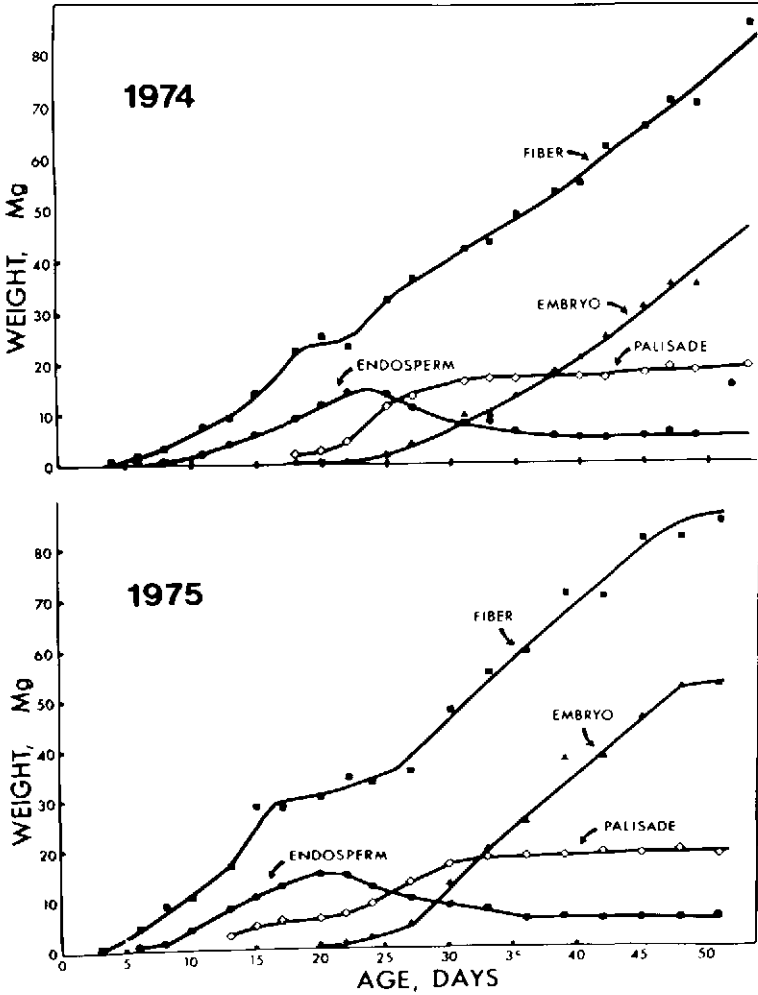

Figure 4. Distribution of mass into the various parts of Coker 310 seed during development. Fiber includes fuzz fiber and endosperm includes inner integument and nucellus. Each point is the average of the contents of 15 bolls.

comparison of the growth of seed parts. Figure 5 presents the ratios of external weight (fiber, fuzz and outer integument) and internal weight (remainder of seed) as a function of DPA. The external part of the seed receives the greatest portion of photosynthate during the first few DPA. This is indicated by the rapid increase in the ratio of external to internal weight during that period. After 4 to 6 DPA, depending on cultivar and environment, the internal weight increases



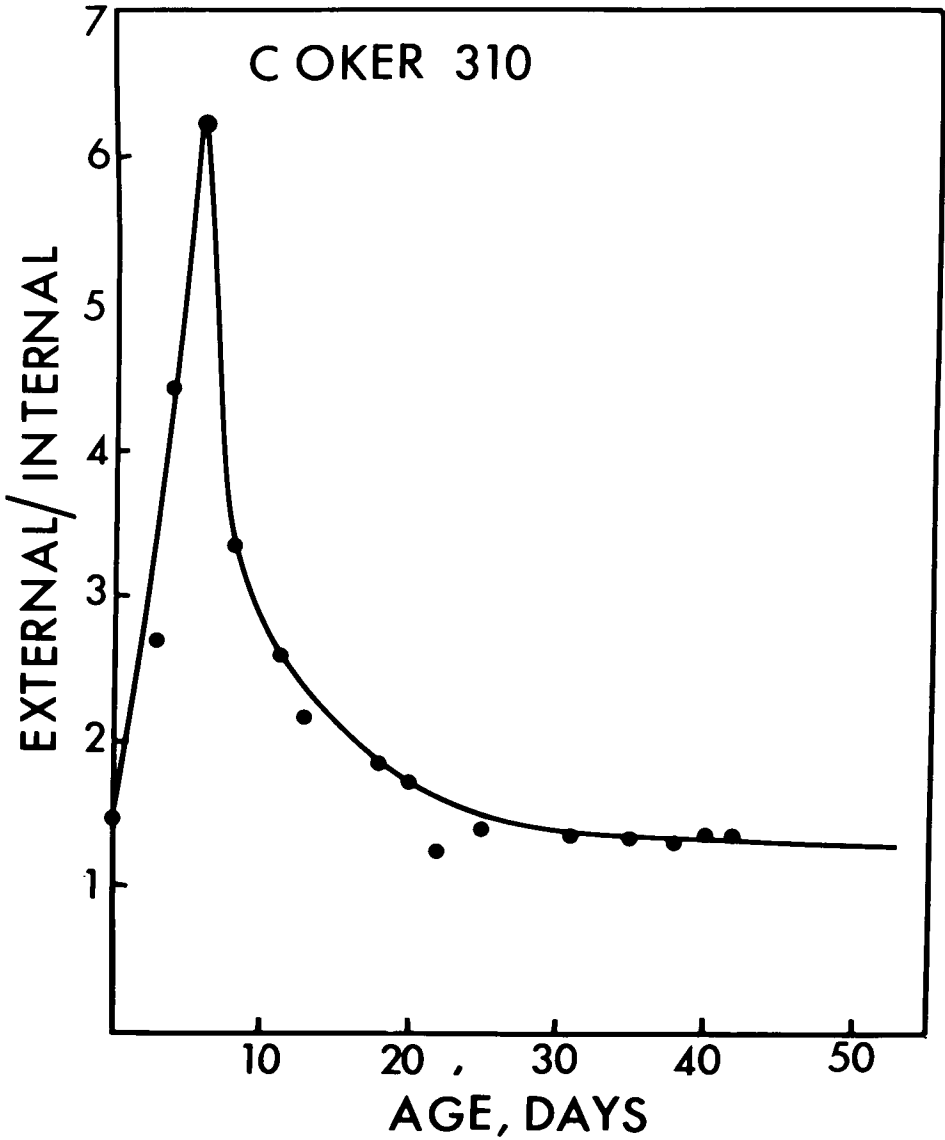

Figure 5. Ratio of external weight (fiber and outer integument) and internal weight (remainder of seed) from anthesis to boll opening in Coker 310.

somewhat faster up to about 20 DPA. From that time until maturity, the distribution of dry matter between external and internal seed parts is about equal, or perhaps internal weight gain is favored slightly, as will be seen later. Thus, three

distinct phases in the distribution of mass occur during the development of the seed. Each of these is discussed in more detail below.

**Differentiation and Potentiation of the Outer Integument**—As indicated earlier, several events, including fiber initiation, are related more to the flowering event than to fertilization. Unfertilized seeds and bolls will enlarge at the same rate as fertilized seeds and bolls until the third day after anthesis (Baert *et al.*, 1975; Cognee, 1975; see also Chapter 25). The stimulus of pollen tube growth (independent of fertilization) probably promotes and prolongs this growth.

Sufficient observations have been made on the early growth of the cotton seed to recognize that its development from -1 to 4-6 DPA is a unique stage which is almost independent of, and in no way secondary to, fertilization and the start of the embryo-endosperm complex. From Figure 5 it is evident that nearly all of the dry matter distributed to the seed during this period goes into the outer integument with its newly forming fibers. Thus, it is almost exclusively this tissue that is responding to changes in nutrition, hormonal balance and environment.

Associated with this period of development are a number of phenomena that determine the fiber (and perhaps seed) quantity and quality at maturity. Ramsey and Berlin (1976b) showed that the process of fiber differentiation can be recognized 16 hours before anthesis (see Chapter 26). Most of the fibers on the ovule, except near the micropyle, begin to expand on the day of anthesis (Anderson and Kerr, 1938; Lang, 1938; Ramsey and Berlin, 1976a; Stewart, 1975); thus, the environmental conditions preceding and during this time, no doubt, exert a strong influence on the number of fibers per unit area of seed and per seed. Worley *et al.* (1976) showed fibers per seed (F/S) to be a basic unit in the yield model of cotton. I calculated fibers per seed ( $F/S = \text{lint per seed/micronaire} \times \text{mean length}$ ) for four cultivars grown in 25 locations across the U.S. Cotton Belt and found a range of 13,000 to 21,000 among locations for a given cultivar (unpublished data). Although the number of fibers per seed were not measured directly, the large variation in calculated values does indicate that environment (location) can significantly influence the number of fibers produced. This is an area of fiber physiology that has not been examined.

A second parameter that may be strongly influenced during the period immediately following anthesis is fiber length. The information currently available on the response of fibers to hormones suggests that the potential for length is established during this period. Specifically, Beasley (1977b) demonstrated that GA greatly stimulates elongation of fibers on *in vitro*-grown ovules, but that its presence is essential only during the first few DPA. Likewise, ABA is effective in the inhibition of fiber growth only during the first 4 days of culture (Dhindsa *et al.*, 1976). IAA was effective in promotion of fiber development throughout the culture period (Beasley *et al.*, 1974). Others (Baert *et al.*, 1975; Singh and Singh, 1975) report results that substantiate those responses. In a study involving inhibitors of the phytohormones, Dhindsa (1978a) concluded that GA mainly promotes ovule

growth while IAA is mainly responsible for fiber growth. DeLanghe and coworkers (DeLanghe *et al.*, 1978) found that the morphology and size of the nucleolus within the nucleus of the young fiber were strongly influenced by GA, auxin and ABA. There was a correlation between nucleolar size at 8 DPA and final fiber length (however, maximum nucleolar size was attained at 5 DPA). They suggested that GA is the potentiating stimulus (production of ribosomes) and that IAA is the actuating stimulus (use or output of ribosomes).

Additional support for this is found in the report of Berlin and Smutzer (1976). Fiber could incorporate  $^{14}\text{C}$ -uridine into RNA up to but not beyond 6 DPA. Also, Dhindsa (1978) found that 5-bromo-2-deoxyuridine, a thymidine analogue, inhibited fiber production, but only during the first 6 days of culture. Since GA is effective only during the few days after anthesis, this strongly indicates that the total potential for fiber length is determined during this period. (More detailed accounts of fiber development are covered in Chapters 23, 25 and 26). Cytokinins apparently do not have a major influence on the growth of the external part of the seed at this time (Beasley, 1977b; Beasley *et al.*, 1974), but may be related to internal events (see below).

Other phenomena concerning the external ovule parts are associated with this period before the endosperm-embryo complex is well established. Stomata develop on the ovules in large numbers, especially on the chalazal end, before the fibers begin to enlarge (Ayyangar, 1948; Stewart, 1975). Although no direct relationship has been demonstrated, it is an attractive hypothesis that these stomata function in the uptake of  $\text{CO}_2$  for incorporation by the PEP-carboxylase pathway into malate. This pathway and organic acid are apparently important in the expansion of the fiber (Dhindsa *et al.*, 1975). Also, there is a high concentration of malate in the liquid endosperm which develops up to about 12 DPA. Mauney *et al.* (1967) found that ammonium malate was beneficial to the *in vitro* culture of very young embryos. Whether the stomata function for the exchange of  $\text{CO}_2$  in the synthesis of these malate pools (fiber, endosperm) should be investigated.

Cell division in the epidermis (and probably the entire integument) accounts for the increase in surface area up to 6 DPA. Thereafter, very few divisions occur, and any increase in ovule surface area is accomplished by cell expansions (Berlin, 1977). Information presented by Berlin (1977) indicates that the non-fiber cells of the epidermis undergo between 2 and 3 cycles of division during the 6-day period. Cessation of division corresponds closely with the initiation of fuzz fibers (Lang, 1938).

**Endosperm**—An interesting feature of reserve storage occurs in the outer integument at anthesis. The preanthesis ovule contains very little starch; however, during the 24 hours preceding expansion of the fibers, starch begins to accumulate in the outer integument (Baranov and Maltzev, 1937; Stewart, unpublished). One could say teleologically that the plant has placed a reserve there for the growth of the fibers that soon start to expand. In reality, the starch does not

appear to be metabolized during elongation but continues to be accumulated and stored up to 20 DPA. The ultimate distribution of this reserve is unclear, but the integument during the latter part of development contains no starch. Since there is a very rapid accumulation of the starch during the 24-hour period before anthesis, a plausible method to determine the use of this reserve would be to pulse label it with  $^{14}\text{C}$  at that time. Assuming a low level of turnover, the redistribution of the label could be followed after the 3-week period.

As can be seen, most of the activity of the cotton ovule during the first few days after anthesis is associated with the external part. Internally significant events occur which initially do not alter photosynthate distribution, but later have profound effects. Some of the changes have already been mentioned. Briefly, the free nuclear endosperm begins to develop almost immediately after triple fusion (1 DPA). As the endosperm develops, the nucellar material is consumed. The fertilized egg contracts and does not divide until 3 to 4 DPA. Continued divisions during the globular stage result in small cells with little increase in embryo size (Jensen, 1963; Pollock and Jensen, 1964).

Although a role for cytokinins in early ovule growth has not been demonstrated unequivocally by exogenous application, Sandstedt (1971) detected cytokinin activity in 1 DPA boll contents. This activity peaked at 4 DPA, was level to 8 DPA, then declined to an undetectable level by 15 DPA. He suggested that there was a causal relationship between the activity he detected and the observations of Pollock and Jensen (1964) concerning zygote division. Another possible correlation not considered by Sandstedt (1971) is cytokinin activity and endosperm activity. Free nuclear divisions occur rapidly from 1 DPA and continue in a pattern similar to the activity level reported for cytokinin. By 15 DPA, the endosperm is largely cellular. Whether cytokinins are produced within the ovule by the endosperm-embryo complex or transported into the ovule is unclear. The former suggestion is supported (but not proven) by the fact that the unfertilized polar nuclei can be induced to fuse and divide by ovule culture in GA and IAA without cytokinin (Jensen *et al.*, 1977).

The development of the endosperm-embryo complex signals the end of the differentiation and potentiation stage of the integument. Marked changes occur in the growth patterns of the ovule. Evidence indicates that IAA is the actuating hormone and that it is produced by the new complex (see Chapter 23). The new pattern of growth can properly be called the enlarging phase.

**Enlarging Phase**—Figure 5 shows that the ratio of external to internal weight begins to decline during the second week of development. This corresponds to the period in which rapid expansion of the ovule and fiber occurs. Stewart and Kerr (1974) showed that the increase in fiber length ( $L$ ) during this period was allometrically related to the increase in ovule volume ( $V$ );  $L = \beta V^\alpha$  or  $\log L = \log \beta + \alpha \log V$  (Figure 6). The  $\alpha$  and  $\beta$  are the growth parameters. The slope ( $\alpha$ ) of the lines for eight cultivars over three environments varied more among

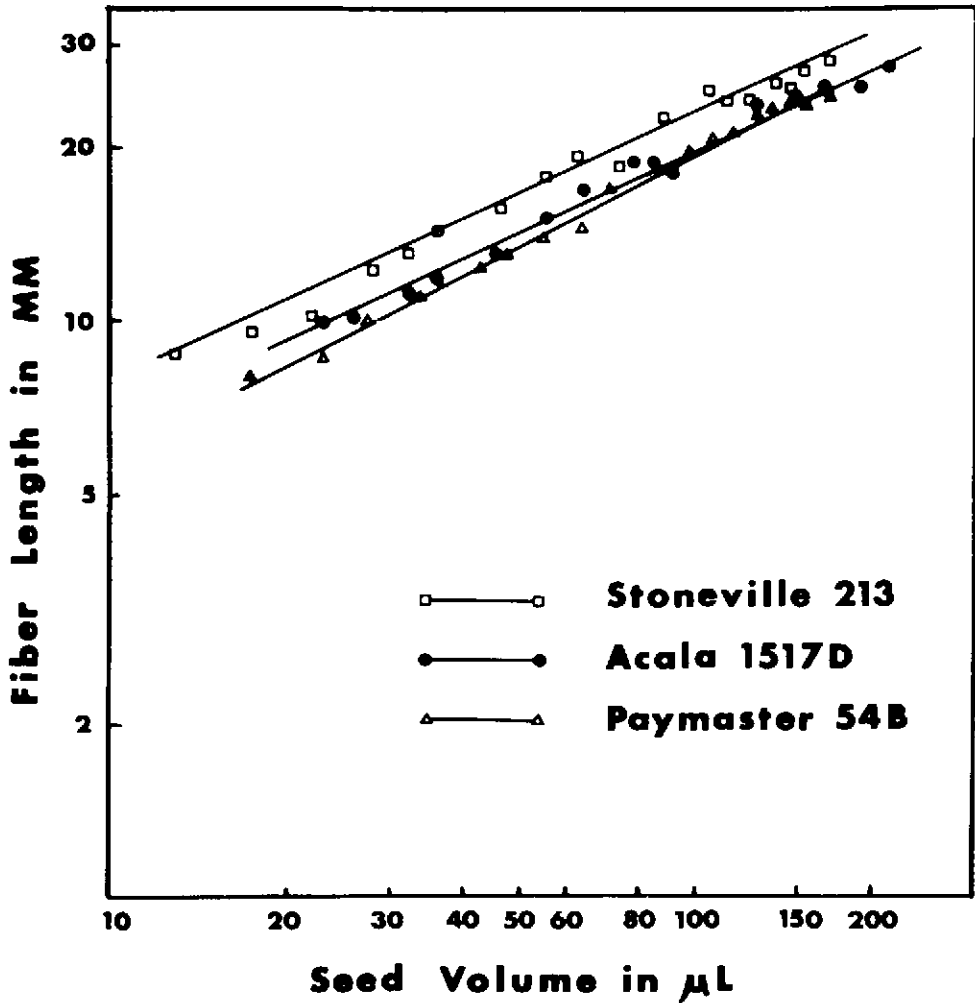

Figure 6. Relation of fiber length to seed volume during the enlargement phase (log transformation).  $L = \beta V^\alpha$  or  $\log L = \log \beta + \alpha \log V$ . Length varies approximately as the square root of volume (Stewart and Kerr, 1974).

environments than among cultivars. The variation in  $\beta$  was about the same for cultivars and environment (Stewart, 1974). The  $\beta$  value represents parameters such as initial ovule size, time of fiber initiation and rate of enlargement of both ovule and fiber during the first week after anthesis.

Figure 7 shows the relative weight distribution between external and internal seed parts beginning the second week postanthesis up to 50 DPA. The results are expressed on a log-log scale for convenience. The cultivars Coker 310 and Dixie

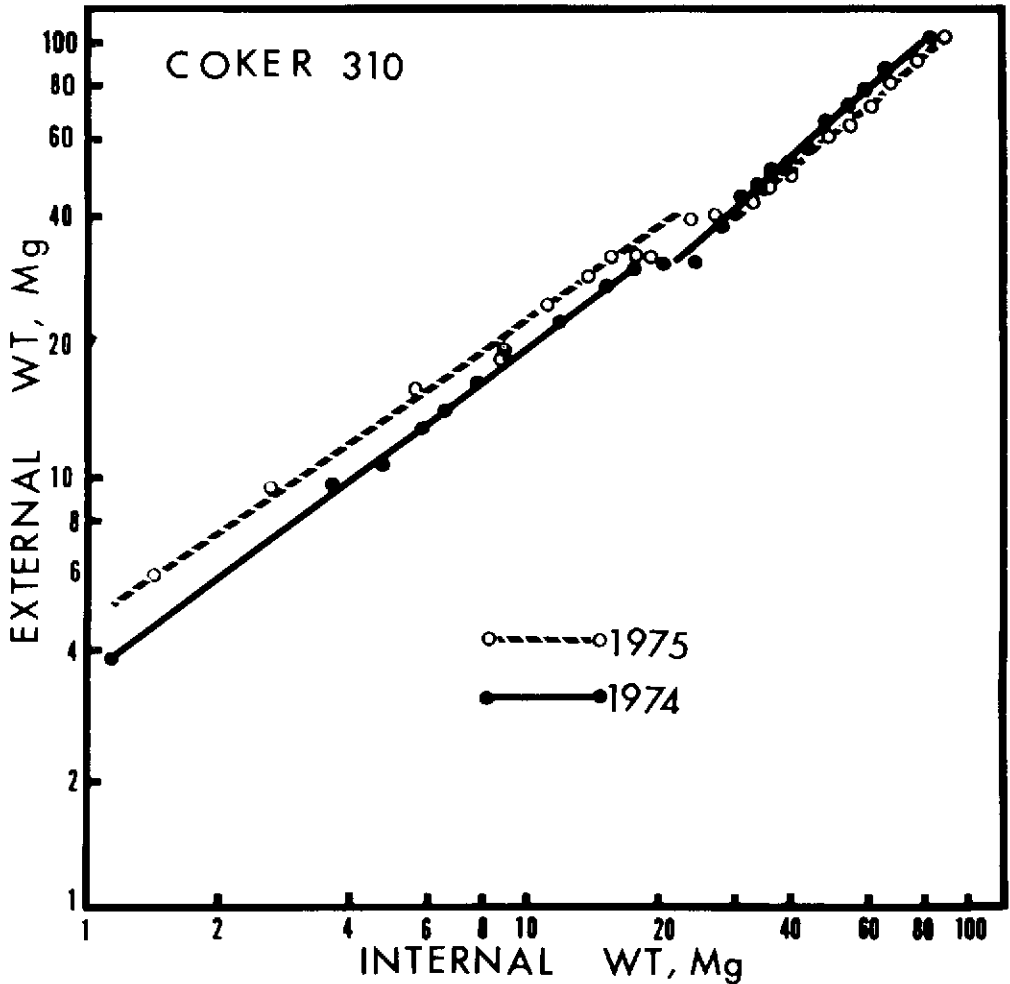

Figure 7. External weight versus internal weight of Coker 310 during the enlarging and accumulation stages. Two patterns of weight distribution are evident between the two stages.

King III (not shown) gave almost identical patterns for the 2 years. At about 45 mg total ovule weight (approx. 16-17 DPA), there was a hiatus in weight accumulation in the external part of the seed but not in the internal part. Reference to Figure 4 shows that the endosperm and palisade were accumulating weight at this time. After the pause, the fibers began to accumulate mass again but with a new distribution relationship compared to the previous distribution of mass.

The lower part of the curve in Figure 7 represents weight distribution during

the second and third week of growth. The slope of this line is approximately 1.7, indicating that the mass distribution is about 63 percent and 37 percent to the external and internal parts, respectively. This represents a considerable increase for the internal part of the ovule which was receiving only about 10 percent during the first 7 DPA.

The major structural additions to the external part are the initiation and development of the fuzz fibers, which begin at the start of the phase (Lang, 1938), and the length increase of the lint fibers. Also, it is likely that secondary cellulose deposition begins in the fibers during the latter part of this period (Schubert *et al.*, 1973). The non-fiber epidermal cells expand laterally and begin secondary deposition in conjunction with the fibers (Berlin, 1977). The outer integument does not increase in depth, but apparently the cells expand laterally and retain, and perhaps increase, their starch content (Baranov and Maltzev, 1937; Joshi *et al.*, 1967).

The development of the embryo with its associated endosperm has been examined by a number of individuals and groups (Baranov and Maltzev, 1937; Irvine, 1957; Joshi *et al.*, 1967; Pundir, 1972; Reeves and Beasley, 1935). There is little disagreement in the general sequence of events among these reports and only minor differences in the timing of events. The following descriptions on the embryo and endosperm are generalized concepts from the above works.

The internal part of the seed has the greatest structural changes during this period. At first the inner integument greatly expands and accumulates starch. The free nuclear endosperm also increases in size, and the embryo develops to the heart stage. The "liquid" of the endosperm has a high osmolarity. This is due mainly to malate salts (Mauney *et al.*, 1967) and probably simple sugars including fructose (Conner *et al.*, 1972). Unlike the fibers (Beasley *et al.*, 1974), the embryo apparently can utilize fructose (Mauney, 1961).

The endosperm-embryo complex is the only tissue undergoing mitosis during the second week of development. Around 10 DPA, the endosperm starts forming cell walls around the nuclei, especially in the micropylar area around the embryo. The sequence of this phenomenon suggests that the stimulus originates with the embryo. By the end of the third week, the endosperm is cellular and no additional divisions occur.

Shortly after the embryo is encased by cellular endosperm, it begins to elongate and form the cotyledons. Generally, by the end of the third week the cotyledons begin to enfold and the embryo begins to accumulate storage products. Also, the endosperm begins to be absorbed by the embryo. The maximum length of the embryo is obtained within a few days (ca. 25 DPA).

Coincident with, and perhaps related to, the changes occurring in the endosperm, the outer epidermis of the inner integument elongates to form the palisade layer which becomes the main protective layer of the seed coat. The stimulus that promotes this unique development is unknown. Secondary deposition in the palisade layer may precede or, at the very least, coincide with the onset of cellulose

deposition in the fibers and outer epidermal layer. The inner epidermis of the inner integument also acquires secondary deposition and eventually becomes the fringe layer.

During the enlarging phase of growth the hormonal interactions of the ovule do not seem quite as complex as the period immediately following anthesis. Auxin needed for the continued expansion of the fibers and ovule is probably produced by the endosperm-embryo complex. Excessive proliferation of integument cells has been related to exogenous GA treatments in several instances (Beasley, 1977b; Joshi and Johri, 1972; Stewart and Hsu, 1977b). Some notes may be related to excessive integument growth *in vivo* (Cognee, 1975; Joshi *et al.*, 1967). Most likely control of differentiation is maintained by a combination of IAA and ABA. These hormones are known to inhibit GA-mediated callus growth of the integuments (Beasley, 1977b; Stewart and Hsu, 1977b). Davis and Addicott (1972) showed that ABA in the young boll increased rapidly from 5 DPA to a maximum at 10 DPA. The amount in the lint and seed declined to near 0 by 15 DPA. Recall that fiber production was not affected by ABA after 4 DPA (Dhindsa *et al.*, 1976). Thus, the ABA may regulate integument development during this period. The influence of ABA on early embryo development *in vivo* is unknown, but there is evidence with somatic embryogenesis that it maintains the development of the embryoids in a more normal pattern of development compared to the absence of ABA (Ammirato, 1974). The absence of ABA at 15 DPA may permit elongation of the embryo. Onset of secondary deposition may also be related to the absence of ABA at this time (see Chapter 23).

C.A. Beasley and his coworkers have done extensive work on the responses of cultured cotton ovules to variations of minerals, carbohydrates and vitamins as well as the major hormones. The interested reader should refer to two reviews (Beasley, 1977b; Beasley *et al.*, 1974) for indepth discussion of their culture methodology and for more detailed discussions concerning hormonal interactions within the cotton ovule (see Chapter 39).

**Accumulation Phase**—During the latter part of the enlargement period accumulation begins, but apparently the two phases are not exclusive. Benedict and coworkers (Benedict *et al.*, 1972; Schubert *et al.*, 1976) showed that elongation of the fibers continues until about 25-26 DPA. Reeves and Beasley (1935) and Pundir (1972) indicate that the full length of the embryo is not achieved until about that same time, even though accumulation of reserve material begins several days earlier. The information at this point suggests that the two processes are independently regulated, but serious investigation of this area is lacking.

The relative distribution of mass during the time that enlargement and accumulation coincide reflects the latter phase. The break between the curves in Figure 7 occurs at about the developmental stage that accumulation of cellulose and embryo reserves starts (16-17 DPA). The slope of the line for the new distribution relationship is approximately 0.9. This means that 47 percent of the



mass is accumulating in the external part of the seed and 53 percent goes to the embryo. Reference to Figure 4 shows that the palisade is the main recipient of mass internally until about 30 DPA. During this time the gain in embryo weight is approximately matched by loss in endosperm weight. After 30 DPA, the embryo weight surpasses that of the endosperm and all additional weight changes internally are explained by embryo weight increases. Externally, essentially all mass accumulation is in the fibers (including the fuzz fibers). From this relationship, it is easy to see why immature seeds generally have a higher lint percentage than mature seeds (Meredith *et al.*, 1967; Walhood and Counts, 1955). The longer a seed accumulates mass, the greater will be the absolute amount in the embryo. Also, data presented by Walhood and Counts (1955) indicate that mass continues to accumulate in the seed (seed index) after the fibers reach maximum weight (fiber index).

During the development of the embryo, the 30 DPA to 32 DPA period is one that has attracted considerable interest, speculation and controversy. In order to explain certain results of their experiments with precocious germination and mRNA synthesis in developing embryos (see Chapter 28), Ihle and Dure (1972) proposed that the vascular connection between the ovule and parent plant atrophies at 32 DPA. Subsequent weight gain of the embryo supposedly would come from the rest of the ovule. In subsequent communications (Dure, 1975) the tenuousness of the proposal was overlooked, and it reached a wide audience and acceptance outside the cotton discipline. However, Benedict *et al.* (1976) adequately demonstrated that  $^{14}\text{C}$  was transported into the seed up to 45 DPA (see Chapter 22). The results of Figure 4 support those of Benedict and coworkers and show that the remainder of the ovule, with the exception of the endosperm, does not lose weight to the embryo. An interesting feature can be seen in the weight changes of the embryo and endosperm. At about 30-32 DPA the embryo weight exceeds that of its supporting environment. Perhaps the restraints Ihle and Dure (1972) attributed to the parent plant reside in the endosperm and as this tissue is lost, the restraints are removed. That germination after 30 DPA is inhibited by ABA is well established (Davis and Addicott, 1972; Dure, 1975; Halloin, 1974). Davis and Addicott (1972) showed that ABA in the developing seed and boll is near zero at 30 DPA but increases rapidly to 40 DPA. The level of ABA in the seeds declines with age thereafter, but continues to increase in the carpel wall until boll dehiscence. The ABA within the seed is probably in the integuments since embryos removed from the seed will germinate (Dure, 1975).

While the external part of the seed accumulates only cellulose, the embryo accumulates both lipids and proteins. The proteins are generally accumulated first in association with the elongation of the embryo and then at a more or less continuous rate associated with the weight increase of the embryo (Elmore and Leffler, 1976; El-Nockrashy *et al.*, 1976; Grindley, 1950; King and Leffler, 1979). There is a low but progressive accumulation of polar lipids during embryo development. The neutral lipids, which constitute the bulk of the storage reserve,

increase rapidly in the seed from about 26-30 DPA to about 45 DPA and then increase only slowly (Brown and Kurtz, 1949; El-Nockrashy *et al.*, 1976; Grindley, 1950; Touma-Touchan, 1977).

**Maturation and Boll Opening**—The final period in boll development has not received the attention other periods such as the enlargement phase have received, and often it is not recognized as a time during which significant changes occur. Overall mass accumulation declines, probably with oil being the only carbon reserve that continues to increase (Brown and Kurtz, 1949; El-Nockrashy *et al.*, 1976; Grindley, 1950; Tharp, 1948; Touma-Touchan, 1977). The accumulation of cellulose in fibers apparently stops before reserve accumulation ceases in the embryo (Walhood and Counts, 1955).

Other changes occur during the maturation period. Active accumulation of minerals, in contrast to photosynthate, continues in the embryo; however, minerals in the carpel walls and in the fibers generally decline (Leffler and Tubertini, 1976; see also Chapter 21). Water-soluble nitrogen, including protein and small peptides, increases in the embryo, whereas accumulation of storage protein ceases (King and Leffler, 1979). Also, dramatic changes in the level of certain enzymes occur during this period (see Chapter 29).

The hormones in the fruit may play a significant role in maturation. The ABA concentration is high in the carpel wall and continues to increase during the maturation period; however, the amount of ABA in the seeds declines during this period (Davis and Addicott, 1972). It is not known if the decline in ABA in the seed is related to other observed changes. In the carpel walls the ABA increase may stimulate ethylene production and dehiscence of the boll. Ethylene production by the fruit increases abruptly during the maturation period (Lipe and Morgan, 1972a).

The final maturation of the seed coat occurs immediately before and during capsule opening. The various layers of the seed coat are not cemented together well and remain permeable to water until oxidative processes occur (Hallowin, 1976b). Coloration of seed coats is apparently due to enzymic oxidation of catechin, and the development of impermeability to water requires  $O_2$ . In "hard" seed the oxidation process extends across the chalazal end, whereas normal seed take up water easily in this region (Christiansen and Moore, 1959). A "hard" seed condition may also result from a high level of ABA in the seed.

The stimulus that triggers the sequence of events leading to boll dehiscence is not known. One would expect that the progression to maturity in the seed would control events in the carpel wall. Ray (1963) found that the boll period of parthenocarpic bolls was 4 days less than fertile bolls. He suggested that dehiscence of capsules was independent of seed maturity. However, that the seeds delay dehiscence cannot be ruled out. In either circumstance, the results suggest that dehiscence can be controlled independently of seed maturation. This may have significance in developing techniques for green boll harvesting.

Once the sutures of the carpels separate, the walls begin to dry and reflex open. The vascular system is tangential to the carpel in the inner part but radial in the middle and outer parts of the carpel wall. Upon drying, the outer part can contract more, hence the walls reflex outward (Baranov and Maltzev, 1937; Simpson and Marsh, 1977).

### ENVIRONMENTAL INFLUENCES

Boll development is controlled by the genetic-environment interaction. While recognizing that there is considerable genetic diversity among cultivars, in the following discussion I will attempt to give general physiological trends that occur in response to changes in the environment. Obviously all plant responses are to the total environment, but for simplicity the environmental parameters are divided into water, mineral and temperature effects.

**Water**—As discussed earlier, during the first 14 DPA the primary response of a young boll to stress is abscission. If water stress occurs after that time, the boll generally does not abscise (McMichael *et al.*, 1973). Since bolls are extremely resistant to water loss and can be considered non-transpiring (McMichael and Elmore, 1976; Radin and Sell, 1975), they are less susceptible to dehydration than leaves. The bolls exhibit 3 to 5 bars higher potential than the leaves, but their diameters will fluctuate with water status (McMichael and Elmore, 1976).

Moisture level during the fruiting cycle of the cotton plant does not affect all parts of the seed equally. During the enlarging stage a stress will reduce fiber length; conversely, irrigation will increase length slightly (Antony and Kutty, 1975; Bennett *et al.*, 1967; Hearn, 1976; Newman, 1967; Spooner *et al.*, 1958). The effects of water availability on the seed at this stage have not been determined directly. Also, these effects cannot be deduced from published reports since the customary measure is seed index, which is determined by both the enlargement and accumulation phase. However, one would expect seed volume to vary with available moisture much the same as fiber length.

Overall, seed index is probably more sensitive to moisture stress than the commonly measured parameters of fiber quality such as length and micronaire (Longenecker and Erie, 1968). This is indicated by the observation that cotton produced under dryland conditions generally has a higher lint percentage than irrigated cotton. Newman (1967) found higher micronaire values under non-irrigated culture and Bilbro (1962) found no differences compared to irrigated. However, under severe water stress, low micronaire values and immaturity of fibers can result (Antony and Kutty, 1975).

The relationship between water availability and percent oil in the seed has long been recognized (Anonymous, 1918). Stansbury *et al.* (1954) found a highly significant correlation of 0.59 for oil content and rainfall during the accumulation period. Correlations between oil percent and rainfall during the enlarging period were much less and were non-significant.

As with most environmental factors, the percent protein in the cottonseed seems to be less affected by water stress than by other seed parameters. However, environmentally controlled experiments are lacking in this area.

**Mineral Environment**—The influence of the mineral environment on cotton fruit development has been examined primarily as the response to fertilization under production conditions. Specific physiological studies of the essential elements usually are limited to yield, but some information on quality parameters in relation to fertilization is available. These studies were reviewed previously by a

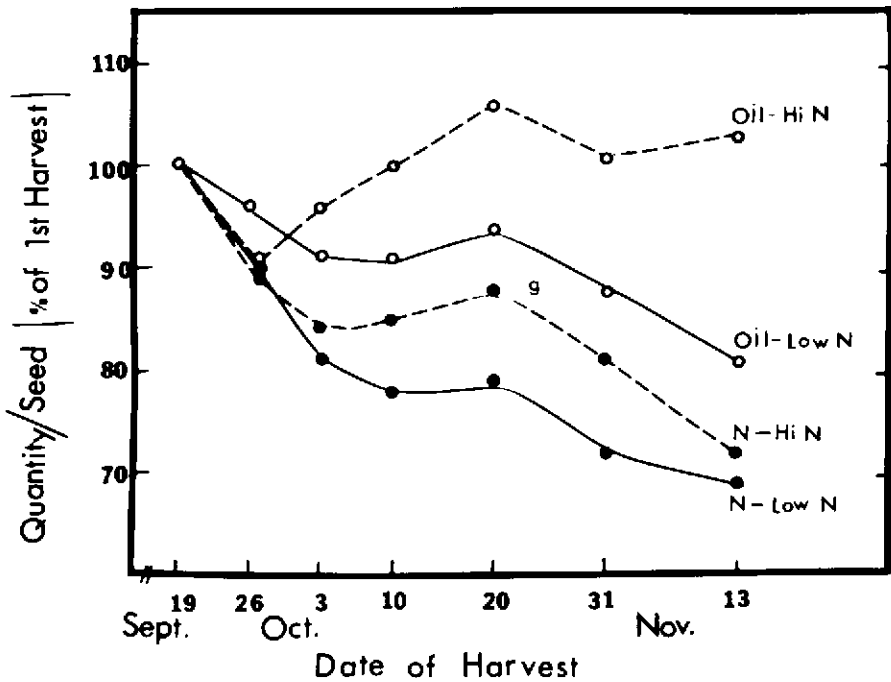

Figure 8. Percent change of seed oil and protein from first harvest to last harvest at high and low nitrogen fertilization. High N reversed the decline in oil but not protein. Results calculated from data given by Leffler *et al.* (1977).

group of authors in another symposium (Elliott *et al.*, 1968). Tharp (1960) presented a general treatment of the response of cotton to essential nutrients. In Chapter 9, Joham discusses the effects of minerals on the relative fruitfulness of cotton; in Chapter 21, Leffler discusses the accumulation and distribution of minerals in the fruit. In view of the availability of information elsewhere, my

discussion will be limited to generalizations and recent observations.

Nitrogen relationships in the developing boll are not yet completely understood. When comparing responses to adequate versus deficient nitrogen supply, the following are usually observed: increases in seed per boll, fiber length, lint weight, seed weight and seed nitrogen, but decreases in percent oil and in the ratio of lint to seed (Elliott *et al.*, 1968; Tharp, 1960). The increases are probably related to the general increase in vegetative vigor of the plant in response to N fertilization. The increase in seed nitrogen is due almost entirely to increase in storage protein (Leffler *et al.*, 1977).

The decrease in percent oil does not necessarily indicate a decrease in oil per seed. In fact, the absolute amount of oil probably increases. Tharp *et al.* (1949) and Leffler *et al.* (1977) noted that conditions that result in high protein may result in high oil content per seed. (The former authors pointed out the need for biologists to express oil and protein concentrations of the cotton seed as amount per kernel or amount per seed rather than the percent of seed used by industry.) Leffler *et al.* (1977) compared percent protein and percent oil of cottonseed from plants grown under high and low nitrogen fertility for different harvest dates. Also, from their data I calculated quantity per seed of oil and protein. As expected, percent N and N per seed increased with high-N fertilization, but they both declined from bottom harvest (early) to top harvest (late). Percent oil was decreased by high-N compared to low-N, but the percent increased from bottom to top harvest regardless of N. Oil per seed was reduced by high-N in the bottom harvest, but the relationship was reversed in the middle and late harvests. As a result of the treatment-environment-boll position interaction, total reserve per seed decreased in the low-N but not in the high-N as the season progressed. The effect of high-N was to maintain a high level of oil accumulation throughout the season. The percent changes of oil and protein with date-of-harvest at high and low-N are shown in Figure 8.

Although lint per seed increased with N fertilization, the observed decrease in lint percentage indicates that seed weight is increased more than lint. Fiber maturity is not significantly changed by nitrogen supply unless it is excessive, in which case micronaire is decreased (Hearn, 1976; Koli and Morrill, 1976). The influence of nitrogen on fibers per seed is not known; however, MacKenzie and van Schaik (1963) reported that N increased lint index (LI) but did not change length (M) or micronaire (Mic) under their conditions. Their observations indicate that the number of fibers per seed increased since  $LI = M \times Mic \times F/S$ .

All nutrient supply to the boll must be viewed in terms of active transport, since there is essentially no transpiration stream to carry minerals passively (McMichael and Elmore, 1976; Radin and Sell, 1975). This is particularly notable when the cotton plant receives nitrogen (N) as nitrate. No nitrate occurs in the ovules, and almost all N supplied to the developing seed is in reduced form (Radin and Sell, 1975). Evidence strongly indicates that the major form of N transported into the seed is asparagine (Elmore and Leffler, 1976).

There are a number of indications that the ammonium ion ( $\text{NH}_4^+$ ) is critical to developmental events in the ovule. Beasley (1977a) found that the response to IAA of cultured ovules was qualitatively influenced by  $\text{NH}_4^+$ . I noted (unpublished data) a synergistic response between  $\text{NH}_4^+$  and callus induction from cultured ovules by ethephon (Stewart and Hsu, 1976). Stewart and Hsu (1977a) found that the ammonium ion was critical for the *in ovulo* culture of embryos. All these reports demonstrate that seed development is influenced by the availability of the ammonium ion. How this ion functions is not known.

Potassium (K) availability is closely associated with seed development and strongly influences the quality parameters of the mature product. Where K is deficient, addition of the mineral will increase mean fiber length and length uniformity (Bennett *et al.*, 1967; Sabino, 1975; Tharp, 1960). These observations are understandable since K is the counter-ion for malate in the elongating fiber (Dhindsa *et al.*, 1975). Potassium malate probably acts as the major osmoticum for fiber expansion; thus, an adequate supply should assure that all fibers reach their maximum potential. Beasley *et al.* (1974) found that high levels of  $\text{KNO}_3$  were beneficial to ovule and fiber growth *in vitro*. A high level of  $\text{KNO}_3$  was also used for *in ovulo* embryo culture (Stewart and Hsu, 1977a).

During the accumulation stage of seed development, K may increase fiber micronaire (Sabino, 1975), but this response is not consistently reported. Perhaps the most consistent response to K fertilization is an increase in the percent oil and oil per seed (Tharp *et al.*, 1949). Seed weight is usually increased. Potassium is intimately involved in transport of photosynthate from the leaves to the bolls and decreases in the K content reduce both the quantity and distance carbohydrates move (Ashley & Goodson, 1972). With a deficiency of K, the symptoms of low carbohydrate status can be expected.

Phosphorus (P) generally does not have a major impact on seed development. If sufficient P is available for the fruiting form to remain on the plant, there is a sufficient amount for seed development. Sabino (1975) found that P fertilization increased fiber length slightly. The main role of P in fiber growth would be in sugar metabolism and in membrane synthesis. The major increase of P occurs in the seed during the accumulation phase (see Chapter 21). More than 80 percent of this accumulation at maturity occurs as phytin (Ergle and Guinn, 1959). The accumulation of P is not important in terms of seed processing/utilization quality but may be extremely important in planting seed quality. This apparently has not been investigated.

Information on the specific effects of other elements on the development of boll components is limited. Liming (Ca, Mg) was found to reduce micronaire without changing length or uniformity (Sabino, 1975). Anter *et al.* (1976a,b) sprayed micronutrients at various concentrations on cotton plants before flowering and/or before (what they called) boll-setting to determine the effects on fiber quality. Zinc (Zn) had no effect; length was decreased by manganese (Mn), iron (Fe), and boron (B); micronaire was decreased by copper (Cu) and Fe but was increased by

molybdenum (Mo) and B. EDTA also increased micronaire significantly and may have increased length slightly. The soil in their experiments was calcareous, so the EDTA may have had its beneficial effect by relieving calcium (Ca) inhibition of micronaire (Sabino, 1975).

Ovules grown in culture require B for normal growth and for development of fibers (Birnbaum *et al.*, 1974). A deficiency of B may disrupt the flow of metabolites through the pyrimidine synthesis pathway (Wainwright *et al.*, 1980) and cause reduced synthesis of UDPG (Birnbaum *et al.*, 1977). UDPG is probably the major intermediate in cellulose synthesis. Thus, sufficient-to-excess B should promote fiber maturity as observed by Anter *et al.* (1976a). The influence of B on embryo development is not known. Anderson and Worthington (1971) found no effect of B fertilization on oil or protein of the seed.

**Temperature**—The influence of temperature, especially low temperature, on cotton boll and seed development has been examined more than any other environmental factor. It is well established that boll period is inversely related to temperature (Gipson and Joham, 1968a; Hesketh and Low, 1968; Morris, 1963; Yfoulis and Fasoulas, 1978; see also Chapter 5). Whether mean day or night temperature is most important depends upon the range of the temperatures in relation to the maximum and minimum. Yfoulis and Fasoulas (1978) found that night temperature must be above a certain minimum rather than a certain mean before an economically acceptable boll-period results.

Other physiological factors not related to temperature influence boll period. Morris (1963) found that the physiological age of the plant when a boll sets has a strong influence on the boll-period. Also, there is great variation in the boll-period of fruit set the same day. Specific reasons for this variation have not been determined but are conveniently explained away as differences in microclimate.

Field experiments (Meredith *et al.*, 1967; Turner *et al.*, 1979; Verhalen *et al.*, 1975) indicate that most of the boll parameters other than seeds per boll (S/B) decline with the season. The declines are usually attributed to the cooler temperatures the cotton crop experiences in the latter part of the growing season. Quisenberry and Kohel (1975) quantified environments by daily and accumulated heat units (HU = mean temperature minus 18.3C). Correlation and regression analyses between HU and boll parameters showed that fiber weight per seed, micronaire and seed size were highly correlated to HU as expected. The maximum temperatures in the three environments they examined were not exceptionally high.

Gipson and coworkers (Gipson and Joham, 1969; Gipson and Ray, 1968, 1969a; Chapter 5) examined the influence of night temperature on fiber elongation. They concluded that the initial stages of fiber elongation were highly temperature-dependent, whereas the later stages appeared to be less sensitive to temperature. Their conclusions are justified when fiber initiation is included as a part of fiber elongation. However, close examination of their data revealed that no

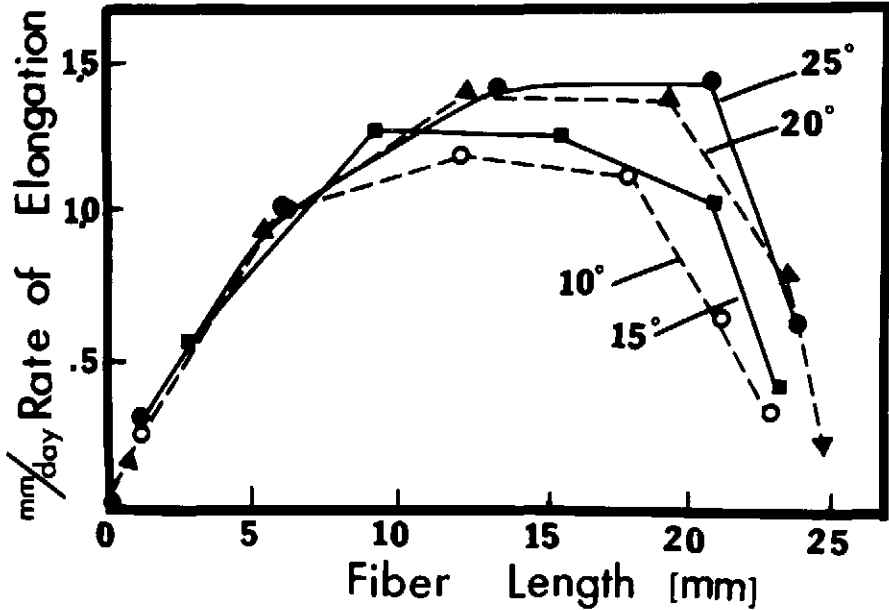

Figure 9. Rate of fiber elongation as a function of length at various night temperatures. Elongation of short fibers is relatively independent of night temperature. Results calculated from data given by Gipson and Ray (1968).

fiber growth was detected for a number of DPA at the lower night temperatures. Therefore, elongation-rate-per-day of fibers at the higher temperatures was being compared to a zero rate at the lower temperatures since there were no fibers. When their data (Gipson and Ray, 1968) for elongation rate were plotted against similar physiological stages of fiber development (length), the early stages of elongation seemed to be independent of night temperature while the later stages became more affected (Figure 9). The novel feature of their data is that fiber initiation (as opposed to elongation) seems to be very sensitive to night temperature.

High temperatures can have a detrimental effect on boll development. Turner (unpublished data) compared boll characteristics of three cultivars grown for 2 years in the Imperial Valley (hot) and the northern San Joaquin Valley (mild) of California. The cotton grown in the Imperial Valley had reduced boll size, seed index, weight per seed, seeds per boll, lint percent and mean length. Micronaire was higher in the hot environment of the Imperial Valley. Stockton and Walhood (1960) also found that boll size and fiber length decreased with increasing boll temperature but maturity increased. Since both low night temperature (Gipson



and Joham, 1968b; Gipson and Ray, 1969a) and high temperature reduce lint length, the response is hyperbolic. Boll weight also is related to temperature in a hyperbolic fashion, with the maximum occurring around a 20-22C night temperature and a day temperature less than 30C (Gipson and Ray, 1970; Hesketh and Low, 1968). Gipson and Ray (1976) found that lint index, lint percentage and lint per boll were decreased by high (37C) or low (13C) night temperature. Contrary to other reports, they found that seed index was increased by high night temperature (however, their day temperatures were probably less than 30C). All reports agree that micronaire is linearly related to temperature.

Information concerning the influence of temperature on embryo development is meager. Gipson and coworkers (Gipson and Ray, 1970; Gipson *et al.*, 1969) found that seed N content was linearly related to night temperature. Percent oil tended to respond hyperbolically, with the optimum being near 20C. Stansbury *et al.* (1954) examined eight cultivars at 13 locations for 3 years and found the correlation of percent oil to maximum temperature to be  $r = 0.57^{**}$ . Low temperature changes the ratio of simple sugars and the time of maximum accumulation in the seed (Conner *et al.*, 1972). The rates of accumulation of minerals and reserves are also altered by low temperature (Kreig *et al.*, 1973). Other than time required to develop, qualitative changes in the seed are difficult to recognize. However, certain interrelationships discussed below suggest that temperature (and other environmental factors) cause qualitative as well as quantitative changes.

## COMPETITIVE INTERACTIONS

Many events and structures are involved in the development of the mature cotton fruit. Those events or structures which develop simultaneously compete for a share of the available mineral and photosynthate within the constraints imposed by the genetic complement and any differential response to environment that may exist. In addition, there is the possibility that the competitive results of one developmental sequence may influence the results in a subsequent sequence. For example, the number of fibers per seed which develop during initiation might influence the mean fiber length during enlargement, and these two in turn influence the amount of cellulose deposited in each fiber during accumulation.

The influence of some of these interactions can be detected in the mature harvested product. However, caution must be exercised in the interpretation of correlation analyses involving events that are separated temporally (environmentally) or involve multiple interactions. Almost no studies are available in which environment is controlled, but in some situations partial regression analysis has been used to separate the relative contribution of the various factors that influenced an observation. When two unrelated factors are influenced in parallel, they will give a positive correlation. That is, two parameters may be correlated but not related. Relatedness must be determined on the basis of their developmental history.

The obvious overall area of competition is between fruits. When the plant acquires a "boll load," the competition is such that no new fruit can set (see Chapters 2 and 12). Schubert *et al.* (Chapter 22) showed that sink demand will determine the distribution of carbohydrate. Since older bolls have the highest demand, new fruit is discouraged, and a boll in the accumulation stage will be at an advantage to one in the enlarging stage. Sink demand may explain the observations of Kittock *et al.* (1979). They estimated the effects of bolls at branch node 1 on bolls at other branch nodes. When branches had 2 or more bolls, the boll at node 3 averaged 8 percent fewer seed, 9 percent lower weight/seed, 13 percent less lint/seed and 22 percent less lint/boll than bolls at branch node 1. About 50 percent of the reduction in seed weight and 75 percent of the reduction in S/B and lint/seed (L/S) was the result of onbranch competition.

The second level of competition occurs between the seeds within a boll. Baranov and Maltzev (1937) demonstrated that the rate of development of embryos in different positions of the lock varied greatly. The slowest-developing position was the basal one. The degree of sunlight (amount of photosynthate) strongly influenced the rate of development, also. Porter (1936) examined fiber length as a function of lock position and found that the position nearest the apex, especially in the many seeded bolls, had the shortest fibers. Seeds near the base of the boll had shorter fibers than seeds at the middle positions (Figure 10).

Although an increase in S/B should increase the sink strength of the fruit, the relationship is not linear. Kittock and Pinkas (1971) measured individual bolls of Pima and found that seed weight decreased as S/B increased. Others (Kearney, 1926; Scholl and Miller, 1976; Turner, unpublished) found a similar correlation in Pima and Upland cotton. In a study involving male-sterile lines, bolls which varied widely in their numbers of seed allowed examination of S/B effects over 5-seed increments from 5 to 40 (L. L. Ray, personal communication). Seed size and fiber-per-seed were strongly inversely related to S/B; however, there seemed to be a definite breakpoint at about 15 S/B. Micronaire, which is related to weight per unit length of fiber, was also inversely related to S/B except that the lowest seed class had a low value. Length was not related to S/B except that the lower category had the shortest length. It appeared that below a certain number of S/B, the strength of the boll as a sink was insufficient to provide for optimum growth.

Turner (unpublished data) determined correlation values for 8 cultivars at 67 or more environments. When all cultivars were examined for trends, the results in Table 1 were observed. These are generalizations concerning the direction of change of seed parameters as influenced by environment. Geneticists often use correlation analyses of diverse genetic lines to predict changes that may occur when selection pressure is placed on a given trait. A survey of a number of these (Innes, 1974; Kearney, 1926; Quisenberry *et al.*, 1975; Scholl and Miller, 1976; Woodward and Malm, 1976) revealed that genetic or intrinsic correlations do not differ greatly from the trends shown in Table 1. (Not all results were in agreement in every case, but generalizations can be made).

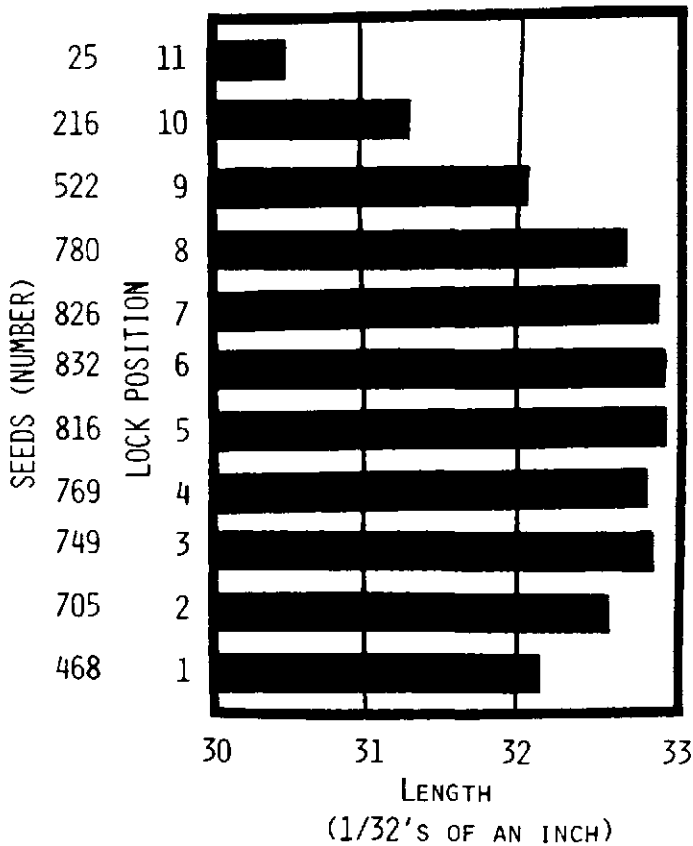

Figure 10. Influence of seed position in the lock on fiber length. From Porter (1936).

The number of S/B is negatively related to most other seed parameters. This is understandable in terms of competition among seeds. The relationship of mean length and S/B is uncertain. Turner found a high positive correlation but Ray found no correlation. The available genetic correlations were also in disagreement. All correlations show that SI or weight per seed is positively associated with fiber quality. Conditions which support good seed growth and development also support fiber development. This may be an example of the parallel influence of environment. Lint per seed (L/S) showed a negative correlation with micronaire across environments, but Quisenberry *et al.* (1975) found a positive correlation in his genetic material. Developmentally, a negative correlation would be expected.

Perhaps one of the more detailed studies of fiber interactions is that of Moore

Table 1. Trends in correlation values for 8 cultivars grown under 67 or more environments (location x years).

	<u>Mic.</u>	<u>M.L.</u>	<u>L/S</u>	<u>SI</u>
S/B	0	+	-	-
SI	+	+	+	
L/S	-	+		
M.L.	0			

(1941). He found that an increasing fiber population on the seed was associated with fiber weight decreases, with the percentage of thin-walled fibers, and with a decreasing fiber length. There was also a negative association of average fiber length and the average fiber weight per inch.

Many of the interactions involved in fiber and seed yield per seed and boll are not clear. Information of the parameter, fiber density ( $f/mm^2$ ), is lacking even though it is a basic yield component: fiber yield/boll =  $wt/f \times f/mm^2 \times mm^2/S \times S/B$  (Turner *et al.*, 1979). Also, from this relationship, it is obvious that surface area of the seed is important.

Surface area is related to seed volume, another parameter that may be important, but whose contribution is unknown. What is the relationship of seed volume developed during the enlarging stage upon kernel (embryo) weight that develops during the accumulation stage? What is the relationship of the enlarging stage to seed density?

A correlation between oil and protein in the cottonseed has been recognized for many years (Pope and Ware, 1945). Hanny *et al.* (1978) examined seed oil and seed protein across 39 genotypes and found a negative correlation. Turner *et al.* (1976a) examined four cultivars grown at 17 locations across the Cotton Belt. The correlation of percent protein with percent oil in the seed was -0.71 and highly significant. When their data were expressed as grams (g) protein vs. grams (g) oil, the correlation was 0.27 and non-significant. When oil and protein were expressed as g/g seed, the correlations were +0.79\*\* and +0.72\*\*, respectively. However, the regression coefficient for oil was 0.29 but only 0.19 for protein. This indicates that conditions which favor high seed weight will increase oil more than protein.

Turner *et al.* (1976b) found that oil percentage was positively correlated to micronaire. Developmentally, these two parameters occur simultaneously; therefore, the correlation is due to environment. The competitive interaction is not known. However, Quisenberry (personal communication) reanalyzed data of Gipson and Ray (1959b) and Gipson *et al.* (1969) and obtained estimates of the differences between seed and fiber mass accumulation at different night temperatures. The result is shown in Figure 11. At low night temperature, more seed mass accumulated than fiber mass. At high night temperature the reverse was true. In

this instance, it is clearly shown that environment can differentially change the competitive balance between two coincidental processes.

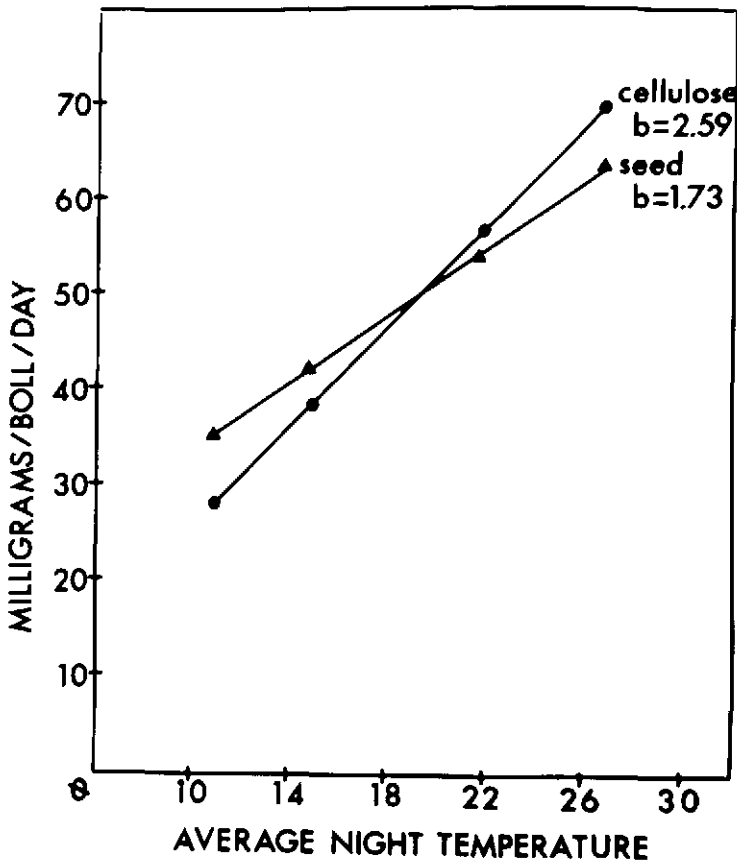

Figure 11. Influence of night temperature on rate of mass accumulation by fibers and by seeds. Graph courtesy of J. E. Quisenberry, data from Gipson *et al.* (1969) and Gipson and Ray (1969a).

### SUMMARY

The development of the cotton boll from flower induction to boll opening involves a complex series of events that are interrelated either sequentially or competitively. Each stage in the developmental sequence must reach a minimum level of completion before the next stage begins. When two or more structures develop simultaneously, they compete for the available photosynthate based on

Table 2. Developmental events in relation to days before and after anthesis.

Age	Events
-40	Floral stimulus
-32	Carpel and anther number established
-23	Ovule number established
-22	Pollen mother cell meiosis; "Pin-head square"
-14	Megaspore mother cell meiosis
-7	Begin exponential expansion of corolla
-3	Begin fiber differentiation
0	Flower open; pollen shed, germinates; fiber initiation; K accumulation in fiber
+1	Fertilization of egg and polar nuclei; division of primary endosperm nucleus; zygote shrinks
+2	Liquid endosperm developing; fibers begin elongating; most dry mass goes to fibers
+3-4	Zygote divides
+5-6	Ovule integument division stops; fuzz fibers initiated; globular embryo dividing but not increasing in size; ovule enlargement stage proceeding rapidly; dry mass to internal parts increase
+12-13	Endosperm becomes cellular around embryo; palisade cells elongate; embryo differentiation begins
+14-16	Secondary deposition in fibers, outer integument and palisade begins; embryo elongating, accumulates Ca and Mg; fibers begin slow accumulation of Ca, outer integument begins rapid weight increase
+20	Endosperm completely cellular and at maximum weight; fiber elongation slows rapidly; P translocated from fiber; embryo begins accumulating protein; weight distribution about equal between fiber and embryo
+25	Fiber elongation complete; bur weight maximum; cotyledons complete; embryo maximum length; endosperm declining; oil accumulation starts
+30-32	Embryo enters period of grand weight gain; endosperm nearly depleted; maximum rate of cellulose deposition in fiber, oil and protein in embryo; rapid P and K accumulation in embryo; fibers begin losing K
+42	Dry weight of boll nearly maximum; some oil accumulation; fibers lose Mg; cellulose deposition stops
+45-50	Internal changes in seed hormones and enzymes; seed coat hardens; boll sutures dehisce in response to ethylene

the genetic control but influenced by their previous developmental history and the current environment.

In this paper I attempt to illustrate how the various parts of the seed are related during their development and how environmental factors influence the development of the cotton fruit. An abbreviated summary of the sequence of events from flower induction to boll opening in relation to days before and after anthesis is given in Table 2. Of course, the days are approximations and can change drastically with environment. Table 3 summarizes some of the critical periods during

Table 3. Developmental periods and events particularly sensitive to competition or environmental factors.

Period (Days)	Event	Factor
-40 to -35	Initiation of floral buds	Temp., N, HOH
-35 to -30	Carpel number, maybe	
	Anther number	CHO
-25 to -22	Ovules/ovary	CHO
	Anther number	R.H.
-19 to -15	Pollen viability	High temp. R.H.
-2 to 12	Fiber density (f/mm <sup>2</sup> )	Temp, CHO
0	Anther dehiscence	Temp, R.H.
0 to 3	Rate of fiber initiation	Temp., K
	Pollen tube growth, fertilization	Temp., R.H.
1 to 14	Boll abscission	CHO, HOH
3 to 25	Fiber length, seed volume	Temp., K
15 to 45	Fiber cellulose	Temp.
25 to 50	Protein and oil accumulation; oil/protein ratio	Temp., HOH, N, K
49 to 50	Boll opening	Temp., R.H.

which an environmental stress can cause a measurable response in the development of the flower or seed.

While much is known about the overall development of the cotton boll, less is known of the specific effects of the environment on photosynthate partitioning. Also, information is limited on the relationship between sink (boll) strength and competition between elements (seeds, fibers, etc.) of the sink. For example, demand increases sink strength so, theoretically, increasing seeds/boll should increase sink strength of bolls. However, more seeds/boll is related to smaller seed so competition is increased. Many such opposing effects probably occur during development of the total crop.

The cotton fruit and seed is a unique biological system that can be used as a model for many of the questions common to all of biology. For example, the development of fibers could be used (or is used) as a model for differentiation, for K transport, for cell extension and for cellulose synthesis; the seed could be used (or is used) for seed development studies, carbohydrate utilization and partitioning and biochemical pathway analysis. Hopefully, the material presented in this discussion will stimulate interest in the potential of cotton, both as a model plant for basic research, and as a plant that still can be improved for economic gain.



## Chapter 21

# MINERAL COMPARTMENTATION WITHIN THE BOLL

Harry R. Leffler<sup>1</sup>  
USDA—ARS  
Stoneville, Mississippi

## INTRODUCTION

Compartmentation is a term often used in metabolism studies to describe the differential localization of metabolites among various areas or structures within a particular plant tissue. For the discussion of mineral nutrient compartmentation within the developing cotton boll, the boll itself will be considered as the unit tissue of interest. The major structural components of the boll—the carpel walls (the bur), the seeds, and the fiber—will be defined as the compartments within the boll.

During the first few weeks after anthesis, the boll enlarges rapidly. After a major increase during the first 3 weeks of development, the fresh weight of the boll remains relatively constant until dehiscence, when it declines rapidly. Various descriptive parameters, such as boll length, diameter, surface area, and volume, have been used as measures of boll size; each provides a similar pattern. The first 3 to 4 weeks of boll development, the enlargement phase, is the time that maximum volumes of the boll and seeds are established and most of the fiber elongation occurs. The next period of boll development, the filling phase, begins during the fourth week postanthesis. Fresh weight plateaus during this phase, but dry weight continues to increase linearly with time. The true endosperm of the seed is consumed by the developing cotyledons and embryo, while fiber development is characterized by the termination of elongation and the initiation of secondary wall formation (Schubert *et al.*, 1973). The filling phase continues into the sixth week of development, when the final period of boll development, the maturation phase, begins.

Most of the discussion of mineral compartmentation will be directed toward a description of the mineral nutrient complements of the three boll fractions and the shifting relationships among them during the filling and maturation phases of boll development. The distributions of minerals among the fractions will be

<sup>1</sup>Presently with Dekalb-Pfizer Genetics, Dekalb, Illinois

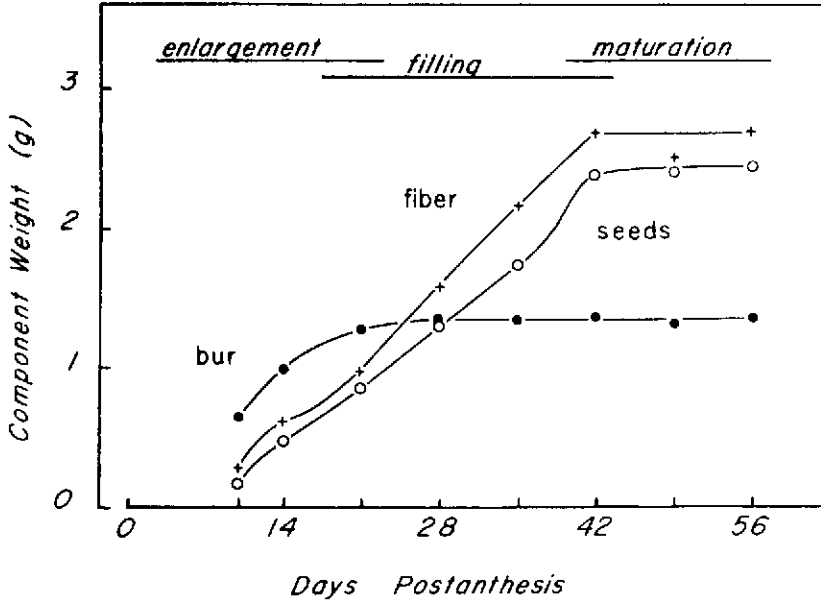

Figure 1. Dry weights of the boll components during the three phases of boll development.

described individually first, then generally in the final section. (Additional discussions on minerals may be found in Chapters 9, 20 and 24.)

As a general reference, the dry weights of the various fractions are illustrated in Figure 1, as are the approximate times of the three phases of boll development. The seed and fiber were separated at the demarcation between the inner and outer integuments of the seedcoat. Consequently, the weights of the fiber fraction were very slightly overestimated because parts of the outer integuments were included with the fiber. Fiber samples used for chemical determinations were, however, contaminant-free.

Most of these data are taken from the earlier reports of Leffler (1976) and Leffler and Tubertini (1976). The levels of mineral nutrients found in these studies agree, in general, with those reported in other studies (Bassett *et al.*, 1970; Bartee and Krieg, 1974).

## MAJOR ELEMENTS

## NITROGEN

The carpel walls and the seeds were analyzed for nitrogen (N) content (Figure 2). While there would surely be some N in the fiber, especially during early development, our efforts to measure it were not successful. Therefore, the discus-

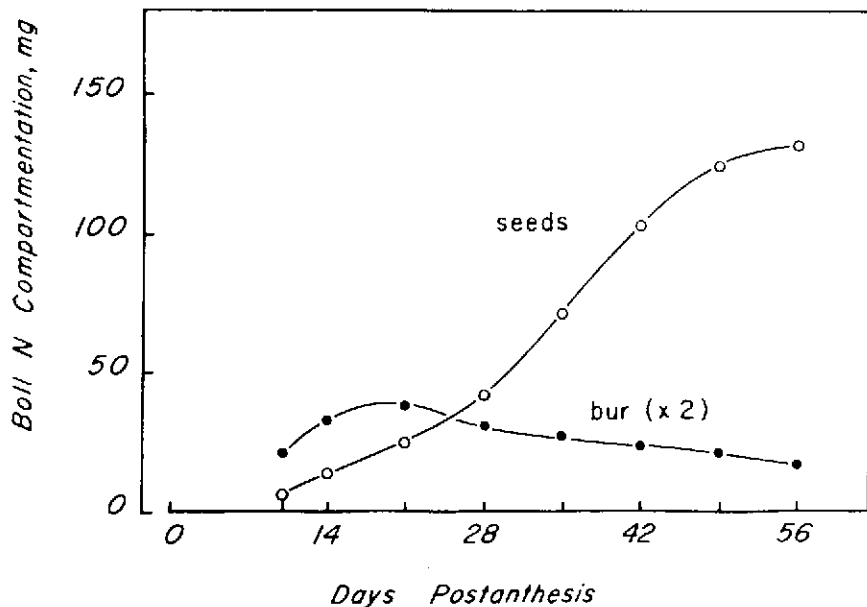

Figure 2. Compartmentation of N in developing bolls.

sion of boll N will be restricted to the pools of N in the bur and in the seeds. During early boll development, most of the boll's N is in the vegetative tissue. This bur N content peaks around the end of the third week of development, then declines throughout subsequent development.

The decrease in bur N coincides with the acceleration of N accumulation by the seeds. Between the third and sixth weeks of boll development, the accumulation of N by the seeds was nearly linear. Even though seed N accumulation slows at the end of the filling phase, it remains significant well into the maturation phase. In fact, over one-third of the seed N accumulates during boll maturation. (Other aspects of N may be found in Chapter 10).

## PHOSPHORUS

The accumulation of phosphorus (P) by the boll fractions follows much the same pattern as does N accumulation (Figure 3). There are, however, two major

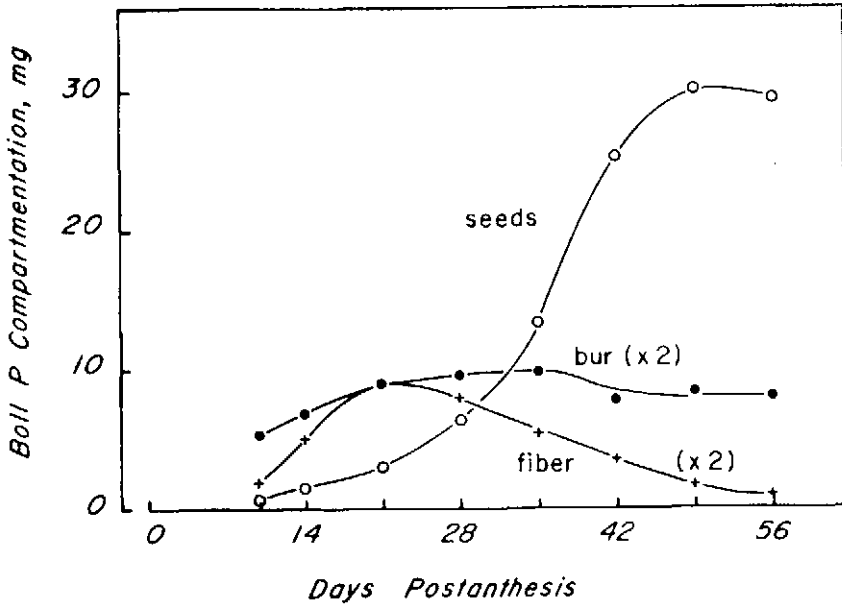

Figure 3. Compartmentation of P in developing bolls.

differences in the accumulation patterns of these two major nutrients. First, significant transient accumulation of P by the fiber was observed, with fiber P content reaching a maximum about 21 days postanthesis—this is the period of maximum fiber elongation. Phosphorus content of the fiber decreased during the period of secondary wall formation. Second, the P content of the bur does not peak until about the fifth week of development, and subsequent loss of P from the bur is not nearly so great as that for N.

As was the case with N, though, the seeds are the primary sites of P compartmentation within the developing boll. Additional accumulation during the maturation phase amounts to almost one-fourth of the total seed P. Similarly, three-fourths of the P present in the fiber fraction at the beginning of maturation is lost during that phase.

## POTASSIUM

The accumulation and distribution of potassium (K) in the developing boll are markedly different from those patterns described above for N and P (Figure 4). The bur, not the seeds, is the primary sink for boll K. With only minor fluctuations, the accumulation of K by the bur is nearly linear throughout the three phases of boll development. At maturity, the bur contains over 5 percent K.

The fiber is the second greatest sink for K through the fifth week of development, which suggests that K may be required for both elongation and secondary

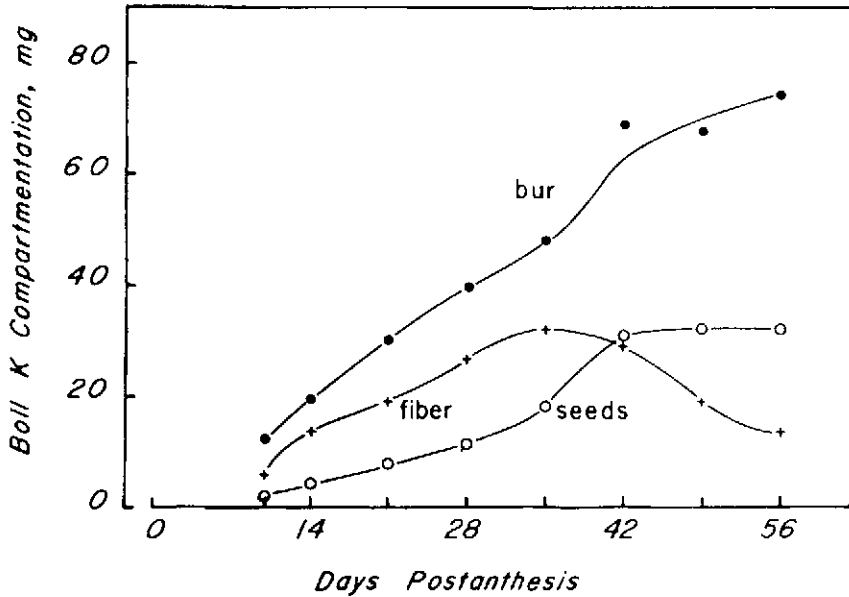

Figure 4. Compartmentation of K in developing bolls.

wall deposition. Although some K moves from the fiber during the sixth week, most of the K is exported later in the maturation phase. Accumulation of K by the seeds is essentially complete by the end of the sixth week; only about one-eighth of the total seed K accumulates during seed maturation.

## MINOR ELEMENTS

### CALCIUM

Calcium (Ca) is often considered to be a mineral nutrient with more structural than metabolic function. As such, fluctuations of Ca contents of the various components of the cotton boll would be expected to relatively approximate their changes in dry weight. This is essentially the pattern that is found (Figure 5). Again, the seeds ultimately contain more of the boll Ca than do either the bur or the fiber, accounting for almost all of the accumulation after the third week of development. The Ca in the bur increases only during the enlargement phase, then remains constant at about 2.5 mg. The bur, however, contains more Ca than the other boll components through the first 5 weeks of development. Then, beginning during the transition into the maturation phase, the Ca content of the seeds exceeds that of either the bur or the fiber. The Ca content of the fiber remains low throughout development, increasing only during fiber elongation (Benedict *et al.*, 1973; Schubert *et al.*, 1973).

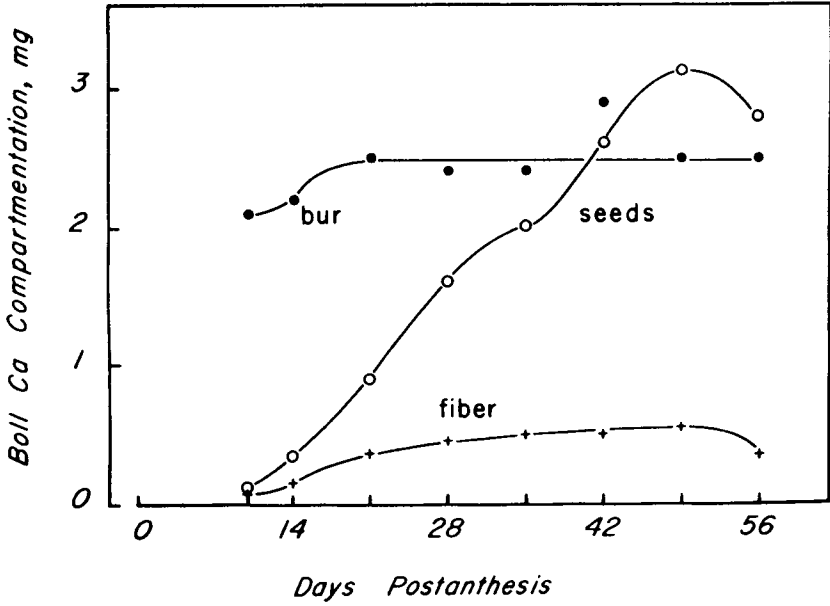

Figure 5. Compartmentation of Ca in developing bolls.

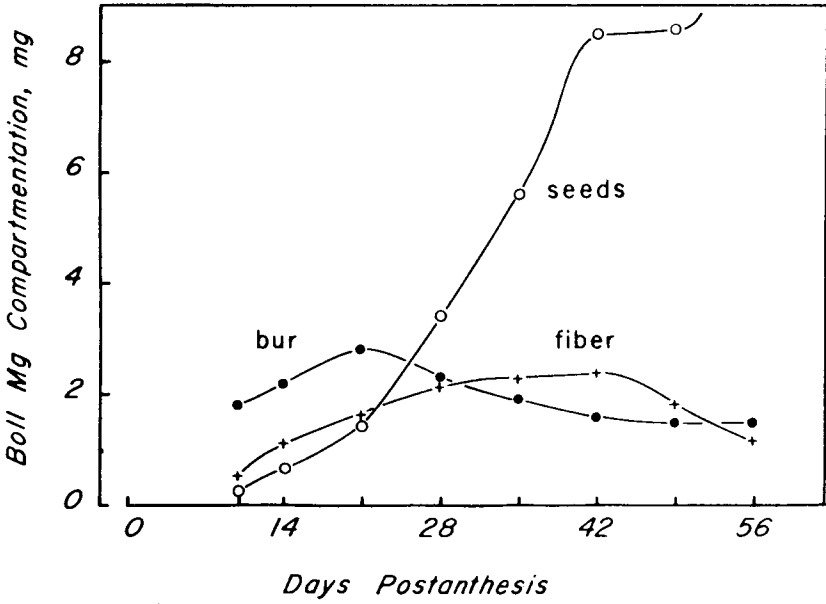

Figure 6. Compartmentation of Mg in developing bolls.

## MAGNESIUM

The magnesium (Mg) in the developing boll is representative more of a metabolic nutrient than of a truly structural nutrient (Figure 6). Once again, most of the Mg content of the boll is partitioned into the seeds. As with K, Mg appears to be associated with both fiber elongation and secondary wall formation. The Mg contents in the bur and the fiber are dynamic, increasing to peaks early or midway in the developmental period, then decreasing until maturity. The bur exports 46 percent of its Mg between 21 days postanthesis and maturity; the fiber moves out 49 percent of its Mg during the final two weeks of development.

## DYNAMIC RELATIONSHIPS OF NUTRIENT COMPARTMENTATION

By separating developing bolls into components and then analyzing the mineral nutrient complement of each component separately, it has been possible to generate significant information about the physiology of boll formation. Boll development has been considered to cover three separate but overlapping phases: enlargement, filling, and maturation (see Chapter 20). The enlargement phase begins at anthesis and lasts for 3 to 3½ weeks. During this time, the seed volume is established, much of the fiber elongation occurs, and the structural housing for the boll grows to final dimensions. This structure, the bur, is also the predominant sink for mineral nutrients during this phase of development. Some of the minerals accumulated in the first 3 weeks are required strictly for boll enlargement; others, however, appear to be accumulated as a ready reserve from which the demands of other growing components can be met later.

During the second, or filling, phase, the predominant growth is inside the boll; the seeds and the fiber continue growth through about the sixth week of development. Each acquires a significant complement of mineral nutrients during this phase. Although most of the mineral nutrients acquired by these internal structures are newly arrived to the boll, a lesser but significant proportion of the total may be derived from nutrients that are exported from the bur. The potential contribution of the bur to the other boll components appears to be greatest for nitrogen and magnesium and lower for phosphorus. It appears not to be significant for either potassium or calcium.

The maturation phase of boll development may yet prove to be the most interesting of the three, especially from the standpoint of mineral compartmentation. This is the phase that has generally been overlooked when only dry weight measurements have been made; yet, there are relatively massive shifts in the compartmentation of mineral nutrients during this final fortnight of formation. Similarly, both the quantity and the quality of cotton seed proteins shift significantly during the final two weeks of boll development (King and Leffler, 1979).

The importance of the maturation period may be better understood when the degree of nutrient import to the seed is more fully identified. During this phase,

the seeds accumulate about one-third of their nitrogen, one-fourth of their phosphorus, one-eighth of their potassium, one-seventh of their calcium and two-fifths of their magnesium. Simultaneously, the fiber loses three-fourths of its phosphorus, three-fifths of its potassium, one-fourth of its calcium and half of its magnesium. These changes, coupled with those in the bur, demonstrate the relative magnitudes of mineral nutrient redistribution among the components of the boll within a comparatively short time (Figure 7). Further, these data strongly suggest that the several boll components remain physiologically interconnected and interdependent as long as the boll remains closed, and that normal boll development continues through boll opening. For these reasons and because seeds harvested just before boll opening have been found to be of poor quality (Leffler, 1980b; Halloin, 1981b), the maturation process must be regarded as an important ontogenetic period, not simply a relatively quiescent one.

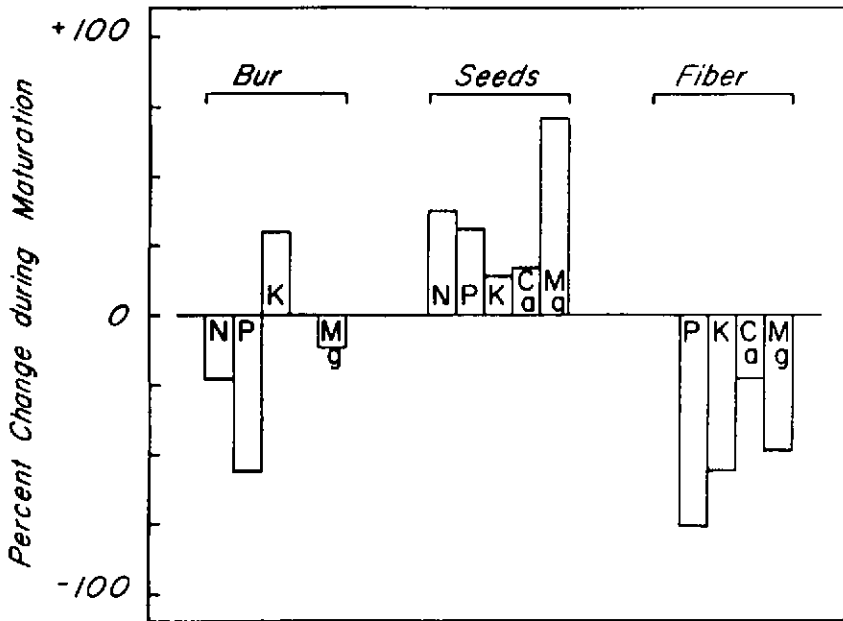

Figure 7. Relative changes in mineral nutrient contents of the boll components during the maturation phase.



## SUMMARY

Published data describing the distribution of mineral nutrients in developing cotton bolls were recalculated on a mass basis to illustrate the internal relationships among boll components. The major components of the boll, the carpel walls (bur), the seeds and the fiber, were considered as the compartments of interest in this evaluation. During early boll development, the carpel walls accumulate significant amounts of all nutrients examined; once secondary boll development is initiated, however, further accumulation occurs only for potassium and, to a limited degree, phosphorus. During secondary boll development, nitrogen and magnesium move from the carpel walls, presumably to the seeds, which comprise the major nutrient sink of the boll. The most striking changes in mineral compartmentation occur during maturation, a two-week interval immediately preceding boll opening which was once considered to be a relatively quiescent period. It is during this period of maturation that the major movement of mineral nutrients occurs that result in the mature boll distribution of nutrients. This redistribution of minerals among the various compartments of the boll indicates that the boll retains physiological integrity and activity at least until dehiscence occurs.

## Chapter 22

# CARBOHYDRATE DISTRIBUTION IN BOLLS

A. Michael Schubert  
Texas Agricultural Experiment Station  
Yoakum, Texas

C.R. Benedict  
Texas A&M University  
College Station, Texas

Russell J. Kohel  
USDA—ARS  
College Station, Texas

## INTRODUCTION

Assimilate distribution in the cotton plant depends on several factors: (1) carbon dioxide exchange rates (CER) of leaves and other photosynthetic tissues; (2) relative strengths of bolls and other sinks; (3) source-to-fruit proximity and other translocation factors; and (4) duration of transport into fruit.

## ASSIMILATE SUPPLY

Pinkhasov (1981) summarized years of research on cotton photosynthesis and assimilate distribution, in which total plant photosynthesis was divided among contributing organs. Main stem leaves contributed 33 percent of the photosynthesis; lateral branch leaves, 55 percent; bracts, 4 percent; fruiting organs, 2.1 percent; petioles, 4.4 percent; and cortex, 1.5 percent. The higher CER of lateral branch leaves over main stem leaves was attributed to the higher rates of assimilate export from the lateral branch leaves. (More will be said later about the relationship of CER and translocation rates.) Pinkhasov found that CER/unit of plant weight peaked at budding time (approximately 45 days after emergence under his growing conditions) and then declined. This peak period was thought to be due to favorable temperatures and a low level of mutual shading. CER/plant and leaf area peaked during the fruiting period (approximately 100 days) and

then declined as crop maturation progressed.

There is general agreement in the literature that leaves, bracts and other structures supply assimilate to the developing boll. Using autoradiography, Brown (1968) found that bracts, carpel walls, subtending leaves and other leaves higher on the main stem supply assimilate to the boll. From more quantitative work, Ashley (1972) and Benedict and Kohel (1975) agree that the subtending leaf is the major source of assimilates for its associated boll. When fruiting branches were allowed to assimilate  $^{14}\text{CO}_2$  following removal of leaves, bracts or both, Benedict and Kohel (1975) found that the associated bracts supplied only 5-10 percent and the carpel wall contributed very little of the developing boll's assimilate. The importance of the subtending leaf is confirmed by the parallel time courses of assimilate efflux from the source leaf and influx into the seed, both of which peaked at 6 hours following incorporation of the label. Ashley (1972) observed a similar time course for efflux with the fastest rates between 2 and 8 hours. Ashley also showed that more than 89 percent of the assimilate fixed in a source leaf remained in that sympodium throughout the 24-hour observation period. This is consistent with the relative importance of main stem and lateral branch leaves observed by Pinkhasov (1981), who reported the assimilate tends to be used by sinks near the source. Elmore and McMichael (1975) found that photosynthesis was equal in normal and nectariless bracts but was reduced to 64 percent of the normal in cotton with frego bracts. This would not be a serious problem in frego bract lines, since the contribution by bracts is small.

Photosynthesis has been reported to limit cotton productivity. Hesketh *et al.* (1972) reported that  $\text{CO}_2$  enrichment doubled the number of bolls per plant. Guinn *et al.* (1976) reported that increasing atmospheric  $\text{CO}_2$  content from 330 ppm to 630 ppm caused an immediate 65 percent increase in CER which declined to a steady 31 percent increase in CER. The  $\text{CO}_2$ -enriched plants had more blooms and a lower boll abscission rate resulting in more bolls. Enriched plants also used more nitrate. There was a 65 percent increase in boll weight. In subsequent work, Mauney *et al.* (1978) showed that  $\text{CO}_2$  enrichment was accompanied by a 15 percent increase in CER and increases in leaf area, boll set and boll weight. Growth analyses showed that the additional assimilate in the high  $\text{CO}_2$  treatments was partitioned first to higher leaf area and plant dry weight in young plants and later to additional bolls. The combination of high  $\text{CO}_2$  and additional mineral nutrients to meet the demands of the increased growth produced a 180 percent increase in harvestable lint weight. When extrapolated to land area, these yields were equivalent to 3,250 kg/ha (5.8 bales/ac). Mauney *et al.* (1978) concluded that, if reliable measurement methods could be developed, increasing CER would probably be an important means of increasing cotton yields. Since leaf area and plant dry weight in juvenile plants responded to increased  $\text{CO}_2$ , these variables might be useful screening tools. Wardlaw (1980) wrote that in:

some crop species, yield increases were due to improved harvest index rather than to increased biomass or photosynthesis. Gifford and Evans (1981) concluded that most yield increases have resulted from increased harvest index. Improved CER may increase yields of economically important plant parts or products, but not necessarily. This depends on how the photosynthate is partitioned among plant parts.

Photosynthetic and translocation processes interact in cotton and other plants. When photosynthesis is very low, the quantity of assimilate available for translocation is reduced. McArthur *et al.* (1975) reported that when cotton plants were kept in darkness for 48 hours, they shed most of their flowers and young bolls 2 to 3 days after the dark treatment. They concluded that only a 1 or 2-day supply of sugar and starch was stored in the leaves and that assimilate translocation ceased after that time. They theorized that shedding was a means of maintaining a fairly constant carbohydrate level in the plant. There is also an effect of translocation on photosynthesis, because assimilate accumulation in leaves appears to inhibit photosynthesis. Through this mechanism, sinks (plant tissues or organs which are net importers of assimilate) can exert some control over assimilate production (Gifford and Evans, 1981).

Pinkhasov (1981) reported that, when all fruiting organs were removed from cotton plants, CER decreased 3-fold and assimilate efflux from leaves decreased. Mauney *et al.* (1979) cited reports of self-limiting behavior of photosynthesis. These involved a reduction of CER at times during the day when conditions were favorable for photosynthesis. Hypothetically, this reduction could have been caused by stomatal closure due to "localized water stress," hormonal changes or accumulation of photosynthetic products. Ackerson and Hebert (1981) and Ackerson (1981) have shown that leaf carbohydrate does increase during water stress cycles. This reaction caused a reduction in photosynthesis unrelated to stomatal factors in stress-adapted leaves compared to non-adapted leaves when water status was adequate. These adapted leaves had higher CER than non-adapted leaves during periods of water stress. Under adequate moisture, chloroplasts in adapted leaves had unusually large starch grains and appeared swollen with some thylakoid membrane breakage.

In early reports, Mauney *et al.* (1976) found that a 100 to 250 mg g<sup>-1</sup> increase in leaf starch content was accompanied by a decrease in CER from 40 to 30 mg CO<sub>2</sub> dm<sup>-2</sup> hr<sup>-1</sup>. Mauney *et al.* (1979) found that there were no significant correlations between leaf sugar content and CER in greenhouse-grown cotton. They did report significant negative correlations between starch content and CER in cotton grown at normal CO<sub>2</sub> levels (330 ppm) in the greenhouse. An increase of leaf starch content from 40 to 150 mg g<sup>-1</sup> reduced CER by about 10 percent in cotton. This range in starch content was observed both in the greenhouse at normal CO<sub>2</sub> levels and in the field. Field-grown cotton and cotton grown at 630 ppm CO<sub>2</sub> did

not, however, exhibit a significant correlation of CER and starch content. The authors point out that since photosynthesis produces starch, a positive correlation of CER and starch would be expected even if starch were inhibiting CER slightly at certain starch levels. The "cause-and-effect relationship tends to mask inhibition of photosynthesis by starch" (Mauney *et al.*, 1979). They observed no negative carbohydrate-CER correlations in sunflower, soybean or sorghum. Although there was no significant correlation of starch and CER among cotton leaves in 630 ppm CO<sub>2</sub>, there were diurnal increases in starch and decreases in CER during each of the first three days after cotton plants were transferred from normal to high CO<sub>2</sub> greenhouses. When cotton was transferred from high CO<sub>2</sub> to low CO<sub>2</sub>, CER increased to normal levels as midday starch content decreased from 235.5 to 145 mg g<sup>-1</sup>. Mauney *et al.* (1979) concluded that although high CO<sub>2</sub> overshadowed the inhibitory effects of high leaf starch concentrations on CER due to high substrate level, it is reasonable to conclude that inhibition was occurring in the greenhouse at high CO<sub>2</sub> contents and in the field. C.W. Chang (1979) found that starch contents become high enough to restrict photosynthesis in young leaves (the top four leaves), but not in older leaves.

## SINK STRENGTH

Sink strength is important in determining how a plant distributes its assimilate among plant parts. As previously stated, harvest index is important in determining yields of specific plant products or structures, such as cotton lint or seed, which are of economic value. In this chapter, sink strength is defined as the ability of an organ, e.g. a cotton boll, to import assimilate for its use. In theory, the use might be for development of economically important products or for economically insignificant metabolic activity or excessive vegetative growth. Since we are interested in efficient seed cotton production, we must also be interested in efficient assimilate conversion into lint and seed. Of course, the plant must have sufficient root, stem and leaf growth to support boll growth, but we are primarily interested in understanding the sink strength of developing bolls.

Hesketh *et al.* (1976) studied basic growth relationships in cotton to determine what constitutes an efficient plant. They concluded that there is probably a point beyond which increasing harvest index would be counter-productive. A minimum vegetative framework is undoubtedly required for dependable plant survival. They found that as leaf area increased, total stem weight, stem weight per unit length, and total plant size increased. Pinkhasov (1981) reported that most labeled assimilate went to leaves and stem until the beginning of flowering. As fruit development progressed toward boll maturity, more and more assimilate went to the bolls. Munro (1971) reported that the first three positions on the sympodium accounted for the majority of mature bolls and received the majority

of assimilate partitioned to reproductive growth. Ashley (1972) found that bolls close to photosynthetically active leaves are strong sinks. This does not, however, preclude the shedding of very young bolls which are closer to the source leaf but are weaker sinks than a larger, actively growing boll nearby. Assimilate may also be imported from more distant sources when the leaf subtending that actively growing boll can no longer meet its assimilate demands because of shading (McArthur *et al.*, 1975). Pinkhasov (1981) reported the same trends, indicating that a leaf on a sympodium sent most of its assimilate to the closest boll if that boll was 16 to 35 days old. He found the peak influx period to be 20 to 27 days, when the boll drew assimilate from distant as well as the closest leaves preferentially over younger bolls. He attributed the loss of 80 to 85 percent of fruiting organs to this competition for assimilate. Pinkhasov described this fruit loss as a survival mechanism, because the early bolls which are more likely to reach maturity are most competitive for assimilate.

Hesketh *et al.* (1976) concluded that production of late season flowers whose bolls will not mature may seem wasteful, but the increased fruiting branch leaves which accompany flowering may be important in crop maturation, since cotton leaves often senesce rapidly. If "wasteful" flower production were eliminated, extending leaf activity or breeding for more leaf production might be necessary.

Sink strength can be defined in a variety of ways depending on the plant species. In wheat, sink strength has been characterized by dry weight increase  $\text{ear}^{-1} \text{hr}^{-1}$  (Wardlaw and Moncur, 1976) and was positively related to rate of assimilate transport through the peduncle. Cook and Evans (1978) correlated sink strength to the number of developing grains per wheat head. The large sinks imported more assimilate than did heads from which grains were removed after anthesis. There was a complication in their findings in that the small sinks imported more assimilate per grain than did the large sinks, especially from reserves. Boote (1975) found that dry weight of peanut fruit was proportional to sink strength. Snyder and Carlson (1978) reported that translocation of assimilate was directly proportional to the taproot-leaf weight ratio in sugarbeet.

While sink strength is often correlated with the physical size or weight of the sink, it is important to realize that sink strength is a function of metabolic demand. Certain portions of metabolic demand, such as respiration, may be a function of tissue mass. Other portions may be related to specific synthetic activities occurring in the sink during a particular developmental period which are not reflected in mass or size of the sink. Benedict *et al.* (1980) reported this to be the case with cotton. Data for boll size plotted against boll age (the number of days after anthesis, DPA) resulted in a hyperbolic pattern. The data were fitted to a fifth degree polynomial equation which resulted in an accumulative curve for the fresh weight of the boll (correlation coefficient 0.913) (Figure 1). The derivative of the polynomial resulted in a rate curve of boll size with the maximum

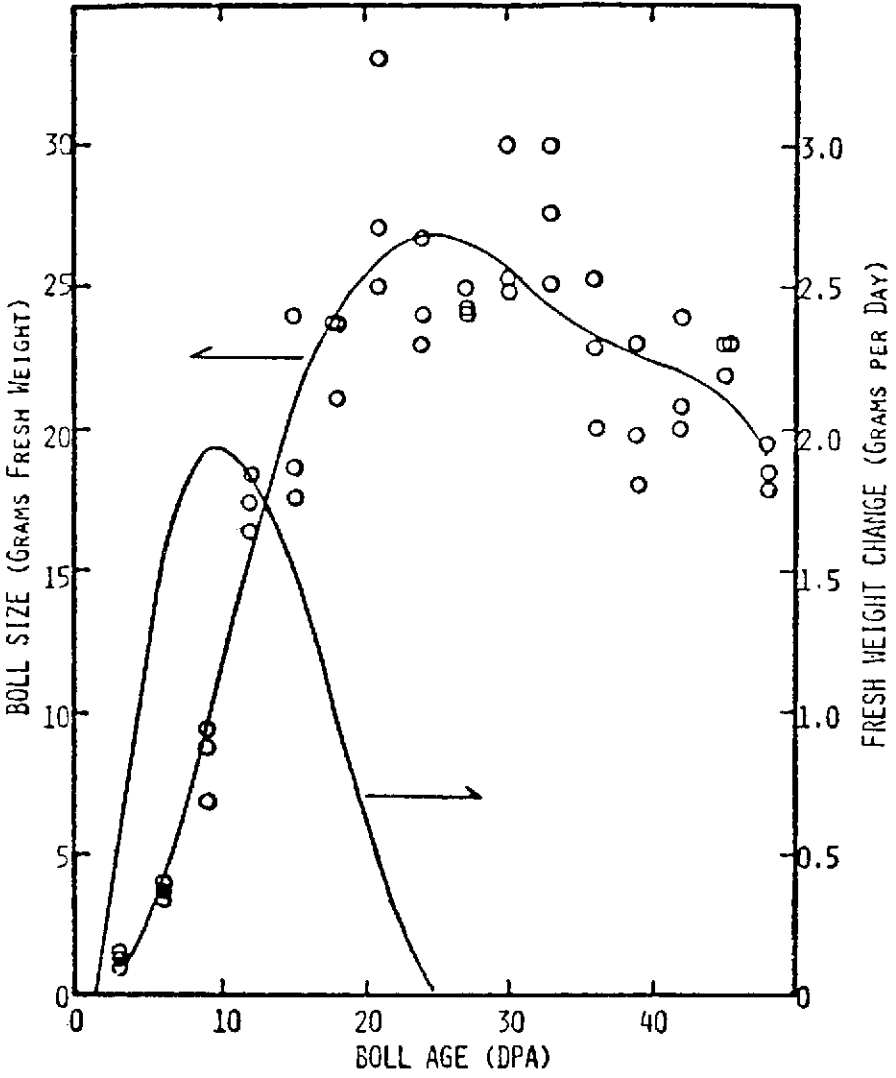

Figure 1. The best-fit curve for the increase in the boll size of different age bolls and the derivative of this curve resulting in the rate curve of boll size.

increase of boll size at 10 days past anthesis (DPA). Increase in boll size stopped 25 DPA. When the distribution of  $^{14}\text{C}$ -assimilates, from a 20 hour translocation period, into different age cotton bolls was examined, there was only a small amount of  $^{14}\text{C}$ -assimilate transported to 10 day old bolls (Figure 2). The amount of  $^{14}\text{C}$ -assimilate transported to cotton bolls reached a maximum 31 to 32 DPA, then the amount transported declined to zero at 45 DPA. The curve for the partitioning of  $^{14}\text{C}$ -assimilates to different age cotton bolls does not correlate to the rate curve describing the increase in boll size. An increase in the size of cotton bolls to 25 DPA is primarily due to an increase in the fresh weight of the carpel wall. Benedict *et al.* (1973) have previously established the curve describing the partitioning of  $^{14}\text{C}$ -assimilates into carpel walls of different age cotton bolls which is similar to the curve for increase in boll size. Baranov and Maltzev (1937) have shown that even though the size of cotton bolls reach a maximum 22 to 25 DPA, the embryo does not reach maturity until much later (See Chapter 20).

Schubert *et al.* (1973) have shown that the rate of fiber weight increase of Stoneville 213 cotton reaches a maximum 30 to 31 DPA and then declines to zero at 55 DPA. Similar patterns were observed in Pima cotton (Schubert *et al.*, 1976). Thus, the partitioning of  $^{14}\text{C}$ -assimilates to different age cotton bolls reflects the distribution of  $^{14}\text{C}$ -assimilates to ovular constituents and lint fibers rather than the distribution of assimilate to carpel wall. Benedict *et al.* (1980) reported a good correlation of the distribution of assimilates to different age cotton bolls and their lint fibers (Figure 3). Curves describing the partitioning of  $^{14}\text{C}$ -assimilate to lint fibers and the rate of weight gain in lint fibers during boll development were also similar with a correlation coefficient of 0.876 for points on the two curves. The distribution of assimilates to different age cotton fibers is highly correlated to the cellulose deposition or sink demand of the different age fibers (Figure 4). This relationship was strengthened by a comparison of the partitioning of  $^{14}\text{C}$ -assimilates to lint fibers and the rate of cellulose synthesis in excised ovules (Figure 5), as indicated by the rate of  $^{14}\text{C}$ -glucose incorporation into cellulose of different age lint fibers. Again, the time courses of assimilate partitioning to lint fibers and cellulose deposition were almost identical. The overall assimilate influx pattern (and, therefore, sink strength) of developing cotton bolls reflects the time-course of their dominate metabolic activity—synthesis of cellulose in the lint fibers—rather than just boll size (Benedict *et al.*, 1980).

## SOURCE-TO-SINK PROXIMITY

The proximity of sinks to sources of assimilate is an important factor in the distribution of assimilate. Tuichibaev and Kruzhilin (1965) reported that labeled assimilate from leaves near the bottom of the plant moved primarily to the roots in



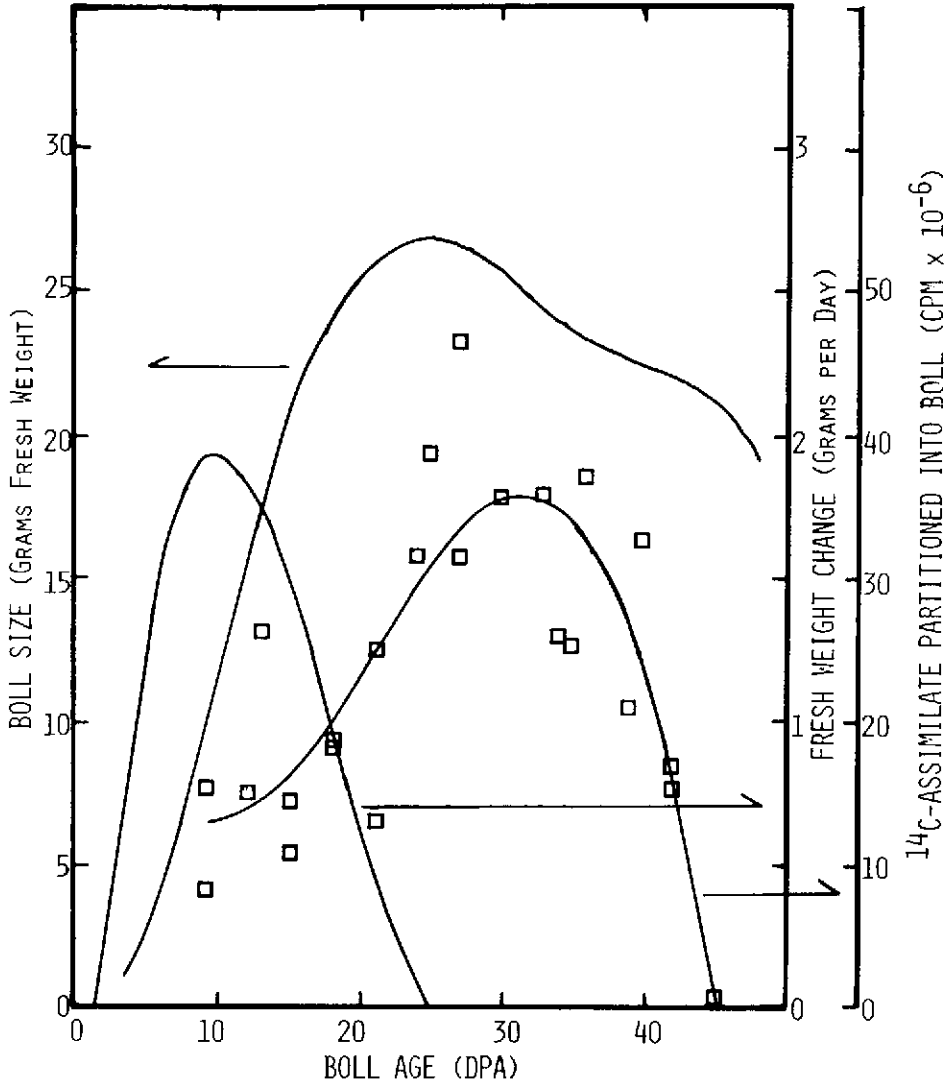

Figure 2. The best-fit curve of the partitioning of  $^{14}\text{C}$ - assimilates into different age cotton bolls versus the best-fit curve for boll size of different age cotton bolls and the differential curve describing the rate of increase of boll size in different age bolls.

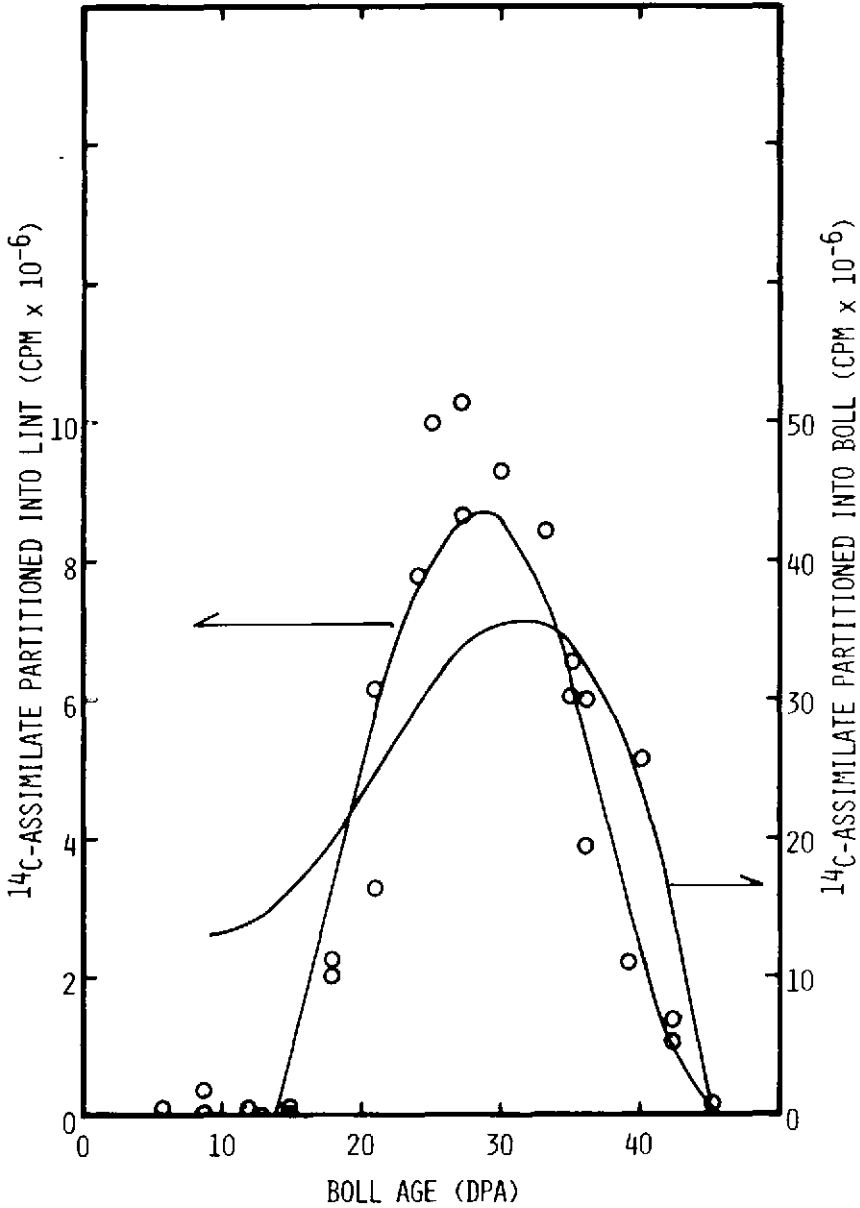

Figure 3. The best-fit curves for the partitioning of <sup>14</sup>C- assimilates into different age cotton bolls and the partitioning of <sup>14</sup>C- assimilates into cotton lint fibers in different age cotton bolls.

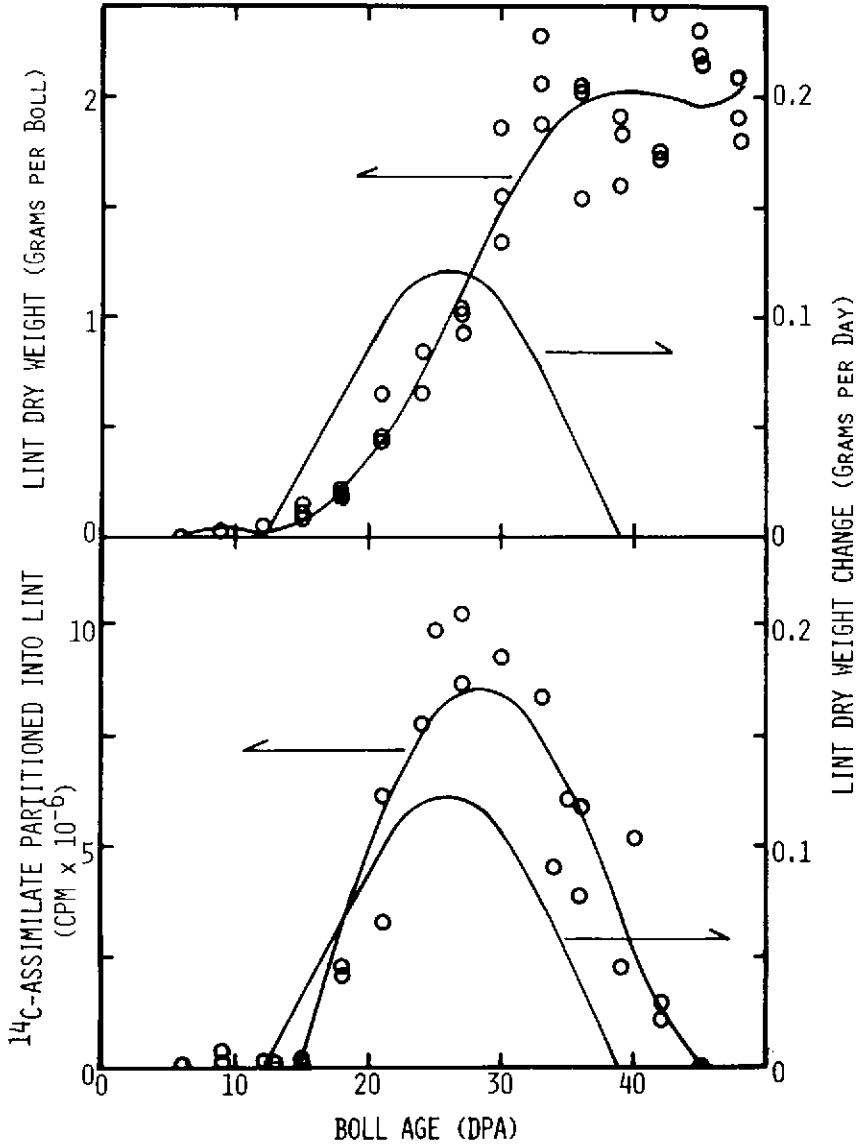

Figure 4. Upper part, is the best-fit curve describing the accumulative increase in dry wt of different age cotton fibers and the differential of this S-shaped curve to give the curve describing the rate of dry wt increase (rate of carbon deposition) in different age fibers. Lower part, the curves for partitioning the  $^{14}\text{C}$ -assimilates into different age cotton fibers and the rate of dry wt increase in different age fibers.

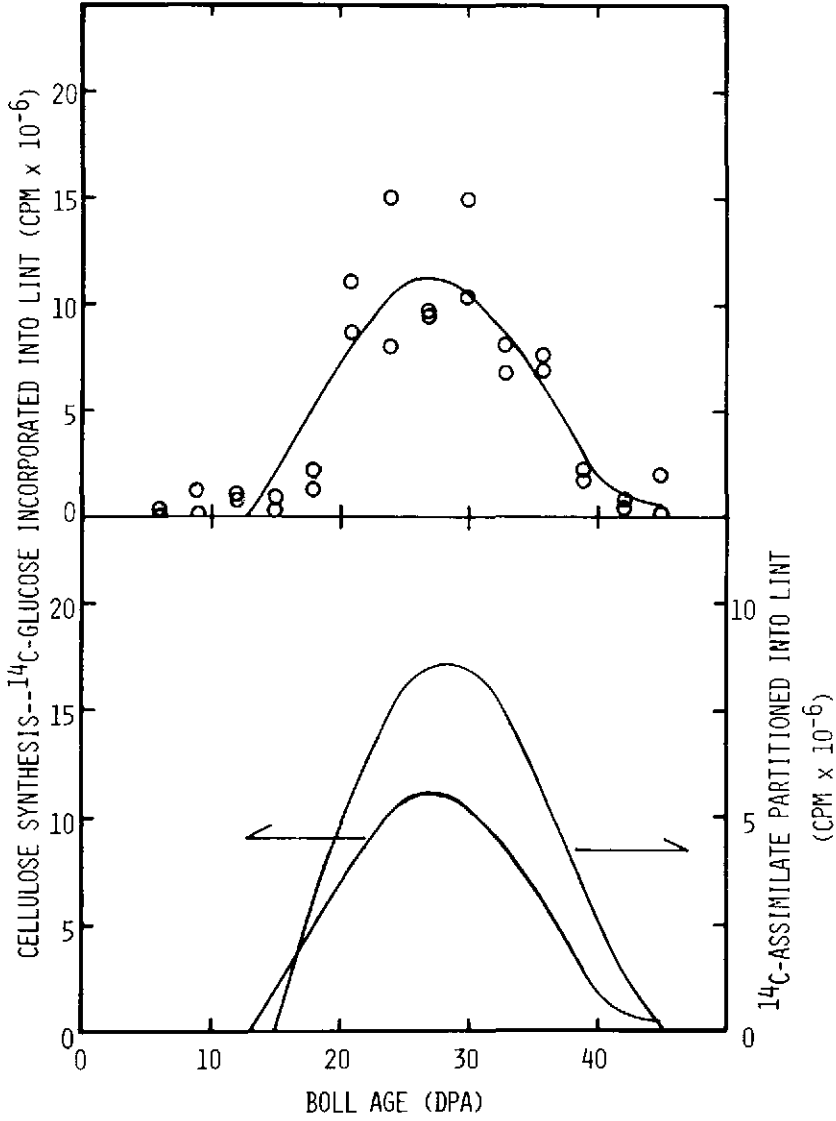

Figure 5. Best-fit curve for the rate of cellulose synthesis in excised ovules (upper part). Curves for the partitioning of <sup>14</sup>C-assimilates into different age fibers and the rate of cellulose synthesis in excised ovules (lower part).

young, vegetative cotton plants. Progressively less labeled assimilate moved to the roots from successively higher leaves. As was previously discussed, Ashley (1972) reported that actively growing cotton bolls were strong sinks for assimilate from nearby leaves.

Pinkhasov (1981) reported on experiments with a cotton cultivar which had an average distance of 24 cm from source leaf to fruit and a mutant with only 14.8 cm distance. Both genotypes had similar whole plant CER. The rate of efflux from the source leaf was twice as fast for the mutant as for the normal cultivar, as was the influx rate into the boll. The mutant had a much lower influx of labeled assimilate into the stem and root. The normal line had a leaf weight:fiber weight ratio of 1:1.99; the mutant had 1:3.49. A Duplex cultivar which has shortened sympodial branches with double bolls, small leaves and a leaf to boll distance 1.5 times shorter than normal lines also exhibited higher yields and earlier maturity than normal cultivars. Pinkhasov theorized that, since translocation is an energy-requiring process, energy is conserved when the translocation distance is shortened. There is also a reduction in the assimilate used to produce and maintain stem tissue. The shorter source-to-sink lines were more productive than normal cotton in the field when plant population was increased.

Other factors also affect translocation rates and assimilate partitioning. Ashley and Goodson (1972) reported that potassium deficiency reduced translocation velocity in cotton from 50 to 20 cm hr<sup>-1</sup>.

Some assimilate may be tied up in storage pools which are not readily available for later use. Chang (1980) studied the relationship of leaf sugar and starch contents, starch degradation in darkness, and amylose and amylopectin dynamics during development in cotton. He found that starch degradation was not accompanied by an increase in leaf sugar content unless the phloem was disrupted by girdling, indicating that sugar released from the starch pool was immediately translocated. Sugar translocation was equal to or faster than starch degradation. The sugar increase after girdling also indicated that sugars produced by starch degradation were not broken down in the leaves to any great extent. Until about 50 days after planting, 70 to 80 percent of the starch in young leaves broke down during a 14-hour dark period, but only 30 percent in old leaves. After 62 days, there was a preponderance of older leaves, starch levels were not as high during the light period, and young and older leaves were more similar in starch degradation percentages in the dark. Chang reported that the main difference in starch degradation was due to changes in the ability of different aged leaves to break-down amylose and amylopectin. As leaves aged, amylopectin degradation decreased. Since amylopectin made up 75 to 90 percent of leaf starch, remobilization decreased greatly in older leaves and older plants which had a preponderance of older leaves.

Thompson *et al.* (1975) reported that levels of both soluble and insoluble

carbohydrates increased in leaves during unseasonably cool temperatures, apparently due to inhibition of translocation and growth.

## DURATION OF ASSIMILATE TRANSPORT TO BOLLS

One of the classical factors determining crop yields is the length of the fruit filling period, along with number of fruit and assimilate partitioning to the fruit. In examining these factors, Duncan *et al.* (1978) found that partitioning was probably most important in peanut.

Duration of transport into the cottonseed could be a serious developmental constraint if that period were relatively short. Despite the suggestions of the early breakage of the funiculus, which supplies the developing seed with nutrients (Ihle and Dure, 1972; Dure, 1975), it appears that developing cottonseed receive some assimilate essentially until maturity. If the assimilate supply to the seed stopped at 32 DPA, the remaining 16 to 20 days of seed development would involve only the metabolic alteration of previously obtained assimilate. This would have some very interesting biological implications. Pinkhasov (1981) reported movement of  $^{14}\text{C}$ -assimilate into bolls at least until 45 DPA. Benedict *et al.* (1976) and Benedict *et al.* (1980) also reported incorporation of  $^{14}\text{C}$ -assimilate into cotton lint until at least 45 DPA. The influx into bolls and incorporation into lint and other fruit structures plotted vs. boll age are basically bell-shaped curves with low levels near maturity, but there is no indication that influx ceases.

## SUMMARY

Developing cotton bolls receive most of their assimilate from their subtending leaves or other leaves on the same sympodium. Other tissue, such as bracts, contribute a small portion of the boll's assimilate.

Photosynthesis has been found to limit cotton yields. Therefore, increased assimilate production is a desirable breeding goal, if gains are not negated by unfavorable changes in harvest index. It is interesting to note that at least in young leaves, low sink demand may reduce photosynthesis. Other sources of increased productivity may include reducing "wasteful" flower and fruit production and partitioning more photosynthate to reproductive growth. Both areas have limitation, however: (1) continued fruit production into the late season provides a hedge against total crop failure and may be accompanied by the development of needed leaf tissue; and (2) there is probably some minimum vegetative framework which is necessary for optimum plant function which can be exceeded if harvest index is increased too far. Transport of assimilate to bolls become more efficient when source-to-sink distances are shortened, but again this miniaturization must become counter-productive at some point. There is probably, at best, a 2-day reserve of assimilate under conditions of no photosynthesis. Although

starch may be detected in leaves, there is good evidence that remobilization declines as the plant and leaves age.

Correlation of sink size to sink strength is probably coincidental to metabolic activity of the large sink. While size may be useful for crop modeling, the related metabolic activity should be characterized to prevent over-simplification of the model. Influx of assimilate into the developing cotton fruit parallels synthetic activity through the development period. This is a bell-shaped relationship which is low in very young and nearly mature bolls and high at and following the mid-point in development.

## Chapter 23

## LINT DEVELOPMENT

Edmond A.L. DeLanghe  
Katholieke Universiteit Leuven  
Heverlee, BELGIUM

## INTRODUCTION

When a cotton flower blooms, a number of cells in the outer epidermal layer of the ovules show a bulging of the outer wall. This is the onset of a very fast, 1000- to 3000-fold, elongation leading to gigantic tubular hair cells up to 6 cm long. They consist of a very thin cuticulum, a thin primary wall remarkable for its combination of strength and extreme extension, a thin cytoplasmic layer and an enormous vacuole. During a second period, the vacuole will shrink progressively while, at the inside of the primary wall, a mass of almost pure cellulose is deposited as a secondary wall. By the time of boll maturation the secondary wall will normally fill the major part of the cell volume, leaving the lumen, the small central cavity, containing the remainder of the cytoplasm and the vacuole. As the boll opens, quick desiccation of the tubular cells occurs. They collapse longitudinally, and assume a ribbonlike form with special twists called convolutions. This is the cotton fiber.<sup>1</sup>

The development of the cotton fiber has been explained many times since Balls (1915). For the state of knowledge of cotton and its cellulose at the end of the 1960's, refer to two excellent reviews by Rollins (1968a,b).

The unique, hence non-representative, form of the cotton fiber is probably just the reason why, in the past, surprisingly little research had been directed toward understanding how the cotton fiber cell synthesizes cellulose and incorporates it into a cell wall (Westafer and Brown, 1976). But during the last decade, physiological research on the developing cotton fiber has contributed in a large measure to better understanding of several fundamental aspects of cell differentiation, cell expansion and cellulose synthesis.

<sup>1</sup>Since this chapter is not dealing with the development of the so-called "fuzz-fibers", the word "fiber" is exclusively used in the present context as an alternative expression for "lint fiber" or "lint". The word "fiber" stands also in this text for the corresponding cell during its development into the real fiber, the latter being the harvested product of the mature cotton boll. Wherever it is felt necessary, exact expressions such as "elongating epidermal cells" are preferred.



On the other hand, since the cotton fiber plays an important role in the textile industry, the technological study of its physical and mechanical properties began during the 19th century (Bowman, 1882). That research produced a universally recognized terminology for the characterization of the cotton fiber as it is available on the market in baled cotton. Despite long-established cooperation between cotton breeders and fiber technologists, it remains difficult to "translate" some technological properties in terms of morphogenetic processes. The recent advances in physiological research on cotton fiber development will probably enable the cotton grower, the breeder and the agronomist to better control development with a view to desired properties in the future.

## FIBER INITIATION

With the exception of stomatal cells, mainly located at the chalazal end, the cells of the outer epidermal layer of a cotton ovule are cuboidal during the last days before anthesis. They are either in a state of division or in interphase (Figure 1A). At the period of anthesis, some cells will no longer divide, but they will protrude slightly above the epidermis surface. These differentiating cells are the fiber initials. Numerous workers have observed fiber initiation the day before anthesis, especially at the crest and at the chalazal end (Aiyangar, 1951; Ramchandani *et al.*, 1966; Joshi *et al.*, 1967; Ramsey and Berlin, 1976a); thus, initiation is clearly not induced by the pollination-fertilization process. Fiber initiation is a part of the total flower opening mechanism, which starts one or two days before anthesis with the expansion of the petals and the elongation of the style and anthers, and which culminates in increased growth of the ovary at the day of anthesis.

Study of the ultrastructure of the outer epidermal layer in *Gossypium hirsutum* by Ramsey and Berlin (1976a) at the day before anthesis revealed some significant changes: at 24 hours preanthesis, all the cuboidal cells had numerous vacuoles containing an electron dense material which was assumed to be phenolic substances. Different cytological changes connected with fiber initiation appears simultaneously in some cells at 16 hours preanthesis, together with the release of the phenolic substances from the vacuoles and an apparent increase in cytoplasm density. Since phenolic substances are known to interfere strongly with IAA-oxidase (Leopold and Kriedeman, 1975; Kefeli and Kutacek, 1977), it is suggested that o-diphenolic compounds are indirectly involved in the original stimulation of the fiber expansion by inhibition of IAA-oxidase with a resulting accumulation of IAA.

However, the metabolic background of the first stages of fiber differentiation may be somewhat more complicated since increase of o-diphenol oxidase activity has also been detected during the same period (Naithani *et al.*, 1981). It may be that different balances between o-diphenols and other phenols in the different

epidermal cells are responsible for the distinction between fiber initials and the remaining epidermal cells.

Fiber initiation appears first at the chalazal part of the ovule and continues progressively towards the micropyle where the first fiber initials are observed at least 24 to 48 hours after anthesis (Joshi *et al.*, 1967; Sheffield, 1936). Meanwhile, and especially during the day of anthesis, a great number of cells continue to divide with an increasing rate in the observed number of mitotic figures. At 1 day postanthesis (DPA) further mitosis occurs but at a gradually decreasing rate. Nevertheless, mitosis has been observed till 10 days after anthesis (10 DPA) in *G. hirsutum* cultivars and till 11 DPA in *G. barbadense* cultivars (Kechagia-Michailidou, 1977).

According to all the reported observations, it is at the day of anthesis that the majority of the lint fibers is clearly initiated.

The fiber initial will first extend above the surrounding epidermal cells and assume a "ballooning" shape. Spectacular changes occur in these cells: the central vacuole moves towards the "ballooning" part and expands further, occupying at 2 DPA almost the complete cell body, including the basal part, leaving only a thin cytoplasmic layer, except at the tip. At that time, only small amounts of electron dense material remain in the vacuole. The nucleus moves towards the tip and increases considerably in size. The original small nucleoli, typical of interphase epidermal cells, fuse together, thus producing a large spherical nucleolus which occupies a major part of the nucleus (Stewart, 1972; Ramsey and Berlin, 1976b) (Figure 1 Bc and C).

## FIBER ELONGATION

### MORPHOGENETIC ASPECTS

The majority of the morphogenetic processes reported hereafter are based on observation of *G. hirsutum* material. The timing of these processes may differ from one species to another and perhaps slightly among the cultivars of a same species.

Longitudinal expansion, in other words, fiber elongation, already dominates at 1 DPA (Figure 1 Cb), but lateral expansion continues slowly and gives approximately the final diameter to the future fiber at about 4 DPA.

At 1-2 DPA, the hitherto rather blunted fiber tip begins to taper (Figure 1 Cb). Tapering on mature fibers will be abrupt in *G. hirsutum* and gradual in *G. barbadense*.

Orientation of almost all the fiber tips towards the micropylar end of the ovule starts from 1 DPA on and was nicely demonstrated with S.E.M. by Stewart (1975). This may be an expression of polarity along the longitudinal axis of the ovule that perhaps is linked with hormonal influences. The resulting orientation is irreversible and mature fibers will generally form a sharp angle with the seed surface.

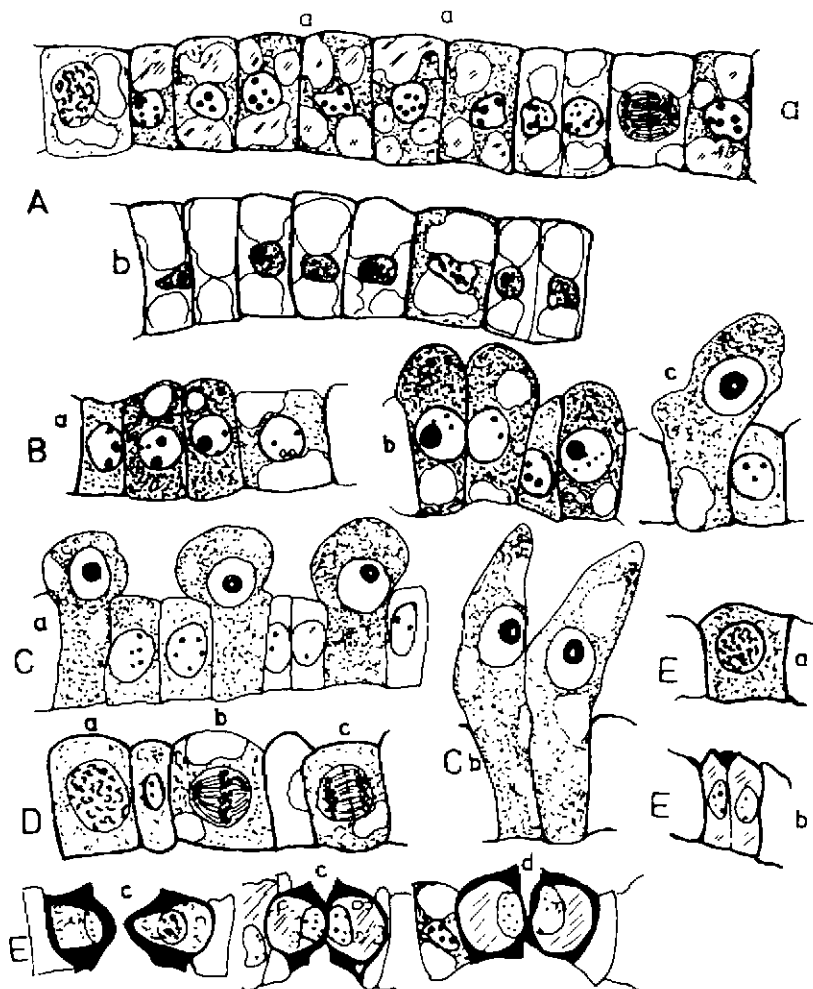

Figure 1. Outer epidermal layer of the cotton ovule during the period of lint fiber initiation.

- A. Epidermal layer of cotton ovule one day before anthesis. a, fiber primordial cells; b, cells which will divide the next day, red staining nucleus.
- B. Fiber initiation. a, dark type cells, beginning of initiation; b, initials four and c, 28 hours after anthesis (*G. hirsutum*)
- C. Fiber initials of *G. barbadense*. a, four and b, 28 hours after anthesis.
- D. Mitotic figures. a, prophase; b, metaphase; c, late anaphase.
- E. Stoma formation. a, mother cell; b, daughter stoma cells; c, stomata of *G. barbadense*; d, stoma of *G. hirsutum* (after Kechagia, 1977)

Also during this early period, the fibers will form small clusters, their tapering tips adhering to each other, with a certain contortion of the rapidly elongating fibers as a result. This is indeed clearly shown on S.E.M. prints made by Stewart (1975). This contortion generates a spiral configuration of the fiber "tube", and this configuration may have important consequences with respect to protoplasmic streaming and cell wall building.

At about 14 DPA, a typical *G. hirsutum* fiber is already more than 20 mm long and about 20  $\mu\text{m}$  wide; this means a more than 2000-fold volume increase. The thin primary wall and the no less thin cytoplasmic layer enclose a gigantic vacuole. From the very first days after anthesis on, the large nucleus will remain midway between base and tip, which after all seems to be the best position for control of the total fiber activity.

Such enormous and almost uni-dimensional cell growth can only be explained by the combination of at least three exceptional conditions: a considerable metabolic activity, the fast and constant uptake of large amounts of the substance needed for this activity, and the constant formation of a continuously extending and strong primary wall.

## ULTRASTRUCTURAL ASPECTS

Many indications of a very high metabolic activity were revealed by electron microscope studies of the fiber cells during the elongation period (Ramsey and Berlin, 1976b; Westafer and Brown, 1976). The cytoplasm contains many lipid bodies, small vacuoles, plastids, mitochondria, single ribosomes, free polysomes, endoplasmic reticulum and dictyosomes with electron dense mature-face cisternae. These dictyosomes are numerous and appear along the entire length of the cytoplasm layer during the elongation phase. Other ultrastructural details can be found in Chapter 26.

Similarities in the nature of membranes are apparent between dictyosome-associated vesicles and plasma membrane-associated vesicles. Many dictyosome vesicles contain "fibrils" morphologically similar to "fibrils" found in the plasma membrane-associated vesicles and in the primary wall, suggesting that dictyosomes are active in both primary cell-wall and plasmamembrane formation. The endoplasmic reticulum is involved in the formation of the central vacuole.

## THE NUCLEOLUS: A DRIVING FORCE

As discussed by Kosmidou (Chapter 25), the size of the spherical nucleolus of elongating fibers increases exponentially during the first days postanthesis to a maximum diameter of some 8-10  $\mu\text{m}$ . This maximum size is maintained for several days then decreases gradually, but nucleolus diameters of more than 2  $\mu\text{m}$  can still be observed at 30-40 DPA. In the same chapter the role of phytohormones in fiber development is discussed: gibberellic acid (GA) in combination with auxin exerts a powerful growth stimulation during the very first days after

anthesis, while a constant presence of auxin in the absence of GA seems to be needed for continuation of fiber elongation, and perhaps for secondary wall formation too. Abscisic acid (ABA) can counteract these stimulations, especially during the elongation phase (Dhindsa *et al.*, 1976).

The nucleolus is probably a major site of action of these hormones on fiber development (DeLanghe *et al.*, 1978). Generation of new nucleolar material should be stimulated by GA, but the resulting ribosomal RNA needs to be translocated into the cytoplasm. This output should be stimulated by auxin. Finally, ABA can stimulate output too, but will counteract the GA-action.

Differentiation of the equation for daily fiber growth gives a curve for the rate of fiber growth as a function of days postanthesis. The shape of this curve is rather similar to the shape of the curve expressing nucleolar diameter as a function of days post anthesis (Figure 2). Two main differences between these curves appear: the maximum fiber growth rate is generally reached a few days later than the maximum nucleolus diameter, and fiber growth rate is almost zero at 30 DPA while the nucleolus, although small, still exists at 40-50 DPA.

The link between nucleolus activity and fiber growth can be understood as

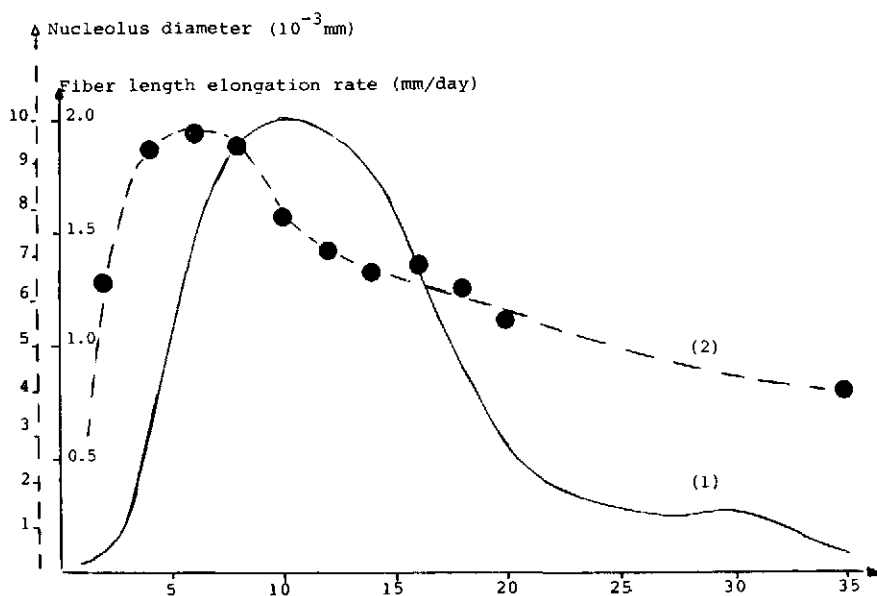

Figure 2. Changes in nucleolus diameter and in fiber elongation rate on the chalazal end of ovules of *Gossypium hirsutum*, cv. 4S.

(1) Mean fiber elongation rate in mm per day (after Michaelidis, 1978)

(2) Mean nucleolus diameter in  $10^{-3}$ mm.

follows: fiber growth rate is almost the direct expression of the total metabolic activity of the expanding cell. The metabolic activity is not only a function of enzymatic activity and of substance availability but in the present case is probably much more dependent on the quality of available enzymes. The quantity of enzymes produced per unit of time is obviously a function of the quantity of active ribosomes (polysomes), and this quantity depends on the nucleolus activity. Given the sequence "nucleolus-ribosomes-enzymes x substrate-expansion", the fiber growth rate should indeed follow in time the change in nucleolus activity. The remaining nucleolus activity between 30 and 50 DPA should be necessary for secondary wall formation, another expression of the metabolic activity.

When the size of the nucleolus as a function of days postanthesis is differentiated, the resulting curve expresses the rate of change in the size of the nucleolus and shows a sharp peak during the first 48 hours after anthesis. This is exactly the brief period when gibberellic acid (GA) exerts the observed strong stimulation of total fiber growth. It is indeed very tempting to locate the site of action of GA in the nucleolus.

The precise mechanism by which the hormones are functioning in the nucleolus needs specialized fundamental research. Although the action of phytohormones on other cellular parts such as plasma-membranes is certainly not precluded here, the amount of work done in this area is considerable, and the results are still rather meager and contradictory. It would perhaps be worthwhile to look for a location of hormonal action in and around the nucleolus.

### THE SUBSTRATE SUPPLY

Since the primary walls of elongating fibers are apparently not in direct contact with a vascular system or with a "nutrient" medium, the amounts of substrate needed for the impressive metabolic activity must be supplied by the vacuole. It is, however, not clearly understood how substrate uptake can keep pace with such a rapidly growing vacuole.

The base of the fiber, where this uptake is supposed to occur, does have a special shape. During the early elongation phase, this base is transformed into a "shank" deeply anchored in the epidermal layer, with a "foot" spreading out broadly beneath the surrounding cells of the outer integument. (Fryxell, 1963, 1964). In later stages the secondary wall deposition will extend into this foot, leading to the impression that the cell does not need further contact with the ovule for the final development.

During the elongation period, turgor pressure should obviously play an important role. Potassium malate, partly coming from dark CO<sub>2</sub>-fixation reactions, was found largely responsible for this turgor in cotton fibers (Dhindsa *et al.*, 1975). Increase in the activity of the involved enzymes (phosphoenolpyruvate carboxylase, a malate dehydrogenase and glutamic oxaloacetic transaminase) was due entirely to GA<sub>3</sub> when unfertilized ovules of the day of anthesis were cultivated *in vitro*. Abscisic acid (ABA) counteracted these GA<sub>3</sub> effects (Dhindsa, 1978b).

Cotton fiber cells maintain very high turgor during the whole period of their expansion, yet, gibberellic acid is effective only during the first days. This seems to exclude a direct activation of the forementioned enzymes and points to the possibility of a more basic action, perhaps again on the level of nucleolar activity.

## THE PRIMARY WALL AND ITS EXTENSION

Transverse sections of elongating fibers show primary walls which remain consistently less than half a micron in thickness. In many cultivars the cells have a cylindrical shape with an almost constant perimeter along more than 80 percent of the length. Tip-growth would permit rigidification of the "older" lower parts of the cell, but it is now evident that, like most other plant cells, the primary wall appears to be deposited evenly and simultaneously on the entire fiber surface (O'Kelly, 1953; O'Kelly and Carr, 1953; MacLachlan, 1977; Ryser, 1977).

## CHEMICAL COMPOSITION

In the pectic fraction, protein, glucose and uronic acid are predominant. The hemicellulose fractions contain glucose, uronic acids (fraction 1), galacturonic acid, glucose, arabinose, galactose and rhamnose (fraction 2). Finally, the  $\alpha$ -cellulose fraction contains glucose, xylose, galactose and rhamnose (Huwyler *et al.*, 1979).

The relative importance of these constituents changes during elongation. The amount of hemicelluloses increases many times and reaches a maximum in absolute weight at the end of the elongation period. While the absolute content in protein of the primary wall increases during elongation, especially in the hemicellulose fractions (Huwyler *et al.*, 1979), the percentage of nitrogen in the cellulose fraction decreases from 0.5% at about 4 DPA to 0.1% at 21 DPA (Nowak-Ossorio *et al.*, 1976). The most interesting change found by Meinert and Delmer (1977) was the large increase in non-cellulosic glucose, which seemed to be a 3-linked glucan, just prior to the onset of secondary wall deposition. According to them, a sharp decline occurs in protein and uronic acid content at the time of the onset of secondary wall, which, as will be seen later, starts well before the end of elongation.

## THE MICROFIBRIL

The basic structural unit of the wall is the microfibril. Some confusion exists in terminology since names such as cellulose fiber, elementary fibril, microfibril, fibril, are applied for the same or for different objects. Bundles of microfibrils, shown electron-microscopically in degraded cotton walls, correspond to the "fibrils" seen in optical microscopy (Kinsinger and Hock, 1948; Willison and Brown, 1977). An extracted primary wall, obtained by elimination of non-cellulosic material, shows the typical woven network of these microfibrils and microfi-

bril bundles. The interwoven pattern makes the length of the individual microfibrils of the cotton wall difficult to evaluate. Most reports agree that the microfibril should be 10-30 nm wide, 5-10 nm thick and several microns long, but some authors still consider such a microfibril as an aggregate of elementary fibrils (called cellulose fibers by Albersheim, 1975), which should be only 3.5 nm wide (Rollins, 1968b).

On the inner side of the primary wall, next to the plasmalemma, the microfibrils are oriented nearly transversely to the cell axis in two more or less opposed directions, while they lay parallel to the axis on the outer side. Both the size and the number of microfibrils increase with the age of the primary wall. These fibrillar dimensions and orientations are considered to be common in the primary walls of the growing cells in most plants. Albersheim (1975) developed the well-known model of primary wall structure from fundamental studies on walls of sycamore cells grown in suspension culture. According to his model cellulose fibers (elementary fibrils) are composed of 40 straight cellulose chains and are linked to parallel chains of rhamnogalacturonan by bridges of xyloglucans and arabinoglucans. While the general application of this model to all primary walls of dicotyledons is uncertain, the fact that galactose and xylose are resistant to even careful isolation from the cellulose of the cotton fibers (Nowak-Ossorio *et al.*, 1976) supports a comparable situation.

### PRIMARY WALL EXTENSION

The mechanism of primary wall extension can be understood by combining the Albersheim model with the so-called "multinect-theory" of Roelofsen (1959), according to which the microfibrils move outwards across the primary wall from inside to outside, changing meanwhile their orientation from nearly transverse to parallel with the axis. This occurs in successive lamellae, following the synthesis of new microfibrils. Albersheim suggested that, as the microfibrils slide past one another, covalent bonds in the crosslinking polysaccharides are repeatedly broken and new bonds formed in order to maintain the strength of the wall. This system depends also on the systematic insertion of newly synthesized polymers (Albersheim, 1975; Albersheim *et al.*, 1977). In such conditions and since the outer microfibrils are parallel with the axis, no lateral extension should be possible once the outward microfibril movement acquires the final orientation: the fiber will keep its perimeter and tubular shape throughout elongation. This critical shape-forming period may occur at 1 DPA when longitudinal growth starts to dominate the lateral expansion, perhaps due to the forementioned polarity of the fiber tips towards the micropyle. According to Willison and Brown (1977), the more recent theories for wall growth, proposed by Boyd and Foster (1975) or Roland *et al.* (1975), are not suitable for cotton fiber walls.

The rate of primary wall extension appears thus to be based on two parameters: the rate of synthesis of new microfibrils and related polysaccharides and the rate of reciprocal microfibril movement. The cellular framework for such continual



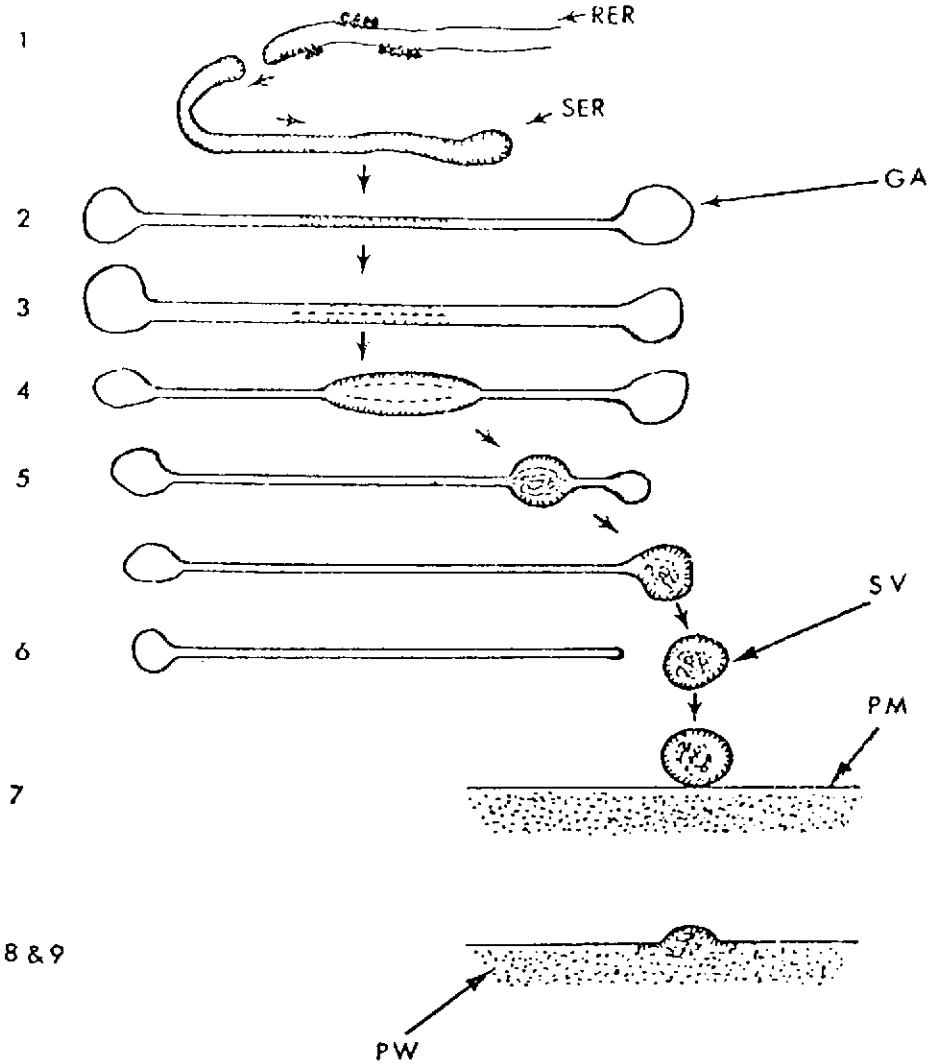

Figure 3. Cross-sectional model of primary wall synthesis in the cotton fibre. The different steps of the primary wall synthesis are explained in the text under the item "Primary wall extension" (after Westafer and Brown, 1976).

synthesis and assembly of the primary wall components is partly a matter of speculation, although great progress was made during the last decade in the study of this process, and ingenious techniques were used in the analysis of various cell

walls. New cellulose is inserted into the inner surface of the cell wall at multiple sites (loci) during growth. From the Albersheim model, one can deduce that both microfibrils and the linking polysaccharides should be synthesized simultaneously since the xyloglucan forms an integral part of the microfibril and since rhamnogalacturonan is a long chain, parallel to the 40 cellulose chains (elementary fibers). Consequently, microfibrils and the associated polysaccharides seem to be constructed at one end of their complex and elongate by tip growth.

R. Malcolm Brown, Jr. and co-workers (Westafer and Brown, 1976; Willison and Brown, 1977) propose the following attractive schemes for primary wall building and extension in the growing cotton fiber cell (Figure 3):

“Synthetases for matrix substances and, perhaps, for cellulose are made in the endoplasmic reticulum. (1) These enzymes are transferred to the Golgi apparatus via membrane flow and are incorporated within the inner surfaces of the cisternal membranes. (2) Substrates in the cisternae of the Golgi apparatus react with enzymes bound to the cisternal membranes, forming incipient secretory products. (3) The products are released from the inner surfaces of the cisternal membrane into a central dilatation. (4) The dilatation moves laterally, transporting the products and membrane to the periphery of the cisterna forming a nascent secretory vesicle. (5) The secretory vesicle separates from the cisterna and migrates to the plasma membrane. (6) The membranes of the secretory vesicles and the plasma membrane fuse and the product is released via exocytosis. (7) The products are incorporated into the growing primary cell wall; and enzymes (perhaps including cellulose synthetases) transported within the secretory vesicle become exposed to the cell exterior where they initiate synthesis while: a) attached to the membrane, or b) existing free in the periplasm, or c) attached to components of the cell wall itself.” Plasmamembrane bounded microfibril synthesizing centers move in the plane of the plasma membrane, spinning out microfibrils as they go. These microfibril synthesizing centers move along a slow helical path towards either end of the fiber such that thin lamellae consisting of uninterrupted microfibrils are produced. The helices of these lamellae are alternatively left-handed and right-handed. Extension of the fiber tends to increase the pitch of the helices, giving rise to the netlike patterns described in multi-net-growth.” (Westafer and Brown, 1976)

Fiber elongation presupposes, apart from the high extensibility of the primary wall, a considerable increase of the surface of the various membranes. The observations of Ramsey and Berlin (1976b) and Westafer and Brown (1976) clearly show that the numerous dictyosomes of the Golgi apparatus continually supply new membrane both to the plasmalemma and to the tonoplast by intercalary addition.

Finally, given the constant strength of the primary wall, the microfibrils need to be reconnected repeatedly during their movement (Albersheim, 1975). Albersheim proposes that auxin-induced expansion promotes the cleavage of the arabinan-galactan and that growth may involve the insertion of new wall material into the cleaved cross-connecting arabinan-galactan (Albersheim *et al.*, 1977). But, there is still no clear evidence for the mechanism by which the cleavage and recombination proceeds. He speculated that an enzyme in the wall mediates the transfer of bonds between polysaccharides, and that it could promote growth specifically. As yet, no such enzyme has been identified, and until it is found, "we will remain in the dark as to the exact nature of cell wall-loosening" (Cleland, 1977).

## THE OVERLAPPING PHASE

### SIMULTANEOUS ELONGATION AND WALL THICKENING

Early observers (Balls, 1915; Anderson and Kerr, 1938; Rollins, 1968a,b) stated that secondary wall thickening starts after the cessation of elongation. Evidence is now accumulating for the fact that secondary wall thickening begins before the completion of fiber elongation (Benedict *et al.*, 1973; Schubert *et al.*, 1973; Kohel *et al.*, 1974a; Meinert and Delmer, 1977). Since the observations were based on mean data, such as substantial increase in dry lint weight per seed during further increase of halo length, one could argue that the evidence does not necessarily mean that the overlapping occurs in individual fibers. Indeed, one can suppose that an increasing number of fibers stop elongation and start wall thickening while a decreasing number continue elongation with only a primary wall. But, Schubert *et al.* (1976) found in *G. barbadense*, cv. "Pima S-4", that by the time elongation ceased, almost 90% of the final lint dry weight per seed had been reached. Moreover, in a careful study of lint elongation on cultivars of *G. hirsutum* and *G. barbadense*, the surface of the seed was subdivided into 9 regions, and lint length measured during the entire elongation period (Michaelidis, 1977). This study clearly showed that elongation rate was strictly synchronous on the whole seed, despite the different lengths per region, and that elongation ceased for all seed regions at about the same day postanthesis.

The deduction from the combination of these results is evident: overlapping of elongation and secondary wall formation occurs at the level of the individual fiber. This conclusion is of fundamental importance for a better understanding of the two processes, the production and extension of the primary wall and the building of the secondary wall, which apparently occur simultaneously during a large time span.

### GRADUAL AND ABRUPT CHANGES IN WALL COMPOSITION

In her study of the degree of polymerization (DP) in cotton fiber walls, Marx-Figini (1966a) found that the DP starts to increase at about 15 DPA, reaching a

plateau of DP 1400 just before 20 DPA. Cellulose biosynthesis increased around 10 DPA and became important at about 16 DPA. It is, however, hazardous to assemble indications of early secondary wall activity from various literature sources since different laboratories worked with different cultivars or even species. Environment too has a definite influence on the rate of elongation and of wall thickening.

Overlapping of elongation and thickening could mean gradual changes in the related metabolism and a gradual increase in cellulose, for instance. But Meinert and Delmer (1977) found rather abrupt changes in the rate of cellulose increase with a first peak at about 16 DPA followed by a decrease for 2 days and then a sustained increase culminating at about 27 DPA. The synchrony of lint elongation (Michaelidis, 1977) and the fact that fuzz fibers probably do not begin secondary wall deposition before the true fibers (Beasley, personal communication), seem to exclude influence of heterogeneity in the material used for cellulose analysis. Moreover, the decrease in elongation rate was less at about 15-16 DPA in cultivars of two *Gossypium* species (Michaelidis, 1977). Glucan synthetase activity shows a sharp peak between 15 and 19 DPA (Delmer *et al.*, 1977) and, as will be explained further, its first product is most probably not cellulose but  $\beta$ -1, 3-glucan which may be an intermediate in the synthesis of cellulose. A study of environmental influences also gave results that fit best with the concept of fundamentally different factors controlling elongation versus secondary wall deposition (Gipson and Joham, 1968b).

Given the different indications, it seems better to abandon the idea of "smooth transition" between elongation and thickening and to accept that a new process is starting rather abruptly during the elongation period. The fiber forms an integral part of a complex assembly: the seed. The fuzz and the non-fiber epidermal cells also start secondary wall formation at 16-19 DPA (Beasley, personal communication; Berlin, 1979). At about the same period, the embryo begins to expand rapidly, soon followed by a spectacular weight increase (Ihle and Dure, 1970). Thus, the entire seed shows a change in metabolism, resulting among other things in the onset of secondary wall deposition in the lint fibers. (See Chapter 20 for more detail on related events during development of the boll). A causal relationship, in the sense that this onset of secondary wall deposition should progressively inhibit further elongation (Meinert and Delmer, 1977) is possible but not evident (Schubert *et al.*, 1976). The acceleration of the elongation rate stops at about 5 DPA. The rate is constant until about 12 DPA, then decreases thereafter (Michaelidis, 1977). No other parameter is in fact needed in order to explain the "phasing out" of elongation.

## THE S<sub>1</sub>-LAYER

The first layer of the secondary wall is distinct from the subsequent ones in many aspects: the terms "winding layer" (Hock *et al.*, 1941) or "S<sub>1</sub>-layer" are frequently used for it (Figure 4). It is said to serve as a transition layer between

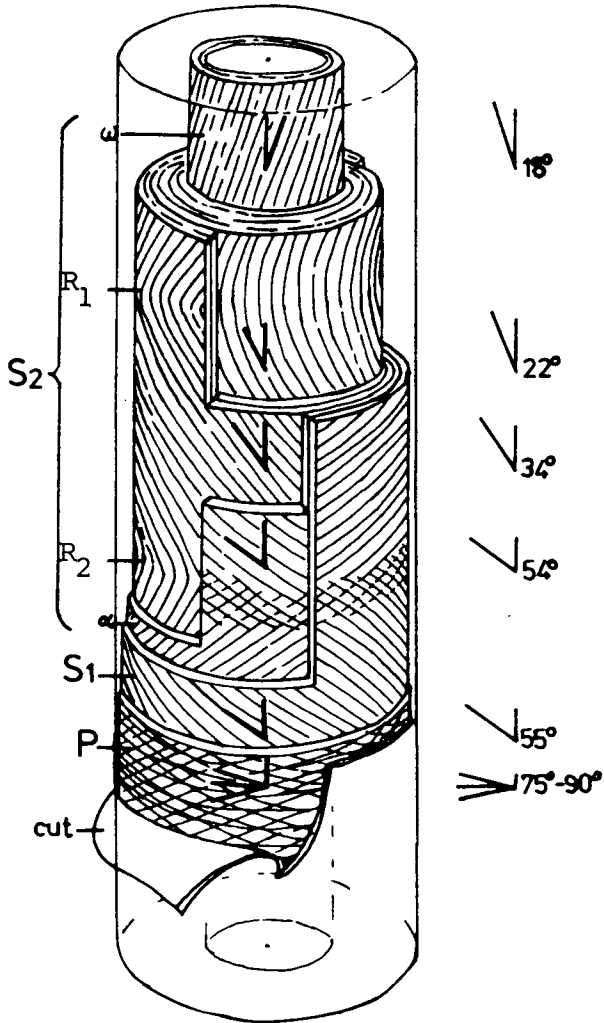

Figure 4. Schema of a mature lint fiber.

Cut = cuticula

P = Primary wall

S<sub>1</sub> = S<sub>1</sub>-layer

S<sub>2</sub> = secondary wall, layers S<sub>2α</sub> to S<sub>2ω</sub>

R<sub>1</sub> = reversal with bended fibrils.

R<sub>2</sub> = reversal with fibrils "crossing" or meeting on opposed fibril angle.

55° = fibril angle

(after Waterkyn, 1974)

the network of the primary wall and the oriented fibrils of the following layers, called  $S_2$ -layers (Rollins, 1968b). The fibril angle is generally wider than in the  $S_2$ -layers, but much smaller than the angle of the primary wall microfibrils. Most striking however is the fact that the fibril helix of the  $S_1$ -layer is opposite to that of all the following  $S_2$ -layers. Observation of the  $S_1$ -layer is difficult and normally requires a swelling treatment by cuprammonium hydroxide (Cuoxam). If fibers are oxidized first with "4%  $KMnO_4 + H_2SO_4$  droplets" and then swollen with Cuoxam, the primary wall and the cuticle separate in helicoidal bands. The underlying  $S_1$ -layer determines the S or Z orientation of these bands and their helical angle with respect to the fiber axis (Waterkeyn, 1974). With  $NO_2$ -oxidation, the primary wall and  $S_1$ -layer split into fine fibrils or into broad spiral bands (Rollins, 1945). In fibers swollen with Cuoxam, the primary wall and the  $S_1$  layer both play a part in restricting uniform swelling of the wall (Kerr, 1946). All this could indicate that  $S_1$ -deposition is more related to the primary wall than to the true secondary wall (Rollins, 1945). The  $S_1$  layer could be detected as early as 10 DPA on unswollen fibers and was made up of a system of bands or tapes lying at "an angle" to the axis of the fiber (Rollins, 1968a). So long as secondary wall deposition was considered to occur only after cessation of the elongation, such early presence of  $S_1$ -traces was confusing. Willison and Brown (1977) suggest that the  $S_1$  layer may simply represent that part of the secondary wall which has undergone extension. But cross sections of fibers at 19 DPA show considerable secondary wall (Schubert *et al.*, 1973). Since 40-50 percent of the final dry weight can be reached by the end of the elongation period (between 25 and 30 DPA), much more than the  $S_1$  layer must have been deposited. Moreover, the helix-orientation of  $S_1$  has consistently been found to be opposed to that of the so-called  $S_2$ -layers, but not necessarily on all parts (Kerr, 1946). The difficulty of understanding the  $S_1$ -layer phenomenon is obviously connected to the compromise between the production of a still extending primary wall and that of a secondary wall which tends to be rigid.

## THE SECONDARY WALL

### PHYSICAL COMPOSITION

Cross sections of mature fibers, swollen with e.g. cuprammonium hydroxide, show a series of concentric layers, the number of which correspond roughly with the duration in days of secondary wall formation. They were called "daily growth rings" (Balls, 1919).

Kerr (1937a) proposed that these rings consist in fact of two layers: a compact one associated with a warm growth-period during daylight, and a more porous one formed during cool night hours. Indeed, with decreasing contrast in temperature between day and night, the rings become less apparent or even disappear (Berriman and Benedict, 1963). Grant *et al.* (1966) showed that fibers grown under constant temperature conditions are ringless, regardless the light, and that only

the fluctuations in temperature are responsible for rings. The interest in this temperature controlled layering increased with the suggestion of Dupre (1959) that elongation of the fibers under high load, as well as reversibility of such extension, are made possible by the slipping of the layers.

Grant and co-workers (Grant *et al.*, 1966, 1970, 1972) proved however, that absence of rings does not lead to major changes in physical properties. The team considers "growth rings" as artifacts, since the rings are revealed only after treatment with cupriethylene diamine or with cuprammonium hydroxide. These are solvents of cellulose, so they suggested that the rings are a result of differences in the dissolution rates of cellulose deposited at low versus high temperatures.

However, even in ringless fibers, a fundamental layering appeared indirectly as sheets of lamellae when walls were fractured after various manipulations (Tripp *et al.*, 1951; Isings, 1964). According to Grant *et al.* (1970) the associated preferred plane of shear could be the real regions for "internal movement in the cotton fiber with the helical fibril arrangement". Polymerization of methacrylate in fiber cell walls results in expansion, and a pattern of concentric layers 35 nm thick is seen. Grant *et al.* (1972) suggested that these are the basic layers.

Construction of microfibril bundles is much more important in the secondary wall than in the primary wall. The bundles with microfibrils still fasciated (Willison and Brown, 1977) run parallel at an angle to the axis that decreases from the outside to the inside (Waterkeyn, 1974). Willison and Brown (1977) observed an undulation of the bundles with comparable wavelength in both the primary and secondary walls but with a much reduced amplitude of 20-40 nm in the secondary wall.

Complexes of microfibril bundles appear under the optical microscope as "fibrils" with the typical helicoidal arrangement. A unique feature of cotton fiber cells is the intermittent change in the direction of the twist of the helix. These "points" are called "reversals". At most reversals the orientation of the fibrils changes abruptly toward an opposed direction, with each fibril apparently bending along an arc (Figure 4 R<sub>1</sub>). At other reversals, two helices of opposed directions encounter at the section-plane and fibril ends seem to overlap (Figure 4 R<sub>2</sub>) (Anderson and Kerr, 1938).

## CHEMICAL COMPOSITION

Data on the chemical composition of cotton fiber walls are based on the analysis of entire walls, primary wall included. But, the comparison of the composition of maturing fibers with that of elongating ones leads to the conclusion that hemicelluloses and pectic substances must be very rare in the secondary wall. The fact that an arabinogalactan was isolated from fibers at the stage of intensive secondary wall formation (Buchala and Meier, 1981) should not be misunderstood. As the authors noted, even in that stage the hemicellulose is located either in the primary wall or in the cytoplasm. An important decrease was found in the absolute amounts of hemicelluloses in the fiber walls during the period of secon-

dary wall thickening (Huwyler *et al.*, 1979). This fact seems to exclude any presence of hemicelluloses in the secondary wall.

Marx-Figini (1966b) found that the degree of polymerization of the cellulose throughout the period of secondary wall building was constant and much higher (14,000) than the DP of primary wall cellulose (1000-3000). In *G. herbaceum* crystallinity of the cellulose appears at 20 DPA, increases rapidly and remains constant from 25 DPA on. (Nowak-Ossorio *et al.*, 1976).

Large differences in crystallinity should not mean that celluloses of the primary versus secondary wall are different. In both cases, the celluloses may consist of native cellulose I crystals, but in the primary wall these crystals will have a poor lateral organization of the network of inter-chain hydrogen bonds (Chanzy *et al.*, 1978).

### THE PROCESS OF SECONDARY WALL FORMATION

The considerations about physical and chemical composition point to the high probability that the difference between primary and secondary wall construction is the result of two basically different cellulose assemblage systems. Willison and Brown (1977) detected granules of 20-30 nm diameter bound to the outside of the plasmalemma of maturing lint fibers which they considered as comparable to the globules associated with the ends of microfibrils in corn roots (Mueller *et al.*, 1976). They suggested that groups of microfibrils are synthesized close together spatially and temporally. The globules on the outside of the plasmalemma may be enzymic complexes concerned with this synthesis and assembly of the cellulose microfibrils (Willison and Brown, 1977).

As they move across the cell surface, they would add new glucan to microfibril ends (Willison, 1978). The constant DP, together with the fact that cellulose fractions of the secondary wall contain a constant amount of a protein which cannot be removed by available isolation techniques, led Nowak-Ossorio *et al.* (1976) to the conclusion that each cellulose chain is firmly attached with its synthesis apparatus. This deduction was supported by the results of Huwyler *et al.* (1979). If this is so, microfibril bundles of secondary walls are increasing in length by tip growth, and glucose residues are added to them simultaneously at all the cellulose chains they contain.

In an attempt to explain the changes in fiber strength at or between the reversals, Raes *et al.* (1968) proposed a model for the origin of the reversal. They postulated that during elongation, a number of "growth sensitive annular rings" appear at irregular distances along the fiber axis. Cellulose would be synthesized either on both sides of such rings with opposite helical deposition of fibrils and "curved fibril-reversals" at the site of the ring, or on one side only (towards base or tip of fiber) with a sequence of helices in the same or opposed directions and "over-lap-reversals" in the areas where the growing "zones" would meet. The Raes-model fits well with the strength behaviour of individual fibers, and its adaptation to include recent findings about cellulose synthesizing sites is possible.



The annular rings should be "synthesizing zones" which should actually move along the cell surface in the proposed directions. The genesis of the rings should occur during the second period of elongation when secondary wall formation starts (see Overlapping Phase). However, a number of questions subsist, irrespective of the present precarious position of the "mobile synthesizing zone". For example, why is orientation of the helix of the  $S_1$ -layer opposed to that of the rest of the secondary wall, and why does the helix angle decrease from out-to inside throughout the secondary wall?

### THE CYTOPLASM

Important changes in the cytoplasm occur during the period of secondary wall formation (Berlin, 1970; Ramsey and Berlin, 1976b; Westafer and Brown, 1976). At 30 DPA, very little cytoplasm is recognizable, dictyosomes have almost disappeared and the numerous unattached ribosomes seen during the elongation phase are replaced by endoplasmic reticulum (ER) associated ribosomes in a spiral polysomal configuration. There are indications that ER membranes acquire characteristics which may permit fusion with the plasmalemma. Microtubules, which are rarely observed during the elongation period become numerous during secondary wall thickening. They look "attached" to the plasmalemma and are oriented parallel to the microfibrils. That microtubules should control the orientation of cellulose deposition is still a matter of controversy (Preston and Goodman, 1968; Newcomb, 1969; Chafe and Wardrop, 1970; Robards and Kidwai, 1972; Picket-Heaps, 1974; Sterling, 1975). It has, however, been found that in cotton fibers, the microtubules do parallel the microfibrillar pattern even through the reversals (Yatsu and Jacks, 1981). If this observation is confirmed, then the arrangement of microtubules in the cytoplasm needs careful study. Since the direction of the fibrils in the  $S_1$ -layer is opposed to that of all the other fibrils, it would be necessary that a general switch in microtubular orientation occur at a particular "moment" after anthesis.

The hormone ethylene is known to control the direction of cell growth, probably through its effect on microfibril orientation (Richmond *et al.*, 1980). Ethylene treatment has been shown to change the orientation both of microtubules near the plasmalemma and of recently deposited cellulose microfibrils in pea epicotyl cells (Lang *et al.*, 1982). Changes in ethylene content during cotton boll development have been demonstrated (Guinn, 1982). Further study on the possible role of ethylene on microtubule orientation in developing lint cells could be beneficial for a better understanding of microfibril orientation in the secondary wall.

### CELLULOSE BIOSYNTHESIS

Although cellulose is one of the most widespread substances in the plant kingdom, its biosynthetic pathway is still not known, despite many attempts to find the precursors and the enzymes involved (Delmer, 1977). The massive secondary wall of cotton fibers with almost pure cellulose is an obvious tool for

such study, and several recent publications have dealt with cellulose synthesis in cotton fibers grown *in vitro* or *in vivo*.

At the onset of secondary wall formation in cotton fibers a sharp rise in non-cellulose glucose, together with a substantial increase in cellulose, was clearly observed by Delmer (1976). A "UDP-glucose: glucan synthetase" proved to be highly active in the early secondary wall formation period. Under *in vitro* growth conditions this enzyme produced a glucan with predominantly  $\beta$ -1,3 linkages (Heiniger and Delmer, 1977). The *in vitro* rates of glucan synthesis in the detached fibers during development is within the range of the *in vivo* rate of cellulose synthesis (Delmer, 1976). Huwyler *et al.* (1978) detected large quantities of  $\beta$ -1,3-glucan (callose) in naturally grown 20-40 DPA old fibers. Delmer suggested that a very active turnover from a  $\beta$ -1,3-glucan into cellulose occurs during secondary wall formation, since  $\beta$ -1,3-glucans, such as callose, normally do not have a structural role. But, in a later publication (Maltby *et al.*, 1979) she and her group announced that pulse-chase experiments failed to show any indication of such turnover. With intact cotton fibers, Meier *et al.* (1981), also using the pulse-chase method, did find a high turnover of callose. By means of a specific fluorescence method, Waterkeyn (1981) showed that the callose is always localized in the innermost layer bordering the cell lumen and can be found throughout the entire period of secondary wall thickening. He postulated that most plant cells normally possess a permanent noncellulosic sheet or interface just outside the plasmalemma. In this "matrix" the newly synthesized cellulose chains and/or microfibrils undergo a sort of "maturation" and are oriented before their definitive incorporation in the highly organized cell wall. He suggests also that the amorphous glucan, which is callose, may contribute to the cell wall plasticity, promoting the gliding and passive shifting of the wall microfibrils. Given the overlapping phase when elongation and secondary wall deposition occur simultaneously for many days, "stress situations" seem unavoidable along the entire cell wall, and callose may play a key role as a sort of "lubricating" agent.

The question to what extent callose turnover leads to cellulose synthesis is still open. The (1 $\rightarrow$ 3)  $\beta$ -D-glucanases detected by Meier *et al.*, (1981) are not necessarily working as transglucosylases. Indeed, it was demonstrated by Carpita and Delmer (1981) that the rate of synthesis and turnover of UDP-glucose was more than sufficient to account for the combined rates of accumulation of sucrose, steryl glucosides,  $\beta$ -1,3-glucan and cellulose. In other words, there would be no need for transformation of callose into cellulose. On the other hand, one should not overlook the fact that the so-called "dead fibers", where no trace of a secondary wall is seen, even at the period of boll maturity, contain considerable amounts of callose (Waterkeyn, personal communication).

## DEHYDRATION OF THE COTTON FIBER

When mature cotton bolls open, the fibers lose their water content and dry out; the tubular cell becomes a twisted ribbon with a kidney-like cross-section. The way fibers have developed may greatly influence the drying pattern. Yet, the dehydration process irreversibly generates many important technological properties of the cotton fiber. For instance, the angle of the many twists, the convolution angle, is negatively correlated with fiber tenacity (Duckett and Goswami, 1979), and the extensibility of normal dry fibers is two to three times less than that of never-dried ones (Berkley and Kerr, 1946). It has even been assumed that most of the crystalline cellulose is formed by dehydration (Colvin, 1972), but never dried fibers are already highly crystalline (Ingram *et al.*, 1974). These last authors found also that the dehydration leads to irreversible hydrogen bonding between the microfibrils, and that this molecular change is responsible for the loss in "slippage" between fibrils, and thus, for loss in extensibility.

A real bilateral structure of these dried fibers was observed by Kassenbeck (1970) after enzymatic degradation. This asymmetry was further examined by Waterkeyn (De Langhe *et al.*, 1979). Dry fibers, treated with alkaline solutions, shorten considerably and "uncollapse". In polarized light such fibers show two opposite helicoidal lines, indicating the demarcation between two alternating helicoidal ribbons. These lines are formed by highly crystalline cellulose fibrils which twist in the same direction as the convolutions and change their direction at the reversals. They were observed on fibers dried as early as 22 DPA (Waterkeyn, 1974). The two ribbons between the lines correspond to the convex (dorsal) and the concave (ventral) side, and drastic action by degrading agents shows that their walls have unequal resistance which is much lower than that of the double helix.

The accessibility of the dried fibers to chemical reagents is, consequently, very unequal and related to the twisting. The key question unanswered is whether the twists are the consequence of an initial heterogeneity created during fiber development, and if so, when exactly and how, or is the heterogeneous structure just the result of mechanical "force-fields" created during the dehydration? Reversals might play a role in the creation of such unequal tensions (Ingram *et al.*, 1974).

## COTTON FIBER POPULATIONS

### NORMAL DISTRIBUTION OF FIBER LENGTH IN SEED COTTON

Important differences in length exist among the thousands of fibers on a single seed. This variation represents up to 98% of the total variation in the harvest of an inbred cotton line (Richmond and Fulton, 1936). Part of this variation is due to difference among regions of the seed where the mean fiber length decreases from chalazal end towards the micropylar end (Iyengar, 1939, 1941a, 1947; Krishnan and Iyengar, 1960). That other properties such as breaking load, weight, diame-

ter and maturity also vary along the regions of a seed was stressed by Moore (1941) who used the term "fiber population". Similar results were obtained by Iyengar (1941b) for different cotton species.

Variation in fiber length, ranging from less than 1 cm up to more than 6 cm in *G. barbadense* cultivars, is a serious hindrance for yarn and fabric manufacturing (Berkley, 1949). It also complicates the evaluation of characteristics such as maturity and fineness.

Fiber length distributions in samples of bale cotton are almost always asymmetric and negatively skewed in as much as the samples contain a large number of short to very short fibers. Even the usual comb sorter methods for measuring fiber length will give the asymmetric frequency distribution. Yet, the shape of the cumulative frequency curve thus obtained is considered as characteristic for cotton varieties (Christidis and Harrison, 1955).

Length variation was found to be correlated with variations in other properties such as perimeter, maturity, fineness, strength, fibril angle and convolution angle, all of which play a part in the ultimate quality of a yarn (Iyengar, 1939; Petkar *et al.*, 1977; Morlier *et al.*, 1951; Warwicker *et al.*, 1966; Lord, 1961; Hessler, 1961). With an asymmetric frequency distribution, the global expression of a fiber characteristic in terms of mean length, mean maturity, etc. . . . are almost useless. This has led to elaborate methods which attempt to correctly express the total variation in the characteristic under study (Lord, 1961).

In contrast to bale cotton samples Wakeham (1955) found that cotton fibers, as they grow on the cotton seed, are in fact remarkably uniform and that the distribution of fiber length is normal. The fundamental importance of this observation, with respect to the understanding of variation and characterization of cotton fibers, may have been somewhat overlooked. When, from any region of the cotton seed, a group of about 200 fibers is carefully pulled out with tweezers and the length of the fibers measured one by one, a normal frequency distribution of fiber length is observed. This normal distribution has been confirmed during two growth seasons for a number of cultivars representing the 4 cotton species, *G. hirsutum*, *G. barbadense*, *G. arboreum* and *G. herbaceum* (De Langhe *et al.*, unpublished results). Variation in fiber elongation appears to occur at random along the whole surface of a cotton seed. Near the micropyle the fibers are indeed much shorter, and coarser too, but the amount of these fibers is minimal, and they are certainly not a cause of significant deviation from normality of the distribution.

The effect of mechanical lint removal processes, including comb sorting, is breakage of an important number of long fibers. This points to the importance of the attachment force of the fiber to the seed (Burkitt, personal communication). Strong attachment should lead to preferential breakage at a weak point along the fiber. About 16 percent of the fibers can break during mechanical removal, and a somewhat higher percentage of the remaining basal parts break again during subsequent removal (Lord, 1963). The difference in asymmetric fiber length

frequency distribution between cotton varieties after mechanical removal is probably a reflection of differences in fiber attachment.

### MORPHOGENETIC RELATIONS BETWEEN LINT CHARACTERISTICS

Many attempts have been made to determine if relations exist among the fiber properties with technological importance, such as length, maturity, fineness, tensile strength. Knowledge of these relations would enable technologists to program better any treatment of the cotton before manufacturing yarn and fabric. Breeders and cotton growers, on the other hand, would be able to "translate" the properties in terms of controllable morphological selection criteria. Unfortunately, many contradictory results came out of these studies. Maturity was found to be either positively (Petkar *et al.*, 1977; Rajaraman and Nanjundayya, 1955; Pillay and Shankaranarayana, 1961) or negatively correlated with fiber length (Fiori *et al.*, 1959; Kechagia-Michailidou, 1977). Analogous situations appeared for other properties, but it was realized that many of them may be the result of different instrumentation or manipulation (Nanjundayya, 1951; Grant and Morlier, 1948; Chytiris, 1961; Calkins, 1961; Iyengar, 1961; Fiori *et al.*, 1961) or sampling (Morlier *et al.*, 1951). Moreover, some relation trends depend on the cotton species (Iyengar, 1939). Some of the contradictions can be explained by the fact that, in some cases, samples from several cultivars were examined (intervarietal relation), while in other cases, the research material contained only fibers of one and the same cultivar (intravarietal-relations). It is well known that the longer fibers of *G. barbadense* do have a smaller perimeter, when compared with fibers of *G. arboreum*. But such a relation obviously cannot automatically be applied to a fiber population from the same cultivar.

A major part of the complication may well be associated with the artificial creation of the asymmetric fiber length distribution. Long fibers develop at the chalazal end of the cotton seed, and they are frequently less mature (Michaelidis, 1977). With mechanical fiber removal, these fibers can break several times and "produce" numerous pseudo-short and less mature fibers. It is easy to see how this artifact can complicate the pattern of maturity, fineness, fabric strength, etc.

Comparison of mean lengths and mean perimeters of fibers from different regions of a seed gave a negative correlation, but different cultivars gave different inclinations for the linear regressions (Michaelidis, 1977; DeLanghe *et al.*, 1979). Such indication of a dimensional relationship of fibers on the level of a seed needs further study in view of its potential importance for the explanation of the other characteristics. On the basis of the regression of fiber length on fiber perimeter, fiber volumes and fiber surfaces can be calculated. With the exception of the small number of short fibers at the micropylar end, variation in fiber volume on a seed surface may be rather small, consequently, fibers with the same volume may develop different wall surface areas and secondary wall thicknesses, depending on the ratio between length and perimeter.

A positive correlation was found by Kechagia-Michailidou (1977) between

fiber perimeter and the perimeter of the fiber initials. Conclusively, a major part of the variations in many fiber properties may be generated through the original variation in the size and growth potential at about the anthesis period of those epidermal cells which differentiate into lint fibers. As for other technologically important characteristics, Duckett and Goswami (1979) for instance, demonstrated that changes in the ratio of fiber perimeter to wall thickness are responsible for deviations from the normally negative correlation between fiber tenacity and the degree of convolution.

## LINT PRODUCTION AND LINT QUALITY

### ENVIRONMENTAL AND GENETIC STRESSES

Many links between environment or genotype and lint development are perhaps simple and clear, but they are complicated by observations performed on mechanically removed fibers, since this technique leads to the artificial asymmetric frequency distribution of fiber properties. Results dealing with stress influences should, therefore, be considered with caution since they may not reflect biological reality. Thus, much global information about these influences in classical handbooks on cotton is still of current value (Christidis and Harrison, 1955; Elliott *et al.*, 1968).

The rates of fiber elongation and of secondary wall thickening are both influenced by temperature. The optimal temperature for fiber elongation is surprisingly low and very rarely exceeds 25C (O'Kelly and Carr, 1953; Hessler *et al.*, 1959; Morris, 1962; Stockton and Walhood, 1960). Contrary to earlier statements, Gipson and Joham (1969) found that fiber elongation is temperature sensitive during the first days after anthesis and becomes temperature independent after 15 DPA. (See Chapters 5 and 20 for additional discussions and interpretations). Smutzer and Berlin (1979) confirmed in *G. hirsutum* L. var. Dunn 56C that fiber elongation was optimal at 15C, and that fiber initiation under 10C or 25C conditions resulted in shorter elongating cells, less apparent electron dense polyphenolic compounds, retardation of vacuole formation and a lower amount of endoplasmic reticulum. An analogous parabolic trend in temperature influence was found for different varieties by Gipson and Joham (1968). Cultivars with longer fibers were more sensitive for lower temperatures (Gipson and Ray, 1969; but see Stewart, Chapter 20).

A comparable trend exists in the relation between temperature and various properties of the secondary wall but at a higher temperature level. In experiments with constant growth conditions, Grant *et al.* (1966) found the shortest period between flowering and boll opening (41 days) was at 29.5C and with constant light. Fibers grown at 21C had thinner walls, less compact cellulose, lower extensibility and lower crystallinity measured by X-ray angle (Grant *et al.*, 1970).

According to Gipson and Joham (1968) the night temperature should play a key role. Most influences are linked with the rate of cellulose synthesis (Hessler *et*

*al.*, 1948), but contradictions appear. Rapidly developing cottons are likely to be strong (Hessler, 1961), but late plantings in the season on the Texas High Plains, meaning growth under lower temperature conditions, gave shorter but stronger fibers (Bilbro and Ray, 1973). It may be stated with Hessler (1961) that "anything less than optimum fiber development under varying environmental conditions can conceivably result in innumerable types of fiber structure". Since secondary wall development in fibers and in other epidermal cells of the same cotton seed is synchronous (Berlin, 1979), the temperature dependent rate of cellulose synthesis is probably only a part of a more general temperature dependence at the level of the cotton boll. Higher night temperatures shorten the boll maturation period while incomplete boll maturation is due to low minimum night temperatures (Yfoulis and Fasoulas, 1978). But, the phenomenon cannot be explained in simple terms of lower photosynthate availability, since at these lower temperatures an increase in sugars is observed parallel to the decrease in cellulose synthesis (Hessler *et al.*, 1959).

The influence of humidity on fiber development is less well documented. Higher humidity conditions during fiber development result frequently in longer fibers with lower tenacity and higher reversal density, but varietal interaction can be strong (Fransen and Verschraeghe, 1967). The same authors found that irrigation increased significantly the reversal density in the three varieties observed. Buxton *et al.* (1973) found that dry growth conditions led to shorter fibers but had no effect on fineness or strength.

Increase in light intensity from 4000 to 60,000 lux can result in the doubling of the rate of cellulose synthesis (Marx-Figini, 1966b). Such high rates are not necessarily beneficial for wall quality. Rapidly formed walls in 30-35 days old bolls on plants grown under glasshouse conditions showed a lower tensile strength for the same or even greater thickness than more slowly formed ones (DeLanghe *et al.*, 1979).

## THE NEED FOR "LINT QUALITY" GENERATING MODELS

For many crops grown all over the world, yield, including resistance to diseases and adverse growing conditions, plays a dominant role in the related agronomic research. For the cotton plant both lint quality and yield are important in the economic evaluation of the product.

Excellent models which simulate plant growth have been elaborated for cotton, and they have been worked out down to the level of lint percentage of the boll weight (Jones *et al.*, 1980; Constable and Rawson, 1980). Current research aims also at improving the morphogenetic aspects in the simulation of cotton plant growth (Mutsaers, 1982; See also Chapter 19).

McArthur *et al.* (1976) advised that future research should be oriented towards improving the subsystems of these models. One such subsystem seems to be the differentiation of the lint weight into computable components that can be combined in quantitative expressions of the lint quality. Efforts have been made

in this direction, and differentiation of yield and quality of the lint into their basic components is an example (Ramey, 1970; Worley *et al.*, 1974; Ramey and Worley, 1973; Turner *et al.*, 1979). If models which generate the lint quality can be elaborated and interfaced with the plant growth models, the subsisting terminological barrier between cotton growers and fiber technologists should progressively disappear.

## SUMMARY

A comprehensive survey of lint development is provided with emphasis on the results of research done during the last ten to fifteen years on differentiation, elongation and secondary wall formation. The importance of these results for the fundamental knowledge of cell differentiation and cellulose biosynthesis is emphasized.

The various processes involved in the development of a typical lint fiber are discussed in the first part, while the variation of typical development is the subject of the second part, under the headings: "Cotton fiber populations" and "Lint production and lint quality".

## ACKNOWLEDGEMENTS

Research in Belgium on cotton fiber development was made possible with grants from the Collective Fund for Fundamental Research and from the International Institute of Cotton. The following laboratories are concerned: Laboratorium voor Tropische Plantenteelt (E. De Langhe) Faculty of Agricultural Sciences, Catholic University, Leuven; Laboratoire de Phytotechnie Tropicale (J. Demol) State Faculty of Agricultural Sciences, Gembloux; Laboratorium de Meulemeester voor Technologie der Textielstoffen (G. Raes), Faculty of Applied Sciences, State University of Ghent; Laboratoire de Cytologie et de Morphologie Vegetales (L. Waterkeyn), Faculty of Sciences, University of Louvain, Louvain-la-Neuve.



## Chapter 24

# STRESS INFLUENCES ON FIBER DEVELOPMENT

Harmon H. Ramey, Jr.<sup>1</sup>  
USDA—ARS  
New Orleans, Louisiana

## INTRODUCTION

The cotton fiber develops from a single epidermal cell of the seed coat (Stewart, 1975). The cell elongates for approximately 20 days and then deposits secondary wall for a subsequent 20 or more days (Ramey, 1980; Walhoo and Addicott, 1968). The two processes appear to overlap (Schubert *et al.*, 1973). This biological system has constraints; otherwise, a fiber cell would elongate infinitely and/or the secondary wall would develop such that the fiber cell becomes a solid cylinder. A given cultivar grown in a given environment will produce fibers of a given length and a characteristic amount of secondary wall deposition. Therefore, it can be inferred that fiber length and secondary wall deposition are under genetic control. The growth environment determines whether or not the fiber length and secondary wall deposition reach the potential of the genotype. Departures from optimum growth conditions, or stress, affect the ultimate dimensions. For purposes of this discussion the term "stress" is used for any departure from optimum growth and fruiting conditions.

## MORPHOLOGICAL PROPERTIES

Cotton evolved in the subtropics where the plants grow as perennials (Hutchinson *et al.*, 1947). In less than 300 years, upland cottons (*Gossypium hirsutum* L.) and Egyptian and Pima types (*G. barbadense* L.) have been adapted to annual culture so that the major production areas are now in the temperate regions (Lewis and Richmond, 1968).

The annual growing cotton plant can be visualized as an inflorescence on a root system. The vegetative part of the plant is less than eight nodes of the main stem (Ewing, 1918). On the average, blooms appear at three-day intervals on the first node of successive fruiting branches up the stem and at six-day intervals at successive nodes on a given fruiting branch (Tugwell and Waddle, 1964). (For details of this process see Chapter 2). Because of the sequential development of

<sup>1</sup>Presently with USDA-AMS, Memphis, TN

the plant, at a given time fibers in some bolls will be elongating and fibers in other bolls will be depositing secondary wall. Thus, stress at a given time will affect the elongation of some fibers and the secondary wall deposition of other fibers on the same plant. For this reason, the effects of stress on cotton fiber growth and development are difficult to assess when all bolls on a plant are sampled for fiber measurements. When individual bolls are considered, stress during the elongation phase will cause shorter fibers and during the wall deposition phase will cause thinner secondary walls. The latter condition is frequently referred to as immaturity. Specific factors that influence fiber growth and development are treated separately in the following.

### MINERAL NUTRIENTS

The extension or elongation of the cotton fiber is dependent on turgor pressure within the cell. Potassium and malate, which accumulate in the fiber and reach peak levels when growth rate is maximum, can account for more than half the osmotic potential (Dhindsa *et al.*, 1975). In field fertilization experiments additions of some potassium fertilizer increased both fiber length and cell wall development (Bennett *et al.*, 1965, 1967; Nelson, 1949). Additional increments of potassium fertilizer had little effect on either. Potassium deficiency caused shorter and lesser developed fibers.

Nitrogen fertilization has been shown to increase fiber length (Jackson and Tilt, 1968; Wadleigh, 1944) although others have observed little or no effect from nitrogen (MacKenzie and van Schaik, 1963; Nelson, 1949). Additions of boron have been shown to increase secondary wall deposition (Anderson and Boswell, 1968). The effect of nitrogen or boron deficiency is probably on the development of the plant rather than on the fiber directly. This contrasts to potassium deficiency which alters the osmotic potential of the fiber cell itself and thereby reduces the length development. Good management practices that prevent mineral element deficiencies eliminate this source of stress. (See also Chapters 9, 10, 20 and 21).

### TEMPERATURE

Cotton growth and development are affected by temperature. Boll period, the time from open bloom (anthesis) to open boll, increases as temperature decreases (Gipson and Joham, 1968a; Yfoulis and Fasoulas, 1978). Night temperatures generally exert more effect than day temperatures (Gipson and Ray, 1969b). However, the effect is not unidirectional because day temperatures above about 32C can increase boll period (Yfoulis and Fasoulas, 1978). Johnson and Wadleigh (1939) reported increases in yields with increases in July average maximum temperature up to 35C and decreases in yields as the July average maximum temperature exceeded 35C. These findings support the concept that there is an optimum temperature for cotton growth and development and that growth will decrease at temperatures above and below this optimum. The optimum is not well defined but may be a characteristic of a cultivar.

Generally, the average temperature declines from the time of boll set until boll opening in most production areas of the northern temperate zone. Typical decreasing temperatures for Lubbock, Texas are shown by Bilbro and Ray (1973). Decreasing temperatures have a retarding effect on elongation and cell wall development (Hawkins and Serviss, 1930).

Night temperatures below 22C increase the time required for fibers to reach the genetic potential for length (Gipson and Joham, 1969a; Gipson and Ray, 1969a). The maximum length of fiber was obtained when night temperatures were between 15 and 21C and reduction in length occurred above and below this temperature range (Gipson and Joham, 1968b; See Chapter 5).

Decreasing night temperatures affect cell wall development more than fiber length (Gipson and Joham, 1968b). The low-temperature effects on cell wall development are more pronounced in the northern temperate zone because of the sequential development of the fiber. Bolls are set in the warmer part of the season and mature under decreasing temperatures, particularly bolls set later in the season. In an area where the bolls set during six weeks, the mass per fiber declined from the second to the sixth week of boll set (no data were reported for the first week of set) (Turner *et al.*, 1979). Planting time affects fiber development by influencing the period at which the majority of the bolls are set. Bilbro and Ray (1961) showed that the micronaire reading, an indication of cell wall development, was highest (more development) in fiber from April 20 plantings and was lower (less development) in fibers from plantings after June 1. Bolls set later in the season produced fibers with lower micronaire reading (Hessler *et al.*, 1957, 1959). The micronaire reading of fiber produced in the warmest of three environments was highest (Quisenberry and Kohel, 1975). These results should be expected because micronaire reading was reduced by reducing night temperature below 25C (Gipson and Joham, 1968b; Gipson and Ray, 1969b).

Conner *et al.* (1972) demonstrated that lower temperatures can affect plant processes involved in fiber formation. Soluble sugars were present in higher concentration in bolls less than 15 days postanthesis from plants grown with 25C night temperatures than in the same age bolls from plants grown at lower night temperatures. There were more soluble sugars present in 40-day old bolls grown at 10C and 15C than in those same age bolls grown at 20C and 25C. These data indicate that low night temperatures affect the production or accumulation of sugar and may affect the use of sugar in fiber development.

In the subtropics, blooms occur during the cooler part of the season (Mauney and Phillips, 1963). Fibers elongate in cooler temperatures and deposit the secondary wall in increasing temperatures. The temperature optima of 15 to 21C for fiber elongation and above 25C for fiber wall deposition favor fiber development in subtropical conditions. However, in temperate regions to which cotton has been adapted, the fibers elongate in the warmer part of the season and deposit secondary wall in decreasing temperatures. The physiological processes have not been sufficiently altered in the adaptation to an annual temperate culture to prevent

stress on the developing fiber. The stress occurs because the temperature trends in the temperate region culture are opposite to the temperature optima for fiber development.

## MOISTURE

Inadequate or excess moisture can affect the growth of the cotton plant and, thereby, the fiber. Although excess moisture is usually not considered stress, Jackson and Tilt (1968) reported shorter fibers from plots in Arizona which were irrigated every 7 days than from plots irrigated at 14-day intervals. When the irrigation interval was extended to 21 or 28 days, the fibers were shorter than those from the 14-day irrigation interval. Drought or deficient moisture tends to reduce fiber length (Bennett *et al.*, 1967; Eaton and Ergle, 1952, 1954; Marani and Amirav, 1971; Shimshi and Marani, 1971; Sturkie 1934, 1947). Increased amounts of moisture tend to increase fiber length (Grimes *et al.*, 1969; Newman, 1967; Spooner *et al.*, 1958). However, in many cases alterations of moisture regime do not affect fiber length, as was mentioned in several of the above cited reports and by Bilbro (1962). Only when plants were severely stressed in the early blooming stage were substantial effects on fiber length noted (Jackson and Tilt, 1968; Marani and Amirav, 1971).

Some moisture deficit may not affect cell wall development (Sturkie, 1947). However, soil moisture deficit or excess throughout the season can reduce micronaire reading (Jackson and Tilt, 1968). Drought may or may not affect micronaire reading, but a severe drought or moisture deficit will reduce micronaire reading (Eaton and Ergle, 1952; Marani and Amirav, 1971; Shimshi and Marani, 1971). Lower micronaire readings were obtained from increased soil moisture (Eaton and Ergle, 1954; Grimes *et al.*, 1969; Shimshi and Marani, 1971; Spooner *et al.*, 1958). Adequate soil moisture increases micronaire reading (Bennett *et al.*, 1967; Marani and Amirav, 1971; Spooner *et al.*, 1958).

The effects of moisture stress on fiber development are difficult to ascertain. Moisture deficit reduces yields by reducing plant development (height) and the number of bolls per plant. The plant tends to compensate for lack of moisture by shedding fruiting forms and, thereby, to some extent alleviating stress on the remaining fruiting forms. The effects of short periods of moisture deficit or excess may not be reflected in a sample from the total production. However, a deviation from optimum moisture will cause shorter fibers with less-developed cell walls in bolls which are in the stage to be affected. The optimum moisture has not been defined. (See Chapter 7 for additional discussion on water deficit.)

## LIGHT INTENSITY

Leffler (1976) reported that bolls did not gain mass during a period of overcast sky. The period of low light intensity occurred during secondary wall deposition. It is not known whether the cessation of mass accumulation resulted in less secondary wall deposition nor whether the secondary wall deposition continued to

the usual limit after the period of overcast sky. Also, it is not known what effect the period of overcast sky would have had on fiber length if it had occurred during the elongation of the fiber cell. The overcast sky must have reduced photosynthesis and, thereby, materials for boll synthesis. Shade has been shown to increase fiber length and reduce micronaire (Eaton and Ergle, 1954). The shade effect may have been indirect by reducing temperature slightly since the effects on fiber were similar to those that result from cooler temperatures.

### PESTS AND PESTICIDES

Most insects and diseases cause shedding or destruction of the fruiting forms or bolls that result in yield losses rather than altered fiber properties. Two diseases, however, cause changes in fiber development similar to severe moisture deficit. *Phymatotrichum* root rot reduces secondary wall development but does not alter fiber length (Eaton *et al.*, 1946). *Verticillium* wilt reduces both fiber length and micronaire (Bugbee and Sappenfield, 1970; Cotton, 1965).

Generally, insecticide applications do not affect fiber properties (Finley *et al.*, 1964), but some effects have been noted. Application of Guthion at low rates, Guthion plus DDT and Dieldrin plus DDT increased micronaire (Hacskaylo and Scales, 1959). Guthion plus DDT application also reduced fiber length. How these insecticides act to cause the altered fiber properties is unknown but the effects are similar to those from increased temperature.

Santelmann *et al.*, (1966) found that applications of herbicides did not affect fiber properties.

### GROWTH REGULATORS

Application of the growth inhibitor, maleic hydrazide, tends to reduce wall development (Ergle and McIlrath, 1952). Defoliants are growth regulators which cause abscission of leaves. Premature application of defoliants will reduce micronaire reading (Tharp *et al.*, 1961) and can reduce fiber length (Brown and Hyer, 1956). If the bolls are beyond 80 percent of the boll period when the defoliant is applied, only a minimal effect on micronaire reading can be detected (Walhood and Addicott, 1968). (See chapters 13 and 14 for information on growth regulators.)

### GENOTYPE INTERACTION

Differential responses of cultivars to temperature have been noted. Gipson and Joham (1968b) found Paymaster 54B more tolerant to lower night temperature than Acala 1517BR-1. The average daily gain in fiber mass per boll at 8C was greater in Paymaster 54B than in Acala 1517BR-1, but at 25C it was greater in Acala 1517BR-1. Elongation rates of fibers of three cultivars were influenced more by lower night temperatures than were those of two other cultivars (Gipson and Ray, 1969a). Quisenberry and Kohel (1975) demonstrated differences among cultivars in fiber development at lower temperatures. These examples

illustrate that some genotypes tolerate a specific stress better than do others.

Plant morphology can affect the ability of a cultivar to withstand stress. Hawkins and Peacock (1968) reported that two cultivars produced longer fiber when grown in a solid planting pattern; whereas, most cultivars produced longer fibers when grown in a skip-row configuration. There should be less stress for the plants in a skip-row planting pattern because the plants would have more space. The two exceptional cultivars both produce larger bolls and fewer bolls are required to achieve a given yield level. The fewer bolls could be set in a shorter time period (Tugwell and Waddle, 1964), and the fibers could reach ultimate length before stresses affect fiber elongation. These same cultivars grown in skip-row planting pattern produced more bolls, and the yields were higher. If the temperatures were higher later in the blooming period, the fibers may have been shorter due to the effect of higher temperatures (Gipson and Joham, 1968b). The cultivars that produce smaller bolls would require more time for boll set and lack of moisture due to the spacing could have caused the shorter fibers in the solid planting pattern as compared to the skip-row planting pattern. The morphology of the plant can affect the ability of a genotype to escape stress.

There is a genotype effect in the response to stress. Some genotypes have the inherent ability to tolerate a specific stress more than other genotypes. Some genotypes can escape a specific stress because of certain morphological features. Specific stresses can be alleviated more readily with certain genotypes than with others.

## MECHANICAL PROPERTIES

The mechanical properties (strength and elongation) of the cotton fiber are affected by the amount of secondary wall deposition. Waterkeyn *et al.* (1975) have shown the angle of cellulose fibrils to the major axis of the fiber decreases from the primary wall inward. Evaluation of cotton fibers in flat bundle tests involves the application of a force in the direction of the major axis. The composite angle of the fibrils to the major axis influences the amount of strain (elongation) the fiber will undergo before rupture. The applied force tends to straighten the fibrils toward the major axis. Fibers whose secondary wall deposition has been arrested by some factor will exhibit greater elongation-to-break than fibers whose secondary wall deposition has proceeded to the normal limit. The composite angle of the fibrils in the less developed secondary wall will be greater, and the change in angle due to applied force will likewise be greater. It should be noted that elongation-to-break is not necessarily recoverable elasticity. Data of Nelson *et al.* (1980), Ramey *et al.* (1982) and Rousselle *et al.* (1980) illustrate the reduced elongation-to-break of fibers that have greater secondary wall development.

Most fiber strength data are from flat bundle tests and are reported in a breaking force-to-mass ratio, either as tenacity or Pressley Index converted to pounds per square inch. The effect of secondary wall thickness on tenacity are

illustrated in Figure 1. The maturity levels, 1 through 4 are 1.27, 1.94, 2.48 and 2.59  $\mu\text{m}$  secondary wall thicknesses, respectively (Ramey *et al.*, 1982). When the jaws of the breaking clamps are closely appressed, zero gauge or  $T_0$ , the lowest tenacity is for the fibers with the least secondary wall development. In contrast,

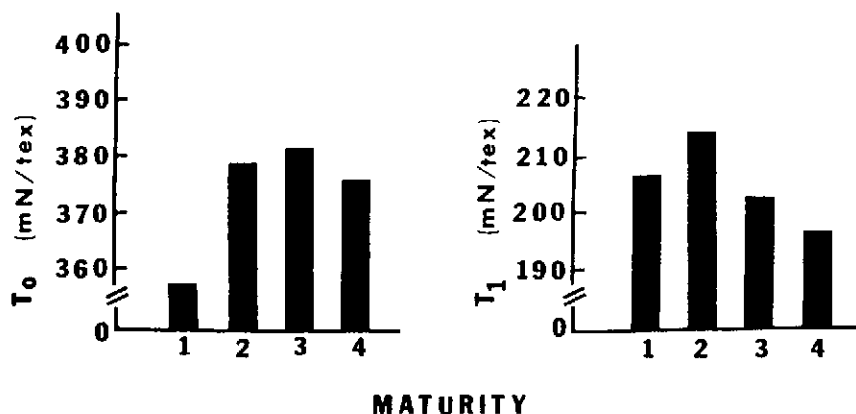

Figure 1. The tenacity of cotton fibers of four maturities.  $T_0$  is the tenacity in flat bundle tests where the clamping jaws are closely appressed, zero gauge.  $T_1$  is the tenacity in flat bundle tests where the clamping jaws are spaced 3.2 mm apart. The maturities 1, 2, 3 and 4 are 1.27, 1.94, 2.48 and 2.59  $\mu\text{m}$  wall thicknesses, respectively. (Data from Ramey *et al.*, 1982.).

when the jaws of the breaking clamps are spaced 3.2mm apart, 3.2 gauge or  $T_1$ , the lowest tenacity is from the fibers with the greatest secondary wall development. Several reports indicate that fiber tenacity at 3.2 gauge is higher for lower micronaire reading samples (Bilbro and Ray, 1973; Jackson and Tilt, 1968). Hessler *et al.* (1957, 1959) reported increased zero gauge tenacity for higher micronaire reading samples. These results strongly suggest that fiber strength is affected only indirectly by stress. Factors that affect secondary wall development affect fiber strength.

When flat bundle test data are converted to force-to-break of individual fibers, the breaking force increases in direct proportion to secondary wall thickness. There was more than two-fold increase in breaking force as the secondary wall increased from 1.27 to 2.59  $\mu\text{m}$  for both zero and 3.2 gauge (Ramey *et al.*, 1982). A fiber which has developed under stress conditions and, thus, has less secondary wall development is less resistant to breakage in processing. Short fibers generated by breakage during processing cause problems in the processing and reduce product quality.

## DISCUSSION

Stress, defined as deviation from optimum conditions, affects the growth and development of the cotton fiber. The effects of stress on the fiber are, for the most part, indirect. Stress affects the plant, and through the effect on the plant, affects the fiber. The fiber is an appendage of the reproductive unit, the seed. The developing reproductive unit is a stronger sink for the plant's resources than are the developing vegetative units. Thus, the fiber is usually less affected by stresses than are the other parts of the plant. For example, Grimes and Yamada (1982) have shown that under conditions of limiting moisture the growth and development of fiber (elongation and secondary wall development) continued at lower moisture availability than did main stem elongation. Many of the conflicting reports of the effects of stress on fiber morphology are due to the stresses acting on the plant and indirectly on the fiber. On the other hand, conditions that are optimum for growth of the plant are also optimum for growth of the fiber. Jackson and Tilt (1968) reported the longest fibers from treatments that produced the highest yields. This concept can be used to design cultural systems to produce optimum quality fiber as well as optimum yields for the genotype (Ramey, 1970). The sequential development of the fiber (Walhood and Addicott, 1968) and of the plant (Tugwell and Waddle, 1964) must be used in the design of systems. The blooming period is about six weeks (Turner *et al.*, 1979). Boll-development periods increase as the temperature increases above 32C (Yfoulis and Fasoulas, 1978) or decreases below 25C (Gipson and Joham, 1968a; Gipson and Ray, 1969b). The time when stresses must be minimized to produce optimum quality fiber range from 13 to 17 weeks. The cultural system must be fitted to the favorable parts of the growing season (Ramey, 1970). Stresses can adversely affect fiber quality, but the use of a system to alleviate stresses during critical times can enhance the production of quality fiber.

The work of Yfoulis and Fasoulas (1978) strongly suggests that genotypes have an optimum temperature range of about 15.5C. Two groups of genotypes were identified; one which develops well between 16.5 and 32.0 C, and another which develops well between 15.0 and 30.5C. Gipson and Ray (1969b) and Quisenberry and Kohel (1975) identified genotypes that are more tolerant of cooler conditions. These observations suggest that genotypes can be developed for specific temperature ranges.

In developing cultural systems to alleviate stress at critical times, the capabilities of the genotypes must be considered. The cultural system may have to be adapted for each cultivar.

## SUMMARY

The cotton fiber develops sequentially to a characteristic length and secondary wall thickness for the genotype. Deviations from optimum conditions or stresses



influence how near the fiber develops to the characteristic length and wall thickness. Fruiting forms appear on the plant at three-day intervals on the first nodes of successive fruiting branches up the plant and at six-day intervals at successive nodes out a fruiting branch. At a given time there are bolls on a plant in which the fibers are elongating and other bolls in which the fibers are depositing secondary wall. The timing of the stress of deviation from optimum conditions determines whether length or wall thickness is affected.

Potassium and malate are the major contributors to the osmotic potential of the developing fiber cell. Potassium deficiency limits fiber length. Other mineral nutrients affect fiber properties through action on the plant.

Fiber properties are probably more affected by temperature than any other environmental factor. The optimum range for fiber length development is 15C to 21C and shorter fibers are produced in temperatures above or below this range. The optimum temperature for cell wall deposition is above 25C. Bolls set late in the season in the north temperate zone produce fibers which deposit less secondary wall. The temperature optima are characteristic of short-day plants from the subtropics and have not been altered in the adaptation to an annual culture in temperate regions.

Deficit or excess moisture can shorten fibers and lessen secondary wall deposition. The plant tends to compensate for moisture stress by retaining fewer bolls so the effects of moisture stress on fibers are frequently small.

Low light intensity caused by an overcast sky can slow down or stop fiber development. The effect of shade is similar to a slight reduction in temperature.

Two diseases, *Phymatotrichum* root rot and *Verticillium* wilt, alter fiber properties similar to severe moisture deficit. Other pests have little effect because injured bolls are shed. Some insecticides can alter fiber properties but the action is unknown.

Premature defoliation can cause shorter fibers and, more frequently, less wall deposition.

Genotypes differ in response to temperature. Specific morphological traits can enable certain genotypes to escape stresses.

Mechanical properties of fibers are affected by the amount of secondary wall deposition. Fibers with less secondary wall deposition will exhibit greater elongation-to-break. In flat bundle tests, immature fibers may exhibit greater strength than mature fibers when clamping jaws are spaced 3.2 mm apart but less strength when clamping jaws are closely appressed. Force-to-break of individual fibers increases directly with increases in wall thickness.

Conditions which produce the longest fibers usually produce the highest yields. Cultural systems designed to alleviate stresses can produce optimum quality fiber and optimum yield. Cultural systems may have to be adapted for each cultivar.

## Chapter 25

# HORMONAL INFLUENCES ON FIBER DEVELOPMENT

K. Kosmidou-Dimitropoulou  
Hellenic Cotton Board  
Athens, GREECE

## INTRODUCTION

Cotton fiber differentiation and development involves numerous biochemical, physiological and morphological changes. Many of these changes are discussed in detail elsewhere in this book (Chapters 20, 22, 23, 26 and others) and need not be repeated here. The phenotypic expression is determined by genotype, but the detailed development of fiber is determined by a combination of internal stimuli, hormonal inputs and external influences. Hormonal work with fibers has been concerned primarily with the two major phases of development, elongation and secondary wall deposition.

Some of the roles of hormones in the mechanisms of cell differentiation and growth have been documented and major progress has been made in characterizing their biosynthesis and metabolism; however, the exact mechanisms of action and interactions still are not very clear (Jones, 1973; Cleland, 1977; Osborne, 1978; Chailakhyan, 1979; and others). Numerous researchers have contributed to our knowledge of the hormonal influences on cotton fiber development (Beasley, 1973; Beasley and Ting, 1973, 1974; Baert *et al.*, 1975; Singh and Singh, 1975; Dhindsa *et al.*, 1976; Kosmidou, 1976; Jasdanwala *et al.*, 1977; Dhindsa 1978a,b; DeLanghe *et al.*, 1978). Also, much is owed to the laboratories which first successfully cultured *in vitro* cotton ovules with associated fibers (Beasley, 1971; DeLanghe and Eid, 1971).

## METHODS USED IN THE HORMONAL RESEARCH

The work done so far in cotton regarding hormonal effects has taken two approaches: (1) isolation, identification and measurement of hormones from bolls and ovules; and (2) external application of hormones *in situ* and *in vitro*.

A number of research workers have isolated gibberellins (GA), auxins (IAA, NAA), cytokinins (CK), abscisic acid (ABA) and ethylene (ETH) from cotton bolls and/or ovules with the associated fibers at different boll growth stages

(Carns, 1958; Addicott *et al.*, 1964; Dale and Milford, 1965; Sandstedt, 1971; Bhardwaj and Dua, 1972; Davis and Addicott, 1972; DeLanghe and Verneulen, 1972; Lipe and Morgan, 1973; Shindy and Smith, 1975; Guinn *et al.*, 1978; Rodgers, 1980, 1981a,b,c; Guinn, 1976, 1977, 1982). In most cases, if not all, the research was aimed at purposes other than correlation with fiber development, and provided little information about hormonal evolution in fiber alone. This work was valuable in establishing correlations with plant/boll growth stages, environmental and physiological relations, etc. Also, it helped to a certain degree with the investigations of hormonal influences on fiber development by giving a picture of the fluctuations of hormones occurring in the ovule, the developing embryo and the fibers.

As far as external application of hormones is concerned, two approaches have been followed: (1) treatment of intact plant with hormones; and (2) hormones administered to organ cultures *in vitro*.

Numerous investigations have been conducted to influence boll growth and consequently fiber quality by applying hormones and growth regulators exogenously to intact plants using a variety of techniques, e.g. spraying the whole plant, soaking the ovaries, or injecting hormones into the bolls (Bazanov, 1966; Bhardwaj and Sharma, 1971; Bhatt and Ramanujam, 1971; Bhatt *et al.*, 1972; Zur *et al.*, 1972; Yue-Quing *et al.*, 1980a,b; Kosmidou, 1981). Although plants often respond differently to growth regulators in field tests than to trials in greenhouses or growth rooms (Morgan 1980), in most cases the final goal is the beneficial and practical use of plant growth regulators in cotton production. Extending the duration of fiber elongation or secondary wall thickening and promoting the translocation of photosynthates to the fruits might significantly improve either the total yield or quality of the fiber. There are certain limitations, though, in applicability of this kind of approach because of the complexity of the whole plant system and the difficulty to eliminate or distinguish the effect of other factors which influence fiber growth. Processes like pollination, pollen tube growth, ovule fertilization, embryo and endosperm growth affect, to some extent, the internal hormonal inputs as well as fiber initiation and/or growth. The external application of hormones changes the internal hormonal level and balance, which, combined with the other internal and external parameters, may lead to artifacts. Failure to obtain yield increases from field application of plant growth substances may also be due in part to the fact that the indeterminacy of cotton's flowering habit almost precludes that the hormone(s) would be available at the required site at the time the fiber might have been favorably responsive (Beasley *et al.*, 1974). Consequently, information obtained from this kind of approach about the hormonal action on fiber growth is rather limited. Still, the mechanical prevention of flower pollination, and therefore ovule fertilization, which otherwise would cause boll shedding without externally applied hormones, does provide a suitable system for certain hormonal studies on fiber growth *in situ*. The appropriate

application of growth regulators (0.1 ml  $GA_3$   $10^{-2}M$  with or without 0.1 ml 2,4-D  $10^{-3}M$  per flower) after emasculation of the flower prevents shedding, and nearly normal boll and fiber growth occurs (Kosmidou, 1976).

The complexity due to plant participation in the *in situ* system is eliminated when isolated ovules and fibers are cultured *in vitro*. Recently a new technique has been developed in which polyethylene glycol could protect cellulose synthesis in detached cotton fibers (Carpita and Delmer, 1980). This technique may offer opportunities for hormonal studies even in detached fibers *in vitro*. The *in vitro* environment can be controlled completely, the exogenous influences can be eliminated, the nutrient as well as other requirements can be fulfilled, and the influencing factors can be identified and manipulated. Moreover, the *in vitro* cultures are fairly homogenous and readily obtainable in quantity. The contribution of certain laboratories in establishing the basic procedures for plant material production—aseptic transfer, appropriate nutrient media, environmental factors, etc.—was significant (Joshi, 1960; Mauney, 1961; Beasley, 1971; DeLanghe and Eid, 1971). Especially important in fiber development were the contributions from Beasley's (1971) laboratory. Most of the information available today about the hormonal influences on fiber growth are due to the research procedures which used his system. Fertilized and unfertilized ovules isolated from the mother plant at different stages—preanthesis, at anthesis, and later—have been cultured (and precultured for sequential hormone application) in media supplemented with several hormone combinations (Beasley, 1973; Beasley and Ting, 1973, 1974; Beasley *et al.*, 1974; Baert *et al.*, 1975; Kosmidou, 1976; Dhindsa *et al.*, 1976; Dhindsa 1978a,b; DeLanghe *et al.*, 1978).

## EFFECT OF HORMONES ON FIBER INITIATION

### HORMONAL INFLUENCES ON FIBER DIFFERENTIATION

There is evidence that gibberellins and auxins are important factors for fiber differentiation (Beasley and Ting, 1973, 1974; Kosmidou, 1976; DeLanghe *et al.*, 1978). It is well established that numerous ovule epidermal cells are differentiated into fiber initials on the morning of anthesis or later. The fiber primordial cells are first recognizable at about 16 hours preanthesis by the accumulation of phenolic substances ("dark" cells) and the higher cytoplasmic density attributed to a higher number of ribosomes (Ramsey and Berlin, 1976a,b; see also Chapter 26). It has been suggested that these phenolic substances are related to auxin metabolism and consequently may be involved in the initiation of cotton fiber differentiation. This is consistent with another report (Popova *et al.*, 1979) according to which larger amounts of phenolic substances are synthesized in ovules showing intensive fiber formation and elongation (early varieties) but none in ovules of a naked-seed type. Increase of o-diphenol oxidase activity occurred during fiber initiation (Naithani *et al.*, 1981), and the authors suggested that a shift in redox balance towards oxidation may play an important role in fiber

initiation. This hypothesis follows the general redox model of the mechanism of auxin action proposed by Arnison (1980), in which emphasis is given on the importance of phenolics as "auxin protector" substances and peroxidases as "auxin destructors." Stewart (1975), in explaining the directional growth of the fibers on a single ovule and the delay of initiation in the micropylar region, proposed either a hormonal stimulus to initiation originating at the crest of the funiculus and migrating towards the micropylar end along the polar alignment of the epidermal cells, or an inhibitor at the micropyle.

Unfertilized ovules isolated early on the day of anthesis before flower pollination and cultured *in vitro* did not produce fibers unless grown on medium supplemented with GA<sub>3</sub> and/or auxin (Kosmidou, 1976). Differences among three hormonal treatments were found in number of initials per ovule and in the elongation following initiation. Gibberellins (GA<sub>3</sub> at 3x10<sup>-6</sup>M) could induce the initiation of a normal number of initials (compared to *in situ*), but it could not stimulate as much elongation as when an auxin was also included in the medium. Auxin alone (2,4-D 3x10<sup>-6</sup>M or IAA 10<sup>-6</sup>M) could induce the initiation of fewer fiber initials per ovule than GA<sub>3</sub> could, but the subsequent elongation of the initials was greater (Kosmidou, 1976). The necessity of GA<sub>3</sub> during initiation was also shown in another study (Beasley, 1976) in which exposure to GA<sub>3</sub> for only a relatively short time (24 hours) before transfer to IAA was necessary for production of equal or nearly equal amounts of fiber compared to cultures with continual presence of both hormones. However, the amount of fiber produced by the end of the culture period decreased as the length of GA<sub>3</sub> preculture increased from 24 to 48 and 72 hours, indicating the need of IAA in addition to GA<sub>3</sub> during the very first days of fiber initiation and growth. Coinciding with and strengthening the *in vitro* results were the appreciable amounts of gibberellin-like substances found at anthesis in cotton fruit extracts (Rodgers, 1981c) and an auxin activity at anthesis which increased to a peak at day 3, decreased at day 5, and thereafter increased through 7-15 days (Rodgers, 1981a). Temperature and ammonium influence the response of unfertilized ovules to IAA as well as to GA<sub>3</sub> and IAA in combination in producing fibers *in vitro* (Beasley, 1977a). The influence of these three factors (NH<sub>4</sub><sup>+</sup>, temperature, hormones) was independent of the availability of reduced nitrogen as a general substrate for growth (Beasley *et al.*, 1979). Despite the current information on the importance of gibberellin and auxin in initiation and growth, more research needs to be done. Perhaps the difference between time of initiation for fuzz and lint fibers, the relatively distinct differences in length of the two fiber types and the much smaller nucleoli of fuzz fibers (see below), are due to sequential "perception" and relative amounts of effective endogenous auxins and gibberellins (Beasley, 1977b).

### FIBER NUCLEOLAR EVOLUTION AND HORMONES

During fiber differentiation and subsequent expansion the nucleus enlarges and the usually single nucleolus (Nu) undergoes spectacular changes in size and

structure (Figure 1) indicative of increased capacity for ribosome synthesis (Kosmidou, 1976; Ramsey and Berlin, 1976a,b; Waterkeyn, 1978). Under natural conditions the general pattern of the nucleolar evolution in terms of size and appearance of light inclusions—the so-called vacuoles—in the differentiated fibers is rather unique. First, there is an exponential expansion in size starting at initiation and lasting for 4-8 days following anthesis. This is accompanied by a moderate to high vacuolation which may occur early but usually later in this period. A maximum nucleolar size of 8-11  $\mu\text{m}$  is obtained. After a short stage of maintenance of the maximum size, a rapid decline of Nu-material follows which slows afterwards so that the nucleolus reaches a minimum size at the end of fiber growth.

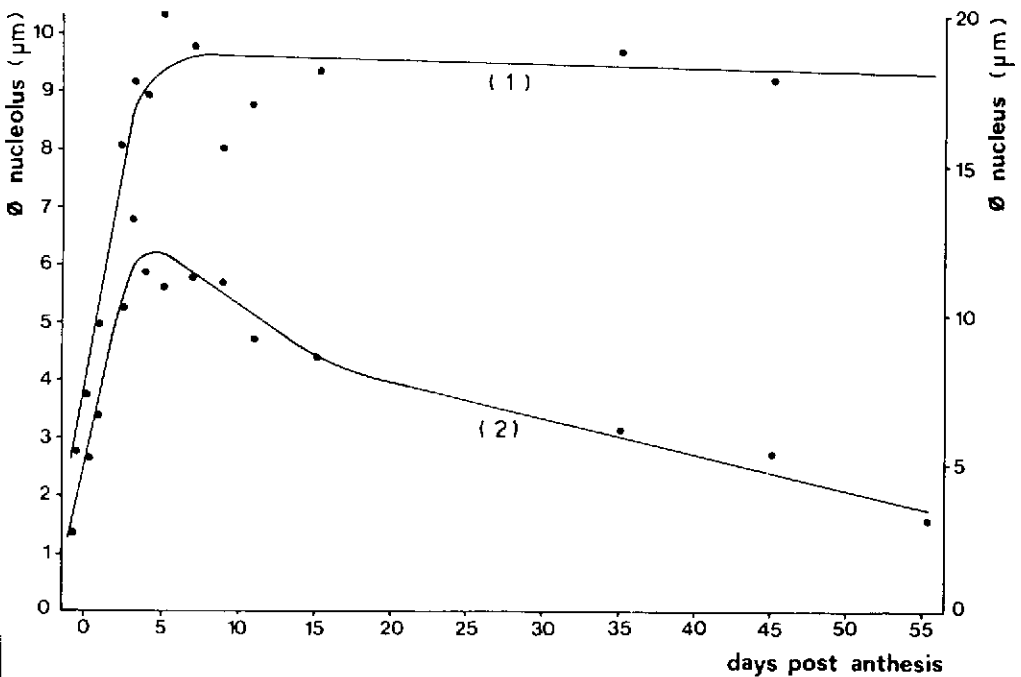

Figure 1. Evolution of nuclear (1) and nucleolar (2) sizes (diam. in  $\mu\text{m}$  on y axis) during fiber cell initiation, elongation, and wall thickening (days postanthesis on x axis). *Gossypium hirsutum* cv B49.

During the first stage of nucleolar expansion there is a correlation between Nu-size and length of initials (DeLanghe *et al.*, 1978) indicating that the development of the nucleolus may be related to the manner of elongation and the resulting fiber length. The nucleolar vacuolation observed during this stage (Vla-

sova, 1971; Ramsey and Berlin, 1976a; Kosmidou, 1976; DeLanghe *et al.*, 1978) and its causatives are poorly understood. The hypothesis that a rapid transport of nucleolar material caused by the high demand for protein synthesis during this period gained support by some investigators (De Bary *et al.*, 1974; DeLanghe *et al.*, 1978), although there could be other reasons.

Vacuolated nucleoli have been described in other tissues and species (Barlow, 1970; Deltour and Bronchant, 1971; Rose *et al.*, 1972; Galan-Cano *et al.*, 1975; Moreno-Diaz *et al.*, 1980), but there has been no agreement on their function. Some authors suggest a correlation between nucleolar vacuolation and nucleolar activity. Others extend this suggestion and conclude that the vacuolated nucleolus provides a storing and/or transporting mechanism for nucleolar products (Moreno-Diaz *et al.*, 1980), but there are also opposing opinions (Rose *et al.*, 1972). However, the appearance of vacuolated nucleoli during periods of high metabolic activity of the cell and the modification of nucleolar vacuolation and size by hormones (Kosmidou, 1976; DeLanghe *et al.*, 1978) support the possibility that some processes under hormonal control in the developing fiber are determined by this early nucleolar activity. Late initials on the ovule (4-12 days postanthesis), which give rise to fuzz fibers (about 2 mm in length), always have small nucleoli without vacuoles (Kosmidou, 1976). Fuzz fibers also have small nuclei (Vlasova, 1971).

Differences among cotton varieties occur in the time required to reach maximum nucleolar size, the absolute size, and the rate and time of vacuolation. Differences also occur among ovules in the same boll according to their location within the boll (top to bottom of the ovary) and among locations on the ovule (chalazal to middle part). Fiber nucleoli of ovules at the top of the ovary increased their material earlier and faster than those at the base of the ovary. The same happens to nucleoli in fibers located at the chalazal end of the ovule compared with those at the middle. However, in all cases the distribution of Nu-size around the mean value of the sample was always normally distributed (*G. barbadense* cv Menufi; unpublished data by Hilde Vincke and E.A.L. DeLanghe, Kath. University of Leuven, personal communication). This is probably a reflection of polar transport within the boll. Nevertheless the general pattern of fiber nucleolar development remains typical as described before. This pattern also suggests that most of the ribosome synthesis necessary for cell elongation and development occurs early.

Pollination seems to be a stimulus for Nu-material increase and fiber initiation, since its prevention *in situ* causes delay in fiber initiation, smaller nucleoli and shorter fiber initials. A quick decline of Nu-material and cessation of growth occurs, followed by boll abscission (Kosmidou, 1976). According to Beasley (1973) an extract of germinating pollen can mimic quantitatively the effect of exogenous hormones, including slight fiber elongation in unfertilized ovules *in vitro*. Unfertilized ovules isolated before flower pollination and cultured *in vitro*

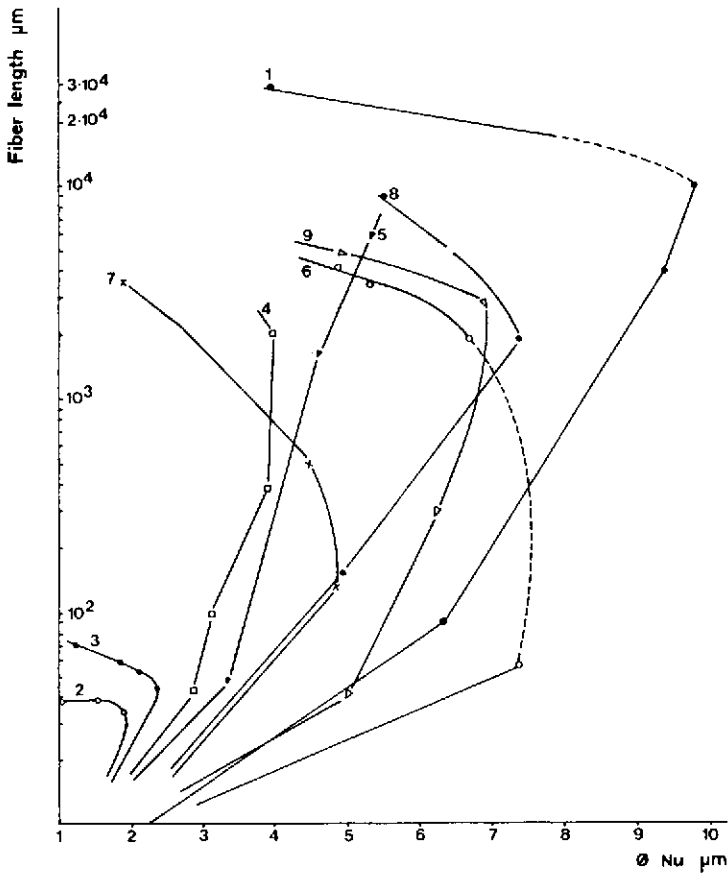

Figure 2. Combined evolution of fiber nucleolar size (diam. in  $\mu\text{m}$  on x axis) and fiber length (in  $\mu\text{m}$  on y axis—logarithmic) *in situ* and *in vitro*. *Gossypium hirsutum* cv B49.

- 1 in natural conditions
  - 2 *in vitro*, unfertilized ovules, no hormone
  - 3 *in vitro*, unfertilized ovules, +  $\text{GA}_3$
  - 4 *in vitro*, unfertilized ovules, + 2,4-D
  - 5 *in vitro*, unfertilized ovules, +  $\text{GA}_3$  + 2,4-D
  - 6 *in situ* unfertilized ovules, +  $\text{GA}_3$
  - 7 *in situ* unfertilized ovules, + 2,4-D
  - 8 *in situ* unfertilized ovules, +  $\text{GA}_3$  + 2,4-D
  - 9 *in situ* unfertilized ovules, +  $\text{GA}_3$  + 24 hrs later 2,4-D
- (measurements at 2, 5, 8 and days postanthesis)



without hormones did not initiate fiber except for a few initials near the chalaza. These had very small nucleoli (maximum diam.  $1.9 \mu\text{m}$ ) which did not increase in size (Kosmidou, 1976).

Gibberellin ( $\text{GA}_3$ ), auxin and ABA each, separately or in combinations, could significantly affect the nucleolar evolution and the corresponding fiber length (Figure 2), especially in unfertilized ovules *in situ* and *in vitro* during fiber differentiation, first initiation and early elongation (Kosmidou, 1976). Gibberellin ( $\text{GA}_3$ ) stimulated the synthesis of dense Nu-material and prevented nucleolar vacuolation. Auxins (IAA, 2,4-D, NAA) also stimulated the increase of nucleolar size, though not when their level was high, and not *in situ*. High auxin level and ABA caused an early high Nu-vacuolation and "ring-shaped" nucleoli. In these nucleoli a large vacuole occupied the center of the nucleolus while the surrounding dense material formed a cortex. Ovules with high percentage of early "ring-shaped" fiber nucleoli, such as those treated with a high concentration of auxin or ABA, ceased their fiber growth after a very short period of rapid elongation. High concentrations of auxin are known to induce the synthesis of ethylene (Rappaport, 1980; Zurfluh and Guilfoyle, 1982), so interference of this hormone cannot be excluded. Under natural conditions (fertilized ovules *in situ*), nucleolar vacuolation was correlated with intense ribosome production and increased fiber elongation rates (Kosmidou, 1976). The effect of moderate auxin treatment on cotton fiber nucleoli resembles that found in other tissues (Guilfoyle *et al.*, 1975; Grierson *et al.*, 1980) in which auxin induced a large increase in RNA synthesis by nucleoli without affecting the properties of the RNA produced. The mechanism of this auxin action is not clear.

A ratio of  $\text{GA}_3$ :auxin in favor of auxin also stimulated early nucleolar vacuolation, higher rate of early fiber elongation and smaller nucleoli. The ratio of  $\text{GA}_3$ :ABA seemed important too, as ABA could counteract the  $\text{GA}_3$  effect. ABA may inhibit or even block the synthesis of Nu-material and may eventually participate, like auxin, in ribosome transport and utilization (DeLanghe *et al.*, 1978). The hormonal balance of auxin, GA and ABA seems to be important for the regulation of synthesis and release of nucleolar material. Fiber elongation is related to these phenomena; however, as long as we do not have complete information about the way in which rRNA production is regulated, many questions will remain.

## EFFECT OF HORMONES ON FIBER ELONGATION

Lint fibers begin their elongation phase at anthesis. Depending on genetic and environmental factors, the elongation phase lasts for about 20-25 days, by which time the fibers attain a maximum length. The maximum growth rate occurs around the 8th to the 10th day postanthesis.

Many reports indicate that gibberellins, auxins and abscisic acid affect fiber elongation, the first two inducing and the third inhibiting it (Bhardwaj and

Sharma, 1971; Beasley, 1973; Beasley and Ting, 1973, 1974; Singh and Singh, 1975; Baert *et al.*, 1975; Dhindsa *et al.*, 1976; Kosmidou, 1976; Babaev and Agakishiev, 1977; Bazanova, 1977; DeLanghe *et al.*, 1978). When treated with GA<sub>3</sub> (0.1 ml 10<sup>-2</sup>M/flower), auxins (IAA or 2,4-D 0.1 ml 10<sup>-3</sup>M/flower) and ABA (0.1 ml 10<sup>-3</sup>M/flower), each separately or in combinations on the morning of anthesis, fibers of non-fertilized ovules *in situ* elongated with different patterns which influenced the final length distribution (Figure 3). GA<sub>3</sub>, besides preventing

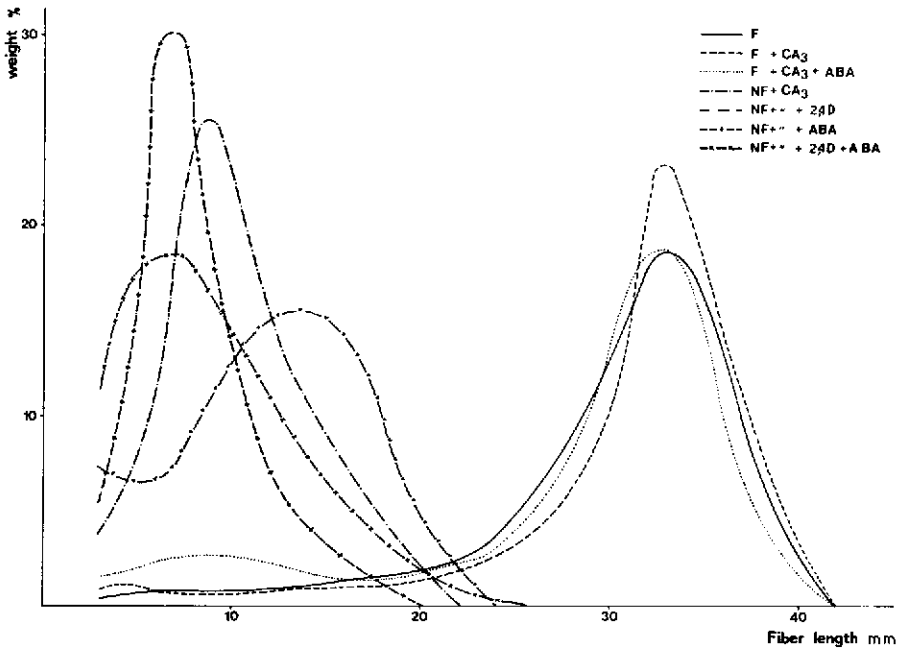

Figure 3. Hormonal effect on cotton fiber length distribution *in situ*. Fertilized (F) and unfertilized (NF) ovules, *G. hirsutum* cv B49.

fruit drop, stimulated a certain degree of fiber elongation. Auxin had a marked positive effect which was additive to the GA<sub>3</sub> stimulation, and ABA counteracted the effect of the other two (Kosmidou, 1976). The auxin stimulus during the elongation phase of fiber is complementary to the work of Jasdandwala *et al.* (1977) who have shown that under natural conditions IAA catabolism is low during this phase. Also, Rodgers (1981a) identified in lint + seed extracts an increased auxin content during the elongation phase with a 6-fold peak at day 15 after anthesis.

Auxins and GA<sub>3</sub> act synergistically *in vitro* on the fiber capacity for primary

wall synthesis and elongation during the early elongation stages (Beasley and Ting, 1973, 1974; Kosmidou, 1976).  $GA_3$  could not affect fiber elongation beyond about the 8th day postanthesis stages. Its positive effect on elongation was greater the earlier the fiber growth stage. On the contrary, auxin enhanced elongation in later stages, too (Kosmidou, 1976). Ethylene (ethephon) in 2-day-old ovules cultured *in vitro* inhibited fiber growth (Hsu and Stewart, 1976).

The work of Beasley and co-workers (Beasley, 1973, 1977a,b; Beasley and Ting, 1973, 1974; Beasley *et al.*, 1974; Dhindsa *et al.*, 1976) *in vitro* has shown that:

1. Two-day-old fertilized and isolated cotton ovules appeared to be deficient in their capacity to synthesize optimum levels of gibberellins, sufficient in their production of cytokinins, and optimum or near optimum in the production of IAA. ABA was not essential for fiber elongation. They, as well as other authors (DeLanghe, 1973; Baert *et al.*, 1975; Kosmidou, 1976), concluded that an increase in IAA and GA following fertilization permits ovule and fiber growth.
2. In two-days postanthesis unfertilized ovules, IAA had a marked positive effect on the production of fibers, kinetin supported no fiber elongation, combinations of IAA and  $GA_3$  produced additive amounts of fibers, ABA reduced the amount of fibers induced by IAA, and kinetin partially overcame the inhibition caused by ABA.
3. Unfertilized ovules transferred to culture on the day of anthesis or one to two days preanthesis responded to IAA and/or  $GA_3$  by producing fibers, but not on the fourth (or earlier) day preanthesis. Dhindsa *et al.* (1976) found that ABA inhibited the growth of fiber only when applied during the first four days of culture, and they suggested the possibility that ABA causes this inhibition by interfering with malate catabolism. In another study Dhindsa (1978b) presented evidence that  $GA_3$  causes a large increase in the activities of malate synthesizing enzymes in unfertilized ovules. Furthermore, ABA inhibits the increase in enzyme activities and lowers the ability of ovules to fix  $CO_2$  in dark, apparently by counteracting the  $GA_3$  effect. The same author (1978a) studied the effect of bromodeoxyuridine (BUdR, known to prevent differentiation), AMO-1618 (a growth retardant) and p-chlorophenoxyisobutyric acid (PCIB, an antiauxin) on preanthesis ovules cultured *in vitro*. In the presence of PCIB alone and in combination with  $GA_3$  or  $GA_3$  plus IAA, ovules do not produce fibers and ovule growth appears to be predominantly determined by gibberellin while fiber growth is largely dependent on the availability of auxin.

The identification of considerable amounts of GA's, auxin and cytokinins in lint + seed extracts during the fiber elongation phase which have their peak activity early in this phase (Rodgers, 1981a,b,c), together with the above *in situ* and *in vitro* results, show the importance of hormones on fiber elongation, especially that of auxin and gibberellin. Relatively high concentrations of ABA occur

in bolls and seeds around 5 days postanthesis, which coincides with the high boll abscission rate (Rodgers, 1980). Abscisic acid (ABA), besides its role on boll abscission and inhibition of embryo germination, seems to be a prime candidate as the agent responsible for altering the fiber promoting effects of auxin and gibberellins.

Although the mode-of-action of auxin-regulated elongation is not yet clear, research results in many tissues support the hypothesis that auxin regulates and coordinates both wall loosening and supply of wall materials in elongation (Vanderhoef and Sathl, 1975). Various theories of auxin-stimulated wall acidification and loosening (Cleland, 1979; Ray, 1980), auxin action in two biochemically distinct phases involving rapid lowering of pH and delayed but sustained steady state growth (Vanderhoef and Dute, 1981) and the auxin receptors (Naryanan, 1981; Rubern, 1981; Vreugdenhil *et al.*, 1981; Walton and Ray, 1981) have received much support. Auxin activity in gene expression for sustained cell elongation also appears to be a real possibility (Bevan and Northcote, 1981; Vanderhoef and Dute, 1981; Zurfluh and Guildfoyle, 1980, 1982).

The role of gibberellins in promoting cell enlargement and division in intact plants is recognized, as is the importance of certain tissues like the intact subapical region and the cereal aleurone layer, as target sites for GA action (Rappaport, 1980). Existing information favors a role for GA's in stimulating synthesis of mRNA and intervening in transcription or translation (Rappaport, 1980).

Despite the lack of knowledge of detailed mechanisms so far, the early requirement of GA<sub>3</sub> and IAA for fiber development is recognized, as is the pronounced deleterious effect of ABA.

## EFFECT OF HORMONES ON SECONDARY WALL FORMATION

Secondary wall formation begins towards the end of the elongation phase and it is the last fiber developmental stage before maturation. An increase in the number of ER-associated polysomes occurs during this stage (Berlin and Ramsey, 1970; Westafer and Brown, 1976). The formation of secondary wall in fibers of unfertilized ovules has been found to be influenced by auxins and ABA *in situ* (Kosmidou, 1976). 2,4-D promoted the synthesis of cellulose and increased the percentage of mature fibers. Jasdanwala *et al.* (1977) also found that auxin was necessary for secondary wall biogenesis. ABA had the opposite effect of auxin in both fertilized and unfertilized ovules (Figure 4). Abscisic acid could not be detected in 20 DPA seeds *in situ* (Davis and Addicott, 1972) and only at about 30 DPA does it appear to accumulate (Choinski *et al.*, 1981).

Fibers developing from unfertilized ovules cultured *in vitro* produce cell walls very similar to those of plant grown fibers, both with respect to composition and changes in the composition as a function of development (Meinert and Delmer,

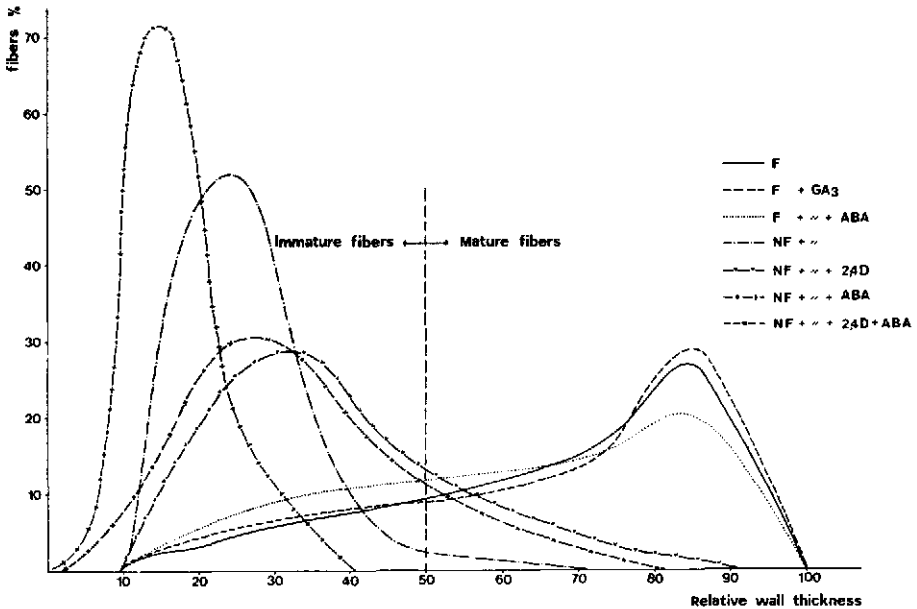

Figure 4. Hormonal effect on cotton fiber relative wall thickness distribution *in situ*. Fertilized (F) and unfertilized (NF) ovules, *G. hirsutum* cv B49.

1977; Carpita and Delmer, 1981). When unfertilized or fertilized ovules were transferred from plants at 5-14 days postanthesis to *in vitro* culture without hormones their fibers could produce secondary walls (Kosmidou, 1976). Auxin (NAA  $10^{-6}$ M and  $10^{-5}$ M) increased the amount of cellulose formed by these fibers and consequently their maturity, while ABA ( $10^{-6}$ M) reduced it significantly. In the same study no significant effect of  $GA_3$  ( $10^{-7}$ M,  $10^{-6}$ M,  $10^{-5}$ M) was detected.

According to Tarchevskii *et al.* (1980) inhibitors of ATP formation in the course of oxidative phosphorylation (rotenone and antimycin A) and glycolysis (sodium fluoride and monoiodoacetate) powerfully depressed cotton fiber cellulose synthesis. Cellulose synthesis in cotton fibers is limited by the content of macroergic phosphates, and modification of the cell energy regime constitutes one of the ways in which synthesis of cotton cellulose can be effectively regulated. Other inhibitors of cellulose synthesis in cotton fibers have been characterized also (Montezinos and Delmer, 1980). Understanding the process of cellulose biosynthesis may help to understand the hormonal influences in it.

Ethylene is known to be implicated in the control of fruit ripening. In cotton it has received much attention as one of the causal agents in young fruit abscission (Guinn, 1979). Maximum rates of ethylene evolution in cotton fruits coincide with the highest incidence of young fruit abscission (Guinn, 1982). Ethrel, which causes rapid release of ethylene in the plant, has been found to stimulate the

translocation of assimilates into cotton bolls, particularly into fibers, during the six days following ethrel treatment (Yue-Quing *et al.*, 1980a). According to this report, the result of this extra translocation was the improvement of fiber quality and fullness, implicating thicker secondary walls. Ethylene also exerts an effect on the orientation of microtubules and cellulose microfibrils in pea epicotyl and stem tissues (Steen and Chadwick, 1981; Lang *et al.*, 1982). Recent progress in the identification of the steps in ethylene biosynthesis in plant tissues (Adams and Yang, 1979; Lürsen *et al.*, 1979), as well as in ways to prevent or inhibit ethylene action, provides the means for detailed investigations regarding the involvement of ethylene in cellulose microfibril deposition and secondary wall formation.

## SUMMARY

Research into the influence of hormones on cotton fiber development made significant progress in the last decade, mainly due to the use of the *in vitro* culture of cotton ovules with their associated fibers. Identification of the naturally occurring hormones in the cotton ovule, and fundamental work on the mode of hormone action in other plants, complemented our understanding on this subject, although not all mechanisms and maybe not all hormonal influences are known. More information on the differences in hormonal balance and changes during all fiber growth stages, in fibers of short versus long cottons, and in the detailed mechanisms of hormone action, would be helpful.

The involvement of phenolic substances in the process of fiber differentiation and the mediation of gibberellins and auxin during fiber differentiation and initiation have been proved. Evolution and structure of fiber nucleoli are changed by the influence of auxins, GA<sub>3</sub> and ABA, and it is speculated that these organelles play a direct or indirect role in hormonal action during fiber development. Hormonal balance seems very important, especially during the early stages of fiber growth.

During the fiber elongation phase, a synergistic effect of GA<sub>3</sub> and auxin seems to play an important role. There is evidence that GA exerts its action during the early days following anthesis, while the presence of auxin seems to be necessary from the early stages through secondary wall formation.

During the secondary wall formation, auxin increases the amount of cellulose deposited in the fiber walls. Limited evidence suggests ethylene involvement during the same fiber growth stage, and further investigation on its exact action, interactions and all possible influences is important.

Abscisic acid counteracts the GA and auxin effects on fiber development, and it has been proposed as the prime candidate responsible for altering the fiber promoting effects of these two types of hormones.

Although considerable information is now available on the involvement of hormones in fiber differentiation and development, a more thorough understanding of the mode of hormonal action, sequential changes, balance and interactions during cotton fiber growth is needed.

## CHAPTER 26

THE OUTER EPIDERMIS OF THE  
COTTONSEED

Jerry D. Berlin  
Texas Tech University  
Lubbock, Texas

## INTRODUCTION

Cotton fibers are single cells that arise from the outer epidermal layer of the cottonseed. Primordial fiber cells initiate elongation on the day of anthesis (Balls, 1915; Aiyangar, 1951; Joshi *et al.*, 1967). The fibers continue to elongate for 16-19 days and then undergo a thickening stage until boll opening. The elongation phase involves primary cell wall synthesis (of course many other things must also be synthesized such as the plasma membrane, internal membranes, cytosol, etc.) whereas the thickening stage is correlated with the synthesis of the secondary cell wall (Balls, 1915). The elongation and thickening stages may overlap (Schubert *et al.*, 1973), and they do not appear to be controlled by the same genetic factors (Kohel *et al.*, 1974).

Characteristics of the fiber primordia at anthesis (flowering) include cell and nuclear enlargement, vacuolarization and the aggregation of smaller nucleoli into a single large nucleolus in the young fiber (Ramsey and Berlin, 1976a,b). There are two types of fibers on most commercial cottons. These are the lint fibers (which are ginned off) and the fuzz fibers that remain on the seed after ginning. The lint fibers initiate elongation on the day of anthesis or shortly thereafter, whereas the fuzz fibers are thought to initiate elongation at later times, e.g., at 4-10 days postanthesis (Barritt, 1929; Aiyangar, 1951; Joshi *et al.*, 1967). Fuzz fibers are distinguished from lint fibers in that they are shorter, have thicker secondary cell walls at maturity, are frequently pigmented differently and, occasionally, are located at specific sites on the cottonseed. The relative numbers of epidermal cells to lint fibers to fuzz fibers varies depending upon the type of cotton.

This review will concentrate on the events surrounding fiber differentiation and initiation in the outer epidermal layer of the cottonseed and will focus on three areas: (1) the morphology of the epidermal cells and the fibers; (2) the incorporation of various radioactive precursors into the epidermal cells and developing fibers; and (3) the seed surface and the number of epidermal cells and fibers on a single seed.

## MORPHOLOGY OF THE OUTER EPIDERMAL LAYER

The morphological descriptions will be presented at the cellular (light microscopy) and subcellular (electron microscopy) levels. All of the light microscopic data were obtained with glutaraldehyde-fixed, plastic-embedded specimens sectioned at 1-2  $\mu\text{m}$ . Numerous stains were employed including aqueous toluidine blue which works well for general morphology. The use of specific cytochemical stains will be mentioned as appropriate. Specimen preparation for electron microscopy was previously described (Ramsey and Berlin, 1976a,b). The plant materials used for most of the morphological work were the commercial cultivars Dunn 56C and Paymaster 266.

### LIGHT MICROSCOPY

Martin *et al.*, (1923) reported differentiation of the floral bud approximately 23 days preanthesis. I examined ovules from 23-day preanthesis squares and found approximately 1,000 outer epidermal cells, each of which was cuboidal and 8-9  $\mu\text{m}$  in length (the preanthesis material used in this study was dated using 3- and 6-day separation for vertical and lateral reproductive buds, respectively, as suggested by McClelland and Neely (1923) and Gore 1932).

Light micrographs of the outer epidermal layer of the developing cotton seed from 4 days preanthesis to 15 days postanthesis are shown in Figures 1-8. At 4 days preanthesis, the outer epidermal cells were generally columnar in shape with dimensions of 9 X 9 X 15  $\mu\text{m}$  (Figure 1). The single nucleus, containing chroma-

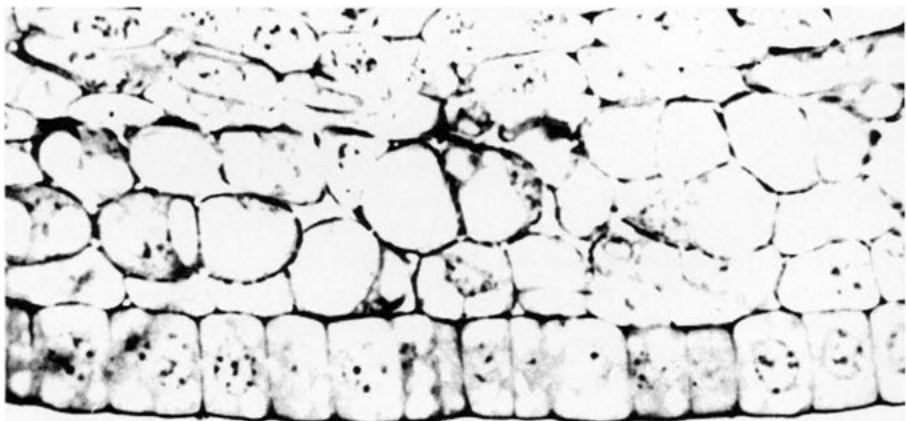

Figure 1. Light micrograph of the outer epidermis of the cotton ovule at 4 days preanthesis. The centrally positioned nuclei each contain peripheral heterochromatin and several small nucleoli. The cytoplasm contains many small vacuoles. (Aqueous toluidine blue stained, 550X magnification).



tin flakes, was centrally positioned. Nucleoli were less than  $1\ \mu\text{m}$  in diameter, and as many as four nucleoli were present in a nucleus. Numerous mitotic figures were apparent in the epidermal layer at all preanthesis times. Numerous small vacuoles were scattered throughout the cytoplasm of the cells. Cells with enlarged nucleoli, presumably fiber primordia, were occasionally observed at three days preanthesis.

At one day preanthesis, the epidermal cells retained their shape, but were

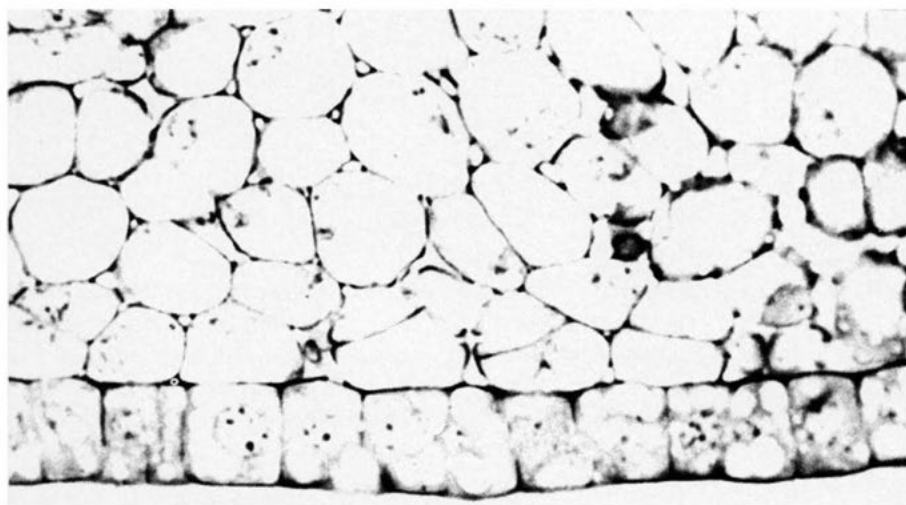

Figure 2. The outer epidermal layer of a cotton ovule at 1 day preanthesis. The nucleoli become prominent and many of the vacuoles have coalesced resulting in fewer, but larger, vacuoles. (Aqueous toluidine blue stained, 550X magnification).

slightly larger (Figure 2). The nuclei were centrally located and exhibited chromatin granules. The nucleus was enlarged in a few cells and a single large nucleolus (up to  $2\ \mu\text{m}$  diameter) was prominent. Cytoplasmic vacuoles appeared to coalesce resulting in fewer, but larger vacuoles. Although not shown in black and white photographs of aqueous toluidine blue stained sections, many of these vacuoles were green to dark green in color indicating the presence of phenolic compounds (Feder and O'Brien, 1968). Epidermal cells from younger ovules lacked similar vacuolar staining.

On the day of anthesis, the first series of fiber primordia started to elongate. These initiating fiber cells bulged outward from the surface of the seed (Figure 3). Enlarged nucleoli (over  $2\ \mu\text{m}$  diameter) were present in the nuclei of these fiber initials, and the nuclei possessed little chromatin staining (Figure 3). At one day postanthesis, the tips of the fiber initials projected about  $15\ \mu\text{m}$  above the

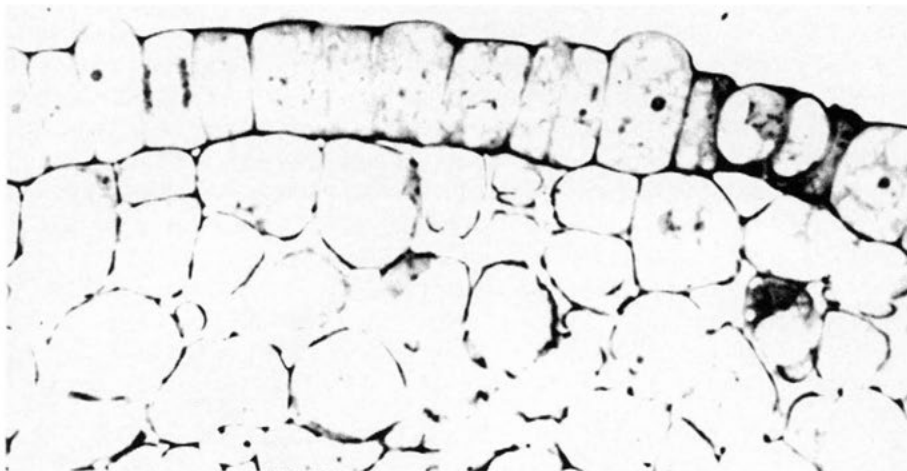

Figure 3. A light micrograph of fiber primordia in the outer epidermal layer of the cotton ovule on the day of anthesis. The fiber primordia, containing prominent nucleoli, have initiated elongation and protrude above the surrounding cells. The vacuoles are less obvious in the fiber primordia than in the neighboring nonfiber cells. Among the nonfiber cells are a cell in anaphase and two guard cells of a stomatal complex. (Aqueous toluidine blue stained, 550X magnification).

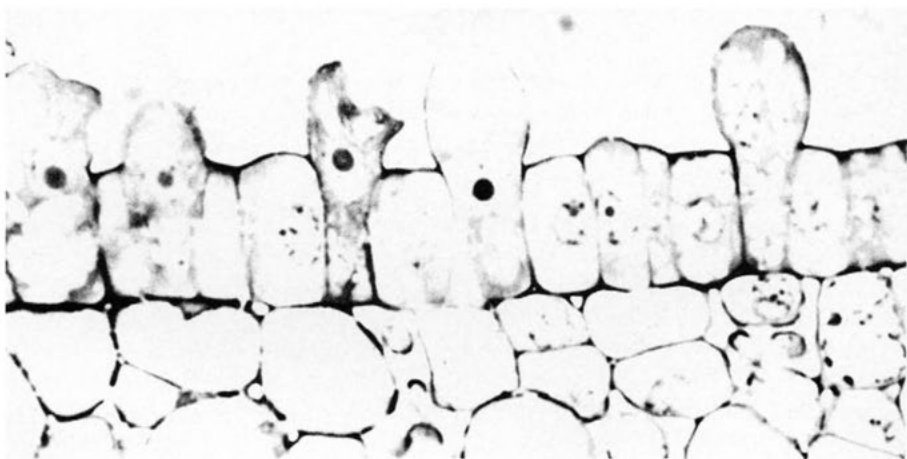

Figure 4. A light micrograph of elongating fibers at 1 day postanthesis. The elongating fibers have a single enlarged nucleolus in a pale staining nucleus that has migrated slightly toward the fiber tip. The cytoplasm contains numerous vacuoles and the large central vacuole has not started to form at this time. (Aqueous toluidine blue stained, 550X magnification).

seed surface (Figures 4, 9), and various cellular structures, including the nucleus, had migrated toward the outer tip of the fiber (Figure 4). The cytoplasm of the young fiber appeared to expand to fill the entire volume of the enlarging cell. The nonfiber epidermal cells maintained their original shape with a slight increase in cell volume, and the nuclei remained centrally located in the cell. There were 50,000 to 60,000 surface cells on the cotton ovule at anthesis. Thus, if all 1,000 epidermal cells in the 23 day preanthesis ovule continued to divide, some 5-6 divisions would be required to arrive at 60,000 epidermal cells at anthesis, and the average generation time would be approximately 5 days.

At 2 days postanthesis the fiber cells that had initiated elongation on the day of anthesis had attained a diameter of about 22  $\mu\text{m}$  and a length of approximately 100  $\mu\text{m}$  (Figure 9). Fiber nuclei were free of chromatin staining and had moved out into the fiber (Figure 5). The single nucleolus in these fibers had enlarged to 4

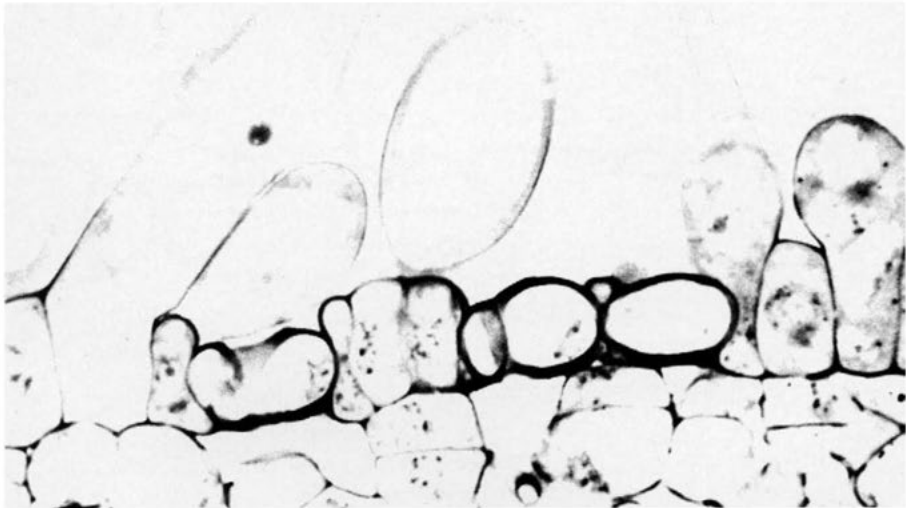

Figure 5. A light micrograph of the epidermal layer and fibers at 2 days postanthesis. Two cells are initiating elongation and several fibers are so large that they are not contained within the field of the picture. A pale-staining nucleus with a large nucleolus is shown in one of the fibers. The older fibers are characterized by large central vacuoles. The cytoplasm of these older fibers contains small vacuoles that may coalesce with the central vacuole. Note the base of the fiber containing the nucleus still has considerable cytoplasm and has not progressed to a "rim" of cytoplasm. Guard cells are shown in the epidermal layer. (Aqueous toluidine blue stained, 550X magnification).

$\mu\text{m}$  in diameter. Other epidermal cells continued to initiate elongation (Figure 5), and the events accompanying initiation in these cells were identical to those previously described to occur at anthesis. The nonfiber epidermal cells were

slightly larger at this time ( $13 \times 13 \times 21 \mu\text{m}$ ). The nuclei were centrally located, and many of the nuclei contained chromatin granules and small nucleoli.

The fiber nucleoli continued to increase in size through 3 days postanthesis (up to  $7 \mu\text{m}$  in diameter). Fiber initiation was not observed between 3 and 5 days postanthesis. The nonfiber epidermal cells enlarged slightly ( $15 \times 15 \times 25 \mu\text{m}$ ), and the nuclei remained centrally positioned (Figure 6). Although mitotic activity was observed in the epidermal layer at this age, it was not as frequent as at preanthesis times. In no case was mitosis observed in these cells after six days postanthesis. The vacuoles continued to decrease in number and increase in size (Figure 6). By 5 days postanthesis the fiber cells attained an average diameter of

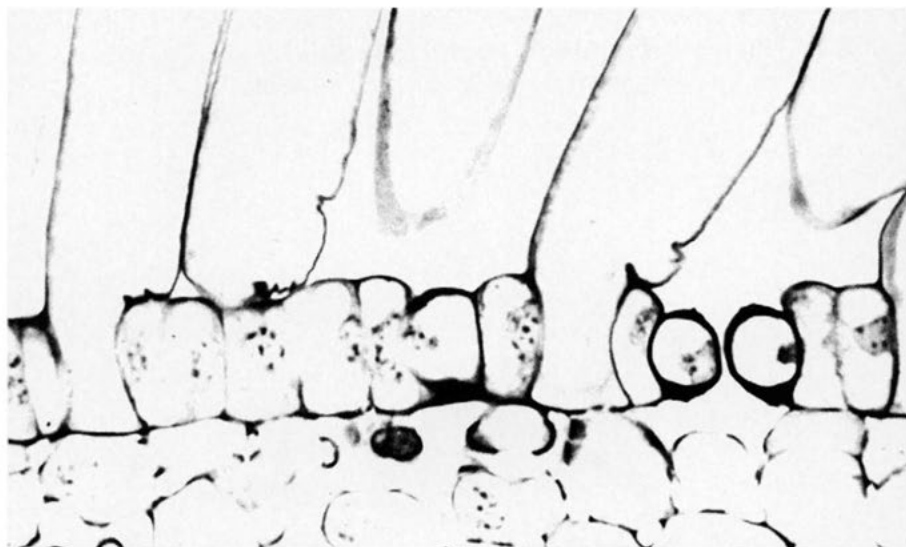

Figure 6. The epidermal layer and fibers at 3 days postanthesis. Each of the fibers has a large central vacuole that extends into the fiber base. The nonfiber epidermal cells contain several large vacuoles. A cross-section of a stomatal complex is shown. (Aqueous toluidine blue stained, 550X magnification).

$29 \mu\text{m}$ , and the longest fibers were 3 mm long (Figure 9).

A new wave of fiber initiation was found between 6 and 8 days postanthesis. Initiating fiber cells, thought to be fuzz fibers, followed the same pattern of initiation as previously described. Between 8 and 10 days postanthesis the nonfiber epidermal cells had a single central vacuole that was filled with phenolic materials (Figure 7). Once the large vacuole was established, further initiation of elongation was never observed.

The vacuoles found in the epidermal cells contained phenolic materials on the day preceding anthesis. These materials were identified as phenolics on the basis

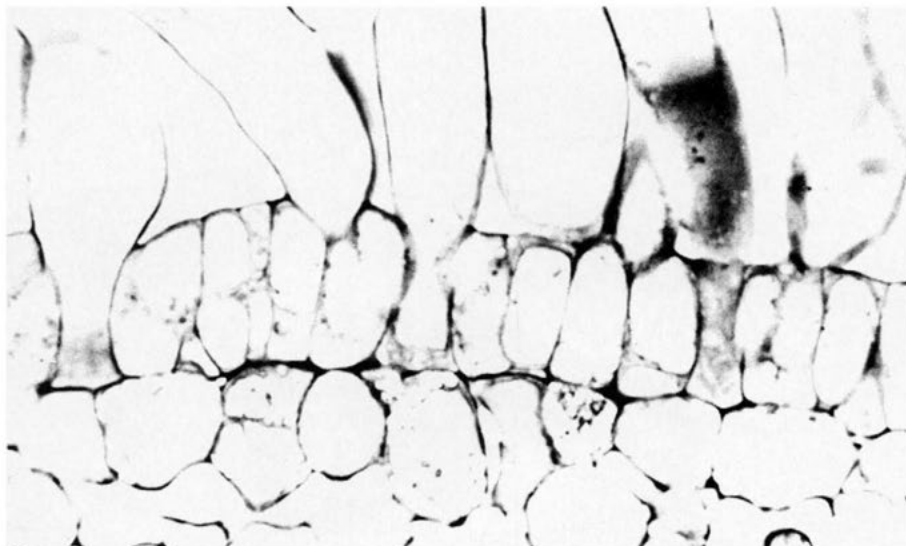

Figure 7. A light micrograph of the epidermal layer at 8 days postanthesis. The fibers have very little cytoplasm in their bases. The vacuoles in the nonfiber epidermal cells have enlarged and are in the process of accumulating phenolic materials. (Aqueous toluidine blue stained, 550X magnification).

of their staining with acid toluidine blue, periodic acid-Schiff, ferric chloride, safranin-fast green and osmic acid (Ginzberg, 1967). These phenolic materials became increasingly condensed, filled the nonfiber epidermal cells (Figure 8) and eventually contributed to the dark coloration characteristic of the cottonseed. At later times, the cells that comprised the seed surface became paradermally enlarged and synthesized thick secondary cell walls.

To summarize our light microscopic studies with respect to the epidermal cells and fiber initiation, nucleolar enlargement was an early indication of fiber primordial differentiation and occurred approximately 2-3 days prior to the initiation of elongation. An enlarged nucleolus is suggestive of increased rRNA synthesis, and thus new ribosomes, which would be correlated with a requirement for new protein synthesis in elongating fibers (Chapter 25). A second event preceding the initiation of elongation was the accumulation of phenolic materials in epidermal cell vacuoles. We shall have more to say about both of these points later. Lint fibers appeared to initiate elongation from anthesis to the second day postanthesis. As previously mentioned, fiber initiation occurs in waves beginning on the day of anthesis (Aiyangar, 1951; Joshi *et al.*, 1967; Lang, 1938). The first wave of initiating fibers become lint fibers (Joshi *et al.*, 1967; Lang, 1938) No initiation of elongation was found between the 3rd and 5th day postanthesis. The second and final stage of fiber initiation was found between 6 and 8 days



Figure 8. The outer epidermal layer of the cottonseed at 15 days postanthesis. The fibers have such a small amount of cytoplasm that it is not visible at this magnification. The nonfiber cells have accumulated massive amounts of phenolic substances in their central vacuoles. (Periodic acid-Schiff stained, 550X magnification).

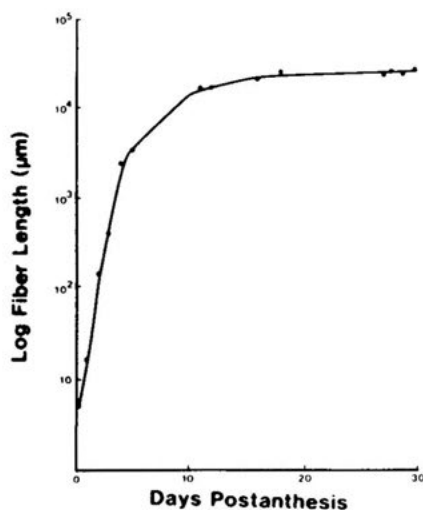

Figure 9. A growth curve of cotton fiber elongation showing increased fiber length with time postanthesis. The log phase of fiber elongation occurs during the first 10 days postanthesis.

postanthesis. These later developing fibers are thought to be fuzz fibers (Joshi *et al.*, 1967; Lang, 1938). The lateral displacement of the nuclei and the concentration of phenolic compounds in the vacuoles of the nonfiber cells at 8-10 days postanthesis caused the internal details of these cells to be obscured at this level of magnification.

### ELECTRON MICROSCOPY

The nuclei and cytoplasm of the epidermal cells from 16 to 3 days preanthesis appeared electron dense and were uniformly dark (Figure 10). The cell wall (primary) at the ovule surface and at the base of the epidermal cells was approximately 150 nm thick; the cell wall located between adjacent epidermal cells was slightly thinner (approximately 80 nm thick). Typical cell organelles such as nuclei, plastids containing starch granules, mitochondria, dictyosomes and vacuoles were observed in the epidermal cells of the ovule. The centrally positioned nuclei were circular to elliptical in shape and contained peripheral chromatin and up to 4 nucleoli. A light nucleolar cap was often observed on the outer edge of one

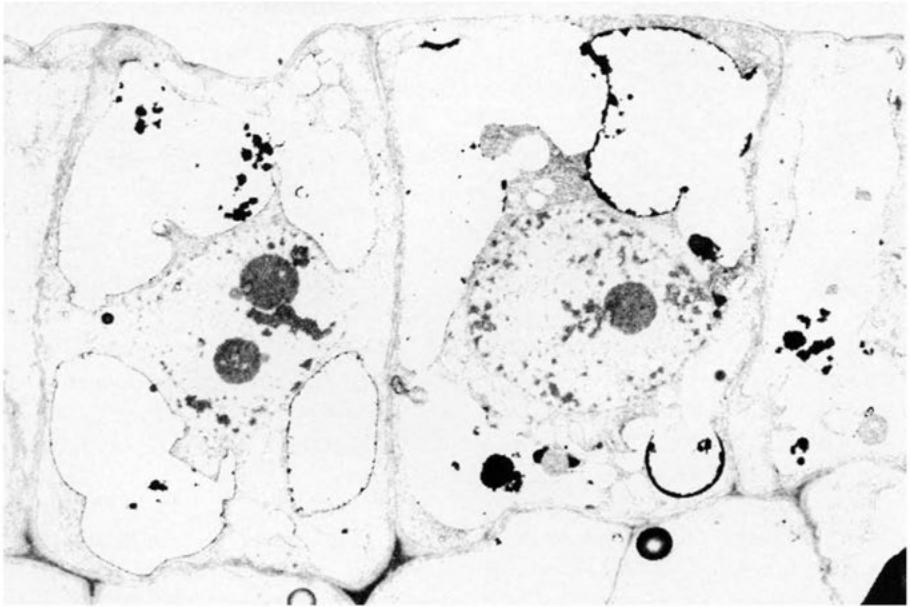

Figure 10. Electron micrograph of a median longitudinal section of the epidermal layer of the cotton ovule at 16 days preanthesis. The cell walls at the free-surface and at the basal region of the cells are approximately twice as thick as the lateral cell walls. The centrally positioned nucleus contains peripheral chromatin and numerous (up to four) nucleoli. Large vacuoles containing a small amount of phenolic material occupy most of the cytoplasm (9,100X magnification). (From Ramsey and Berlin, 1976a).

or more of the nucleoli. The dictyosomes possessed 4 to 7 cisternae and often had an electron dense cisterum at the mature face. Large vacuoles with a small amount of dense pigment were apparent in 16 day preanthesis epidermal cells (Figure 10). The vacuoles at 10 to 3 days preanthesis were smaller and more numerous (Figure 11) than in younger ovules.

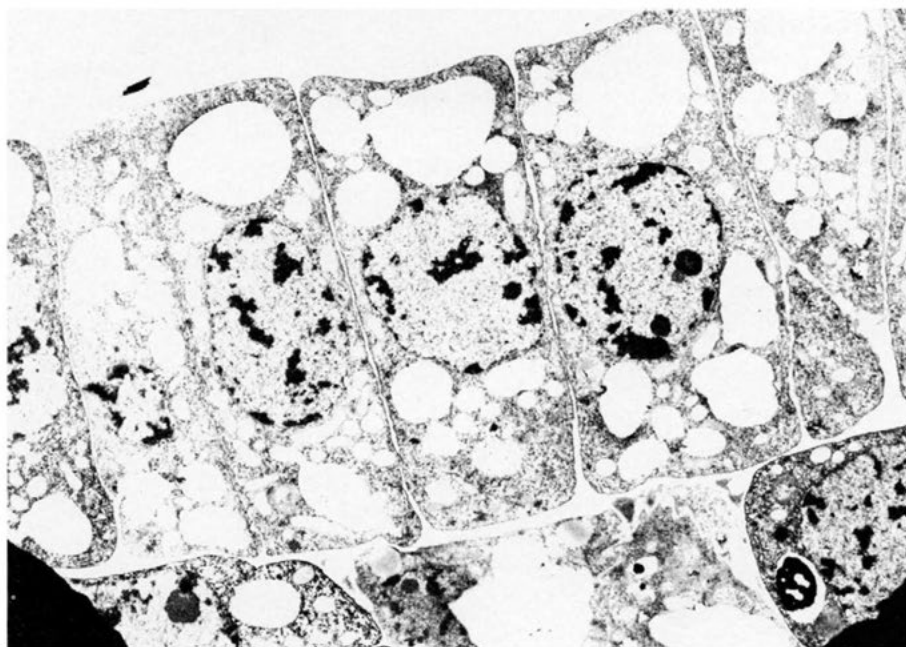
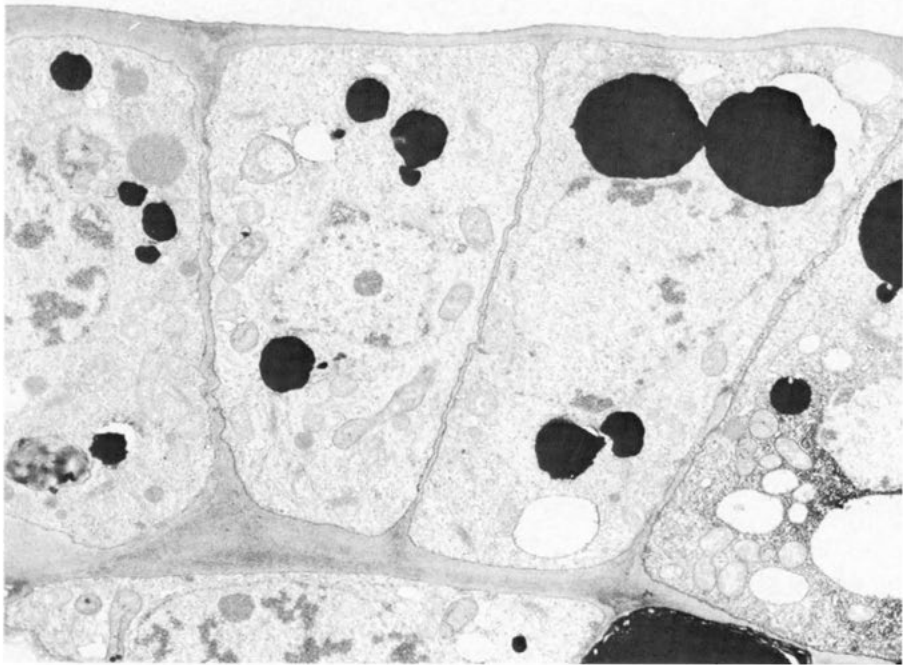

Figure 11. Transmission electron micrograph of the epidermal layer of a cotton ovule at 3 days preanthesis. The centrally positioned nuclei are surrounded by numerous small electron transparent vacuoles. Numerous mitochondria and proplastids are present in the cytoplasm. (8,200X magnification). (From Ramsey and Berlin, 1976a).

The appearance of the cells in the epidermal layer of the ovule was greatly altered approximately 24 hours preanthesis when many of the vacuoles became filled with an electron dense pigment (Figure 12). The nucleus and cytoplasm were conspicuously less electron dense and appeared much lighter than the dense, uniformly dark, epidermal cells of earlier times. The electron dense material in the vacuoles of the epidermal cells was concluded to be pigment as a result of the light microscopic cytochemical staining previously mentioned and the fact that the electron dense material was not observed in the vacuoles following methanol treatment of the ovules which would extract phenolic compounds (Mabry *et al.*, 1970).





**Figure 12.** Median longitudinal section of the outer epidermal layer of a cotton ovule at 1 day preanthesis. Many of the vacuoles are filled with phenolic substances. The nuclei and cytoplasm are less electron dense than in younger epidermal cells. A number of mitochondria, proplastids and dictyosomes are evident in the epidermal cytoplasm. Numerous plasmodesmata occur in the thin lateral cell walls between epidermal cells. (12,600X magnification). (From Ramsey and Berlin, 1976a).

Differentiation of primordial cells (epidermal cells that ultimately produce cotton fibers) in the epidermal layer first became apparent via electron microscopy at 16 hours preanthesis. A few cells near the chalazal end of the ovule were slightly enlarged and had dark nuclei, dark cytoplasm and vacuoles with very little pigment remaining (Figure 13). The cytoplasmic density of these differentiating primordial cells was not as uniform as the cytoplasmic density observed in epidermal cells from 16 to 3 days preanthesis. The cytoplasm immediately surrounding the vacuoles was more electron dense than the cytoplasm further removed from the vacuoles (Figure 14).

Light cells and dark differentiating primordial cells could be observed in the epidermal layer from the chalazal end midway to the micropylar end of the ovule by 8 hours preanthesis. The pigment in the vacuoles of the light cells at 8 hours preanthesis was not as compact nor as uniformly electron dense as the pigment

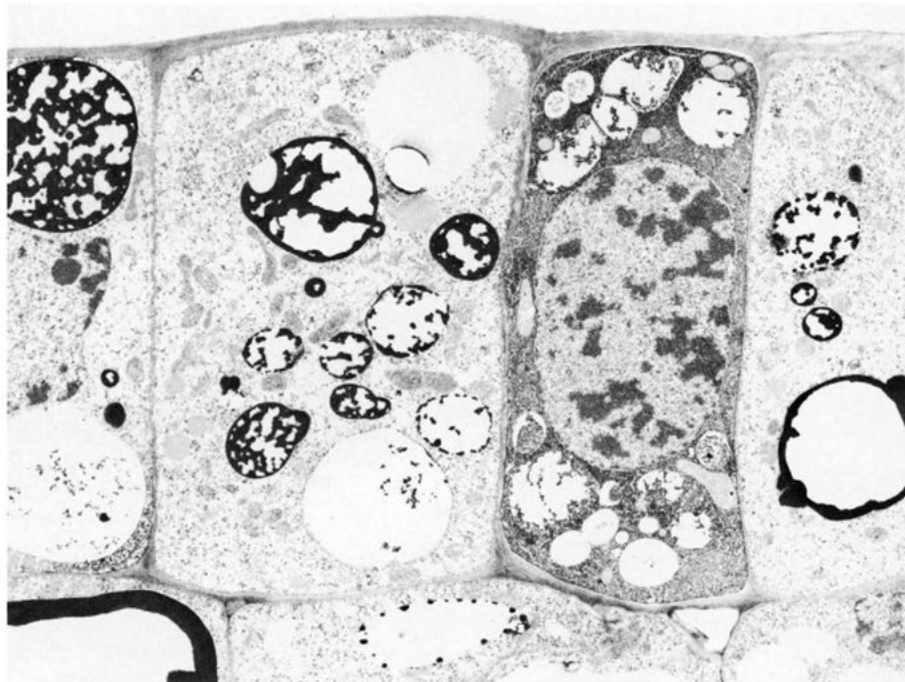

Figure 13. Median longitudinal section of the epidermal layer of the cotton ovule the evening before anthesis. The dark fiber primordial cells have little phenolic material remaining in the vacuoles compared with the light nonfiber cells that have phenolic materials localized within the vacuoles. The dark cells have enlarged nuclei. (10,000X magnification). (From Ramsey and Berlin, 1976a).

found in vacuoles of light cells at 24 hours preanthesis. Comparison of light and dark cells at anthesis revealed that the ribosomes in the cytoplasm of the dark cell were more numerous than the ribosomes in the cytoplasm of the light cell (Figure 15).

Only dark cells with most, but not necessarily all, of the pigment released from the vacuoles were observed to initiate fiber elongation at anthesis (Figure 16). Endoplasmic reticulum and dictyosomal membranes were more prominent in these fiber primordia than in neighboring nonfiber cells at anthesis (Figures 16, 17). The increase in these structures is undoubtedly in preparation for the increased requirement for membranes during the elongation phase of fiber development. The nucleus of the elongating fiber was enlarged at anthesis, had a single enlarged nucleolus, contained very little condensed peripheral chromatin and migrated from its original central position toward the fiber tip (Figure 18). Mitotic activity occurred in adjacent cells in the epidermal layer simultaneously

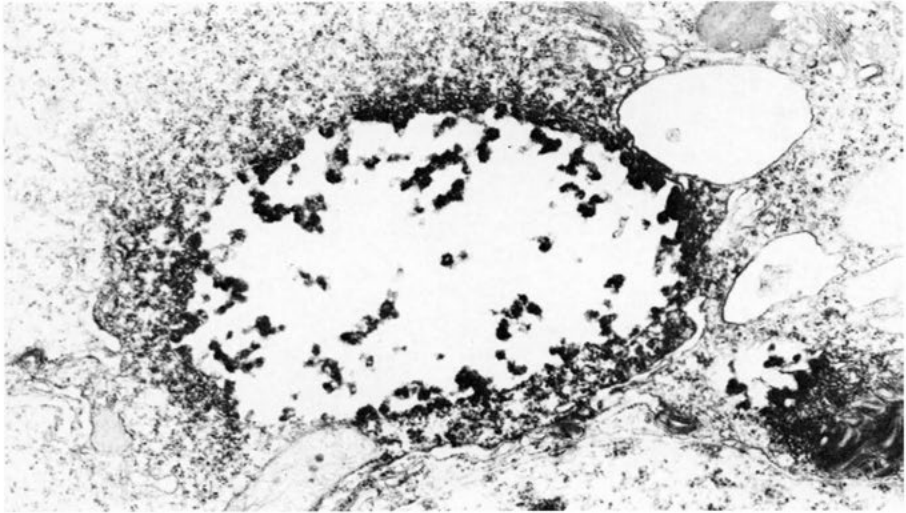

Figure 14. A portion of a fiber primordium showing an early stage in the dispersion of phenolic substances from a vacuole just prior to elongation. Membranes near the vacuole are coated with the phenolic materials, whereas structures further removed from the vacuole are not coated with the electron opaque material. (45,000X magnification).

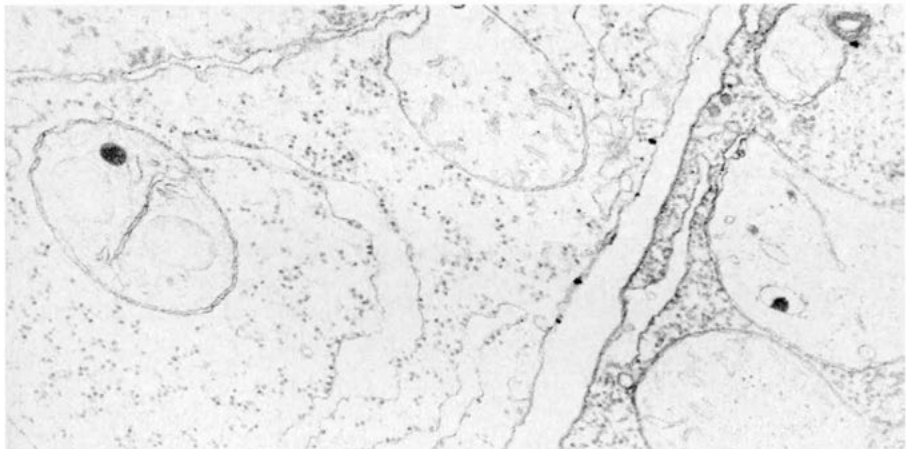

Figure 15. A comparison of the cytoplasm of light and dark epidermal cells. The dark cell contains many more ribosomes than does the light cell. Evidence of phenolic materials adhering to membranes is suggested by the apparent increased thickness of the plasma membrane and the endoplasmic reticulum of the dark cell. (39,000X magnification). (From Ramsey and Berlin, 1976a).

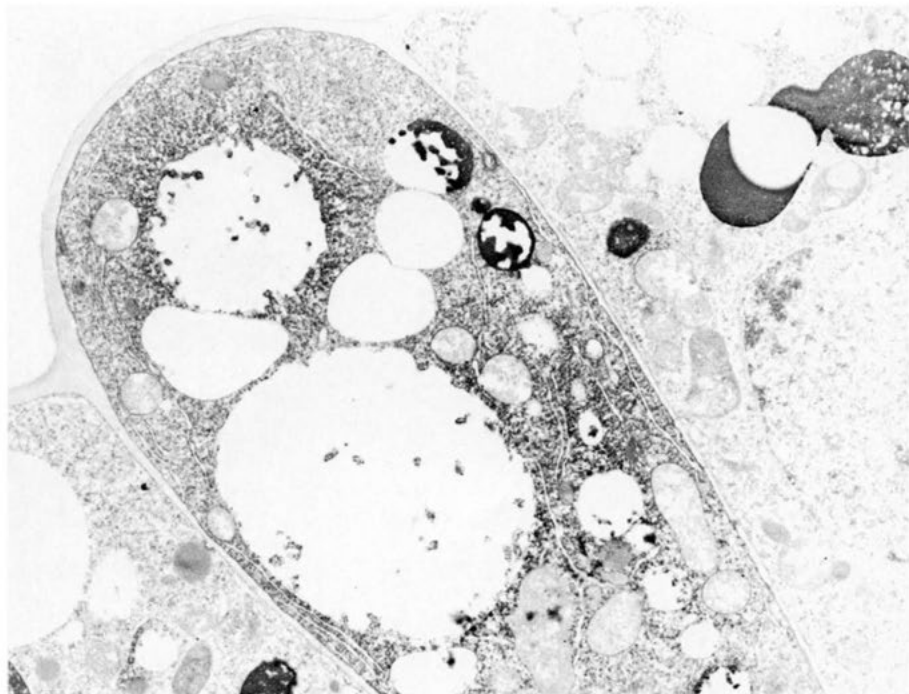

Figure 16. A fiber primordial cell initiating elongation on the day of anthesis. The dark cell protudes above the neighboring nonfiber, epidermal cells. The endoplasmic reticulum of the fiber primordium is well-developed and more extensive than in the adjacent light cells. The vacuoles in the dark cell contain only a small amount of phenolic materials in the vacuoles. (14,000X magnification). (From Ramsey and Berlin, 1976a).

with the initiation of elongation in fiber primordia. The cytoplasm of the elongating fibers became less electron dense first at the fiber tip. (Figure 18); however, the fiber base became less electron dense as the fiber further enlarged. Initiation of fiber elongation from epidermal cells appeared to occur randomly. Two or more fibers were often observed to initiate from adjacent epidermal cells; however, the relationship of the two cells to each other could not be determined. Numerous plasma membrane-associated vesicles were frequently observed in the tips and sides of elongating fibers (Figure 17). These plasma membrane-associated vesicles were not observed in fiber bases nor in nonelongating epidermal cells.

The elongating fibers at one day postanthesis were longer than fibers found at anthesis and appeared to have an increased number of lipid bodies present in the cytoplasm (Figure 19). The formation of the large central vacuole, characteristic of cotton fibers, was apparent by one day postanthesis. Two events led to the

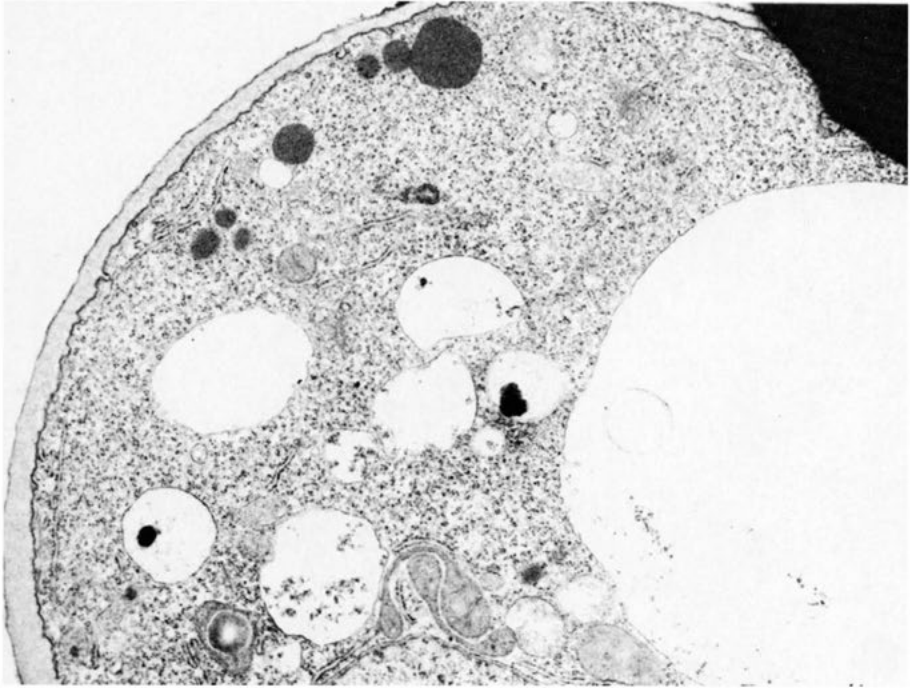

Figure 17. The tip of an elongating fiber on the day of anthesis. The cytoplasm is rich in ribosomes, endoplasmic reticulum and dictyosomes. Numerous plasma membrane-associated vesicles are apparent. (21,000X magnification).

formation of the central vacuole. First, dilation of the endoplasmic reticulum in close association with vacuoles produced a number of small vacuoles (Figure 20). Secondly, the several small vacuoles present in the fiber primordia on the morning of anthesis, as well as the vacuoles formed from the endoplasmic reticulum, coalesced into a larger vacuole. The vacuole, at one day postanthesis, further enlarged and migrated from the basal region into the mid-region of the fiber. The basal portion of the central vacuole at one day postanthesis was approximately even with the surface of the epidermal layer of the ovule and contained a small amount of diffuse pigment (Figure 19). The central vacuole enlarged and extended into the fiber base at 2 days postanthesis, leaving a thin rim of cytoplasm adjacent to the cell wall (Figure 21). A further suggestion of small vacuoles fusing with the tonoplast of the large central vacuole is shown in Figure 21.

The fiber nucleus at one day postanthesis was further enlarged, contained a small amount of condensed peripheral chromatin and had migrated into the mid-region of the fiber. At 2 days postanthesis, the nucleus was irregularly shaped, lacked peripheral chromatin and had a huge "bullseye" nucleolus (Figure 22). A

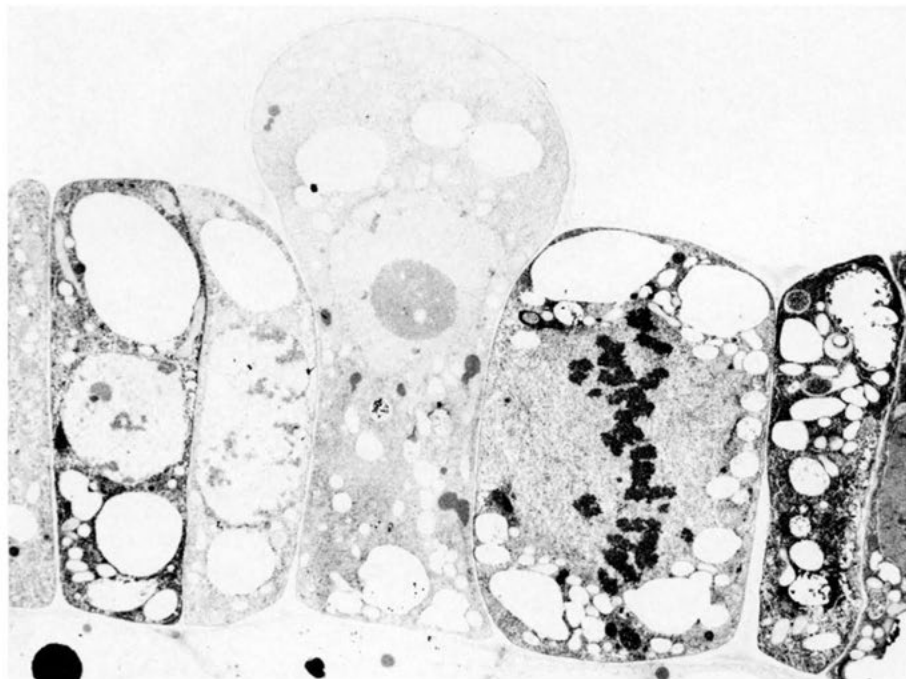

Figure 18. A median longitudinal section of the epidermal layer of the cotton ovule showing a lint fiber tip protruding above the epidermal layer on the day of anthesis. The nucleus of the fiber cell is enlarged, has a single, large nucleolus and has migrated toward the fiber tip. The fiber cytoplasm contains numerous vacuoles and is darker at the base than at the tip. An epidermal cell in mitotic metaphase is shown next to the fiber. (6,000X magnification). (From Ramsey and Berlin, 1976a).

small circular nucleolar cap was routinely observed at the outer edge of the nucleolus. The fiber nucleus remained structurally intact during the later stages of development and was observed in the distal one-third of the fiber at 16 days (Figure 23) and at 37 days postanthesis (Figure 24). The nucleus at these times was irregularly shaped and lacked peripheral chromatin. The fiber nucleolus became smaller after 3 days postanthesis and apparently disappeared by about 6 days postanthesis (however, see Chapter 25).

The cytoplasm in the young fiber tip at 2 days postanthesis contained numerous dictyosomes, lipid bodies, endoplasmic reticulum, plastids, mitochondria and small vacuoles (Ramsey and Berlin, 1976a). Dictyosome-derived vesicles contained fibrils which were similar in morphology to the fibrils found in the primary cell wall (Figure 25). Similarities between dictyosome-associated vesicles and plasma membrane-associated vesicles were apparent, suggesting the former be-

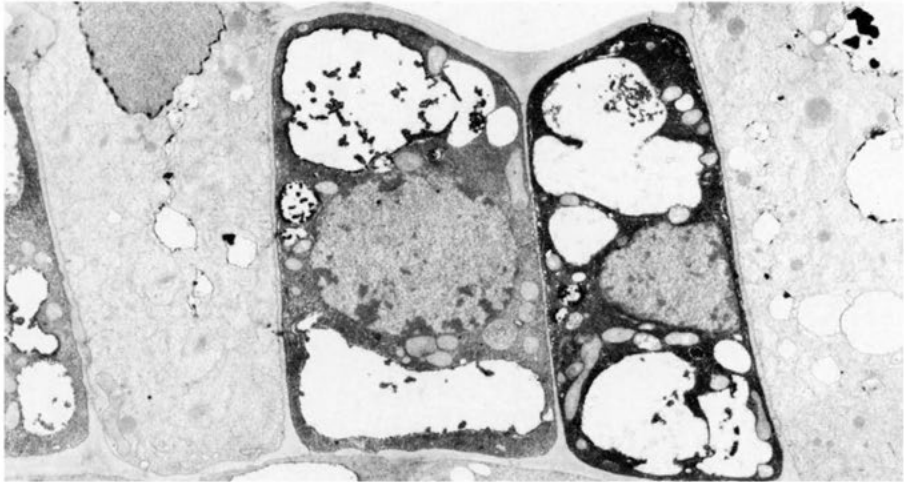

Figure 19. Two elongating lint fibers at 1 day postanthesis. The central vacuole has formed in the fibers above the seed surface. An accumulation of pigment material is characteristically found at the base of the enlarging central vacuole. (4,500X magnification). (From Ramsey and Berlin, 1976b).

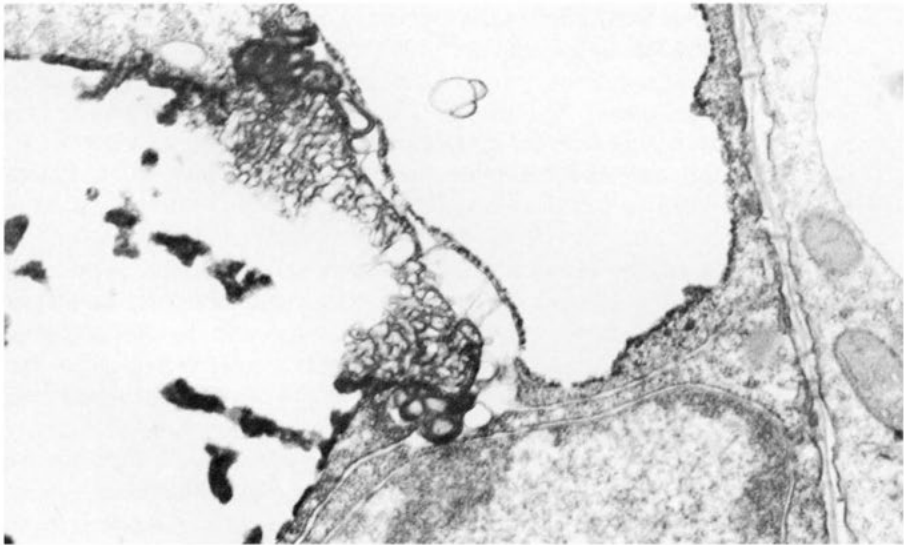

Figure 20. A portion of a dark cell on the day of anthesis with endoplasmic reticulum cisternae continuous with a fenestrated membranous network associated with a vacuole. The endoplasmic reticulum also shows continuity with the nuclear envelope. (44,000X magnification). (From Ramsey and Berlin, 1976a).

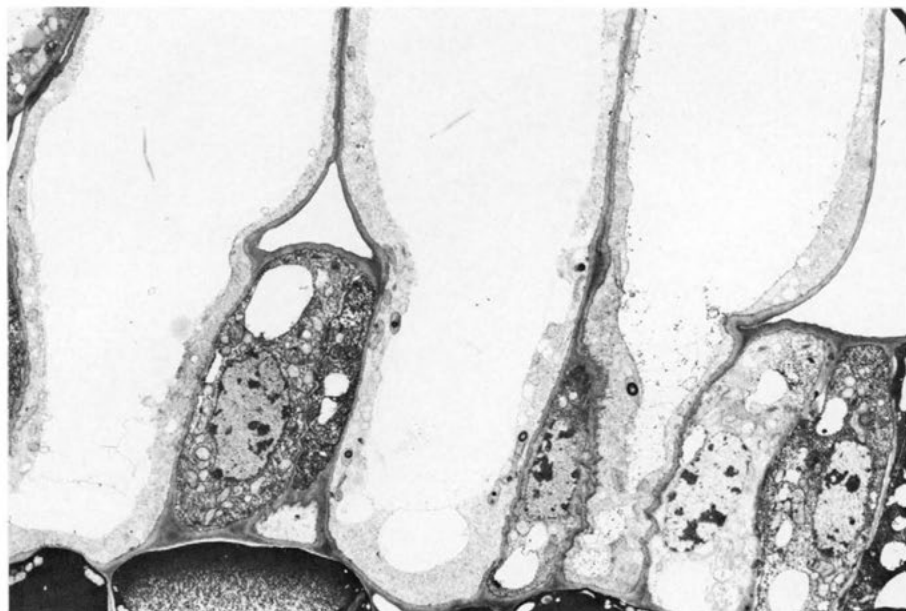

Figure 21. Cotton fibers at 2 days postanthesis have central vacuoles extending into the fiber bases, leaving a thin rim of cytoplasm around the central vacuole. Several small cytoplasmic vacuoles appear to be in the process of fusing with the tonoplast of the central vacuole. (5,000X magnification). (From Ramsey and Berlin, 1976b).

came the latter via an exocytotic secretory process (Ramsey and Berlin, 1976b; Westafer and Brown, 1976). Dictyosome-associated vesicles found in fibers during secondary cell wall thickening did not contain fibrils characteristically found in dictyosome-associated vesicles during primary cell wall synthesis.

Most of the ribosomes in the young fiber were free and unattached to membranes (Figure 25) and only a few were in the polysome configuration during primary cell wall synthesis. This situation was reversed during the early stages of secondary cell wall synthesis (Berlin and Ramsey, 1971; Westafer and Brown, 1976); the ribosomes were almost exclusively in the polysome configuration, and free unattached ribosomes were rarely found.

Microtubules, oriented parallel to the fibrils in the cell wall, were observed in all stages of cotton fiber development. Particles, approximately 15-20 nm in diameter, were observed between the plasma membrane and secondary cell wall and were oriented in chains parallel with the microtubules (Figure 26). An intriguing possibility is that these particles may represent membrane-bound cellulose synthetase enzyme complexes (Brown and Montezinos, 1976) responsible for the synthesis of the secondary cell wall. Particles were observed between the



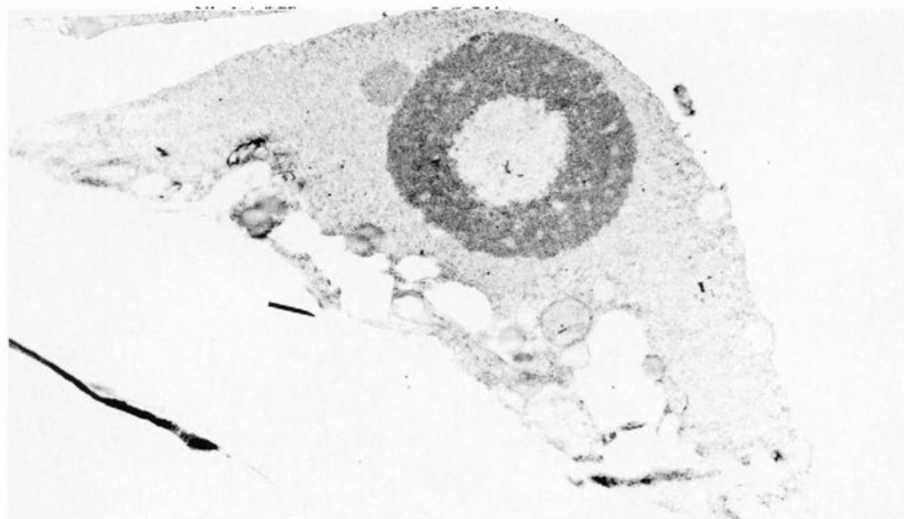

Figure 22. The nucleus of a 2-day postanthesis fiber contains an enlarged "bull's-eye" nucleolus. The nucleus is elliptically shaped and displaced to one side of the central vacuole. (7,000X magnification).



Figure 23. The nucleus of a 16-day postanthesis fiber is irregularly shaped and lacks heterochromatin and nucleoli. Several mitochondria with numerous cristae, plasma membrane-associated vesicles and the primary cell wall are shown. (37,500X magnification).

plasma membrane and primary cell wall as early as 2 days postanthesis; however, the frequency of particles observed increased tremendously during secondary wall synthesis.

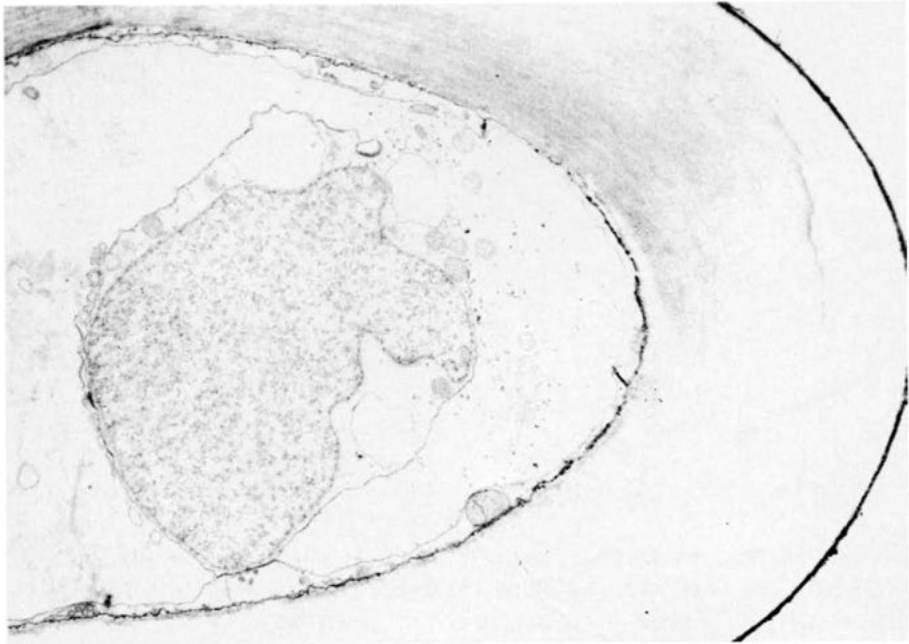

Figure 24. The nucleus of a 37-day postanthesis fiber is irregularly shaped, but structurally intact. Nuclei in old fibers lack a nucleolus and condensed chromatin. The mitochondrial cristae appear less numerous than in younger fibers. The characteristic secondary cell wall of a lint fiber is shown. (13,000X magnification).

Additional fibers were observed to initiate elongation at 6 days postanthesis (Figure 27). These late initiating fibers had dark cytoplasm containing many lipid bodies. The irregularly shaped nucleus was enlarged, had migrated from its central position in the epidermal cell toward the mid-region of the developing fiber and contained a large, elliptical nucleolus. Elongating dark and light cotton fibers could be distinguished at 7 days postanthesis (Figure 28). Farr (1933) observed that after the 6th day postanthesis, there was a marked contrast in fibers of different lengths. The longer ones, through increased vacuolation, became more and more hyaline and the shorter ones, in addition to their usual cytoplasmic density, became more opaque due to the apparent presence of a pigment in the cell cytoplasm. Epidermal cells of the seed coat accumulated mucilaginous and tannin-like compounds in the cell vacuoles a few days after anthesis (Lang, 1938). The presence of these substances in the vacuoles of the fuzz fibers was taken as evidence that such fibers originated several days after anthesis; fibers produced 1 to 2 days postanthesis did not contain these substances. Reeves (1936) and Brown and Ware (1958) also reported that in some varieties the lint and fuzz fibers were

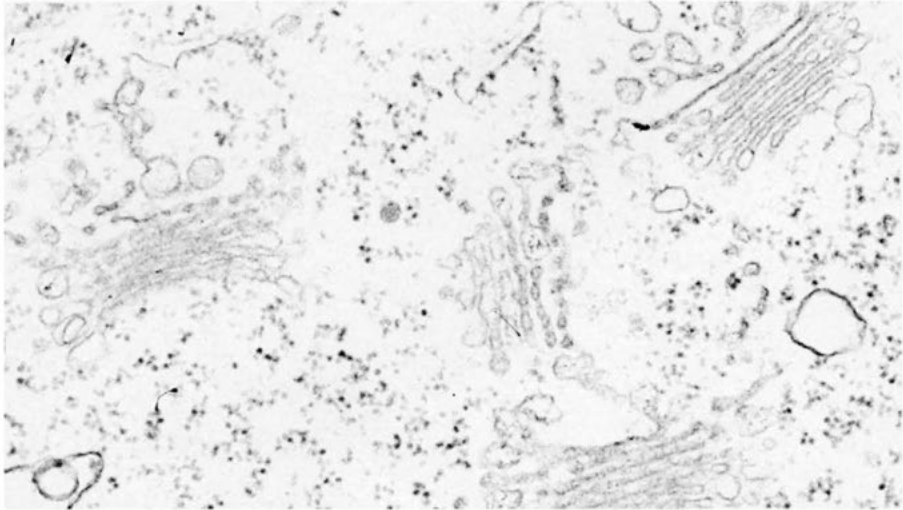

Figure 25. The cytoplasm at the tip of a 2-day postanthesis fiber. Numerous dictyosomes with cisternae containing fibrils similar to the fibrils found in the primary cell wall of the cotton fiber are shown. Most of the ribosomes are unattached, but many are in a helical configuration. (57,000X magnification). (From Ramsey and Berlin, 1976b).

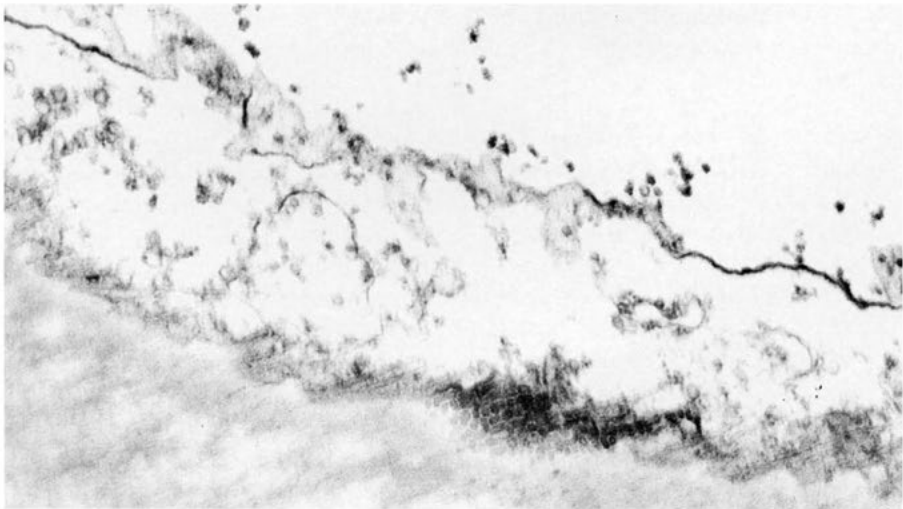

Figure 26. A tangential section of a 24-day postanthesis fiber. Particles located between the secondary cell wall and the plasma membrane apparently extend outward from microtubules in the cytoplasm. The possibility exists that the particles are membrane-embedded cellulose synthetases (Brown and Montezinos, 1976). (66,000X magnification).

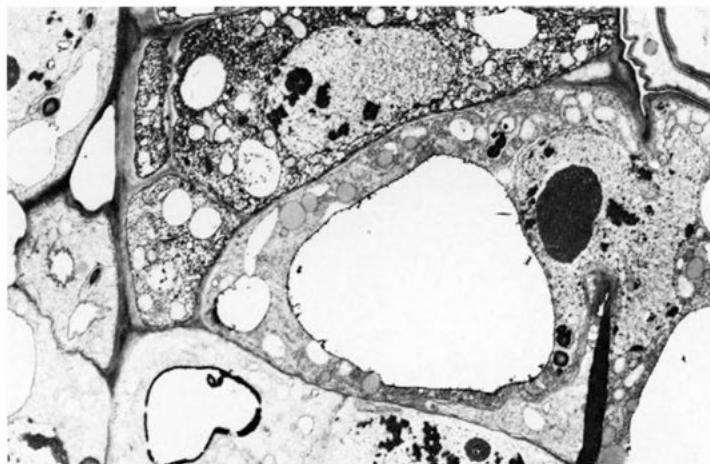

Figure 27. A slightly tangential section of the epidermal layer at 6 days postanthesis shows an initiating fuzz fiber. The fiber nucleus is enlarged, irregularly shaped and has migrated toward the fiber tip. An enlarged nucleolus is shown. The cytoplasm contains numerous vacuoles and lipid bodies. (8,500X magnification.)

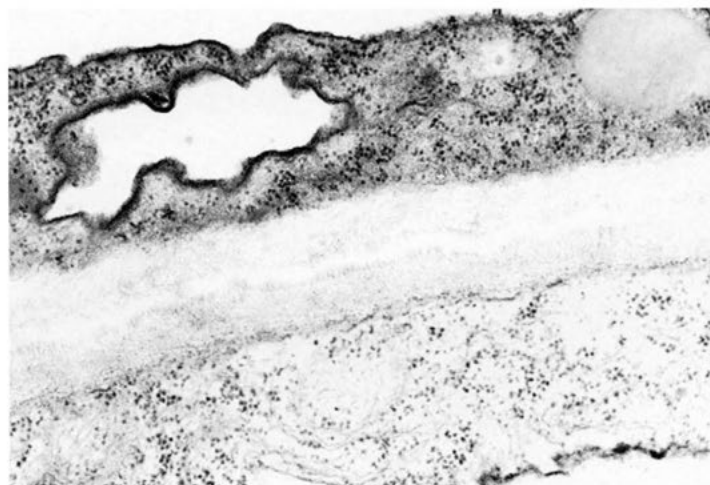

Figure 28. Portions of a light and dark fiber at 7 days postanthesis. The lint fiber has light cytoplasm and the fuzz fiber has an electron dense cytoplasm. Free, unattached ribosomes characteristic of the elongation stage are present in both fiber types. (38,000X magnification.)

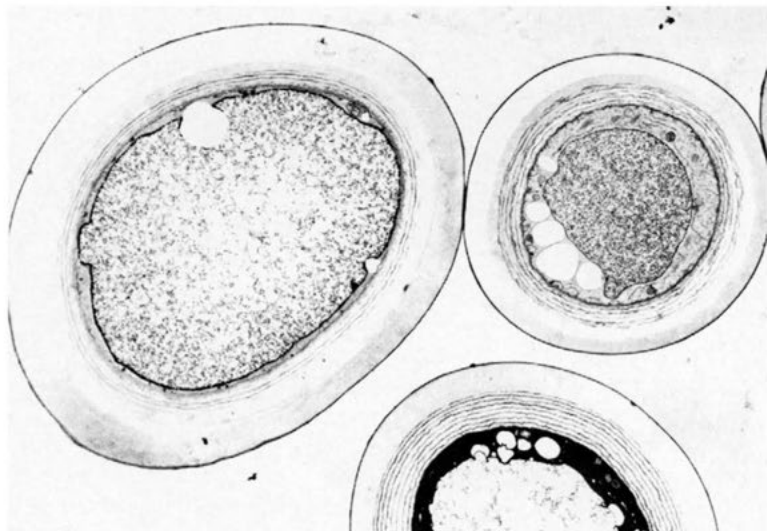

Figure 29. Cross-sections of fuzz fibers from Florida greenseed at 24 days postanthesis. Fuzz fibers are characterized by lamellae in the secondary cell wall, by dark cytoplasm and by pigments in the central vacuole. (6,300X magnification).

pigmented differently, and frequently pigment was present in the fuzz fibers when it was entirely absent from the lint fibers. The light and dark fibers were, therefore, identified as lint and fuzz fibers, respectively (Figure 28). Both types of fibers had free, unattached ribosomes (Figure 28) during the elongation stage of fiber development.

An electron microscopic examination of known fuzz fibers, e.g., the green fuzz from Florida greenseed (Figure 29), identified the dark fibers as fuzz fibers (Watson and Berlin, 1973). The fuzz fibers had dark cytoplasm similar to the cytoplasm of the initiating fiber shown at 4 days postanthesis. Other fibers had a light cytoplasm characteristic of lint fibers observed at anthesis and at one day postanthesis and, thus, can be identified as lint fibers (Figure 30). To repeat, fuzz fibers could be distinguished from lint fibers by their darker cytoplasm and greater amounts of condensed pigment in the lumen of the central vacuole. Additionally in older fibers, alternating light and dark rings (lamellae) were observed in the secondary cell wall of fuzz fibers (Figure 29). Lamellae, dark cytoplasm and large quantities of pigment were not observed in lint fibers (Figure 30). Cross sections of 24-day postanthesis fuzz fibers revealed that the number of lamellae was not the same in every fuzz fiber (Figure 29). Therefore, it is extremely doubtful that the fuzz fiber lamellae are equivalent to the temperature-related ring structures found in swollen cotton fibers by Grant *et al.* (1966). The density of the cytoplasm and the amount of pigment present in the central vacuole

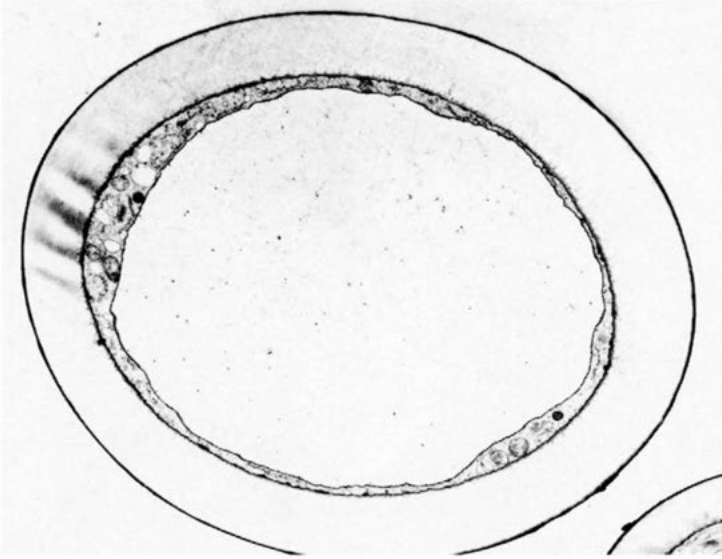

Figure 30. Cross-section of a lint fiber at 19 days postanthesis. Lamellae are not visible in the secondary cell wall, the cytoplasm is light and contains numerous organelles. Only a small amount of pigment is present in the central vacuole. (10,500X magnification).

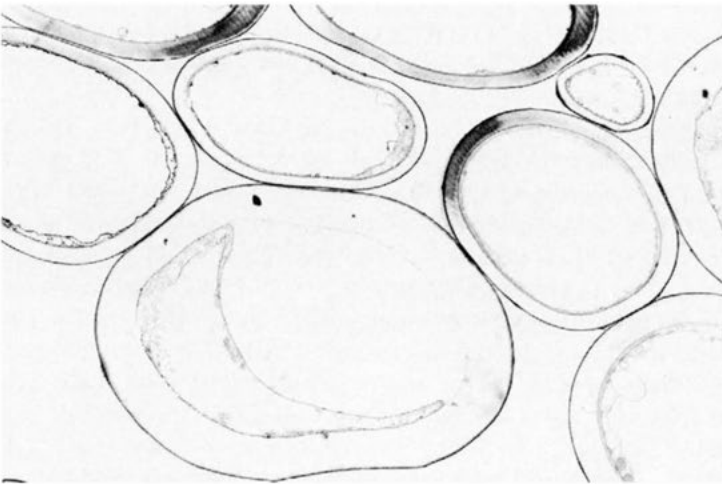

Figure 31. Cross-sections of lint fibers at 37 days postanthesis. Considerable variation in the thickness of the secondary cell wall is obvious. (6,000X magnification).

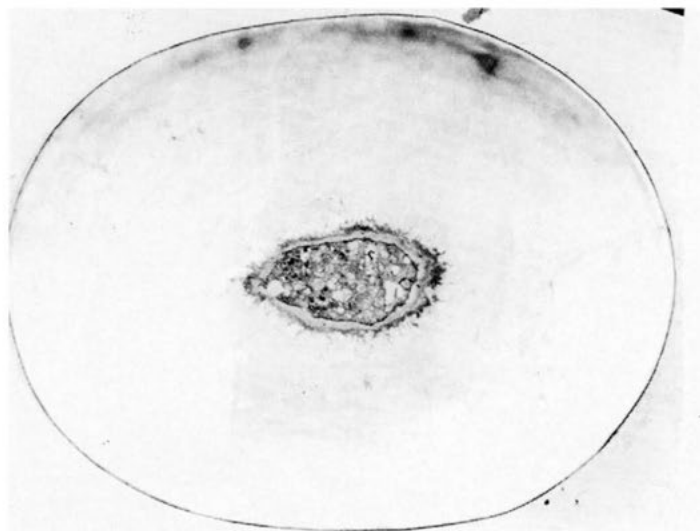

Figure 32. Cross-section of a lint fiber at 37 days postanthesis. An extremely thick secondary cell wall has reduced the lumen of the fiber. Such a thick cell wall is uncommon for lint fibers. (9,000X magnification).

varied considerably in fuzz fibers (Figure 29).

Cross sections of fibers at 37 days postanthesis revealed that some fibers at the chalazal end of the ovule had thin, immature, secondary cell walls (Figure 31). Other fibers were observed with thick secondary walls with the lumen of the fiber reduced to a small diameter due to cellulose deposition on the inner edge of the wall during formation of the secondary cell wall (Figure 32). The nonuniformity of cotton fiber cell walls has been quantitatively documented (Moore, 1941; Berlin *et al.*, 1981).

The ability to distinguish lint from fuzz fibers proved valuable in an examination of fiber bases. The base of the lint fiber has an exceedingly thin secondary cell wall (Figure 33). The paradermal expansion of the nonfiber epidermal cells squeezes the lint fiber base providing the elbow, shank and foot arrangement characteristic of the lint fiber (Fryxell, 1963). Most of the nonfiber epidermal cells synthesized a thick secondary cell wall with lamellations, and these cells were also filled with phenolic substances (Figure 34). The similarity between the nonfiber epidermal cells and the fuzz fibers with respect to these two features was striking.

The electron micrographs presented so far were obtained from cells that were not allowed to dry during specimen preparation. Obviously, when the boll opened under field conditions these cells did dry, shrink and distort. Upon drying, the shank of the lint fiber was crushed by the surrounding epidermal cells (Figure 35)

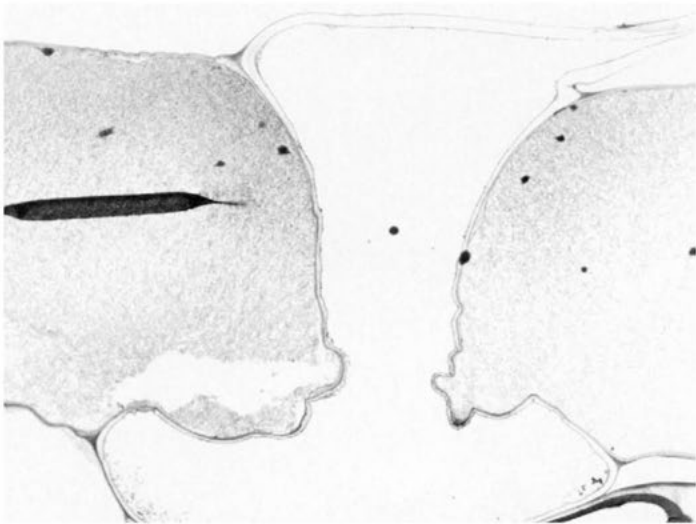

Figure 33. Median longitudinal section of the base of a lint fiber at 37 days post-anthesis. A thin, immature secondary cell wall is found at the base of lint fibers. Lateral pressure from the adjacent, pigment-filled, epidermal cells has constricted the middle of the fiber base causing it to protrude slightly below the bottom of the epidermal layer. (4,200X magnification).

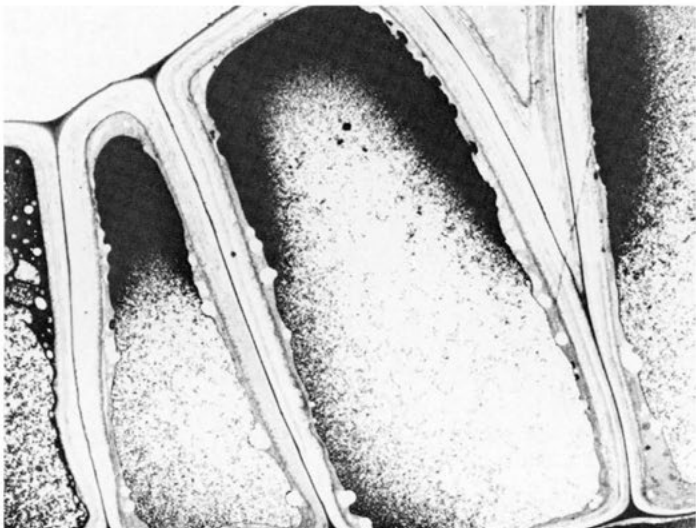

Figure 34. Median longitudinal section of the epidermal layer at 24 days post-anthesis. The epidermal cells over most of the seed surface have thick secondary cell walls containing lamellae similar to that found in fuzz fibers. The epidermal cells also contain pigments in their central vacuoles. (3,500X magnification).





Figure 35. The base of a dried lint fiber from an opened boll sample. The thin secondary cell wall of the lint fiber base has been crushed by the adjacent cells that distort and shrink upon drying. (6,000X magnification).

and, because of the nearly nonexistent secondary cell wall in this region, the lint fibers lacked a firm connection to the seed. The absence of the thick secondary cell wall at the base of the lint fiber is of obvious importance to the ginning process. In contrast, the base of the fuzz fiber had a thick secondary cell wall that extended into the epidermal layer (Figure 36). Upon drying and subsequent crushing by adjacent epidermal cells, the thick secondary cell wall at the base of the fuzz fibers literally anchored the fuzz fiber to the seed. The effect of drying on the bases of lint and fuzz fibers is diagrammed in Figure 37.

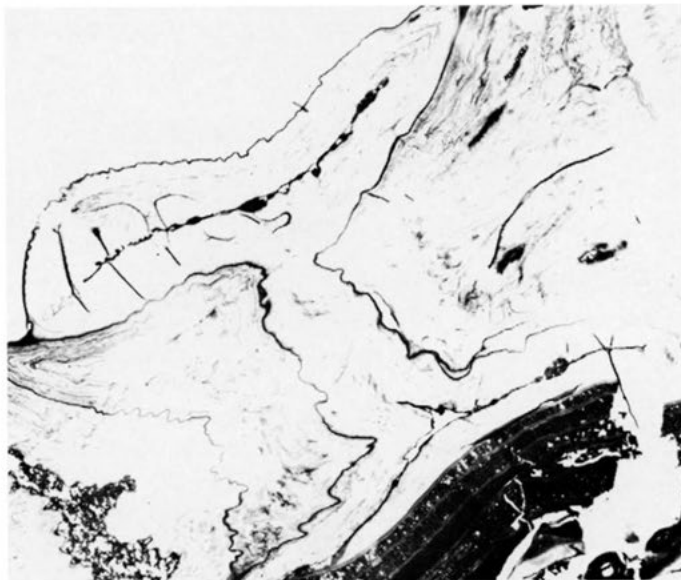

Figure 36. The base of a dried fuzz fiber from an opened boll sample. The thick secondary cell wall of the fuzz fiber extends into the epidermal layer and, presumably, is the major contributing factor in fuzz fibers remaining on seeds after ginning. (3,500X magnification).

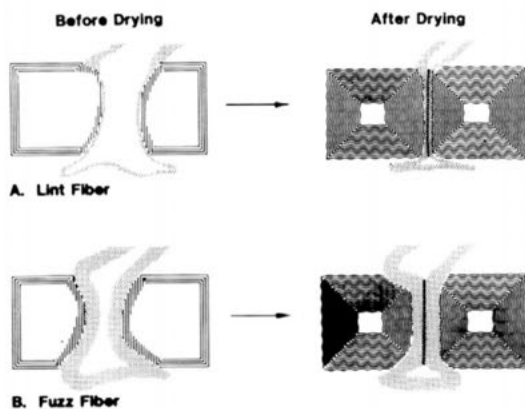

Figure 37. Diagram of the effects of drying on lint and fuzz fiber bases. Lint fibers have exceedingly thin secondary cell walls at their bases, whereas fuzz fibers have thick secondary cell walls that extend into the epidermal layers. The shank region of the lint fiber is crushed by adjacent epidermal cells upon drying resulting in a tenuous attachment of the lint fiber to the seed. The dried fuzz fiber is essentially anchored into the epidermal layer by virtue of the thick secondary cell wall at its base.

## AUTORADIOGRAPHIC ANALYSES OF THE EPIDERMAL LAYER

Fiber primordial differentiation and fiber development are exceedingly complex events. The morphology of these stages suggested underlying changes in subcellular functions. We have followed the incorporation of various radioactive precursors into these cells using autoradiography to identify some of these physiological changes.

The ability to grow cotton ovules in culture (Beasley, 1973) facilitated the study of fiber development without experimental complications from the ovary or other plant parts. In our autoradiographic studies, radioisotopes were added to Beasley's culture media, and their cellular incorporation was correlated with ovule and fiber development. Specifically, DNA synthesis, RNA synthesis, protein synthesis and an indication of possible phenolic synthesis were examined using tritiated thymidine, uridine, amino acids (a batch mixture of glutamic acid, glycine, leucine and lysine) and phenylalanine, respectively. The autoradiographic techniques, including the use of Nomarski contrast to examine unstained sections, was previously described (Smutzer and Berlin, 1976). The plant material used for the autoradiographic studies was the commercial cultivar DPL 16.

### THYMIDINE

The uptake of tritiated thymidine was expressed as numerous dots (exposed silver grains) in autoradiographs (Figure 38). Approximately 10 percent of the epidermal cells incorporated tritiated thymidine after a 15 minute incubation at 12 days preanthesis (Figure 39). A linear decrease in thymidine uptake was observed until 2 days preanthesis when none of the cells were labeled after a 15 minute incubation (a prolonged incubation of 12 hours revealed less than 5 percent of these epidermal cells had incorporated thymidine). After this absence of labeling, there was an increase in thymidine incorporation until 1 day postanthesis when 7 percent of the epidermal cells were labeled with a 15 minute incubation (Figure 39). Thereafter, a sharp drop in uptake occurred and very few epidermal cells were labeled between 3 and 6 days postanthesis. Thymidine was not incorporated into the epidermal layer after 6 days postanthesis (even with 12-hour incubation times).

The arrest of cell division in the epidermis at 2 days preanthesis was concomitant with differentiating fiber primordial cells (Aiyangar, 1951; Ramsey and Berlin, 1976a,b). These observations suggested that cell division and cell differentiation were antagonistic processes in the cotton epidermal cells. The change from synthesis of substances for the cell's own maintenance to synthesis of their differentiated products is often accompanied by the slowing or cessation of cell division (Elbert and Kaighn, 1966). Incorporation of thymidine by nonelongating cells was observed at anthesis; therefore, the early stages of cell elongation in neighboring fibers had little, if any, effect on the mitotic activity of nonelongating



Figure 38. Autoradiograph of the epidermal layer at 2 days postanthesis showing tritiated thymidine incorporation. The uptake of thymidine is shown by the dots overlying the cells. The nuclei of two cells in the epidermal layer are heavily labeled. Cytoplasmic labeling results from the incorporation of thymidine into mitochondria and proplastids. Nomarski interference contrast light micrograph of unstained section. (625X magnification).

epidermal cells. The cell cycle was not synchronized as both nonlabeled and labeled cells were present at the same time.

The epidermal cells did not incorporate thymidine after 6 days postanthesis. Ultrastructural observations suggested that the vacuoles of these cells enlarged and became filled with phenolic materials, and the nuclei were pushed to the sides of these cells. These chemical and morphological changes were probably related to the cessation of DNA synthesis in the epidermis, and it appeared unlikely that these differentiated cells would undergo mitosis after 8 days postanthesis. Farr (1931, 1933), however, found evidence of micropylar cells in apparent late telophase as late as 12 days postanthesis.

Hence, as a whole, the tritiated thymidine studies showed that ovule enlargement was due primarily to cell division up to 3 days postanthesis; whereas after this time, ovule enlargement (discussed later) was due to an increase in the size of

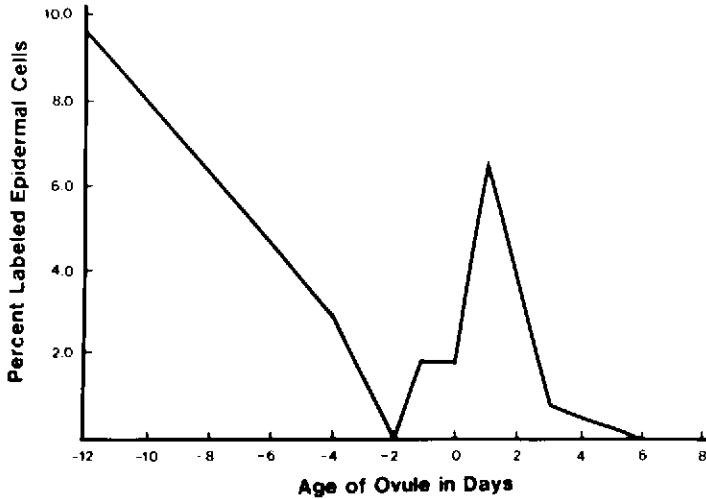

Figure 39. The percent labeled epidermal cells at different ovule ages after a 15-minute incubation in tritiated thymidine. Thymidine was not incorporated into the epidermal layer after 6 days postanthesis.

existing cells.

The assumption was made that cells synthesizing DNA were preparing to enter mitosis. Whether or not cell division occurred after thymidine incorporation could not be determined. Although considered unlikely, it is possible that the thymidine may have been degraded to an undetermined labeled fraction. Incorporation of such fractions into the nonnuclear portions of labeled cells appeared to be minimal, and it is likely that cytoplasmic labeling may have represented mitochondrial and proplastid incorporation of thymidine. A second alternative was that labeled thymidine may have been incorporated into DNA undergoing gene amplification in differentiating fiber primordial cells. This explanation appears unlikely since the percentage of cells incorporating thymidine in the epidermal layer during differentiation into fibers was low. If fiber primordial cells were undergoing gene amplification, at least 10 percent of the epidermal cells would have to be labeled since approximately 1 in 10 epidermal cells initiate elongation at anthesis. No incorporation was observed over nuclei in elongating fibers after anthesis. These observations suggested that gene amplification did not occur during fiber development at any time tested. In summary, it appears that the best interpretation of these experiments is that thymidine incorporation occurred as DNA was synthesized in preparation for cell division.

## URIDINE

The incorporation of tritiated uridine by fiber primordia and elongating fibers

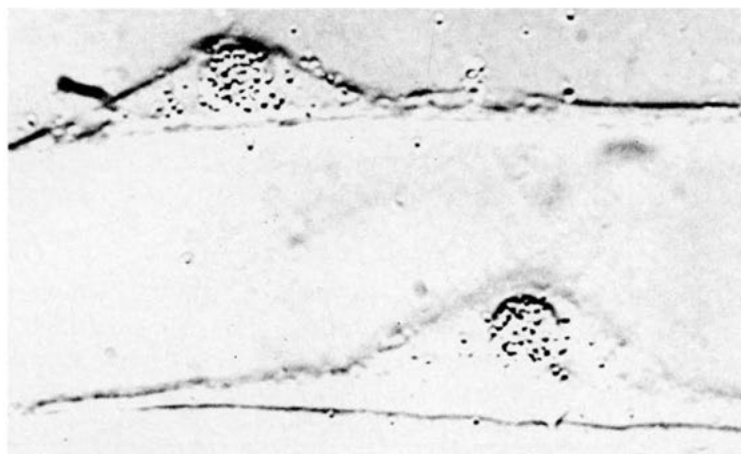

Figure 40. Autoradiograph of tritiated uridine incorporation in fibers at 2 days postanthesis. The bulk of the exposed silver grains over the large nucleoli in the developing fibers is suggestive of mRNA synthesis. Nomarski interference contrast micrograph of an unstained section. (1450X magnification). (From Smutzer and Berlin, 1976).

occurred from 1 to 6 days postanthesis (Figure 40). The incorporation at 6 days postanthesis was slight and virtually no uridine incorporation occurred in fibers after 6 days postanthesis. These results indicated that the bulk of fiber RNA was made from 1 to approximately 5 days postanthesis. The greatest uptake of uridine in fiber cells occurred at 3 days postanthesis when both total cellular and nucleolar incorporation were highest. The increase in nucleolar incorporation occurred in the enlarged nucleolus previously described in the morphological studies.

Most, if not all, of the cellular RNA occurring in fiber cells was synthesized prior to 6 days postanthesis. Differing chemical compositions of primary and secondary cell walls (Frey-Wyssling and Muhlethaler, 1965) indicate the probability of different enzymes functioning during the elongation and thickening stages. Indeed, biochemical evidence suggests that different enzyme systems are necessary for primary and secondary cell wall synthesis in cotton (Delmer *et al.*, 1974). The synthesis of fiber RNA prior to 6 days postanthesis suggested the existence of a long-lived mRNA that would be translated into the enzymes required for secondary cell wall synthesis sometime after 16 days postanthesis. Clay *et al.* (1975) and Walters and Dure (1966) have found evidence of long-lived messenger RNA in germinating cotton seeds, and the extension of its presence in fiber development seems logical. Since it was not experimentally feasible to observe every time period in fiber development, small spurts of RNA synthesis could have been missed in this study, but it seems apparent that all or nearly all of the RNA utilized in fiber development was synthesized shortly after anthesis.

In these studies, two assumptions were made in comparing uridine incorporation to actual RNA synthesis. First, it was assumed that the cellular uridine pool did not change with time. If this is not the case, an increase in the uridine pool would necessitate an increase in the amount of tritiated uridine to give the same level of labeling. Secondly, it was assumed that the ability of uridine to enter fiber cells did not change during the different stages of fiber development. These changes could not be detected by the methods employed in our study.

### AMINO ACIDS

The ability of the epidermal layer to synthesize proteins was assayed by their uptake of a mixture of four radioactive amino acids (glutamic acid, glycine, leucine and lysine). The uptake of amino acids in the epidermal layer occurred from the earliest day tested (6 days preanthesis) until 3 days postanthesis with resumption of uptake at 22 days postanthesis. No uptake was observed at 6, 16, or 33 days postanthesis. Peak incorporation occurred at 4 days preanthesis, anthesis and to a lesser extent at 3 days postanthesis. Interestingly, the subepidermal cells incorporated a greater amount of the mixture of radioactive amino acids than did the epidermal cells at times near anthesis (Figure 41).

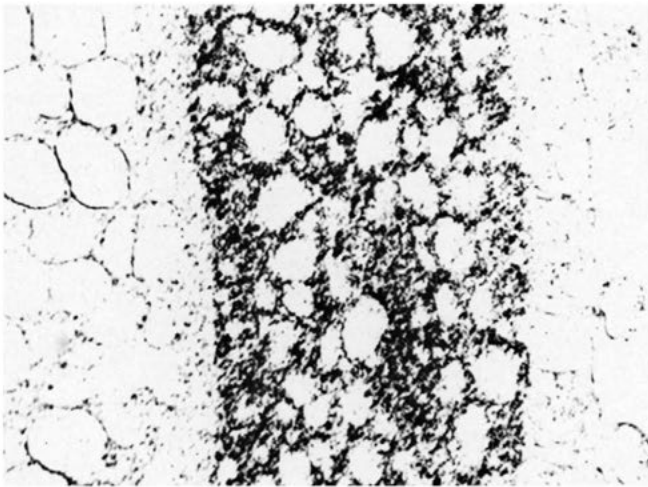

Figure 41. Autoradiograph of 1 day postanthesis cotton ovule exposed to a mixture of amino acids (glutamic acid, glycine, leucine and lysine). The young, elongating fibers are outlined by cytoplasmic incorporation of the amino acids. The majority of the label occurs in the subepidermal cells. Nomarski interference contrast micrograph of an unstained section. (625X magnification).

Several ultrastructural changes occurred in epidermal cells that may have been related to increased uptake of amino acids from 4 days preanthesis to anthesis

(Berlin and Ramsey, 1970; Ramsey and Berlin, 1976a,b). First, there was an increase in the cytoplasm to cell size ratio of epidermal cells prior to anthesis. Second, shortly before anthesis, the previously electron-light vacuoles contained dense phenolic pigments. Third, an increase in the endoplasmic reticulum and in the number of free ribosomes was found in fiber primordia prior to their initiation of elongation. Fourth, increased numbers of dictyosomes were found in epidermal cells that had initiated elongation. All of these morphological changes may have been related to increased amino acid incorporation into cellular proteins. Metabolism of proteins are necessary for an increase in cytoplasmic ground substance, ribosome production and dictyosomal synthesis. A multitude of new enzymes may be necessary to direct the preanthesis synthesis of electron dense phenolic pigments.

From fiber initiation at anthesis to 3 days postanthesis, rapid ultrastructural changes may have again been related to increased amino acid incorporation found at these stages of ovule development. The elongation of certain epidermal cells from 10  $\mu\text{m}$  to over 2,000  $\mu\text{m}$  in length, with most of the cell volume taken up by a large central vacuole, dictated a large increase in membrane expansion. Geometric calculations of elongated cells indicate over a 2,000 fold increase in the surface area of the plasma membrane and tonoplast had occurred by 3 days postanthesis. The increase in membrane expansion may have been related to some or all of the increased amino acid incorporation occurring from 4 days preanthesis to 3 days postanthesis.

During the period of primary cell wall synthesis, the bulk of amino acid label in the fiber was observed prior to 6 days postanthesis. With fiber length continuing until approximately 27 days postanthesis (Schubert *et al.*, 1973) and ultimately increasing 3,000 times in length (Watson and Berlin, 1973), apparently most of the proteins were synthesized prior to 6 days postanthesis. Wakelyn (1975) found evidence of free amino acids occurring during primary wall extension. Free amino acids would have been removed by our method of specimen preparation and would not have been detected by autoradiography. It is possible that after 6 days postanthesis, protein components for continued membrane and cell wall extension were synthesized from a free amino acid pool. Another alternative is that by 6 days postanthesis until 22 days postanthesis, the labeled amino acids may have been incapable of entering the fibers and, if such conditions existed, would not have been detected by autoradiography at these times. The resumption of incorporation after 22 days postanthesis would tend to negate this latter possibility.

### **PHENYLALANINE**

The epidermal cells and the young fibers were extensively labeled with phenylalanine at 1 day postanthesis (Figure 42). The cytoplasm of the subepidermal cells was also labeled with this amino acid, and the amount of subepidermal labeling increased in older cottonseeds.

The decamination of phenylalanine by phenylalanine ammonia lyase is an early step in the formation of numerous phenolic compounds (Walker, 1975; Ribereau-





Figure 42. Autoradiograph of 1 day postanthesis ovule incubated in tritiated phenylalanine. The cells in the epidermal layer as well as the young fibers are extensively labeled, probably due to the incorporation of phenylalanine into phenolics. Nomarski interference contrast micrograph of an unstained section. (625X magnification).

Gayon, 1972). We hoped to get some indication of phenolic biosynthesis in the epidermal layer by comparing phenylalanine incorporation to the mixture of amino acids. As an amino acid, phenylalanine incorporation would be expected to closely parallel the incorporation of other amino acids. Any variation in the uptake of phenylalanine from the other amino acids would be presumptive evidence for phenolic biosynthesis, especially if the activity could be positively correlated with the cytochemical localization of phenolics.

The difference in autoradiographic results between phenylalanine and the four amino acids used to detect protein synthesis, especially at 1-day postanthesis (compare Figures 41 and 42), suggested phenylalanine might be incorporated into phenolics (especially in the epidermal layer and young fibers), as well as into proteins. Phenylalanine uptake in the epidermal layer closely paralleled the phenolic activity observed in these cells in our morphological studies.

The combining of phenolics with proteins may regulate cell development by altering enzymes and organelles (Swain, 1965). Naturally occurring phenolics may act *in vivo* as inhibitors or activators of indole acetic acid (IAA) by interacting with IAA oxidase (Henderson and Nitch, 1962; Reynolds and Maravolo, 1973; Zenk and Muller, 1963). Kosmidou-Dimitropoulou reported that IAA stimulated fiber elongation (Chapters 23 and 25).

A heavy labeling of subepidermal cells with phenylalanine at later stages of ovule development was probably related to the increased tannin content in the integuments of the ovule.

Table 1. Comparison of cotton ovules at anthesis.

Kultivar or strain	Surface area (mm <sup>2</sup> )	Number of surface cells	Uncorrected fibers/seed	Surface with fibers (%)	Corrected fibers/seed
Florida Greenseed	4.40	54,000	16,000	80	12,800
CB 3051	3.71	55,200	11,300	50	5,700
Dunn 56C	4.06	61,700	10,800	60	6,480
Sea Island	3.97	70,800	1,000	30	300
Texas 429	4.03	69,400	0	0	0
Isogenic Naked	3.96	66,200	0	0	0
Mexican Acala	3.40	57,500	0	0	0

## THE SEED SURFACE

The number of epidermal cells and fibers per seed was obtained by calculating the surface area of the cottonseed (Figure 43) assuming it to be an eccentric spheroid (Farr, 1931) and, by proportion, converting the number of features in the area of a scanning electron micrograph of the seed surface (a magnification of about 500X was required) to the number of cells and/or fibers per surface area of the cottonseed.

Examination of ovule surfaces on the day of anthesis with the scanning electron microscope (Figure 44) revealed about 60,000 cells per ovule regardless of the cotton type (Table 1). However, cotton types differed greatly in the pattern of fiber initiation. For example, naked seed strains showed no fiber elongation at anthesis, whereas Dunn 56C and Florida Greenseed had 50 and 80 percent, respectively, of their surfaces covered with fibers at anthesis (Table 1). The corrected number of fibers per seed was obtained by counting the number of fibers in the area containing fibers and multiplying by the percent area of the seed with fibers.

The cell count data go hand-in-hand with our autoradiographic results of thymidine incorporation, i.e., cell division in the epidermal layer ceases at about 6 to 8 days postanthesis. Subsequent seed enlargement (Figure 43) was accompanied by increased cell size and not increased cell number.

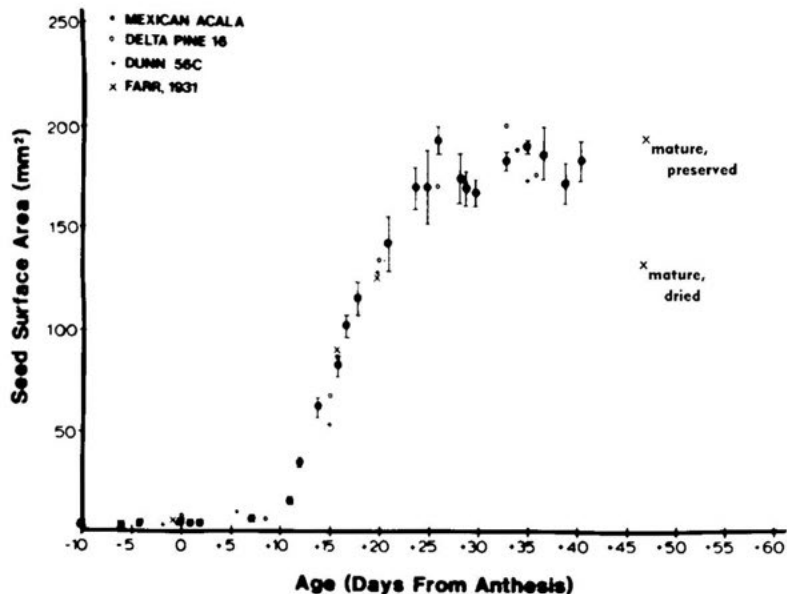

Figure 43. The increase in cottonseed surface area with age. The surface area was calculated assuming the cottonseed to be an eccentric spheroid (Farr, 1931). Farr's data for 5 cottonseeds are included and illustrate the shrinkage of the cottonseed caused by aging. The vertical bars indicate 2 standard errors of the mean.

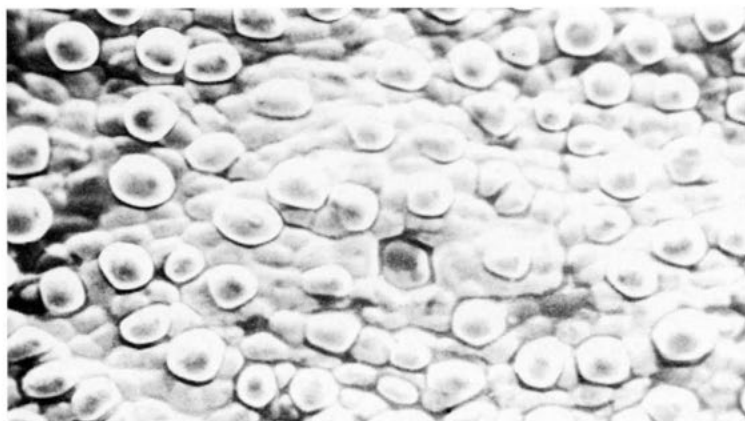

Figure 44. Scanning electron micrograph of the cottonseed surface at 1 day post-anthesis showing fiber primordia initiating elongation. (500X magnification). (From Ramsey and Berlin, 1976a).

Our previous results with the transmission electron microscope afforded us the ability to distinguish lint and fuzz fibers with the scanning electron microscope. Very simply, lint fibers have thin-walled bases and fuzz fibers have thick-walled bases. It was necessary to hydrolyze the fibers with concentrated sulfuric acid to observe the surface of fiber-bearing seeds (Figure 45). The lint and fuzz fibers

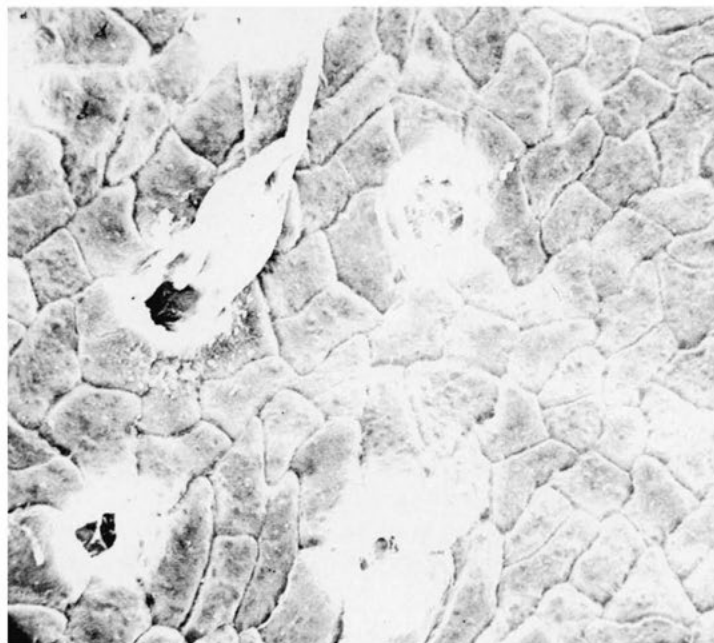

Figure 45. Scanning electron micrograph of the seed surface of a mature, but never-dried seed. Most of the fibers were hydrolyzed with a short rinse in concentrated sulfuric acid to expose the seed surface. The outlines of the epidermal cells are obvious. A single fiber is shown emerging from the epidermal layer. The thick-wall surrounding the hole in the epidermal layer in the middle of the micrograph represents the base of a fuzz fiber. (800X magnification.).

could be distinguished on the basis of their secondary cell wall. Comparing cell and fiber counts from about ten strains and varieties, we found the lint fiber to epidermal cell ratio varied tremendously between different cotton types. It appeared that for most naked seed strains there was one lint fiber for every 21 epidermal cells. What would happen if this ratio could be altered from 1:21 to 2:21? In fact, this happened with commercial cultivars. For example, at 15 days postanthesis the cultivar Dunn 56C had about 31,000 lint fibers and 340,000 epidermal cells, or a lint fiber to epidermal cell ratio of 1:11. These numbers appear to be genetically determined, and it is possible that this represents a genetic trait that might be

beneficially incorporated into commercial cultivars. Would a change in this ratio from 1:11 to 1:10 be reflected by a 10 percent increase in yield? The fuzz fiber to epidermal cell ratio on Dunn 56C was about 1:13. It is interesting that the presence of fuzz fibers on cottonseeds is positively correlated with lint fiber yield.

## SUMMARY

In summary, the epidermal cells showed a progressive increase in size from 23 days preanthesis to about 20 days postanthesis. Mitotic figures were found in the youngest samples examined through six days postanthesis. Similarly, thymidine incorporation occurred in the epidermal layer (except at 2 days preanthesis) until cessation at six days postanthesis. The number of epidermal cells increased from about 1,000 at 23 days preanthesis to about 60,000 at anthesis and to nearly 350,000 cells at 6 days postanthesis. If the cell divisions were synchronous and all cells participated, these numbers would mean that there were 6 cell divisions from 23 days preanthesis to anthesis and 3 cell divisions from anthesis to 6 days postanthesis. The time required for a cell division would decrease from 5 days to 2 days for the pre- and postanthesis periods, respectively. The surface area of the epidermal cells increased from approximately  $60 \mu\text{m}^2$  at anthesis to about  $200 \mu\text{m}^2$  at 15 days postanthesis. The major increase in cottonseed surface area (in most cottons from about 10 to  $200 \mu\text{m}^2$ , respectively) occurred between 10 and 25 days postanthesis.

The accumulation of phenolic compounds in vacuoles just prior to anthesis and the preferential incorporation of phenylalanine into the epidermal layer at anthesis suggests a prominent role for these compounds in epidermal cells. Indeed, phenolic compounds appeared to play a role in the differentiation of fiber primordia. The epidermal cell vacuoles became filled with phenolics, and some of these compounds were subsequently dispersed into the cytoplasm of fiber primordia. On the other hand, the phenolics in the nonfiber cells remained within the vacuoles. It is possible that these observations are a morphological manifestation of a mechanism regulating fiber differentiation. Phenols can regulate IAA activity by interacting with IAA oxidase, the enzyme that destroys IAA (Henderson and Nitch, 1962). It would appear that the cells in the epidermal layer are subject to individual growth regulation via phenolic compounds. A working hypothesis would be that this phenomena would regulate the fiber to nonfiber ratio and, possibly, the lint to fuzz fiber ratio on the cottonseed. This hypothesis should be amenable to testing using ovule culturing techniques (Beasley, 1973) to screen various phenolic substances.

The huge increase in phenolics in the epidermal cells at 8-10 days postanthesis is likely a reflection of a metabolic storage system that ultimately provides a protection device for the cottonseed (phenolics are known to confer disease resistance to plants, Ribreau-Gayon, 1972). (See also Chapter 38).

The morphological and autoradiographic observations suggested that RNA and protein synthesis may be stage specific and may occur well in advance of their

apparent need in the developing fiber. In particular, rRNA and mRNA required for secondary cell wall synthesis during the thickening stage appeared to be synthesized during the first 6 days postanthesis.

### ACKNOWLEDGMENTS

It is a pleasure to acknowledge the technical help of James Ramsey, Greg Smutzer, David Knezek and Melvin Watson and the helpful criticism of Susan Middleton and Sharla Short in the preparation of the manuscript. Supported in part by grants from Cotton, Inc., the research and marketing company representing Amercia's cotton producers and the Plant Stress Institute, Texas Tech University.

## Chapter 27

CHEMISTRY AND BIOLOGY OF  
THE COTTONSEED GLOBULINS

Julius W. Dieckert  
Texas A&M University  
College Station, Texas  
and

Robert W. Wallace  
University of Alabama Medical School  
Birmingham, Alabama  
and

Marilync C. Dieckert  
Texas A&M Research Foundation  
College Station, Texas

## INTRODUCTION

The history of the cottonseed globulins is long, but the progress in understanding their chemistry and biology has been slow. As late as 1963 Altschul (1964) pointed to the fact that up to that time supposedly pure protein fractions were heterogeneous by modern analytical criteria. A review of the earlier work on the cottonseed proteins is provided by Altschul *et al.* (1958). Rossi-Fanelli *et al.* (1964) seem to be the first to isolate a monodisperse globulin from cottonseed. They called it "acalin A". Rossi-Fanelli (1968) reported the isolation of a second globulin from cottonseed which he named "acalin B". Berardi *et al.* (1969) described a two-step process that separated the cottonseed proteins into an albumin (Isolate I) and a globulin (Isolate II) fraction. We have established (Wallace, 1976) that Isolate II is a mixture containing mostly acalin A and acalin B.

It seems clear that most of the globulins of the mature cottonseed are localized in the aleurone grains (Hensarling *et al.*, 1969; Martinez *et al.*, 1970). Our ultrastructural analysis indicates that cottonseed aleurins are synthesized and sequestered in a system of endoplasmic reticulum, dictyosomes and vacuoles (Dieckert and Dieckert, 1976a). The process seems common to phylogenetically diverse seed plants including peanuts, shepherd's purse (Dieckert and Dieckert, 1976a) and coconut solid endosperm (Dieckert and Dieckert, unpublished data).

## CHEMISTRY OF ACALIN A AND ACALIN B

As mentioned before, acalin A and acalin B are the principal aleurins of cottonseed (Rossi-Fanelli *et al.*, 1964, 1968). We have determined the molecular weight of acalin A by sedimentation equilibrium (Wallace, 1976). Native acalin A in .03 M NaCl, pH 7.0 (NaOH) has a molecular weight of about 119,000 daltons. The same protein in 0.3 M NaCl, 0.1 sodium phosphate, pH 7.0, has a molecular weight of about 198,000 daltons. The dimerization seems to be caused by the presence of phosphate ion and not by a difference in ionic strength. Apparently, Rossi-Fanelli *et al.* (1964) had acalin A in the dimer form, since they report a molecular weight of about 180,000. They also report a value  $S_{20,w}^0$  of 9.2 for acalin A. A well-behaved spherical protein of 188,300 molecular weight would exhibit such a value. Analysis of native acalin A by ORD shows only about 1.3 percent  $\alpha$ -helix (Wallace, 1976). Acalin A appears to be a glycoprotein because it precipitates in the presence of concanavalin A and is bound by concanavalin A attached to sepharose (Wallace, 1976). The bound acalin A is released from the adsorbent by solutions containing  $\alpha$ -methyl-D-mannoside. Finally, the major subunit of acalin A gives a positive Schiff test on separation by SDS gel electrophoresis.

Acalin B was less completely analyzed than acalin A. However, analysis by ORD shows it to contain only about 3.6 percent  $\alpha$ -helix (Wallace, 1976). The principal subunits of acalin B do not seem to be glycoproteins. However, the best preparations obtained so far contain small quantities of acalin A, a glycoprotein. Both acalin A and acalin B contain several subunits when denatured with SDS. The principal subunits of acalin A and acalin B were isolated from the best available preparations of the parent proteins by the procedure of Wallace *et al.* (1974) and Wallace and Dieckert (1976). The subunit composition of acalin A is given in Table 1. Some of the subunits are present as disulfide-bridged pairs of polypeptide chains. The principal one has a molecular weight of about 98,000 daltons and is composed of two subunits of about 49,000 daltons molecular weight which may or may not be identical. A second, less abundant subunit has a molecular weight of about 80,000 daltons which upon reduction with  $\beta$ -mercaptoethanol yields two subunits of 49,000 and 31,000 daltons. A very minor component exhibits a molecular weight of 77,000 daltons. On reduction subunits of 49,000 and 28,000 are obtained. The most abundant subunit of acalin A has a molecular weight of about 53,500. This subunit is not present as a disulfide-bridged pair and shows no sign of polymerization. Three other subunits with similar properties are of molecular weights 46,000, 31,000 and 18,000 daltons, respectively. These six subunits account for most of the mass of acalin A.

Two disulfide-bridged subunits were isolated from acalin B (Table 2). One of these,  $P_{36}$ , has a molecular weight of approximately 35,000 and consists of two subunits of about 20,000 and 15,000 daltons, respectively. The second,  $P_{42}$ , has a molecular weight of approximately 42,000 and consists of two disulfide-bridged



Table 1. Molecular weight of the subunits of acalin A of cotton

Protein	State <sup>1</sup>	Mol. wt. <sup>2</sup>	A-S-S-B
P <sub>98</sub>	not red.	98,000	P <sub>49</sub> -S-S-P <sub>49</sub>
P <sub>49</sub>	red. <sup>3</sup>	49,000	
P <sub>80</sub>	not red.	80,000	P <sub>49</sub> -S-S-P <sub>31</sub>
P <sub>49</sub>	red.	49,000	
P <sub>31</sub>	red.	31,000	
P <sub>77</sub>	not red.	77,000	P <sub>49</sub> -S-S-P <sub>28</sub>
P <sub>49</sub>	red.	49,000	
P <sub>28</sub>	red.	28,000	
P <sub>54</sub>	not. red.	53,500	NO
P <sub>46</sub>	red.	46,000	NO
P <sub>31</sub>	red.	31,000	NO
P <sub>18</sub>	red.	18,000	NO

<sup>1</sup>All subunits were denatured with Sodium Dodecyl Sulfate (SDS).

<sup>2</sup>Molecular weights were determined by SDS-page.

<sup>3</sup>Subunits reduced with  $\beta$ -mercaptoethanol.

Table 2. Molecular weight of the subunits of acalin B of cotton

Protein	State <sup>1</sup>	Mol. wt. <sup>2</sup>	A-S-S-B
P <sub>42</sub>	not red. <sup>3</sup>	42,000	P <sub>23</sub> -S-S-P <sub>22</sub>
P <sub>23</sub>	red.	22,500	
P <sub>20</sub>	red.	20,000	
P <sub>35</sub>	not red.	35,000	P <sub>15</sub> -S-S-P <sub>20</sub>
P <sub>15</sub>	red.	15,000	
P <sub>20</sub>	red.	20,000	

<sup>1</sup>All subunits were denatured with SDS.

<sup>2</sup>Molecular weights were determined by SDS-page.

<sup>3</sup>Subunits were reduced with  $\beta$ -mercaptoethanol.

subunits of 20,000 and 22,000 daltons, respectively. Acalin B contains several other components, probably including acalin A contaminants. The individual reduced subunits of P<sub>35</sub> and P<sub>42</sub> have not yet been isolated. The amino acid composition of P<sub>35</sub> and P<sub>42</sub> was determined by the same procedures as mentioned below for the acalin A subunits.

## POSSIBLE HOMOLOGIES

The amino acid composition of P<sub>98</sub>, P<sub>54</sub>, P<sub>31</sub> and P<sub>18</sub> of acalin A was determined after hydrolysis with methanesulfonic acid containing 3-(2-aminoethyl) indole (Liu and Chang, 1971; Simpson *et al.*, 1976). The hydrolysis time was varied in order to estimate the labile amino acids and those released with difficulty. Half-cystine was determined as cysteic acid and methionine as methionine sulfone after performic acid oxidation and hydrolysis with 4 N HCl (Hirs, 1967). Over 93 percent of the dry weight of each subunit was accounted for by the weight of the amino acid residues recovered.

A comparison of the amino acid compositions was made using the Metzger Difference Index (Metzger *et al.*, 1968) as discussed by Dieckert and Dieckert (1976b, 1978). The pairwise comparison of the acalin A subunits is given in Table 3. All of the values of the difference index were less than 9 where a number less than 15 is considered presumptive evidence of genetic homology. The acalin A subunits appear to be genetically related but variable in molecular weight and amino acid composition. We think that several non-allelic structural genes code for the subunits. P<sub>36</sub> and P<sub>49</sub> have very similar amino acid compositions; however, P<sub>46</sub> does not seem to form disulfide-bridged pairs, whereas P<sub>49</sub> does. The question of the relationship between P<sub>18</sub> and P<sub>31</sub> remains open. These proteins may be the products of separate genes or cleavage products of one of the larger subunits. In either case the low values of the difference index for protein pairs involving P<sub>18</sub> or P<sub>31</sub> and the other subunits (Table 3) suggest the larger ones may have evolved

Table 3. Metzger indices for the subunits of acalin A<sup>1</sup>.

Subunit <sup>2</sup>	P <sub>18</sub>	P <sub>31</sub>	P <sub>46</sub>	P <sub>49</sub>
P <sub>54</sub>	5.5	5.2	6.8	7.0
P <sub>49</sub>	8.2	7.2	2.4	
P <sub>46</sub>	8.7	7.8		
P <sub>31</sub>	6.2			

<sup>1</sup>Acalin A from *G. hirsutum* Acala (Wallace, 1976).

<sup>2</sup>The subscript denotes MW x 10<sup>-3</sup>.

from a much shorter common ancestor by gene duplication and fusion. Definitive answers to these questions should be forthcoming as sequence data on the individual proteins becomes available. (Also see Chapter 28).

A comparison of the amino acid compositions of P<sub>35</sub> and P<sub>42</sub> (acalin B) by the Metzger criterion suggests the two proteins are homologous (Table 4). P<sub>35</sub> cannot be a simple cleavage product of P<sub>42</sub>, since P<sub>35</sub> contains more lysine and histidine residues than P<sub>42</sub>. P<sub>35</sub> or P<sub>42</sub> cannot be simple cleavage products of P<sub>46</sub>, P<sub>49</sub> or P<sub>54</sub> of acalin A because there are too many tryptophan and methionine residues. The

Table 4. Comparison of P<sub>35</sub> of acalin B with legumin-type proteins

Protein		Source	D.I.
P <sub>22</sub> P <sub>20</sub>	(42,000)	Acalin B, <i>G. hirsutum</i> Acala <sup>1</sup>	8.07
A B	(61,900)	Legumin, <i>V. sativa</i> <sup>2</sup>	9.78
A C	(56,300)	Legumin, <i>V. sativa</i> <sup>2</sup>	7.59
α β	(58,600)	Legumin, <i>V. faba</i> <sup>3</sup>	9.33
P <sub>25</sub> P <sub>14</sub>	(67,000)	Arachin, <i>A. hypogaea</i> <sup>4</sup>	11.03
Glycinin	(59,600)	<i>G. max</i> <sup>5</sup>	8.90
P <sub>19</sub> P <sub>30</sub>	(49,000)	<i>C. nucifera</i> <sup>6</sup>	9.51

Raw data from: <sup>1</sup>Wallace (1976); <sup>2</sup>Weintraub and Tuen (1971); <sup>3</sup>Wright and Boulter (1974); <sup>4</sup>Yu (1977); <sup>5</sup>Catsimpoilas *et al.* (1971); and <sup>6</sup>Wallace and Dieckert (1976).

preliminary indication is that at least two structural genes code for these proteins and that they are different from the genes coding for the acalin A subunits.

The acalin A and acalin B polypeptides seem genetically related to the reserve proteins of other seeds. The reserve aleurins from phylogenetically diverse species of plants are compositionally and structurally similar. Dieckert and Dieckert (1976b, 1978) adduced evidence that the aleurins are variable but genetically related. Two homology classes were suggested. One, the "vicilin" class, is typified by the vicilins of *Vicia*, α-conarachin of peanuts and concocosin of coconut endosperm. A second class, the "legumins", includes the legumins of *Vicia*, arachin of peanuts, glycinin of soybeans, cocosin of coconut endosperm and edestin of hempseed. The vicilins (Table 5) are usually glycoprotein dimers of low

Table 5. Properties of some proteins of the vicilin type.

Protein	Molecular weight		Glycoprotein	% α-helix
	Parent	SDS subunits		
α-Conarachin: <i>A. hypogaea</i>	142,000 (7.85) <sup>1</sup>	72,000 <sup>2</sup>	YES <sup>3</sup>	12 <sup>3</sup>
Vicilin: <i>P. aureus</i>	N.D. (8.05) <sup>4</sup>	50,000 <sup>4</sup>	YES <sup>4</sup>	N.D.
Concocosin: <i>C. nucifera</i>	110,000 (7.65) <sup>5</sup>	56,000 <sup>5</sup>	YES <sup>6</sup>	30 <sup>5</sup>
Acalin A: <i>G. hirsutum</i>	113,000 <sup>7</sup> (9.15) (198,000)	53,500 <sup>7</sup> 49,000 46,000	YES <sup>6</sup>	1.3 <sup>7</sup>

<sup>1</sup>Dechary *et al.* (1961); <sup>2</sup>Yu (1977); <sup>3</sup>Jacks *et al.* (1973); <sup>4</sup>Ericson and Chrispeels (1973); <sup>5</sup>Khaund (1971); <sup>6</sup>Wallace and Dieckert (unpublished); and <sup>7</sup>Wallace (1976).

N.D. means not determined.

Table 6. Properties of some proteins of the legumin type.

Protein	Molecular weight		$\alpha$ -Helix	Pleated sheet	Unordered	N-terminal residue	(A-S-S-B) <sub>n</sub>
	Parent	SDS subunits					
Legumin: <i>V. faba</i>	320,000 <sup>1</sup>	21,600 av. (3) <sup>2</sup> 37,000 (2)	N.D.	N.D.	N.D.	Gly <sup>2</sup> Leu, Thr	(B <sub>22</sub> -S-S-a <sub>37</sub> ) <sub>6</sub> <sup>2</sup>
Glycinin: <i>G. max</i>	363,000 <sup>3</sup>	22,300 av. <sup>4</sup> 37,000 (3) <sup>5</sup> 45,000	9 <sup>6</sup>	33.3	57.7	Gly Phe, Leu (Ile) <sup>5</sup> Leu (Ile)	(b <sub>22</sub> -S-S-A <sub>1,37</sub> ) <sub>6</sub> <sup>7</sup>
Arachin: <i>A. hypogaea</i>	330,000 <sup>8</sup>	23,600 <sup>9</sup> 43,100	14.6 <sup>10</sup>	27.0	58.4	Gly <sup>11</sup> Ile	(P <sub>24</sub> -S-S-P <sub>43</sub> ) <sub>6</sub> <sup>11</sup>
Edestin: <i>C. sativa</i>	309,000 <sup>12</sup>	23,000 <sup>13</sup> 27,600	6.3 <sup>6</sup>	28.1	65.6	Gly <sup>13</sup> Blocked	(P <sub>23</sub> -S-S-P <sub>26</sub> ) <sub>6</sub> <sup>13</sup>
Cocoin: <i>C. nucifera</i>	208,000 <sup>14</sup>	19,000 <sup>15</sup> 30,000	N.D.	N.D.	N.D.	N.D.	(P <sub>19</sub> -S-S-P <sub>30</sub> ) <sub>4</sub> <sup>16</sup>

Data drawn from following sources: <sup>1</sup>Bailey and Boulter (1970); <sup>2</sup>Wright and Boulter (1974); <sup>3</sup>Wolf and Briggs (1959); <sup>4</sup>Catsimpoolas *et al.* (1971); <sup>5</sup>Kitamura and Shibasaki (1975a); <sup>6</sup>Jacks *et al.* (1973); <sup>7</sup>Dieckert *et al.* (unpublished); <sup>8</sup>Johnson and Shooter (1950); <sup>9</sup>Singh and Dieckert (1973); <sup>10</sup>Jacks *et al.* (1975); <sup>11</sup>Yu (1977); <sup>12</sup>Svedberg and Pedersen (1940); <sup>13</sup>Dlouhá *et al.* (1964); <sup>14</sup>Sjogren and Spsychalski (1930); <sup>15</sup>Wallace and Dieckert (1976); and, <sup>16</sup>Wallace (1976).

N.D. means not determined.

$\alpha$ -helical and high unordered content. The amino acid compositions are similar. Generally, the legumins (Table 6) are hexamers of disulfide-bridged pairs of subunits and usually are not glycoproteins. One member of the pair is an "acidic" and the other a "basic" subunit. As a group, the legumins are conformationally similar with low  $\alpha$ -helix, considerable pleated sheet and large unordered conformational components. Compositional similarities between the vicilin and legumin-type proteins suggest that they, too, derive from a common genetic ancestor.

The acalin A proteins probably belong to the vicilin class. They seem to be glycoproteins, their amino acid compositions are similar to other vicilin-type proteins (Table 7) and they appear to have similar three-dimensional structures.

Table 7. Metzger indices for aleurins similar to vicilin from *Phaseolus aureus*.

Subunit <sup>1</sup>	V <sub>60</sub> <sup>2</sup>	P <sub>72</sub> <sup>3</sup>	P <sub>49</sub> <sup>4</sup>
P <sub>54</sub> <sup>4</sup>	12.3	8.8	7.0
P <sub>49</sub>	11.0	9.7	
P <sub>72</sub>	12.9		

<sup>1</sup>Subscript of letter designation is MW x 10<sup>-3</sup>. Raw data from: <sup>2</sup>Ericson and Chrispeels (1973) (vicilin, *P. aureus*); <sup>3</sup>Yu (1977) ( $\alpha$ -conarachin, *A. hypogaea*); and <sup>4</sup>Wallace (1976) (two subunits of acalin A from *G. hirsutum*).

Table 8. Comparison of P<sub>42</sub> of acalin B with legumin-type proteins.

Protein	mol. wt.	Source	D.I.
P <sub>15</sub> P <sub>20</sub>	(35,000)	Acalin B, <i>G. hirsutum</i> Acala <sup>1</sup>	8.07
A B	(61,900)	Legumin, <i>V. sativa</i> <sup>2</sup>	9.39
A C	(56,300)	Legumin, <i>V. sativa</i> <sup>2</sup>	10.46
$\alpha$ B	(58,600)	Legumin, <i>V. faba</i> <sup>3</sup>	9.32
P <sub>23</sub> P <sub>44</sub>	(67,000)	Arachin, <i>A. hypogaea</i> <sup>4</sup>	7.34
Glycinin	(59,600)	<i>G. max</i> <sup>5</sup>	9.62
P <sub>19</sub> P <sub>30</sub>	(49,000)	<i>C. nucifera</i> <sup>6</sup>	11.20

Raw data from: <sup>1</sup>Wallace (1976), <sup>2</sup>Weintraub and Tuen (1971); <sup>3</sup>Wright and Boulter (1974), <sup>4</sup>Yu (1977); <sup>5</sup>Catsimpooulas *et al.* (1971); and <sup>6</sup>Wallace and Dieckert (1976).

The acalin B subunits P<sub>35</sub> and P<sub>42</sub> seem to belong to the legumin homology class. The non-reduced subunits are composed of two subunits linked by disulfide bridges, and the amino acid composition of each is similar to other legumin-type homologues (Tables 4 and 8). Less is known about the 3-dimensional structure of acalin B proteins than other legumins. However, the available data suggest that native acalin B is structurally similar to the other legumins. We find by ORD studies that acalin B has only about 3.6 percent  $\alpha$ -helix. Rossi-Fanelli (1968) observed a sedimentation coefficient of about 11s. This is the value expected for a well-behaved spherical protein of  $\sim$ 246,000 molecular weight. A mixed hex-

amer of equal molar proportions of  $P_{85}$  and  $P_{42}$  would have a molecular weight of 231,000. These indicators of 3-dimensional structure are similar to those observed for other legumin-type proteins. Acalin A and acalin B may be homologous. They have similar amino acid compositions with differences indices less than 15.

## A PROVISIONAL MODEL

From a consideration of the total data there emerges a useful and plausible model for the chemistry and biology of the reserve aleurins of the seed plants. According to the model the reserve proteins are synthesized and sequestered in a system of endoplasmic reticulum, dictyosomes and vacuoles. The aleurins function primarily as a store of organic nitrogen for the seedling. Perhaps structural genes for extracellular proteins were adapted to synthesize the reserve proteins. Apparently there were only a few potential structural genes for the aleurins. Aside from this limitation the requirements for an acceptable reserve protein are minimal. Some possible constraints are: (1) capable of mass production in a short period of time; (2) segregatable from the cytoplasm; (3) high particle weight to permit high tissue concentration without osmotic stress to the cells; and (4) compatible with the germination nitrogen metabolism of the species. Under the model there are many aleurin variants but only a few homology classes. The allowed variability for functionally viable reserve proteins suggests that species may differ with respect to which homology classes are represented. There may be species with vicilins only, legumins only, or with varying proportions of each. Examples of this type of variability may be discerned in Leguminosae.

## SUMMARY

Acalin A and acalin B are the principal globulins of the cottonseed. Native acalin A assumes molecular weights of 119,000 or 198,000 depending on the solvent. ORD shows acalin A to contain only about 1.3 percent  $\alpha$ -helix. Acalin A appears to be a glycoprotein with several polymorphic forms of subunits. The principal ones have reduced molecular weights of approximately 53,500, 49,000 and 46,000. Comparison of amino acid compositions and other parameters suggest that the subunits are homologous with each other and with the vicilin-type protein of other seed plants. Acalin B is less well characterized than acalin A. It appears to have a native molecular weight of 240,000 to 250,000, 3.6 percent  $\alpha$ -helix, no sugars, and consists of hexamers of two kinds of disulfide-bridged pairs of subunits. The molecular weights of the individual pairs are approximately 35,000 and 42,000. Comparison of various properties suggests that these proteins are homologous to the legumin-type protein of other seed plants. The acalin A and acalin B proteins do not seem to be in a precursor-product relationship to each other. A model for the biology and chemistry of the seed globulins is discussed.

## ACKNOWLEDGEMENTS

This work was supported by Cotton Incorporated Cooperative Agreement No. 75-682, Texas Agricultural Experiment Station Project H-1306 and Robert A. Welch Foundation Grant No. A-235.

## Chapter 28

# DIFFERENTIAL GENE ACTIVITY IN COTTON EMBRYOGENESIS

Glenn A. Galau  
University of Georgia  
Athens, Georgia

## INTRODUCTION

Attempts have been made to explain the process of cell differentiation as a consequence of the gene products which are synthesized in differentiating cells. The foundations of the Variable Gene Activity Theory of Cell Differentiation may be found in the writings of Stedman and Stedman (1950), Mirsky (1951, 1953) and Sonneborn (1950). Several beliefs are crucial to the theory. The most important is that a cell's current differentiated state is a consequence of the history of the gene products, the proteins, it has synthesized and that different states then imply different such histories. In addition, all cells contain the same complements of DNA. If there are a large number of differentiated states, then much of the gene complement in the DNA must not be expressed in any particular cell. Thus, the conclusion is that differential control of gene expression must ultimately control cell differentiation.

In the succeeding years the process of gene expression has been increasingly defined, yet in its broad outline the theory remains robust. There are now recognized to be many separate steps in the expression of a gene into the protein for which it codes. These include: (1) the transcription of a messenger RNA (mRNA) precursor from the gene sequence; (2) the processing of that primary mRNA transcript into a mature mRNA; (3) its export into the cytoplasm; and (4) the translation of the mRNA into a polypeptide. Many translation products are further assembled into functional complexes and some, as well, undergo co-translational or post-translational modifications such as cleavage or glycosylation. The direct result of gene expression is the current concentration of its protein products. A polypeptide's concentration is ultimately determined by the concentration of its cytoplasmic mRNA, the efficiency with which the mRNA is translated into the polypeptide (together these determine the synthesis rate of the polypeptide), and the intrinsic degradation rate of the polypeptide. The focus of much of molecular biology has been to understand how these processes are regulated and what are the consequences of this regulation for the cell.

As might be expected, differential gene-specific regulation of gene expression has been demonstrated to occur at every step, or level, in gene expression (Tobin,



1979; Davidson and Britten, 1979; Darnell, 1983). It is now clear that for any particular gene it is not possible to predict with any certainty at what level, if any, control in its expression may be exerted. Furthermore, control at more than one level may not be excluded *a priori*. Several general statements may be made, however. Although there are instances of changes in the translational efficiency of particular mRNAs (called translational level control), or changes in the processing or degradation rates of the polypeptide products (post-translational level control), the concentration of the polypeptide is usually intimately related to the concentration of its cytoplasmic mRNA template. The mRNA concentration in turn is determined by the rate of its entry into the cytoplasm (which is a consequence of the gene's transcription rate, the number of genes in the gene family being transcribed and the efficiency of processing and export of the transcripts) and its own intrinsic degradation rate. Here as well there are documented examples of gene-specific control being exerted at all of the levels which determine mRNA concentration, and in some cases at more than one level for a particular gene. Historically, the bias has been that the primary control of gene expression is most often probably at the transcriptional level, and, in fact, many studies with individual genes have tended to confirm this notion (Derman *et al.*, 1981; Darnell, 1983). However, there are several experimental results which suggest that changes in the processing efficiency of constitutively synthesized primary transcripts may be the basis of differential expression of many other genes (Wold *et al.*, 1978; Kamalay and Goldberg, 1984). So, unfortunately, it is still unclear to what extent transcriptional control is responsible for differential gene activity.

A rich mixture of stratagems, including in some cases limited rearrangement of particular DNA sequences, are used by organisms in order to 'remain in control' of their development. It is the task of those interested in differential gene expression then to render a comprehensive description of the important gene products, the cues responsible for their control, and how these cues are utilized. One hopes that these are ultimately responsible for, and not merely the reflection of, the events which drive development.

The growing cotton embryo has been used in several laboratories as a model system in which to study the control of gene activity as it relates to development. Earlier studies highlighted embryogenic events which were thought to be important for subsequent germination (Ihle and Dure, 1972; Dure, 1975; Choinski *et al.*, 1981). A substantial body of work has described the cotton genome and its organization and evolution (Walbot and Dure, 1976; Wilson *et al.*, 1976; Geever, 1980), the embryo mRNA content and its polyadenylation (Harris and Dure, 1978; Galau *et al.*, 1981) and the number of different genes being expressed as mRNAs during germination (Galau *et al.*, 1981). This background and the continually improving techniques of molecular cloning and protein and nucleic acid analysis have allowed a fairly detailed description of global gene activity in embryogenesis. The regulation and significance of some of these events are now being pursued. This review summarizes the rationale used in these investigations, the results obtained so far and the directions likely to be used in subsequent work.

## ANALYSIS OF GLOBAL GENE ACTIVITY IN EMBRYOGENESIS

The initial approach was to plead ignorance about what happens in embryogenesis and, thus, to simply look with the widest possible field of vision and the highest resolution available. The preliminary results of this descriptive phase have been collated (Dure *et al.*, 1981; Galau and Dure, 1981), but it is essentially an ongoing project, mapping the temporal aspects of different gene activities in finer detail and better accuracy as the tools are developed. Cotyledons from several stages of normal embryo development of *G. hirsutum* L. cv. Coker 201 have received the most attention. These include embryos of about 50 mg wet weight (about 27 days postanthesis [DPA]), embryos of about 100 mg weight (about 40 DPA), mature embryos (about 55 DPA) and embryos germinated 24 hours. These stages of embryogenesis correspond to cell division and maturation respectively. In addition, an experimental developmental system has been examined. It relies on the ability of excised young embryos to precociously germinate (Ihle and Dure, 1969; Choinski *et al.*, 1981). Incubation of such embryos in abscisic acid reversibly inhibits germination (Ihle and Dure, 1970) and is thought to perhaps mimic the environment of the embryo *in ovulo* during late embryogenesis (Davis and Addicott, 1972; Rodgers, 1980b; Choinski *et al.*, 1981).

A major analytical tool to study abundant polypeptides has been 2-dimensional polyacrylamide gel electrophoresis (O'Farrell, 1975). The protein sample is first electrophoresed in a cylindrical gel containing a pH gradient where polypeptides migrate to and stop at their isoelectric point. The gel cylinder is then mounted on a slab gel and the polypeptides electrophoresed out of the cylinder and fractionated in the slab primarily on the basis of their molecular weight in sodium dodecyl sulfate (Laemmli, 1970). Both dimensions maintain the polypeptides in their denatured state, and together are capable of resolving up to 1,000 polypeptides as individual spots, depending on the concentration distribution of the polypeptides in the sample and the methods used for their detection. Only several hundred polypeptides are usually detected in cotton embryo protein samples with this system under conditions where the highest resolution is achieved (Figure 4, an example).

This technique has been applied to the analysis of the: (1) extant polypeptides, detected by Coomassie or silver stain (Oakley *et al.*, 1980); (2) polypeptides which become radioactive when excised embryos are incubated 3-6 hours in radioactive amino acids, detected by fluorography (Lasky and Mills, 1975); and (3) polypeptides which are synthesized *in vitro* from radioactive amino acids in the wheat germ translation system programmed with embryo RNA, again with detection by fluorography. The identity and concentration of the resolved extant polypeptides is a measure of the past and current gene activity, as outlined above. On the other hand, the radioactivity in each polypeptide synthesized *in vivo* approximates a measure of the synthesis rate for each, since newly synthesized

radioactive polypeptides should not turn over significantly in the short incubation time in the radioisotope. In short, it is a measure of which mRNAs are being translated by the embryos, and, if the translational efficiencies of all the mRNAs are similar *in vivo*, the concentration of these active mRNAs as well. The relative radio-specific activities of different polypeptides are a function of their relative synthesis and degradation rate constants. In the third type of analysis the identity of translatable mRNAs and their concentration are assayed directly by their translation *in vitro* and subsequent electrophoresis of their radioactive polypeptide products. In practice, shorter mRNAs appear to be preferentially translated, due to protease and nuclease activities in the preparations, and premature termination of translation may lead to artifactual spots (Dure and Galau, 1981). Direct comparisons of *in vitro*-synthesized polypeptides with those extant or synthesized *in vivo* may also be confounded if the translation products are normally processed *in vivo* to such an extent that the electrophoretic behavior is changed (as in the case of the storage proteins described below). These shortcomings are usually minor enough to allow the identification of many of the *in vitro*-synthesized polypeptides with those synthesized *in vivo*. Comparisons of the two samples can then give an estimate of the relative translational efficiencies of the mRNAs *in vivo*. This comparison asks to what extent are the available mRNAs actually being used by the embryo.

From these sorts of experiments we have no evidence for widespread gene-specific translational level control of gene expression in cotton embryogenesis. To a first approximation, if the embryo mRNA is detectable by its translation *in vitro*, the embryos are found to be translating the mRNA *in vivo*. This generalization should be tempered due to the aforementioned experimental uncertainties of the *in vitro* translation system and our limited abilities to identify unambiguously the same polypeptides in different gels containing different protein samples. However, it appears that the embryo relies on modulation of its mRNA concentration rather than differential translation of its mRNAs, at least for its abundant transcripts. How it does so, by transcriptional or post-transcriptional controls, remains unknown by these methods of analysis.

It was earlier inferred from biosynthesis inhibitor studies that the synthesis of several particular mRNAs occurred in late embryos but were not utilized until early germination (Ihle and Dure, 1972; Dure, 1975). Some of these observations have not been subsequently confirmed using similar techniques and have been criticized on procedural grounds (Smith *et al.*, 1974; Radin and Trelease, 1976; Choinski *et al.*, 1981). (See Chapter 29 for additional discussion.) The enzymes encoded by these mRNAs are probably not abundant enough to be detectable on two dimensional gels, and their mRNAs have not been directly assayed at any stage, so these conclusions remain in doubt. The present results do suggest, however, that, at least for abundant mRNAs, synthesis of nontranslated mRNAs in embryogenesis is probably not of general occurrence.

From the analysis of these protein populations, seven major subsets of the

embryo mRNA complement can be operationally defined by their different temporal expression. The time course of major expression is shown diagrammatically in Figure 1. Subset 1 has at least 36 members and is by and large constitutive

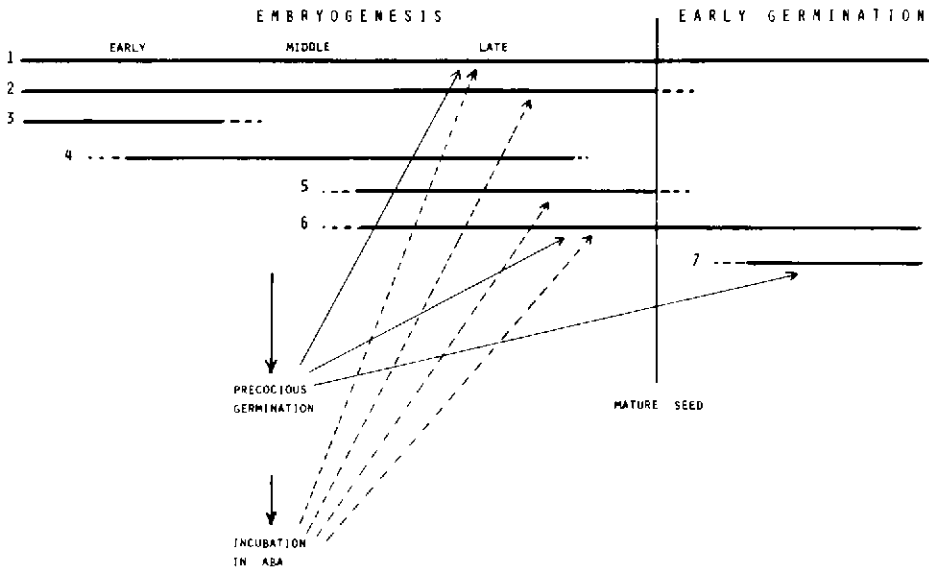

Figure 1. Representation of the time span in which the major subsets of developmentally regulated cotton mRNAs are abundant, as judged from *in vivo* and *in vitro* protein synthesis. (From Dure *et al.*, 1983b).

throughout the time period studied. At least 6 mRNA species comprise Subset 2, which is constitutive to embryogenesis only. They are found in the mRNA (by *in vitro* translation) in mature embryos, but in greatly reduced amounts at 12 hours of germination, and they fail to be detectably translated *in vivo* during the first 6 hours of germination. Thus, these mRNAs must be rapidly degraded in the first hours of germination. Subset 3 is unique to small embryos, the member mRNAs are no longer detected in embryos of about 40 mg wet weight. The major storage proteins and at least four soluble polypeptides make up Subset 4. Their mRNAs are abundant during most of embryogenesis, but not so during desiccation and germination. The mRNAs of Subset 5 and 6 both increase to detectable levels in embryos of about 100 mg wet weight. More than 14 polypeptides comprise Subset 5. Like those of Subset 2, their mRNAs are detectable in the mature seed but are degraded rapidly in the first hours of germination. Subset 6 mRNAs contain at least 5 species and are additionally present throughout early germination. Finally, there are several germination-specific mRNAs in Subset 7 which are quite abundant by 24 hours of germination.

Looking at the polypeptides and mRNAs in excised young embryos by the same techniques has been very illuminating as regards the possible cues which are responsible for the modulation in mRNA concentrations seen in normal embryogenesis. Whether precocious germination proceeds or is arrested by abscisic acid, excision appears to specifically reduce the mRNA concentrations of Subset 4 members and to induce Subset 6 member mRNAs. In addition, under conditions leading to precocious germination, Subset 2 mRNAs disappear and Subset 7 mRNAs accumulate. By this analysis of gene activity, such excised embryos completely bypass late embryogenesis and maturation. They never synthesize Subset 5 mRNAs in their development. Alternative incubation of excised embryos in abscisic acid produces quite another result. Only the mRNAs of Subset 5 are specifically modulated, increasing to very high levels. The observed induction of Subset 6 mRNAs and the decline in Subset 4 mRNAs occur just as they do in precociously germinating embryos. Subset 2 is maintained in abscisic acid, just as in normal late embryogenesis. Under these conditions the embryo appears to bypass much of its normal intermediate growth and proceeds directly to a late maturation stage and reversible dormancy. These observations of the excised embryo system have suggested that Subset 4 is maternally maintained, Subset 6 is maternally repressed and Subsets 2 and 7 are germination repressed and germination induced, respectively. The expression of Subset 5 mRNAs appears to be abscisic acid induced. These tentative designations, of course, are derived primarily from an experimental system and may not necessarily relate to the control of expression in normal embryogenesis. The experimental system does, however, allow manipulation of the expression of several mRNA subsets and should prove useful in further evaluating the control of normal expression.

Although providing a detailed picture of fundamental changes in gene expression, the foregoing experiments only looked at abundant polypeptides and their mRNAs. Furthermore, they were limited to those abundant polypeptides with isoelectric points between pH 4.2 and 8.2 and which, in addition, could be identified reliably in the series of gels containing different protein samples. A further study (Galau and Dure, 1981) was thus conducted using a technique which followed the changes in concentration of these and most of the other 25,000-30,000 different gene transcripts which are present during this time period. This involved the molecular hybridization of polyadenylated mRNAs, isolated from each of the principle stages of normal development, with complementary DNA (cDNA) synthesized from these mRNAs *in vitro*. The extent and rate of hybridization of the cDNAs with their parental mRNA populations can be used to calculate the number of different mRNA sequences and their abundance in the populations (Bishop *et al.*, 1974). By additionally hybridizing each cDNA population with the other stage RNAs (Ryffel and McCarthy, 1975; Levy and McCarthy, 1975) the abundance of many groups of mRNAs could be followed throughout development. While this study used for technical reasons only the polyadenylated mRNAs, an earlier study (Galau *et al.*, 1981) demonstrated that

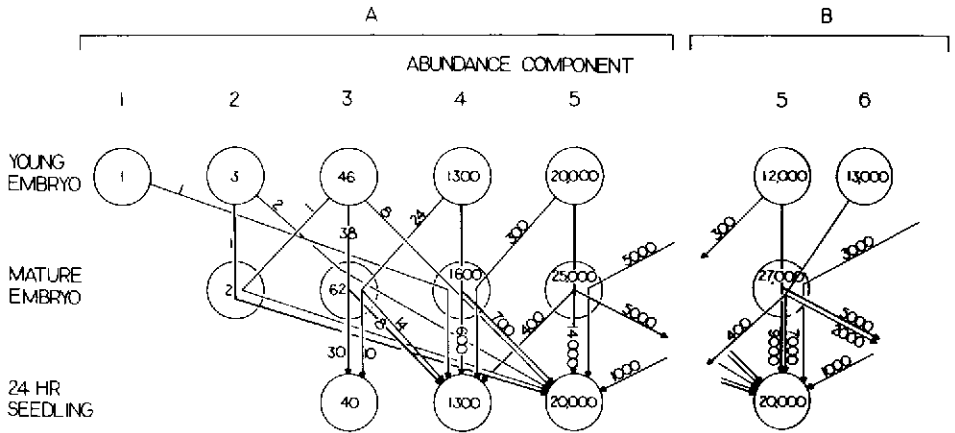

Figure 2. Changes in the concentration of major mRNA subsets with development as judged by cDNA-mRNA hybridization. The mRNA abundance classes are indicated by the circles. The number within each circle is the total number of different mRNA sequences calculated to be in each class. The change in concentration of individual groups of mRNAs are indicated by the arrows, with the associated numbers of different mRNA sequences in each group. The abundance component and (in parenthesis) the approximate percent of the total mRNA mass each sequence comprises is 1(30%), 2(4%), 3(0.4%), 4(0.02%), 5(0.002%) and 6(0.0004%). (From Galau and Dure, 1981).

polyadenylated mRNAs would be representative of all mRNA sequences, since all the sequences present in the total mRNA population are shared in the polyadenylated subset at about the same relative concentration.

A summary of the results of these studies is shown in Figure 2. At each of the three developmental stages studied in detail the frequency distribution of the individual mRNA sequences in the population is shown diagrammatically. Circles represent the different mRNAs which together comprise an abundance group, each of the different mRNA sequences in a group having about the same concentration. The numbers inside each circle indicate the number of different mRNA species in each. For example, the most abundant mRNA is detected in young embryos where it makes up 30 percent of the total mRNA, whereas the thousands of individual mRNA species in abundance component 5 each make up about 0.002 percent of the total mRNA mass. The arrows trace the detected change in concentration of particular groups of mRNAs during development and again their associated numbers indicate the number of different mRNAs in each group. For instance, the most abundant mRNA in component 1 in young embryos, the storage protein mRNA (see below), changes in concentration about 1000-fold during desiccation to form the mature embryo but changes very little

in concentration during early germination. The data were not sufficient to distinguish very well the number and concentration changes of the mRNAs in component 5. An alternative model, consistent with the data, is presented for component 5 in Panel B of the Figure.

This approach provided a very detailed picture of large scale changes in many thousands of different gene transcripts during the latter half of embryogenesis and in early germination. At least 17 groups of mRNAs were detected, based on their absolute abundance and the change in their abundance with time. If groups which share the same pattern of change (regardless of absolute abundance) are lumped together, then still at least 11 such subsets are detected. Two intermediate developmental stages (110 mg embryos and 12 hour seedlings) were also examined in less detail, but showed that the modulation is even more complex than indicated in Figure 2. Sequences in abundance components 1, 2 and 3 should have been detected in the two dimensional gel electrophoresis of the proteins in the first study (Dure *et al.*, 1981), and, in fact, the same subsets and the numbers of mRNAs in each were detected here as was predicted from that study. In addition to confirming by another technique the results of the protein analysis, the hybridization studies showed that gene specific changes in concentration occur in the less abundant mRNAs as well. Thus, it appears that there are several independent events, including developmental cues, which modulate the level of particular mRNAs. The hybridization studies did not address the question of whether or not these transcripts were actually being used in embryogenesis, though it is known that at least some of these sequences are on polysomes at 24 hr of germination (Galau *et al.*, 1981).

The events in cotton are similar to those seen in soybean embryogenesis (Goldberg *et al.*, 1981a). In fact, the number of cotton genes expressed and their modulation in concentration is not unusual when compared with gene expression in other plants (tabulated in Galau and Dure, 1981) and animals (reviewed by Lewin, 1980).

Faced with such an enormous complexity of developmental changes in gene expression, we have concentrated on a further analysis of the regulation of the mRNAs in several of the abundant subsets which were detected by protein electrophoresis and cDNA-mRNA hybridization. Hopefully, defining their regulation will be of importance in understanding gene expression in general and the larger events which occur in embryogenesis. It is expected that if the different members of each subset are in fact coordinately regulated, then these genes will share control sequences for their common regulation, be it for transcriptional or post-transcriptional regulation. These should be common to all members of the co-regulated set and found only in these members (Davidson and Britten, 1979; Davidson *et al.*, 1983). The current aims are then to isolate recombinant DNA probes for these mRNAs and to use them to define more accurately those genes which are indeed coordinately regulated. These probes will be used to isolate the genes, with subsequent sequencing to deduce putative control regions according

to this logic. Complementary work is geared towards understanding what signals regulate their expression and defining the function of these genes.

### STORAGE PROTEIN mRNAs

The major high molecular weight storage protein polypeptides comprise about 30 percent of the mature embryo protein and also account for about 30 percent of the protein synthesis during much of the growth phase of embryogenesis. They were, thus, a tempting target for further study. The physical characteristics and biosynthesis of these storage protein polypeptides have been described (Dure and Chlan, 1981; Dure and Galau, 1981). Two major molecular weight (denatured) forms of 48 and 52 kd, each comprised of between 5 and 7 isoelectric variants, are observed in the mature embryo. There are in addition a large number of smaller, protein body-associated polypeptides (Chapter 27). The polypeptide composition of several of the native storage protein complexes have been examined (Cherry and Leffer, 1984). A similar set of 39, 67 and 70 kd polypeptides are observed during embryogenesis (Dure and Galau, 1981) but not in the mature embryo. Several techniques were used to work out the biosynthesis of these proteins, including exposure of excised embryos to radioactive amino acids and *in vitro* translation of the embryo mRNAs, both of which were followed by one and 2-dimensional gel electrophoresis. As tools to identify related polypeptides, polyclonal antibodies were made against each of the two major mature molecular weight forms, and a stain for carbohydrate was used to identify glycosylated proteins *in situ* after gel electrophoresis. The combination of techniques led to a suggested processing scheme presented in Dure and Galau (1981). The mature 52 kd protein is initially synthesized as a preproprotein, most likely the 60 kd form. It is presumed to co-translationally lose a signal peptide used to target the product for the endoplasmic reticulum (reviewed by Silhavy *et al.*, 1980), and at some time it is glycosylated to yield a 70 kd intermediate proprotein. This is then slowly cleaved to yield the glycosylated 52 kd mature protein plus smaller polypeptides. The rate of cleavage is very slow, such that the 70 kd proprotein is easily detectable in embryogenesis as a stainable protein. The 48 kd mature protein is likewise synthesized as a preproprotein, most likely the 69 kd form. It loses a signal peptide to yield a 67 kd proprotein and is then rapidly cleaved to form the 48 kd mature species plus smaller polypeptides. Although not worked out in *Gossypium*, the sites of processing are presumed to be the endoplasmic reticulum and protein bodies, as have been described for other storage proteins (Chrispeels *et al.*, 1982; Bollini *et al.*, 1983). All protein species of 48, 52, 60, 67, 69 and 70 kd are seen nearly equally well by antibodies made against either of the two mature 48 and 50 kd forms. In addition, the amino acid composition of the two mature forms are very similar, if not identical. Thus, they appear to be very clearly related at the amino acid sequence level.

The total number of genes coding for each of these sets of proteins is still not



directly known. One difficulty has been the inability to resolve in the first isofocusing dimension the *in vitro*-synthesized 60 and 69 kd preproteins in order to detect the number of their isoelectric variants. Judging from the number of variants seen in the proprotein intermediates, however, a minimum of about 3 and 6 genes are believed to code for the 48 and 52 kd, species respectively. The unsupported assumption here is that each isoelectric variant is encoded by a single gene. This need not be the case at all, depending on the conservation of amino acid sequence, minor post-translational modifications, and the extent of artifactual protein modification in the separation techniques. In this as well as many other respects, the cotton storage proteins exhibit many of the features seen in other seed storage proteins (Brown *et al.*, 1982; Chlan and Dure, 1983).

A variety of observations suggested that the mRNAs for the storage proteins are highly regulated and that the expression of both of the molecular weight sets are highly coordinated. Thus, isolation of these genes would provide a collection of several functionally similar genes sharing the same control sequences, especially if they are a large multigene family dispersed throughout the genome such that each gene is transcribed independently of the others. Towards this end recombinant DNA clones containing young embryo cDNAs were made and screened for those which contained storage protein mRNA sequences (Galau *et al.*, 1983). As predicted, about 35 percent of the cDNA clones were complementary with very abundant young embryo-specific mRNAs. These turned out to code for the storage proteins. Confirmation of their identity entailed hybridization of the cloned cDNAs to the appropriately sized abundant mRNAs (60 kd and 69 kd preproteins are synthesized from 1.9 and 2.2 kb mRNAs, respectively) and the ability of these cloned DNAs to hybridize with mRNAs, which subsequently are translatable *in vitro* into the 60 kd and 69 kd preproteins. Surprisingly, three different mRNA sequences were discovered to code for storage proteins, not just two as had been surmised (Figure 3). The 69 kd preproprotein is encoded in a single sequence as presumed. The genes containing this sequence are probably divergent in about 15 percent of their nucleotide sequence in their mRNA transcripts. What was unexpected was that not one but two sequences encode the 60 kd preproprotein. They show very little homology with each other, but the genes within each sequence group seem to have diverged very little. Although at the protein level the 60 and 69 kd preproteins are clearly related by antibody tests, no homologies at the nucleotide level are evident from DNA-mRNA hybridization studies.

Representative full length cDNA sequences for each of the three subfamilies have now been sequenced (Dure and Chlan, 1985) in order to deduce their amino acid sequences and their relatedness at the nucleotide level. Putative glycosylation and cleavage sites have been identified by homology with known functional sites in other proteins. If these are functional in *Gossypium*, then these data strongly suggest that both 52 kd and 48 kd mature proteins are products of the 69 kd preproprotein family. They differ principally by the presence or absence of the

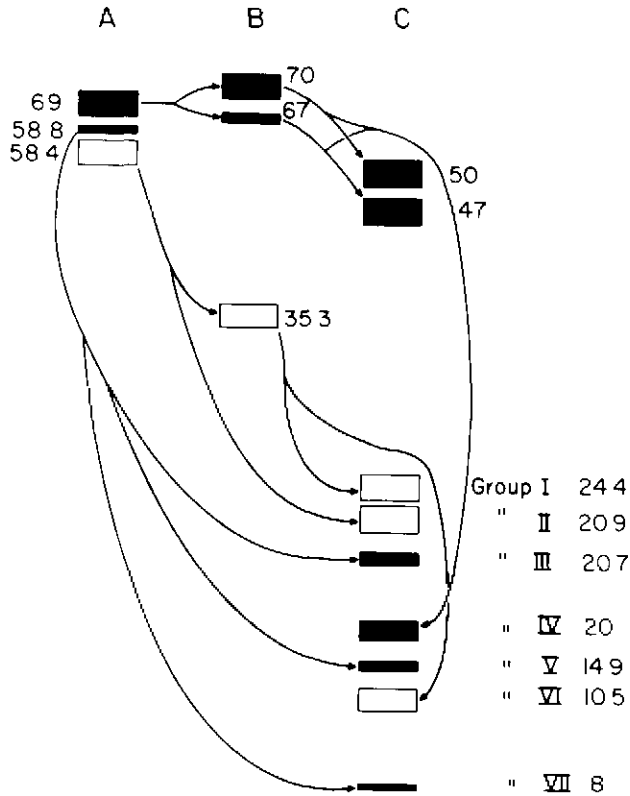

Figure 3. Biosynthesis of the major cotton storage proteins (after Dure and Chlan, 1985). The postulated pathway is based on sequences of representative cDNA clones, assuming the observed glycosylation and cleavage sites are functional. The numbers next to each protein species are their sizes, in kd, deduced from their nucleotide sequences. (A, preproteins; B, proproteins; C, mature proteins).

glycosylation site. All three classes of preproprotein have several potential cleavage sites, suggesting that all of the many insoluble species, which together comprise 60 percent of the mature seed protein (Dure and Chlan, 1981), arise from these three families of transcripts.

The cDNAs are also being used to isolate the genes from *G. hirsutum* (Kamalay and Dure, unpublished) to discover any putative controlling sequences. In the meantime we have examined seed protein from the two A genome diploids and of five of the D genome diploids by 2-dimensional gel electrophoresis (Hughes and Galau, unpublished) using *G. hirsutum* seed proteins as internal molecular weight markers (Hughes and Galau, 1984). All species so far looked at have both

major molecular weight forms with sizes identical to those in *G. hirsutum*. Furthermore, the 48 kd protein set in all species appears to be very similar in the number of polypeptide species and in their isoelectric points. However, the A genome species synthesize only the alkaline members of the *G. hirsutum* 52 kd set while the D genome species synthesize only the acidic members. Thus, it would seem that the genus will provide genes of sufficient divergence so that sequences of regulatory importance (those expected to change very little) may be deduced by simple comparative analysis of the same gene in several selected species.

The expression of mRNAs for each of the three sets have been examined in detail (Dure *et al.*, 1983a; Galau, unpublished) by quantitative hybridization with the cloned cDNA sequences. At the stage of maximum expression, the mRNAs for the 69 kd preproteins and one of the two 60 kd preproprotein sets are each about 15 percent of the total mRNA, while the mRNAs for the second 60 kd preproprotein set are only about 5 percent of the total mRNA. This difference in expression of the two 60 kd preproprotein sets may reflect different gene numbers or differences in the efficiency of gene expression. All three sets of genes appear to be coordinately regulated since the concentration of all three mRNA sequences change in parallel during normal development, from about 5 percent of maximum at 5 mg wet weight, with an abrupt decline to about 0.2 percent of maximum during desiccation and a small further decline during the first day of germination. They remain at about that level throughout several days of germination, and it would seem likely, though not proven yet, that these sequences must be resynthesized during germination. It is not yet known if these mRNAs are functional during germination; they are, however, the appropriate size for mature transcripts. A similar situation occurs with soybean storage protein mRNAs (and other very abundant embryo mRNA sequences) throughout a period of several weeks after germination (Goldberg *et al.*, 1981b). Since there should be no functional requirement for storage protein synthesis in embryogenesis, it seems strange that expression may not be completely repressed. One could argue that in a tissue destined for senescence, there would be no need for such a fine control. Alternatively, continued expression at  $10^{-3}$  of the maximum level might be a necessary consequence of the control mechanisms necessary for very high, yet modulatable, expression at other times. Knowing the level of transcripts in adult tissues would be illuminating in this respect. In soybean, similar sequences are not detectable in leaves (Goldberg *et al.*, 1981b). Thus, it may be that once turned on in the cells of the embryo it is impossible to completely turn such genes off.

### LATE EMBRYO-ABUNDANT (SUBSET 5) mRNAs

Recombinant DNAs containing cDNAs complementary to other subset mRNAs have been isolated as well (Galau and Dure, unpublished) and are now being studied. A major focus in our laboratory is the regulation of Subset 5

mRNAs which are normally very high in concentration only in late embryogenesis. Apparently these are the only abundant mRNAs which are specifically modulated by abscisic acid in the excised young embryo system. It is hoped that analysis of these polypeptides and of their expression will speak to the proposition that the growth regulator plays a role in late embryogenesis in preventing vivipary (for reviews see Walton, 1980, 1981; Black, 1980, 1981; Khan, 1980, 1981; King, 1982).

The proteins themselves are highly soluble, not post-translationally processed *in vivo*, and fairly abundant in the mature embryo. Fifteen different cloned mRNA sequences have been identified so far as being late embryo-specific. The polypeptides they encode have been identified for 10 of these sequences (Figure 4). Eight of the cloned sequences hybridize with mRNAs that code for 2 to 6

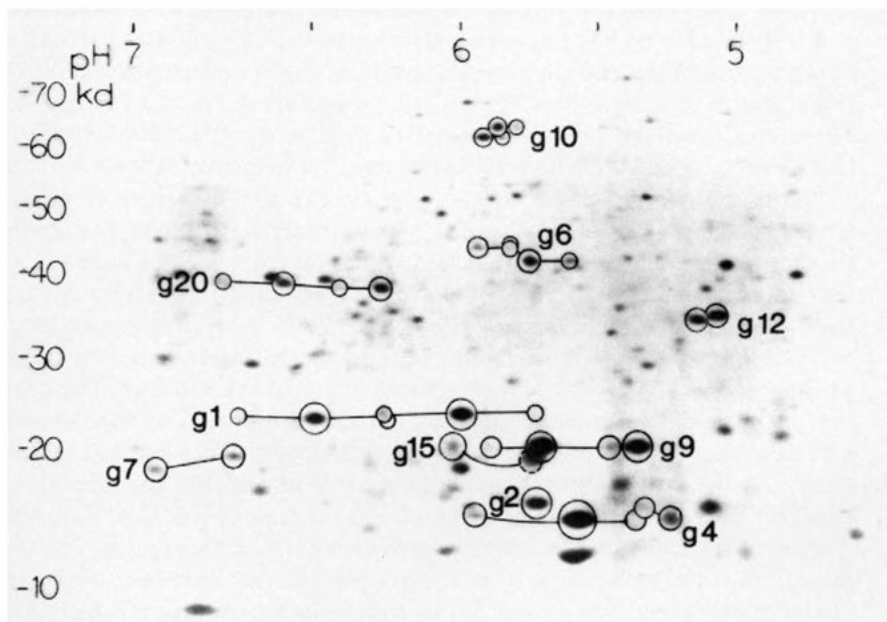

Figure 4. Late embryo-abundant (Subset 5) proteins encoded by individual cloned cDNA sequence groups. Shown are the *in vitro* translation products of mature embryo mRNA separated by two dimensional gel electrophoresis. The linked circles enclose all the polypeptides whose mRNAs hybridize with a single cDNA clone (Galau and Dure, unpublished).

different polypeptides detected on two-dimensional gels of *in vitro*-synthesized protein. Thus, each of these sequences are probably transcribed from a small multigene family. Most of them had previously been identified as Subset 5 products in the earlier global study (Dure *et al.*, 1981). Some escaped identification but can now be seen to be late embryo-specific and inducible in the excised

embryo system. Some of these mRNA sequences show distant homologies with each other, even though they encode significantly different sized polypeptides (groups 2 and 4; groups 6, 7 and 10 in Figure 4), suggesting that there is a functional relationship in the coding or noncoding regions of these mRNAs. Preliminary analysis of the seed protein in the diploid species, mentioned above, indicates that the multigene family in the allotetraploid is based in part on two smaller multigene families, one present in each of the A and D subgenomes. Using these cDNA probes, these genes are also being isolated from *G. hirsutum* (Kamalay and Dure, unpublished).

The expression of these Subset 5 genes have also been followed by *in vivo* and *in vitro* translation and by hybridization with the cloned cDNA probes (Galau, and Hughes, unpublished). For the most part the different genes within each family, for which the products are distinguishable in protein electrophoresis, are coordinately regulated in both normal and experimental embryogenesis. There are some apparent exceptions, and some translational level regulation may also occur in the expression of at least one of the gene families during abscisic acid induction. These issues will be explored further with gene-specific cDNA probes and immunoelectrophoresis to quantitate individual protein members of each family.

Like in the storage protein mRNA analysis, the current cloned cDNA probes for Subset 5 mRNAs react with all of the transcripts of a multigene family, so they measure the sum of the individual transcripts from the entire family. Fourteen of the sequence family mRNAs have now been measured in normal embryogenesis and early germination by such DNA-RNA hybridization. At least two and possibly three groups of coordinately regulated families can be discerned within this population. Although all show their highest expression during desiccation or in the mature embryo, some are modulated in early and middle embryogenesis as well, suggesting that they may be responsive to several temporally separated signals in embryogenesis. The number of different coordinately regulated sets of genes in this group of sequences is being further defined by looking at the kinetics of accumulation and decay of the mRNAs and their dose-response in the experimental induction system. In addition, possible expression will be tested in non-embryogenic tissues and in cell culture under conditions where abscisic acid is thought to be an important regulator, such as in cold stress (Rikin, 1979) and water stress (Wong and Sussex, 1980a, b). Hopefully, the inducing agent for at least some of these genes can be identified in more detail and the level determined at which the mRNA concentration is subsequently regulated.

## FURTHER DIRECTIONS IN THE STUDY OF DIFFERENTIAL GENE ACTIVITY

Investigation of gene activity in cotton embryogenesis has used principally the tools of nucleic acid and protein analysis and molecular cloning to study two groups of genes which vary widely in terms of function, time of expression in

normal embryogenesis and in their regulation in excised embryos. Clearly there is a lot to be learned about gene structure and regulation. Much will be learned by comparative sequence analysis of the isolated genes, including putative control elements and the amino acid sequence of the proteins. Hopefully, at least some members of Subset 5 will prove to be inducible in normal embryogenesis with abscisic acid and perhaps play some role in the prevention of vivipary.

There are several tools, mostly biological, which should be of great help in further analysis. The limited screening of other *Gossypium* species has already proved useful. They should continue to be important in understanding gene structure and evolution. In some we may find natural variation in their expression as well. A viviparous mutant would be very useful in which to test directly the supposed connection between abscisic acid, vivipary and late embryo-abundant proteins. Lacking such mutants, we will attempt their creation in plants and in cell culture (Wong and Sussex, 1980a,b). *In ovulo* embryo culture (Stewart and Hsu, 1977a) also is attractive as an experimental system, which should be closer to normal development, so that abscisic acid-induced changes can be more easily seen independent of excision induced events. Finally, antibodies to the Subset 5 proteins would be useful in several areas, especially in their localization and evaluation of their biochemical function.

As a final point, in the absence of a wide variety of mutants which vary in the expression of the particular gene of interest, the conclusions derived from descriptive and comparative analysis of wild type genes and their expression is limited. For this reason, *in vitro* and *in vivo* expression systems are being developed in a wide variety of organisms, in order to test directly the conclusions derived from such studies. They are also of use in the isolation of functionally defined DNA sequences without having to first isolate particular genes. This area of research is moving rapidly in some other dicot plants (Caplan *et al.*, 1983). It is difficult to predict which approaches will have the best success, but expression systems in cotton will probably require improvements in cotton tissue culture and regeneration, and perhaps the modification of current delivery and transformation systems. These are long term goals but clearly are of critical importance, if we are to enter the predictive phase of the study of cotton biology.

## Chapter 29

# SYNTHESIS AND COMPARTMENTATION OF ENZYMES DURING COTTONSEED MATURATION

Richard N. Trelease, Jan A. Miernyk, John S. Choinski, Jr.  
and Stephen J. Bortman  
Arizona State University  
Tempe, Arizona

## INTRODUCTION

An important event during postgerminative growth of oil seeds is gluconeogenesis from storage lipid (Figure 1). The process involves lipolysis of storage triglycerides within lipid bodies followed by activation and  $\beta$ -oxidation of fatty acids in the glyoxysomes. Acetyl-CoA, the product of  $\beta$ -oxidation, is shunted through the

GLUCONEOGENESIS FROM STORAGE LIPID DURING OILSEED GERMINATION

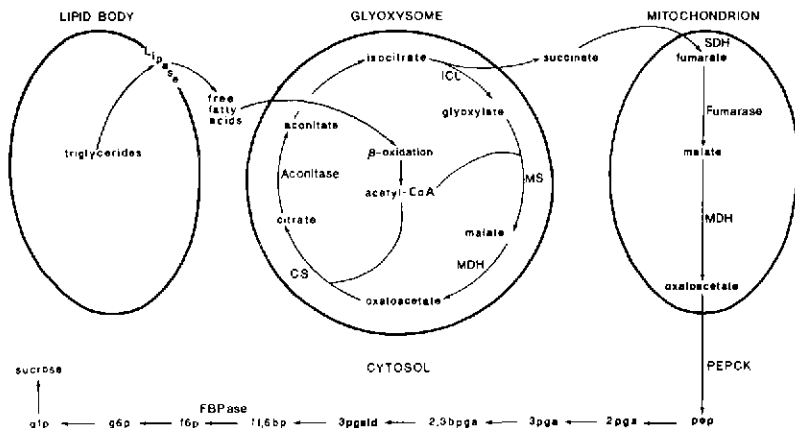

Figure 1. Diagrammatic representation of reserve lipid mobilization and gluconeogenesis following oilseed germination.

glyoxylate cycle producing succinate which presumably moves into the mitochondria and is converted to oxaloacetate (OAA). OAA is transported out of the

mitochondria and decarboxylated to phosphoenolpyruvate (PEP), which is converted to sucrose via several glycolytic enzyme reactions in the cytosol. This transport carbohydrate presumably moves from the cotyledons to the axis where it is used as a main carbon source for seedling growth.

Studies with several different oil seeds have shown that the two enzymes unique to the glyoxylate cycle, isocitrate lyase (ICL) and malate synthase (MS), develop *de novo* following germination (Beevers, 1979). Previous work with castor beans indicated that glyoxysomes housing these enzymes were synthesized together during postgerminative growth (see Beevers, 1979, for review). Interpretation of these studies led to the generalization that glyoxylate cycle enzymes are absent or have negligible activity in storage tissues of all ungerminated oil seeds (Beevers, 1979). Data presented in this paper, however, indicate that glyoxysomes containing all of the glyoxylate cycle enzymes (except ICL) are synthesized during cottonseed maturation and persist in dry cotyledons prior to germination. *De novo* synthesis of enzymes does occur during postgerminative growth but likely are added post-translationally to organelles synthesized during maturation and carried over into germinated seeds.

Ihle and Dure (1972) concluded from experiments with Actinomycin D (Act D) that the *de novo* synthesis of ICL and carboxypeptidase C during cottonseed germination was from pre-existing mRNAs stored in dry seeds. Since these enzymes were unique to germination, i.e., were not enzymes found in cotyledons during maturation, they postulated that ICL and carboxypeptidase C were representative of an entire body of similar "germination" enzymes whose synthesis was regulated in concert from mRNAs transcribed during maturation, but not translated until commencement of germination. In a proposed developmental scheme for cottonseed embryogenesis, Ihle and Dure (1972) suggested that transcription of this mRNA occurred shortly after natural atrophy of the vascular connection (funiculus) between the ovary wall and ovular tissue surrounding the developing embryos (at approximately 32 days postanthesis, DPA). Loss of vascular flow from the mother plant was presumed responsible for cessation of embryonic growth (cell division) and derepression of germination cistrons. Abscisic acid (ABA), apparently synthesized in the ovular tissues and absorbed by the embryos at about this time (DeLanghe and Vermeulen, 1972), was implicated in suppressing translation of the germination mRNAs, thus preventing vivipary of the embryos in maturing bolls. The overall scheme describes several developmental events which are thought to be part of the preprogramming of the seed for successful germination (Dure, 1975; Harris and Dure, 1978; Ihle and Dure, 1972).

Smith *et al.*, (1974) and Radin and Trelease (1976) independently reported that treatment of mature seeds and excised embryos with Act D *did* inhibit appearance of ICL activity. Both groups attributed the disparity between their results and those of Ihle and Dure to the method of treating embryos with Act D prior to germination. Furthermore, Schubert and associates (Chapter 22) and



Stewart (Chapter 20) have strong evidence that the funiculus does not break at 32 DPA, but remains intact, transporting carbon from the mother plant into the embryo sink until approximately 45-50 DPA. These results clearly are inconsistent with the developmental scheme proposed by Ihle and Dure (1972). There is ample evidence that a body of mRNA pre-exists in dry cotton seeds and that this mRNA needs to be further processed (e.g. by polyadenylation) for normal germination to commence (Dure, 1977; Hammett and Katterman, 1975; Harris and Dure, 1978). However, the conflicting results outlined above and data presented in this paper indicate that the specific role of this conserved mRNA should be reassessed. Moreover, it appears that the timing and control of developmental events related to preparation of the seed for germination must be reevaluated.

Over the past ten years our laboratory has been involved in studies aimed at understanding the relationship between activities of lipid-mobilizing and gluconeogenesis-related enzymes and their subcellular localization within cotyledons of various oil seeds. Results from this work have led us to conclude that there must be certain developmental events that occur during oilseed embryogenesis that would prepare the seed for the massive reserve mobilization that occurs during postgerminative growth. Dure's (1975) and Katterman's (Hammett and Katterman, 1975) laboratories have contributed considerable information on the molecular biology of nucleic acids involved in cottonseeds (see Chapter 28). Benedict's group (Chapter 22) has provided important information on carbon fixation and transport in developing bolls, and hopefully our laboratory can provide meaningful data on enzyme activity and organellar localization as they pertain to the physiology and biochemistry of developing cotton embryos.

## METHODS

### GROWTH AND SELECTION OF PLANTS

Cotton plants, *Gossypium hirsutum* L. cv. Deltapine 61 and 70, were grown under glasshouse conditions. Flowers were routinely tagged at anthesis to determine the age of developing bolls. Since the boll development period varied with the seasons, we selected embryos on the basis of age (DPA), a standard degree of ovule wall sclerification, and gross morphology and fresh weight of embryos (Choinski and Trelease, 1978).

Studies on mature seeds were done mostly with commercial Deltapine 61 and 70 seed. Similar results were obtained when seeds harvested from our glasshouse plants were acid delinted and germinated on plates. Germination and postgerminative growth of seedlings in Petri dishes was done according to the presoaked and decoated procedure previously described (Radin and Trelease, 1976).

### ORGANELLE ISOLATION AND ENZYME ASSAYS

Total enzyme activity in immature embryos and germinated seeds was determined from clarified homogenates of French-pressed samples (Choinski and

Trelease, 1978). Isolation of organelles was accomplished with a Beckman JCF-Z zonal rotor. The procedure is described by Choinski and Trelease (1978) for immature embryo organelle isolation, and essentially the same procedure for germinated seeds is outlined by Bortman *et al.* (1981). Enzyme activity was measured according to procedures in Bortman and Trelease (1981) and Miernyk and Trelease (1981a, b). Total nitrogen was measured as described by Choinski *et al.* (1981). Total lipid was gravimetrically determined after chloroform-methanol extraction and Folch washing; neutral lipid was that fraction collected after passing the total lipid extract through a silica gel G column in chloroform (Miernyk and Trelease, 1981a). Proteins in germinated-seed gradients were estimated by the Lowry *et al.* (1951) procedure; those in embryo gradient fractions and embryo cultures were determined by the Bradford method (1976). BSA was the standard for Lowry, and human gammaglobulin for Bradford procedures. Close agreement between the two methods was found, but the Bradford technique was more convenient.

### EMBRYO CULTURE

Complete details of the culture procedure are given in Choinski *et al.* (1981). Excised ovules (with fibers removed) were surface sterilized in 1.3 percent hypochlorite, and embryos were aseptically removed with a scalpel and soaked in sterile solution (water, ABA or ABA plus an inhibitor.) Following a 3-hour presoak, 15 embryos were placed in a 150 x 25 mm plastic Petri dish containing 75 ml of culture medium in 0.8 percent agar. Cultures were maintained in the dark at 30C. The cotton ovule medium of Beasley and Ting (1973) was used with the following exceptions: 0.058 M sucrose was substituted for glucose plus fructose, and 3 mM L-asparagine and 4 mg/ml  $\text{NH}_4$ -malate were added. ABA and Act D solutions were autoclaved separately before addition to the autoclaved medium. Cordycepin and cycloheximide solutions were filter-sterilized.

## ENZYME DEVELOPMENT AND ORGANELLE LOCALIZATION

### IN GERMINATED SEEDS

Mature seeds deocoated after a 4-hour imbibition period and germinated on moist Petri plates for several days (see Figure 1, Bortman *et al.*, 1981, for morphology) developed glyoxylate cycle and gluconeogenesis-related enzyme activities which peaked at about 38 to 48 hours after initial imbibition (Table 1). Isolation of organelles on sucrose-density gradients from cotyledons of 48-hour germinated seedlings revealed that a fatty acid  $\beta$ -oxidation marker enzyme (3-hydroxyacyl CoA dehydrogenase), catalase, glyoxylate cycle enzymes (ICL, MS and citrate synthase), and alanine and aspartate aminotransferases (not shown) all banded in the 1.26 g/cm<sup>3</sup> region of the gradient, separate from mitochondria

Table 1. Development of enzyme activity in cotyledons of *Gossypium hirsutum* (cv. Deltapine 61, 1977 harvest) germinated and grown in the dark on moist filter paper at 30C. Values are means from at least 4 separate experiments wherein 12 to 16 cotyledon pairs were homogenized per experiment. (From Bortman *et al.*, 1981).

Enzyme	Hours after initial soaking					
	0	10-12	22-26	36-40	45-50	70-75
	nmol min <sup>-1</sup> cotyledon pair <sup>-1</sup> X10 <sup>3</sup>					
Isocitrate lyase	0	0	12	41	42	38
Malate synthase	32	43	71	200	200	160
Catalase <sup>1</sup>	4	11	22	59	55	56
Malate DH	840	1,190	1,650	1,840	1,970	1,850
Citrate synthase	28	42	45	52	84	51
Aconitase	6	8	24	55	51	29
Enoyl hydratase	110	350	490	620	187	23
Hydroxyacyl-CoA DH	38	78	116	208	147	42
Oxoacyl thiolase	3	4	17	26	16	6
Aspartate AT	38	33	110	137	160	112
Alanine AT	32	28	41	42	36	21
Triosephosphate isomerase	1,840	1,900	1,950	1,950	2,160	1,880
Fructose-bisphosphatase	7	7	15	122	96	32
NADP-isocitrate DH	6	6	14	23	27	20

<sup>1</sup>Lück units

marker enzymes equilibrating at 1.19 g/cm<sup>3</sup> (Figure 2). The 1.26 g/cm<sup>3</sup> region of the gradient is where glyoxysomes characteristically equilibrate when isolated from other oil seeds (Beevers, 1979). Electron microscopic examination of these fractions showed that glyoxysomes were the predominant organelles (Bortman *et al.*, 1981).

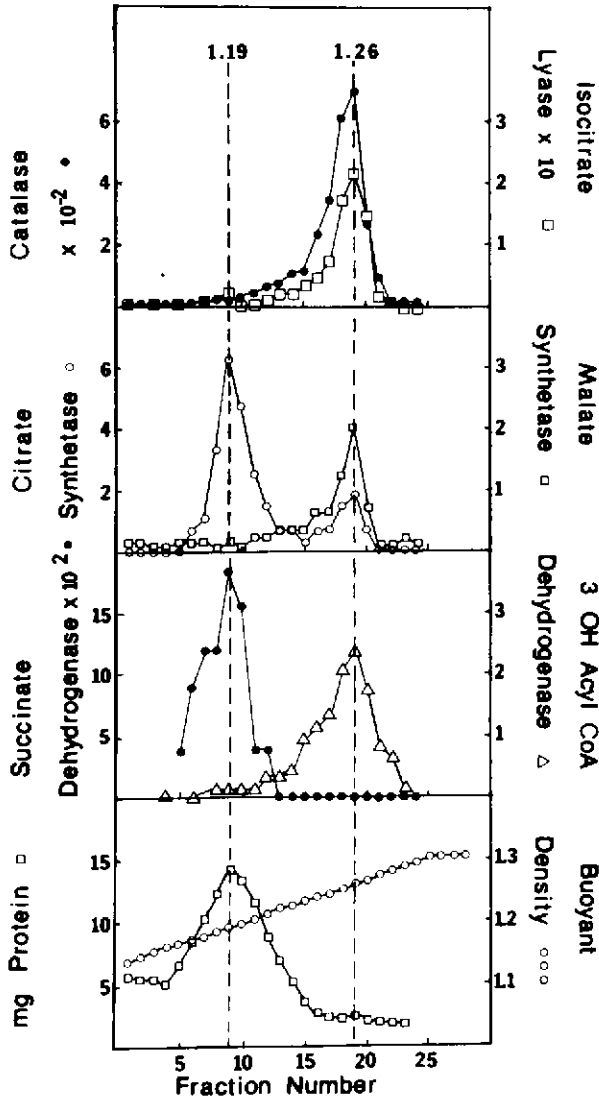

Figure 2. Distribution of protein and enzyme activities on a continuous sucrose density gradient after centrifuging a clarified homogenate of cotyledons removed from 48-hr-old seedlings. Enzyme activities are  $\mu\text{mol}/\text{min}/\text{fraction}$ , except for ICL which is  $\text{nmol}/\text{min}$ . Mitochondria ( $1.19 \text{ g}/\text{cm}^3$ ) are clearly separated from glyoxysomes ( $1.26 \text{ g}/\text{cm}^3$ ).

IN MATURING EMBRYOS

Selected enzyme activities were assayed in homogenates of embryos excised from bolls at various times after anthesis. Figures 3 and 4 and Table 2 show development of enzyme activities in maturing embryos compared to that in germinated mature seeds. Catalase, a constituent enzyme of glyoxysomes, and  $\beta$ -oxidation enzymes (known to be in glyoxysomes, Miernyk and Trelease, 1981a) increased in activity from 22 to 50 DPA. Activity of MS did not parallel these increases in activity; it was not detectable in embryos excised from 22 to 40 DPA

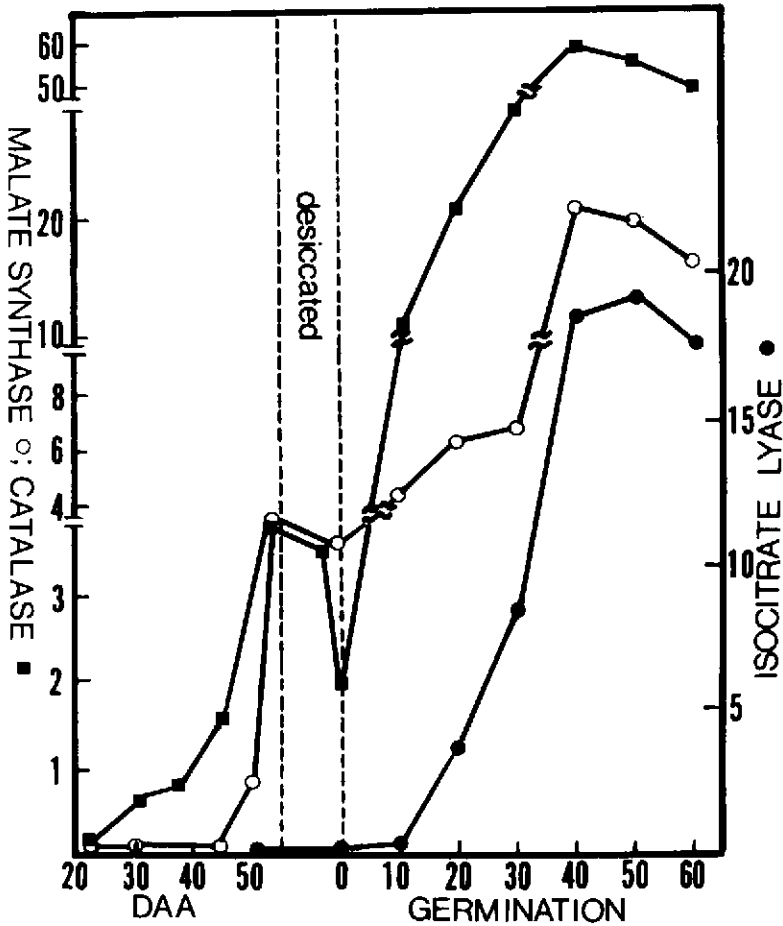

Figure 3. Development of selected glyoxysomal enzyme activities in embryos and germinated seeds. For actual activities (nmol/min/embryo), multiply ordinate values by 10 for catalase, by 100 for malate synthase and by 20 for isocitrate lyase.

but increased dramatically from approximately 42 DPA to 50 DPA, reaching a level nearly 20 percent of peak activity found in germinated mature seeds. Activity of ICL, a companion enzyme to MS in the glyoxylate cycle, was not detectable at any stage of maturation; it developed only after a 10-hour lag period following germination of mature seeds (Figure 3). The lack of ICL activity in immature

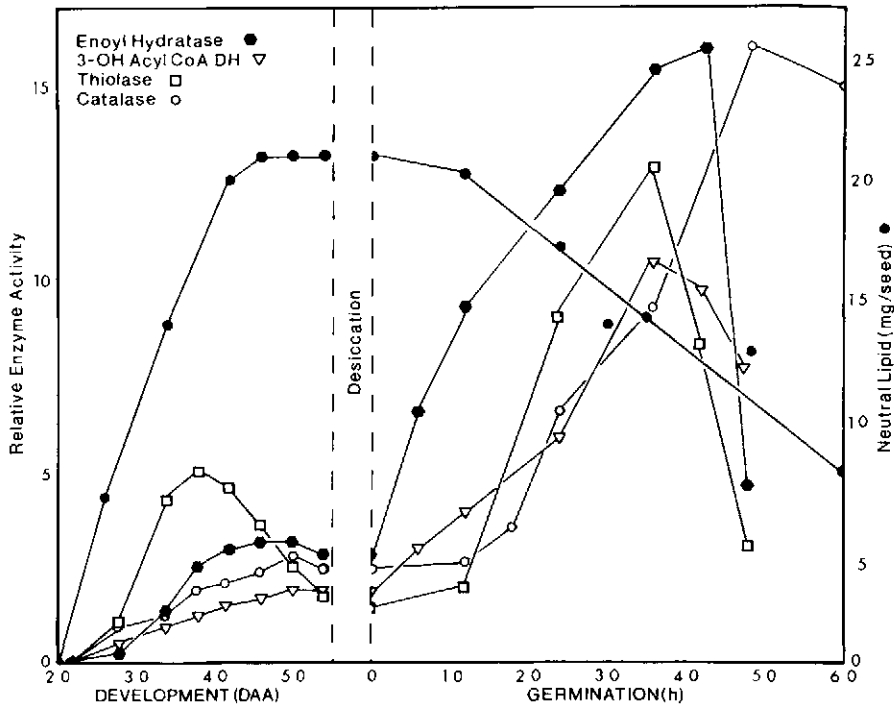

Figure 4. Development of catalase and  $\beta$ -oxidation enzyme activities in embryos and germinated seeds in relation to the synthesis and degradation of neutral lipid. For actual enzyme activity (nmol/min/embryo), multiply ordinate values by 200 for enoyl hydratase, by 100 for hydroxyacyl-CoA DH, by 20 for thiolase and by 18 for catalase. (From Miernyk and Trelease, 1981a).

embryos is consistent with Dure's findings (Dure, 1975), but the noncoordinated development of MS and the other enzyme activities during maturation has not been shown previously. All of these enzymes are required for successful postgerminative lipid mobilization but appear in immature embryos prior to desiccation. In addition, activity of these enzymes (except ICL) developed in the presence of ABA which has been shown to accumulate in maturing embryos (Radin and Hendrix, personal communication). These data are inconsistent with two aspects of Dure's developmental scheme: (a) ABA prevents vivipary through suppression of mRNA translation of enzymes required for "germination", and (b) the synthe-

Table 2. Developmental changes in enzyme activity during cotton embryo maturation. French-pressed, clarified homogenates were used directly for assays. Values are means  $\pm$  standard errors of eight separate experiments. (From Miernyk and Trelease, 1981b).

Enzyme	Days postanthesis					
	34	38	42	46	50	54
	nmol/min/embryo					
Malate synthase	0	0	43 $\pm$ 44	115 $\pm$ 38	208 $\pm$ 45	319 $\pm$ 24
Malate DH	8310 $\pm$ 2004	7770 $\pm$ 2005	8330 $\pm$ 2263	7960 $\pm$ 2736	8230 $\pm$ 2419	8390 $\pm$ 2628
Citrate synthase	83 $\pm$ 28	142 $\pm$ 30	150 $\pm$ 49	167 $\pm$ 47	205 $\pm$ 55	279 $\pm$ 42
Aconitase	40 $\pm$ 8	48 $\pm$ 8	75 $\pm$ 21	79 $\pm$ 16	79 $\pm$ 12	57 $\pm$ 7
NADP-isocitrate DH	55 $\pm$ 24	53 $\pm$ 10	74 $\pm$ 12	63 $\pm$ 19	66 $\pm$ 19	62 $\pm$ 17
Fumarase	103 $\pm$ 47	148 $\pm$ 11	134 $\pm$ 1	131 $\pm$ 42	141 $\pm$ 27	146 $\pm$ 64
Aspartate AT	327 $\pm$ 47	314 $\pm$ 40	348 $\pm$ 54	323 $\pm$ 48	338 $\pm$ 15	358 $\pm$ 34
Alanine AT	327 $\pm$ 68	341 $\pm$ 18	367 $\pm$ 32	333 $\pm$ 85	325 $\pm$ 28	322 $\pm$ 21

Table 3. Total malate synthase activity in crude homogenates of dry cotton seeds representing several species and cultivars. Enzyme preparation and assay as in Methods. Seed dry weight is derived from decoated seeds previously stored at room temperature. Values are the mean of four separate preparations. Units are nmol/min. (From Miernyk *et al.*, 1979).

Seed	Units/seed	Units/mg dry seed wt	Units/mg as a per cent of Deltapine 16
<i>Gossypium barbadense</i> L. cv. Pima (tetraploid)	747	8.53	129
<i>Gossypium hirsutum</i> L. cv. Deltapine 61 (tetraploid)	451	7.84	118
<i>Gossypium hirsutum</i> L. cv. Deltapine 16 (tetraploid)	380	6.63	100
<i>Gossypium herbaceum</i> L. var. Africanum (diploid)	91	5.33	80
<i>Gossypium hirsutum</i> L. cv. Stoneville 213 (tetraploid)	252	4.32	65
<i>Gossypium arboreum</i> L. (diploid)	125	3.70	56
<i>Gossypium thurberi</i> Tod. (diploid)	38	3.25	49
<i>Gossypium davidsonii</i> Kell. (diploid)	77	3.15	48
<i>Gossypium australe</i> F.v.M. (diploid)	12	2.30	35

sis of an entire body of "germination" enzymes is regulated in a coordinated fashion (Dure, 1975). These aspects will be discussed in more detail later.

The discovery of substantial MS activity in mature Deltapine cotton seeds appeared to be an anomaly among oil seeds since it had been generally assumed that glyoxysomal enzyme activity was absent or negligible in oil seeds (Beavers, 1979). This prompted us to examine other ungerminated oil seeds, including several species and cultivars of cotton, for MS activity (Miernyk *et al.*, 1979). The results from a survey of ungermination cotton seeds is shown in Table 3. All seeds had relatively high activity, ranging from 35 to 129 percent of the activity



(units/mg dry seed weight) found in *Gossypium hirsutum*, cv. Deltapine 16. None of the seed homogenates had detectable ICL activity. A survey of other ungerminated oil seeds, including mono- and dicotyledons representing 11 families, showed that appreciable MS activity was present in homogenates of all oil seeds examined (Miernyk *et al.*, 1979). Thus, it was concluded that the synthesis of MS during seed development is universal among oil seeds, apparently in the absence of glyoxylate-cycle associated ICL activity.

The appearance of  $\beta$ -oxidation enzyme activities in the maturing embryos deserves further discussion. Figure 4 is a more detailed view of the development of these enzyme activities in embryos and germinated seeds, plotted in relation to synthesis and utilization of neutral lipids. Activity of three  $\beta$ -oxidation enzymes increased with catalase activity beginning at about 22 DPA. Enoyl hydratase and 3-hydroxyacyl CoA dehydrogenase rose to a peak with catalase at 50 DPA and remained essentially the same during the desiccation period. Thiolase activity, however, increased initially with the other enzymes, but consistently showed a peak activity at approximately 38 DPA. The significance of this is not understood. Although more enzyme activity develops following germination of mature seeds (Figure 4), clearly demonstrable  $\beta$ -oxidation enzyme activity developed in the maturing embryos during the period of neutral lipid synthesis and deposition in lipid bodies. The near parallel synthesis of neutral lipids and the enzyme system used to degrade ( $\beta$ -oxidize) fatty acids from neutral lipids seemed inconsistent with the anabolic metabolism normally associated with maturing cotyledon cells. This apparent inconsistency was addressed earlier by Hutton & Stumpf (1969) who had shown the presence of  $\beta$ -oxidation activity in maturing castor beans. Considering the known toxicity of free fatty acids and their high rate of synthesis during this period, they proposed that the  $\beta$ -oxidation system served as a "scavenger" system for those fatty acids not incorporated into triglyceride moieties. We do not have any additional evidence for or against this hypothesis and, therefore, consider it to be a viable explanation for the concurrent existence of  $\beta$ -oxidation enzymes and neutral lipid synthesis.

Hutton & Stumpf (1969) also investigated subcellular localization of  $\beta$ -oxidation enzymes in developing castor beans. Their data showed enzyme activities in both the mitochondrial and glyoxysomal regions of sucrose density gradients. In the endosperm of germinated castor beans, however, the activities clearly were restricted to glyoxysomes (Cooper and Beevers, 1969). In scutellum from germinated corn seedlings (Longo and Longo, 1975) and megagametophyte of germinated pine (Beevers, 1979) activities were found in both the mitochondria and glyoxysomes. Isolation of particles and distribution of enzyme activities on sucrose gradients from cotton embryos harvested 38 DPA is shown in Figure 5. The  $\beta$ -oxidation enzymes and catalase were clearly segregated in the 1.25 g/cm<sup>3</sup> region of the gradient, separate from mitochondria equilibrating at 1.21 g/cm<sup>3</sup>. Activities of MDH and citrate synthase peaked in both regions of the gradient (not shown). This indicates that glyoxysomal-type particles were synthesized

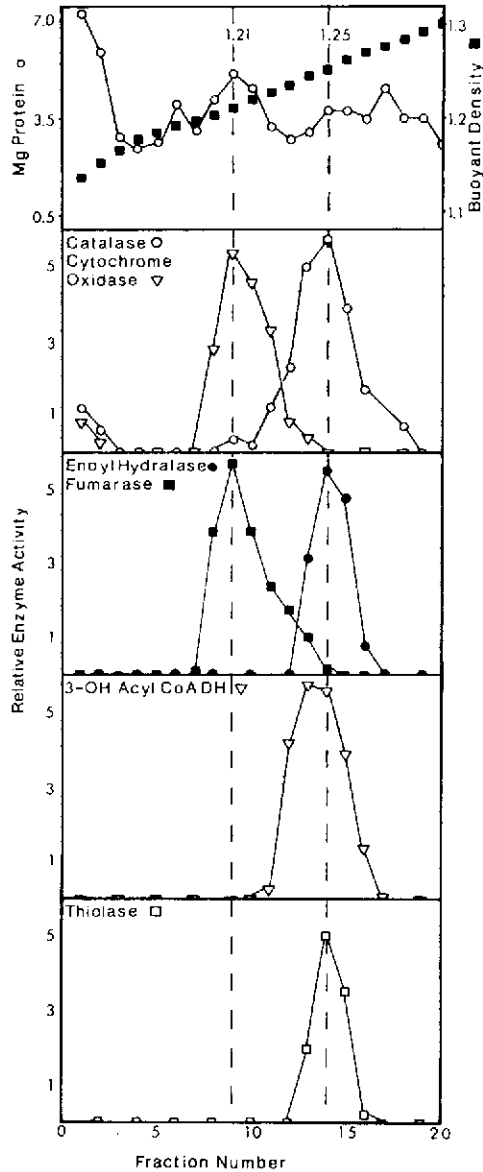

Figure 5. Distribution of protein and enzyme activity on a sucrose gradient after centrifuging a clarified homogenate of 38 DPA embryos. For actual activity (nmol/min/fraction), multiply ordinate values by 60 for enoyl hydratase, 2800 for fumarase, 85 for hydroxyacyl-CoA DH and 12 for thiolase. (From Miernyk and Trelease, 1981a).

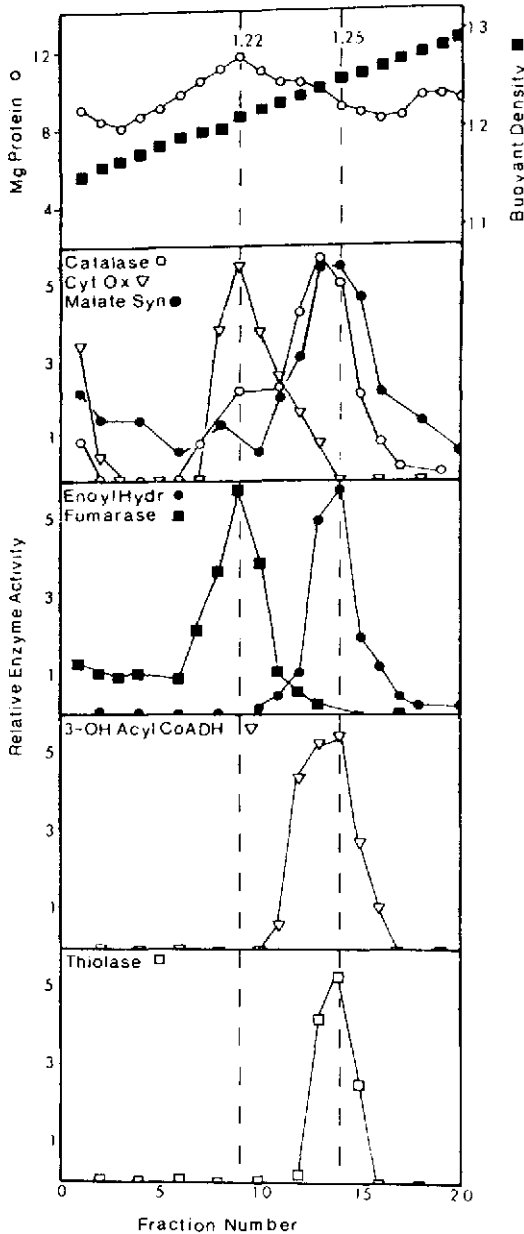

Figure 6. Distribution of enzyme activity from mature embryos on a sucrose gradient. Activity: enoyl hydratase x 150, fumarase x 4000, 3-OHAcCoA DH x 100, thiolase x 20 malate synthase x 45. (From Miernyk and Trelease, 1981a).

during maturation, notably in the absence of either marker glyoxylate cycle enzyme (ICL or MS). Isolation of particles from mature embryos (54 DPA) showed the same  $\beta$ -oxidation enzyme distribution, i.e., an exclusive localization in glyoxysomal-type particles (Figure 6). Citrate synthase, MDH and aspartate aminotransferase (not illustrated) also were localized in glyoxysomes isolated from mature embryos.

The results outlined above show that fatty-acid  $\beta$ -oxidation and related gluconeogenic enzymes are synthesized during embryogenesis and that these enzymes are compartmentalized into organelles which have a similar buoyant density on sucrose gradients, as do glyoxysomes isolated from germinated seeds (see Table 4 for a summary). This comparison does not necessarily show that the

Table 4. Summary of enzyme activities from mature embryos (50-54 DPA) equilibrating in the mitochondrial and/or glyoxysomal regions of sucrose density gradients.

Enzymes	Mitochondria	Glyoxysomes
	1.20-1.22 g/cm <sup>3</sup>	1.23-1.26 g/cm <sup>3</sup>
	nmol/min/fractions	
Isocitrate lyase	0	0
Hydroxyacyl CoA DH	0	1,487
Enoyl hydratase	0	1,528
Thiolase	0	158
Catalase	26	127
Malate synthase	37	734
Aspartate AT	483	1,125
Citrate synthase	1,452	333
Malate DH	9,848	5,226
Alanine AT	80	0
NADP isocitrate DH	160	0
NAD isocitrate DH	80	0

embryo-synthesized organelles are involved in gluconeogenesis, as are glyoxysomes in germinated seeds. The absence of detectable ICL activity in embryo-synthesized organelles suggests that gluconeogenesis from acetyl-CoA is not likely. An alternate hypothesis would be that these organelles have some role in seed maturation. Considering the known enzyme content of the organelles, it seemed possible that they are centrally involved in organic acid metabolism (see Miernyk and Trelease, 1981b, for more data and discussion).

Recent evidence obtained by Kindl's group with cucumber seeds bears directly on our work with cotton seeds. They, like others, have been unable to assay ICL activity in dry seed extracts, but they did detect a protein in the dry-seed extracts which was precipitable with an antibody made to purified ICL obtained from germinated seeds (Köller *et al.*, 1979). Thus, ICL could exist in an inactive form

*in vivo*, or it may be inactivated during extraction. We did a number of experiments with cottonseed extracts to test for possible inactivation of the enzyme during homogenization (Miernyk *et al.*, 1979). Addition of a protease inhibitor, gel filtration, etc., did not yield any ICL activity. These treatments did not rule out the possible existence of an inactive enzyme *in vivo*. However, we have prepared an antibody to germinated-seed ICL and could not detect any immunological reactants in extracts from immature embryos (Miernyk *et al.*, 1982). We believe the protein is not present in dry seeds but is synthesized *de novo* following germination, then added post-translationally to organelles synthesized during seed maturation. This delayed synthesis and compartmentation may be an important control on lipid mobilization.

Work in several laboratories on castor beans has led to a generalization that glyoxysomes are synthesized *de novo* following germination (Beevers, 1979). The data favor the hypothesis that the constituent enzymes are inserted into newly formed glyoxysomes as they vesiculate from segments of rough endoplasmic reticulum. New evidence generated by Kindl's group indicates that enzyme addition to cucumber cotyledon glyoxysomes does not proceed in this fashion. Rather, their data show that several enzymes are added to glyoxysomes from cytoplasmic pools (Frevert *et al.*, 1980; Kindl, 1982). We do not have any direct biochemical data on glyoxysomal biogenesis in cotton seeds, but we have made cytochemical electron-microscopic observations for catalase reactivity in cotyledon cells of maturing embryos and germinated seeds and found nearly the same number of glyoxysomes per cell in immature and germinated cotyledons, plus an increased size of glyoxysomes in germinated seeds (Kunce *et al.*, unpublished). Taken together, these data allow speculation that the organelles synthesized during maturation are direct precursors of glyoxysomes in germinated seeds. The renewed synthesis of gluconeogenic enzymes following germination likely reflects the need for more of the same enzymes to process the carbon liberated from stored triglycerides. Hence, the embryo-synthesized organelles may serve as "primer glyoxysomes" already constructed and available to accept the new enzymes.

Such a hypothesis is not conceptually different from Ihle and Dure's (1972) original hypothesis that cotton embryos are programmed to prepare the seed for successful germination (and/or postgerminative growth). Their postulate, however, was based on the idea that the mRNAs for the germination enzymes (actually postgerminative enzymes, since they studied ICL and a protein-degrading enzyme) were transcribed during maturation and were available for translation following germination. Our work with these and numerous other enzymes has shown that the enzymes increase in activity and are incorporated into organelles prior to germination. It is clear from Dure's work that mRNAs exist in dry cotton seeds and that they must be processed before normal germination and growth can occur (Dure, 1977; Harris and Dure, 1978). It seems appropriate now to learn which of the three subsets of mRNAs described by Dure (stored, residual, and newly-synthesized mRNA) code for the various enzymes involved in germination and seedling establishment.

## IN CULTURED EMBRYOS

There are few data in the literature describing the influence of hormones, metabolites, drugs, etc., on the development of enzymes in embryos during cotton boll maturation. Such information is needed to construct or modify working hypotheses on the mechanisms of developmental processes leading to preparation of the seed for germination. Due to the inherent difficulty in treating intact bolls with these compounds, we devised an *in vitro* culture system for excised embryos (Choinski *et al.*, 1980). Our efforts focused on culturing embryos excised about 40 DPA, since MS activity developed from zero activity subsequent to 40 DPA.

A modified version of the cotton ovule culture medium of Beasley and Ting (1973) was used. Inclusion of sucrose and L-asparagine in the media was based on high *in vivo* levels of these compounds (Mauney *et al.*, 1967) and their known role as primary transportable forms of carbon and nitrogen. The ammonium salt of malate was added in part because of the high level of malate noted in cotton endosperm tissue, and because  $\text{NH}_4$ -malate plus sucrose and salts in the media

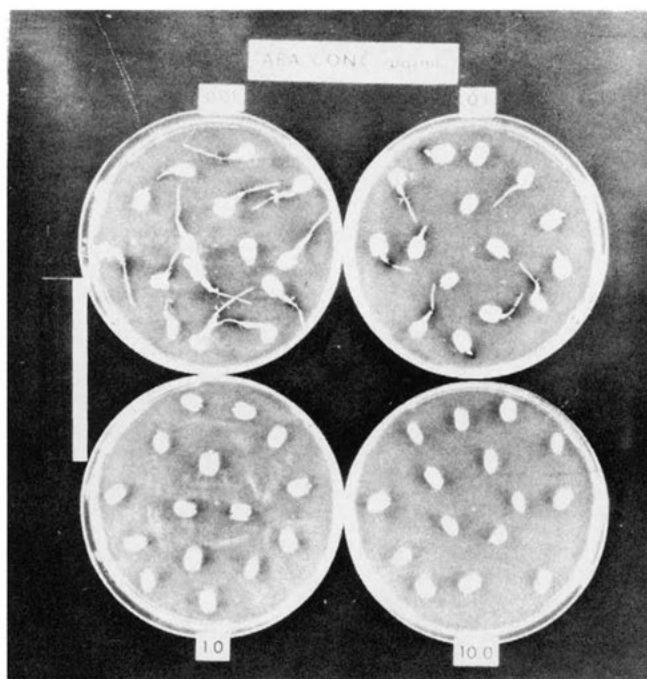

Figure 7. Appearance of embryos cultured *in vitro* for 4 days on nutrient media containing various concentrations of ABA. 1.0  $\mu\text{g}/\text{ml}$  ABA equals 3.8  $\mu\text{M}$  ABA. Bar on left equals 10 cm. (From Choinski *et al.*, 1981).

were reported to greatly improve culturing efficiency of young cotton embryos (Mauney *et al.*, 1967). ABA was included in the media since it prevents precocious germination *in vivo* (vivipary).

Figure 7 shows the appearance of embryos cultured for four days after boll excision on media containing various concentrations of ABA, and Table 5 gives the values for percent germination, radicle growth and change in enzyme activity. Embryos cultured without ABA (not pictured) appeared the same as embryos cultured with 0.01  $\mu\text{g/ml}$  (0.038  $\mu\text{M}$ ) ABA. Both precociously germinated (95-100 percent) (Figure 7) and produced radicles of approximately the same length and fresh weight (Table 5). Embryos on media with 0.1  $\mu\text{g/ml}$  (0.38  $\mu\text{M}$ ) ABA

Table 5. Influence of varied ABA concentrations on enzyme development, germination and radicle growth of cultured cotton embryos. Embryos were pre-soaked for 3 hours in the designated ABA concentration prior to culturing on plates. (From Choinski *et al.*, 1981)

Enzyme	0 Day <sup>1</sup>	4 Days culture				38
		ABA concentration ( $\mu\text{M}$ )				
		0	0.038	0.38	3.8	
		nmol/min/embryo				
Malate synthase	0	659	596	572	514	513
Isocitrate lyase	0	5	5	3	0	0
Catalase <sup>2</sup>	32	87	103	109	96	86
Hydroxyacyl-CoA DH	208	888	852	896	843	846
		Percent				
Germination	---	95	100	74	2	0
		mg/embryo				
Radicle <sup>3</sup> growth (fresh wt)	5	60	56	32	5	5
		mm				
Length	9-10	30-35	25-40	12-28	9-10	9-10

<sup>1</sup>Embryos harvested 38-40 DPA; Average fresh wt = 93 mg/embryo

<sup>2</sup>Catalase units are Lück units—see Methods

<sup>3</sup>The term radicle as used here includes radicle and hypocotyl tissue

also precociously germinated, but the average percent germination (74 percent) and radicle growth (Table 5) was less than for embryos cultured on 0.038  $\mu\text{M}$  ABA. Precocious germination of embryos was essentially nil in cultures with 1.0 and 10.0  $\mu\text{g/ml}$  (3.8 and 38  $\mu\text{M}$ ) ABA.

Comparing the enzyme activity in 0 day (excised) embryos with that in embryos cultured for 4 days on 3.8 or 38  $\mu\text{M}$  ABA (Table 5) shows that considerable development of MS, catalase and hydroxyacyl-CoA dehydrogenase activity oc-

curred in cultures without any appearance of ICL activity. Detectable ICL activity and elevated levels of the other enzymes were apparent in those embryos cultured on ABA concentrations  $\leq 0.38 \mu\text{M}$  ABA (Table 5). However, these embryos exhibited radicle growth indicating that the ICL and elevated activities were due to appearance of enzymes related to postgerminative growth.

Literature values for endogenous ABA concentrations are expressed as an amount per boll (Davis and Addicott, 1971) or  $\mu\text{g}$  ABA/kg embryo (DeLanghe and Vermeulen, 1972). Thus, it is difficult to determine whether the concentration of ABA preventing precocious germination ( $3.8 \mu\text{M}$ ) in our system is similar to an *in vivo* concentration. An estimate of molar concentration in 34 DPA embryos from DeLanghe and Vermeulen's data is  $0.08 \mu\text{M}$  ABA per embryo. Walbot *et al.*, (1975) and other reviewers (e.g., Walton, 1977) refer to "combined

Table 6. Comparison of changes in enzyme activity and other parameters during development of cotton embryos cultured *in vitro* or maintained on plants *in vivo*. (From Choinski *et al.*, 1981)

	38 DPA	4-Day culture ( <i>in vitro</i> )	54 DPA ( <i>in vivo</i> )
Enzyme		nmol/min/embryo	
Malate synthase	0	$432 \pm 18^1$	$385 \pm 23$
Isocitrate lyase	0	0	0
Catalase <sup>2</sup>	$27 \pm 2$	$61 \pm 3$	$80 \pm 2$
Hydroxyacyl-CoA DH	$168 \pm 11$	$557 \pm 17$	$426 \pm 28$
Citrate synthase	$255 \pm 20$	$406 \pm 17$	$388 \pm 25$
Malate DH <sup>2</sup>	$21.4 \pm 2$	$23.1 \pm 1$	$26.6 \pm 3.2$
Aspartate AT	$500 \pm 16$	$563 \pm 27$	$466 \pm 17$
Weight		mg/embryo	
Fresh	$81 \pm 3$	$139 \pm 5$	$55 \pm 1.2$
Dry	$46 \pm 3$	$53 \pm 4$	$52 \pm 0.6$
Protein (Bradford)		mg/embryo	
Total	$30.6 \pm 0.7$	$31 \pm 0.7$	$34.5 \pm 0.2$
Insoluble	$21 \pm 0.5$	$23 \pm 0.5$	$25 \pm 0.7$
Nitrogen	$222 \pm 17$	$\mu\text{mol/embryo}$	
		$261 \pm 17$	$286 \pm 4$
Lipid		mg/embryo	
Total	$13.8 \pm 0.9$	$15.0 \pm 0.6$	
Neutral	$11.9 \pm 0.6$	$13.9 \pm 0.5$	$16.0 \pm 0.8$

<sup>1</sup>Values for enzyme activity are means  $\pm$  S.E. of replicates from at least three separate experiments. Other values are means  $\pm$  S.E. of replicates from one or two experiments.

<sup>2</sup>Malate dehydrogenase units are  $\mu\text{mol/min/embryo}$ ; catalase units are Lück units.



gas chromatography and bioassay" values for ABA concentration in cotton ovules and embryos that ostensibly are included in a published report by Ihle and Dure (1970). However, careful examination of this reference does not reveal any such values; thus, if these data are published, their source is not known to us. Since enzyme development occurred without precocious germination in embryos cultured on 3.8  $\mu\text{M}$  ABA, this concentration was used in media for all subsequent experiments.

A comparison of various developmental changes in cultured embryos and *in vivo* embryos is shown in Table 6. Activity of all enzymes increased in the presence of 3.8  $\mu\text{M}$  ABA to levels comparable to those found in embryos removed from bolls 54 DPA. Dry weight increase of cultured and *in vivo* embryos was similar, whereas protein and neutral lipid accumulations in cultured embryos were less than in *in vivo* embryos. Overall, the data show that embryos cultured on nutrient media containing 3.8  $\mu\text{M}$  develop similarly to maturing embryos within bolls.

Table 7 shows the influence of adding various protein-synthesizing inhibitors (Act D-transcription, cordycepin-polyadenylation, cycloheximide-translation) to ABA-containing cultures. All three inhibitors essentially prevented the development of MS activity, and they suppressed additional development of catalase,

Table 7. Influence of protein synthesis inhibitors on enzyme development and fresh weight of cultured cotton embryos. Concentration of inhibitors was: ABA—3.8  $\mu\text{M}$ ; Act D—8.0  $\mu\text{M}$ ; cordycepin—300  $\mu\text{M}$ ; cycloheximide—178  $\mu\text{M}$ . (From Choinski *et al.*, 1981)

Enzyme	0 Day <sup>1</sup>	3 Days culture			
		ABA	ABA Act D	Cordycepin	Cycloheximide
		nmol/min/embryo			
Malate synthase	0	400	24	29	37
Isocitrate lyase	0	0	0	0	0
Catalase <sup>2</sup>	25	55	18	22	12
Citrate synthase	243	452	192	234	160
Malate DH <sup>2</sup>	26.2	28.0	25.4	27.8	33.4
Aspartate AT	1012	1977	1630	1537	1672
Enoyl hydratase	2072	3625	2022	1818	1620
Hydroxyacyl-CoA DH	138	300	154	126	106
Thiolase	164	100	117	74	76
		mg/embryo			
Embryo (fresh wt)	74	131	101	104	98

<sup>1</sup>Embryos harvested 38-40 DPA

<sup>2</sup>Catalase units are Lück units; malate DH units are  $\mu\text{mol}/\text{min}/\text{embryo}$

citrate synthase, enoyl hydratase, hydroxyacyl-CoA dehydrogenase and thiolase activity. Further development of MDH and aspartate aminotransferase activity was apparent in the presence of these drugs, but some inhibition was noted. It may be significant that the latter two enzymes exist as multiple forms (Beevers, 1979). The results may reflect a selective inhibition of the glyoxysomal, and not the mitochondrial or cytoplasmic, forms. The complete inhibition of citrate synthase development would be an exception to this idea, since it apparently also exists in multiple forms.

The data in Table 7 provide good evidence that enzymes known to be incorporated into glyoxysomes during maturation (Table 4) can be transcribed and translated in the presence of ABA. Inhibition by cordycepin indicates that the mRNAs for these enzymes must be polyadenylated prior to translation. Harris and Dure (1978) also have reported the requirement for such processing of mRNAs conserved in the dry seeds. Development of ICL activity again is conspicuous by its absence. These and other results previously described for ICL development explain the rationale for Dure's proposal that "germination enzyme" development is suppressed by ABA, and, hence, so is vivipary. None of the embryos in this experiment precociously germinated. In this regard, our results are again inconsistent with Dure's finding that addition of Act D to ABA-treated embryos overcame the effect of ABA and permitted germination. The difference in results is not presently understood. We have cultured excised embryos on agar plates containing only ABA and found that the embryos did not germinate. Thus, we believe that ABA is important in preventing vivipary, but we do not accept the hypothesis that its action is through the prevention of mRNA translation of enzymes unique to germinated seeds, since these enzymes are translated in immature embryos in the presence of ABA (Tables 5-7). One cannot ignore the lack of ICL development, however. It is entirely possible that ABA blocks ICL appearance and thereby blocks germination. This reasoning is clouded by the fact that ICL activity appears in precociously-germinated embryos and germinated seeds several hours after germination (protrusion of the radicle) commences, not concomitant with germination. (See Chapter 28 for additional information on ABA control of mRNAs.)

## SUMMARY

Assaying for activity of several key gluconeogenesis-related enzymes in maturing cotton embryos has revealed new information pertinent to understanding developmental events that occur during boll maturation. First and foremost is the fact that all of the gluconeogenesis-related enzymes examined, except ICL, appear at some time during maturation and are incorporated into organelles (glyoxysomes and mitochondria). Their localization in organelles within mature embryos is the same as in germinated seeds. The function of the embryo-synthesized glyoxysomes is not clearly understood. They may play a non-gluconeogenic

role during the late stages of maturation, such as in the metabolism of organic acids (Miernyk and Trelease, 1981b), and/or they may be needed as direct precursors for the glyoxysomes centrally involved in lipid mobilization and gluconeogenesis during postgerminative growth. Other functions are equally possible but have not been adequately explored.

Our data generally reenforce the concept originally proposed by Dure that certain developmental events occur which prepare the seed for successful germination and/or postgerminative growth. However, the data presented in this paper coupled with results from Benedict's laboratory (Chapter 22) strongly indicate that substantial modification of Dure's proposed developmental scheme is in order. The following is a list and brief discussion of major modifications suggested by the new information. Figure 8 is a diagrammatic summary of these events and

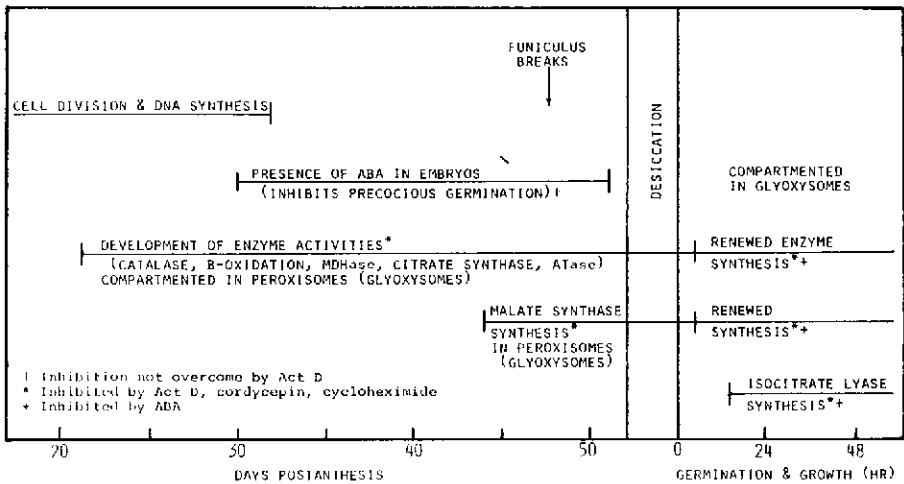

Figure 8. Schematic summary of the sequence of events in maturing and germinated cotton seeds. (From Choinski *et al.*, 1981)

our results.:

1. The list of developmental events associated with the natural atrophy of the funiculus thought to occur at 32 DPA should be abandoned and described again in a revised temporal map. Benedict's group has strong evidence that funiculus atrophy occurs much later (45 to 50 DPA), and our data show the appearance of several enzymes beginning at about 22 DPA;
2. The concept that ABA prevents vivipary should be preserved. The postulated mechanism of ABA inhibition of germination needs to be revised based on new knowledge that numerous "germination" enzymes are synthesized during maturation. The proposal that immature embryos and mature seeds are differentially sensitive to ABA must be reconsidered since two independent reports

have shown that mature seeds also do not germinate in the presence of ABA (Halloin, 1976a; Radin and Trelease, 1976);

3. The synthesis of glyoxysome-type organelles and timing of their appearance with different enzymes should be integrated into the developmental scheme. The early appearance of catalase and  $\beta$ -oxidation enzymes likely is important in relation to successful lipid synthesis and deposition. The delayed appearance of MS activity and absence of any development of ICL activity probably are important to maturation, but more work is needed to understand the significance of these phenomena; and,
4. The concept of mRNAs being transcribed during maturation and conserved in dry seeds should be retained. However, the timing of this mRNA synthesis and suggestions that they are not translated until germination should be reconsidered. Knowledge of the proteins coded for by these mRNAs would be helpful in this regard. Finally, the proposition that the pre-existing mRNAs code for the entire body of enzymes unique to germination in a coordinated fashion is no longer tenable. Many of these enzymes are synthesized during maturation, some at different times. Some or all of the conserved mRNA may code for renewed synthesis of these enzymes, or initial synthesis of ICL, but more data are needed to explore these possibilities.

### ACKNOWLEDGEMENTS

The cooperation and support of the Western Cotton Research Laboratory, USDA-ARS, Phoenix, AZ is gratefully acknowledged. Special thanks are due Drs. J.W. Radin, J.R. Mauney, G. Guinn and D.C. Doman for their advice, numerous discussions and help on various aspects of the research. Financial support came primarily from the N.S.F.

*SECTION IV*

**SEED AND GERMINATION**

## Chapter 30

# DEVELOPMENTAL ASPECTS OF PLANTING SEED QUALITY

Harry R. Leffler<sup>1</sup>  
USDA-ARS  
Stoneville, Mississippi

## INTRODUCTION

Cotton seed planting quality has become the subject of increasing interest to both producers and research scientists in recent years. A grower's primary interest in seed quality stems from the inherent requirement to establish a stand as rapidly as possible, to assure the production of a harvestable yield as economically as possible. Cotton seeds with high planting quality can be expected to germinate quickly and produce seedlings that emerge rapidly from the soil, under both favorable and adverse environmental conditions. Cotton seeds produced under diverse conditions possess varying levels of quality that can be associated with the ultimate yield potential of the seedlot (Peacock and Hawkins, 1970). Planting seed quality is also associated with the development of yield, in that the majority of a crop of seedcotton is produced by plants originating from the most rapidly-emerging seedlings (Wanjura *et al.*, 1969). Germination and stand establishment consequently form not only the basis for the term "planting seed quality", they can also have a pronounced effect upon a grower's success in producing a cotton crop.

Unfortunately, however, the planting quality of cotton seeds has been of only peripheral interest to many experimentalists, particularly those who are investigating the processes of seed development. There is, therefore, a relative paucity of research information that lends itself to the definitive identification of cotton seed planting quality characteristics. In this review, some aspects of seed development are described that may influence the planting quality of cotton seeds. Initially, a brief summary of seed development will be presented; this topic was covered in detail earlier by Stewart (Chapter 20). Then, attention will be directed to aspects of seed development that are responsive to the physiological status of the plant upon which the seeds develop. Finally, a description will be made of the seasonal and developmental aspects of planting seed quality, which will lead to a discussion of a physiologically oriented system for the production of high quality cotton seeds.

<sup>1</sup>Presently with DeKalb-Pfizer Genetics, DeKalb, Illinois

## CHRONOLOGY OF SEED DEVELOPMENT

Boll development from anthesis to maturity can be divided into three distinct phases. The first developmental phase lasts for about three weeks; most growth during this period is enlargement. During this initial period, the final volumes of the boll and seeds are established and most of the fiber elongation occurs. As elongation of the fiber and enlargement of the boll and seed begin to slow, the boll enters the second developmental phase, the filling period. Most of the dry weight of the boll components accumulates during the filling period, which begins after the third week postanthesis and continues until about 10 days to two weeks before boll opening. During this phase, most fiber growth occurs through secondary wall formation, while seed growth is through accumulation of oil and protein by the embryo developing within the volume established by the integuments. Very little dramatic change in the dry matter distribution occurs in the final period of boll development, the maturation phase. This period does, however, cover the time during which some significant physiological processing takes place; boll development is generally considered to be complete upon opening of the boll.

Similarly, seed development can be considered to span the three phases of enlargement, filling and maturation. Accumulation of dry matter by developing seeds is nearly linear through the enlargement and filling periods; it becomes essentially nonexistent, or sometimes even negative, during the maturation phase (Leffler, 1976c). Although the general tendency is for weight accumulation to be nearly linear with time, the occurrence of a period of stress—even for a short time—may disrupt this pattern (Leffler, 1976c). The pattern of dry matter accumulation by cotton seeds becomes considerably more intriguing once attention is given to the composition of the dry matter that is being accumulated.

When investigating mineral nutrient accumulation in cotton seeds, Leffler and Tubertini (1976) found that the percentage of most nutrients decreased during the first two and one-half weeks of development. Once the minimum concentrations were reached between 15 and 20 days postanthesis, the nutrients then accumulated throughout the filling period.

Developing seeds were examined for carbohydrate composition because the integuments appeared to be heavily laden with a white storage product during the third developmental week (Leffler, 1976b), even though Grindley (1950) had reported extremely low levels of carbohydrate during early seed development. It was found upon direct examination, however, that there was considerable starch present; its concentration peaked, at or above 20 percent, at the same time as the mineral nutrient concentrations reached their respective lows (Leffler, 1976b). The developmental pattern of cotton seed starch concentration is illustrated in Figure 1. Subsequently, histochemical staining illustrated the deposition of starch, primarily in the integuments and secondarily in the gelatinous matrix of the endosperm; this starch was later consumed as the seed developed (Leffler and King, 1977). A similar developmental pattern was identified with the soluble

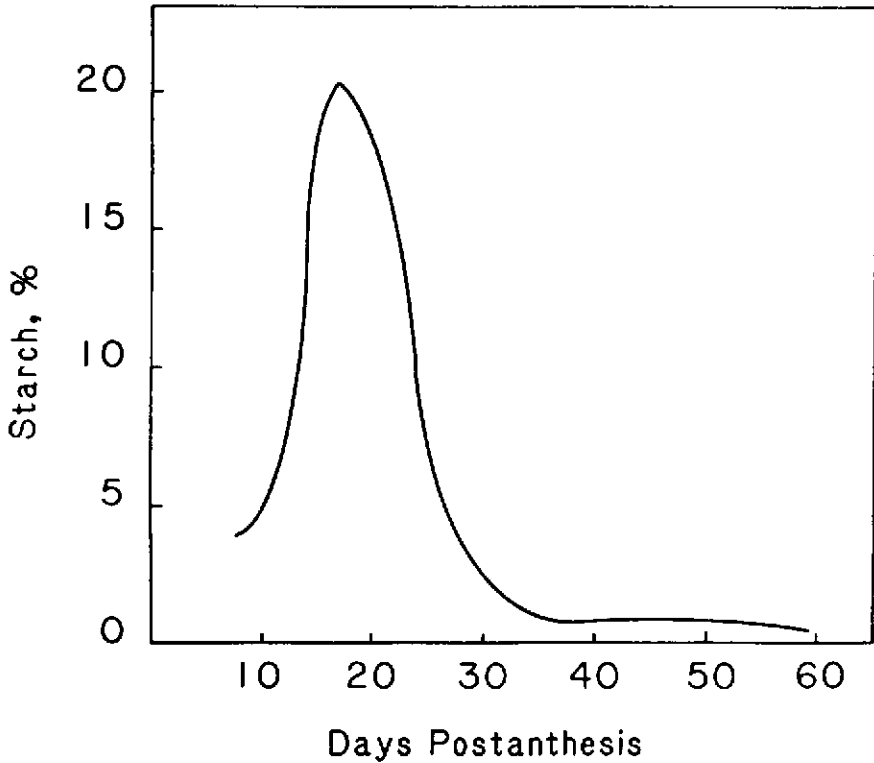

Figure 1. Starch concentration during development of cotton seeds.

sugars, although their concentrations did not diminish as rapidly as did that of starch. Analysis of the components of the soluble sugar pool revealed that maltose was the predominant sugar throughout seed development. Among the other sugars, glucose and fructose predominated during the enlargement phase, while sucrose was the second most prevalent sugar during the seed filling period. The predominance of maltose would be consistent with the degradation of starch by amylase, while the level of sucrose would indicate the arrival of photosynthate to the seed directly from translocation.

Seale (1942) described the accumulation of oil in developing cotton seeds and identified the period from 25 to 40 days postanthesis (DPA) as that during which most oil accumulation occurred. This general pattern was also described by Grindley (1950). When, however, samples were taken earlier in development, it was found that the concentration of oil in the seed followed a pattern similar to that of the major mineral nutrients (Ali and Ullah, 1963). After declining from anthesis to about 17 days postanthesis, the seed oil concentration increased until



near the end of the seed-filling period (Ali and Ullah, 1963). The fatty acid composition of the triglyceride fraction changes throughout the enlargement period; once major oil deposition is underway during the filling period, however, the fatty acid profile changes little (Kajimoto *et al.* 1979).

Essentially similar patterns of the amino acid profiles were identified during the phases of seed development by Elmore and Leffler (1976). Their data showed few changes in the cotton seed amino acid profiles after about the fourth week of development. The predominant group of proteins accumulating during this phase of development was shown by King and Leffler (1979) to be storage proteins. The amino acid profiles during enlargement (early seed development) were markedly influenced by the presence of a substantial non-protein nitrogen pool (Elmore and Leffler, 1976). Relative concentrations of seed oil and protein in developing cotton seeds are shown in Figure 2.

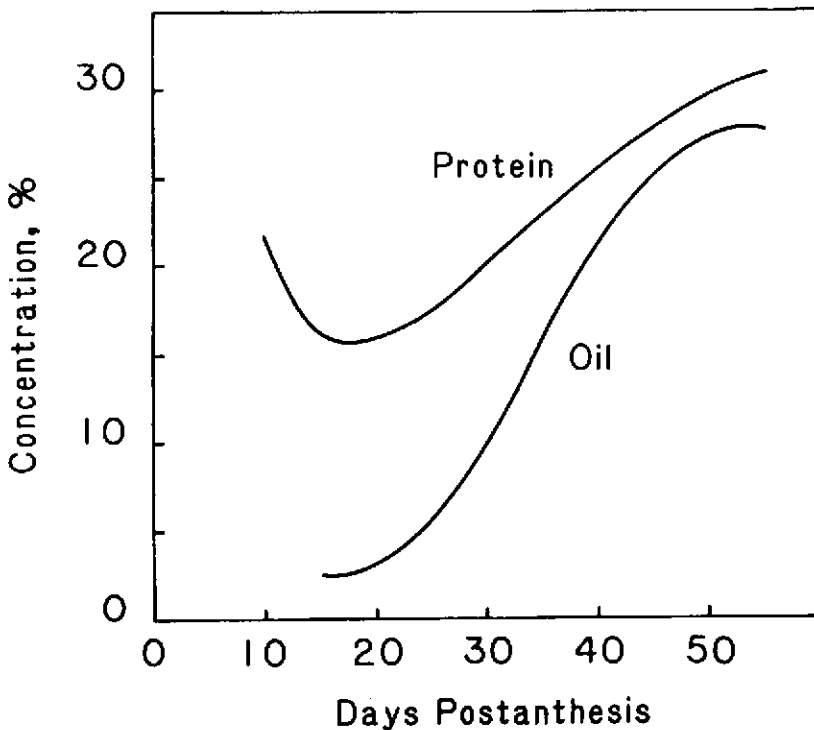

Figure 2. Protein and oil concentrations during development of cotton seeds.

## EFFECTS OF DATE OF BLOOM ON SEED DEVELOPMENT

Because of the indeterminate flowering pattern of cotton, the reproductive development of a cotton crop may span a period of several months, even without considering the preliminary period of floral initiation (squaring). While the actual period of bloom may be restricted to a two-month interval, it may continue for a longer time, depending upon the cultivar and the production environment in which the crop is grown. Subsequent boll development then extends the effective reproductive season by an additional six weeks to two months.

As the cotton crop progresses through the reproductive period, a plot of the number of blooms per day per unit area approximates a bellshaped curve (Verhalen *et al.*, 1975). Within this distribution of blooms, there is another distribution—that of the number of bolls forming from these blooms. A comparison of these two distributions reveals a nearly linear decline, over time, in the percentage of fruiting forms retained (Chapter 12).

Because of the extended period of bloom, bolls develop under a pronounced range of environmental conditions. These conditions are defined by both meteorological and physiological parameters. The combined effects of these shifting conditions on the cotton seeds can be identified through the use of stratified (periodic) harvests. This method of harvesting produces seedlots that can be generally traced to different dates of bloom and development within the different portions of the parental canopy. Comparisons of the boll components from stratified harvests reveal the influences of bloom-developmental period on a number of parameters (Meredith and Bridge, 1973). Generally, seeds from late bolls are considerably smaller than those from early bolls (see Chapter 20).

Ali and Ullah (1963) followed the development of seeds from bolls tagged periodically throughout the bloom period. Their data, and those of Leffler (1976c), illustrate the contrast in weight accumulation by seeds from early blooms and those from late blooms. A very similar pattern was found for the development of oil content by these seeds. Data collected over several seasons at Stoneville, Mississippi, indicate that both oil and protein concentrations of cotton seeds change from early-season bolls to late-season bolls (Leffler, H.R., unpublished data). Significantly, however, the degree of change of these storage products in bolls from various positions in the canopy is highly dependent upon the production environment (year). Generally, the late-season seeds weigh less and have a higher oil:protein ratio than do the early-season seeds (Nelson, 1949; Tharp *et al.*, 1949), although there have been exceptions to this pattern for the oil:protein ratio (Kohel, R.J., and J.P. Cherry, personal communication).

## ESTIMATIONS OF PLANTING SEED QUALITY

Within a seedlot, the percentage of seeds that germinate and produce seedlings that emerge from the germination medium can be used as an index of the planting quality of that seedlot. Evaluation of planting quality can be conducted either in the laboratory (in germinators or greenhouses) or in the field. Laboratory evaluations are indirect measures of planting quality while field measurements are direct measures of planting quality. Each approach to evaluation has advantages—and disadvantages. When the experimental procedures are appropriate, however, some parallels can be generated.

Pinckard and Melville (1977), for example, generated a seed quality index for each of several seedlots in greenhouse tests, then measured yields of the same seedlots in field tests; yields were directly related to the seed quality index. Wanjura *et al.*, (1969) found that the plants from the most rapidly-emerging seedlings contributed the most to the yield of that plot. Seedlots of a given cultivar, produced in different environments, possess different levels of seed quality that are associated with differential yield potential (Peacock and Hawkins, 1970).

Direct examinations of the effects of developmental/seasonal phenomena upon seed size, composition and planting seed quality are relatively scarce, however. Although their principal objective was to investigate the deterioration of cotton seeds in the field, Simpson and Stone (1935) collected some data that suggested that early-formed seeds might germinate better than late-formed seeds.

Caldwell (1962) studied, in Mississippi, the influences of many production practices upon the planting quality of the cotton seeds that were harvested. Among the production management factors identified as influencing seed quality were row spacing, nitrogen fertilization and boll position in the parental canopy. Within the experimental limitations of his study, he found that relatively poor quality seeds were produced in narrow rows, under high levels of nitrogen fertilization and at boll positions low in the canopy. Maleki (1966) subsequently provided some confirmation of the beneficial influence of low population density on seed quality. Fertilization with less than 67 kg/ha nitrogen was associated with the production of the highest-quality cotton seeds (Caldwell, 1962). Both Caldwell (1962) and Maleki (1966) reported that seeds from bolls low within the parental canopy were inferior to seeds produced at higher positions. Each of these studies, however, was primarily concerned with in-field preharvest deterioration, and this determinant of seed quality would be most severe in the lower strata of the parental canopy.

From their investigations of the influences of night temperature (between 5 and 25C) on cotton growth and development, Gipson and Joham (1969b) found there to be a positive relationship between germination and the night temperature during seed development. Night temperature was more influential than day temperature on cotton seed weight increase (Gipson *et al.*, 1969).

We have used seedlots obtained from stratified harvests to evaluate the planting quality of seeds produced during various portions of the production season. Seedlots produced under differing conditions, but from within the same canopy, differ not only for the ability to produce a stand, but also for the ability to produce a crop of seedcotton.

Initial field evaluations were conducted at Stoneville in 1977 on seeds of 'Stoneville 213' cotton produced in 1976. The experiment was repeated the following year with seeds of the same cultivar produced in 1977. Both stand and yield data were collected each year. Stands in both years were significantly influenced by the date of the source harvest (period of seed development), as were seedcotton yields in 1977. In 1978, the yields were affected more by the stands that survived a hail storm that occurred immediately after the initial stand counts were recorded than they were by the initial stands themselves. The best seedlots in the 1977 evaluation were obtained from the middle of the parental canopy; seeds with much lower productivity potential were obtained in the later source harvests (Figure 3). Both earliness and total seedcotton yield were affected by the develop-

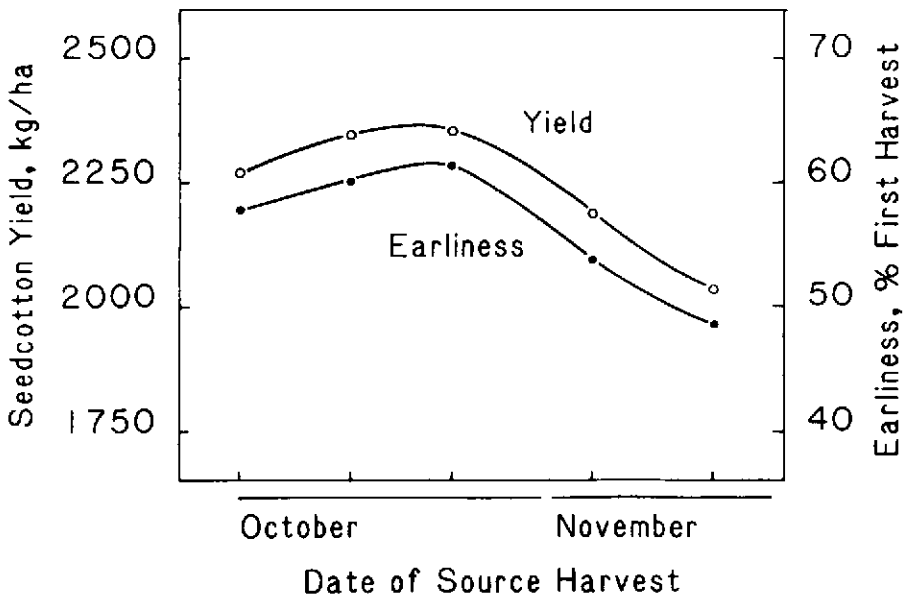

Figure 3. Seedcotton yield and earliness, as influenced by dates of planting seed maturation and harvest.

mental period of the seeds; the major determinant of total yield was the first-harvest yield, a measure of earliness.

In each year, however, the effect of source harvest upon stand was highly significant. The source harvests evaluated in the 1978 test were gathered nearly a month earlier in the production season than those evaluated in the 1977 test.

Consequently, the mean temperatures during development were much higher for the former seedlots than for the latter seedlots. Thus, it appears that some physiological aspects of the parental canopy, not just night temperature, influence the germinability of the seeds produced (Leffler *et al.*, 1978). Similarly, the physiology of the germinating seedlings seems to have contributed to the yield differentials observed among seedlots, since there remained significant differences among seedlots after the effects of stand were removed by analysis of covariance. Leffler and Williams (1983) showed that seed quality differentials can affect sustained seedling growth.

In 1979, evaluations of the field germination of seedlots of three cultivars were conducted; as in previous experiments, relatively unweathered seedlots were obtained from stratified harvests. There was, however, a warm rainy period between the first and second harvests that contributed to weathering of the second-harvested seedcotton. Although the stand counts revealed a significant influence of cultivar on stand establishment (Leffler, 1980a), each cultivar responded similarly in terms of planting quality over the various stratifications.

There are indications that planting seed quality may be enhanced through genetic selections. The cultivar effects in the 1979 seed quality evaluations at Stoneville appear to be genetic background effects, separate from canopy maturity characteristics. Tupper (1969) reported that the density of cotton seeds was the most important predictor of planting seed quality, a conclusion supported by Krieg and Bartee (1975; see also Chapter 33). El-Zik and Bird (1969) found that the ability to establish a stand was a quantitatively inherited trait that could be improved through breeding. Hess (1977) subsequently reported the genetic improvement in seed density through three cycles of selection; this increased seed density was associated with a significant increase in lint yield. A possible limit to the desirability of high seed density was suggested by King and Lamkin (1979) who found that increases in seed density were associated with reductions in seed volume. The optimum seed density (1.04 to 1.08 mg/mm<sup>3</sup>) reported by King and Lamkin (1979) was found by Leffler and Williams (1983) to be that at which there was a maximum value for the ratio of oil content to protein content of the seeds; higher density seeds were so limited in storage reserves that their performance was severely restricted.

## PRODUCTION OF QUALITY PLANTING SEEDS

The production of cotton seeds is imposed on the parental canopy structure, so the factors that influence either the physiological competence or the activity of that canopy also affect the quality of the seeds produced. There are many reports of the reduced seed weight of late-maturing bolls (Nelson, 1949; Tharp *et al.*, 1949; Meredith and Bridge, 1973; Leffler *et al.*, 1977) and of the compositional changes of seeds produced during different portions of the season (Nelson, 1949; Tharp *et al.*, 1949; Ali and Ullah, 1963; Leffler *et al.*, 1977). Two factors, more

than any others, contribute to these seasonal profiles: 1) temperatures (Gipson and Joham, 1969b) and 2) the number of bolls developing on the same plant and competing for photosynthate. For these and other reasons, there is a seasonal distribution of cotton seed qualities. Generally, the best seeds appear to be produced near the middle of the parent canopy. The quality of early-forming seeds is restricted, either by the limited availability of photosynthate or by the less-than-ideal environmental conditions low in the canopy (Caldwell, 1962) that are conducive to post-maturity deterioration of seeds. Late-forming seeds, conversely, appear never to have acquired quality, because of restricted growth.

Other production practices may also influence seed quality. Both Caldwell (1962) and Maleki (1966) reported an enhancement of planting quality due to a reduced population density in the seed production field. Additionally, Caldwell (1962) found that nitrogen fertilization above about 65 kg/ha reduced the quality of the seeds produced. Both population density and nitrogen fertilization have significant effects upon the timing and duration of reproduction.

With these and other factors influencing the planting quality of cotton seeds, a physiological approach to the production of planting seeds might be in marked contrast to standard production practices. It would appear that plant population density might need to be reduced, although we do not now have a good estimate of the optimum planting density. The amount of nitrogen fertilizer applied to a production field should be limited, probably to 60 kg/ha or less, in an area such as the Mississippi Delta. While other production areas would likely have different optimum levels of nitrogen for cotton planting seed quality, these levels would undoubtedly be lower than those currently used in standard production systems. Additionally, the seed crop must be harvested so that weathering losses can be minimized and the latest-formed seeds, because of their inherently inferior seed quality, are excluded. Gipson and Joham (1969b) stated emphatically: "Thus, one may question the practice of producing planting seed in the northern areas of the Cotton Belt. In any case, the use of seed produced late in the season under low night temperatures could not be recommended unless adequate laboratory evaluations were made on the specific seed lot." Few data available today would diminish the thrust of their statement.

Specialized production of all cotton planting seeds in a selected production region, such as Arizona or California, has frequently been suggested. The advantages of this approach would include the implementation of production practices specifically designed for the development of planting seed quality in an environment that would be expected to have minimal weathering losses. This concentration of planting seed production would be expected to encourage the adoption of specialized harvesting, ginning and seed handling procedures that would preserve the quality parameters that the seeds had acquired during development. These modifications in production and processing practices should result in a reduction of producer problems in stand establishment.

There would, however, be logistical problems encountered in such a restructur-

ing of cotton planting seed production procedures. The adoption of a specialized seed production region would, for most producers, greatly increase the transportation costs for planting seeds. Additionally, seeds of many cultivars would be produced outside the areas of adaptation for those cultivars. Therefore, a premium price for the seeds of those cultivars would be required to compensate for their relative yield disadvantage. Additional costs would be incurred for the preservation of varietal purity, both for the minimization of outcrossing and for the elimination of mechanical mixtures and contaminants. While these latter costs would also affect, to a degree, any specialized seed production system, the more broad geographically based systems would tend both to reduce them and also to minimize the transportation costs associated with the seeds. Consequently, the more localized production systems will probably have a better chance to develop.

## SUMMARY

The planting quality of a cotton seed can be ultimately defined by its ability to germinate and produce a seedling that rapidly emerges from the soil under field conditions that may be considerably less than ideal. Both seedling growth rates and crop productivity potential can be significantly influenced by seed quality characteristics. Although the planting quality of a cotton seed is at its relative maximum immediately after boll opening, not all seeds in a crop possess equivalent planting quality at maturity. As the physiology of the production canopy is affected by numerous management factors, so is the planting quality of the seeds formed within this canopy. Seeds that are formed relatively late in the season are usually small and contain little storage reserve that can be drawn upon during germination and seedling establishment. Consequently, these seeds are usually identified as having poor planting quality. Production practices that tend to shift the development of the production crop to later maturity will, therefore, tend to reduce the relative planting quality of the seeds that are harvested. Conversely, if the crop is managed so that its development becomes relatively more determinate, the planting quality may also be penalized because of the internal competition among bolls for a relatively limited supply of photosynthate. Maximum planting seed quality should be obtained when the production crop is managed so that vegetative and reproductive development remain in balance and when the seed-cotton crop is harvested before any weathering deterioration has a chance to occur.

## Chapter 31

# WEATHERING: CHANGES IN PLANTING SEED QUALITY BETWEEN RIPENING AND HARVEST

John M. Halloin  
USDA-ARS  
College Station, Texas

## INTRODUCTION

Weathering of cottonseed is a term used to describe a series of processes, usually deteriorative, occurring between the times of boll opening and harvesting. Typically, weathered seeds exhibit an increase in free fatty acids, a decrease in germinability and vigor and a change in embryo color from creamy white to greenish or greenish-brown (Altschul, 1948). Plants derived from weathered seeds frequently are less robust, more prone to seedling diseases and less fruitful than those from nonweathered seeds.

## INCREASES IN VIGOR AND GERMINABILITY

Apparently sound cottonseed occasionally exhibit transient low percentages of germination. For example, samples from two lots of seed harvested immediately following boll opening in 1980 exhibited germinations of 31 and 42 percent, when tested within a week of harvesting. When retested two months later, they germinated 90 and 94 percent, respectively. Because such dramatic increases in germinability seldom are observed in commercial seed samples, it is likely that loss of dormancy occurs as a natural consequence of field exposure. Transient dormancy was first described by Simpson (1935a). Investigators studying the effects of accelerated aging on cottonseed occasionally observe slight increases in germination percentage or vigor during the early stages of aging (Bird and Reyes, 1967) and have referred to this phenomenon as "quality conditioning". Abscisic acid, an endogenous constituent of developing cottonseed, decreases in concentration as seeds near maturity (Davis and Addicott, 1972). This compound inhibits the



percentage and rapidity of cottonseed germination (Halloy, 1976a) and is, therefore, likely to be the cause of both transient dormancy and quality conditioning.

## DECREASES IN VIGOR AND GERMINABILITY

### CHANGES IN SEEDS ASSOCIATED WITH WEATHERING

The most commonly observed manifestations of weathering of planting seeds are decreases in germination and seedling vigor, which may be viewed as end products of the deteriorative processes involved. Although considerable work has been done on weathering and its associated processes and consequences, little is known of the physiological processes that lead to reductions in vigor and germinability.

Lipolysis, the breakdown of glycerides to free fatty acids, commonly is associated with reduced seed performance. Rusca and Gerdes (1942) reported an inverse correlation between the free fatty acid contents and germination, with little or no germination in lots of seeds containing more than 8% free fatty acids. Hoffpauir *et al.* (1947) in an elegant experiment on individual seeds, demonstrated that seeds containing more than 2% free fatty acids fail to germinate. These observations suggest that free fatty acid formation might be involved in reduction of germinability. But Lewis (1969) and Bartkowaki *et al.* (1978) failed to detect an adverse effect on seedling performance when seedlings were treated with exogenously applied fatty acids. Failure of exogenous free fatty acids to inhibit germination is not surprising, since high concentrations of these materials are present within seedlings during normal germination (St. Angelo and Altschul, 1964). These observations indicate that accumulation of free fatty acids and loss of germinability are independent manifestations of deterioration.

A high incidence of abnormal seedlings also is associated with weathered seeds. Wiles and Presley (1960) described "nub-root," a condition in seedlings from weathered seeds in which part or all of the tap root fails to develop. Hunter and Presley (1963) later referred to this phenomenon as "pinched root tip" and observed that there was a complete lack of cell division in the tips of these roots. This condition leads to the development of weakened seedlings completely lacking a tap root.

High specific gravity of seeds is commonly associated with good planting seed quality (Chapter 33). However, Ray and Minton (1973) observed no reduction in seed weight as a consequence of weathering. I have repeatedly looked for and observed decreases in seed density during weathering. Additionally, I have found no differences in susceptibility to weathering among high and low buoyant density seeds. Thus, degree of and changes in seed density do not appear to be associated with weathering.

## THE INFLUENCES OF ENVIRONMENTAL FACTORS ON WEATHERING

The main environmental factor influencing weathering of cottonseed is moisture. The association between moisture and weathering of cottonseed was first reported by Simpson and Stone (1935) who observed that cottonseed exposed to rain or high humidity deteriorated, whereas those harvested before exposure to moisture retained high quality. Additionally, cottonseed ripening during humid or wet weather were more prone to deterioration than those ripening during dry weather. Later, Meloy (discussed in Altschul, 1948) observed that cottonseed produced in humid areas adjacent to rivers exhibited more deterioration than seeds produced in the same vicinities, but under less humid conditions. He concluded that the humidity under which seeds developed and ripened was the only significant factor influencing weathering. Woodruff *et al.*, (1967) also reported that humidity during boll ripening was the only factor that influenced seed quality. Light intensity and temperature had little or no influence. Exposure to rainfall, dew deposition and high humidity after ripening also contribute to weathering, but the influence of moisture on seeds during ripening appears to exert the major influence on predisposition to weathering.

The indeterminate and dispersed fruiting habit of the cotton plant enhances moisture retention of bolls, and thus, weathering. The earliest ripening bolls have the most frequent exposure to moisture. This problem is compounded by the fact that the bolls closest to the ground or enclosed within the plant canopy, which normally are the earliest ripening ones, generally dry out more slowly than other bolls and, thus, have more prolonged exposure to moisture during each moist period. Hofmann and Taylor (1980) found that seeds from early- and late-set bolls were about equal in their predisposition to weathering; hence, the major difference in weathering between these two groups is the amount of exposure to moisture.

The constant association of high moisture with seed deterioration during weathering does not mean that water is the cause of this deterioration. Water merely provides a favorable environment for its occurrence.

## THE CONTRIBUTION OF BIOLOGICAL PROCESSES TO WEATHERING

Nearly as constant as the association between moisture and weathering, is the association between infection of seeds by microorganisms, primarily fungi, and weathering. In experiments on individual weathered seeds, nearly all seeds that failed to germinate in 7 days at 22C were infected by microorganisms. Of the few noninfected seeds that failed to germinate at 22C, nearly all germinated within 2 days at 30C (Halloin, 1981a).

The variety of microorganisms which infect seeds during field exposure varies with moisture availability. In the relatively moist eastern portion of the United States cotton belt, infection by "field fungi," such as *Aspergillus niger* and species of *Alternaria*, *Fusarium*, *Diplodia*, *Rhizopus* and *Colletotrichum* (Davis, 1977; Roncadori *et al.*, 1971; Simpson *et al.*, 1973), is common. In the more arid western portion of the U.S., infection by field fungi is less pronounced, and infection by osmophilic fungi or "storage fungi" such as *Aspergillus flavus* is more common. Generally, the field fungi require higher water potentials for growth than do the osmophilic fungi. This requirement for water is reflected in the geographic distribution of these fungal groups in infected cottonseed. However, moisture in the environment also affects the activity of osmophilic fungi. Russell *et al.* (1976) demonstrated that early termination of irrigation in Arizona cotton fields reduced production of aflatoxins by *A. flavus* in cottonseed.

Infestation of weathered cottonseed by bacteria is more common in the eastern than in the western portion of the U.S. cotton belt, reflecting the requirement of high water potential for growth of bacteria. Among bacteria isolated from cottonseed are species of *Bacillus*, *Pseudomonas* and *Xanthomonas* (Mayne, 1956). Infection of seeds by *X. malvacearum*, the cause of bacterial blight of cotton, is a major factor in the spread of this organism (Brinkerhoff and Hunter, 1963).

The contribution of microorganisms in post-ripening boll rot is well accepted. This phenomenon is most pronounced in bolls exhibiting "hard loc", a condition in which bolls crack and partly open under moist conditions but fail to fluff. Extensive growth of fungi in hard loc bolls is easily visible and causes rapid rotting of both lint and seeds. Apparently, slow drying of these bolls provides a highly satisfactory environment for growth of fungi. Hard loc bolls normally are excluded from harvest during picker harvesting, but they are collected during stripper harvesting, and their seed can contribute to decreased performance of seed lots. A more subtle manifestation of this problem is described as "microbial tight loc" (Marsh *et al.*, 1954); bolls exhibiting this phenomenon are partially fluffed. This phenomenon occurs under the same environmental conditions as hard loc but may also occur under arid conditions when bolls open prematurely due to moisture stress. The partial fluffing of tight loc bolls results in their being harvested both in stripper and in picker harvesting. A sheen that persists on the matted fibers, and the visible growth of fungi, suggest that materials that may provide a nutrient base for fungi are present. Normally these materials are resorbed by boll tissues or fibers during the latter stages of boll development. In a recent study, I observed (unpublished) that seeds from tight loc and the most nearly adjacent fully fluffed bolls exhibited 97 and 93 percent infection by fungi, and 45 and 61 percent germination, respectively. Clearly, many infected seeds in both groups germinate, but germination of seeds from tight loc cotton was more severely reduced.

Production of toxins by seed-infecting microorganisms may be important in reducing seed performance. *Alternaria tenuis*, a common resident of cottonseed, produces a toxin called tentoxin (Templeton *et al.*, 1967). This toxin causes a chlorosis of infected cotyledons (Fulton *et al.*, 1960) by specifically inhibiting chloroplast coupling factor 1 (Steele *et al.*, 1976). Affected seedlings fail to mature due to their failure to photosynthesize. Aflatoxins produced by fungi in the *Aspergillus flavus* group inhibit seed germination and chlorophyll synthesis (Dashek and Llewellyn, 1977). Other fungi found in cottonseed produce compounds which elicit various necrotic responses in plants, but their role in deterioration of cottonseed is unexplored.

The physiological role of microorganisms in deterioration of seeds during weathering is frequently more subtle than in the examples discussed above and is poorly understood, partly because the processes involved in deterioration are poorly understood. Also, it is impracticable to obtain adequate samples of seeds or ripened cotton free of microorganisms to permit definitive determination of the relative roles of processes of seed and microbial origins. Our ignorance in this area can lead to erroneous assumptions, often evident, but seldom stated, in published work on seed deterioration. As an example of the confusion which can arise, I will discuss the process of lipolysis.

To determine the biological basis for lipolysis in deteriorated (weathered) cottonseed, we can consider the following known evidence: (1) Both deterioration and growth of microorganisms in seeds require moisture (normally in excess of 12 percent on a seed wet weight basis) (Roncadori *et al.*, 1971; Simpson and Stone, 1935); (2) essentially all deteriorated seeds are infected by microorganisms (Haloïn, 1981a; Roncadori *et al.*, 1971; Simpson *et al.*, 1973); (3) frequently, embryo tissues are not infected until after some deterioration has occurred, but tissues surrounding the embryos are heavily infected (Haloïn, 1975a); (4) both the embryos and the infecting microorganisms are capable of producing lipid degrading enzymes (Mayne, 1956; St. Angelo and Altschul, 1964); and (5) many of the infecting microorganisms produce a variety of metabolites during saprophytic growth, which have diverse toxic effects on plant tissues (Dashek and Llewellyn, 1977; Fulton *et al.*, 1960). Given this evidence, it is impossible to reach an incontestable conclusion as to the biological basis for lipolysis; seed processes, microorganismal processes or both working in concert. All seem likely. I suspect that lipolysis and various other processes involved in deterioration are a result of the joint action of seed and microbial systems.

Cottonseed contain a variety of broad spectrum antibiotic compounds including terpenoids (Haloïn and Bell, 1979), flavanols (Haloïn, 1982), flavanol glycosides (Blouin and Cherry, 1980) and cyclopropenoid fatty acids which may have an auto destructive role in seed deterioration during weathering. However, such a role for these compounds is largely unexplored. Glanded cottonseed contain the

terpenoid aldehyde gossypol localized within lysigenous glands. Under extremely moist conditions, cottonseed also synthesizes nonglandular terpenoid aldehydes in a phytoalexin-like response (Halloin and Bell, 1979). That glandular terpenoids are not involved in autodestructive processes is suggested by the fact that glanded and glandless cottonseed exhibit no apparent differences in their susceptibilities to weathering (Halloin *et al.*, 1978). Flavanols and nonglandular terpenoids, however, have been shown to be casually associated with necrosis of cotton tissues (Mace and Bell, 1981). Terpenoids, flavanols, flavanol glycosides and their oxidation products also may contribute to the discoloration (Allschul, 1948; Blouin and Cherry, 1980) observed in weathered cottonseed.

## RESISTANCE TO AND AVOIDANCE OF WEATHERING

The possible contributions of the various antibiotic constituents of cottonseed to resistance to weathering have not been explored. The only documented mechanism of resistance to weathering in cottonseed is an impermeable seed coat (Christiansen and Justus, 1963; Christiansen *et al.*, 1960; Mayne *et al.*, 1969). The hard or impermeable seed coat, common in wild cottons, prevents 1) moisture uptake by seeds, 2) infection of seeds by microorganisms and 3) deterioration of seeds. It has disadvantages for use in cultivated cotton, however, as hard seeds require scarification (either mechanical or solvent) which may damage the embryos or increase their vulnerability to infection by microorganisms in the soil. Additionally, residual, nonharvested seeds can produce volunteer cotton for years following cropping with a hard seeded variety (Endrizzi, 1974). Several reports have documented differences among cotton cultivars in their susceptibility to seed deterioration and to infection by microorganisms (Arndt, 1945a; Bourland and Ibrahim, 1980b; Brown *et al.*, 1975; Cabangbang and Covar, 1978; Leffler, 1980a; McMeans *et al.*, 1977; Simpson and Stone, 1935), but factors accounting for these differences have not been determined.

Avoidance of exposure of cottonseed to moist conditions through timely harvesting has long been known and continues to be the best way to circumvent weathering damage of planting seed. Scott (1979) proposed specialized production of cotton planting seed as a primary crop, with fiber yield on that crop being given secondary consideration. He felt that with production in favorable locations and timely harvesting, the economic return from increased seed value and subsequent plant performance would outweigh any loss in fiber yield.

## SUMMARY

Weathering of cotton planting seed involves processes, usually deteriorative, occurring between the time of boll opening and harvesting. These changes normally result in decreases in germination, seedling vigor and yield potential of the

subsequent crop. The physiological bases of the deteriorative processes are poorly understood. Weathering occurs only when seeds are exposed to moisture and probably involves systems of both seed and microbial origin. Timely harvesting of cotton to avoid prolonged exposure to moisture is the best means of avoiding weathering.

## Chapter 32

# HARVEST AND POST-HARVEST FACTORS AFFECTING THE QUALITY OF COTTON PLANTING SEED AND SEED QUALITY EVALUATION

James C. Delouche  
Mississippi State University  
Mississippi State, Mississippi

## INTRODUCTION

A uniform, vigorous stand of cotton is the first major milestone in an economically successful cotton production program. Obtaining such a stand is also among the first of a host of problems that beset the cotton producer. Stand failures or poor stands can result from any one or a combination of factors and their interactions: poor seed bed preparation, low soil temperature, mechanical impedence from crusting, excessive or deficient soil moisture, soil microorganisms and other pests, chemical injury and low quality seed (Delouche, 1969). Low quality seed are probably a major contributing factor in most stand failures, for they are much more susceptible to adverse conditions in the seed bed environment and will usually produce a satisfactory stand only under very favorable conditions. Unfortunately, the quality of cotton planting seed available to producers is relatively low as compared to other crops such as corn, wheat and even soybeans, while conditions at planting time are relatively more adverse.

The quality of cottonseed is affected by an array of factors which can be grouped into two categories: pre-harvest factors and harvest, post-harvest factors (Colwick *et al.*, 1972; Gelmond, 1979; Presley *et al.*, 1967). The pre-harvest factors affecting the quality of cotton seed have been reviewed in Chapters 30 and 31. This paper considers the harvest and post-harvest factors or operations that can affect the quality of cottonseed for planting and the present status of seed quality evaluation and assurance.

The quality of cottonseed can be affected by harvesting procedures and all of the subsequent operations involved in handling, removal of the fiber and preparation of planting seed for marketing. The latter includes: storage of seed cotton before ginning, handling of seed cotton and cottonseed, bulk storage (cottonseed), delinting, conditioning and treatment of the seed, and storage of conditioned,

packaged seed before and during distribution and marketing. The major types of damage to cottonseed during harvesting and post-harvest operations are mechanical damage, chemical injury and physiological deterioration resulting from high temperature and seed moisture levels, and their interaction. Mechanical damage and chemical injury, of course, have physiological consequences in terms of the performance of cottonseed as the reproductive units for the crop.

## MECHANICAL DAMAGE

The six-layered seed coat of cotton is thick, strong and slightly elastic (Simpson *et al.*, 1940). It provides much greater protection to the embryo than the relatively fragile and brittle seed coverings of other major crops, *e.g.*, corn, soybean, wheat, sorghum. Yet, mechanical damage of cottonseed is a major cause—directly and indirectly—of quality problems.

Mechanical damage to cottonseed probably began with the introduction of the mechanical fiber remover, or gin. While the “early” gins undoubtedly inflicted some injury, mechanical damage to cotton has become a major problem only in relatively recent times. Substantial mechanical abuse and injury of cottonseed is a product of mechanization, and its increasing seriousness has closely paralleled advancements in this sphere (Colwick *et al.*, 1972).

The advent of the mechanical picker introduced another potential source of seed injury. Since the vastly increased efficiency of mechanical harvesting overtaxed the capacity of conventional gins, better, more efficient and higher capacity gins had to be developed. High capacity ginning greatly increased the potential of the gin as a source of injury. Since accelerated operations in the gin yard require high capacity handling and conveying systems, the potential for injury to the seed was further increased.

From another direction, more advanced mechanization of planting and cultural practices, combined with the development of better varieties and higher seed costs, created a rising demand among planters for seed with better flowability characteristics that could be effectively treated and planted more precisely at lower rates per acre. Mechanical delinting or reginning is one method of improving the flowability of cottonseed. It became an accepted practice, and yet another source of injury was added. Acid delinting is an even better method of improving the flowability of cottonseed, and it has become the dominant method of delinting. While acid delinting does not cause mechanical injury *per se*—only incidentally in the conveying systems involved—it has complicated quality problems by permitting direct contact of a very reactive chemical with embryonic tissue through breaks in the seed coat.

The incidence of mechanical damage to cottonseed varies among locations, seasons and producers. In a survey of the quality of cottonseed planted in Mississippi in 1964, Helmer (1965b) found that about 70 percent of the lots planted had mechanical damage levels (percent damaged seed) of 5 percent or higher (Table 1).



Table 1. Incidence of mechanical damage in 738 lots of cottonseed planted in Mississippi in 1964 (From Helmer, 1965b).

Mechanically damaged seed (%)	No. of samples	Percent of total
Damage level:		
0-5	233	31
5-10	301	41
10-5	139	19
Over 15	65	9

Table 2. Effect of mechanical picking on the incidence of cracked seed and germination in Carolina Queen cotton (From Colwick *et al.*, 1972)

Year	HP	Picker treatment <sup>1</sup>		
		PDO	S1ST	S2ST
Percent visibly damaged seed				
1965	0.1	6.3	—	20.8
1967 <sup>2</sup>	6.1	12.9	14.4	44.6
1968	0.4	4.1	3.9	7.7
Percent germination				
1965	94	90	—	87
1967	17	16	18	14
1968	87	87	86	82

<sup>1</sup>HP = hand picked; PDO = doffed on canvas without going through conveying system; S1ST and S2ST = through complete system at fan speeds of 1807 and 2,338 r.p.m., respectively.

<sup>2</sup>Harvesting delayed until February because of inclement weather.

Based on other evidence, Helmer's findings in 1964-65 appear to be rather low. In smaller surveys in 1967 and 1968 (Colwick *et al.*, 1972) damage averaged 14 percent. Reviews of the quality control records of several cottonseed companies indicate that damage levels of 10-15 percent among the lots handled are commonplace, while even higher damage levels are frequent enough to require careful selection of lots for acid delinting and treatment with some systemic insecticides.

## HARVESTING

On the basis of their studies of the effects of mechanical harvester damage on the germination and vigor of cottonseed, Douglas *et al.* (1965, 1967) concluded: mechanical harvesters (picker type) of certain designs cause severe damage to cottonseed; harvester damage was reflected in reduced germination and vigor:

seed of some varieties appeared to be less susceptible to harvester damage than others. In studies at Clemson University, Garner and associates (see Colwick *et al.*, 1972) found that several factors affected the percentage of seed coats cracked in mechanical harvesting and that reduced germination was associated with the incidence of cracked seed (Table 2). The percentage of cracked seed increased with an increase in fan speed in the picker. Severe weathering which delayed harvesting in one year decreased the resistance of the seed to picker damage. Apparently, weathering erodes the mechanical strength of the seed coat. Weathered soybean seed are also more susceptible to mechanical damage (Green *et al.*, 1966).

Harvester damage to cottonseed appears to be more of a problem in arid, irrigated production areas. Miller (1967) reported that pickers cracked 18-25 percent of the seed produced in California under contract for his company before quality control procedures were used to reduce the damage level to 3-5 percent. The main sources of damage in the cotton picker are high picker speeds, doffing, blowing (conveying) and impact of the seed cotton against the top of the basket. High speed movies of doffing revealed two causes of damage at the doffing position (Colwick *et al.*, 1972): pinching of the seed between the spindle and the doffer and tearing off fragments of the seedcoat as a result of competition of adjacent spindles for the same boll. In the same study, fan speed and blade design (radius of curvature) had the greatest influence on seed damage. A fan speed of 2,300 r.p.m. caused two to four times as much damage as a fan speed of 1,800 r.p.m.

Miller emphasized the importance of proper maintenance and adjustment of the picker and close monitoring of individual pickers. Baskin *et al.* (1972) described field modifications that can be made in various makes of pickers to reduce the incidence of seed coat cracking.

## GINNING AND MECHANICAL DELINTING

The ginning operation—especially saw ginning—is an important cause of damage to cottonseed. Moore and Shaw (1967) point out that ginning damage to cottonseed was evident on acid delinted seed in 1934 linter content studies at the U.S. Cotton Ginning Research Laboratory, Stoneville, Mississippi. This was in the days when gin saws were mostly 12 inches in diameter and were operated at speeds of only 300 to 400 r.p.m. Damage levels in those times, however, were rather low.

Extensive studies of gin damage to seed in Louisiana and Mississippi were conducted by Watson and Helmer (1964) in 1963. Seed cotton and cottonseed samples were drawn from 30 bales at each of seven gins. Six of the gins utilized high capacity equipment. Moisture content of the seed cotton averaged 11.0 for the 210 bales and exceeded 12 percent (12.3 percent) at only one gin. The incidence of seed damage in the seed wagon, which can be attributed to mechanical harvesting, ranged from 2.7 to 5.9 percent among the gins with an overall

average of 4.2 percent. Seed damage was increased by about one percent during seed cotton cleaning, drying and associated conveying up to the feeder. Ginning contributed an additional 5 percent to the total mechanical damage of the seed. Although seed cotton moisture was mostly below 12 percent, Watson and Helmer demonstrated a fairly consistent trend of seed damage increase with increases in seed moisture content (Figure 1). Seed damage also increased as ginning rate increased, while germination—as might be expected—decreased as the percentage of damaged seed increased (Figure 2).

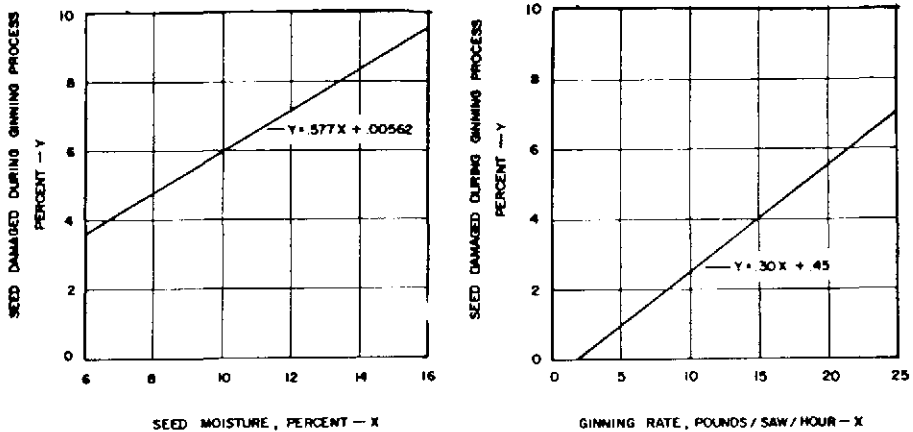

Figure 1. Effects of seed cotton moisture content (left) and ginning rate (right) on mechanical damage to cottonseed (from Watson and Helmer, 1964).

In a similar follow-up study (Moore and Shaw, 1967) in California in 1964, mechanical damage to the cottonseed averaged 10.7 percent. Harvesting (5.0 percent) and ginning/handling (5.7 percent) contributed equally to the total damage. Other, more comprehensive and controlled studies (Moore and Shaw, 1967) at the U.S. Cotton Ginning Research Laboratory, Stoneville, MS, during the period 1964-66 established that: there is considerable variation in the amount of damage inflicted to cottonseed at gin plants; average damage levels of 16-17 percent are not uncommon in a gin-run cottonseed; the spindle-type cotton harvester contributes about 44 percent of the damage, ginning about 44 percent, while about 12 percent is contributed by the drying, overhead cleaning and conveying systems for seed cotton; the action of the gin saw causes a major portion of the seed damage at gin plants; increasing feed rates of seed cotton into the gin stand increases seed damage. The incidence of seed damage also increased as seed moisture decreased, which is in disagreement with earlier results (Watson and Helmer, 1964) and other data from Texas which suggested an opposite relationship between the percentage of damaged seed and seed cotton moisture content.

Mechanical delinting is essentially a reginning operation, except the saws are

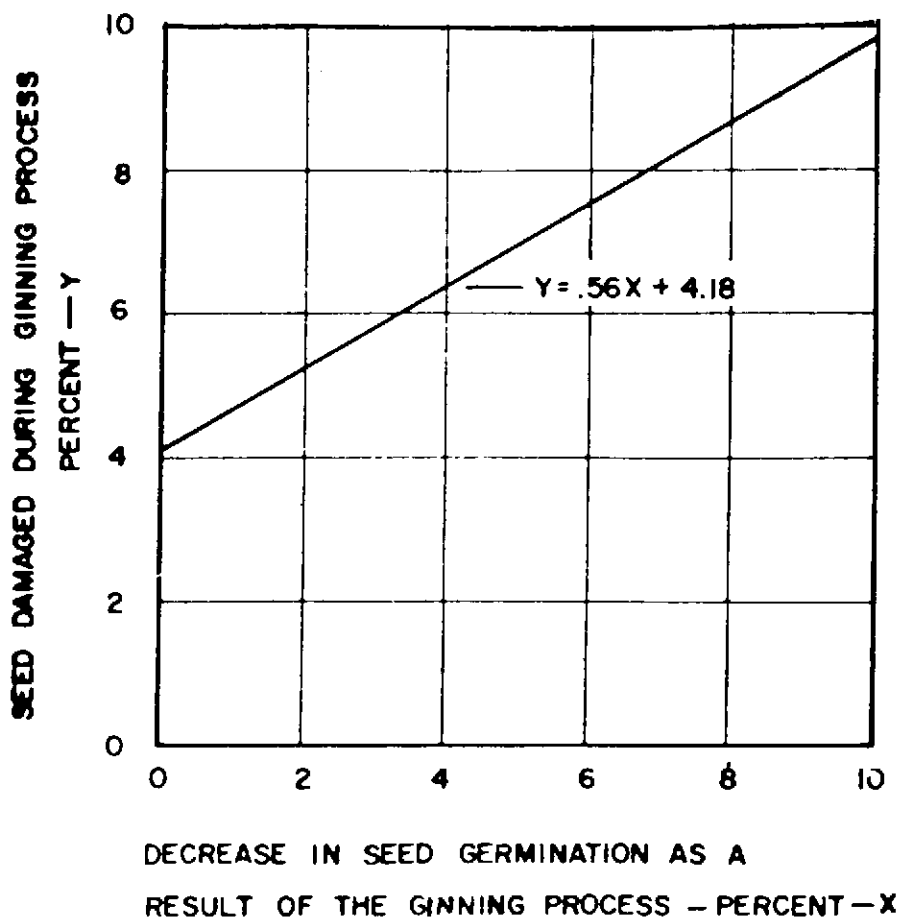

Figure 2. Relationship between seed damage during ginning and reduction in germination percentage (from Watson and Helmer, 1964).

finer and more closely spaced. It reduces the amount of linters on the seed and improves their flowability. Generally, only one cut, i.e., pass through the delinting stands, is made for planting seed. Mechanical delinting always adds a couple of points to the percentage of damaged seed. Close gauging of the ginning saws, incautious delinting and double cut delinting can inflict considerable damage to the seed. The conveying and handling systems in the mechanical delinting plant are other potential sources of seed injury.

Harvester and conveying/handling damage can usually be distinguished from gin saw damage by close visual examination of a sample of acid delinted seed. Typically, seed damaged during harvesting and conveying exhibit cracking or fracturing of the seed coat. Fragments of the seed coat are often missing, exposing

the embryo, but the fractured edges are straight. Gin saw-damaged seed, on the other hand, exhibit cuts or deep gashes in the seed coat with enrolling of the cut edges.

## HANDLING AND CONVEYING

Seed cotton and cottonseed are handled many times from harvesting through packaging of the seed for marketing. The pneumatic seed cotton handling system in the mechanical harvester is a major source of harvester damage, especially when the seed cotton is conveyed through the fan (Douglas *et al.*, 1967; Miller, 1967). At the gin and seed house, several types of conveyers are used. Pneumatic conveyors are used to handle both seed cotton and cottonseed (Shaw and Franks, 1964; Stedbronsky, 1964). Belt conveyors are often used to transport cottonseed from under the gin stands to a pneumatic line intake, while screw conveyors are used to convey cottonseed, gin trash and some seed cotton (Alberson, 1964). Pneumatic and belt conveyors have the advantage for planting seed of being essentially self-cleaning (Franks and Oglesbee, 1957; Shaw and Franks, 1963); thus, varietal mixing in multi-variety gins is minimized. Screw conveyors have to be thoroughly cleaned to prevent mixtures, but this task can be facilitated by fitting drop bottoms to U-trough types.

In the delinting and conditioning plant, cottonseed are conveyed by pneumatic, screw and belt conveyors, and by belt-buckle elevators. Improperly maintained and operated screw conveyors can cause substantial damage to seed, but the major source of damage in conveying/handling operations is the pneumatic conveyor. Pneumatic conveyors are very damaging to other kinds of seed and are seldom used (Metzer, 1961a).

Miller (1967) reported that under California conditions the most significant source of damage (15-20 percent) at the gin plant was pneumatic conveying of the cottonseed from the seed scale to the seed storage pad. Conveying distance in some cases was as far as 300 feet. Using good quality-assurance procedures, Miller and colleagues were able to reduce seed damage during pneumatic conveying to less than 2 percent. This was accomplished by eliminating all 90 degree elbows, rubberizing long-sweep elbows, reducing air velocity to the minimum that conveyed the seed without plugging, and replacement of 5 inch piping with 6 inch piping. Watson and Helmer (1964) found that the percentage of damaged seed rapidly increased with successive passes through a pneumatic conveying system.

## MECHANICAL PROPERTIES OF THE COTTONSEED COAT

Several studies have been made to determine the mechanical properties of the cottonseed coat. Kirk and McLeod (1967) reported that the total energy absorption to rupture of the cottonseed coat was relatively constant at 0.70 in.-lb, although the force (pounds/seed) required to rupture cottonseed and the resulting seed deformation under static loading decreased as seed moisture content increased from 6 to 14 percent. Seed damage from impact velocities increased

rapidly above 4000 f.p.m. and was as high as 50 percent at 8000 f.p.m. In contrast to static energy tests, seed moisture content had no effect on seed damage due to impact.

In a more detailed study of the effects of static loading and energy on cottonseed germination, Chang *et al.* (1967, see also Colwick *et al.*, 1972) found that cottonseed were more easily damaged, i.e., reduced in germination, when a static load was applied to the ends of the seed than when an equivalent force was applied to the sides of the seed. The maximum force that could be applied to the sides of high quality cottonseed (97 percent germination) without reducing germination below 80 percent was 26, 25 and 13 pounds/seed for cottonseed at 4, 8 and 12

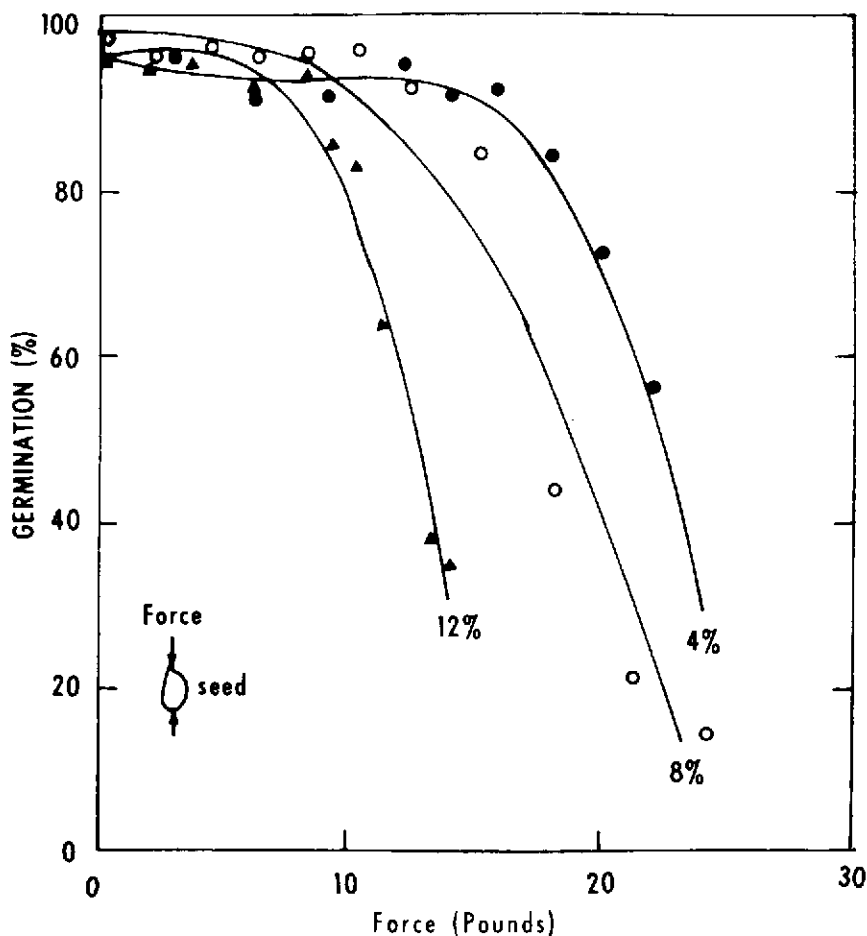

Figure 3. Effect of static loading with seed oriented longitudinally (end-to-end) on germination of cottonseed at 4, 8 and 12 percent moisture content (from Colwick *et al.*, 1972).

percent seed moisture, respectively. When the load was applied to the ends of the seed, the maximum force for maintaining 80 percent germination was 18, 14 and 10 pounds/seed at 4, 8 and 12 percent seed moisture, respectively (Figure 3). In terms of energy absorption, the maximum static energies the high quality seed could withstand without a reduction in germination below 80 percent were 0.34 in.-lb. on the sides and 0.20 in.-lb. on the ends. These levels are lower than the 0.70 in.-lb. reported by Kirk and McLeod (1967). The latter, however, observed only deformation and rupture of the seed coat and did not consider the effect of static energy on germination.

In dynamic impact studies, Clark *et al.* (1969, also Colwick *et al.*, 1972) found that impacts of equivalent force were more damaging to germination on the radicle end of the seed than the chalazal end or sides, which were least damaging.

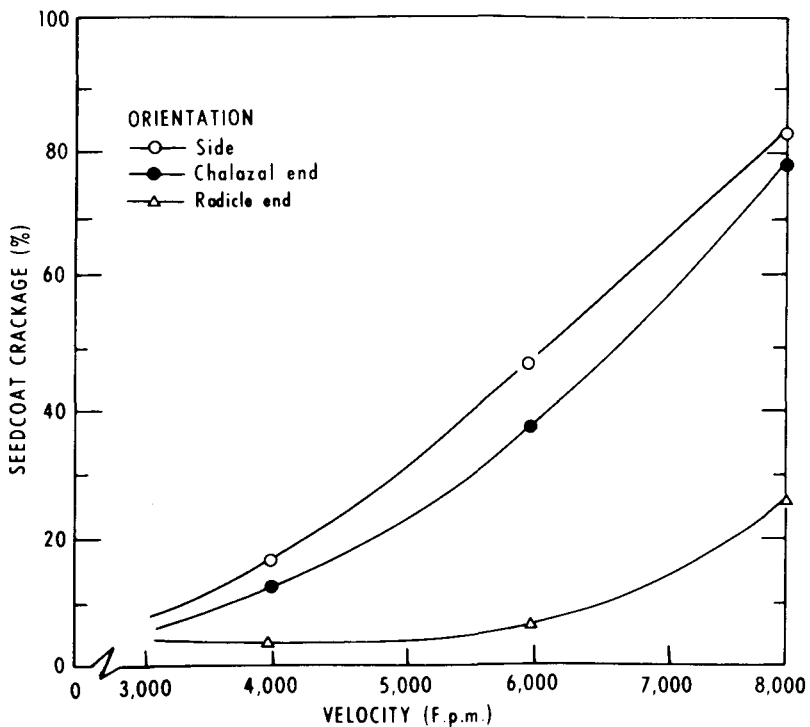

Figure 4. Effect of impact velocity and seed orientation on seed coat crackage of Coker 100 cottonseed over all moisture contents (4 to 12 percent) (from Clark *et al.*, 1969).

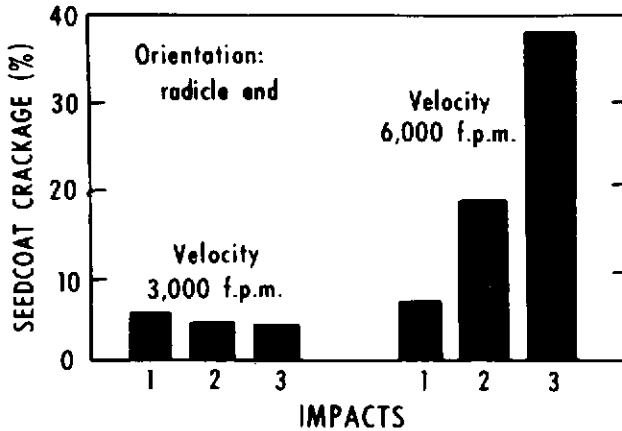

Figure 5. Effect of number of impacts at two impact velocities on seed coat crackage of Stoneville 213 cottonseed at 10 percent moisture content (from Clark *et al.*, 1969).

The seed were most resistant to impacts at seed moisture contents between 9 and 12 percent regardless of seed orientation. At moisture contents within this range, 6500 f.p.m. was the maximum velocity the seed could withstand without reducing germination below 80 percent. Above and below the 9-12 percent seed moisture range, the maximum velocity was about 4500 f.p.m. Although germination was most affected by impacts on the radicle end, impacts on the sides of the seed caused the greatest incidence of crackage of the seed coat (Figure 4). At impact velocities of 3000 f.p.m. successive impacts did not increase damage. However, damage increased rapidly with successive impacts at 6000 f.p.m. (Figure 5). In terms of energy absorption, slowly applied (static) loads were more detrimental to germination than impact forces at levels above 3 in.-oz (Figure 6).

Colwick and associates (1972) studied impact damage in a 90 degree elbow in a pneumatic conveying system and showed that there was very little crackage of the seed below 6000 f.p.m. regardless of stage of weathering of the seed. Cottonseed at 12-13 percent moisture were most resistant to impact damage.

On the basis of the results of the several studies discussed above and other observations, minimal air velocities (4000-5000 f.p.m.) should be used for pneumatic conveying of cottonseed, 90 degree elbows should be replaced with long-sweep turns and conveyor piping should be at least 6 inches in diameter.

The mechanical strength of cottonseed under static loading indicates there is little possibility of damage from high stacking of bulk or packaged seed. Much more fragile kinds of seeds (Associated Seed Growers, Inc., 1942; Huelsen and Brown, 1952) are also not injured by static loads in stacks. The static loading data for cottonseed, therefore, are most applicable to such actions as pinching of the



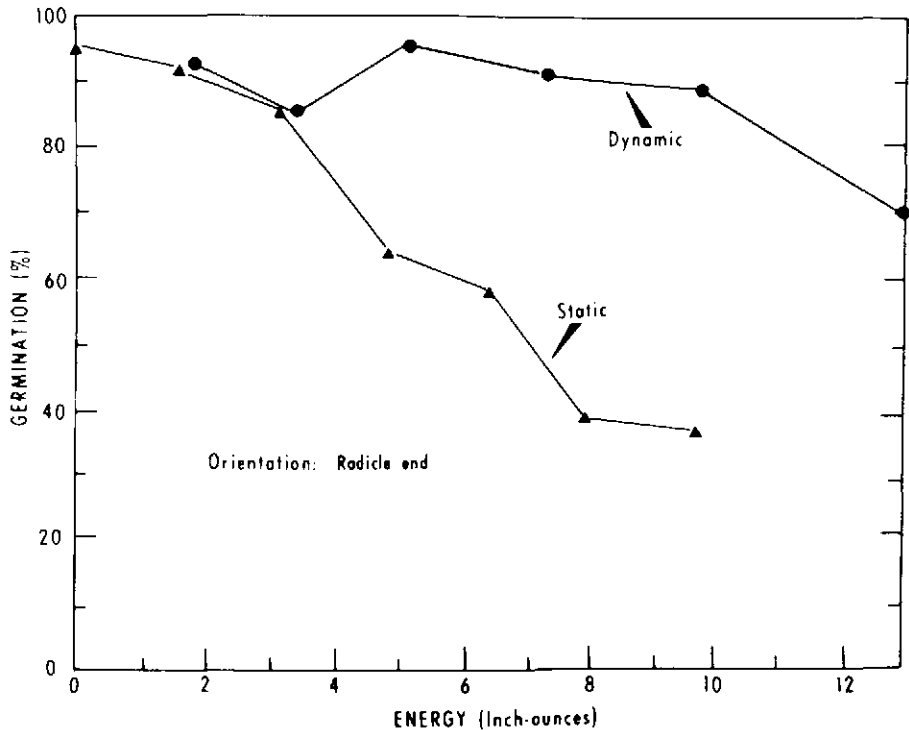

Figure 6. Effects of static and dynamic energy absorption on germination of Stoneville 213 cottonseed at 12 percent moisture content (from Colwick *et al.*, 1972).

seed between spindle and doffer, and transport of seed by screw conveyors. Overall, the mechanical properties of the cottonseed are superior to those of some other kinds of seed (Leonhardt *et al.*, 1961; Perry and Hall, 1965).

### CONSEQUENCES OF MECHANICAL DAMAGE

Mechanical damage of seed has direct and indirect effects, both of which can have immediate and latent consequences. Severe damage or damage in a vulnerable area such as the radicle can result in an immediate loss of the capacity to germinate (Associated Seed Growers, Inc., 1942; Atkin, 1957; Keith, 1972; Klein and Harmond, 1966; Toole and Toole, 1951). Less severe injury produces seedling abnormalities (Atkin, 1957; Spreafico, 1965) and reduces storage life, vigor and field emergence potential (Colwick *et al.*, 1972; Koehler, 1957; Wortman and Rinke, 1951). The indirect effects of mechanical damage are often as important as the direct effects. In the soil, damaged seed are more susceptible to seed rotting

microorganisms which gain easy entry to necrotic tissue through cuts or fractures in the seed coat (Erwin *et al.*, 1964; Koehler, 1957; Oatout, 1928). Mechanically damaged seed are also more susceptible to processes and materials used in preparation of seed for marketing. In acid delinting of cottonseed, cuts in the seed coat expose the embryo to the acid, causing acid burn (Colwick *et al.*, 1972). Damaged seed are often injured by chemical seed treatments such as the formerly widely used organic mercurials (Roane and Starling, 1958; Sakolnik, 1948) and some of the systemic insecticides applied to cottonseed (Colwick *et al.*, 1972).

Studies at our laboratory in the late 1960's (Colwick *et al.*, 1972) on the effects of mechanical damage on the quality of cottonseed produced the following conclusions: in damaged seed, necrosis is initiated in embryonic tissue beneath cuts and fractures; germination and storability decreases as the incidence and severity of mechanical damage increases; the detrimental effects of acid delinting (conventional wet-acid process) increase as the incidence of mechanical injury increases; treatment of damaged seed with fungicides improves laboratory germi-

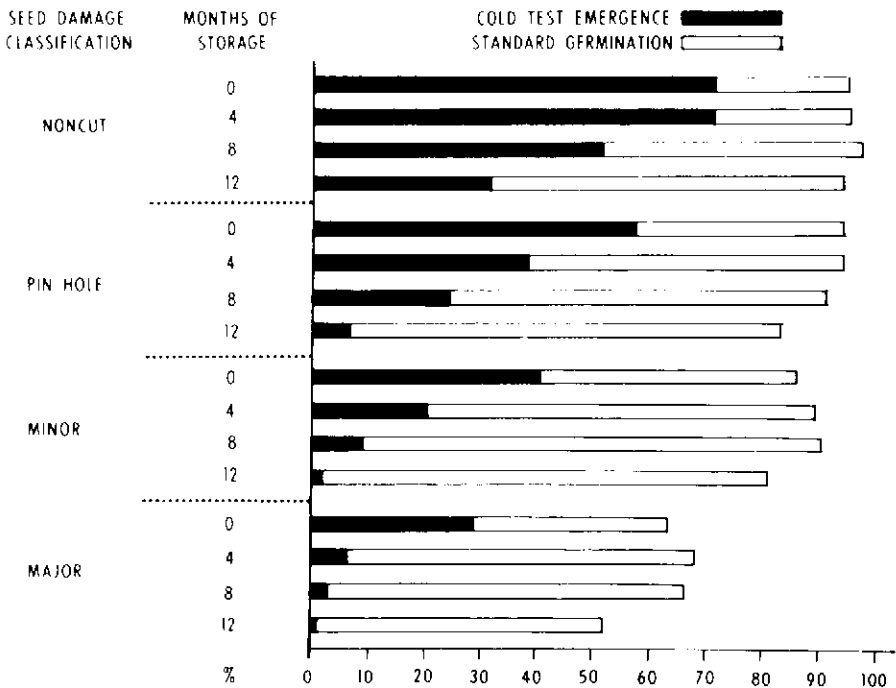

Figure 7. Effects of seed damage level over all treatments on germination percent and cold test emergence percent of cottonseed after 0-12 months warehouse storage (from Colwick *et al.*, 1972).

nation, cold test and field emergence; in commercially processed seed lots, three in four minor-damaged seed, one in three major-damaged seed, and one in five immature seed are capable of germinating; x-ray analysis can be used to rapidly assay gin-run seed for immature and empty seed, but only a small portion of the mechanical damage can be detected.

Typical responses of mechanically damaged seed over several combinations of seed treatments (fungicides and systemic insecticides) in germination and cold tests at intervals during storage are shown in Figure 7. Germination of minor- and major-damaged seed in these tests was higher than indicated in the "conclusions" above. The latter, however, represented the averages for a very large number of commercially processed seed lots.

## DELINTING

The linters that remain on cottonseed after ginning become entangled, causing the seed to clump. Since gin-run seeds do not singulate and the flowability is very poor, cleaning, upgrading and accurate metering in planting operations are difficult to impossible. Various methods have been and are used to singulate the seed and improve flowability. Most of the methods involve partial or complete removal of the linters and tags, but a variety of coating procedures have also been tried without much success—technically or economically (Mezynski, 1966; Webber and Boykin, 1907).

Mechanical delinting is the traditional process for improving the flowability of cottonseed. As discussed previously, mechanical delinting is basically reginning with finer and more closely spaced saws to remove a portion of the linters, which have commercial value.

Mechanical delinting improves flowability of the seed, but not sufficiently for the precision conditioning operations required to separate despined cockleburrs and immature, low density seed (Bunch *et al.*, 1961; Mezynski, 1966). Plantability is also improved, but precision of metering is less than for smooth, readily flowable seed. The major effect of mechanical delinting on seed quality—other than improvement of flowability—is mechanical damage, which was discussed earlier.

The limitations of mechanical delinting in terms of improvements in flowability led to the development of supplemental or other methods for partial or complete removal of the linters. Flame delinting is used to effect further improvement in the flowability of mechanically delinted seed. Several acid delinting processes are used to remove the linters completely, or more recently, partially.

### FLAME DELINTING

In flame delinting (flame "zipping") mechanically delinted seed are dropped through an intense flame to singe or burn off loose linters. Flowability is substantially improved, but again not sufficiently for precision cleaning and conditioning

operations. Properly designed and managed flame zippers have little, if any, effect on seed quality. However, since the seed are heated passing through the flame and by the burning linters, rapid "de-sparking" and cool-down of the seed are critical. If these tasks are not accomplished effectively and rapidly, the seed can be severely damaged by heat. I know of several cases where several hundred tons of good quality cottonseed were ruined for planting purposes by flame delinting. In most of the cases, new installations were involved and start-up, check-out testing was inadequate. Modifications were made which eliminated the problem.

### ACID DELINTING

Three major types of acid delinting systems are in use (Jones, 1980): wet-acid, gas-acid and dilute wet-acid. The first two systems produce lint-free seed with excellent flowability, while the latter process produces lint-free "black" seed or partially—but uniformly—delinted seed. All of the acid delinting systems can reduce seed quality, if not properly controlled and managed.

**Gas-acid Process**—The gas-acid delinting process is mostly used in arid areas where moisture content of cottonseed is less than 9 percent and low humidity reduces corrosion of the equipment and facilities. Anhydrous hydrochloric acid is

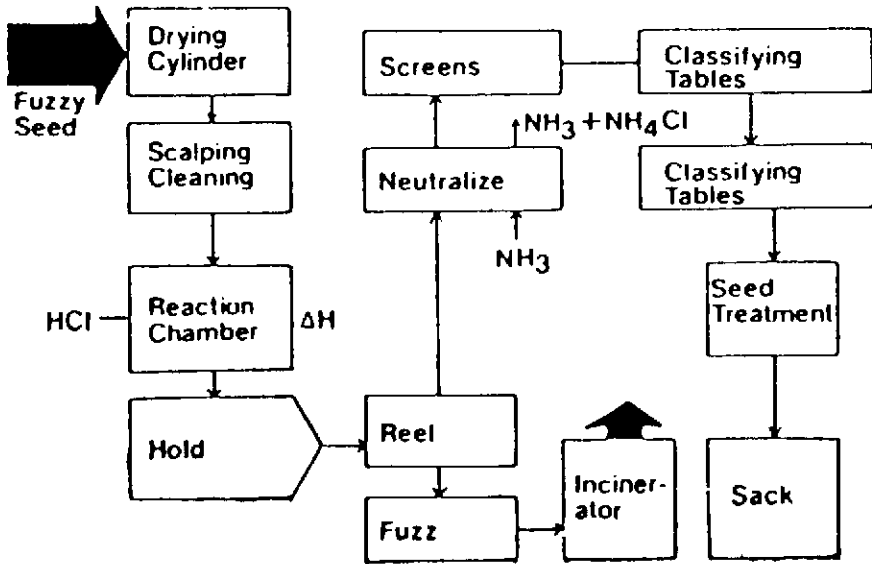

Figure 8. Generalized flow chart for commercial gas-acid delinting of cottonseed (from Jones, 1980).

used to degrade the linters so that they can be removed from the seed by frictional forces (Jones *et al.*, 1974). A generalized scheme of the gas-acid process is shown in Figure 8.

The seed are first dried as needed to reduce moisture content to 5-7 percent, then rough cleaned to remove gross contaminants. A charge of seed is then placed in a rotating reaction chamber where the temperature is raised to 60-70C before injection of the gas-acid at a concentration of 0.5-2.0 percent of seed weight. Reaction time varies from 5 to 20 minutes, depending on the temperature, seed moisture content, concentration of the gas-acid and variety. After exit from the reaction chamber, the seed pass through a reel where frictional forces complete removal of the degraded linters. Neutralization is usually accomplished with ammonia. The lint-free, readily flowable seed can then be cleaned, density graded, treated and packaged as efficiently as other kinds of seed.

The gas-acid delinting process requires fairly sophisticated equipment, close monitoring and stringent control of the various operations for effective delinting without injury to the seed. The major causes of injury to the seed are too high a reaction temperature and gas-acid concentration, too long a reaction time and "over" neutralization with ammonia. Poorly controlled and managed gas-acid delinting can cause a drastic reduction in germination and vigor.

**Wet-acid Process**—The wet-acid delinting system is favored in humid, rainfed areas of the cotton belt. The process is relatively simple and does not require

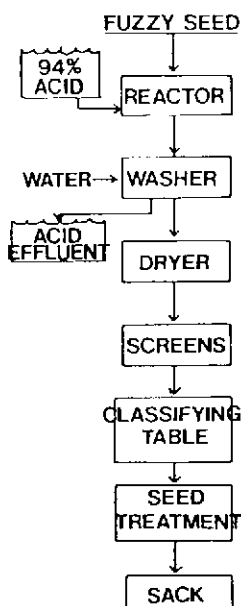

Figure 9. Generalized flow chart for the conventional wet-acid delinting process for cottonseed (from Jones, (1980).

sophisticated equipment (Figure 9). Gin-run seed are fed into a reactor trough or tank and mixed with concentrated sulfuric acid. From the reaction trough the seed are passed through washers where the residual degraded linters and acid are washed off. Since the seed are wet they have to be dried before moving to the cleaning, grading, treating and packaging line.

Seed quality losses in the wet-acid delinting process can occur when reaction time is longer than necessary, seed temperature rises too high during drying, the seed delinted are low in vigor, and the incidence of mechanical damage is above 12-15 percent.

The major problem in wet-acid delinting—apart from the high cost of sulfuric acid—is disposal of the spent acid and wash water. In earlier days the effluent was usually dumped in a stream. This easy solution has been eliminated by environmental concerns and regulations (Sigman, 1973). The alternative solution of collecting the effluent in a sort of sewerage lagoon also poses environmental problems.

**Dilute Wet-acid Process**—The dilute wet-acid delinting process was developed by Cotton, Inc. (Jones, 1980; Jones and Slater, 1976). The process differs from the conventional wet-acid process as follows (Figure 10): a dilute solution of sulfuric

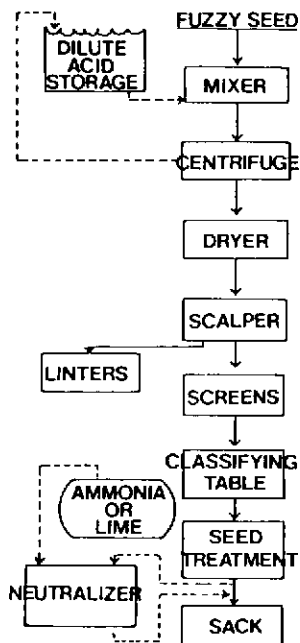

Figure 10. Generalized flow chart for dilute-sulfuric acid delinting of cottonseed (from Jones, 1980).

acid (about 10 percent) is used instead of concentrated sulfuric acid to wet the linters; the wet seed are "dewatered" by centrifugation to about a 10 percent add-on level of the dilute acid; the seed are dried with heated air to evaporate water, thus, increasing the concentration of the acid; the degraded linters are removed by frictional forces in a rotating buffer-drum; neutralization of residual acidity is accomplished by ammonia or adding lime in the seed treatment process. The advantages of the dilute wet-acid delinting process are a great reduction in the quantity of sulfuric acid required because of the much lower quantity used and the recovery of a major portion in dewatering, and elimination of the effluent produced in wet-acid delinting. In addition, the hydrolyzed linters removed during buffing have potential value in ethanol production and as an animal feed additive.

The basic dilute acid delinting process has been modified in several installations. In one case the centrifuge has been eliminated. Most plants produce two kinds of delinted seed: lint free or black seed and partially delinted seed. Partial delinting is accomplished by further reduction of the acid concentration.

The relatively recent introduction of the dilute wet-acid delinting process has not permitted much time for thorough assessment of its potential effects on seed quality. It is claimed that the dilute wet-acid process has little, if any, effect on mechanical properties or permeability of the seed coat. Quality problems that arise appear to be mostly associated with heat damage during the drying cycle.

#### ACID DELINTED VS. MECHANICALLY DELINTED SEED

There has long been controversy about the relative merits of acid delinted and mechanically delinted cottonseed, especially in the humid portions of the cotton belt. Cotton producers concede that acid delinting greatly improves plantability, but many contend that acid delinted seed are more susceptible to environmental stresses in the seedbed, *e.g.*, cold and wet, than mechanically delinted seed. The production of partially delinted seed in the dilute wet-acid process is aimed at a rather large market that continues to discriminate against lint-free seed. The objections to acid delinted seed stated by Gore (1943) still holds in the minds of many farmers: "Our experiences with acid-delinted seed reveal that its high cost . . . and occasional failure to get a stand, more than offset its advantages."

Early interest in acid delinting of cottonseed was related to control of certain diseases. Duggar and Cauthen (1911) reported that the percentage of cotton bolls infected with "boll rot" or anthracnose was reduced from 11.3 to 5.9 percent by "charring" the seed coat with concentrated sulfuric acid before planting. Other workers (Archiblad, 1927; Brown, 1933; Sherbakoff, 1927; Young, 1942) reported on the beneficial effects of acid delinting for the control of various diseases. Chester (1938, 1940, 1941) found that acid delinting and gravity grading of cottonseed practically eliminated "internally-infected" seed and increased the rate of emergence, thus, shortening the period of susceptibility of the seed to *Rhizoctonia*. He believed that the latter response was the reason for the wide-

spread acceptance of acid delinted seed in the Southwest, where *Rhizoctonia* is very prevalent. Conversely, he attributed the low level of acceptance of acid delinted, gravity graded seed in humid areas of the cotton belt to the effectiveness of organic mercurial seed treatments in control of the prevalent seedling disease organisms in the area, *Glomerella gossypii* and *Fusarium moniliforme*.

The general experience has been that acid delinted seed do not store as well as gin-run and mechanically delinted seed (Colwick *et al.*, 1972). In terms of the effects of acid delinting on germination and emergence, the initial quality of the seed appears to be the controlling factor. Seed low in vigor and with a high incidence of mechanical damage are more adversely affected by acid delinting than high quality seed (Colwick *et al.*, 1972).

A review of quality control records of several cottonseed companies in the late 1960's revealed that in the Mississippi Delta area emergence percentages of acid delinted seed were slightly lower than those of mechanically delinted seed. Similar results were reported by Minton and Quisenberry (1980). On the other hand, Marani and Amirav (1970) stated that acid delinting improved and accelerated germination and emergence by increasing the permeability of the seed coat, and Garber and Hoover (1973) reported that acid delinted seed produced stands

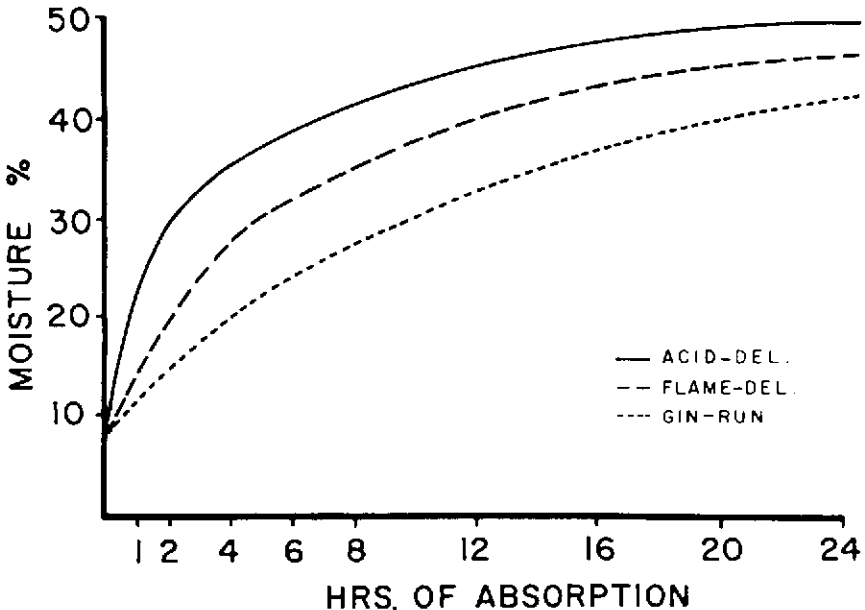

Figure 11. Effect of delinting method on rate of moisture absorption by cottonseed (from Helmer, 1965a).



similar to those produced by mechanically delinted seed, even though 13 percent less seed were planted.

Bourland and Ibrahim (1980) evaluated three methods of acid delinting—dilute acid, concentrated acid, and water-plus acid—in combination with several drying procedures. Delinting and drying methods had no influence on speed of germination and mold growth on the seed at a cool temperature. Acid delinting also increases the exudation of amino acids from hydrolyzed portions of the seed coat (Lewis, 1969b). This apparently has little significance except in tests where free amino acid exudation is used as an assay of quality.

Helmer (1965a) made a detailed comparison of the laboratory and field performance of gin-run, flame delinted and wet-acid delinted sublots taken from the same lot of seed. The acid delinted seed absorbed moisture, germinated and emerged (in the field) more rapidly than flame delinted seed which, in turn, responded more rapidly than gin-run seed. In soil tests involving two soil types, optimum and suboptimal temperatures, and several soil moisture tensions, the acid delinted seed performed better than flame delinted or gin-run seed. Illustrative responses from Helmer's studies are shown in Figure 11 and 12.

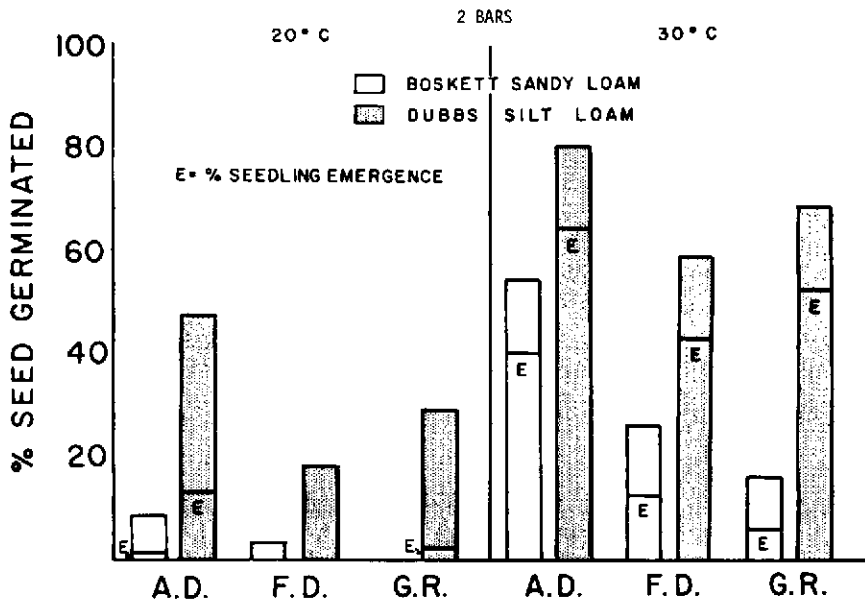

Figure 12. Effects of delinting method on germination and emergence of cottonseed in two soil types at 2 bars moisture tension at 20 and 30°C. A.D., F.D. and G.R. refer to acid delinted, flame delinted and gin run seed, respectively (from Helmer, 1965a).

## CONDITIONING

Cottonseed are conditioned—cleaned, graded and treated—to the extent possible after delinting to prepare them for marketing. The poor flowability characteristics of mechanically delinted and flame-zipped seed severely constrains the efficiency and effectiveness of cleaning operations and essentially precludes grading.

The concentration of despined cockleburs, which are a troublesome contaminant, can be reduced in mechanically delinted, flamed seed with cylindrical screen length/width separators but usually not enough to meet certification standards for cocklebur contamination (Bunch *et al.*, 1961; Mezynski, 1966). Separation of immature seed, which often constitute a relatively large percentage of the lot by number and are of low quality, is virtually impossible.

Complete removal of the linters by acid delinting transforms cottonseed into singulated, readily flowable "particles", which can then be cleaned and graded with considerable precision. Despined cockleburs can be completely removed with a gravity separator because they are much lower in density than cottonseed. A very high percentage of cockleburs can also be removed with a length grader, because they are generally longer than cottonseed (Mezynski, 1966). Most importantly, however, lint free seed can be density graded with a gravity separator to upgrade germination and vigor.

The close association of seed density and quality in cottonseed has been recognized for many years (Arndt, 1945; Chester, 1938, 1940; MacDonald *et al.*, 1947; Porterfield and Smith, 1956; Webber and Boykin, 1907) and well documented in the last 15-20 years (Bartee and Krieg, 1974; Dave *et al.*, 1971; Ferguson and Turner, 1971; Gregg, 1969; Johnson, 1970; Justus, 1965; Krieg and Bartee, 1975; Minton and Supak, 1980; Peacock *et al.*, 1971; Tupper, 1969; Tupper *et al.*, 1971; Turner and Ferguson, 1972; Wilkes, 1969). The subject is discussed in Chapter 33 and has been extensively reviewed by Tupper (1969) and Tupper *et al.*, (1971) in previous papers. Here I will only briefly summarize the detailed studies made in our laboratory by Gregg (1969) in 1968-69.

Nineteen lots of cottonseed, representing the important varieties in the Mississippi Delta area, were acid delinted (wet-acid process) in a commercial plant and gravity graded into 10 density fractions according to discharge positions from a gravity table separator. Standard bulk density of the density fractions over all lots ranged from 33 lb./bu. to over 47 lb./bu. Standard germination, accelerated aging and cold test responses, and field emergence increased as bulk density of the seed increased up to about 46 lb./bu. (Figure 13), while free fat acidity increased as bulk density decreased (Figure 14). Gregg recommended discard of seed below 42 lb./bu. for an "average" quality product and discard of seed below 44 lb./bu. for premium seed.

Presently, the gravity table is the most practical machine for density separation and upgrading of acid delinted cottonseed. The aspirator, especially the fraction-

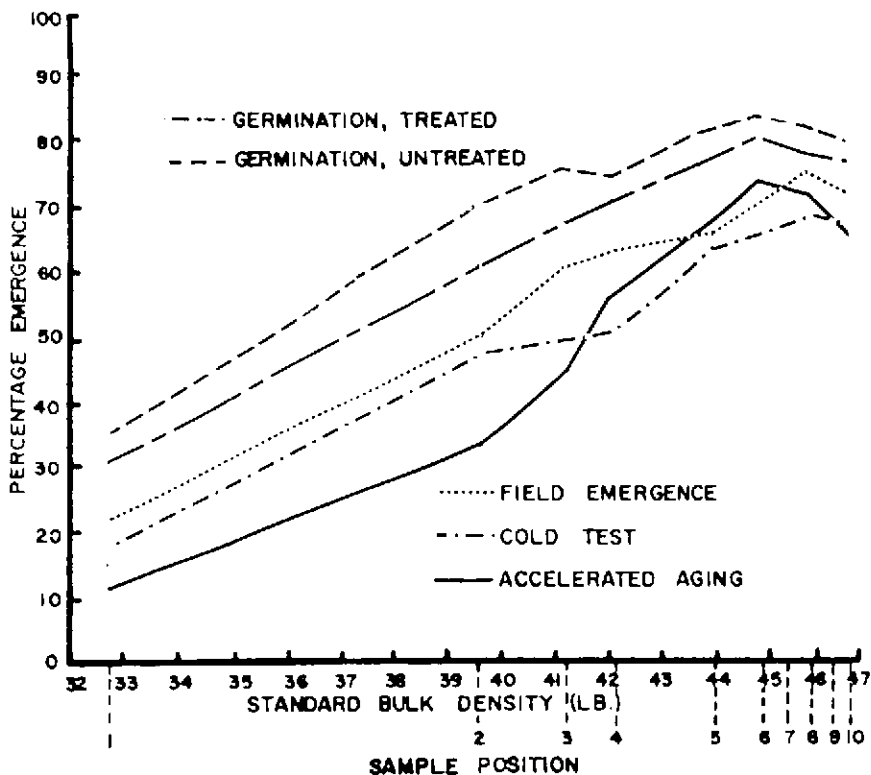

Figure 13. Effects of bulk density (lb./bu.) of acid delinted cottonseed on germination, germination after accelerated aging, cold test and field emergence. Data are averages of 19 seed lots. Sample position refers to 10 equidistant areas along discharge end of an Oliver Model 50 gravity table (from Gregg, 1969).

ating aspirator, does separate the seed on the basis of density but not with the precision of the gravity table (Lai, 1972).

After gravity grading the remaining steps in conditioning are treatment of the seed with fungicides and insecticides and packaging. Seed treatment has a positive effect on performance of the seed, except in cases where there is an adverse reaction to some of the systemic insecticides. Packaging has no effect on the seed quality unless seed moisture content is high and the packages relatively impervious to diffusion of water vapor.

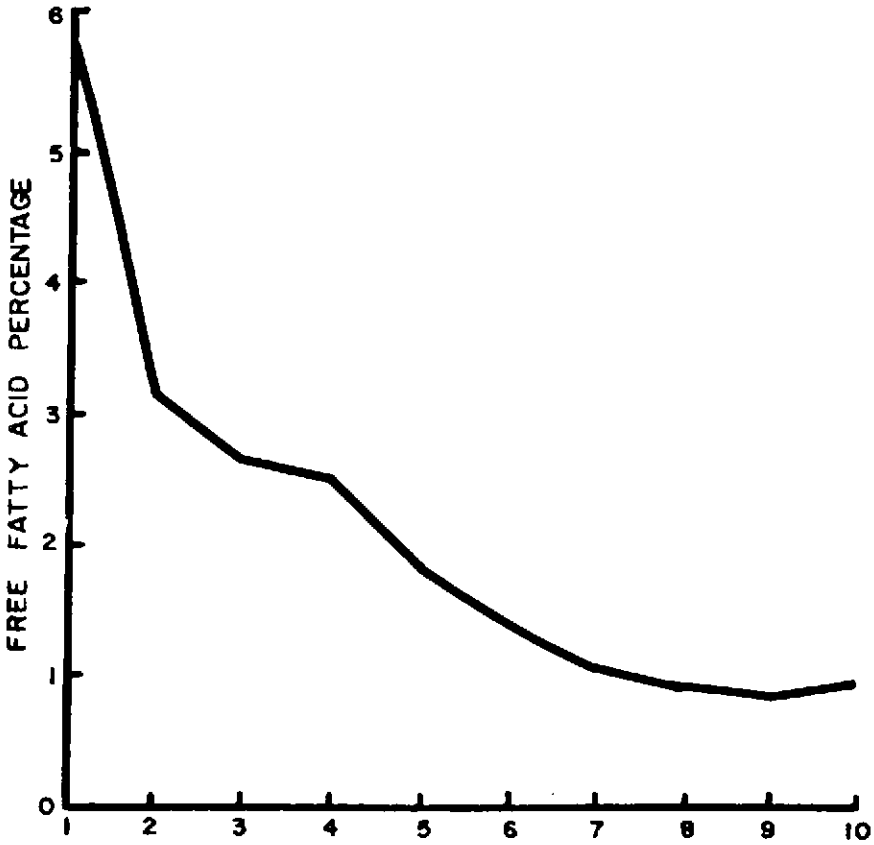

Figure 14. Relationship of free fatty acids in cottonseed (avg. of 19 seed lots) to sample position along discharge end of an Oliver Model 50 gravity table. Bulk density ranged from 33 lb./bu at sample position 1 to 47 lb./bu. at sample position 10 (from Gregg, 1969).

## STORAGE

The total storage period for cottonseed encompasses three distinct phases. The first phase is seed cotton storage from harvest to ginning. It is a critical phase because cotton is harvested under a variety of conditions, and the period of storage can be rather long. Deterioration of the seed cotton is relatively high due to heating in the mass of seed cotton. Sorenson (1973) and Colwick *et al.* (1972)

determined the following "safe" storage periods for seed cotton at various moisture contents packed at densities of 7-12 lb./cu. ft:

Seed cotton moisture (%)	Safe storage period (days)
8-10	30
10-12	20
12-14	10
14-15	3

The introduction of the module and other devices for field storage of seed cotton before ginning added another dimension to the problem of seed deterioration. Drastic reductions in seed quality have been reported.

After ginning, the gin-run cottonseed are conveyed or transported to a seed house for storage in bulk until they are delinted and conditioned. Considerable reduction in quality can occur in the huge piles of cottonseed when seed moisture content is too high and/or the seed are not adequately aerated to even out moisture and reduce the temperature in the seed mass. In the Mississippi Delta area, cottonseed companies summarily divert cottonseed at 12 percent moisture or higher to the oil mill. It is too difficult and expensive to dry the seed under the prevailing humid conditions. Seed quality problems associated with storage of seed cotton and bulk cottonseed are discussed in Chapter 33.

Good quality conditioned, packaged cottonseed store surprisingly well—much better than other kinds of oil seeds. Simpson (1935b) found that sea-island and upland cottonseed deteriorated rapidly after two years in "ordinary storage" at James Island, South Carolina. Seed at 8 percent moisture stored in tin containers to prevent reabsorption of moisture showed little deterioration after 4.5 years, while seed at 13.7 percent moisture were all dead in nine months. In subsequent studies, Simpson (1946) demonstrated the great influence of climatic conditions on longevity of cottonseed. He produced a single lot of seed at Jackson, Tennessee, subdivided the lot for various treatments (gin-run, gin-run treated with 2 percent "Ceresan", acid delinted, and acid delinted treated with 2 percent "Ceresan") and shipped samples from each subplot for storage at seven locations ranging from Jackson, Tennessee to Baton Rouge, Louisiana. Germination trends over all treatments for the seven-year storage period are shown in Figure 15. Storage life was shortest—as might be expected—at Baton Rouge, the warmest and most humid location. Acid delinted seed stored about as well as gin-run seed at all locations. Germination of Ceresan-treated seed was higher than untreated seed for the various storage periods, but Simpson properly attributed this response to the control of fungi during germination rather than to any effect of the chemical on rate of deterioration during storage. In the same paper, Simpson reported on the germination of samples of cottonseed stored in unsealed containers at Saca-

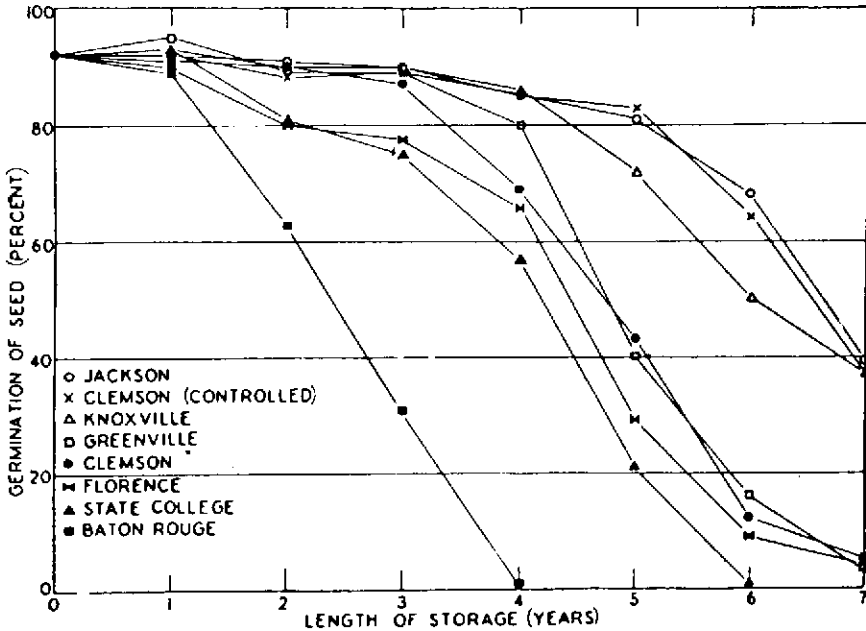

Figure 15. Germination percentages of cottonseed after periods of warehouse storage at eight locations (from Simpson, 1948).

tion, Arizona, for 6 to 35 years. The oldest sample that contained germinable seed (6 percent) had been in storage for 25 years. Many samples 15-20 years old germinated above 40 percent—a few above 80 percent. Stewart and Duncan (1976) brought the latter study up to date in 1976. Seed stored in Sacaton, Arizona, from the year of production ranging from 1925 to 1938 until 1945 under open conditions, then at Knoxville, Tennessee in sealed containers at 21C from 1945 to 1957, and finally at near 0C from 1957 to 1974, were evaluated for germination in 1974. The oldest viable seed lots were produced in 1929 and had a maximum germination of 68 percent in 1974 (after 45 years). Cottonseed at College Station, Texas in a sealed container at 10C germinated 92 percent after 16 years, while seed stored at room temperature in sealed glass and paper envelopes germinated 66 and 8 percent, respectively, after 6 years (Table 3). In California, 17 samples of seed with average germination of 84 percent were stored for 10 years at Shafter in a metal warehouse (Towers and Harrison, 1949). Average germination after 10 years was 15 percent.

The general experience of seed companies is that good quality cottonseed maintains germination for 18-24 months with some reduction in vigor. In some

cases, storage for 2-3 years appears to improve field performance under stress conditions (Taylor and Lankford, 1972).

Table 3. Germination percent of cottonseed stored under different conditions at College Station, TX, for periods up to 20 years (From Beckholt *et al.*, 1969).

Condition	Years					
	0	4	6	11	16	20
10C-scaled	92	96	80	86	92	41
Rm. temp.						
Sealed glass	92	95	66	0		
Paper env.	91	88	8			

## SEED QUALITY

The quality of a lot of planting seed is determined—and established—by several factors and/or characteristics: the varietal and physical purity of the lot; the physical condition, germinability and vigor of the seed; the types and incidence of seedborne microorganisms; and the types and uniformity of applied seed treatments. In cotton, varietal purity can be assured through careful and systematic varietal maintenance, seed multiplication and production practices, and by well established quality assurance procedures such as field and facility inspections, one variety seed farms, gins and storehouses. The several types of delinting procedures in use are adequate for conditioning gin-run seed into a readily flowable, singulated product which can be cleaned, density graded, uniformly treated and planted with considerable precision. Cleaning equipment and density separators are available to remove physical impurities and contaminants, and most immature, rotten and other low density seed. Modern seed treaters can apply one, two or more fungicides and insecticides simultaneously or in sequence at controlled dosages just before packaging for storage and marketing.

Considering the array of quality assurance procedures, processing technology and facilities presently available for the production and conditioning of cottonseed there is little reason for quality problems related to varietal and physical purity, contaminants, physical condition of the seed, and—to a lesser degree—seedborne microorganisms. Problems that do arise in these areas can usually be attributed to lapses in quality control, poor management and/or inadequate facilities and can be resolved by appropriate corrective actions. The one problem which continues to elude a satisfactory resolution relates to the germination, vigor and stand producing potential of the seed. Indeed, much of the technology used to produce, harvest and condition the large quantities of cottonseed needed for

planting in an efficient manner, and which has made possible the resolution of other quality problems, has aggravated the germination/vigor problem as discussed in previous sections.

The causes of cottonseed germination and vigor problems are well known: indeterminate habit of the plant; preharvest climatic conditions; mechanization of harvest and post-harvest operations; priority attention to lint rather than seed. Improvements in the germination and stand producing performance of cottonseed have been and are being made, but most cotton producers do not perceive these as sufficient for their needs. Judging from the voluminous literature on germination, vigor, stand establishment and related problems in cotton, many cotton researchers share the perception of cotton producers that further improvements are necessary.

"Getting a Stand" was the second of 20 areas considered in the Blueprint of Cotton Research developed by the National Cotton Council of America in the early 1960's. Tharp (1961) pointed out that, "The problems connected with 'getting a stand' spread across all phases of cotton production" . . . and, "present a challenge to research workers in all production disciplines—from the geneticist, who can improve the inherent quality of planting seed, to the agricultural engineer, who can preserve the quality during the harvesting and ginning operation." Seed quality improvement was highlighted as one of the broad opportunities for research. Specifically, Tharp felt that research was needed to: develop better methods for evaluating seed quality; improve properties of the seedcoat; identify genetic sources of "quality" for incorporation into commercial varieties; elucidate the biological/biochemical bases and mechanism of vigor, cold tolerance and resistance to seedling diseases; prevent or reduce field deterioration of the seed; and identify and develop chemical means for "preserving" vigor. Tharp's view have been echoed in later reviews and discussions of the cottonseed quality situation (Delouche and Baskin, 1970; Niles, 1967; Noggle, 1971; Presley *et al.*, 1967; Scott, 1979; Wilkes, 1970), and his strategy is reflected in the work of many researchers.

The economic consequences of low germination and vigor of cottonseed lots are difficult to assess because the quality of the seed planted is only one of the factors that affect stand establishment. Tharp (1961) estimated the annual loss attributable to "stand" problems at \$150 million in the early 1960's. More recently, Parvin *et al.* (1978) discussed the direct and indirect benefits that can be realized with high quality cotton planting seed. They pointed out, however, that redirection of breeding efforts to improve seed quality at the expense of lint yield and quality would not be a satisfactory solution.

## EVALUATION OF SEED QUALITY

Adequate methods for evaluating the physical purity of cottonseed lots have been developed and are in use. Quality assurance procedures in the production field, gin and conditioning plant are generally satisfactory in terms of maintain-



ing varietal purity, although there is need for more research and developmental work on methods for identifying varieties in the seed and seedling stage. The major problems in evaluation of cottonseed quality are in the areas of germination, vigor and timeliness.

**Germination.**—Germination of cottonseed is determined by the standard germination test (Association of Official Seed Analysts, 1983). Four replicates of 100 seed each are planted on moist paper towels, blotters or in sand and incubated at an alternating 20-30C or 30C temperature. A first or preliminary count is made after 4-5 days and a final count after 12 (20-30C) or 8 days (30C). The Rules for Seed Testing (Association of Official Seed Analysts, 1981) state that samples which do not respond to the usual method should be placed in a closed container with water and shaken until the lint is thoroughly wet, after which the excess moisture is blotted off. The latter recommendation is based on a suggestion by Toole and Drummond (1924). Test results are expressed as a germination percentage, which is further defined as the percentage of normal seedlings that develop during the test period. Criteria—mostly morphological—for normal seedlings are specified in the Rules.

Despite long-term use and periodic refinement, the standard germination test for cottonseed presents problems to seed analysts and seedsmen. Different laboratories frequently obtain widely varying results on seed from the same lot or portions of the same sample. Excessive variation in germination test results, even within the same laboratory, is also rather commonplace, with the result that much retesting is required. Seedsmen confronted with widely differing test results from different laboratories or the same laboratory have a rather shaky basis for labeling of seed lots.

Difficulties in germination testing of cottonseed have long been noted. Toole and Drummond (1924) reported that seed above 10 percent moisture content appeared to "mold" badly during testing, while seed at 5-6 percent moisture often exhibited some hardseededness which interfered with germination testing. They felt that conditions contributing to rapid germination produced the best and most consistent results.

Weir (1959) and Stanway (1960, 1962) compared the germination of many samples of cottonseed at 20-30C and 30C temperatures and concluded that while final germination percentages were not different at the two temperatures, germination was "completed" 2-5 days sooner at the higher, constant temperature. Arndt (1954a) and Bohorquez (1977) also reported that the optimal germination temperature for cottonseed is in the range of 30 to 33C. Stanway recommended that 30C be accepted as an alternate temperature for germination testing of cottonseed. Her recommendation was adopted in the mid-1960's.

McWilliams (1961) found that interpretation of germination test results could be made when the radicle was one-half inch in length with essentially the same results as evaluation at later stages of seedling development. Test results tended to

be more consistent because mold problems, which complicate interpretation, were avoided. Powell and Morgan (1973) developed a germination test system—the TAMU rapid germination test for cottonseed—which generally produced higher results than the standard germination test.

Excessive variation in germination test results of cottonseed—as well as other kinds of seed—is caused by many factors ranging from improper sampling to analyst fatigue. Better training and periodic workshops for analysts from cotton-belt laboratories would substantially improve the uniformity and reliability of germination test results for cottonseed. Additional research is also needed to determine the effects of substrate moisture content on germination of cottonseed. Although the Rules for Testing Seed give little attention to substrate moisture relations, observations indicate that excessive moisture can cause wide differences in test results.

**Quick Tests.**—During receiving and bulk storage operations, cottonseed producers often have to make almost immediate judgments of quality and important decisions based on these judgments. Methods are available for rapidly determining moisture content, contaminants and even mechanical damage. However, germination, which at this stage is of crucial importance, cannot be determined in less than 4 to 5 days. It is not surprising, therefore, that cotton seedsmen are extremely interested in any type of “quick test” for estimating germination percentage. One cottonseed company uses a “cutting” test. The seed are sampled and 50 to 100 seed are placed in a holder which permits rapid longitudinal bisection of the seed. The cut embryos are visually rated for “fullness” and color and an estimate of germination is made. The test takes about 15 minutes. On the average, the estimates are surprisingly close to germination percentage as determined by the standard test.

The tetrazolium test for seed viability is widely used in the cottonseed industry (Baskin *et al.*, 1972; Metzger, 1961). Experienced analysts can obtain reliable estimates of germination in 8 to 16 hours. The tetrazolium test is described and discussed in Chapter 33.

More recently there has been considerable interest in quick tests for viability based on the electrical conductivity of pre-conditioned seed or seed exudates (Anderson *et al.*, 1964; Bondie *et al.*, 1978; Brashears *et al.*, 1979; Hopper, 1981). This approach, in turn, is based on the work of Presley (1958), among others, which demonstrated a relationship between “protoplast” permeability and seed quality. The electrical conductivity or current flow methods are reasonably accurate in identifying very high or low quality seed but are often quite unreliable in predicting germination of seed in the medium quality range. McDaniel (1977) described a somewhat different method for estimating germination of cottonseed based on exudation of materials. Seed were soaked in water at 65-70C for one and one-half hours and the leachates “read” with a refractometer. Readings below 0.2 were considered indicative of good seed, while readings above 0.6 were considered indicative of poor quality seed.

Free fatty acids content is extensively used as a rough index of the quality of cotton planting seed. In the late 1940's, Hoffpauir *et al.* (1947, 1950) found that germination percentage decreased as the percentage of free fatty acids increased. Individual seed with over 1 percent free fatty acids (3 percent in extracted oil) did not germinate. They recommended that cottonseed saved for planting purposes have a free fatty acids content of less than 1 percent. Lewis (1969a), on the other hand, contended that the concentration of specific fatty acids was a more relevant parameter of quality than total free fatty acids. In any event, free fatty acids can only be used as a very rough index of quality. A few badly deteriorated seed in a sample can produce an alarmingly high free fatty acids concentration although the rest of the seed germinate vigorously. Conversely, a seed lot can germinate poorly—or not at all—even though free fat acidity is below 0.5 percent.

**Vigor.**—The deficiencies of the standard germination test as the measure of the physiological quality or stand producing potential of seed have long been recognized (Association of Official Seed Analysts, 1976; Delouche and Caldwell, 1960). The reasons for the deficiencies of the test have been discussed in detail by Delouche and associates (Delouche, 1969; Delouche and Baskin, 1970a, 1973b; Delouche and Caldwell, 1960). Basically, the deficiencies of the standard germination test derive from two sources: first, the dominant philosophy of germination testing has been, and is, optimization of results; secondly, the test methodology—including interpretation criteria—do not adequately take into account the progressive nature of seed deterioration.

Field conditions are seldom optimal for germination, emergence and seedling growth. The weaker seed that produce normal seedlings in the laboratory frequently succumb to stresses in the seed bed with the result that field emergence usually differs markedly from laboratory germination. This situation would not be too bad, if every lot of seed of the same variety and equivalent germination performed the same—albeit more poorly—under similar field conditions. A relatively simple calibration scale could be constructed to relate germinability to emergence for various types and degrees of environmental stress in the seed bed. Seed lots of the same variety and equivalent germination, however, often perform (emerge) quite differently when planted at the same time and under the same conditions in the field. These differential responses of seed lots to less than optimal conditions reflect different degrees of deterioration—or vigor—among the lots. Interpretation of the germination test focuses on loss of the capacity to germinate, which is the final practical consequence of seed deterioration. The lesser consequences of deterioration, which reduce rate of germination and seedling growth and the seed system's resistance to environmental stresses in the seed bed, are virtually ignored.

The deficiencies of the germination test are strikingly evident in the data presented in Table 4. Samples from 50 commercial lots of cottonseed labelled 80

percent germination were collected in the spring of 1967. The seed were tested for germination and 34 samples with actual germination between 80 and 85 percent were selected for field emergence tests in mid-April and mid-May. In the mid-April planting, emergence percentage (actually 18-day seedling survival) ranged from 80+ percent to less than 40 percent. Twenty samples emerged 60 percent or higher, while 14 samples emerged below 60 percent—5 below 40 percent. Emergence percentages in the mid-May plantings were higher, but five samples still emerged below 60 percent. Farmers who purchased the low emergence lots were surely disappointed and most likely blamed the poor stands or stand failures on the weather.

Table 4. Field emergence of 34 lots of cottonseed with germination percentages from 80-85 percent. Emergence tests made at Mississippi State University, Mississippi in 1967.

Date	No. lots with emergence percentage of:					
	80+	70-79	60-69	50-59	40-49	40-
Mid-April	1	8	11	6	3	5
Mid-May	6	10	13	2	2	1

Seed vigor, which has been a much researched and somewhat controversial areas for the past 20 years (Bridges, 1962; Delouche, 1976; Delouche and Baskin, 1973; Grabe, 1976), is a sort of reverse expression of deterioration. In a physiological sense—but not necessarily a genetic sense—seed vigor is highest when deterioration is minimal and decreases as deterioration progresses. In 1978 the Vigor Test Subcommittee of the Association of Official Seed Analysts (1978) defined vigor as follows: "Seed vigor comprises those seed properties which determine the potential for rapid, uniform emergence and development of normal seedlings under a wide range of field conditions."

Seed vigor is generally considered especially important in field emergence and stand establishment (Baskin, 1979; Bird and Reyes, 1968; Bishnoi and Delouche, 1980; Delouche, 1976; Delouche and Caldwell, 1960; Grabe, 1976). However, several investigators (Bishnoi, 1971; Delouche, 1969; Johnson, 1970; Peacock and Hawkins, 1970; Rajanna, 1972) presented evidence that the quality, i.e., vigor, of cottonseed planted can also affect plant growth, development and yield. Peacock and Hawkins (1970), for example, found that seed source affected lint yield in two varieties of cotton even though good stands were produced by the seed from different sources. The differences in yield must have been related to differences in vigor. In a study of the emergence and lint yield of cotton from seed produced under plant bug infestations, Hanny *et al.* (1975) observed that seed from different harvest dates produced significantly different yields which could not be related to stand and suggested that, "there are some yet unrecognized areas of planting seed quality where seed technologists and plant physiologists might study cotton yields."

A variety of vigor tests for cottonseed have been developed. Mahdi *et al.* (1971) modified the well known soil cold test for corn seed for use on cottonseed. Seed were planted in moist sterile sand and incubated at 6C for 4 days, followed by 4 days at 30C, after which the percentage of normal seedlings was determined. The test was capable of differentiating among seed lots but probably confounded vigor with susceptibility to chilling injury during the early stages of germination (Buxton *et al.*, 1976a; Christiansen, 1964, 1967; Cole and Christiansen, 1975). Another variation of the soil cold test is used by several laboratories (Bishnoi and Delouche, 1980). The seed are incubated for 3 to 5 days at 13C in soil at 60 percent moisture saturation followed by 4 days at 30C, after which the percentage of normal emerged seedlings is determined.

Christiansen (1961) developed a method for measuring epigeous seedling growth rate (in cotton) based on the rate of transfer of cotyledonary dry weight to the axial parts of the seedling. He advocated use of the method for selection for genetic vigor and as a bioassay for evaluation of the effects of certain treatments. The dry weight transfer test, however, has not been very effective in identifying lots with high emergence potential (Buxton *et al.*, 1977b).

The electrical conductivity of exudates or leachates from cottonseed has been used to assess vigor as well as to predict or estimate germination (Bishnoi and Delouche, 1980; Halloin, 1975b; Hopper, 1981; Presley, 1958). Results have been mixed. The tetrazolium test discussed previously as a quick test for viability is also used to evaluate vigor (Association of Official Seed Analysts, 1976; Baskin, 1979; Delouche and Baskin, 1970). It is a very powerful and reliable test in the hands of an experienced quality assurance specialist (see Chapter 33).

The most widely used vigor tests for cottonseed are the tetrazolium test and the cool germination test, i.e., Texas Cool Test (Association of Official Seed Analysts, 1976; Baskin, 1979; Rejanna, 1972; Wiles, 1960). The cool germination test is similar to the standard germination test except that a temperature of 18C is used rather than 20-30C or 30C, and the percentage of normal seedlings 1½ inches or longer (hypocotyl and radicle) is determined after 6 to 7 days, respectively, for acid delinted and mechanically delinted seed. The tetrazolium and cool germination tests were selected for refinement and standardization by the Association of Official Seed Analysts (1976, 1983).

Other methods developed, used or advocated for evaluating cottonseed vigor are based on seedling vigor classification criteria (Association of Official Seed Analysts, 1976, 1983), rate of seed respiration (Bishnoi, 1971), rate of germinative responses following accelerated aging (Baskin, 1979; Bishnoi and Delouche, 1980; Bollenbacher *et al.*, 1963; Delouche and Baskin, 1973) and germinative responses following rapid release of a vacuum pulled over immersed seed (Bridges, 1962; Metzger, 1961b).

Vigor tests are not and cannot be designed to predict field emergence, because the environmental conditions and stresses in the seed bed cannot be predicted. But, they are extremely useful in identifying high quality seed lots which have a

high potential for successful stand establishment under a wide range of field conditions, or low quality lots which should not be used for planting. Vigor tests are also very efficient in establishing the relative quality of seed lots received, in inventory and marketed. They are most effectively used to supplement the quality information obtained from germination and other quality tests.

## DORMANCY

When planted under conditions favorable for germination, dormancy is manifested as the complete failure of the seed to germinate, a slow rate of germination or as an increased specificity of the conditions required for germination. At least two mechanisms of dormancy appear to be involved.

Simpson (1935a) noted that seed from freshly opened bolls (1-5 days) of several upland varieties remained ungerminated and sound after 28 days in a germinator. Seed harvested from bolls opened longer than 5 days germinated better but at a much slower rate as compared to seed from storage. Drying and storage of freshly harvested seed for about one month practically eliminated the dormant conditions. Hsi and Reeder (1953) also found that dormancy was most intense in seed extracted from freshly opened bolls and dissipated 21 to 30 days after boll opening. The intensity of dormancy also appears to increase as date of boll opening increases (Christidis, 1955).

In some lots of cottonseed, dormancy persists for much longer than a few weeks after harvest. Seed analysts frequently encounter seed dormancy problems during the heavy testing season from January to April. Generally, the problem—dormancy—can be eliminated by drying the seed at 40C for a few days before testing or by germinating them at 30C rather than 20-30C. Taylor and Lankford (1972; see also Reynolds, 1968) reported a type of “secondary” dormancy which persisted for 3 years and which was manifested as an increased sensitivity of the seed to low germination temperatures and salinity.

The type of dormancy discussed above is not caused by impermeability of the seed coat to water. The seeds readily absorb water. Rather, this type of dormancy appears to be related to inhibition of germination by abscisic acid (ABA) (Davis and Addicott, 1972; Halloin, 1976a). ABA content in the developing boll and seed increases rapidly from 30 to 40 days after anthesis, then declines in the seed but continues to increase in the carpel wall until boll opening (David and Addicott, 1972; Guinn, Chapter 12). Helmer and Abdel-Al (1965) found that dormancy in Deltapine 15 cottonseed was most intense (0 percent germination) 40 days after anthesis (DPA) and was rapidly released during boll opening a few days later. Since excised embryos germinate in the later stages (Berkey, 1974; Dure, 1975), ABA is probably concentrated in the seed coat. Although Trelease *et al.* (Chapter 29) suggested that the postulated mechanism of ABA inhibition of germination should be revised, they felt that the concept that ABA prevents vivipary should be preserved.

that dormancy was most intense about 48 DPA—the boll cracking stage. Some seed harvested at 28, 30 and 32 DPA germinated when planted fresh but rotted within a few days when dried before testing for germination. Injecting distilled water in developing bolls 34 DPA stimulated germination of seed harvested 40 DPA. Injections of gibberellin and kinetin singly and in combinations were not any more effective than distilled water. Seed from bolls detached from the plant 30 DPA and “cultured” for 10 days in White’s solution germinated above 88 percent as compared to 0 percent for seed from 40-day bolls. Seed extracted from 40-day bolls germinated 50 percent in atmospheres of 60 or 100 percent oxygen, as compared to 0 percent in a normal atmosphere. Removal of the seed coat or excision of a portion of the seed coat at the chalazal end promoted prompt and complete germination. In a very tedious experiment, Berkey removed the various layers of the seed coat by abrasion. Germination was dramatically increased when the inner pigment layer was disrupted. On the basis of this and other responses, he concluded that dormancy in cottonseed was at least partially conditioned by a restriction imposed on oxygen absorption by the hydrated inner pigment layer of the seed coat.

Another type of mechanism of dormancy in cotton is water impermeability of the seed coat, or hardseededness (Christiansen and Moore, 1959). Hardseededness has been reduced to a very low level in modern cotton varieties by conscious or unconscious selection. It is much more prevalent in the primitive strains and in the relatives of cotton such as okra and weedy malvaceous species. Lee (1975) reported that hardseededness in cotton was caused by two genes whose concerted action determined the level or degree of water impermeability of the seed coat in interaction with environmental conditions during seed development and maturation. Halloin (1976b), for example, found that oxidative processes during ripening are necessary for development of seed coat impermeability. Exclusion of oxygen during this state increased permeability and prevented “cementing” together of the various layers of seed coat. Hardseededness can be overcome by time, mechanical and acid scarification, hot water treatment and electrical treatments (Stone *et al.*, 1973). The potential benefits of dormancy in terms of resistance to field weathering and adverse storage conditions are discussed in the next section.

## IMPROVING SEED QUALITY

Several approaches for improving the quality of cottonseed are available. Better management based on a rigorous quality assurance program can greatly reduce seed quality losses sustained during the various operations, as previously discussed. Positive programs, designed to take full advantage of the quality upgrading capability of density separators and to identify and market premium quality seed lots, would be well accepted by farmers, even with substantially

higher seed prices. The information/technology bases are sufficiently developed for full exploitation of these avenues for improving the quality of cottonseed available to cotton producers.

Other approaches for improving cottonseed quality are in the idea or beginning stages and considerable research and developmental work will be required to advance them even to the pilot-scale evaluation stage. Two approaches, which have good potential and are receiving considerable attention, are enhancement of quality (and performance) through conditioning treatments and procedures and genetic improvements in the physical and physiological characteristics of the seed.

The work of Christiansen (1964, 1967, 1969) and others (Buxton *et al.*, 1976a; Cole and Christiansen, 1975) on chilling injury to cottonseed during imbibition and the early phases of germination have pinpointed periods of sensitivity to low temperatures and identified several desensitization treatments. Since low seed bed temperatures are often associated with stand failures, efforts have been made to improve germination and emergence of cottonseed at cool temperatures through various conditioning or desensitizing treatments. Seed imbibed at 30-31C for several hours followed by drying, or seed elevated in moisture content to 14 percent or higher in a humid atmosphere, are very resistant to low temperature injury under laboratory conditions (Christiansen, 1969; Christiansen and Thomas, 1971; Cole and Wheeler, 1974; Cole and Christiansen, 1975; Fowler, 1979). Responses in field tests, however, have been negative or variable (Buxton *et al.*, 1977a; Fowler, 1979; Krzyzanowski, 1980; Wanjura and Minton, 1974). Similarly, pre-conditioning treatments with various phytohormones such as gibberellin and kinetin have not usually been beneficial under field conditions (Buxton *et al.*, 1977a; Shannon and Francois, 1977).

Although pre-plant hydration and other pre-conditioning treatments have not produced consistently beneficial results under field conditions, the approach appears to be worthy of additional exploration. Controlled hydration or osmotic priming, as reported by Heydecker *et al.* (1973, 1975) for "invigorating" seed, are especially interesting approaches. The permeation or infusion techniques utilizing organic solvent systems to in place phytoactive chemicals in seed also need further evaluation for cotton (Halloin, 1977; Khan *et al.*, 1976).

Singh and Singh (1972) reported that pre-planting soak treatments of *G. aboreum* seed with succinic acid (0.01 percent) increased stand, plant growth and yield. Calcium treatment of field deteriorated cottonseed produced seedlings that were healthier and more vigorous than those from untreated seed. More recently, McDaniel and Taylor (1979) found that treatment of Pima cottonseed with buffered adenosine monophosphate improved germination and emergence. The benefits of the AMP treatment was greatest under disease or cold stress conditions. Gas plasma (glow discharge) radiation of cottonseed increased rate of germination and early seedling growth in the laboratory but not in the field (Webb *et al.*, 1964, 1966). The effects of radiation treatments are probably



attributable to an increase in permeability of the seed coat to water.

There are substantial opportunities for improvement of inherent characteristics or properties of cottonseed associated with improved quality or which contribute to maintenance of improved quality during the pre-harvest and post-harvest periods. Although much of the work has been directed at improving the processing of cottonseed (Kohel, 1978a), some efforts are underway to improve the planting quality as well. There is genetic variability in cotton for tolerance to low temperature during germination (Buxton and Sprengler, 1976) which might be related to isocitratase activity (Scholl, 1974, 1976).

El-Zik and Bird (1969) reported that final seedling stand was inherited and that improvements in this important characteristic through breeding appeared to be possible (see Chapter 35). In a somewhat different connection, Bird *et al.* (1979) used resistance of the seedcoat to molds and a reduced rate of germination at 13C as key traits for selection for multi-adversity resistance to stresses in the seedbed.

Christiansen and Moore (1959) pointed out the potential of hardseededness in cotton for maintenance of seed quality. Followup work (Christiansen and Justus, 1963; Christiansen *et al.*, 1960) demonstrated that hardseededness was especially effective in reducing field deterioration of the seed. One cultivar (LA 901) of cotton with a high degree of hardseededness has been released. The demonstrated benefits of hardseededness in maintenance of seed quality have stimulated similar effort for other kinds of seed (Potts, 1978; Potts *et al.*, 1975). McDaniel (1979) suggested that selection for a thicker palisade layer in the seed coat of cotton might increase its mechanical strength, thus, decreasing some types of mechanical damage.

Much more effort is needed to identify seed and seedling traits associated with superior quality and performance. In this connection, the continuing efforts and progress (Wanjura and Buxton, 1971, 1972) in simulation of cotton germination and emergence should be helpful.

## SUMMARY

The quality of cotton planting seed can be affected by harvesting procedures and all the subsequent operations involved in handling, removal of the fiber and linters, and preparation of the seed for marketing. Reductions in seed quality during the various operations are usually associated with mechanical damage, chemical injury, or physiological deterioration resulting from high temperature and moisture levels, and their interactions. These losses in quality can be minimized by proper selection and adjustment of equipment, better design of facilities, improvements in operational management and a rigorous quality assurance program. On the positive side, the close association of seed quality with seed density offers an opportunity for substantial upgrading of quality by removal of low density seed.

The germination test has serious deficiencies as a measure of the planting value of cottonseed. The refinement and standardization of one or more of the vigor tests used for cottonseed would permit more effective identification and marketing of high quality seed lots.

Improvements in the quality and performance of cottonseed can be achieved through various conditioning treatments prior to sowing and selection in breeding programs for traits associated with superior quality and performance.

## Chapter 33

# TECHNIQUES TO EVALUATE PLANTING SEED QUALITY

Charles C. Baskin  
Mississippi State University  
Mississippi State, Mississippi  
and

Norman W. Hopper  
Texas Tech University  
Lubbock, Texas  
and

Gordon R. Tupper  
Mississippi State University  
Stoneville, Mississippi  
and

Otto R. Kunze  
Texas A & M University  
College Station, Texas

## INTRODUCTION

Maintaining the quality of cotton seed at the level that it is at harvest (or as nearly as possible) is a primary concern in producing high quality seed. The condition of seed cotton at the time of storage, the management in storage, as well as the condition and management of bulk seed in storage have a marked effect on seed quality.

The same factors are important regardless of the length of storage. Proper storage of seed cotton is often difficult because of varying field conditions. Adequate precautions are not always taken to protect seed cotton during storage.

As with any seed the primary factors affecting storability are moisture and temperature. Properly designed and constructed facilities, knowledge of conditions necessary for safe storage and how to achieve these conditions are necessary in order to maintain seed quality.

Measuring seed quality is important in the selection of lots for conditioning and in the quality control program of a seed company. Eliminating lots not suitable for planting from the market can be invaluable to a seed company as well as to a farmer.

## SEED STORAGE

## HYGROSCOPIC EQUILIBRIUM

The single most important factor affecting seed quality in storage of both seed cotton and bulk cotton seed is moisture. Other factors contribute to physiological quality and length of life in storage. Their effect, however, is superimposed on the effect of moisture. Thus, other factors modulate but never supersede the important effect of moisture (Altschul, 1948). Cotton seed will come into equilibrium with the moisture content of the surrounding air and/or other material. In this way relative humidity, green material, wet or damp lint, etc. exert a great influence on the storability of seed.

Equilibrium moisture content of cotton seed is reached in eight to ten days and will range from less than 5 percent at 10 percent relative humidity to about 18 percent at 90 percent relative humidity (Altschul, 1948; Robertson and Campbell, 1933; Simpson and Miller, 1944). Griffin and McCaskill (1964) concluded that the behavior of cottonseed in seed cotton form appeared to be identical to that reported for cottonseed in bulk storage. The moisture content and rate of germination decline in cottonseed stored in small quantities at seven locations in the southeastern United States for a period of seven years was related to atmospheric conditions at the storage site (Table 1).

Table 1. Fluctuation in moisture content and decline in germination of fuzzy cottonseed in ambient storage (from Simpson, 1946).

Storage site	Variation in seed moisture (%)	Seed germination (%)		
		Initial	Later	Time interval
Jackson, TN	8.3- 9.7	92	72	5 years
Knoxville, TN	8.4- 9.8	90	76	5 years
Greenville, TX	8.0-10.2	91	76	4 years
Clemson, SC	9.2-10.6	92	69	3½ years
Florence, SC	8.2-11.1	92	77	2 years
Mississippi State, MS	9.1-11.1	91	76	2 years
Baton Rouge, LA	10.1-11.2	92	68	1½ years

Seed stored in the drier climate of Arizona germinated well after considerable longer periods of storage. Seed of 20 strains of Egyptian cotton averaged 85 percent germination after 7 to 14 years storage, while seed of upland cotton germinated up to 95 percent after 16 years storage in ambient conditions (Ishy, 1950). However, when cottonseed are stored in relatively large masses, the natural air movement through the mass is negligible. Thus, atmospheric conditions would be expected to have a minor effect on cottonseed in unaerated storage for normal 6 to 18 month storage periods.

## SEED QUALITY MOISTURE-TEMPERATURE RELATIONSHIP

Initial seed moisture is critical if viability and quality are to be maintained in storage. There is a definite relationship between seed moisture and storage temperature. Simpson (1942) found seed with initial germination of 90 percent, stored at ambient temperatures and 7-9 percent moisture, declined very little in germination in 36 months, while seed at 11 percent moisture germinated less than 40 percent in the same period. Seed at 13 and 14 percent moisture were dead in 24 and 12 months, respectively. When seed were stored at 32C and 7 percent moisture, germination dropped to 60 percent after 36 months, while seed at 9, 11, 13 and 14 percent moisture were dead after 28, 17, 12 and 4 months, respectively. Seed stored at 21C and 7 to 9 percent moisture germinated over 80 percent after 36 months; seed at 11 percent moisture germinated approximately 70 percent; while seed at 13 percent germinated near zero, and seed at 14 percent moisture were dead after 17 months storage. Seed stored at 0C maintained initial germination for all moisture contents for 36 months.

Pate and Duncan (1964) reported on a similar study but extended the time period up to 25 years. Cottonseed stored in sealed containers at 0C and 7, 9 and 11 percent moisture showed little or no decline in germination after 25 years. Seed at 13 and 14 percent moisture maintained 70 percent or higher germination for 15 and 3 years, respectively. Increasing temperature to 21C considerably reduced length of life in storage. Seed at 7, 9 and 11 percent moisture maintained germination above 80 percent for 13½, 5½ and 2 years, respectively, while seed at 13 and 14 moisture did not maintain 80 percent for one year. At 32C only the 7 percent moisture sample maintained 80 percent germination for one year or longer.

Higher temperatures for shorter periods of time, such as those resulting from drying seed cotton at gins, can also damage cottonseed. These may present more of a management problem than temperatures after cottonseed is in the warehouse because there is little, if anything, that can be done until seed can be aerated. Sorrenson and Wilkes (1959) studied effects of 26C, 38C and 60C temperatures on seed stored at 8 to 9 percent moisture. The 26C temperature caused no reduction in germination during the 21-day period, but 38C reduced germination, and 60C completely killed the seed during the 21-day time period.

Cherry (1976) reported that exposing cottonseed with 9 percent moisture to 60C for 72 hours reduced germination to zero. He also reported measuring seed temperatures of 49C-55C immediately after ginning. As a result, California planting cottonseed distributors have made it a policy to eliminate or seriously question the quality of any seed exposed to temperatures over 49C. Many seed conditioners accept cottonseed at 12 percent or less moisture instead of 10 percent and never measure temperature.

Ideally seed should be conveyed from the gin to the warehouse. However, in many, if not most instances, this is not possible. Seed must be trucked from gins to warehouse storage. The length of time they must remain on the truck will vary; all

day or over night is not uncommon. Temperature could be a very important factor in this length of time.

### VARIATION IN SEED MOISTURE CONTENT

There can be a considerable variation in seed moisture in seed cotton. The indeterminate fruiting habit of the cotton plant results in quite a variation in the length of time bolls are opened before they are picked. Sorenson (1973) studied seed moisture content in seed cotton at various times after boll opening. His findings are presented in Table 2. Considering percentage of bolls opened and

Table 2. Variation in moisture content of individual seeds, composite samples of seeds in individual locs and individual bolls at 0, 4, 12, 16 and 20 days after boll opening (From Sorenson, 1973).

Component	Days after boll openings					
	0	4	8	12	16	20
	Range in moisture (percent)					
Seeds	10-22	11-21	10-16	10-13	8-13	8-12
Locs	10-21	12-20	10-12	10-17	8-11	7-11
Bolls	14-17	11-18	10-12	10-12	9-11	8-11

seed moisture contents, if cotton were picked at 20 days after the first bolls were open, only 67 percent of the seed would contain 12 percent moisture or less.

Sorenson (1973) also conducted studies of germination of seed from seed cotton stored at different moisture contents and different densities for various lengths of times. He concluded that, at densities of 7 to 12 pounds per cubic foot, storage times without loss of seed germination could be:

<u>Percent seed moisture</u>	<u>Days of storage</u>
8-10	30
10-12	20
12-14	10
14-15	3

Seed at 8-10 percent moisture could be stored at 20 pounds per cubic foot without reducing germination. Based on these figures, cotton would have to be ginned rather rapidly in order to prevent loss of seed quality.

### PRESENCE OF HIGH MOISTURE FOREIGN MATERIAL

This is much more of a problem in the southern area than in areas where plant growth and defoliation can be controlled and regrowth is not a problem. Harvesting in the Southeast, in particular, without getting some green material is almost

Table 3. Effect of storing seed cotton with different amounts of foreign material (stems, leaves, and other plant parts) on changes in moisture content of the seed cotton and seed (From Sorrenson and Wilkes, 1974).

Moisture content of foreign material at start of shortage (percent <sup>1</sup> )	Foreign material in stored seed cotton (percent)	Moisture content of seedcotton and seed (percent)				Moisture content of foreign material at end of storage (percent)
		Seed cotton		Cottonseed		
		Start of storage	End of storage	Start of storage	End of storage	
80	5	8.0	11.5	9.1	12.7	19.5
	10	8.0	15.4	9.1	17.2	29.5
	15	8.0	18.5	9.1	21.2	34.5
	20	8.0	20.9	9.1	24.5	46.2
	25	8.0	24.6	9.1	28.0	49.4
65	5	6.9	9.1	7.8	10.2	14.0
	10	6.8	10.4	7.6	12.8	19.5
	15	7.0	14.4	7.8	15.7	25.6
	20	7.2	16.4	7.8	18.5	30.0
	25	7.0	18.2	7.7	20.6	31.1
46	5	6.9	8.6	7.8	9.7	13.8
	10	6.9	10.0	7.7	11.4	16.6
	15	7.0	11.2	7.8	12.7	18.8
	20	7.1	12.5	7.8	14.4	21.7
	25	6.8	12.8	7.7	14.6	22.7

<sup>1</sup>Seed cotton samples containing foreign material with an initial moisture content of 80 percent were stored for 42 days. Samples containing foreign material with initial moisture contents of 65 and 46 percent were stored for 28 days.

impossible due to uneven or incomplete defoliation and regrowth on occasions. Sorenson and Wilkes (1974) measured moisture transfer from foreign material at different moisture contents and in different quantities to seed cotton and cotton seed (Table 3). This study clearly demonstrates the moisture problems that can be created when seed cotton contains green material.

### STORAGE IN TRAILERS

Griffin and McCaskill (1964) studied the effects of storage of seed cotton in trailers on fiber quality. Heating was a problem. Temperatures up to 60C were observed when seed moisture content was 16.4 percent. They concluded that trailer storage was not safe unless cottonseed moisture was 10 percent or less. Cooling and drying trailer stored seed cotton by forced aeration was too slow and unpredictable to be a practical means of preventing storage damage. Seed cotton densities ranged from 6 to 8 pounds per cubic foot.

### STORAGE IN THE FIELD

Field storage in the dry, western cotton production area has been a practice for a number of years. Field storage has varied from uncovered piles in fields to ricks where cotton is stored on pallets. A study in 1965 (USDA Southern Cooperative Series, 1965) concluded seed cotton with low moisture content could be safely stored in the field on well drained sites without a cover in the High Plains, but in areas where even limited rainfall occurred, seed germination was drastically reduced in uncovered seed cotton.

Numerous studies of seed cotton stored in mechanically packed modules on pallets (Baskin, 1976a; Baskin, 1965b; Roberts *et al.*, 1974) have reached essentially the same conclusion as earlier trailer studies. Dry seed cotton with dry seed, 10 percent or less moisture, and little or no green foreign materials can be stored at densities of 12 to 14 pounds per cubic foot without any problems, provided adequate protection is provided from precipitation and the storage site is well drained.

### DRYING AND AERATION

Shaw and Franks (1962) concluded after some nine years of research that drying cottonseed at the cotton gin substantially benefited perserving seed germination, provided that the seed were adequately cooled shortly after drying. However, drying of seed is not practiced except maybe for small quantities for breeding purposes. Drying of cottonseed is not necessary every year, even in the high rainfall area of the southeastern United States. The general practice is to harvest cotton as dry as possible, measure moisture content after ginning and, if seed moisture content is not acceptable, send the seed to the oil mill. Seed moisture contents of 10 or 12 percent or less are generally acceptable. Whether 10 or 12 percent is the maximum acceptable level depends on the standards of the individual seed company and, to some extent, the capability of aeration in storage.



Cooling cottonseed as it comes from the gin and maintaining the stored mass under conditions that will prevent hot spots and moisture buildup are necessary to prevent loss of quality. The most economical means of maintaining cottonseed at safe storage temperatures is by aeration (Cherry, 1976).

Aeration systems used for planting seed should be designed for planting seed. Higher air flow rates are necessary. These may be as high as 20 ft.<sup>3</sup>/min/ton but should not be less than 10 ft.<sup>3</sup>/min/ton, compared to 2 to 5 ft.<sup>3</sup>/min/ton for oil mill storage (Smith, 1975).

The general practice in cottonseed aeration is to draw air down through the seed because: (1) the natural tendency for air to move is upward from the warm seed to the cool upper surface is in part offset, (2) the warm moist exhaust air in early aeration is expelled in the lower part of the bin, and possible condensation at the cooler upper surface is prevented and (3) the operator can detect any offensive odors in the exhaust air (Cherry, 1976).

Smith (1975) suggested the manifold aeration system for planting seed. The advantages of this system are: (1) aeration can be started as soon as enough seed is placed in storage to cover one or two ducts to a sufficient depth, (2) as additional seed is stored and more ducts are covered, additional slide gates can be opened, (3) if an area is not cooling sufficiently or a hot spot develops, all gates can be closed except the one in the trouble spot, and all of the air can be directed through that area and (4) adjustments can be made for selective removal of cottonseed from the storage area.

Aeration to remove ginning heat is usually started as soon as the first lots are in storage. Although there are times when little cooling occurs, aeration is still beneficial to remove the heat and moisture of respiration. Temperatures of 30C or lower at a relative humidity of 80 percent or less are recommended for aeration after ginning heat has been removed. A final seed mass temperature of 10C-13C is desirable for storage of planting seed (Smith, 1975). Sorrenson and Wilkes (1959) found that quality could be maintained for seven months when seed mass temperatures were lowered to 13C.

Some drying may occur during aeration. Sorrenson and Wilkes (1959) measured from zero to a 1.3 percent decrease in seed moisture content. However, the rate of moisture removal at these air flow rates is very slow and is not sufficient for drying high moisture cottonseed.

## EVALUATION OF SEED QUALITY

The concept and importance of seed quality and a review of the studies for evaluating seed quality are presented in Chapter 32. The need for evaluation other than the standard germination test is also discussed, as is the concept of vigor.

Our purpose here is to discuss some tests that are being employed in the cottonseed industry, in addition to standard germination, to evaluate cottonseed.

We will also discuss the relationship between density and seed quality and how this is being employed in the industry.

### TETRAZOLIUM EVALUATION

The tetrazolium test provides a rapid evaluation of seeds and can provide timely guidance concerning the extent and nature of seed quality problems during harvesting, conditioning and storage and distribution.

The test can be used to estimate both seed germination and vigor. For an estimation of germination, stained seed are placed in a germinable or non-germinable category based on the overall color, location and amount of dead tissue (Delouche *et al.*, 1962). For an estimation of vigor the germinable seed are classified into categories, or vigor levels, based on the intensity and/or depth of staining, lack of staining and location of weak or dead embryo parts.

The tetrazolium salt commonly used in seed testing is 2, 3, 5,-triphenyl tetrazolium chloride. Tetrazolium salt is an oxidation reduction indicator. The 2, 3, 5,-triphenyl tetrazolium chloride is reduced by accepting hydrogen from dehydrogenase enzymes. The reaction produces formazan, an insoluble red compound, and hydrochloric acid. Since dehydrogenase enzymes are involved in respiratory activity of biological systems, the reaction takes place within the cells. The insoluble formazan does not diffuse out the cell, therefore, there is a sharp delineation between the red, viable, respiring tissue and colorless, non-viable, non-respiring tissue.

Several dehydrogenase enzyme systems appear to be capable of catalyzing the reaction (Jensen *et al.*, 1951). Smith (1952) made a detailed study of the reduction of 2, 3, 5,-triphenyl tetrazolium chloride in corn embryos. He concluded that the reaction is catalyzed by diphosphopyridine nucleotide-linked dehydrogenase in malic and alcohol systems and is mediated by diaphorase.

The tetrazolium test is, then, a test for dehydrogenase enzyme activity. The loss of activity of these systems parallels the loss in seed viability and vigor.

**Evaluation**—The basis for viability and vigor evaluation involves the identification, location and appraisal of sound, weak and dead embryo tissue related to seedling development (presence and condition of essential structures), overall strength of the developing seedling and possible influence on length of life of the seed in storage. Differences in color, lack of color and tissue turgidity or flaccidness help distinguish sound, weak or dead tissue. Observation of the location and extent of the fractures, missing embryo parts and abnormalities provide additional information in evaluation of embryo soundness. The presence, amount, depth and location of embryo imperfections near or within essential embryo structures are also important to the evaluation.

There are basically two systems for grouping seeds into categories: classifying seeds as either strong or weak, and classifying seeds as high, medium or low vigor. Both systems, of course, would have a nongerminable category. Either system is

adequate, but the three-category system allows a more critical evaluation of the seed.

*High vigor* seed are completely stained or with only minor unstained areas on or near the chalazal end of the seed. Staining is uniform and bright, not deeply stained. Tissue is firm. Radicle tip is stained but is darker than the cotyledons.

*Medium vigor* seed may have minor unstained or darkly stained areas over various portions of the cotyledons. Embryo axis is uniformly stained but not dark except for the radicle tip. The extreme tip of the radicle may be unstained. Tissue is firm but may be slightly darker than high vigor seed.

*Low vigor* seed may have large areas of the cotyledon unstained but none in the area near the axis, which is considered essential. The tip of the radicle may be unstained into the extreme tip of the vascular tissue (stele). Cotyledons may be darkly stained or with a slight milky appearance in parts of the cotyledons. Tissues may be somewhat flaccid (Baskin, 1981).

*Nongerminable* seed include those with one-third or more of the radicle extremely dark (almost black) or unstained, one-third or more of the cotyledonary tissue unstained, entire seeds stained very dark, seeds stained grayish or cloudy (milky), seeds with one-third or more of the radicle missing and very flaccid embryos.

To classify seeds as strong or weak, simply combine the high and medium vigor categories.

## ELECTRICAL CONDUCTIVITY

As previously indicated, the measurement of the electrical conductivity of the seed soak water has been employed as a measure of seed vigor (biochemical test). According to the scheme of seed deterioration proposed by Delouche and Baskin (1973), electrical conductivity should be a sensitive vigor test, if it is an accurate measure of membrane degradation. They propose that membrane degradation is the first step in seed deterioration. Experimental evidence generally supports the test as a relatively good indicator of membrane integrity and, hence, vigor in many crops.

To better understand the concept of measuring seed vigor by the use of electrical conductivity, a general understanding of the structure and function of cellular and organelle membranes is necessary. The membranes, among other functions, provide for compartmentalization of cellular and organelle constituents, are semipermeable barriers for the movement of various substances and are sites for numerous enzymatic and growth regulator reactions. Compositionally, the two major components of membranes are lipids and proteins. Although the exact structure of membranes is not clearly understood, it is generally accepted that they consist of a bilayer of phospholipids oriented such that a nonpolar portion is positioned toward the center of the membrane while a polar portion is positioned outward on both sides. Protein is embedded in and associated with the phospholipid layers.

Cellular membranes are usually considered to reach their maximum level of structural organization during seed development. According to Abdul-Baki (1980), the greatest structural changes in membranes occur during the seed maturation phase (dehydration) and during the germination (imbibition/rehydration) phase. As the seeds mature and dehydrate, the membranes become disorganized and are rendered inefficient as barriers. Presumably this occurs when the seeds reach a moisture content of about 20-30 percent and is likely due to reorientation of the phospholipid bilayer. The membranes, and consequently the seed, remain in this disorganized state until imbibition (rehydration) occurs during the germination phase (assuming good storage conditions). Abdul-Baki (1980) concluded that reorganization of seed membranes during the rehydration process is critical in that the reorganization must occur before the cell is hydrated. Otherwise the mixing and/or loss of cellular constituents may occur, resulting in reduction or complete loss of seed vigor. This led him to propose that, on a biochemical level, three conditions had to be met to attain and maintain vigor: "First, a highly organized organelle/membrane system must exist in the seed during development; second, disorganization of the organelle/membrane system during seed maturation and dehydration must proceed in an orderly manner such that its reorganization upon hydration becomes possible in the shortest possible time; third, upon rehydration, all membranes must become fully organized before the cells become fully hydrated". Thus, the loss into the imbibing medium of cytoplasmic solutes with electrolytic properties provides the basis upon which the electrical conductivity test measures seed quality for planting purposes.

Presley (1958) was among the first to report a relationship between seed leachate electrical conductivity and seed viability. In studying cotton, he noted that the soak water of deteriorated seeds was more turbid than that of nondeteriorated seeds and, subsequently, measured the electrical conductivity. It was then that he observed and reported a positive relationship between conductivity and seed deterioration (as measured by a germination test). Later, Matthews and Bradnock (1968) and Matthews and Whitbread (1968) evaluated the relationship between seed exudation (electrical conductivity) and the field emergence of peas (wrinkle-seeded) and French beans. They observed a highly significant negative correlation and, thus, proposed the use of this test to detect seed of low planting value (vigor). Since these studies, numerous investigations as to the relationship between electrical conductivity and viability/vigor have been conducted with several different crop species.

In corn, several workers (Gill and Delouche, 1973; Joo *et al.*, 1980; Tao, 1980a,b) have evaluated the electrical conductivity test as a measure of seed vigor. All have reported that the conductivity test correlated well with vigor; however, Joo *et al.* (1980) and Tao (1980a,b) indicated that genotypic differences do exist. Therefore, care needs to be exercised in the interpretation of test results.

In the United States, more recent work has probably been done with soybeans than any other crop relative to the use of electrical conductivity as a measure of

seed quality. Abdul-Baki and Anderson (1973) and Yaklich and Abdul-Baki (1975) noted an increase in the leaching of labeled materials from the embryonic axes of soybean seeds of low vigor. McDonald and Wilson (1979) reported a relationship between electrical conductivity (measured using a commercial instrument—ASA-610) and the germination of soybean seedlots with values below 20 percent and above 80 percent. McDonald and Wilson (1980) also reported that the electrical conductivity (ASA-610) accurately evaluated the quality of soybean seeds that had been subjected to both mechanical damage and accelerated aging. Other workers (Miles and Copeland, 1980; Tao, 1980a,b) noted that the electrical conductivity test correlated well with soybean field emergence.

A limited amount of research has been conducted with other crop species. In general, the conductivity test has correlated well with seed quality in bush bean, peanut, cotton and navy bean (Levengood *et al.*, 1975); cowpea (Beighley and Hopper, 1981); navy bean (Suryatmana *et al.*, 1980); clover and ryegrass (Ching and Schoolcraft, 1968); barley (Abdul-Baki and Anderson, 1970); and rice (Agrawal, 1977).

Most of the work reported for cotton indicates that the electrical conductivity test is a good indicator of seed quality. As previously indicated, Presley (1958) was among the first to evaluate the test as it relates to cotton. He observed from his studies that seed of high viability soaked in water resulted in high resistance (low conductivity) readings and that the resistance readings decreased as the degree of seed deterioration increased. Later, Bird and Reyes (1967) reported just the opposite response in that increasingly deteriorated (by high relative humidity and temperature) cottonseed resulted in higher electrical resistance values. However, they only soaked the seeds in distilled water for two minutes and made no mention of the initial seed moisture content. Both of these could affect the results. Halloin (1975), in an attempt to resolve this discrepancy, aged cottonseeds (high temperature and humidity) at low (7-8 percent) and high (20 percent) initial moisture levels prior to measuring the seed soak water electrical conductivity. He reported, as Presley (1958) had previously, an increase in the conductance and a subsequent reduction in the germination of those seeds deteriorated at low initial seed moisture levels. However, when he adjusted the seed moisture level to 20 percent prior to deterioration, the electrical conductivity, as affected by seed deterioration, was not consistent. It is likely that by adjusting the seed moisture content to 20 percent prior to deterioration the membranes had an opportunity to become reorganized before the seeds were soaked and, thus, would be expected to lose less electrolytes by leakage. Bishnoi and Delouche (1980) also reported a lower resistance (higher conductivity) in cottonseed that was artificially deteriorated.

In the mid-1970's, a company (Agro Sciences, Inc.) developed and began marketing an instrument (MSS-110) that would directly measure the conductivity across individual seeds after they had been soaked in water. Although the process of handling each seed individually was somewhat time-consuming, most

workers observed a good relationship between seed electrical conductivity and seed quality (Levengood *et al.*, 1975; Bondie *et al.*, 1978; Brashears *et al.*, 1979; Hopper, 1981). Hopper (1981) soaked seeds from several lots of Blightmaster A5 in deionized water (15 min.) and separated them into four conductivity categories. The seed in each category were then subdivided and germination and emergence (growth chamber and greenhouse) studies were performed on the seed (Table 4). Seed in the higher conductivity categories exhibited poorer levels of germination and emergence (both growth chamber and greenhouse). In the

Table 4. The relationship between seed electrical conductivity and the germination and emergence (growth chamber and greenhouse) of five seed lots of Blightmaster A5.

Conductivity category	Germination (percent)	Emergence (percent)	
		Growth chamber	Greenhouse
$\mu$ Amps			
0-14.9	73	70	77
15-29.9	57	54	73
30-44.9	41	40	51
$\geq 45$	22	20	19

Table 5. The relationship between seed electrical conductivity and seedling plant height of five seed lots of Blightmaster A5 grown in the growth chamber.

Conductivity category	Days after planting				Mean
	8	10	12	14	
$\mu$ Amps	Height (cm)				
0-14.9	5.2	6.8	8.2	8.6	7.2
15-29.9	4.6	6.6	7.8	8.4	6.9
30-44.9	4.2	5.4	6.0	6.2	5.5
$\geq 45$	3.2	4.4	5.2	5.8	4.7

emergence study, seedling heights were also measured 8, 10, 12 and 14 days after planting in the growth chamber (Table 5) and 4, 6, 8 and 10 days after planting in the greenhouse. The growth chamber data (Table 5) indicated lower vigor levels from the seed in the higher conductivity categories, as evidenced by the reduced seedling heights. The same general trends were observed in the greenhouse emergence study. Other workers have generally reported a concomitant decrease in germination as electrical conductivity increased (Levengood *et al.*, 1975; Bondie *et al.*, 1978).

During the late 1970's Agro Sciences, Inc. developed and began marketing another instrument with a multi-electrode head (ASA-610) that would measure

the electrical conductivity of the seed soak water of 100 seeds—each soaked in an individual cell. As would be expected, this greatly speeded the testing procedure. The work reported thus far with cotton generally indicates a good relationship between this form of the electrical conductivity test and seed quality. Hopper and Hinton (1980) observed that the instrument provided a good estimate of the germination of seed lots with reasonably good viability (69-86 percent). The results, however, were much more variable when they used poor quality seed (0-65 percent germination). Hyer *et al.* (1980) and Glat *et al.* (1982) also reported that the instrument provided good estimates of germination when they measured the electrical conductivity of the seed exudates after soaking in distilled water.

Most of the work with cotton and other crops indicates that the use of electrical conductivity provides very useful information relative to seed quality. It should be noted that certain factors have been reported that may affect the reliability of test results. These include factors such as initial seed moisture, chemical seed treatments, temperature conditions and seed size (Andersen *et al.*, 1964; McDonald and Wilson, 1979); the type of filter paper (Tao, 1980c); mechanically injured seed (McDonald and Wilson, 1980); and possibly others. However, as previously indicated, under controlled conditions valuable information relative to seed quality may be obtained by use of the electrical conductivity test. A description of the test, in addition to numerous other vigor tests, may be found in the Seed Vigor Testing Handbook (Association of Official Seed Analysts, 1983).

### RELATION OF DENSITY AND WEIGHT TO SEED QUALITY

Tupper (1969) conducted research to relate a seed's physical characteristics (diameter, length, weight, volume and seed density) to its ability to germinate and grow. Ungraded 'Lankart 57' and 'Stoneville 213' seed were selected under a magnifying glass to remove all visibly damaged seed. The identity of each of the 800 seed randomly selected from each variety was maintained throughout the entire experiment.

The length and maximum diameter of each seed were measured with a micrometer. Seed were allowed to equilibrate for a minimum of 14 days at a constant temperature (10C) and relative humidity (50 percent) before being weighed in air and in distilled water. A single seed was submerged in water about 30 seconds. Turner (1929) found that the apparent specific gravity of cottonseed changed by only 8 percent when seed were submerged in water for 15 minutes. Thus, a cottonseed apparently absorbs water rather slowly when first submerged. The following equation was used to measure volume,  $V$ , of the seed.

$$Y = \frac{W_a - W_l}{D_l}$$

Where:

$W_a$  = Weight (g) of seed in air

$W_l$  = Weight (g) of seed submerged in liquid

$D_l$  = Density of liquid (g/cc) at the temperature of the liquid.

A standard laboratory day-night seed germinator was used by Tupper *et al.* (1970). In a standard germination test, the germinator was set to operate at 20C for 16 hours and 30C for 8 hours through the 7-day experiments. The germinator was set to maintain a constant 18½C for the cold test. From each variety, 400 seed were germinated in the standard and in the cold test.

The seed were put in visual germination cells which were placed in a vertical position in the germinator. These cells allowed the seedlings to grow in their normal position without physical disturbance when they were observed at 24 hours intervals.

**Germination Response**—After the seeds were germinated, the data for each lot of 400 seeds were ranked in order from the lowest to the highest numerical value of each physical characteristic, as reported by Tupper *et al.* (1971). The percentage of seed germinated was calculated for each day of the experiment.

Correlation coefficients were calculated for the relationship between each physical characteristic and the percentage germination on each day of the experiment. Each physical characteristic was treated as an independent variable.

Seed density was the physical characteristic which had the greatest influence on germination response. Seed volume and diameter were influential on the 3rd and 4th days but had little influence thereafter. A time period is needed for the center or a large diameter of high volume seed to reach a high enough moisture content to trigger the germination process. After sufficient time for moisture absorption, these two physical characteristics apparently have only a minor role in the germination response.

**Growth Response**—A multiple regression analysis was used to eliminate the least significant variable until all remaining variables were significant at the 5 percent level. In the standard germination test physical characteristics of seed were less important than when seed were stressed in the cold test. In cold tests with Stoneville 213 and Lankart 57, seed weight had the greatest influence on seedling growth. Though the results were not as evident for growth as they were for germination, seed weight provided the best relationship to growth of a seedling in the germinator. Cotyledons of the heavy seed may have provided more stored energy which was available for use in the growth process.

**Combination of Germination and Growth**—Each of the 400 seeds was analyzed for growth irrespective of the day the seed germinated. This procedure provided a more practical approach to seed selection because it considered a combination of germination and growth responses.

Seed density was the only physical characteristic which contributed significantly to the regression equations relating to root and hypocotyl growth of both varieties in the standard germination test and for Stoneville 213 in the cold test. After 10 days in the cold test with Lankart 57, only seed density was contributing



significantly to seedling growth. The influence of seed density on the earliness of germination apparently overshadowed the influence of seed weight on growth.

Based on these data, seed selection equipment should be designed to select the highest density cottonseed for planting purposes. Additional separation could be made on the basis of seed weight to remove light seed.

## SEPARATION OF SEED USING THE DENSITY FACTOR

The value of the density factor in separating cottonseed was recognized as early as 1907. Webber and Boykin (1907) separated cottonseed with a column of moving air. In subsequent field test, plants from heavy seed yielded approximately 10 percent more seedcotton than plants from light seed. Chester (1938, 1940) separated acid delinted cottonseed using water as a medium to produce a density gradient. He compared gin run, ungraded acid delinted seed, acid delinted floaters and acid delinted sinkers. Over a two year period the heavy (sinkers) acid delinted seed produced 32, 52, and 159 percent greater emergence than did ungraded acid delinted, gin run and light (floaters) acid delinted seed, respectively.

The practice of density separations using water never gained wide acceptance, however. Kunze *et al.* (1969) demonstrated differences in field emergence and growth response of cottonseed of different physical characteristics, density being a primary factor. A study of liquid separation was conducted by Kunze (1978). He developed a dynamic or continuous liquid separator. As with other liquid separations over the years commercial application has never been attained. Justice *et al.* (1965) separated cottonseed using a gravity table (separator). They concluded that the heavier fractions of acid delinted seed were superior to the lighter fraction in field tests. Heavier seed had a higher percentage emergence and more rapid early seedling growth than lighter fractions. They did not report weight per bushel or other parameters of the various density fractions.

Gregg (1969), using 19 lots composed of 10 cultivars planted in Mississippi, separated acid delinted seed into 10 different density fractions using an Oliver model 160 gravity separator. The physical parameters, standard bulk density (weight per bushel), screened bulk density, pack bulk density, compactibility, true volume, weight per 100 seed and specific gravity were measured on each of the 10 fractions. The biological parameters, germination percentage, soil cold test, germination after accelerated aging, seedling growth rate, free fat acidity and field emergence were measured.

Standard bulk density (weight per bushel) was a good indicator of seed quality. Ranges in standard bulk density of seed for respective positions (1-10, light to heavy) of the gravity separator are presented in Table 6. Among lots, coefficients of correlation between standard bulk density and standard germination of treated seed ranged from .802 to .959, and for field emergence the range was from .800 to .946. The general conclusion from Gregg's work (1969) was that if weight per

bushel is above 42 pounds, seed are suitable for planting, and that seed above 44 pounds per bushel might be considered as a premium quality product.

Johnson *et al.* (1973) found that as bulk density increased, germination, field emergence and three-week seedling survival increased. Lint yield of high density seed, however, was not significantly higher than that of ungraded seed (Table 7). It must be pointed out that there were some exceptions, and this cannot be accepted as an absolute measure of seed quality. Other tests need to be combined with standard bulk density to measure the planting value of cottonseed.

Table 6. Range in standard bulk density (wt/bu) of acid delinted cottonseed from different discharge positions of a gravity separator.

	<u>1</u>	<u>2</u>	<u>3</u>	<u>4</u>	<u>5</u>	<u>6</u>	<u>7</u>	<u>8</u>	<u>9</u>	<u>10</u>
Low	26.05	35.30	36.15	37.43	40.83	42.78	43.63	44.00	44.58	45.30
High	38.48	43.88	44.68	46.78	47.20	47.83	48.20	47.88	48.33	49.63

Table 7. Germination, bulk density, field emergence, seedling dry weight and lint yield of different seed density classes from two lots of acid delinted cottonseed.<sup>1</sup>

Density class	Seed per class (%)	Germ. (%)	Density (lbs/bu)	Field emerg. (%)	3-wk D.W. (gm/plt)	Lint yield (lbs/A)
<u>Stoneville 7A</u>						
D-1	31	82 a <sup>1</sup>	49.3	78 a	.80 a	989 a
Upgraded	—	81 a	47.3	60 b	.65 b	900 a
D-2	28	76 ab	45.9	61 b	.74 ab	820 b
D-3	25	68 b	42.3	54 c	.68 b	929 a
D-4	16	41 c	36.8	32 d	.27 c	774 c
<u>Stoneville 213</u>						
D-1	29	86 a	50.0	85 a	.68 a	1027 a
D-2	28	83 a	48.3	74 b	.67 a	969 a
Upgraded	—	77 a	46.0	70 b	.85 b	944 a
D-3	23	79 a	46.5	65 bc	.58 b	851 b
D-4	19	59 b	41.4	46 d	.52 b	772 b

<sup>1</sup>Means not followed by the same letter are significantly different at the 5 percent level.

## Chapter 34

# GERMINATION AND STAND ESTABLISHMENT

Meryl N. Christiansen and Randy A. Rowland  
USDA-ARS  
Beltsville, Maryland

## INTRODUCTION

There is nothing more important to maximizing cotton production than a vigorous stand of seedlings. It has been repeatedly demonstrated that plants that develop from poor seed, or from seedlings that have been stressed by cold, pesticides, salt or pests, generally grow slowly, fruit poorly and produce uneconomic returns. The present paper will relate the current knowledge as to how cottonseeds germinate and how the germination environment can affect germination processes, seedling development and resistance to pests.

## COTTONSEED GERMINATION

Water imbibition is the first process of germination which triggers a multitude of metabolic and other physiological events. Early investigations by Simpson (1940) disclosed that water uptake by the dry seed is primarily through the chalazal aperture. Dye studies showed that the path of water followed the nucellar tissue around the embryo to the radicle cap, which was the initial site of embryo hydration. Various genetically controlled blocks to water entry are known to exist. Seed which are not wet by rain or dew may exhibit a moderate resistance to hydration that may persist for a few hours or more; however, genetically controlled impermeable seeds are generally endowed with chalazal blocks made up of pentosans, lignins, waxes and other water insoluble substances that exclude water for extended periods of time. Such seed may persist in soil for several years before microorganisms decompose the chalazal plug or other parts of the seed coat to permit water entry. Walhood (1958) developed a hot water (85C—1 to 2 minutes) treatment that successfully overcame impermeability in Pima S-1. Subsequent breeding efforts eliminated the problem in the Pimas. Christiansen *et al.* (1959, 1960) demonstrated that impermeable seed coats can provide long-term protection to preserve seed. Christiansen and Justice (1963) later showed that field deterioration could be greatly reduced by the heritable impermeable seed coat. Thus, impermeable seed coat can be advantageous. Little work has progressed since that time to further the idea other than an inheritance study by Lee (1964).

The rate of water entry into the embryo is initially rapid (12 hours) as a consequence of the initial change of embryo tissue from 8-10 percent to 40-80 percent water content (Dewez, 1964). Cole and Christiansen (1975) noted genetic differences in rate of water uptake among *G. hirsutum* and *G. barbadense* varieties. There is some evidence that very slow hydration (such as in high humidity) is beneficial to performance of aged or deteriorated seed, while immersion or rapid hydration can reduce subsequent seedling performance. The level of temperature during hydration can have considerable effect on the rate of water uptake and also on membrane organization in embryo cells. This will be discussed later in temperature considerations. A number of researchers have measured water uptake. The rate seems to vary widely, depending upon the genetic source, the location of production, the amount of picker or gin saw damage and the amount of field weathering. Dewez (1964) showed full hydration at 30C in 4-5 hours; Wanjura and Minton (1974) in something less than 6 hours. Cole and Christiansen (1975) showed a rapid hydration by Pima S-4 to near maximum level in 4 hours (60-70 percent) and a slow linear hydration rate for an M-8 selection to 50 percent after 8 hours. In the work by Cole and Christiansen, seed of both selections had identical cultural and storage histories.

All differences noted in rate of hydration of cottonseed most certainly reflect on field germination performance, as well as response to adverse seedbed conditions, particularly water availability and temperature. Simon (1978) suggested that unique changes in membrane configuration take place when seeds are hydrated. The major change in membranes is a change to a functional osmotic mediator or barrier that regulates germination functions. Any stress, including aging, that alters the normal course of establishment of functionality of membranes will drastically disrupt germination processes.

## ENZYMOLGY OF GERMINATION

Metabolic activity is greater and more complex during germination than at any other period in the cycle of plant life. Stored components of the seed are being mobilized and transported, new structural components and metabolic systems are developing, energy is transformed and expended at a high level. All events occur in a more or less orderly fashion unless disrupted by unfavorable external forces.

Cottonseed and most other oil-storing seed follow similar metabolic activity patterns during germination. Although detailed information is not available on all metabolic events occurring during cottonseed germination, it is possible to relate information from studies with other oil seeds to cottonseed and develop a cohesive metabolic map. Very early germination activity is supported by soluble carbohydrate reserves. The primary energy and carbon source during germination is from the stored lipid and protein. There is generally very little overall weight loss from seed to emerged seedling, indicating that most of the activity is a conversion of stored material to structural components.

Most of the early research on metabolic activity in cottonseed centered on lipid.

Of particular interest was the state of lipases in the seed. Olcott and Fontaine (1941) found no lipase activity in preparations from dormant seed but that activity increased rapidly with the onset of germination. Bamann and Ullmann (1940) and McIlrath (1956) agreed that little activity was present in dormant seed. Others (Ramakrishnon and Nevgi, 1951) noted considerable activity. Activity in dormant seed may be a consequence of field wetting and activation of a lipase precursor that remains active after redrying (Christiansen, 1960).

The hydrolysis of lipid during germination was studied under light and dark conditions by White (1958). Storage lipid was found to be depleted after 14 days. Contrary to reports by other researchers, White found no marked increase in free fatty acids during germination, indicating a continuous metabolism of fatty acids to organic acids and sugars via the glyoxylate pathway.

Isocitratase activity in germinating cottonseed has been of considerable interest as a method of monitoring the glyoxylate pathway. Scholl (1974, 1976) related level of activity with seedling vigor. It is also more chilling sensitive than other enzymes of the pathway (Smith *et al.*, 1971). A discussion of temperature-isocitratase interaction will be covered in a later section.

Germination-related protein hydrolysis, transport of amino acids and resynthesis into other structural and metabolically active entities has received less attention than lipids. Some early work with dormant seeds demonstrated the presence of active proteolytic systems (Rossi-Fanelli *et al.*, 1965) and active ribosomes (Phillips, 1964). Leffler (1976a) reported four-fold increases in ribonuclease over seven days germination which was paralleled in part by a large increase in polyribosomes. Patterson and Flint (1979) showed chilling at 13C reduced stomate conductance and reduced photosynthesis in seedling cotton. Parallel reductions in dry weight accumulation were noted.

## ENVIRONMENTAL EFFECTS ON GERMINATION

### TEMPERATURE

Cotton has been the subject of more chilling stress research than all other crop species. Yet, many questions remain, and the problem of low temperature induced loss of seedling stands continues.

The research has progressed along three avenues: 1. The kinds of temperature regimes that cause injury; 2. The nature of injury (physical, metabolic, biotic interaction); and 3. Methods of preventing or ameliorating injury (genetic, cultural and chemical). These are discussed below.

Cottonseed and seedlings are not uniformly sensitive to chilling at all stages of germination. Incidence of chilling during initial hydration can be extremely damaging. As little as four hours of chilling at the onset of hydration can kill all seeds or cause high incidence of aborted root tips; however, if seed are hydrated to 12-13 percent moisture, little injury occurs (Christiansen, 1967). Chilling after the radicle has elongated 2-3 cm causes cortex sloughing, slowing of early growth,

sensitivity to pathogens, membrane leakage of sugars and amino acids and long-term growth reduction and flowering delay (Christiansen, 1963, 1967, 1970).

Emerged seedlings also are sensitive to cold below 12C. The primary impact seems to be on water relations through inactivation of root water uptake and a continued high rate of leaf water loss (J.R. McWilliams, personal communication), which causes seedling desiccation (Kramer, 1940; Guinn, 1971a; Christiansen, 1978). Reports of injury to mature plants are also noted in the literature including the early work of Sellschop and Salmon (1928). Later work by Gipson and co-workers (1968b, 1970) related cool night temperature to effects on fiber quality and yield, and seed properties (see Chapter 5).

Early studies by Arndt (1937), Ludwig (1932) and Camp and Walker (1927) established minimum temperatures for germination under controlled conditions. These experiments indicated that temperatures below 15C are deleterious to germinating seed. A number of field studies are reported as guides to time of planting. These were primarily date of planting studies to ascertain optimal periods for maximizing stand and yield (Holekamp *et al.*, 1960; McQuigg and Calvert, 1966; Riley *et al.*, 1964). Some of the most definitive work on field stand performance is that of Wanjura and Minton (1974).

Symptomology studies have included both physical and chemical descriptions of cold injury. The early work of Arndt (1937), Camp and Walker (1927) and Ludwig (1932) was primarily in terms of germination. Later work by Christiansen and Thomas (1969) gave evidence of season-long expression of the effects of cold occurring during seed germination. These results, which show the linear cumulative effect of increments of chilling on final plant height, date of flowering and earliness, suggest that cold stress during germination affects a very basic control system in the seedling.

Several researchers including Kramer (1940) and Guinn (1971b) observed that emerged seedlings suffer water stress under chilling conditions. Christiansen and Ashworth (1978) later demonstrated that chilling injury at 8C did not occur, if the aerial parts were in high humidity. They suggested and demonstrated the ability of a chemical anti-transpirant to prevent cold injury in growth chamber studies.

Morphological and anatomical changes are induced by chilling. Change in size and shape of the first and second true leaves are caused by chilling during germination, and abortion of the root terminal is a common symptom of chilling during initial seed hydration (Christiansen, 1963). As indicated earlier, collapse and disintegration of radicle cortical cells are induced by cold during germination.

Many researchers have searched for the key site of cold impact on germinating seeds and seedlings. Definition of the major site of injury is desirable in order to intelligently seek solutions to the problems of chilling injury. Most of the studies involved comparative chemistry of constituents. Guinn (1971b) researched the effect of cold on carbohydrates, amino acids, proteins and nucleic acids in

emerged seedlings. Reducing sugars and amino acids accumulated in chilled roots, and protein and nucleic acid syntheses were retarded. DNA of both roots and leaves was reduced when roots were chilled. Guinn, therefore, suggested that cotton roots are a major source of the building blocks necessary for shoot development and that root metabolism is upset by chilling. Christiansen (1970) reported similar studies on pre-emerged seedlings, noting a general disarray of metabolic systems after chilling. Chilling retardation of isocitratase activity, lipid catabolism and lower soluble sugars were reported by Mohapatra *et al.* (1970). Leffler (1976a) noted chilling alteration of RNAase activity and cytoplasmic protein synthesis.

The functionality of cells, organelles within cells and the compartmentation of biochemical pathways is dependent upon membrane integrity. A number of reports implicated environmental stress with disruption of membrane form and function (Lyons and Raison, 1970). Christiansen *et al.* (1970) reported greatly increased exudation of sugars and amino acids from radicles following chilling, low pH and O<sub>2</sub> deficiency. Guinn (1971a) reported similar results with cotyledonary tissue, with the exception that membrane leakage of cotyledonary tissue continued after chilling was stopped, while it ceased in radicles, if cold exposure was less than 48 hours. Smith and Fites (1973) found permeability of glyoxysomes to succinate was reduced by chilling, which suggests cold-blockage of a metabolically active carrier system. By contrast, Christiansen (1970) reported that cold-induced (5C) radicle exudation can be quickly blocked by post-facto addition of calcium to the system. The latter situation suggests a physical function of calcium in stabilizing membrane structure, particularly since little metabolism goes on at 5C in cotton. St. John and Christiansen (1976) implicated the level of linolenic acid in radicle membranes with tolerance to chilling stress by using a specific chemical inhibitor of linolenic acid synthesis (Hilton *et al.*, 1971) to prevent chill hardening. The work firmly implicates fatty acid quality with functionality and survival under chilling conditions.

## OXYGEN REQUIREMENTS

Germination of seeds with lipid reserve requires a large supply of oxygen to support conversion of CH<sub>2</sub> units to Krebs cycle acids and to other metabolic entities. Restriction of free air to germinating cottonseed will inhibit germination, and waterlogging of seedbeds will cause stand failure. Tackett and Pearson (1964) studied the interaction of oxygen and soil compaction on root growth. They found that O<sub>2</sub> levels below 10 percent depressed seedling root growth at low soil bulk densities (1.5 g/cc); at higher densities, soil compaction became the factor controlling root extension; at very low density (1.3 g/cc) root growth was near normal at 5 percent oxygen levels. In earlier work Leonard and Pinckard (1946) reported that root growth ceased at 0.5 percent O<sub>2</sub>. Camp and Lund (1964) also noted depression of root growth at levels below 10 percent in low density soils and found no beneficial effects of increasing O<sub>2</sub> in compacted soil.

Bowen (1961) found that seedling emergence was markedly inhibited, if physical impedance of the emerging seedling exceeded 15 psi (see Chapter 36).

### MINERAL DEFICIENCIES AND TOXICITIES

Cottonseed germination requirements for exogenous minerals have not been thoroughly researched. Christiansen (unpublished) found no beneficial effects during 5 days of germination of additions of N, P, K, Mg, Mn, Bo or Fe to germination media at favorable temperature. Many researchers have observed favorable effects of calcium, particularly under stress. Presley and Leonard (1948) found cotton seedlings were more sensitive to calcium deficiency at low water levels. Wilcs (1959) noted beneficial effects of calcium in improvement of resistance to damping off organisms. Puente (1966) investigated the interaction of chilling and available calcium and observed improved survival and growth, if Ca was added to soil at levels of 1.4 and 3.8 g Ca/100 g soil. He noted that higher phosphorus levels caused increases of chilling injury to tap roots. Hood and Ensminger (1964) also found increased phosphorus in the form of ammonium phosphate was detrimental to seedling emergence.

Accumulation of salts at the soil surface due to upward movement of water and surface evaporation can be a serious problem, particularly in areas of the world where soils are sodic and irrigation water is high in salinity. Acid soils may also present root development problems with aluminum and manganese toxicity.

### CHEMICAL AIDS TO GERMINATION AND STAND ESTABLISHMENT

Use of chemicals to influence germination, emergence or stand persistence has been researched in several ways including modification of the seed bed environment, alteration of the chemistry of germination and functions of the emerged seedling. Most of the synthetic growth regulators were applied as seed or seedling treatment. Gibberellins induce more rapid emergence and taller seedlings (Ergle, 1958; Ergle and Bird, 1958; Bird and Ergle, 1961) but do not provide any salutary effect on stand survival or agronomic performance, particularly under stress. Cycocel, 2-4-D, naphthalene acetic acid and other growth active substances have provided little benefit (Bhardwaj *et al.*, 1963; Coats, 1966; Walhood, 1958). Reddy *et al.* (1979) reported that Cycocel prevented root rot in seedlings.

Cole and Wheeler (1974) compared hot water treatment (85C), seed soaking at 30C, cyclic AMP and gibberellic acid and noted some advantage in germination and seedling growth for AMP and GA and benefits in germination at low temperature for AMP, GA and soaking at 30C. McDaniel and Taylor (Agronomy Abst. 1979, p. 115) reported similar results.

As stated earlier, much of the injury to emerged seedlings is due to cold inhibition of root water uptake and resultant water stressing of seedlings. If highly effective antitranspirants can be developed, they offer a chemical method



to reduce stand losses (Christiansen and Ashworth, 1978).

Modification of the germination environment has been studied to prevent soil crusting, improve internal soil structure for aeration and drainage and to increase soil temperature. Bennett *et al.* (1964) tried various calcium compounds, Krilium (a soil conditioner), asphalt mulch and black plastic to improve stand establishment. The treatments all improved emergence, with black plastic the most effective. Ranney and Wooten (1966) reported similar studies with spray-applied petroleum mulch.

A considerable volume of literature exists concerned with seed protectants, including systemic fungicides and insecticides as well as topical seed protectants. Likewise, in-furrow fungicide treatment has been researched extensively. It is not within the scope of this review to discuss these topics.

## STAND IMPROVEMENT

What are the possibilities for progress toward solution of the problem? Several researchers demonstrated genetic differences in response to environmental adversity. Marani and Dag (1962b) noted maternal influence on germination at low temperature. Similar genetic variance in response to hydration-chilling sensitivity occurs between Acala and DPL selections. Reciprocal crosses of sensitive and tolerant lines indicated maternal control (Christiansen and Lewis, 1973). Bird and co-workers in Texas produced a number of lines which are superior in tolerance to the interacting effects of stress and seedling disease (see Chapter 35). Buxton and Sprenger (1976) reported genetic differences in field emergence from cold soils in Arizona.

The present knowledge of the effect of adverse environment and interacting seedling disease suggest that major progress can be made in improving stand production through breeding efforts. This statement is based on the assumption that genetic variability exists within available *G. hirsutum* and *G. barbadense* stocks. If this assumption is not true, the road to improvement may be much longer and dependent upon gene introgression from wild species or by other genetic engineering.

Chemical improvement of seedling resistance should not be ruled out. It is just a matter of time until we find ways to chemically alter stress tolerance.

## Chapter 35

# SEED QUALITY AND STAND ESTABLISHMENT

Luther S. Bird  
Texas A&M University  
College Station, Texas

## METHODS

Information from published papers will be used to illustrate prerequisites for establishing stands. The seed quality curve was first presented in 1967 and has proven to be a valuable aid in forecasting what to expect from planting-seed (Bird and Reyes, 1967). Information about planting-seed in cold germination tests and in field plantings provided different interpretations of what performance traits mean in terms of stand and yield (Bird, 1973). Data obtained under Southern Regional Project S-72 "Determining Biological Performance for Planting-Seed" provided new concepts of what can be ascertained from knowing more about seed (Bird, 1978). The S-72 data provided optimum estimates of seed measurements which explained variability in damping-off, root damage, stand, earliness and yield. The variability surveyed was from 35 measurements on two sets of seed (1971-72 and 1973-74) representing varieties, seed processing, seed production locations and field performances over four years for sites in Arizona, Texas, Louisiana, Mississippi and South Carolina. All seed lots were acid-delinted and without treatment with seed protectants. Performance data for three groups of MAR cotton cultivars, representing sequential genetic changes in seed traits, will be used to illustrate that there are seed characteristics which have cause and effect relationships with yield and earliness (Reyes, 1980).

## THE SEED QUALITY CURVE

The seed quality curve is based on plotting total germination against days of exposure for seed lots differing in controlled exposure to 100 percent relative humidity at 50C (Figure 1). Germination, seed coat resistance to mold and abnormal roots are determined for seed lots after 7 days at 18C. The cottonseed are evaluated under limitations of time and temperature.

Seed exposed for zero to two days are termed unconditioned and are characterized by a slower rate of germination and emergence at reduced temperatures, seed coat resistance to mold, less seed rot, no abnormal roots on seedlings, optimum cold tolerance and seedlings that are less apt to be killed by pathogens. When

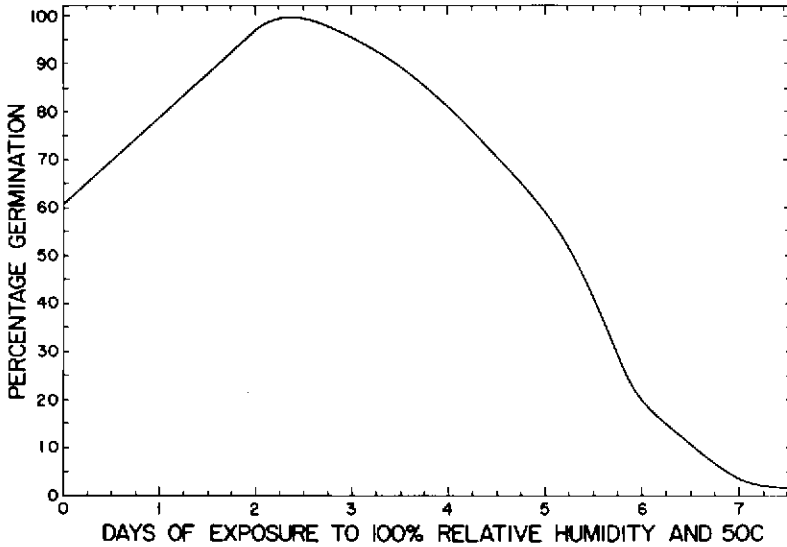

Figure 1. The seed quality curve shows total germination after 7-days at 18C for seed lots exposed 0, 1, 2, 3, 4, 5, 6 and 7 days to 100 percent relative humidity and 50C. Germination, amount of seed with moldy seed coats and abnormal roots at 18C for 7 days helps determine the position of an unknown seed lot on the curve. The position on the curve indicates what to expect from the seed in establishing field populations of cotton.

planting cotton early in the season, only unconditioned seed should be used, especially in regions where reduced temperatures and high soil moisture are likely to occur following planting. Only minimal seed treatment and other practices for controlling seedling disease are necessary when using unconditioned planting-seed. Seed exposed to the equivalent of 2 to 3 days moisture and heat are conditioned and exhibit the most rapid germination and emergence at reduced temperatures. Conditioned seed, in comparison with unconditioned, are further characterized by the seed coat being more susceptible to mold and to seed rot, more seedlings with abnormal roots, less cold tolerance and seedlings that are more sensitive to attack by pathogens. Conditioned seed should not be planted early in the season. They should be used in arid areas where preplant irrigation is practiced and soil moisture may be lost if germination and emergence is not fast enough. Conditioned seed will require use of the more effective seed treatments and use of other practices to reduce seedling disease. Seed exposed to the equivalent of 3 to 4 days moisture and heat have undergone partial deterioration. They germinate and emerge at much slower rates, seed coats are very susceptible to mold, seed rot is high, many more seedlings have abnormal roots, cold tolerance is lost and seedlings are very sensitive to damage by pathogens. Partially deteriorat-

ed seed, if they must be used, should be planted only after soil temperature and moisture conditions will be continually favorable for cotton.

Unconditioned seed will give essentially the same germination and good roots in the cold and standard tests. Conditioned seed may give essentially the same germination in both tests, but there will be some abnormal roots in the cold test. Partially deteriorated seed will have less germination and many more abnormal roots in the cold test when compared to performance in the standard test. If the electrical conductivity of seed leachate is used, unconditioned seed will have a low conductivity rating, conditioned seed a higher and partially deteriorated seed a much higher rating.

The seed quality curve helped to identify three desirable traits for cotton planting-seed. These were: reduced total germination at 18C after 7 days (resulting from a slower rate of germination under the 7-day limitation); coats of seed with zero to two days exposure to moisture and heat that are resistant to mold growth at reduced temperatures; and the number of seedlings with abnormal roots, when evaluated at reduced temperatures, increases in relation to time of exposure of seed to moisture and heat.

Correlation coefficients among measurements made in the germinator (in this case 16C after 7 days) reveal the meaning for the traits relative to establishing stands of healthy plants. Field performance data were obtained in early plantings when soil temperatures were minimal for cotton (Table 1). Germination at 16C after 7 days was favorably associated with live seedlings 14 days after initial emergence. However, with time this changed to an unfavorable association. Seed

Table 1. Correlation coefficients among seed measurements made in the germinator and field performance during the period of establishing stands for cotton cultivars representing variability for the traits involved.

Variables	Period from emergence to establishment of stands in the field			
	Days From Planting			
	14	28	38	45
Germination, 7 days, 16C	.41*	-.16	-.36*	-.35*
Moldy seed coats, 7 days, 16C	.01	-.37*	-.33*	-.31
Postemergence damping-off	.80**	.44**	-.14	-.22
Plants with healthy roots	.06	.26	.41*	.44**

Period of disease

\*Significant at 5 percent level

\*\*Significant at 1 percent level

lots with high germination resulted in high and rapid field emergence. These seedlings were in turn killed by pathogens, as indicated by the high positive correlation between live seedlings 14 days after emergence and postemergence damping-off (Table 1). Seed lots with low germination and less seed with moldy coats had less damping-off, higher stands and more plants with healthy root systems 38 to 45 days after initial emergence (Tables 1 and 2). Such correlation coefficients, over the span of time when seedling pathogens take their toll, reveal what to expect from seed traits in giving field stands. The correlation coefficients with yield are more revealing. The seed lots with lower germination, less moldy seed, less damping-off, high field populations and more plants having healthy roots gave the best yields (Table 3).

Table 2. Correlation coefficients among seed measurements made in the germinator and in field performance in establishing healthy stands of plants for cotton cultivars representing variability for the traits involved.

Variables in the field	Performance in germinator, variables in 7 days, 16C	
	Germination	Moldy seed
Postemergence damping-off	.46**	.04
Plants with healthy roots	-.55**	-.32

\*\*Significant at 1 percent level

Table 3. Correlation coefficients among seed measurements made in the germinator and in field performance in establishing stands of healthy plants with yield for cotton cultivars representing variability for the traits involved.

Seed and performance measurements	Yield
Germination, 7-days, 16C	-.25
Moldy seed, 7-days, 16C	-.35*
Postemergence damping-off	-.28
Plants with healthy roots	.39*
Stand, 45-days from planting	.68**

\*Significant at 5 percent level

\*\*Significant at 1 percent level

## APPLICATION TO GENETIC IMPROVEMENT

The seed quality curve makes it possible to understand the relationships between measured seed traits and actual performances in the field. The regional S-72 data were handled in a manner to identify 6 of 35 seed measurements having the most likelihood of use in forecasting performance of planting-seed. The six seed measurements, along with the sign of the standard partial regression coefficient (SPRC) between them and field performances, are given in Table 4. The criterion for a good measurement would be the same sign showing a favorable direct relationship for each set with each field performance measurement. A high level of seed damage in a lot is known to be unfavorable for performance (Table 4). Yet, the SPRC signs for cut seed are inconsistent for seed sets and every performance character other than stand. The sign is favorable for low levels of cut seed being associated with high stands. The SPRC signs for germination as percentage of check (from Moore's Tetrazolium test) were consistent for seed sets for all performance traits other than damping-off. Where consistent, the signs show favorable relationships except for good roots. High germination as percentage of check correlates with low percentage plants with good roots in field populations. The SPRC signs for velocity of germination at 18C were inconsistent for seed sets and all performance traits other than damping-off and earliness. These relationships showed high velocity of germination was associated with low damping-off and late maturity. Total germination at 18C had consistent SPRC signs for damping-off, stand and yield. In this case, high germination was associated with high damping-off, high stands and high yield. Seed index had the same pattern of consistency as germination at 18C, with SPRC signs being the opposite. Heavy seed were associated with less damping-off, lower stands and lower yields. Leachate resistance to conductivity (or low ion content) was the only seed measurement having SPRC signs consistent for sets of seed and all performance traits. High resistance of leachate (low conductivity) was favorably correlated with less damping-off, high stands, more plants with good roots and high yield. High resistance was associated with lateness of maturity which may be considered unfavorable.

In a broad biological sense, the capability of making certain seed measurements which will indicate field performance, including yield potential, would be desirable. The S-72 data indicate that this is a viable objective. The  $R^2$  values (Table 4) indicate the likelihood of using the same seed measurements for damping-off and earliness as used for stand, good roots and yield is not good. However, the  $R^2$  values indicate that the likelihood of having a set of seed measurements which will indicate the ability of getting high stands of plants with good roots that give high yields is very good. High leachate resistance to conductivity was the only measurement having consistency and a favorable relationship with stand, good roots and yield (see Chapter 33). Four measurements (total germination as percent of check, germination at 18C, seed index and leachate resistance) would

Table 4. Broad biological implication and potential of pertinent seed traits in forecasting performance in the field. (Southern Regional data for 1970-71 and 1972-73 sets of seed.)

Seed trait	Performance trait and sign of standard partial regression coefficient									
	Damping-off		Stand		Good roots		Earliness		Yield	
	70-71	72-73	70-71	72-73	70-71	72-73	70-71	72-73	70-71	72-73
Percent damaged seed, multi-cut	+	-	-	-	-	+	+	-	+	-
Total germination, percent of check	+	-	+	+	-	-	+	+	+	+
Velocity of germination, 18C	-	-	-	+	+	-	-	-	-	+
Total germination, percent 18C	+	+	+	+	-	+	-	+	+	+
Seed index, acid-delinted	-	-	-	-	-	+	+	-	-	-
Leachate, resistance to conductivity	-	-	+	+	+	+	-	-	+	+
R <sup>2</sup> as percent	6.1		96.9**		84.2**		44.6		68.2**	
		20.6		53.3		40.7		58.9		84.5**

\*\*Significant at 1 percent level

be reliable in forecasting stand and yield. If only one field performance trait is to be considered, the  $R^2$  values indicate a greater likelihood of success in dealing with yield instead of stand (Table 4).

The information for the two sets of S-72 seed (Table 4) may be used with the seed quality curve (Figure 1) to estimate the amount of exposure to moisture and heat for the seed. The positive relationship of germination at 18C with damping-off, stand and yield indicate the seed had the average equivalent exposure of 2 to 3.5 days exposure to moisture and heat. The 1970-71 seed were produced in Arizona and South Carolina, and the 1972-73 seed were produced on the B. V. A&M University Farm at College Station, Texas. The locations of production suggest that on the average the seed would have had an excess of 2 days natural exposure to 50C and 100 percent relative humidity.

A main consideration in the genetic improvement of cotton for multi-adversity resistance (MAR) is proper alteration of seed and seedling traits having to do with performance in cool-wet soil in a manner to give high populations of plants with good roots. The desired alterations are being accomplished. If the above relationship information is correct, then such improvements should be associated with improvements in yield potential. The information shown in Figure 2 indi-

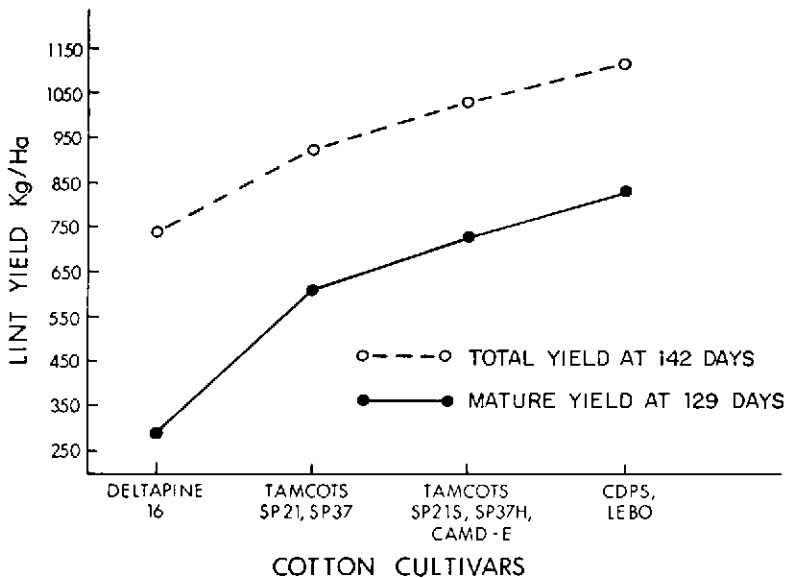

Figure 2. Total lint yield at 142 days and mature yield at 129 days (earliness) for Deltapine 16, and cultivars representing sequential hybrid pools 1, 2 and 3 of the MAR program. Performance of the MAR cultivars illustrates what genetic alteration of seed and seedling traits, having to do with establishing field stands, can mean for yield and earliness in cotton.



cates relationships with both yield and earliness. Deltapine 16 represents varieties with unaltered seed traits. Tamcots SP21 and SP37 (1967-68) represent seed alterations from the first hybrid pool of the MAR program. Tamcots SP21S, SP37H and CAMD-E (1972-73) represent further improvements in seed traits accomplished with the second MAR hybrid pool. CDPS and LEBO (1976-77) represent even further improvements in seed traits from the third hybrid pool of the MAR program. The yield and earliness data are based on averages over 1979 tests conducted in three counties near Corpus Christi, Texas, in which the entry x location interaction was not significant (Reyes *et al.*, 1980). The progressive improvement in yield and earliness from hybrid pool to hybrid pool along with improved seed traits indicate what to expect from gaining better understanding of seed.

The manner in which seed and their seedlings respond to adversity (cold-wet soil and pathogens) is the key to establishing stands. Seed traits x adversity interactions must be understood and used in successful seed quality research relative to establishing field stands. Expectations for seed performance must be based on what may occur when any or all adversities may be present under field conditions.

### ACKNOWLEDGEMENT

Assistance of associates and colleagues involved in phases of the research is gratefully acknowledged. They are authors or co-authors of the original papers in which the results were reported.

## Chapter 36

# FIELD ENVIRONMENT AND STAND ESTABLISHMENT

Donald F. Wanjura  
USDA-ARS  
Lubbock, Texas

## INTRODUCTION

Establishing a stand of cotton that consists of an adequate number of vigorous seedlings is important, because this is the first phase of the production cycle that sets a limit on yield potential. Everything that occurs subsequently only maintains or decreases the potential yield of the initial stand of cotton seedlings.

## PHYSICAL FACTORS

The physical soil parameters that most often regulate hypocotyl elongation and seedling emergence under field conditions are temperature, moisture and physical impedance (Wanjura and Buxton, 1972b). Temperature regulates both the rate and maximum length that a hypocotyl can attain in the soil. Temperatures in the optimum range (20-30C) cause more rapid and longer maximum elongation than do lower or higher temperatures. Similarly, soil moisture influences the rate and maximum elongation of cotton hypocotyls. Moisture also affects the ratio of hypocotyl to radicle length ( $H/R$ ). As moisture content decreases, the radicle elongates progressively more in relation to the hypocotyl, resulting in a decreasing value of  $H/R$ . Physical impedance also regulates the rate and maximum elongation of cotton hypocotyls. However, while temperature and moisture apparently regulate metabolic processes that produce elongation, physical impedance does not. Thus, hypocotyls that are prevented from elongating by physical impedance continue to grow, and the result is a thickening of hypocotyls (increasing diameter).

The stress imposed by low temperature and soil moisture causes increased variability of radicle elongation in germinating seedlings. In the temperature range from 38 to 15C and soil moisture tensions from  $-1/5$  to -10 bars, a temperature decrease of 6.2C caused the same increase in variability of radicle length as a soil moisture tension increase of -1.1 bars when mean radicle length was 3 mm (Wanjura and Buxton, 1972a).

There are three primary characteristics of a seedling stand that determine yield potential—population, spacing uniformity and plant vigor. While all of these

characteristics are important, plant vigor is the most difficult to evaluate. Speed or earliness of emergence correlates well with yield as a measure of plant vigor. Earliness of emergence was an indicator of plant vigor where differences in time of emergence were due to seed quality, planting depth or physical impedance (Wanjura *et al.*, 1969). In a field study, survival of plants emerging on the fifth, eighth and twelfth days after planting was 87, 70 and 30 percent, respectively, and the corresponding relative yields were 100, 46, and 29 percent.

In germination tests using seed of different sizes and densities, the rate of radicle elongation was an indicator of seedling vigor (Dalianis, 1982). Speed of seedling emergence was fastest for seed that had radicle emergence after germinating for 2 days at 20C, slightly less for seeds with radicles emerging on the third day, and significantly slower for seeds with radicles emerging on the fourth day. Plants from seeds where radicles emerged on the fourth day produced 14, 12 and 12 percent less dry weight after 32, 45 and 56 days of growth in the field, respectively, than did plants from seeds with radicles that emerged on the second day.

## PLANTING FACTORS

The goal of the planting operation is to provide a good seed zone environment to germinate seed and emerge cotton seedlings. Because of the importance of the physical factors of the seed zone environment, the seedbed should be well prepared, and the planter should place seed in the soil at a uniform depth in firm contact with warm, moist soil at an acceptable spatial uniformity. When these planting conditions are met, moisture in the seed zone can be maintained long enough for seed to germinate.

Correct seed placement is important because depth affects the moisture and temperature environment around the seed and the time and energy needed for seedling emergence. Thus, seed vigor can affect emergence from a specific planting depth. In a study by Dalianis (1982) seedling emergence from seeds planted 4 cm deep was more rapid and complete than from seeds planted 7 cm deep. Deep planting had a greater adverse effect on emergence of seedlings that required four days for radicle emergence compared with seedlings that required only two or three days to accomplish radicle emergence. Average lint yield from seed lots of three different vigor levels, as measured by germination percentage, was 891, 865 and 717 kg/ha for planting depths of 5.1, 7.6 and 10.2 cm, respectively (Wanjura *et al.*, 1969). Seedcotton yields were 440 kg/ha higher for a planting depth interval of 2.5 to 5.1 cm than at a depth of 7.6-10.1 cm (Hudspeth and Jones, 1954).

## POST-PLANTING FACTORS

The factors which most frequently cause poor emergence, even if seed are

properly planted, are soil crusting due to rainfall and low temperature. The occurrence of either of these situations is largely uncontrollable once seed are planted. Soil crusting can be best managed if the planted bed profile provides for rapid drainage of rainfall away from the seed zone and permits the use of mechanical crust breaking tools. The best strategy for circumventing low temperatures is careful selection of planting date based on soil temperature.

Holekamp *et al.* (1966) used the results from a seven year field study to develop a procedure for selecting planting date for cotton on the Southern Great Plains based on soil temperature. The earliest recommended date for planting was when the 10-day average of the minimum soil temperatures at 20 cm reached 16C. Emergence generally increased as the temperature average increased up to 19C. Below a 16C average minimum soil temperature, less than 40 percent of the seed planted produced seedlings.

Procedures for estimating the length of time between planting and emergence usually include a factor that measures cumulative heat input. One simple measure that correlated well with initial cotton emergence was developed from the results of a three-year field study by Wanjura *et al.* (1967). In this procedure, whenever 103 hours of temperature above 18C at seed level had accrued after planting, initial emergence occurred from a 5.1 cm planting depth. In another study, predictive relationships were developed between times to initial, or 45 percent of final, emergence and cumulative average daily air temperature, or cumulative average daily minimum seed level temperature (Wanjura *et al.*, 1969). Correlations between measures of cumulative heat input, such as those above, and time periods for emergence are good, provided planting depth is not changed and other factors controlling emergence remain at nonlimiting levels.

If soil crusting occurs, the force created by emerging seedlings is very important in overcoming the resistance of the crusted surface. A study by Gerard (1980) showed that emergence force of cotton seedlings was a linear function of volumetric soil moisture, number of seedlings and cross-sectional area of emerging hypocotyls. Maximum diameters of hypocotyls constrained by a mechanical crust at 22, 27, 32 and 40C averaged 0.32, 0.41, 0.34 and 0.25 cm, respectively, and the maximum forces exerted were about 350, 600, 400 and 200 g, respectively. The time required to reach maximum exertion by the seedlings was temperature dependent and ranged from 40 to 48 hours at 32C and 50 to 60 hours at 27C. Bilbro and Wanjura (1982) showed that, as soil crust resistance increased from 100 to 1000 kPa, mean emergence date increased linearly, emergence percentage and emergence rate index decreased linearly, and seedling hypocotyl diameter increased in a positive, curvilinear manner.

In a greenhouse experiment using several levels of constant temperature, Wanjura and Minton (1981) studied the effects of soil crusting on emergence by delaying emergence for 50, 100 and 150 percent of the normal emergence time for noncrusted conditions. Seedling survival and hypocotyl diameter were minimal at 26 and 24C, respectively. Seedling emergence and survival were significantly

reduced at delays between 50 and 100 percent of the normal emergence period. A similar study was conducted for 3 years under field conditions using emergence delays up to 100 percent of normal emergence time (Wanjura, 1982). Regression analysis estimated reductions in seedling survival from the expected survival under no emergence delay of 13, 32 and 58 percent, respectively, for emergence delays of 33, 66 and 100 percent. For these same levels of emergence delay, lint yield reductions averaged 10, 33 and 56 percent.

Soil salinity decreases the performance of germinating cotton seedlings according to Sexton and Gerard (1982). Results from their study indicated that each unit increase in soil salinity in the range of 4.0 to 17.0 mmhos/cm  $EC_e$  (the electrical conductivity of the soil solution) reduced the average emergence force of a cotton seedling by 23.5 g. The time required to reach maximum emergence force increased from 58 to 77 hours for soil salinities between 1.6 and 17.3 mmhos/cm, but a unit increase in salinity in the range of 17.3 to 29.7 mmhos/cm increased this time by 13 hours.

Cotton has a high  $Q_{10}$  for oxygen consumption during the germination stage (Coble, 1965). Oxygen requirements for normal respiration increased a minimum of 300 percent when temperature increased from 18 to 28C. The solubility of oxygen in water decreases about 20 percent, and the diffusion coefficient increases 30 percent over the same temperature range. Since solubility and diffusion affect oxygen availability in an opposite manner, the net effect is an apparent 10 percent increase in oxygen availability. However, Coble (1965) concluded that, if an oxygen limitation to cotton germination did occur, it would be more severe at higher temperatures. In a laboratory experiment by Bowen *et al.* (1971) cotton seed were planted in vermiculite and subjected to alternate periods of varying duration of water flooding followed by periods of drainage at different levels of constant temperature between 18 and 35C. The general trend at all temperature levels was for increased growth rate and more healthy seedlings as the ratio of drainage: flooding increased. The length of the drainage and flooding periods did not affect seedling performance at 18C. However, at higher temperatures growth rates and seedling vigor were reduced as the cycle lengths of drainage and flooding increased between 6, 12 and 24h, regardless of ratio of drainage: flooding time within cycles.

*SECTION V*

**SPECIAL TOPICS**

## Chapter 37

# FOOD AND FEEDING QUALITY OF COTTONSEED

John P. Cherry

USDA—ARS

New Orleans, Louisiana

and

Russell J. Kohel

USDA—ARS

College Station, Texas

and

Lynn A. Jones and William H. Powell

National Cottonseed Products Association, Inc.

Memphis, Tennessee

## INTRODUCTION

The research objective for production of quality cottonseed that has been a major concern of cottonseed researchers for many years is to:

“Identify the genetic variability of cottonseed composition, determine the genetic control of cottonseed traits, and develop preferred cottonseed quality germplasm; develop an understanding of developmental processes of the plant that leads to improved cottonseed composition, and develop methods to measure and evaluate quality parameters; and identify cultural practices, production systems, and handling procedures suited for the production of high quality seeds” (National Cotton Research Task Force, 1979).

During the past 80 years, intermittent periods of increased research on cottonseed composition have improved understanding of the influence genetics and growing location have on seed quality, and the quantity of such seed storage constituents as oil, protein and gossypol. These periods of increased interest, however, have been short lived, and little progress has been made toward the stated objective.

## PAST RESEARCH EFFORTS ON SEED QUALITY (1900-1970)

Most early studies on the effects of genetics and growing location on cottonseed quality were analyses of commercial samples from a limited geographical area.

They showed that both factors should be of concern in research on cottonseed composition (Garner *et al.*, 1914; Barrow-Agee, 1918; Law, 1919; Harrington, 1928; Ware, 1931; Sievers and Lowman, 1932; Hancock, 1942).

During the crop years of 1935 to 1937, Pope and Ware (1945) analyzed delinted cottonseed from 16 varieties of cotton grown at 12 to 15 locations in the United States Cotton Belt. This study was the first designed to test the relative effect of variety, location season, and the statistical interactions of these main effects on the oil and protein content of cottonseed. It showed that location averages of oil and protein data varied widely among years, indicating that levels of these constituents in cottonseed are affected by weather conditions (rainfall, temperature) (Table 1). The effect of variety on oil and protein composition was

Table 1. Mean percentages of oil and protein in moisture-free, delinted cottonseed.<sup>1</sup> Data are averages of all varieties within the 12 to 15 locations during the three year period of 1935 to 1937. (Summarized from Pope and Ware, 1945.)

Location	Component composition (percentage)					
	1935		1936		1937	
	Oil	Protein	Oil	Protein	Oil	Protein
Prattville, Ala.	—	—	19.7	24.2	20.4	24.7
Marianna, Ark.						
Delta	23.7	22.0	24.4	21.7	26.2	20.8
Upland	22.1	24.5	20.3	24.0	23.4	23.5
Experiment, Ga.	—	—	24.2	20.5	21.0	24.0
Baton Rouge, La.	23.5	20.9	23.3	25.6	26.7	21.7
Stoneville, Miss.	23.2	22.2	23.0	24.4	24.7	23.9
Statesville, N.C.	24.2	20.7	25.4	21.1	25.1	22.9
Stillwater, Okla.	21.2	24.7	17.6	24.8	19.0	26.8
Florence, S.C.	21.0	23.0	24.6	22.4	23.0	22.3
Jackson, Tenn.	20.9	22.8	21.3	24.4	21.4	23.5
Knoxville, Tenn.	21.8	22.6	22.4	22.4	21.9	24.2
College Sta. Tex.	22.1	23.3	20.7	22.6	16.1	24.8
Greenville, Tex.	21.4	24.0	19.7	23.8	17.8	25.3
Lubbock, Tex.	21.6	24.4	22.4	24.8	23.2	23.7
Brazos Valley, Tex.	—	—	—	—	19.0	24.5
Average (all locations)	22.2	22.9	22.1	23.3	21.9	23.8

<sup>1</sup>See Table 2 for list of varieties.



also shown to be significant (Table 2), as was season. For all three variables, the effects of varieties were much greater than the interactions of varieties by locations or seasons, indicating that chemical composition is basically a varietal characteristic. Thus, cottonseed oil and protein contents are dependent on variety. A consideration of the variables associated with this term in the breeding program should result in the isolation of genetic lines that are superior in either one or both of these constituents.

Further statistical comparison of the oil and protein data showed that they are independent of each other as far as their genetics is concerned but are negatively correlated when the effects of environment are included in the analysis of the data (Pope and Ware, 1945). Previously, Ware (1931) had pointed out negative correlation for cottonseed oil and protein among samples gathered from widely different environments.

Stansbury *et al.* (1954) demonstrated that the oil content of moisture-free

Table 2. Mean percentages of oil and protein in moisture-free, delinted cottonseed.<sup>1</sup> Data are averages of the 12 to 15 locations for each year. (Summarized from Pope and Ware, 1945.)

Variety	Component composition (percentage)					
	1935		1936		1937	
	Oil	Protein	Oil	Protein	Oil	Protein
'Acala (Roger)'	22.2	22.8	21.8	23.1	21.8	23.4
'Arkansas 17'	22.6	22.2	22.4	22.7	22.4	23.1
'Cleveland (W)'	21.4	22.8	20.6	23.4	20.8	23.8
'Cook 912'	23.1	22.3	22.6	23.0	22.8	23.2
'Delfos 4'	22.9	23.0	23.0	23.2	22.5	23.4
'Deltapine'	22.3	23.4	22.0	23.8	21.7	24.2
'Dixie Triumph 759'	23.1	21.8	23.1	22.4	23.0	22.8
'Farm Relief'	21.1	23.8	21.2	23.7	21.2	24.5
'Half and Half'	22.6	24.6	22.6	25.0	22.3	25.6
'Mexican Big Boll'	22.2	23.3	22.5	23.7	22.2	24.1
'Qualla'	20.0	23.0	20.0	23.0	19.7	23.5
'Rowden 2088'	22.7	22.9	22.6	23.4	22.5	24.2
'Startex 619'	22.5	23.0	22.4	23.6	22.4	23.8
'Stoneville 5'	21.8	22.3	21.8	22.7	21.1	23.3
'Triumph 44'	23.4	22.8	23.4	23.6	22.9	24.2
'Wilds 5'	21.9	22.9	21.7	22.9	21.7	23.3
Average (all varieties)	22.2	22.9	22.1	23.3	21.9	23.8

<sup>1</sup>See Table 1 for list of locations.

Table 3. Mean percentages of oil in moisture-free cottonseed kernels. Data are from varieties grown at 13 locations, 1947-1949.<sup>1</sup> (Summarized from Stansbury *et al.*, 1954.)

Location	Oil composition (percentage)			
	1947	1948	1949	Average
Statesville, N.C.	34.4	29.9	38.0	34.1
Florence, S.C.	41.5	38.5	37.9	39.3
Tifton, Ga.	33.1	37.3	38.6	36.3
Auburn, Ala.	37.4	37.6	37.6	37.5
Jackson, Tenn.	34.8	32.5	39.8	35.7
Stoneville, Miss.	35.1	37.1	36.4	36.2
St. Joseph, La.	39.9	38.2	42.0	40.0
Chickasha, Okla.	33.8	33.5	38.4	35.2
Greenville, Tex.	33.9	33.2	36.9	34.7
College Sta., Tex.	38.3	33.2	34.8	35.4
State College, N.M.	37.2	36.2	37.7	37.0
Sacaton, Ariz.	35.2	35.1	37.4	35.9
Shafter, Calif.	37.0	30.2	38.2	35.1

<sup>1</sup>Varieties listed in Table 4.

Table 4. Mean percentages of oil in moisture-free cottonseed kernels. Data are from varieties grown at 13 locations 1947-1949.<sup>1</sup> (Summarized from Stansbury *et al.*, 1954.)

Variety	Oil composition (percentage)		
	Low	High	Average
'Acala 4-42'	27.6	41.2	35.4
'Acala 1517W'	32.4	42.7	37.7
'Ravden 41B'	29.4	43.1	36.5
'Mebane Watson's'	28.8	41.0	35.8
'Stoneville 2B'	28.4	43.4	37.8
'Deltapine 15'	26.8	42.4	35.6
'Coker 100W'	28.3	43.3	36.5
'Coker Wilds'	29.6	42.6	35.9
Average	26.8	43.4	36.4

<sup>1</sup>Locations listed in Table 3.

cottonseed kernels from seeds of eight commercial cotton varieties grown at 13 locations from 1947 to 1949 ranged from 26.8 to 43.4 percent (Tables 3 and 4). Analysis of variance of these data showed that both variety and growing location

Table 5. Average oil, nitrogen and gossypol contents of moisture-free cottonseed kernels from selected varieties grown at 13 locations during three years, 1947-1949.<sup>1</sup> (Summarized from Stansbury *et al.*, 1956.)

Component	Variety				
	'Acala 4-42'	'Acala 1517W'	'Stoneville 2B'	'Deltapine 15'	'Coker 100W'
Percent of moisture-free kernels:					
Oil	35.4	37.7	37.4	35.6	36.5
Nitrogen (Protein) <sup>2</sup>	6.5(40.6)	6.3(39.4)	6.0(37.5)	6.4(40.0)	6.3(39.7)
Gossypol	0.8	1.1	1.2	1.2	1.2
Gm/100 moisture-free kernels:					
Weight	6.6	7.3	6.5	5.5	5.8
Oil	2.3	2.7	2.4	2.0	2.1
Nitrogen (Protein) <sup>2</sup>	0.4(2.5)	0.5(3.1)	0.4(2.5)	0.3(1.9)	0.4(2.5)
Gossypol	0.06	0.08	0.08	0.07	0.07

<sup>1</sup>Varieties and locations listed in Tables 3 and 4.

<sup>2</sup>Protein determined as N x 6.25.

have significant influence on the oil content of cottonseed kernels. Correlations on the basis of years at locations between kernel oil content, temperature and rainfall showed that these weather conditions significantly influenced oil quantities.

Stansbury *et al.* (1956) also analyzed the relationship between the oil, nitrogen and gossypol content of moisture-free cottonseed kernels from the samples used in the oil study summarized above (Table 5). Both variety and growing location had a highly significant influence on each constituent whether expressed as percentage of the kernel or as weight of constituent per 100 kernels. Each cultivar showed a significant positive correlation between oil and gossypol and significant negative correlations between oil and nitrogen, and gossypol and nitrogen, on the basis of percentage of constituent in the kernels. Amounts of both oil and nitrogen improved with increased kernel size.

In other studies with these same varieties, locations and crop years, Stansbury *et al.* (1953b) showed that the influence of variety and growing location factors on total, acid-soluble, phosphatide, inorganic and phytin phosphorus (calculated on a moisture-free or moisture-and-oil-free basis) was statistically significant. A significant positive correlation coefficient was obtained for the relationship between total phosphorus and phytin phosphorus contents of the moisture-free kernels. Analysis of variance showed that the influence of variety and of location and year combined to be highly significant for the iodine value of the cottonseed oil (Stansbury *et al.*, 1953a). The iodine value was negatively correlated with temperature.

Fatty acid composition of oils extracted from cottonseed of various cultivars grown at different locations during crop years 1961 and 1962 are summarized in Table 6 (Bailey *et al.*, 1966). The percentages of the major fatty acids varied significantly: palmitic, 21.4 to 27.4 percent; oleic, 13.9 to 19.5 percent; and linoleic, 48.8 to 57.2 percent. Deltapine 15 and Acala 44WR oil had the highest levels of saturated fatty acids. Acala 1517A and the two Stoneville varieties had the lowest oleic acid among all cultivars, while Stoneville 2B had one of the highest levels of this fatty acid. The malvalic acid (cyclopropene fatty acid) content in oil of the different cultivars ranged from 0.64 (Acala 44WR) to 0.98 percent (Stoneville 3203). Regression analyses showed that palmitic acid rather than stearic acid is associated with an increase in linoleic acid, indicating a connection between these fatty acids during their biosynthesis in cottonseed.

All of these earlier studies emphasized the role environment plays in cottonseed quality. A study by Barrow-Agee Laboratories (1918) showed moisture levels (rainfall) between May and July affected oil percentages of Alabama-grown cottonseed (the age of these seeds was not known). Stansbury *et al.* (1953a, 1953b, 1956) and Pons *et al.* (1953) found that the most critical period during which weather affected the percentage of oil and gossypol in maturing cottonseeds was when they had grown for 35 days beyond the flowering stage. Moisture and temperature were shown to be the most influential environmental factors.

Table 6. Fatty acid composition of oils from cottonseed of selected commercial varieties grown at different locations during crop years 1961 and 1962.<sup>1</sup> (Summarized from Bailey *et al.*, 1966.)

Variety	Fatty acid content (percentage)						
	Myristic	Palmitic	Palmitoleic	Stearic	Oleic	Linoleic	Malvalic
Lockett 88A	1.2	26.2	0.7	2.9	19.5	48.8	0.66
Deltapine 15	1.1	27.1	1.0	3.0	18.1	49.0	0.72
Acala 44WR	1.0	27.4	1.1	2.7	17.0	50.3	0.64
Paymaster 54B	0.8	23.9	0.7	3.2	17.2	53.4	0.76
Acala 4-42	1.1	24.8	1.1	3.3	16.2	52.8	0.73
Stoneville 62	0.9	23.7	0.8	2.9	17.1	53.9	0.74
Coker 100A	1.0	24.4	0.6	2.6	15.0	55.4	0.84
Paymaster 101A	0.9	21.8	0.5	3.0	18.2	54.9	0.82
Acala 1517A	1.1	23.4	0.6	2.5	16.6	55.1	0.68
Stoneville 3202	0.8	24.2	0.6	2.3	13.9	57.2	0.98
Stoneville 2B	0.8	21.4	0.9	2.9	17.9	55.2	0.76
Average	1.0	24.4	0.8	2.8	17.0	53.3	0.76

<sup>1</sup>Cottonseed grown at Chickasha, Okla.; Huntsville, S.C.; Plainview, Tex.; Scott, Miss.; Stoneville, Miss.; Tempe, Ariz.; University Park, N.M.; and Vernon, Tex.

Table 7. Mean percentages of constituents in cottonseed of 97 varieties from various genome groups of *Gossypium*. (Summarized from Pandey and Thejappa, 1975.)

Item	Genera				Mean
	<i>G. arboreum</i>	<i>G. herbaceum</i>	<i>G. hirsutum</i>	<i>G. barbadense</i>	
Number of samples	30	11	46	10	
Oil (10%-moisture basis):					
Lowest value	29.9	26.7	27.9	25.5	25.5
Highest value	35.3	35.3	37.9	34.4	37.9
Mean	32.2	31.3	33.3	28.8	32.3
Protein (moisture-free basis):					
Lowest value	28.5	30.8	30.3	32.0	28.5
Highest value	38.1	37.9	42.8	41.1	42.8
Mean	34.0	34.5	36.2	36.2	35.3
Free gossypol (moisture-free basis):					
Lowest value	0.57	0.82	0.59	1.22	0.57
Highest value	2.38	1.96	2.35	2.41	2.41
Mean	1.27	1.44	1.32	1.72	1.36

In experiments that evaluated the specific effects of environment on seed development (Gipson and Joham, 1968, 1969b; Gipson, 1970), investigators studied the effects of night temperatures on the growth of cotton plants that were adapted and not adapted to the Texas High Plains environment. Their data showed that during the growing season, as night temperature increased, so did boll development; the response was statistically linear. Seed nitrogen increased during this same period of development. On the other hand, oil composition responded in a curvilinear fashion, reaching an optimum level when the temperature was about 20C (see also Chapter 5).

### SEED QUALITY RESEARCH IN THE EARLY 1970's

Pandey and Thejappa (1975) studied the interrelationship between oil, protein and free gossypol in cottonseed of 97 varieties of *Gossypium arboreum*, *G. herbaceum*, *G. hirsutum* and *G. barbadense* (Table 7). Protein and oil, and protein and free gossypol were negatively correlated. No significant correlation, either positive or negative, was noted between oil and free gossypol. The results of this study suggested that any increase in protein content in cottonseed will result in a relative reduction in oil and free gossypol, and vice versa. The observation of

Table 8. Mean values of three seed quality traits from 17 locations in 1973.<sup>1</sup>  
(Summarized from Turner *et al.*, 1976a.)

Location	Component content (percentage)		Seed index (g/100 seed)
	Oil	Protein	
Arvin, Calif.	19.1	22.4	10.19
Chowchilla, Calif.	18.7	21.4	10.01
Tulare, Calif.	18.9	21.7	9.74
Maranna, Ariz.	18.1	20.4	9.77
Phoenix, Ariz.	19.6	21.2	9.95
Safford, Ariz.	20.6	20.3	9.62
Las Cruces, N.M.	18.9	21.6	10.11
El Paso, Tex.	20.8	20.9	10.70
Altus, Okla.	19.1	21.3	10.50
Chickasha, Okla.	22.5	20.2	10.47
Clarksdale, Ark.	17.4	22.7	8.61
Rohwer, Ark.	19.3	21.3	9.89
Portageville, Mo.	19.6	21.5	10.54
Bossier City, La.	20.5	21.5	9.84
St. Joseph, La.	21.7	18.8	9.55
Jackson, Tenn.	18.4	22.9	9.65
Rocky Mount, N.C.	19.9	20.8	9.01

<sup>1</sup>Acid-delinted, moisture-free cottonseed.

no real correlation between oil and free gossypol means that any improvement in cottonseed oil content will not result in a similar increase in gossypol content, findings important to cotton breeders interested in increasing the oil content of cottonseeds.

Percentages of oil and protein and seed index were determined on cottonseed samples from Coker 310, Deltapine 16, Lockett 4789A and Acala 1517-70 of the 1973 National Cotton Variety Tests (Tables 8 and 9) (Turner *et al.*, 1976a). Samples of four cultivars from 17 locations were used to study the seed quality parameters. Statistically, growing location had a greater influence on percentage of oil in cottonseed than the cultivar. It was suggested that a differential response of cultivars across the 17 locations for oil content was a result of genotypic differences in growth and fruiting patterns and the cultivars' response to diverse climates. Cultivar had as much influence on protein content as growing location conditions, and the interaction term of cultivar x growing location was not significant, meaning that both variables influenced cottonseed protein content in a similar way.

A negative correlation was noted between the oil and protein content of cottonseed from all cultivars used in the 1973 National Cotton Variety Tests (Turner *et al.*, 1976b), but only in Coker 310 and Deltapine 16 was the negative correlation significant. These authors suggested that if cotton geneticists checked early-stage breeding lines for cottonseed oil and protein, they could discover genotypes with higher levels of both of these constituents than current cultivars.

Table 9. Mean values of seed quality factors of four cultivars from 17 locations in 1973.<sup>1</sup> (Summarized from Turner *et al.*, 1976a.)

Cultivars	Component content (percentage)		Seed index (g/100 seed)
	Oil	Protein	
Coker 310	19.5	21.8	9.2
Deltapine 16	19.5	20.8	9.3
Lockett 4789A	19.6	21.5	10.2
Acala 1517-70	19.8	20.8	10.8

<sup>1</sup>Acid-delinted, moisture-free cottonseed.

## SEED QUALITY RESEARCH ON GLANDLESS COTTONSEED

McMichael (1959) caused considerable excitement in the cotton industry when he published data indicating that varieties with gossypol-free cottonseed could be developed simply by selecting for the proper alleles at two genetic loci. Seeds from plants that are homozygous recessive  $gl_2 gl_2 gl_3 gl_3$  ( $gl$  = glandless) are



essentially free of gossypol and related substances (McMichael, 1960; Lee, 1962; Wilson and Lee, 1971; Barrow and David, 1974). Reviews on the genetic development of glandless cottons were presented by Hess (1976, 1977a).

Lawhon *et al.* (1976) analyzed ginned cottonseeds and kernels of 16 new and experimental varieties (eight each of glanded and glandless) for oil, protein, total gossypol, fatty acids and amino acids (Tables 10, 11 and 12). Oil in glanded, ginned seed and kernels varied significantly among varieties, averaging 21.0 and 37.8 percent, respectively (Table 10). Those of glandless samples also varied widely, averaging 21.1 and 39.7 percent. There was little apparent difference in the mean values for oil in seed from the two types of cotton; the mean value of oil in glandless kernels was about 2 percent greater than that in the glanded kernels. The average weight of 100 glandless kernels was 0.5g heavier than that of the glanded kernels. Glanded, ginned cottonseed and kernels had slightly higher average percentages of protein than those of the glandless samples. A significant amount of variability was noted for seed and kernel weights and protein content among glanded and glandless varieties. Little difference was noted in the gossypol content of cottonseed kernels, which ranged from 1.1 to 1.3 percent for glanded and from 0.01 to 0.03 percent for glandless varieties. Gossypol content in the glandless cottonseed sample was probably due to contamination with glanded seeds.

Palmitic acid ranged from 17.6 to 24.8 percent and from 17.6 to 26.0 percent in cottonseed oil from glanded and glandless varieties, respectively (Table 11). Oleic acid ranged from 15.0 to 18.7 percent and from 16.0 to 19.2 percent, respectively, in oil from glanded and glandless varieties; linoleic acid ranged from 52.7 to 60.5 percent and from 52.1 to 60.4 percent in the corresponding oils. Similar ranges of cyclopropene fatty acids were noted in glanded (0.06 to 0.31 percent) and glandless (0.07 to 0.32 percent) cottonseed oils. Mean values for individual fatty acids did not vary appreciably between glanded and glandless cottonseed oils.

Protein from cottonseed of glanded and glandless varieties was found not to differ substantially in amino acid composition (Table 12). Variations among varieties within each type of cottonseed were found to be minimal and of the same general magnitude.

Progress is being made in developing glandless cottons that outyield glanded cottons in lint and seed (Cooper and Hyer, 1977; Ray and Supak, 1977; Phelps *et al.*, 1979). The protein and oil composition of some varieties of glandless seed is comparable or better than that of glanded varieties and is affected by genetic and agronomic factors (Cherry *et al.*, 1977; Cooper and Hyer, 1977; Phelps *et al.*, 1979).

Table 10. Analytical data<sup>1</sup> on cottonseed and kernels of 16 varieties.<sup>2</sup> (Summarized from Lawhon *et al.*, 1976.)

Analyses	Variety								Mean
	A	B	C	D	E	F	G	H	
Ginned cottonseed, glanded:									
Oil (percent)	23.2	20.0	21.2	17.4	21.7	21.8	21.4	21.6	21.0
Protein (percent)	21.2	23.6	23.2	22.2	23.2	25.9	24.0	21.6	23.1
Weight (g/100 seed)	10.8	11.3	8.7	9.1	10.7	10.1	10.3	9.1	10.1
Ginned cottonseed, glandless:									
Oil (percent)	21.0	20.0	17.6	20.7	23.9	23.4	25.6	16.5	21.1
Protein (percent)	23.0	24.0	23.0	24.0	23.3	23.1	20.0	19.6	22.5
Weight (g/100 seed)	11.6	10.9	7.6	12.6	13.0	11.9	10.4	7.0	10.6
Kernels, glanded:									
Oil (percent)	40.5	36.7	38.1	36.4	37.7	37.8	35.6	39.4	37.8
Protein (percent)	38.5	41.6	39.1	41.1	39.2	40.0	40.9	36.8	39.3
Total gossypol (percent)	1.3	1.3	1.3	1.1	1.3	1.2	1.3	1.2	1.2
Weight (g/100 kernels)	6.0	6.8	5.6	6.9	7.3	6.9	6.4	6.2	6.5
Kernels, glandless:									
Oil (percent)	39.5	38.3	38.3	36.6	40.6	39.7	43.9	40.3	39.7
Protein (percent)	41.0	41.4	40.0	40.9	39.9	39.2	31.6	37.3	38.9
Total gossypol (percent)	0.02	0.01	0.01	0.02	0.01	0.03	0.01	0.03	0.02
Weight (g/100 kernels)	6.6	6.7	6.5	9.0	8.3	7.5	5.5	6.0	7.0

<sup>1</sup>Dry weight basis.<sup>2</sup>Cottonseed supplied by ACCO Seed, Plainview, Tex.; L. Bird, Texas A&M Univ.; Coker's Pedigreed Seed Co., Lubbock, Tex.; Dunn Seed Farms, Inc., Lamesa, Tex.; Gregg Seed Farms, Plainview, Tex.; Lambright Seed Farms, Slaton, Tex.; Lockett Seed Co., Vernon, Tex.; N.R. Malm, New Mexico State Univ.; and U.S. Cotton Research Station, Shafter, Calif.

Table 11. Composition of fatty acids (percentage) in cottonseed oils of 16 varieties.<sup>1</sup> (Summarized from Lawhon *et al.*, 1976.)

Fatty acids	Variety								Mean
	A	B	C	D	E	F	G	H	
Glanded cottonseed oil:									
Myristic	0.8	1.5	0.7	1.0	1.0	0.6	0.8	0.6	0.9
Palmitic	23.9	24.6	24.0	17.6	22.1	22.1	24.5	24.8	23.0
Stearic	2.1	2.2	2.1	2.2	2.0	2.2	2.4	2.5	2.2
Oleic	18.3	18.1	16.3	18.2	16.4	20.7	18.7	15.0	17.7
Linoleic	54.9	52.7	56.4	60.5	58.0	53.9	53.0	57.1	55.8
Cyclopropenes	0.28	0.28	0.10	0.31	0.31	0.06	0.23	0.29	0.23
Glandless cottonseed oil:									
Myristic	0.8	0.7	0.7	0.9	0.8	0.7	0.6	0.6	0.7
Palmitic	24.0	20.3	17.6	26.0	24.1	22.1	26.0	20.8	22.6
Stearic	2.1	2.0	2.1	2.4	2.0	1.9	2.4	2.1	2.1
Oleic	16.0	17.1	19.2	17.9	17.3	18.6	16.3	19.2	17.7
Linoleic	56.5	59.4	60.4	52.1	55.8	56.1	54.7	57.0	56.5
Cyclopropenes	0.28	0.32	0.24	0.11	0.07	0.27	0.23	0.28	0.23

<sup>1</sup>Sources of varieties noted on Table 10.

Table 12. Amino acid composition of cottonseed protein of 16 varieties.<sup>1</sup>  
(Summarized from Lawhon *et al.*, 1976.)

Amino acids (g/16g N)	Glanded seed			Glandless seed		
	High	Low	Mean	High	Low	Mean
Lysine	4.6	4.2	4.4	4.6	4.3	4.5
Histidine	2.8	2.6	2.7	2.9	2.6	2.7
Arginine	12.3	10.9	11.6	13.2	11.2	12.1
Tryptophan	1.4	1.0	1.2	1.3	1.0	1.2
Half-cystine	3.4	2.3	2.6	2.6	2.2	2.4
Aspartic acid	9.5	8.8	9.2	9.3	8.6	9.1
Threonine	3.2	2.8	3.0	3.2	2.8	3.0
Serine	4.4	3.9	4.2	4.4	3.9	4.2
Glutamic acid	22.4	20.5	21.7	22.4	19.9	21.6
Proline	4.0	3.1	3.6	3.7	3.1	3.4
Glycine	4.5	3.8	4.1	4.6	3.7	4.1
Alanine	4.2	3.6	3.9	4.2	3.6	3.9
Valine	4.7	4.3	4.5	4.8	4.1	4.4
Methionine	1.8	1.3	1.5	1.7	1.2	1.4
Isoleucine	3.4	3.0	3.1	3.2	2.8	3.0
Leucine	6.1	5.5	5.8	6.1	5.3	5.7
Tyrosine	3.3	2.8	3.1	3.6	1.6	2.9
Phenylalanine	5.6	5.0	5.4	6.2	5.0	5.4
Available lysine	4.1	3.9	4.0	4.2	3.9	4.1

<sup>1</sup>Sources of varieties noted on Table 10.

Bell and Stipanovic (1977) pointed out that although gossypol must be eliminated for cottonseed to become a major source of high protein food and feed, the pigment glands confer host resistance to many insects and herbivores. Flavonols, such as catechins, procyanidins and condensed tannins are also involved in resistance to several diseases (Chapter 38). The pigments decrease the need to apply costly insecticides, and optimal combinations of terpenoids and flavonoids for host plant resistance are being sought.

The alternative is to grow glandless cottons in areas such as the Texas High Plains and parts of California where insect pests are not a serious problem in cotton farming. Glanded cottons would be grown in locations where such insects as bollworms and bollweevils are problems. Another possibility would be to breed cotton plants with the genetic character called "delayed gland morphogenesis", a character mainly noted in certain wild species (Lukefahr and Fryxell, 1967). The initial cells for gland formation occur in the seed embryos, but there is no deposition of gossypol until they begin to germinate. All other aerial portions of the cotton plant (leaves, stems, bolls) have as many glands and as much gossypol as present commercial varieties.

## COMPARISON OF SEED QUALITY DATA DEVELOPED THROUGH THE YEARS

The protein and oil composition of moisture-free, delinted cottonseed has not changed very much over the years (Tables 1-5, 7-10). For example, Pope and Ware (1945) found oil content of 16.1 to 26.7 percent and protein content of 20.5 to 26.8 percent. Thirty years later, Lawhon *et al.* (1976) found oil content to be 16.5 to 25.6 percent, and protein content to be 19.6 to 24.0 percent. Turner *et al.* (1976a) reported average values of 19.6 percent for oil and 24.8 percent for protein. On a moisture-free kernel basis Stansbury *et al.* (1956) reported values for oil, protein and gossypol of 35.4 to 37.7 percent for oil, 39.3 to 40.6 percent for protein and 0.8 to 1.2 percent for gossypol. Pandey and Thejappas' (1975) averages for these same constituents were 32.8, 40.2 and 1.4 percent, respectively; Lawhon *et al.* (1976) published values of 37.8, 39.3 and 1.2 percent, respectively. These data show that although seed storage constituents can be influenced by cultivar, growing location and crop season, little has been done through the years to take advantage of this vast wealth of variability to improve cottonseed quality.

## RECENT COTTONSEED QUALITY RESEARCH

A number of ways to improve cottonseed quality and augment the returns to the producers and processors of cottonseed, as well as influence the end-use value, have been identified (Table 13) (Carter *et al.*, 1979). In the latter part of the 1970's a cooperative effort was undertaken to develop a data base on the physical and chemical composition of cottonseed from select cultivars grown in different locations in the Cotton Belt. In California, the data base study included four Acala varieties grown during three crop seasons at four locations in the San

Table 13. Identified factors that affect the value of cottonseed (from Carter *et al.*, 1979).

Factor	Needed change
Gossypol	Lower or eliminate
Oil	Increase
Protein	Increase
Hulls	Decrease—improve resistance to mechanical and microbiological damage
Linters	Decrease
Cyclopropene fatty acids	Decrease or eliminate
Essential amino acids	Increase—especially lysine and methionine
Nongossypol pigments	Identify and remove flavonoids
Flavor	Identify and improve
Sugars	Remove raffinose and stachyose

Joaquin Valley. In Texas the seed of the four standard cultivars of the National Variety Tests grown at eight locations for one year and at four locations for three crop years were examined. The specific cultivars and locations are listed in the appropriate tables and figures.

Twenty-three seed quality characteristics of cottonseed were related to genetic and growing location, including moisture, seed index, hull, lint and kernel percentages, quantity and quality indexes, and grade, germinability, proximate composition (including oil, protein, carbohydrate, crude fiber and ash), free fatty acids, free and total gossypol, and cyclopropene fatty acids. The nitrogen solubility, differential settling tests and extractability of nonstorage and storage proteins were examined to evaluate the processability of cottonseed into food. Studies of fatty acids, amino acids and the polyacrylamide gel electrophoretic properties of proteins from cottonseed were also conducted.

Seed grade factors (quantity, quality index and grade) were determined by the rules of the National Cottonseed Products Association (1977-78). Tests for lint, proximates [protein (or nitrogen  $\times$  6.25), oil, carbohydrates, ash and fiber], free fatty acids, free and total gossypol and fatty acid profile were made in accordance with the official and tentative methods of the American Oil Chemists' Society (1976). The methods of Kaiser *et al.* (1974), Brown (1969), Rao *et al.* (1963), Lyman *et al.* (1953) and Vix *et al.* (1949) were used to determine protein amino acid profiles, cyclopropenoid fatty acids, epsilon-amino-free lysine, nitrogen solubility and differential settling, respectively. Nonstorage and storage protein extractability were determined by the selective extraction procedure of Berardi *et al.* (1969) with the following modifications: (1) the ratio of hexane-defatted flour to extractant (water, 10 percent NaCl solution) was 1:20 (w/v), and (2) a 10 percent NaCl solution was used to solubilize storage proteins. The method of Lowry *et al.* (1951), with serum bovine albumin as the standard, was used to determine quantity (mg/ml) of extractable protein. Polyacrylamide disc-gel electrophoresis of nonstorage and storage proteins was conducted by the procedure of Cherry *et al.* (1970).

## RESULTS BY LOCATIONS

The analysis of variance showed that agronomic and/or environmental factors influence most of the quality factors (Table 14). Significant location  $\times$  cultivar interactions for most of the quality factors suggested that all cultivars did not respond the same across locations.

**Texas Results**—Among the four cultivars grown in Texas, Acala 1517-70 generally maintained the highest and Lockett 3789A the lowest percentages of oil (Figure 1) (Cherry *et al.*, 1978b,c). Oil contents among locations were consistently highest at the west (dry) and south (Subtropical and Coastal Bend) locations, and lowest in the north (High Plains and Rolling Plains) region. Significant variability in oil percentages was noted among cottonseed of all cultivars from

Table 14. F-test for each percentage quality factor of cottonseed (from Cherry *et al.*, 1978b).

Quality factor	Cultivar (C) <sup>1</sup>	Location (L) <sup>1</sup>	C X L <sup>1</sup>
df <sup>2</sup>	3	7	21
Hulls	4.79**	11.29**	1.58
Kernels	5.57**	19.65**	2.44*
Lint	74.79**	30.75**	7.33**
Quantity index	2.25	120.69**	3.22**
Quality index	9.35**	340.87**	4.96**
Seed grade	12.69**	294.95**	2.67**
Seed index	45.00**	24.98**	2.39*
Protein <sup>4</sup>	15.98**	6.76**	3.32**
Oil <sup>4</sup>	14.81**	23.38**	4.03**
Total sugars <sup>5</sup>	2.94*	2.74*	3.17**
Ash <sup>5</sup>	0.98	31.97**	3.18**
Crude fiber <sup>5</sup>	2.40	2.57*	0.43
Free fatty acids <sup>6</sup>	2.08**	585.59**	9.38**
Free gossypol <sup>5</sup>	18.10**	5.52**	6.64**
Total gossypol <sup>5</sup>	29.10**	15.86**	11.13**
c-Free amino lysine <sup>7</sup>	2.73	6.72**	0.70
N-Solubility <sup>8</sup>	17.89**	5.11**	2.87**
Germinability	3.86*	73.25**	9.96**
df <sup>2,3</sup>	3	6	18
Cyclopropanoid fatty acids <sup>5</sup>	2.78**	26.14**	7.22**
Differential settling overflow:			
Protein	1.93	7.27**	2.22*
Free gossypol	35.70**	40.69**	9.30**
Total gossypol	22.40**	15.53**	1.92
Differential settling underflow:			
Protein	1.87	14.44**	7.68**
Free gossypol	8.92**	25.90**	5.37**
Total gossypol	10.57**	36.44**	6.44**
Protein extractability:			
Nonstorage	1.57	0.50	0.95
Storage	0.23	2.51*	1.27

<sup>1</sup>\*,\*\*Significant at the 0.05 and 0.01 level of probability, respectively, by the Newman-Keuls multiple range test (Steel and Torrie, 1960).

<sup>2</sup>Degrees of freedom.

<sup>3</sup>Pecos location omitted from these tests.

<sup>4</sup>Moisture-, lint-free basis.

<sup>5</sup>Moisture-free kernel basis.

<sup>6</sup>Percentage in oil.

<sup>7</sup>g/100g sample.

<sup>8</sup>Percentage of total protein.

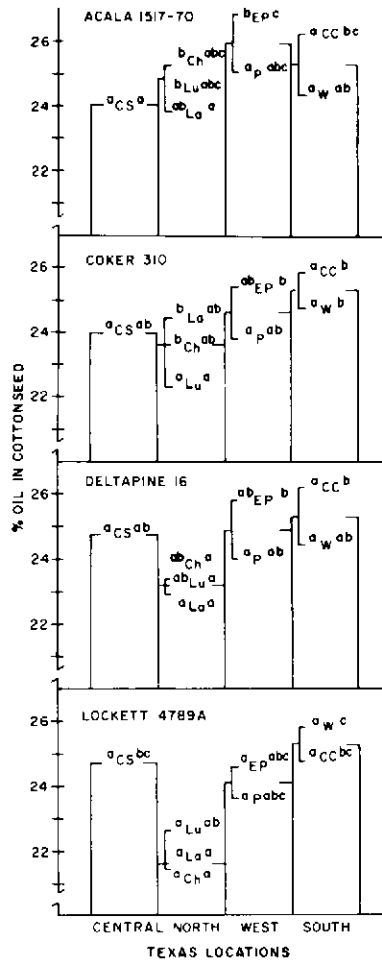

Figure 1. Mean values of oil in Texas-grown cottonseed (moisture-free, lint-free). CC, Corpus Christi; CS, College Station; Ch, Chillicothe; EP, El Paso; La, Lamesa; Lu, Lubbock; P, Pecos and W, Weslaco.

Chillicothe, Lamesa, Lubbock and El Paso.

The highest percentage protein for cottonseed occurred at College Station, and the lowest at Lubbock and Lamesa (Figure 2) (Cherry *et al.*, 1978b,c). Coker 310 generally had the highest percent protein among cultivars. Acala 1517-70 and Deltapine 16 showed the greatest differences among Texas locations, whereas Lockett 4789a displayed little variability.

Mean values for gossypol are shown in Figure 3. No consistent pattern for location over cultivars or cultivar over locations was readily evident. Apparently



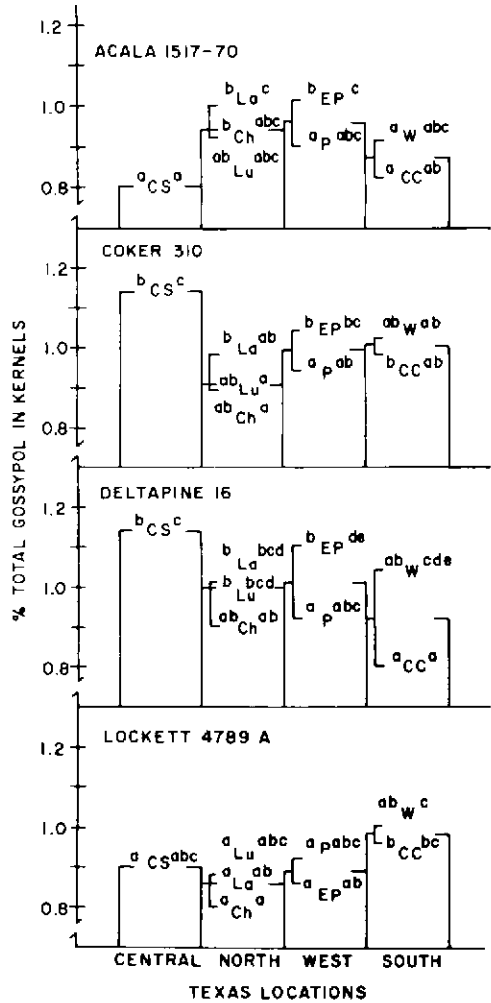
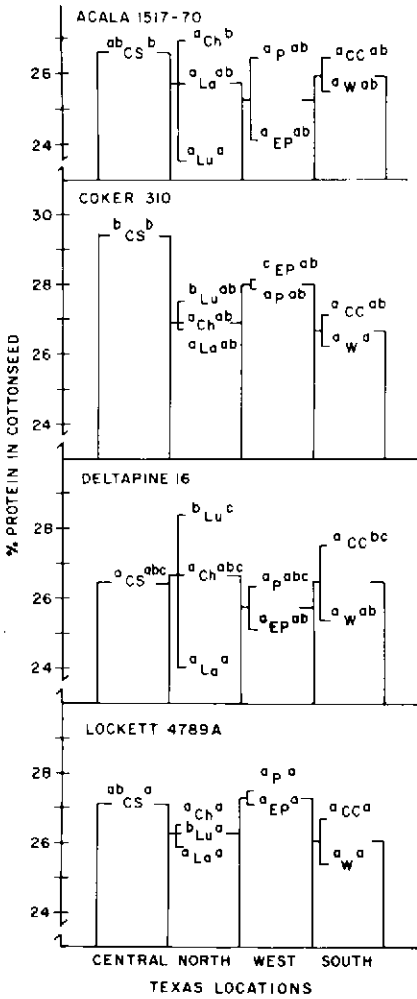

Figure 2. (Left) Mean values of protein in Texas-grown cottonseed (moisture-free, lint-free). (See Figure 1 for abbreviations.)

Figure 3. (Right) Mean values of gossypol in Texas-grown cottonseed kernels (moisture-free). (See Figure 1 for abbreviations.)

gossypol has a high environment x genotype interaction, as is indicated in Table 14.

The amino acid content of most of the cottonseed was significant or highly significant for the statistical variables of cultivar, location and/or cultivar x

Table 15. Amino acid composition (g/100 g sample) of fat-free cottonseed flour from cultivars grown in various Texas locations (from Cherry *et al.*, 1978b).

Amino acid	Range of amino acids			F-test for percentage amino acids <sup>1</sup>		
	Low	High	Mean	Cultivars	Locations	CxL
				(C)	(L)	
Alanine	1.00(C,W) <sup>2</sup>	2.26(L,EP)	2.12	2.306	0.432	1.137
Valine <sup>1</sup>	1.66(D,CS)	2.61(A,CC)	2.20	2.688	4.135*	3.005*
Glycine	2.08(A,Lu)	2.35(L,EP)	2.21	3.207*	1.608	0.966
Isoleucine <sup>1</sup>	1.20(D,CS)	1.86(A,C)	1.59	2.231	2.914*	2.399*
Leucine <sup>1</sup>	2.88(D,La)	3.84(C,W)	3.12	3.418*	3.504*	1.969
Proline	1.83(L,Lu)	2.13(A,CC)	1.96	1.463	1.476	0.610
Threonine <sup>1</sup>	1.42(A,W)	1.98(C,C)	1.74	6.412**	2.635*	1.797
Serine	2.14(D,La)	2.59(D,C)	2.40	3.971*	2.142	1.243
Methionine <sup>1</sup>	0.59(A,W)	0.96(C,W)	0.74	3.202*	1.391	2.201*
Phenylalanine <sup>1</sup>	2.62(C,W)	3.02(L,Lu)	2.82	1.996	0.719	0.989
Aspartic acid	4.58(D,EP)	5.25(L,La)	4.93	3.147*	3.773**	0.809
Glutamic acid	9.46(D,CC)	11.15(C,CC)	10.53	2.009	2.953*	1.131
Tyrosine	1.29(D,La)	1.68(C,CC)	1.51	4.036*	4.129**	1.754
Lysine <sup>1</sup>	2.28(D,EP)	2.63(L,EP)	2.46	3.832*	6.588**	1.791
Histidine <sup>1</sup>	1.12(L,CS)	1.62(D,Lu)	1.41	0.629	2.466*	4.985*
Arginine <sup>1</sup>	4.39(D,La)	6.42(C,CC)	5.43	2.099	5.384**	0.905
Half-cystine	0.70(L,EP)	1.08(C,CC)	0.88	8.038**	7.751**	2.112*
Total	44.34(D,La)	50.82(C,CC)	48.02	3.115*	2.376	1.105

<sup>1</sup>Essential amino acids with respect to their growth effect in the white rat.

<sup>2</sup>Cultivar and location. Cultivars: A, 'Acala 1517-70'; C, 'Coker 310'; D, 'Deltapine 16'; L, 'Lockett 4789A'. Locations: C, Chillicothe; CC, Corpus Christi; CS, College Station; EP, El Paso; La, Lamesa; Lu, Lubbock; P, Pecos; and W, Weslaco.

<sup>3</sup>\*,\*\*Significant at the 0.05 and 0.01 level of probability, respectively.

Table 16. Fatty acid composition (percentage) of oil from cottonseed kernels of cultivars grown in various Texas locations (from Cherry *et al.*, 1978b).

Fatty acid	Range of fatty acids			F-test for percentage fatty acids <sup>2</sup>		
	Low	High	Mean	Cultivars(C)	Locations(L)	CxL
Myristic (C14:0)	0.68(C,Lu) <sup>1</sup>	1.16(L,CC)	0.82	102.714**	81.937**	4.813**
Palmitic (C16:0)	21.63(A,Lu)	26.18(L,CC)	23.68	8.705**	96.801**	2.728**
Palmitoleic (C16:1)	0.56(D,CS)	0.82(A,CC)	0.65	29.786**	21.528**	2.328**
Stearic (C18:0)	2.27(L,C)	2.88(C,W)	2.55	3.540*	12.296**	1.621
Oleic (C18:1)	15.17(D,CS)	19.94(L,CC)	17.41	356.913**	79.995**	6.892**
Linoleic (C18:2)	49.07(A,CC)	57.64(C,Lu)	54.54	238.386**	229.044**	10.084**

<sup>1</sup>Cultivar and location. Cultivars: A, 'Acala 1517-70'; C, 'Coker 310'; D, Deltapine 16'; L, 'Lockett 4789A'. Locations: C, Chillicothe; CC, Corpus Christi; CS, College Station; EP, El Paso; La, Lamesa; Lu, Lubbock; P, Pecos; and W, Weslaco.

<sup>2</sup>\*,\*\*Significant at the 0.05 and 0.01 level of probability, respectively.

location (Table 15) (Cherry *et al.*, 1978b,c). Each of the cultivars had specific amino acids that were lower than in other cultivars, whereas Coker 310 and Lockett 4789A each accounted for 12 of the highest levels of specific amino acids. Variations in threonine and half-cystine had a strong genotype component. The latter amino acid was also strongly influenced by environment, as was lysine.

Most cottonseed oil fatty acid levels varied significantly for cultivar, location and cultivar x location (Table 16) (Cherry *et al.*, 1978b,c). Because of the percentage expression, a cultivar or location high in one abundant fatty acid would be low in another fatty acid.

Table 17. Mean values of cottonseed quality traits of 'Acala' cultivars grown at four California locations, 1975-1977.<sup>1</sup>

Quality factors <sup>2</sup>	'Acala' cultivars		Covariance	Lowest standard deviation
	'SJ-2'	'SJ-5'		
Hull	41.60a	36.89b	5.2	1.50
Kernel	45.37a	51.63b	3.5	0.96
Lint	19.03a	21.81b	4.9	1.01
Quantity index	97.29a	109.59b	1.0	3.00
Grade	96.73a	109.29b	1.3	3.30
Oil	19.03a	21.81b	1.2	0.64
Protein	22.25a	23.44b	1.8	0.11
Free fatty acids	1.20a	0.86b	2.4	0.44
Free gossypol	1.03a	0.73b	6.4	0.05
Total gossypol	1.09a	0.80b	5.7	0.04
Phosphorus	0.94a	0.88b	7.0	0.05
Differential settling overflow:				
Free gossypol	0.03a	0.02b	6.4	0.05
Total gossypol	0.06a	0.04b	5.7	0.04

<sup>1</sup>Means among cultivars having the same letter are not significantly different according to the Newman-Keuls multiple range test. Values for seed index ('SJ-2', 11.68; 'SJ-5', 11.16), crude fiber (2.20; 2.09), ash (5.07; 5.15), total sugars (6.65; 6.70),  $\epsilon$ -free amino lysine (3.86; 3.85), N-solubility (97.46; 97.90), quality index (99.32; 99.74) and differential settling overflow protein (61.44; 61.06) were not significantly different for the two cultivars.

<sup>2</sup>Hull, kernel, and lint are presented as percentage (%) of seed; oil and protein are % of linted seed; free fatty acid is % of oil; free and total gossypol, phosphorus, crude fiber, ash and total sugars are % of kernels;  $\epsilon$ -free amino lysine is g/100g flour; N-solubility is % of total protein; and differential settling overflow protein and free and total gossypol is % of flour. All of these values are presented on an "as is" moisture value, which was 9.35 and 9.08 for the 'Acala SJ-2' and 'Acala SJ-5' cottonseed, respectively, values that were not significantly different.

A summary of the effects of cultivar and growing location on all of the other seed quality factors included in these studies was presented by Cherry *et al.* (1978b).

**California Results**—Select data on cottonseed from Acala SJ-2 and Acala SJ-5 in California are presented in Tables 17, 18 and 19. Statistically significant improvements in seed quality of SJ-5 over SJ-2 include (1) both a reduced portion of the seed as hull and linters and an increase in the percentage of kernel, (2) decreased amounts of gossypol and cyclopropene fatty acids, (3) improved quantities of oil and protein and (4) higher levels of essential amino acids and select fatty acids (a decrease in palmitic acid and a subsequent increase in oleic acid).

Table 18. Mean values of amino acids of flour from cottonseeds of 'Acala' cultivars grown at four California locations, 1975-1977.<sup>1</sup>

Amino acid (g/100g flour)	'Acala' cultivars	
	'SJ-2'	'SJ-5'
Alanine	2.00a	2.03a
Valine <sup>2</sup>	2.10a	2.14a
Half-Cystine	0.79a	0.82a
Arginine <sup>2</sup>	6.47a	6.62a
Lysine <sup>2</sup>	2.24a	2.26a
Histidine <sup>2</sup>	1.50a	1.59b
Tyrosine	1.54a	1.54a
Aspartic acid	4.84a	4.84a
Glutamic acid	10.38a	10.40a
Phenylalanine <sup>2</sup>	2.68a	2.78a
Glycine	2.10a	2.12a
Isoleucine <sup>2</sup>	2.55a	2.57a
Leucine <sup>2</sup>	2.96a	3.01a
Proline	1.92a	1.95a
Threonine <sup>2</sup>	1.64a	1.67a
Serine	1.41a	1.43a
Methionine <sup>2</sup>	0.64a	0.66a

<sup>1</sup>Means among cultivars having same letter are not significantly different according to the Newman-Keuls multiple range test.

<sup>2</sup>Essential amino acid with respect to growth of rats.

Table 19. Mean values of fatty acids of oil from cottonseed of 'Acala' cultivars grown at four California locations, 1975-1977.<sup>1</sup>

Fatty acid (percentage) <sup>2</sup>	'Acala' cultivars		Covariance	Lowest Standard deviation
	'SJ-2'	'SJ-5'		
Palmitic (C16:0)	23.32a	22.69b	0.57	0.26
Palmitoleic (C16:1)	0.72a	0.64b	7.4	0.02
Stearic (C18:0)	2.17a	2.29b	3.2	0.07
Oleic (C18:1)	16.63a	17.26b	0.98	0.20
Cyclopropene	0.90a	0.84b	2.7	0.04

<sup>1</sup>Means among cultivars having the same letter are not significantly different according to the Newman-Keuls multiple range test.

<sup>2</sup>Values for myristic (C14:0), ('SJ-2', 0.75; 'SJ-5', 0.74), linoleic (C18:2), (55.80; 55.84), and linolenic (C18:3), (0.35; 0.34) acids were not significantly different for the two cultivars.

**Acala Cottonseed Quality In California And Texas**—Percentages of oil in cottonseed of Acala cultivars SJ-2, SJ-4 and SJ-5 grown at four locations in California ranged from 20 to 27 percent, and that of Acala 1517-70 from eight areas in Texas was 24 to 26 percent (Figure 4) (Cherry *et al.*, 1979b). Average oil content of all samples of Acala cottonseed from the two states was approximately 25 percent for Texas and 24 percent for California. By Newman-Keuls multiple-range analysis (Steel and Torrie, 1960) only the highest value (SJ-5 grown at Huron, California) was significantly different from all values less than 24.5 percent.

The protein content of cottonseed from Acala 1517-70 grown in Texas ranged from 24.5 to 26.6 percent (Figure 5) (Cherry *et al.*, 1979b). In California, values ranged between 26 and 29 percent. The overall average for Texas-grown cottonseed was 25.6 percent, that for California 26.6 percent. Most of the values were not significantly different; however, percentage of protein from SJ-2 grown at Wheeler Ridge was significantly different from values below 25.2 percent.

Acala SJ-2 cottonseed from all locations of California had higher percentages of total gossypol (1.08 to 1.27 percent) than the other Acala cultivars, SJ-4, SJ-5 and 1517-70 (Figure 6) (Cherry *et al.*, 1979b). The average of gossypol content in all samples from California and Texas were 1.0 and 0.9 percent, respectively.

These data show that during the past ten years, since the development of Acala SJ-2, the breeding program in California has selectively increased oil and protein content in Acala cottonseed (SJ series) and reduced gossypol (see Figures 4, 5 and 6.).

A significantly higher level of lysine (2.67g/100g of hexane-defatted flour) was noted for Acala SJ-4 cottonseed than from those of the other Acala cultivars;

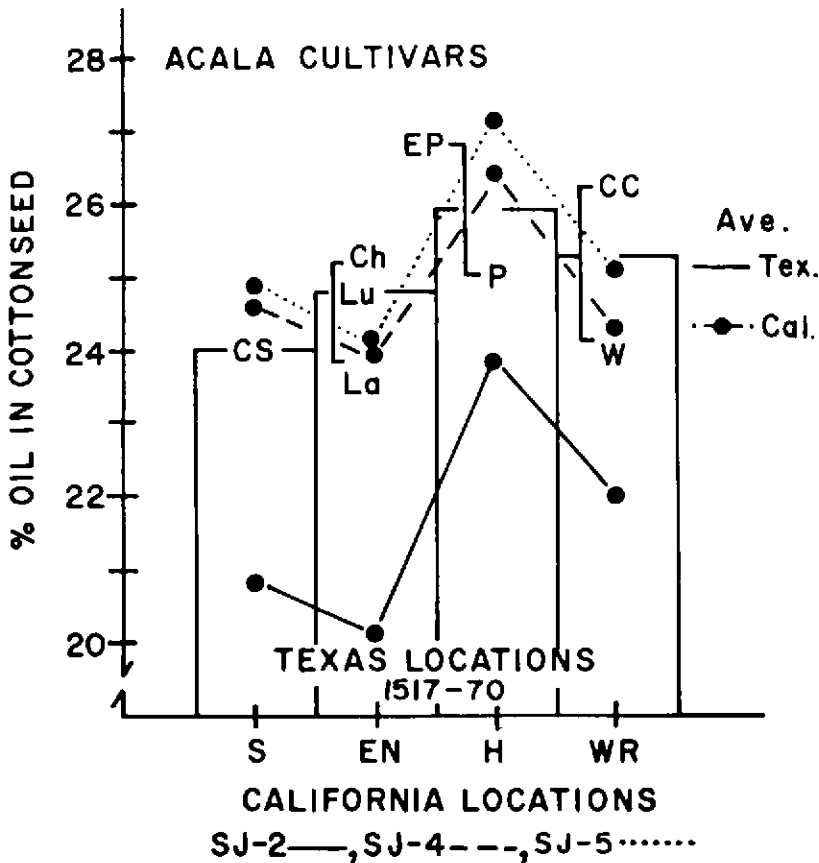

Figure 4. Cottonseed (moisture-free, lint-free) oil content from 'Acala' cultivars grown in Texas and California. California: EN, El Nido; H, Huron; S, Strathmore, and WR, Wheeler Ridge. Texas: CC, Corpus Christi; CS, College Station; Ch, Chillicothe; EP, El Paso, La, Lamesa; Lu, Lubbock; P, Pecos; and W, Weslaco. (From Cherry *et al.*, 1979b).

all other lysine values in cottonseed flours from cultivars grown in California ranged between 2.14 and 2.34 (Figure 7). The lysine content of flour from Acala 1517-70 grown in Texas ranged between 2.31 and 2.62. The average lysine values for all California and Texas samples were approximately 2.32 and 2.42, respectively.

Among the sources of Texas-grown cottonseed, flour of Acala samples from College Station had significantly higher amounts of methionine than samples from other locations (Figure 7). Cottonseed flours from the other Texas locations contained similar amounts of methionine, ranging from 0.6 to 0.7g/100g of

sample. California-grown cottonseed produced flours containing between 0.64 and 0.80g of methionine/100g of sample. The overall average methionine content of flours from California cottonseed was slightly higher than those from Texas.

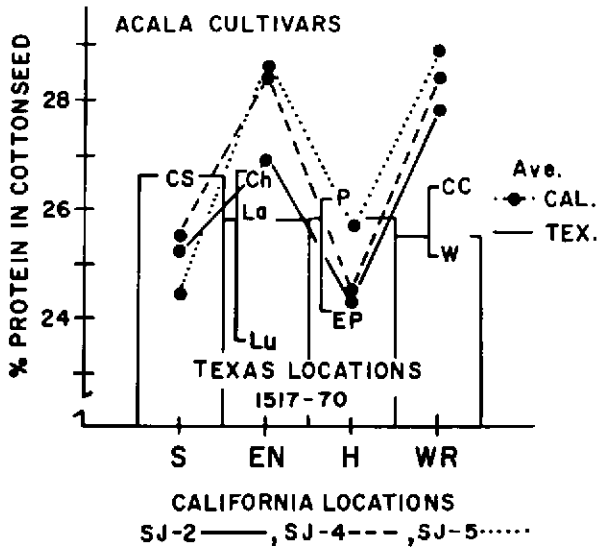

Figure 5. Cottonseed (moisture-free, lint-free) protein content from Acala cultivars grown in Texas and California (from Cherry *et al.*, 1979b). (See Figure 4 for abbreviations.)

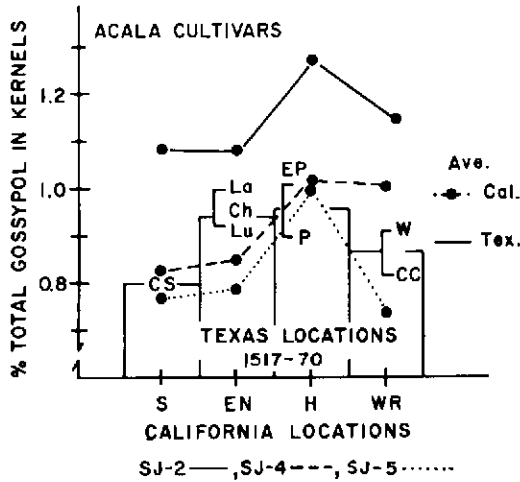

Figure 6. Total gossypol content in cottonseed kernels (moisture-free) of 'Acala' cultivars grown in Texas and California (from Cherry *et al.*, 1979b). (See Figure 4 for abbreviations.)



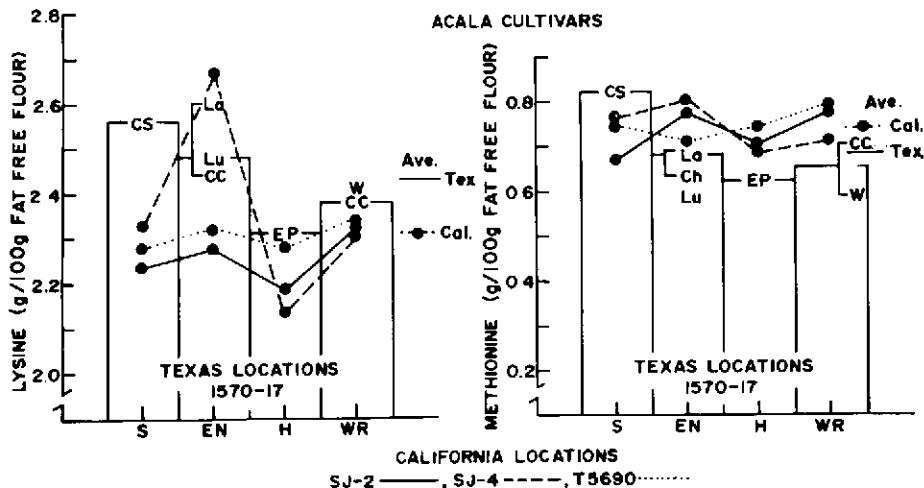

Figure 7. Lysine and methionine content of hexane-defatted flour ("as is" moisture) of cottonseed from Acala cultivars grown in Texas and California (from Cherry *et al.*, 1979b). (See Figure 4 for abbreviations.)

## OTHER FACTORS AFFECTING COTTONSEED QUALITY

### PINK BOLLWORM CONTAMINATION

Cultivars of *Gossypium hirsutum* L. and *G. barbadense* L. are susceptible to pink bollworm [*Pectinophora gossypiella* (Saunders)] and require application of insecticide to insure that growers will receive adequate compensation for their fiber and seed. Field infestation levels of approximately 50 percent, with no more than one larva per boll, have little effect on cotton-quality (Brazzel and Gaines, 1956, 1957), but infestation levels of 60 percent or greater causes a decrease of as much as 34 percent in the cotton crop because of lower yields and poorer fiber and seed quality (Lukefahr and Martin, 1963).

Cherry and Goodwin (1978) showed that pink bollworms affect the physical and chemical composition of cottonseed, and therefore, the processability of cottonseed into functionally and nutritionally useful food and feed ingredients. As the number of pink bollworms per boll increased from 0 to 12, the level of oil, protein and free and total gossypol tended to decrease. Pink bollworm contamination also caused fluctuations in fatty acid and essential amino acid content—quality was highest in bolls containing 0 and 5-6 insects. Extractability of non-storage and storage proteins fluctuated between high and low quantities in cottonseed from bolls containing 0 to 5 pink bollworms but decreased as infestation increased to 12 insects. Polyacrylamide gel patterns showed that changes oc-

curred in the type of protein present in water and alkaline pH extracts. No doubt biochemical mechanisms operating in the cottonseed during development are being affected by the pink bollworms in the boll, and this in turn affects the quality of cottonseed available for food and feed processing.

### MODULE STORAGE OF SEED COTTON

The module builder, which allows field storage of seed cotton prior to ginning, is revolutionizing the cotton industry by breaking the connection between harvesting and processing, allowing each operation to proceed at its own pace (Wilkes *et al.*, 1972; Wilkes and Sorenson, 1973; Roberts *et al.*, 1973; Curley *et al.*, 1973; Paxton and Roberts, 1973; Baskin, 1976a; Jones, 1976; Kepner and Curley, 1976; Eickhoff and Willcutt, 1978; Wilkes, 1978). Roberts *et al.* (1973), Paxton and Roberts (1973), Eickhoff and Willcutt (1978) and Wilkes (1978) showed that the germinability and free fatty acid content of high-quality cottonseed are not affected significantly during module storage of seed cotton as long as seed moisture remains below 12 percent. Low quality seed deteriorates regardless of moisture level. The moisture in such trash as leaves, soil and branches causes "hot spots", localized temperature rises in the module which transfer to the seed. Temperatures that exceed 50C during module storage indicate that seed is deteriorating and that it should be ginned immediately. Good management during harvesting and close monitoring of the conditions of the seed cotton during storage are necessary for module storage (see Chapter 32).

Cherry *et al.* (1979a) supported earlier studies showing that high temperature and moisture affected cottonseed quality during module storage. Under the right conditions, microorganisms such as *Aspergillus*, *Mucor* and *Alternaria* that exist in the microflora of cottonseeds may also affect their quality. Cottonseeds having greater than 12 percent moisture seemed to be most susceptible to changes in composition. The most notable changes were decreases in percentages of oil and free gossypol and increases in levels of free fatty acids. The addition of propionic acid to moist, module-stored seed at a rate of 4 lb/bale lessened these changes. Increases in protein may be a result of the proportional decrease in oil. The extractability of nonstorage protein was not significantly different among samples stored dry or moist, but these values were significantly lower than those of samples that were not stored or that were stored with propionic acid. Great variability was noted only in the extractability of storage proteins from cottonseed stored moist. Gel electrophoretic patterns showed no qualitative or quantitative differences in extracts of nonstorage and storage proteins from stored and un-stored cottonseeds; variations may be below levels detectable with techniques used in these studies.

### COTTONSEED MATURITY, CLOSED-BOLL HARVESTING, AND ARTIFICIAL DRYING OF COTTONSEEDS

Changes in the constituents of maturing cottonseeds and the factors that affect

the rate of their synthesis have been investigated for many years (Gallup, 1932; Grindley, 1950; El-Nockrashy *et al.*, 1976; Benedict *et al.*, 1976; Sood *et al.*, 1976; Elmore and Leffler, 1976; Leffler *et al.*, 1977; Kajimoto *et al.*, 1979; Cherry *et al.*, 1980). Protein, oil and gossypol are deposited continuously in the cottonseed through most of the period between flowering and opening of the bolls.

Benedict *et al.* (1976) used  $^{14}\text{C}$  isotope to follow the rate of incorporation of radioactively labeled photosynthate of leaves into various seed storage components. The amount of radioactive label incorporated into amino acids remained fairly constant throughout boll development, indicating that few changes were occurring in the rate of synthesis of different amino acids. Elmore and Leffler (1976) also noted no drastic shifts in the concentration of any amino acid during seed maturation. Benedict *et al.* (1976) noted no large shifts in  $^{14}\text{C}$  labeling of structural proteins to storage globulins, but Elmore and Leffler (1976) showed that aspartic acid was predominant early in seed development and was then replaced by arginine and glutamic acid, amino acids mainly present in storage proteins.

Leffler *et al.* (1977) showed that maturing cottonseed do respond to elevated nitrogen fertilization by synthesizing additional storage proteins (see Chapter 30). Such responses cause significant changes in the seeds' amino acid composition: lysine, threonine, glycine and alanine decreased, while arginine and glutamic acid increased (arginine and glutamic acid are mainly present in cottonseed storage globulins).

It was shown that the rate of oil synthesis did not increase dramatically until the seeds had matured 20 days after the flowering stage (Benedict *et al.*, 1976; Kajimoto *et al.*, 1979). The rate of oil synthesis peaked between 30 and 40 days and stopped by 45 days. The total amounts of cyclopropene and cyclopropane fatty acids in triglycerides were 38.0 and 15.9 percent of fatty acids, at 3 and 10 days, respectively, after flowering (Table 20) (Kajimoto *et al.*, 1979). These fatty acids decreased markedly from 10 to 65 days (when the seeds were considered mature). Linoleic acid increased rapidly during this same period. Linolenic acid, a highly unsaturated and oxidatively unstable fatty acid, decreased from 13.5 percent to non-detectable levels during this same time. The potential for causing the greatest reduction in cyclopropane and cyclopropene fatty acids and improving quantities of linoleic acid by maneuvering environmental conditions (and, in turn, manipulating favorable biochemical mechanisms into operation in the maturing cottonseed) is probably best during the time of maximum oil synthesis.

Harvesting unopened bolls and opening them by artificial drying methods were investigated by Jones *et al.* (1977). This approach to processing seed cotton: (1) reduced dust in the cotton fiber; (2) lessened the need for control of boll rot organisms; (3) shortened the growing season, offering the potential of multiple-crop production; (4) lessened harvested trash in the lint; and (5) introduced the possibility of utilizing never-dried fibers in the textile industry. This study showed that cotton could be harvested as much as 30 to 40 days before all bolls opened in

Table 20. Fatty acid composition (percentage) in oil of maturing cottonseed. (Summarized from Kajimoto *et al.*, 1979.)

Fatty acid	Days after flowering			
	3	10	30	65
Myristic (C14:0)	0.3	0.7	1.4	1.4
Palmitic (C16:0)	15.2	27.9	27.4	28.3
Palmitoleic (C16:1)	0.6	0.9	1.0	0.8
Stearic (C18:0)	1.4	1.0	2.1	1.7
Oleic (C18:1)	17.5	12.9	13.7	15.9
Linoleic (C18:2)	18.3	35.3	50.1	50.7
Linolenic (C18:3)	13.5	5.0	Trace	—
Cyclic octadecanoic Acid (CP18:0)	7.4	3.1	1.2	0.3
Cyclic octadecenoic Acid (CP18:1)	9.2	3.7	1.1	0.3
Cyclic nonadecanoic Acid (CP19:0)	3.6	2.0	0.6	0.2
Cyclic nonadecenoic Acid (CP19:1)	17.8	7.1	1.5	0.4

the field without significant reductions in fiber yield and percentage of seed germination.

Simmons *et al.* (1979) and Cherry *et al.* (1980) showed that cottonseeds from hand harvested closed bolls that were dried artificially by blowing low humidity, 40C-air over them had oil and protein of more uniform quality than field-opened bolls. Averaged values of experiments from two crop years showed that seeds of closed bolls were smaller than those of field-dried bolls, but they were comparable in oil and protein content and the overall quality of fatty and amino acids. Seeds from closed bolls contained less free fatty acids, unsaturated fatty acids and cycloprene fatty acids than field-dried seeds. The composition of seeds from closed bolls harvested more than 45 days after flowering was not affected by maturing level and drying methods as much as that of more immature seeds.

Other drying methods included in these studies were lyophilization, forced air at 80C and microwave heating (Cherry *et al.*, 1980). Optimum quality was obtained in seeds from bolls dried by forced air at 40C and by lyophilization. The composition of maturing cottonseeds was altered significantly by oven drying at 80C and by microwave heating. These methods caused a decrease in total and free gossypol and in the extractability of nonstorage and storage proteins at most stages of seed maturity (seeds matured beyond 45 days after flowering were not affected as much as more immature seeds). Gel electrophoresis showed that cottonseed proteins were greatly denatured by these drying methods. Oven-dried seeds had lower percentages of oleic acid in the oil compared to those dried at

40C, lyophilized or field dried. Little change was noted in the overall quality of amino acids in oven-dried and microwave-dried seeds.

**WILD *GOSSYPIUM* SPECIES**

The wild species of *Gossypium* are excellent sources of diverse germplasm coding for new compositional properties (in protein, oil, and so forth) that may expand the functional and nutritional properties of cottonseed products as food and feed ingredients (El-Nockrashy *et al.*, 1969; Cherry *et al.*, 1970, 1971, 1972, 1977; Cherry and Katterman, 1971; Johnson and Thein, 1970; Cherry, 1977, 1978). The genus *Gossypium* is comprised of about 34 diploid and 4 natural allotetraploid species (see Chapter 1). The diploid (2n) plants are divided into six groups or genomes labeled A to F. Tetraploid (4n) species, from which presently cultivated varieties have originated, are described as 2(AD)n since they are

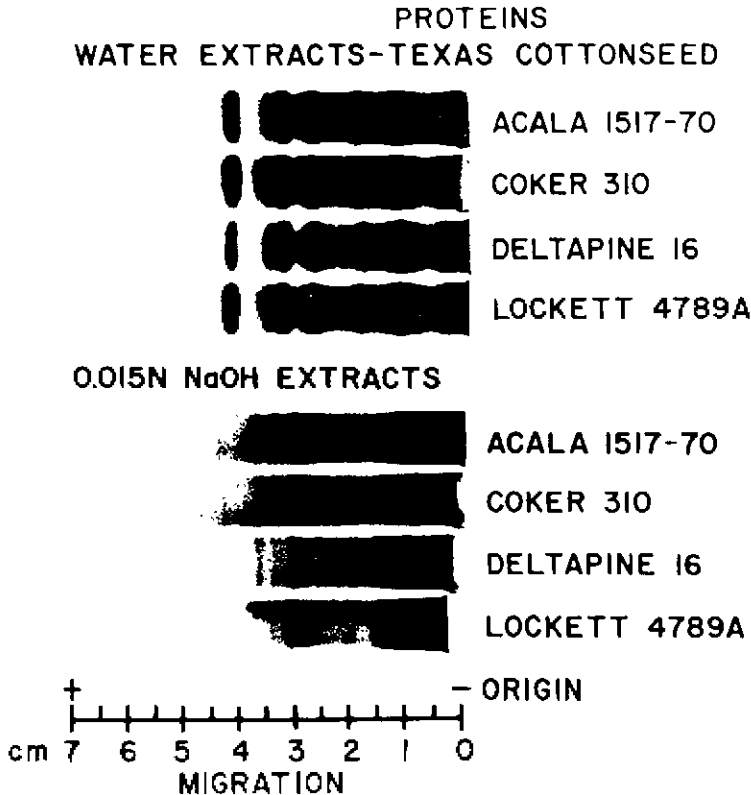

Figure 8. Typical polyacrylamide disc-gel electrophoretic patterns of proteins in cottonseed of Acala cultivars grown in Texas and California (from Cherry *et al.*, 1978c).

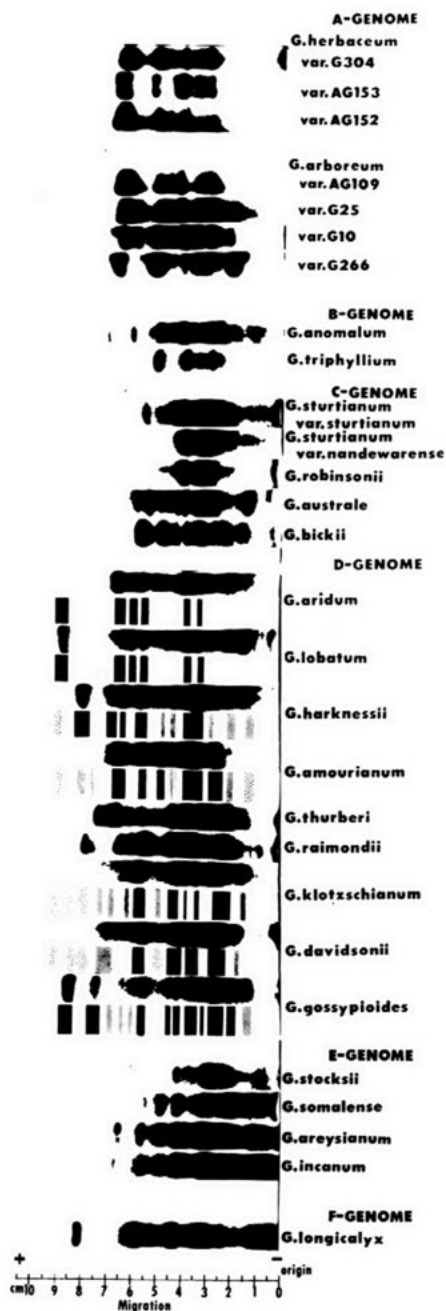

Figure 9. Gel electrophoretic patterns of proteins in cottonseed from select wild species in the genus *Gossypium* (from Cherry *et al.*, 1970).

hypothesized to have originated from a cross between plants from the A and D genome. Polyacrylamide gel electrophoretic studies show that much more variation (quantitative and qualitative) in banding patterns of proteins exist within the wild species of the A and D genomes than the cultivated varieties (Figures 8 and 9). Although the protein quality of cottonseed from different cultivars differs and can be influenced by genetic and agronomic practices, the gel electrophoretic data suggest that this variability is not reflected in the types of cottonseed protein. Thus, proteins that may be low in specific essential amino acids are unknowingly selected for in present-day breeding and agronomic programs to improve fiber quality, thereby perpetuating a nutritional imbalance in the cottonseed of new commercial cultivars.

The potential economic value of the wild relatives of *G. hirsutum* and *G. barbadense* is apparent not only because they offer important sources of diverse germplasm for improving agronomic characteristics but also as sources of protein material that offer the potential of expanding the functional and nutritional properties of cottonseed used in feed and food.

## IMPROVING COTTONSEED USE IN FEED AND FOOD

Increased use of other seeds (such as soybean, palm, sunflower, peanut) in the oil and feed industry, and the even greater prospect for use of cottonseed as a food, have increased the awareness of the importance of cottonseed to feed and food reserves of the world. To keep cottonseed commercially competitive in the world market as a source of oil, feed and food, researchers have to strive continually to produce cottonseed with high oil and protein content and low to zero gossypol levels. In the oil, cyclopropenoid fatty acids should be eliminated, the amount of unsaturated fatty acids (especially oleic and linoleic) needs to be increased, and the amount of saturated fats should be reduced. In the proteins, the essential amino acids (especially lysine, methionine and isoleucine) should be increased. This could be done by selectively increasing quantities of the water-soluble non-storage proteins, or by improving the levels of select polypeptides in the storage globulins that are rich in essential amino acids (Cherry *et al.*, 1978a; King and Leffler, 1979; Zarins and Cherry, 1981). Whichever approach is taken, the effort should maintain the separation of these two groups of proteins into noncompartmentalized and compartmentalized, water- and alkaline-pH-extractable components, respectively (for reasons of economy and for diversification of protein product uses).

Techniques of processing of cottonseed to oil and meal, and liquid cyclone (Gardner *et al.*, 1976; Cherry *et al.*, 1978b,c, 1979b) and air classification (Friedman *et al.*, 1979) methods to prepare low gossypol edible food ingredients would be more applicable or economically feasible than under present conditions, if the amount of linters, hulls and gossypol in cottonseed were lowered. Lowering or eliminating gossypol in the meal would allow more use of cottonseed products

in the nonruminant animal and poultry industries. Removing linters would allow development of the direct dehulling of cottonseed during oil mill processing and not only eliminate a costly step in processing but also greatly reduce the dust problem.

Geneticists, agronomists, chemists and processing engineers have laid the groundwork for developing answers to many of the needs confronting the cottonseed industry. Their studies show that seed storage constituents can be influenced by cultivar, growing location and insect damage. Careful selection of cultivars and growing locations should yield optimum quality cottonseed products that can continue to compete favorably in the world market, without affecting the fiber industry.

## DISCUSSIONS

### THE GENETICISTS' VIEWPOINT

Interest in improving cottonseed quality has been traced to the work of Williams (1906). Throughout the intervening years, numerous authors have reported similar interests and research (Hare, 1914; Rast, 1917; Sievers and Lowman, 1932; Hancock, 1942; Pope and Ware, 1945; and Harland, 1949). Nevertheless, there has been neither continuity of interest nor continuity in research programs. There is no evidence that cottonseed quality has had an impact on cotton variety improvement. But we have now entered into a new period of interest in cottonseed quality that has been heightened by the discovery of the glandless factors (McMichael, 1959).

The role of geneticists is to develop the materials or information that will enable others to genetically manipulate cottonseed quality characters. They may participate in the identification and selection of the seed quality characters, but their primary function is to determine whether or not they can be genetically manipulated and how. Their initial task is to identify genetic variability for the seed quality characters (the existence of genetic variability is prerequisite to any genetic manipulation). Although in practice geneticists would have to identify and take into consideration the environmental variability, in this part of the discussion it is assumed that they have adequate control and understanding of the environment. Thus, this discussion will concentrate on the genetic variability.

The sources of natural variability available to Upland cotton researchers are (1) current cultivars, (2) the Upland germplasm collection at Stoneville, Mississippi, (3) the *Gossypium hirsutum* race collection at College Station, Texas, and (4) the *Gossypium* species collection at College Station, Texas. These sources are listed in order of increasing genetic variability, increasing difficulty to obtain and decreasing agronomic potential.

The species are perennial wild plants that are photoperiodic or at least respond to some specific environmental stimulus that controls flowering. A reasonably optimistic time to expect the transference of a character from the species to a



cultivar would be about 15 years. The *G. hirsutum* races are predominantly photoperiodic, and accessions range from types with strong perennial growth habit to prolific types that flower in the first year of growth. They produce spinnable fibers on their seeds but are agronomically unimproved, compared to modern cultivars. Transference of a character from the races to a cultivar should require about 10 years. The upland collection at Stoneville, Mississippi, represents strains and obsolete cultivars that have limited agronomic improvement relative to current cultivars but are readily accessible for genetic manipulation. Transference of a character from this source to a cultivar should require approximately five years. Current cultivars represent the most accessible source of genetic materials, if they possess the necessary variability.

Although this discussion is on various seed quality characteristics, it would have to give priority in genetics or plant improvement research to oil, protein and gossypol. These characters are immediately relevant to current cottonseed utilization, and acceptable methods and means to measure them are available. Once geneticists develop an understanding of these genetics, they will be better equipped to investigate other seed quality characteristics.

There is no need to discuss seed gossypol at length because with the discovery of the glandless genes (McMichael, 1959), geneticists have obtained the ability to genetically control the presence or absence of gossypol in seeds. Simple genetic control of seed gossypol has not solved all the problems. But most of the many questions yet to be answered, before geneticists can effectively access the role of glandless cottonseed, are not related to the genetics of seed quality (Kohel, 1978a).

The upland and race germplasm collections were screened for seed oil percentage (Kohel, 1978b) and seed protein percentage. These screenings revealed, as predicted, that greater variability existed in the race collection than in the upland collection. These studies included seed physical properties and stressed the importance of monitoring these properties. Differences in composition percentages can be due to changes in seed or seed coat size. These changes may be most important when transferring characters from diverse germplasm sources where geneticists observe the greatest range in seed physical properties (Kohel, 1978b).

The geneticists have concentrated on the transference of seed oil percentage from the germplasm collections because they have instrumentation that nondestructively measures seed oil. They are exploiting the variability of the germplasm collections because it is an activity that is well suited to pursue, and it is not easily undertaken by individual plant breeding programs. The goal of geneticists is to provide a range and combination of seed quality characters for use in plant breeding programs, characters not available in cultivars of acceptable agronomic background.

Seed oil percentages from the upland germplasm collection are quantitatively inherited and to a large extent controlled by additive gene action (Kohel, 1980).

At this point, the large environmental variance must be considered. In the segregating material studied, about two-thirds of the variability in seed oil percentage was due to the environment. However, as the range of seed oil percentage types was transferred into improved agronomic backgrounds, it reduced the range of seed oil percentage. The upland germplasm collection had a wider range of seed oil and physical properties than the cultivars.

### INDUSTRY'S VIEWPOINT

Work by Cherry *et al.* (1978b), and presented in this text, has helped summarize the recent information on cottonseed quality. The distressing observation that there has been little if any change in oil, protein and gossypol levels in cottonseed in this century must be taken in context.

Cottonseed value has often been improperly assessed by the cotton industry. Cotton producers have concentrated their production and harvesting practices in order to maximize returns on lint per acre. For many years cottonseed was actually considered only a byproduct of little value to the grower. But several factors have combined to emphasize the value of cottonseed to the cotton producer, economic factors as well as educational efforts by the crushing industry. The fuzzy seed is, of course, the raw material of the cottonseed oil mill and its value reflects the values of the products that can be made from it.

The National Cottonseed Products Association, through its Research and Education Committee, has established the following goals for improving seed quality: (1) to increase seed yield per acre; (2) to increase the oil percentage; (3) to eliminate cyclopropenoid fatty acids in seed; (4) to eliminate or reduce seed gossypol; (5) to increase seed protein percentage; (6) to increase lysine content of meal; (7) to improve the level of mycotoxin resistance in seed; and (8) to insure that new cultivars have hulls that will maintain their integrity prior to the actual hulling operation (commonly called non-shattering). Another goal, (9) to reduce cottonseed linters percentage, is also included on this list, but we will not discuss it at this time.

**Seed Yield**—The oilseed crushing industry has always been concerned about the availability of cottonseed for crushing. Three possible avenues for improvement are theoretically available: (1) to increase the seed percentage in seed cotton, (2) to increase cotton acreages, and (3) to increase the total yield of seed cotton per acre. Increasing seed percentage of seed cotton would likely reduce lint yields, which is unacceptable. Increasing acreage as well as total seed cotton yield are the only two approaches to this problem. The cottonseed processing industry is cooperating with federal and state research workers in the development of superior cultivars and improved cultural practices and handling methods. Public and private breeding programs are providing germplasm that is superior in lint and seed quality and quantity, and also possesses resistance to disease and pests.

**Oil**—Modern cotton breeding programs include consideration of both oil and protein percentages. Breeders are reporting genetic variations within their breeding stocks for both of these characteristics. Variations between commercial cultivars produced during 1979 in California are shown in Table 21. The oilseed crushing industry encourages cotton breeders to increase both recoverable oil and seed protein levels in their new cotton lines.

TABLE 21. 1979 California cottonseed variety test means from four locations each at the San Joaquin and Imperial Valleys.

Analysis (percentage) <sup>1</sup>	San Joaquin Valley <sup>2</sup>		Imperial Valley
	'Acala SJ-2'	'Acala SJ-5'	'Deltapine 16' <sup>3</sup>
Protein	21.2	22.8	20.6
Oil	17.7	20.2	17.3
Total gossypol	1.28	.95	1.12

<sup>1</sup>"As is" moisture, fuzed seed basis.

<sup>2</sup>Planting seed sold, 1980: 81% 'SJ-2,' 19% 'SJ-5.'

Planting seed sold, 1978-1979: 70-75% 'SJ-2,' 25-30% 'SJ-5.'

<sup>3</sup>90% of cotton acreage in Imperial County, Calif., in 1980 was 'Deltapine 16'.

The county produces about 7-10% of the Calif. cotton crop.

**Cyclopropenoid Fatty Acids**—The cyclopropenoid fatty acids are unique, biologically active fatty acids that are present in minute quantities in cottonseed oil. Cyclopropenoid fatty acid levels are an important consideration in meal as well as oil. Lack of a satisfactory analytical method has limited research in this area. Obviously, cottonseed processors would encourage any program that attempts to eventually identify low cyclopropenoid fatty acid strains of cotton and incorporate them into commercial lines.

**Gossypol**—Elimination of seed gossypol is one of the most important goals of the cottonseed products industry as well as other segments of the cotton industry. The first glandless cotton was reported by McMichael (1959). Glandless cultivars of cotton are now available with lint and seed production that is essentially equal to glanded types in lint yield and other characters. Low-gossypol meal has resulted in excellent performance in poultry, swine and pet rations. Potential food uses include protein supplementation as flour in baked goods, confectionery products and extenders in dairy and meat products. Food-grade glandless cottonseed products must meet Food and Drug Administration regulations.

The National Cottonseed Products Association is presently working with cotton breeders from the federal government, state universities and industry to promote the production of glandless cotton. Several glandless cultivars are now available for commercial production in West Texas. Breeders in California and the Southeastern United States are presently developing cultivars that provide excellent seed and lint yields.

**Protein**—Seed protein content is like oil content; increased levels of each are desirable.

**Lysine**—Levels in cottonseed meal have long been of concern to nutritionists. It is believed that it is possible for plant breeders to select lines capable of providing higher levels of this essential amino acid (as was accomplished in corn). Thus, *cotton research workers are encouraged to include improvement of lysine levels in their breeding programs.*

**Hull Integrity**—The ability of the seed coat to resist shattering is a problem most obvious in the milling process. Cotton breeders have identified plant selections with wide variations in seed coat strength and thickness. Crushing mills are concerned that new cultivars retain their integrity because reduced seed coat thickness and strength can lessen the recovery of oil from meats and meal. **Breeders should avoid reducing seed coat thickness and strength.**

Communicating these goals to plant breeders has always been considered a weak point in the cottonseed industry. An example is a rise in gossypol levels seen in the California Acala varieties. During the early 1970's, California changed Acala cotton lines. The line introduced at that time had higher total gossypol levels than the line that preceded it. Before the change, California oil mills had established a low-gossypol cottonseed meal market in poultry feeds. The high-gossypol cultivar increased meal gossypol levels and had a significant impact on the maximum level of the cottonseed meal that could be used in poultry feeds in that market. Lack of communication between cotton breeders and the oil mill industry regarding gossypol levels resulted in major market problems.

The oilseed crushing industry tries to work closely with plant breeders and other researchers to provide information to meet the needs of the industry and the consumers of their products. The same researchers can provide the National Cottonseed Products Association with information regarding new cultivars, cultural methods and pest control programs beneficial to the industry.

With the most significant cottonseed quality improvement, glandless cotton, implementation is probably what needs to be emphasized at this time rather than research. Our industry looks at glandless cotton with great expectations, in hopes that it will eventually provide quality protein for the food and non-ruminant animal markets. Of course, the National Cottonseed Products Association is primarily interested in glandless protein, but it must appreciate the necessity for high quality and quantity in lint yields. The industry is optimistic about the lint quality and yield, pest resistance and seed quality characteristics that cotton breeders are incorporating into their glandless materials.

In conclusion, the cottonseed products industry has its list of desires and hopes for seed quality and welcomes any forum to discuss these items with others who also expect so much from this versatile, renewable resource, the cotton plant.

Hopefully, we won't have another 60 to 80 years go by without some of the improvement in the qualities of the seed of this plant.

## SUMMARY

Past and present studies show that cultivar, growing location, crop year and/or their interaction terms—cultivar x location, cultivar x crop year, location x crop year, and cultivar x location x crop year—are highly significant sources of variation associated with quality of cottonseed grown in the United States Cotton Belt. Breeding, agronomic and handling practices can be used to favorably alter the physical and chemical properties of cottonseeds to improve their processability into oil, feed and food products without affecting optimum fiber quality. Yet despite many years of published expressions of interest in improvement of cottonseed quality, there has not been a continuity of interest or research programs; there is little evidence that cottonseed quality has had an impact on improving cotton cultivars. And, we have now entered a new period of interest in cottonseed quality research, interest that has been heightened by the discovery of glandless cotton.

## Chapter 38

# PHYSIOLOGY OF SECONDARY PRODUCTS

Alois A. Bell  
USDA-ARS  
College Station, Texas

## INTRODUCTION

Cotton produces a large number of secondary products that often occur in specialized cells or tissues and serve diverse biological functions. The concentrations of these compounds may vary from a few ppb for some volatile terpenoids to more than 20 percent of the dry weight for condensed tannins and lignins. Some secondary products are undesirable because they present toxic hazards during fiber processing and seed utilization. Their synthesis also diverts photosynthate from the desired products. However, many secondary products have important desirable roles in resistance to pests and to environmental stress, and some also may be useful as pharmaceuticals. Thus, a thorough knowledge of secondary products chemistry and biology is needed to manipulate and use these compounds for optimal cotton production and utilization.

In this review the structure, biological activity, localization, genetic control, and interaction with environment will be discussed for different secondary products. The compounds and their derivatives are divided into the broad categories: phenolic acids, flavonoids, terpenoids and unique fatty acids.

## PHENOLIC ACIDS

The cotton plant (*Gossypium* spp.), like most other plants, produces a number of derivatives of benzoic and cinnamic acids. Both groups of acids are probably derived from shikimate metabolism, although this has not been confirmed in cotton. Maga and Lorenz (1974) identified the most prominent phenolic acids in defatted cottonseed flour. The major benzoic acid derivatives, 3-methoxy-4-hydroxybenzoic (vanillic) and 3,5-dimethoxy-4-hydroxybenzoic (sinapic) acid, each occurred at 30 ppm. The major cinnamic acid derivatives, 4-hydroxycinnamic (*p*-coumaric), 3-methoxy-4-hydroxycinnamic (ferulic) and 3,5-dimethoxy-4-hydroxycinnamic (syringic) acid, occurred at 41, 45 and 21 ppm, respectively. Other phenolic acids, found at 4-11 ppm, included *p*-hydroxybenzoic, 2-hydroxybenzoic (salicylic), 2-hydroxycinnamic (*o*-coumaric), 2,5-dihydroxybenzoic (gentisic), 3,4-dihydroxycinnamic (caffeic), 3,4-dihydroxybenzoic (protocate-

chic) and chlorogenic acid. The concentrations of total phenolic acids and of vanillic acid alone were at or slightly above the taste threshold. Thus, they may contribute slight astringency or bitter taste to cottonseed products.

Benzoic acid has not been reported to occur in cotton. However, benzaldehyde and benzyl alcohol make up 0.2-1.0 percent of the volatile products collected by steam distillation of various cotton tissues, gin trash and mill dust (Hedin *et al.*, 1975a,b,c, 1976). These compounds occur in subfractions with potential byssinotic activity but have not been tested directly against animal cells.

The hydroxylated cinnamic acids appear to function largely as intermediates in the synthesis of coumarins, lignins and flavonoids. Scopoletin, a coumarin derivative of ferulic acid, occurs in trace amounts along with its glucoside scopolin in living tissues of the cotton plant (Hanny, 1980). Concentrations of scopoletin generally increase markedly during senescence or following infection and stress (Caldwell *et al.*, 1966; Wakelyn *et al.*, 1974). The compound persists in dead tissues and may be found in mill dust from bales stored for several years. Field dried bracts contained 5 ppm of scopoletin (Wakelyn *et al.*, 1974), and frost-killed bracts and leaves contained 22.6 and 21.6 ppm, respectively (Doolan *et al.*, 1982).

Wiese and DeVay (1970) found that caffeic acid, like scopoletin, increased in *Verticillium*-infected cotton. Caffeic acid at  $10^{-4}$ M decreased IAA degradation by 30 percent in healthy cotton tissue, and scopoletin was mildly inhibitory. They concluded that these compounds might contribute to the increase of IAA and decrease of IAA decarboxylation that commonly occurs in diseased tissues. Terpenoid aldehydes and catechins, however, are probably more important because they accumulate to much greater concentrations than phenolic acids and coumarins (Bell and Stipanovic, 1978) and similarly affect IAA decarboxylation.

Lignin may constitute over 40 percent of the dry weight of mature cotton stems (Veksler *et al.*, 1978). *p*-Coumaryl aldehyde, coniferyl aldehyde (3-methoxy-4-hydroxycinnamic aldehyde) and syringyl aldehyde have been isolated from dried cotton stalks (Brauns and Brauns, 1960), and the corresponding *p*-coumaric, guaiacilic and syringic structural units have been shown in cotton dioxane lignins (Veksler *et al.*, 1977). Presumably most of the aldehydes are reduced to corresponding alcohols before incorporation into the lignin polymer. El-Hinnawy *et al.* (1980) concluded that cinnamyl units in lignin are linked mostly through *p*-aryl type linkages.

Lignin structure in cotton varies with plant age (El-Hinnawy *et al.*, 1980; Veksler *et al.*, 1977, 1978). In young plants lignin contains almost exclusively guaiacilic residues, indicating that it is synthesized from coniferyl alcohol. With age the degree of methylation of lignin first increases to a peak and then after several months may decrease slightly; corresponding changes occur in the percentage of syringyl units in the polymer. *p*-Coumaryl units never occur in more than minor amounts. C3 side chain substitution and condensation of aromatic nuclei in lignin are greatest in young vegetative plants and least in mature stems,

presumably due to the changes in methylation. Lignins extracted with dioxane contain some condensed proanthocyanidins (see section on flavanols) which decrease in percentage as the plant ages.

The percentage of syringyl units in cotton lignin varies considerably for different preparations, even from the same cultivar. This might be due to the influence of environment or pests on lignin composition. Recent studies have shown that rapid lignin synthesis in response to pests is an important mechanism of both cultivar and induced resistance to diseases and insects in various plants (Bell, 1981; Kuc, 1981). Infection-induced lignin, compared to that in healthy plants, often has more syringyl residues and little or no aldehyde content (indicated by negative reactions with acidic phloroglucinol). Numerous reports of increased yellow fluorescence in diseased tissues of cotton (Bell, 1973) may be due to induced lignin synthesis, because syringyl derivatives fluoresce yellow or yellow-green (Bell, 1981). Studies of the possible importance of lignins in the resistance of cotton to pests and stress are needed.

## FLAVONOIDS

The flavonoids of cotton have the basic structure shown in Figure 1. Additional hydroxyl substitutions can occur at the 3, 8 or 3' carbons, and carbonyl oxygen can occur at the 4 carbon depending on the specific compound. Hydroxy groups can react further to form methyl ethers or glycosides at various positions. Variations also occur in the oxidative state of the heterocyclic ring, and these distinguish groups of compounds known as flavonols, flavones, anthocyanins and flavanols.

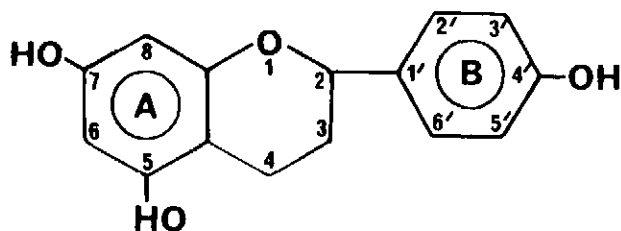

Figure 1. Ring structure of flavonoids, showing numbering of carbons and ring identification.

## FLAVONOLS

Flavonols may make up 2-4 percent of the dry weight of flowers and 1 percent of leaves. The localization of these compounds among cells or tissues is uncertain, although it has been suggested that they occur in the epidermis of embryos in seed (see references in Pratt and Wender, 1959). I have also found the flavonol isoquercitrin in the capitate hairs of the epidermis of stems and leaves.



The most abundant flavonols occur as glycosides of one of the four aglycones shown in Figure 2. The 4'-methyl ethers of quercetin and kaempferol are the only other known aglycones (Struck and Kirk, 1970). The sugar composition and

## FLAVONOLS

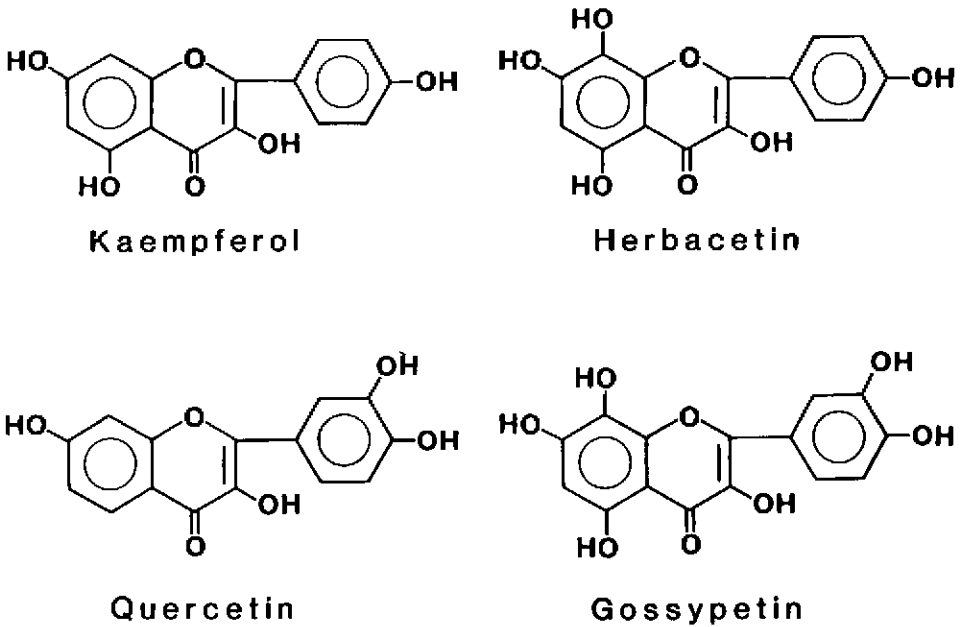

Figure 2. Structures of major flavonol aglycones from *Gossypium*.

occurrence of cotton flavonols in different tissues is given in Table 1. The absolute structures of the sugars is only partially known. Two different rhamnoglucosides of quercetin have been identified from seed. In the first, rutin, the sugar moiety is rutinose (6-O- $\alpha$ -L-rhamnosyl-D-glucose), whereas in the second the sugar is neohesperidose (2-O- $\alpha$ -L-rhamnosyl-D-glucose). Blouin *et al.* (1981a,b) concluded that the main rhamnoglucoside of kaempferol in seed was a neohesperidoside. The linkage between rhamnose and galactose in the rhamnogalactosides is apparently the same as in rutin. The 3-glucoside of quercetin usually has been identified as isoquercitrin, which contains glucose in the  $\beta$ -D-pyranose form. However, Sadykov (1972) reported that the 3-monoglucosides of kaempferol and quercetin from the cultivar '108 F' (*G. hirsutum*) had properties different than expected for the  $\beta$ -D-glucopyranosides and suggested that kaempferol-3- $\alpha$ -D-glucofuranoside was the correct structure for the kaempferol glucoside. The

Table 1. Flavonols reported to occur in various tissues of *Gossypium*.

Flavonol	Tissue			
	Petals	Anthers	Leaves	Seed
Kaempferol glycosides				
3-glucoside (astragalin)	+(O-H) <sup>2</sup>		+(H)	
3-glucoglucoside				+(H)
3-rhamnoglucoside	+(O-H)		+(H)	+(H)
Quercetin glycosides:				
3-glucoside (isoquercitrin)	+(H)	+(H)	+(H)	+(H)
3-glucoglucoside		+(L)		+(H)
3-rhamnoglucoside	+(O-II)	+(L)	+(H)	+(H)
3-rhamnogalactoside				+(H)
3-xyloglucogalactoside			+(O-H)	
3'-glucoside	+(O-H)	+(L)		
4'-glucoside	+(O-H)			
7-glucoside (quercimetrin)	+(O-H)	+(L)		
7-glucoglucoside		+(L)		
7-rhamnoglucoside		+(L)		
3,7-diglucoside		+(L)		
4'-methyl-7-glucoside	+(O-H)			
Herbacetin glycoside:				
7-glucoside (herbacitrin)	+(O-H)			
Gossypetin glycosides:				
3-glucoside (gossytrin)	+(O-H)	+(H)		
7-glucoside (gossypitrin)	+(O-H)	+(L)		
8-glucoside (gossypin)	+(O-H)	+(VL)		
3 (or 7)-glucoglucoside		+(H)		

<sup>1</sup>Data are adapted from published reports: petals (Hanny *et al.*, 1978; Hedin *et al.*, 1968; Parks *et al.*, 1972; Parks *et al.*, 1975; Sadykov, 1972); anthers (Hanny, 1980); leaves (Hanny *et al.*, 1978; Howell *et al.*, 1976; Parks *et al.*, 1972; Sadykov, 1972); seeds (Blouin *et al.*, 1981a,b; Pratt and Wender, 1959, 1961).

<sup>2</sup>Relative concentrations in parentheses: H=high, M=medium, L=low, VL=very low, O=none detected.

flavonol identified as trifolin by Parks *et al.* (1965a,b, 1972, 1975) most likely is the kaempferol-3-glucoside, australin. Trifolin is kaempferol-3-galactoside, whereas the glycoside from cotton contains glucose (Parks *et al.*, 1965a,b; Blouin, 1981a,b). Different conclusions have been reached about the location of glucose substitutions on the  $\beta$  ring of *Gossypium* flavonols. Hanny (1980), Hedin *et al.* (1968) and Sadykov (1972) reported only the 3'-glucoside of quercetin, whereas Park *et al.* (1975) reported only the 4'-glucoside in various *Gossypium* species.

Sadykov (1972) concluded that the sugar in quercetin-3-glucogluco-*sido* from *G. barbadense* flower petals apparently was sophorose (2- $\beta$ -D-glucosido-D-glucose); this sugar has not been identified in other studies. More detailed studies are needed to ascertain the structures of the sugar moieties in the *Gossypium* flavonols.

Flavonols appear to be important because they influence insect behavior. Low concentrations may act as feeding stimulants, whereas higher concentrations often inhibit larval growth and especially pupation. Guerra and Shaver (1969) found that ethanolic solutions (5 mg/ml) of isoquercitrin and rutin, when applied to surfaces of leaf disks, stimulated feeding by larvae of tobacco budworm (*Heliothis virescens*) and cotton bollworm (*Heliothis zea*). The pupal weight and percentage of larvae pupating in these insects also increased slightly when concentrations of .05 to .10 percent of these compounds were added to artificial diets; 0.025 percent of these flavonols caused similar stimulation of the pink bollworm, *Pectinophora gossypiella* (Lukefahr and Martin, 1966; Shaver and Lukefahr, 1969). Aqueous solutions of 0.1 percent quercetin, quercetin-7-glucoside and quercetin-3'-glucoside applied to filter paper wrapped over water-agar plugs moderately stimulated feeding attempts by boll weevil (Hedin *et al.*, 1968). In contrast, kaempferol, quercetin-3-glucoside and cyanidin-3-glucoside had no effect or slightly inhibited boll weevil feeding. Thus, some specificity in stimulation may reside with different flavonol structures.

Rutin and isoquercitrin at concentrations above 0.2 percent inhibit larval growth and especially pupation in cotton bollworm, tobacco budworm, and pink bollworm (Chan *et al.*, 1978; Elliger *et al.*, 1980; Guerro and Shaver, 1969; Lukefahr and Martin, 1966; Shaver and Lukefahr, 1969). Concentrations of 0.05 to 0.1 percent of rutin added to 0.1 percent gossypol greatly increased toxicity to bollworms, indicating a synergistic interaction between flavonoids and terpenoids in natural resistance to insects (Lukefahr and Martin, 1966).

The toxicity of flavonols depends both on their specific structure and the insect species. Flavonols containing the 3',4'-*ortho*-dihydroxy structure are more toxic than those having only a 4'-hydroxyl group (Chan *et al.*, 1978; Elliger *et al.*, 1980). Addition of sugar moieties generally decreases toxicity; quercetin is more toxic than isoquercitrin, which is more toxic than rutin (Lukefahr and Martin, 1966; Shaver and Lukefahr, 1969). With most flavonols, the pink bollworm is more sensitive and the cotton bollworm less sensitive than the tobacco budworm. Of the numerous flavonols known in cotton only kaempferol, quercetin, isoquercitrin and rutin have been included in comparative tests. Appreciable concentrations of free kaempferol and quercetin have not been found in cotton tissue; instead these occur mostly as glucosides. There is a critical need for more toxicity data on most of the major glycosides that occur in cotton before a strategy concerning their genetic or cultural manipulation for insect control can be developed.

The flavonols also may be important for their adverse effects. Blouin *et al.*

(1981a,b) conclusively showed that the undesirable yellow color of baked products prepared with cottonseed flour is due to flavonols and can be duplicated by adding rutin to baked products. Several studies have implicated flavonols and their oxidation products (polyphenols) in byssinosis. Kilburn *et al.* (1973, 1974) showed that quercetin, its oxidation products and polyphenols extracted from cotton trash recruited polymorphonuclear leucocytes on airways when inhaled by hamsters. Polyphenols also cause aggregation of human red blood cells, and rutin at 0.018 to 0.100 percent stimulates 12 to 46 percent release of histamine from platelets of pig blood (Ainsworth *et al.*, 1979b). The composition of the polyphenol preparation in these studies is unclear, but most likely included oxidized derivatives of flavanols and lignins, as well as flavonols. Because of the potent activity of rutin at concentrations found in the cotton plant, other major flavonol glucosides known in cotton should be investigated for possible involvement in byssinosis.

Flavonol composition may vary among tissues (Table 1), cultivars, species, and environments. Herbacetin and gossypetin glycosides and 3', 4'- and 7-glycosides of all aglucones have been reported only from anthers and petals of flowers; only 3-glycosides of quercetin and kaempferol are known in leaves and seed. High concentrations of herbacetin and gossypetin are closely associated with yellow flower color. These aglucones are abundant in yellow-flowered cultivars of *G. hirsutum*, but are missing from white-flowered cultivars. Likewise, they occur only among yellow-flowered species of the wild American diploid cottons. Distinct differences appear to occur in flavonols of *G. hirsutum* and *G. barbadense*. Quercetin-7-glycosides and kaempferol-3-glucoside are more abundant in *G. barbadense* than in *G. hirsutum*, whereas the rhamnoglucosides occur abundantly in *G. hirsutum* but only in trace quantities in *G. barbadense*. Other differences among species have been reviewed by Parks *et al.* (1975).

Parks *et al.* (1972) examined the effects of different growing environments across the U.S. Cotton Belt and of different nutritional levels, temperatures and photoperiods in controlled environments on flavonol contents of tissue. The flavonol content of petals was quite constant, regardless of environment. In contrast, flavonol composition of leaves varied markedly depending on age of tissue as well as environment. Howell *et al.* (1976) and Sadykov (1972) also observed that flavonol concentrations increase gradually in leaves with ageing, usually concurrently with decreases in flavanols (catechins and condensed tannins) that are synthesized earlier in leaf development. The greatest concentrations of flavanols occurred in the youngest unfolded leaves next to the terminal, whereas the greatest content of the flavonol, isoquercitrin, was in the third leaf back of the terminal.

Howell *et al.* (1976) also studied the relative ability of leaves of different ages to synthesize flavanols and flavonols in response to infection by *Verticillium* wilt. The ability of leaves to synthesize flavanols in response to infection quickly decreased with age, being negligible in leaves 5 and 6 back from the terminal. In contrast, induced flavonol synthesis was greatest in the 4th leaf, and 3- to 6-fold

increases in flavonol concentrations occurred in the 5th and 6th leaves, which were the oldest leaves studied. These studies indicate that the flow of flavonoid biosynthesis in leaves is largely to flavanols in young tissues but to flavonols in older tissue. It has not been determined whether the flavanols are directly converted to flavonols.

## FLAVONES AND ANTHOCYANINS

Flavone and anthocyanidin aglucones normally occur bound in glycosides. The only clearly identified flavone and anthocyanidin aglucones in cotton are apigenin and cyanidin, respectively (Figure 3). Apigenin occurs in high concentrations as the 7-rutinoside in flowers of the wild Australian species, *G. australe*, *G. robin-*

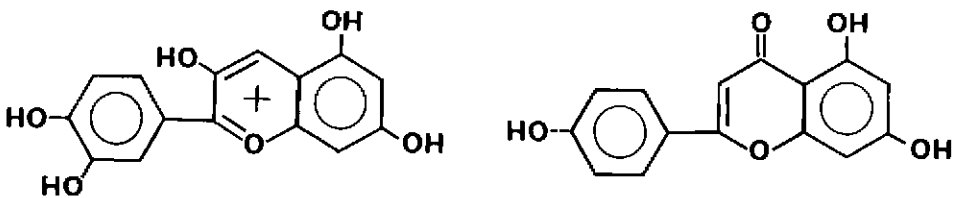

Figure 3. Structures of flavone and anthocyanidin aglucones from *Gossypium*.

*sonii* and *G. sturtianum*, but has not been found in other *Gossypium* species (Parks *et al.*, 1975). Eight other compounds with flavone characteristics have been found in the Australian species but have not been identified. Cyanidin-3-glucoside (chrysanthemine) is the major anthocyanin in flower buds, petals and leaves (Hedin *et al.*, 1967; Sadykov, 1972). Cyanidin-3-xyloglucoside (Sadykov, 1972) and an unidentified anthocyanin of *G. sturtianum* (Chan and Waiss, 1981) also have been reported to occur in flowers. Chrysanthemine is concentrated in the epithelial cells that make up the envelope of pigment glands in green tissues (Chan and Waiss, 1981). A second anthocyanidin associated with pigment glands in *G. hirsutum* may be pelargonidin (Hedin *et al.*, 1981). Delphinidin is obtained by acid hydrolysis of cotton condensed proanthocyanidins, but it has not been found as a glycoside.

Chan and Waiss (1981) obtained 4.5 mg of pure chrysanthemine from 135 mg of isolated pigment glands of 'Waukena White' (*G. barbadense*), and estimated that 10.4 percent and 9.4 percent of the dry weight of pigment glands from *G. arboreum* var. *sanguineum* and *G. barbadense*, respectively, were anthocyanin. However, some oil contents of the glands were lost during freeze drying, and further oil was undoubtedly lost during flotation of glands on methylene chloride. Thus, the estimates might be high for intact glands in the plant. Anthocyanins in glands apparently occur only in the epithelial cells surrounding the lysigenous cavity which contains terpenoids dissolved in oils. Sadykov (1972) reported anthocyanin contents of 2.1 and 5.5 percent in flower petals of two cultivars of *G.*

*hirsutum*. This anthocyanin apparently occurs mostly in vacuoles of parenchymous cells.

Hedin *et al.* (1982) recently reported that the growth of tobacco budworms on leaf terminals and flower petals of cotton was negatively correlated with chrysanthemins contents, as well as gossypol contents, indicating that this anthocyanin may have a role in resistance to insects. Anthocyanin both in pigment glands and in parenchyma cells of petals appeared to be effective. In feeding tests, cyanidin, delphinidin and chrysanthemins showed toxicity to budworms that was similar to that of flavonols, gossypol and tannin.

Various pesticides, temperature extremes and drought stress may cause reddening of cotton leaves and stems. Parrott and Lane (1980) showed that such reddening caused by the insecticide methomyl was correlated with increases in anthocyanin contents. The effects of other stresses on anthocyanins have not been determined.

## FLAVANOLS

The flavanols of cotton have the structures shown in Figure 4. The monomeric flavanols are characterized by a reduced heterocyclic ring that gives them much greater water solubility than corresponding flavones or flavonols. They do not occur as glycosides but are polymerized via 3C-8C linkages to form flavanol polymers called condensed proanthocyanidins (or condensed tannins). The condensed tannins can be hydrolyzed by dilute HCl in butanol to yield cyanidin and delphinidin from catechin and gallocatechin moieties, respectively, in the polymer. This reaction is frequently used for quantitative estimates of 'tannins' in cotton, but it only detects the flavanol polymer. Once oxidation of the heterocyclic ring and *ortho*-dihydroxy groups occurs, such as during seed ripening or death in diseased tissues, a nonhydrolyzable dark brown water-insoluble pigment (melanin) is formed.

Estimates of flavanol concentrations in tissues have varied considerably and have been presented in a variety of units. For purposes of uniformity, I have

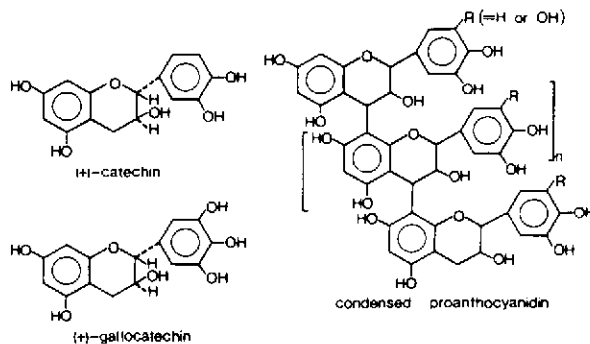

Figure 4. Structures of flavanols from *Gossypium*.

recalculated some data into percent dry weight, assuming that leaves and stems have dry weights of 10 and 20 percent, respectively, and that  $E_{1\text{cm}}^{1\%} = 270$  for products of butanol-HCl hydrolysis of condensed tannin as suggested by Lane and Schuster (1981).

The variable results from different studies of flavanol concentrations probably are due largely to the different methods and different standards used. The best estimates of catechin and gallic catechin probably result from initial separation by thin-layer chromatography on silica gel followed by reaction with 2,4-dimethoxybenzaldehyde to estimate quantities (Howell *et al.*, 1976). Ethyl ether:formic acid (95:5) is an excellent developing solvent, and (+)-catechin should be used as a standard.

Condensed tannins are best extracted with 70 percent acetone: 30 percent water from finely ground (100-200 mesh) dry tissues (Lane and Schuster, 1981). They can best be estimated in extracts or fresh leaf disks by hydrolysis in butanol:conc. HCl (95:5) at 98C for 2 hours, followed by reading absorbance at 550 nm. Purified condensed tannin prepared by the methods of Chan *et al.* (1977) can be used as the standard. Different standards may be needed for different cultivars, because E for condensed gallic catechin is about twice as great as E for condensed catechin, and considerable variation in catechin:gallic catechin ratios may occur in tannins from different cottons. Ratios of 1:4, 1:1, 2:1 and 4:1 have been reported for condensed tannin of Texas 1055 and free catechins of Seabrook Sea Island 12B2, Acala 4-42 and Stardel, respectively (Bell and Stipanovic, 1978; Howell *et al.*, 1976; Lane and Schuster, 1981). Obviously, the same standard could not be used for accurate measurements of condensed tannins in both Texas 1055 and Stardel. Likewise, tannic acid should not be used as a standard because it has quite different chemical properties than the flavanol tannins of cotton.

Flavanol concentrations vary considerably among various tissues and with age. The seed embryo contains only traces of flavanols in the palisade parenchyma, whereas high concentrations occur in the pigment layers of the seed coat (Holloin, 1982). Sadykov (1972) reported that seed hulls contained 12 percent catechin and related compounds just prior to ripening, but following ripening contained only 7 percent. Presumably the balance was oxidized into the brown pigments of the seed coat during ripening.

Following seed germination flavanol synthesis in the root begins within 1-2 days and appears first in the root cap and endodermis (Mace and Howell, 1974). Next, flavanols appear in the hypodermis and finally in parenchyma cells scattered throughout the root bark. Only a few scattered paravascular, pith and xylem ray cells form flavanols in healthy stele.

In young hypocotyls and stems, flavanols initially are synthesized in the epidermis and endodermis. Concentrations are low in new tissues but increase progressively over several weeks. Hunter (1974, 1978) found that flavanol concentrations increased linearly from 0.5-0.8 percent in 6-day-old hypocotyls to 1.1-2.3 percent in 12- to 14-day-old hypocotyls. These differences apparently account for the

marked increase of resistance to seedling diseases that occurs during this period of growth. Flavanol concentrations continue to increase with age in both root and stem bark (Bell and Stipanovic, 1978) until stationary levels of about 7-8 percent are reached (Sadykov, 1972).

In leaves, the lowest concentrations of flavanols occur in the cotyledonary and first true leaves. Concentrations increase progressively with each leaf formed until about the tenth leaf. Subsequent leaves have about the same amount as the tenth leaf, except considerable variation occurs among different leaves (Lane and Schuster, 1981). Finally, late in the growing season concentrations in leaves again decline (Sadykov, 1972).

Any given leaf has the highest flavanol concentration when first unfolded and only partially expanded. Concentrations in the leaf then decline progressively with age (Bell and Stipanovic, 1978; Lane and Schuster, 1981). Chan *et al.* (1978) and Hedin *et al.* (1981) reported flavanol levels of 22-50 percent in the shoot terminals (mostly leaf buds) of a few cultivars, but Hanny *et al.* (1978) found concentrations of only 7.5-24.3 percent in terminals in a survey of 39 cotton strains. Unfolding and young, expanding leaves are reported to contain 3-44 percent flavanol tannins with concentrations of 3-8 percent being most common (Chan *et al.*, 1978; Guinn, 1982; Hedin, 1981; Hanny *et al.*, 1978; Howell, 1976; Lane and Schuster, 1981; Schuster and Lane, 1980). The high concentrations usually have been found in exotic cotton strains selected for high levels of resistance to insects. Old leaves contain 1-11 percent flavanol tannin depending on cultivar and exact age. Free catechin and gallic acid concentrations ranged from 0.5 to 0.7 percent in young leaves to 0.3 to 0.4 percent in old leaves of Acala 4-42 (Howell *et al.*, 1976). Sadykov (1972) reported total flavanol concentrations of 7-11 percent in petioles of leaves, but Bell and Stipanovic (1978) found very low concentrations (<2%). Hedin *et al.* (1982) concluded that flavanol concentrations in leaf veins were higher than those in the leaf blade. Young capitate hairs on leaves initially contain flavanols but later contain flavanol glucosides.

Hanny *et al.* (1978) found condensed tannin concentrations of 6.0-11.7 percent in flower buds of 37 cotton strains. Parts of dissected mature flower buds from one cultivar contained the following percentages (%) of condensed tannins: receptacle, 11; calyx, 8; fused corolla tube, 18; corolla, 9; anthers, 3.4; carpels, 19; and pistil, 23 (Chan *et al.*, 1978). In more extensive studies, Hanny (1980) found condensed tannin concentrations of 4.8-5.3 percent in anthers of various glanded and glandless cultivars with yellow- or cream-colored pollen. Plants with cream colored pollen contained significantly more tannin in anthers than those with yellow pollen within each of several cultivars.

Guinn (1982) studied concentrations of flavanols in 4-day-old bolls and found concentrations of 2.0-4.6 percent of hot water-soluble and 3.7-8.1 percent of insoluble flavanols. Concentrations in the bolls and in middle-aged leaves did not vary significantly with moisture stress or irrigation regimes, but leaf concentrations were increased by artificial defruiting of plants.



Many pathogens and insects tend to attack tissues and organs of the plant that are low in flavanol content, i.e. root tips, stele, anthers and old leaves. Such attack on tissues may result in marked increases in flavanol content (Mace *et al.*, 1978). Hunter (1974) found that flavanol concentrations in hypocotyls doubled within 24 hours after being inoculated with *Rhizoctonia solani*. Likewise, Bell and Stipanovic (1978) found that flavanol concentrations in stele tissue increased from 0.2-0.8 to 4.2-8.0 percent at 10 days after inoculation with *Verticillium dahliae*. Benedict and Bird (1981) found that mixtures of nonpathogenic *Bacillus* species that increase resistance to boll weevil when sprayed on cotton plants stimulate increases of flavanol synthesis in cotton tissues.

Flavanols apparently have several important functions in cotton. Halloin (1982) found that flavanol polymers and especially their melanized products appear to be involved in the regulation of water uptake by seed. When seed were removed from bolls a few days prior to dehiscence and ripened under nitrogen, they were fully viable, but seed coats were white, fragile and imbibed water much more rapidly than normal seed. Such rapid imbibition would allow extensive deterioration of seed in the field during extended moist periods (see also Chapter 31). Thus, flavanol metabolites are important determinants of seed quality. Flavanols and melanins formed at wound sites and at diseased sites may also prevent dehydration or water congestion of tissues.

Another important role of flavanols is in disease resistance. Flavanols and their oxidation products formed with peroxidase act as bactericides (Vernere, 1980), fungicides (Howell *et al.*, 1976; Hunter, 1978), enzyme denaturants (Hunter, 1974, 1978) and antisporelants (Howell *et al.*, 1976). Hunter (1978) showed that low levels of catechin stimulated pectinase production by a strain of *Rhizoctonia solani* highly virulent to cotton, whereas only inhibitory effects occurred with moderately virulent strains. Thus, the response of pathogens to flavanols may also be important in determining their virulence. Most studies implicating flavanols as determinants of disease resistance in cotton have been reviewed by Bell and Stipanovic (1978). More recent studies indicate that flavanols contribute to increases of resistance with aging against seedling pathogens (Hunter, 1978) and to cultivar resistance against bacterial blight (Vernere, 1980).

Flavanols also contribute to insect resistance, but their precise role is still uncertain. Waiss *et al.* (1981), Hedin *et al.* (1981), Chan *et al.* (1977, 1978) and Elliger *et al.* (1980) showed that condensed tannin and catechin inhibit growth of young larvae of cotton bollworm, tobacco budworm and pink bollworm when incorporated into diets at concentrations greater than 0.1 percent wet weight. Larvae of the budworm quickly lose their sensitivity to condensed tannin with age and are not appreciably affected by even 0.4 percent after they are 7 days old (Waiss *et al.*, 1981). Klocke and Chan (1982) found that bollworms feeding on condensed tannin-treated diet exhibited decreased protease and invertase activities in the midgut caecal wall and lowered total protein and sugar levels in the hemolymph compared to controls. However, these differences apparently had no

effect on assimilation and efficiency of conversion of digested matter into animal biomass. They concluded that reduction in growth is due mostly to reduction in food consumption. Flavanols, therefore, might not be effective in decreasing feeding or growth on the intact plant, which also contains feeding stimulates, even though they inhibit feeding when added alone to synthetic diets.

Cotton stocks resistant to spider mites have consistently shown unusually high levels of condensed tannins in leaves. The isolated tannins from resistant cultivars also have shown greater levels of astringency per unit of tannin than those from susceptible lines, indicating qualitative differences of tannins and flavanols among cottons (Lane and Schuster, 1981). Schuster and Lane (1980) found that four high-tannin cotton lines also had fewer bollworms and less square damage than cotton lines with lower tannin levels. However, two other high tannin lines had no apparent resistance. Based on studies with five cultivars, Hedin *et al.* (1981) concluded that when concentrations of tannins and other phenols (terpenoid aldehydes) were high in cultivars, weights of bollworm and budworm feeding on terminals were low. After more extensive studies, however, Hedin *et al.* (1982) concluded that tobacco budworm larval growth in the field is slightly positively correlated with tannin concentrations. Likewise, Hanney (1980) found that cream-colored anthers in various cottons had higher condensed tannin concentrations than yellow-colored anthers but gave better growth of tobacco budworms. It is important that the interactions of flavanols with feeding stimulants, such as the flavonol glycosides, and with other toxicants, such as the terpenoid aldehydes, be determined. Then, their role in resistance to insects may be more clear.

Flavanols also have several adverse effects. The brown discoloration of baked products prepared from glandless cottonseed flour probably is due to flavanols (Blouin, 1981a,b; Halloin, 1982). Interspecific hybrid plants undergoing genetic lethal reactions show massive spontaneous flavanol synthesis in stele tissues, cambium and phloem where little or no synthesis normally occurs. This response closely resembles the normal induction of flavanols in response to pathogens. Thus, Mace and Bell (1981) concluded that this genetic lethality may be analogous to autoimmune death in animals. The relationships between yield and flavanol content have not been determined. However, it is apparent that increasing flavanol concentrations in leaves from 3-5 to 20-25 percent for insect resistance would cause a considerable drain of photosynthate away from desired products.

## TERPENES

### VOLATILE TERPENES

The cotton plant produces a variety of monoterpenes and sesquiterpenes that are found in essential oils collected by steam distillation of plant parts comminuted in water. Extensive surveys are available of the volatile constituents in flower buds (Hedin *et al.*, 1975a,b; Minyard *et al.*, 1966, 1968, 1969), leaves (Hedin *et*

*al.*, 1972; McKibben *et al.*, 1977), green hulls and bracts (Hedin *et al.*, 1975a), whole plants (Thompson *et al.*, 1971), air space above plants (Hedin, 1976; Hedin *et al.*, 1975c) and cotton lint and waste (Hedin *et al.*, 1975a). The concentrations of essential oils obtained from buds, leaves, whole flowering plants and whole mature plants have usually been 100-150 ppm (fresh weight). Concentrations obtained from young seedlings were 20-30 ppm.

Hedin (1976) studied seasonal variations in the emission of volatiles by cotton plants in the field in Mississippi. Peak emissions (10-26  $\mu\text{g}/4000$  liters of air/8 hr) were produced between July 17 and August 11 when plants were squaring and flowering. Emissions by very young or old plants were less than 5  $\mu\text{g}$ .

Both similarities and distinct differences occur in the volatile terpenes (Figure 5) of *G. hirsutum* and *G. barbadense*.  $\alpha$ -Pinene and *trans*- $\beta$ -ocimene are major monoterpene hydrocarbons and (-)- $\beta$ -carophyllene and  $\alpha$ -humulene are major sesquiterpene hydrocarbons in both species. Terpenoid alcohols found in

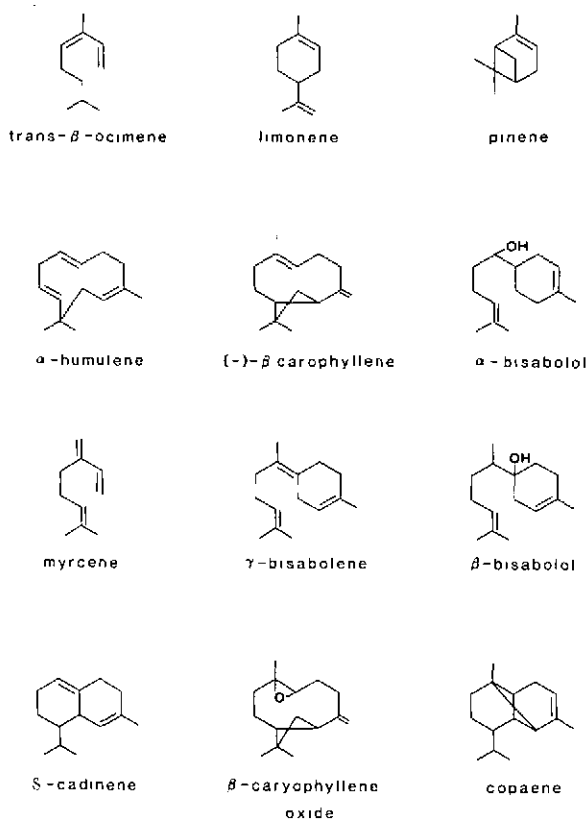

Figure 5. Structures of volatile terpenes from *Gossypium*.

minor concentrations (0.2-2.0 percent of the essential oil) in both species include linalool,  $\alpha$ -terpineol, isoborneol,  $\alpha$ -bisabolol and geraniol. Myrcene is a major monoterpene in *G. hirsutum* but has not been found in *G. barbadense*. Accordingly, terpenoid aldehyde derivatives of ocimene occur in both species, whereas derivatives of myrcene have been found only in *G. hirsutum* (Bell *et al.*, 1978). *G. barbadense* apparently lacks the ability to synthesize myrcene. The sesquiterpenes, *cis*- $\gamma$ -bisabolene and  $\beta$ -bisabolol, occur in concentrations of 12.41 and 13.71% in oils from whole plants of *G. hirsutum* (Thompson *et al.*, 1971) compared to only 0.7 and 0.0 percent in those from leaves of *G. barbadense*. This is another major difference between the volatile terpenoids from the two species. Further differences occur in copacene,  $\beta$ -caryophyllene oxide and (–)- $\delta$ -cadinene, which occur at 14.3, 8.0 and 7.8 percent in *G. barbadense* volatile leaf oil compared to only 0.7, 0.4 and 0.3 percent, respectively, in oils from *G. hirsutum*. These differences might contribute to differences in insect-host relationships between the two species.

Volatile oils have been shown to attract both the boll weevil, *Anthonomus grandis* Boheman (McKibben *et al.*, 1977) and the Egyptian cotton leaf worm, *Spodoptera littoralis* Boisduval (Hedin *et al.*, 1972). The cotton constituents, (+)-limonene, (+)- $\alpha$ -pinene,  $\beta$ -caryophyllene oxide, (–)- $\alpha$ -caryophyllene and (+)- $\beta$ -bisabolol, were effective attractants of boll weevils when used as single compounds (Minyard *et al.*, 1969). Maximal activity of the first three occurred at 0.3-3.0 ppm, while that of the last two occurred at 6-10 ppm in water. A mixture containing 10, 3, 100, 100, and 130 ppb of (+)- $\alpha$ -pinene, (+)-limonene, (–)- $\beta$ -caryophyllene, (+)- $\beta$ -bisabolol and (–)- $\beta$ -caryophyllene oxide, respectively, was 124 percent as attractive as the most attractive volatile oil from cotton buds. McKibben *et al.* (1977) concluded that the volatile oils are sufficiently attractive to guide overwintering boll weevils to fields of seedling cotton. Pheromones from the male weevil are more important in influencing migration later in the season.

Recently, S.B. Vinson and H.J. Williams (personal communication) at Texas A&M University have found that volatile sesquiterpenoids may also attract wasp parasitoids of tobacco budworms. Wasps were attracted especially by  $\beta$ -bisabolol and to a lesser extent by  $\gamma$ -bisabolene, (–)- $\beta$ -caryophyllene oxide and  $\alpha$ -humulene. Thus, certain terpenoids may be useful to facilitate biological control.

No attempt has been made to manipulate the volatile terpenes with cultural or genetic techniques. The distinct differences in the volatile terpenoids of *G. hirsutum* and *G. barbadense* indicate that at least breeding approaches may be practical.

## SESQUITERPENOID NAPHTHOLS AND KETONES

The compounds 2,7-dihydroxycadalene, lacinilene C and their respective 7-methyl ethers were first isolated from cotton bracts (Lynn and Jeffs, 1975; Stipanovic *et al.*, 1975, 1981). The probable biosynthetic relationships among

these compounds are shown in Figure 6. Lacinilene C-7-methyl ether causes a number of responses in animal cells that suggest it as a causative of byssinosis, a respiratory disease of cotton mill workers (Ainsworth *et al.*, 1979b; Kilburn *et al.*, 1979). This compound also is toxic to tobacco budworm (Stipanovic and H. Williams, personal communication). Lacinilene C and its cadalene precursor are bactericides and have been implicated in the resistance of cotton plants to infection by the bacterium, *Xanthomonas campestris* pv. *malvacearum* (Essenberg *et al.*, 1982). Thus, compounds in this group probably serve a normal function of protection of the plant against pests.

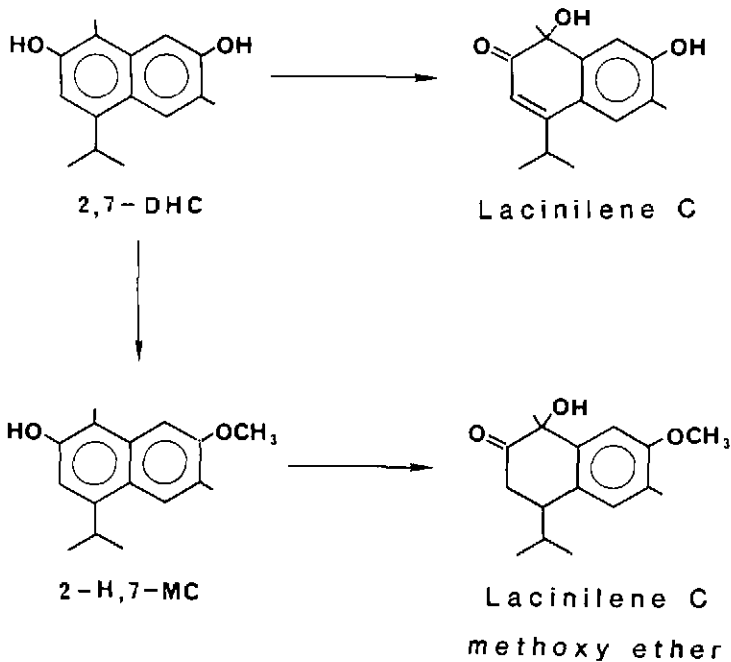

Figure 6. Structures and biosynthetic relationships of sesquiterpenoid naphthols and ketones from *Gossypium*.

The hydroxycadalenes and lacinilenes appear to be formed largely in response to stress in leaves, bracts and surface tissues of stems and bolls. Enhanced synthesis of these compounds has been elicited by inoculations with incompatible (avirulent) bacteria (Essenberg *et al.*, 1982), the boll rot fungus, *Diplodia gossypina*, and the defoliant, DROPP (Holloin and Greenblatt, 1982). "Field-dried" and "frost-killed" bracts and leaves often contain higher levels of lacinilenes than comparable "green-dried" tissues. Thus, synthesis might also be activated by normal senescence or chilling injury. Old green bract tissue, however, is frequent-

ly invaded by weak fungal pathogens, so that lacinilenes in "field-dried" tissues still may be elicited by infection.

Essenberg *et al.* (1982, personal communication) found intense yellow fluorescence, characteristic of lacinilenes, in both palisade and spongy mesophyll cells of bacterial-inoculated leaves, indicating that these are possible sites of lacinilene synthesis. Halloin and Greenblatt (1982) subdivided fungal-inoculated and DROPP-treated bolls into various tissue layers and found hydroxycadalenes and lacinilenes mostly in the outer epicarp tissue. It has not been clearly determined whether synthesis occurs in the epidermis as well as the underlying parenchyma cell layers.

Quantification of lacinilenes is complicated by difficulties in extraction and purification. Several days of extraction apparently are required for complete removal of lacinilenes from tissues with water, ether or ethanol. Beier and Greenblatt (1981, personal communication), Doolan *et al.* (1982), Gilbert *et al.* (1980) and Wall *et al.* (1980a,b) have developed various techniques to clean up cadalenes and lacinilenes and to separate and quantitate them by HPLC. Most of these investigators have reported concentrations of 5-50 ppm (dry weight) of lacinilene C methyl ether in bracts and leaves, and Beier and Greenblatt (1981) found similar concentrations of the other individual cadalenes and lacinilenes. Wall *et al.* (1980a), however, reported concentrations of lacinilene C methyl ether over 200 ppm in gin trash, over 500 ppm in bract, and 36-54 ppm in dust. The reasons for these higher values are not obvious. However, it should be noted that Wall *et al.* (1980a) used natural lacinilene C-methyl ether isolated from gin trash as a standard, whereas other studies have used a chemically-synthesized standard (McCormick *et al.*, 1978) or have calculated concentrations based on the extinction coefficients of the pure crystalline compound (Stipanovic *et al.*, 1975). Lacinilene C-methyl ether supplied by Wall had only about one-third of the biological activity as that of 85 percent pure chemically-synthesized material in tests by Ainsworth *et al.* (1979b). However, it is not known whether this natural lacinilene C-methyl ether was prepared in the same way as the standard used for quantification by Wall *et al.* (1980a). Complete purity of standards is essential, if erroneously high values are to be avoided.

Different cotton cultivars apparently make different amounts of the lacinilenes. G. Greenblatt and I found that the Asiatic cottons, *G. arboreum* and *G. herbaceum*, lack the ability to methylate either 2,7-dihydroxycadalene or lacinilene C. Consequently they make only lacinilene C and its precursor. Stipanovic *et al.* (1981) found that 2 cultivars of *G. hirsutum* had distinctly lower levels of hydroxycadalenes and lacinilenes than three other cultivars. G. Greenblatt and R. Beier (personal communication) further found that Rodgers GL-6 contained only 6 ppm lacinilene C methyl ether in bracts compared to 20-50 ppm in several other cultivars. Results from the latter two studies, however, might reflect different degrees of pest attack, rather than different genetic potential, if the lacinilenes are synthesized primarily in response to pests.

Essenberg *et al.* (1982) found that lacinilene C preparations from the cultivars WbM (0.0) and Im 216 had ellipticities of opposite signs at 331 nm. (+)-Lacinilene C was about 3X more toxic to bacteria than the (-)-lacinilene C. Thus, the toxicity of lacinilenes in tissues apparently can be altered by changing both isomerism and concentration. Detailed studies of environmental and genetic control of hydroxycadalenes and lacinilenes are needed to ascertain their importance and potential usefulness in pest resistance, as well as their role in byssinosis.

## TERPENOID ALDEHYDES

Genera in the plant tribe Gossypae characteristically produce lysigenous glands located below the palisade cells of leaves and the hypodermal cells of stems and capsules (bolls). In older plants, glands are also found in the phloem rays of the bark. Lysigenous glands are composed of a large central cavity containing yellow to orange oily substances surrounded by a single layer of flattened epithelial cells. In green tissues of most *Gossypium* species the epithelial cells are red or purple because they contain high levels of anthocyanins (Chan and Waiss, 1981). In glands of seed, internal bark, staminal tissue and petals the epithelial cells generally do not contain anthocyanins but might contain other flavonoids. The oily substance within the gland cavity contains high concentrations of the terpenoid aldehydes shown in Figures 7 and 8. The occurrence and distribution of these terpenoids among glands of different *Gossypium* species and tissues has been reported by Bell *et al.* (1975, 1978) and Stipanovic *et al.* (1980).

The terpenoid aldehydes, gossypol and its methyl ethers, also accumulate in epidermal cells and a few scattered cortical cells of young roots after they are a few days old (Mace *et al.*, 1974) and later may be exuded from root surfaces (Hunter *et al.*, 1978a). In older roots, these terpenoid aldehydes occur throughout the phelloderm of the root bark. When plants are several months old, the same aldehydes may accumulate in xylem ray cells in the wood. Cells other than those mentioned remain free of terpenoid aldehydes in healthy plants.

Cotton tissues stressed by microbial infections, toxic chemicals or adverse environment synthesize terpenoid aldehydes apparently as a defense response. Examples include the induction of terpenoid aldehyde synthesis in cortical parenchyma of young roots by chilling (Bell and Christensen, 1968), in pericycle of roots by nematodes (Veech, 1978, 1979), in stem cortical tissue by *Rhizoctonia* (Hunter *et al.*, 1978b), in paravascular parenchyma by vascular fungal pathogens and bacteria (Bell and Stipanovic, 1978; Mace *et al.*, 1976), in boll endocarp tissue by boll rotting fungi (Bell, 1967), in germinating seed by fungi (Halloin and Bell, 1979) and in cambial tissue by various pathogenic organisms (Bell and Stipanovic, 1978). Cupric ions and other toxic chemicals also may stimulate terpenoid aldehyde synthesis in these tissues (Bell, 1967; Bell and Stipanovic, 1978). The major terpenoids that accumulate in stressed tissues are hemigossypol, hemigossypol methyl ether and their desoxy precursors. The mechanism of induced terpenoid aldehyde synthesis is not known. However, it has been shown

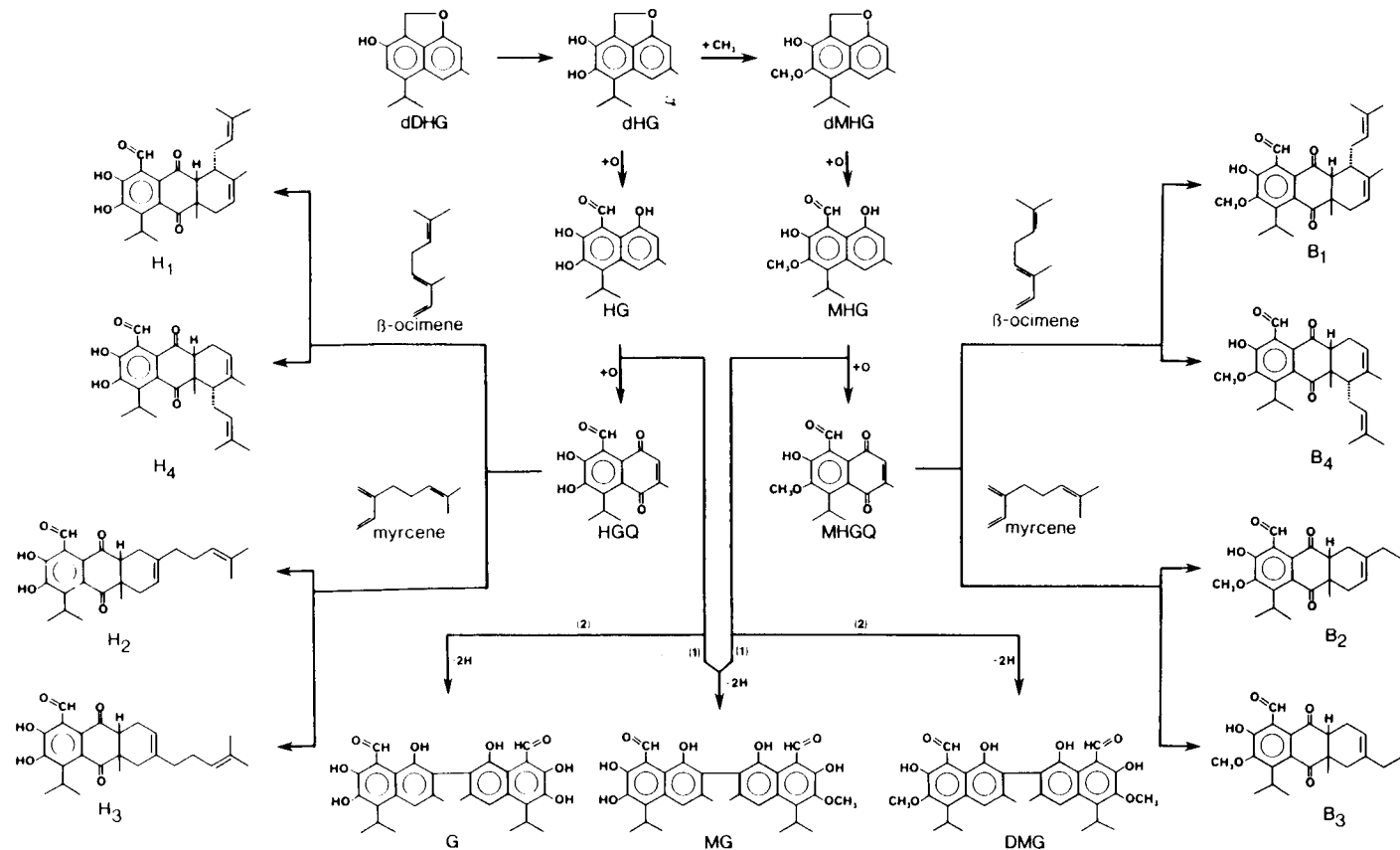
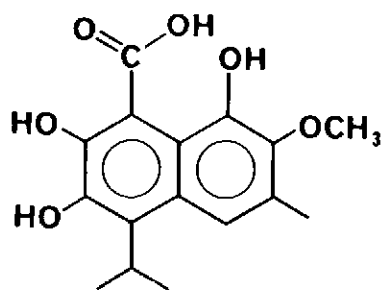
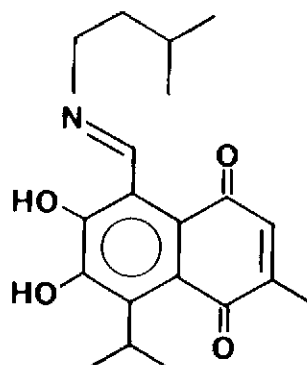

Figure 7. Structures and biosynthetic relationships among terpenoid aldehydes from *Gossypium*.





Raimondal



Gossyrubilone

Figure 8. Structures of raimondal and gossyrubilone.

that dead microbial cells and heteropolymers from cell walls also elicit synthesis, especially in resistant cultivars (Bell and Stipanovic, 1978; Heinstejn, 1980; Stepanichenko *et al.*, 1980)

Heinstejn *et al.* (1979) have reviewed studies of the biosynthesis of gossypol. They concluded that *cis-cis* farnesyl pyrophosphate (FPP) is a precursor of gossypol, and that the prenyltransferase enzyme complex (Widmaier *et al.*, 1980) is probably a key regulator of terpenoid aldehyde synthesis. The first products of cyclization from FPP have not been identified, but these probably are converted to desoxyhemigossypol and then to hemigossypol. Veech *et al.* (1976) have shown that peroxidase converts hemigossypol to gossypol. The heliocides apparently are formed by spontaneous Diels-Alder reactions between terpenoid aldehyde quinones and the monoterpenes ocimene or myrcene (Figure 7; Stipanovic *et al.*, 1977). Other enzymes involved in terpenoid aldehyde synthesis have not been isolated and characterized. However, the recent development of cell suspension cultures of cotton that synthesize gossypol (Heinstejn and El-Shagi, 1981) should facilitate biosynthetic studies.

The terpenoid aldehydes show a wide range of pesticidal activities and are poisonous to most monogastric animals. Many of the studies on biological activity have been reviewed by Bell and Stipanovic (1977, 1978). Recently demonstrated biological activities of terpenoid aldehydes include:

- 1) Toxicity to tobacco budworm, cotton bollworm and pink bollworm, (Chan *et al.*, 1978; Elliger *et al.*, 1978; Hedin *et al.*, 1981; Stipanovic *et al.*, 1977);
- 2) Toxicity to the spiny bollworm, *Earias insulana*, and the cotton leafworm, *Spodoptera littoralis* (Meisner *et al.*, 1977a,b,c,d);
- 3) Toxicity to the root-knot nematode, *Meloidogyne incognita* (Veech, 1979);
- 4) Toxicity to fungi: *Verticillium dahliae* (Paizieva *et al.*, 1977) and *Fusarium*

- oxysporum* (Kaufman *et al.*, 1981; Kumar and Subramanian, 1980);
- 5) Spermaticidal activity (Waller *et al.*, 1980) and menostasis and atrophy of the uterus (Kuo-Fen, 1980) in humans;
  - 6) Toxicity to detrimental gut bacteria in the boll weevil, *Anthonomus grandis* Boheman (Hedin *et al.*, 1978);
  - 7) Histamine release and, at higher concentrations, lysis of blood platelet cells from pig (Ainsworth *et al.*, 1979a) and of mast cells from rat (Elissalde *et al.*, 1983);
  - 8) Uncoupling of oxidative phosphorylation and inhibition of oxygen uptake by rat mitochondria (Paizieva *et al.*, 1977); and,
  - 9) Inhibition of production of pectic enzymes by *F. oxysporum* (Kumar and Subramanian, 1980).

The relative activity of different terpenoid aldehydes has not been studied extensively. Stipanovic *et al.* (1977) found that heliocides formed from ocimene (heliocides H<sub>1</sub> and B<sub>1</sub>) were more toxic to *Heliothis* spp. than those formed from myrcene (heliocide H<sub>2</sub> and B<sub>2</sub>). Others, however, have failed to confirm this observation (Hedin *et al.*, 1981; Elliger *et al.*, 1978). H.H.S. Fong (personal communication) found that the (+)-enantiomer of gossypol from *Thespesia* had no spermaticidal activity even though racemic gossypol from cotton was highly active. The active agent apparently is (-)-gossypol. This observation could be extremely important because most studies of biological activity have involved racemic gossypol acetate prepared by precipitation of gossypol with acetic acid from crude solutions in ethyl ether. Cotton cultivars apparently contain mostly (+)-gossypol plus variable proportions of (-)-gossypol (Dechary and Pradel, 1971). More attention needs to be given to the enantiomer composition of natural mixtures of gossypol and the activity of these natural mixtures.

Terpenoid aldehydes in pigment glands are an important source of resistance to herbivores and insects (Bell and Stipanovic, 1977). Glandless mutants of cotton are attacked by several insect species that normally do not feed on glanded cotton. Likewise, damage by many normal insect pests, rodents and birds is more extensive on glandless cottons. Terpenoid aldehyde contents of tissues generally correlate negatively with insect damage. For example, Hanny (1980) showed that damage by tobacco budworm (*Heliothis virescens*) in cotton cultivars was negatively correlated with the gossypol content of anthers. Seaman *et al.* (1977) and Shaver *et al.* (1980) showed that gossypol, heliocide H<sub>1</sub>, heliocide H<sub>2</sub> and total terpenoid aldehyde concentrations in flower buds were negatively correlated with larval growth of *Heliothis* spp. fed on artificial diets containing extracts of buds. Similar relationships between terpenoid aldehyde contents in plant terminals and leaves of cotton cultivars and inhibition of larval growth has been shown for tobacco budworm, (Hedin *et al.*, 1981, 1982), the leafworm *S. littoralis* (Meisner *et al.*, 1977a,b,d) and cabbage looper (Hanny *et al.*, 1978). The importance of terpenoid aldehydes is further demonstrated by elevated insect resistance in 'high terpenoid' breeding stocks of cotton (Bell and Stipanovic, 1977; Sappenfield and Dilday, 1980).

The induced synthesis of terpenoid aldehydes is an important resistance mechanism against microbial pathogens (Bell and Stipanovic, 1978). However, efficacy is determined by how quickly the terpenoids are synthesized in response to the pathogen rather than by the concentration that eventually accumulates.

More rapid synthesis of terpenoid aldehydes in resistant than in susceptible cultivars has been demonstrated against the fungal pathogens *Fusarium oxysporum* (Kaufman *et al.*, 1981; Harrison and Beckman, 1982; Kumad and Subramanian, 1980) and *Verticillium dahliae* (Bell, 1969; Mace, 1978), the root knot nematode *Meloidogyne incognita* (Veech, 1978, 1979) and the bacterial pathogen *Xanthomonas malvacearum* (Bell and Stipanovic, 1978). Changes of resistance resulting from tissue aging also are associated with how quickly toxic levels of terpenoid aldehydes are accumulated (Bell, 1969; Bell and Stipanovic, 1978; Hunter *et al.*, 1978). The physiological bases for quick synthesis of terpenoids in response to pathogens have not been determined.

While terpenoid aldehydes are important for pest resistance, they also may have adverse effects. Gossypol, in lysigenous glands, makes up 0.5 to 1.0 percent of the dry weight of cottonseed from most cultivars. This concentration is highly toxic to most monogastric animals. Thus, cottonseed can not be used for food, and only small amounts can be used in poultry and swine feed. Appreciable concentrations of terpenoid aldehydes also occur in dried bract tissue and in mill dust which contains bract residues. Loewenschuss and Wakelyn (1972) found 440 to 650 ppm free gossypol in dry bracts of cotton. Stipanovic and Bell (unpublished) recently found that mill dust contained over 400 ppm free gossypol and 250-300 ppm of each heliocides H<sub>1</sub> and H<sub>2</sub>. These concentrations are far above those required to cause lysis of pig blood platelets (Ainsworth *et al.*, 1979a) and release histamine from rat mast cells (Elissalde *et al.*, 1983). Thus, terpenoid aldehydes in dust need to be evaluated as possible contributing factors to byssinosis.

Variability of terpenoid aldehyde content in different tissues has been studied in considerable detail. Dilday and Shaver (1976a,b, 1980) surveyed terpenoid aldehyde concentrations in flower buds from more than 200 primitive stocks of *Gossypium hirsutum* during three different years. They found significant variations in terpenoid concentrations among stocks and between seasons. Subsequently, Dilday and Shaver (1981) also found significant variations between different sampling dates during a single season. They concluded that comparisons of genotypes at least should be based on samples taken on the same date, and for best results means should be obtained from several sampling dates. Flowerbuds from several race stocks had terpenoid concentrations about twice as high as those in prevailing commercial varieties. These stocks should be useful to increase resistance against insects that feed on flower buds.

Hanny *et al.* (1978) surveyed terpenoid aldehyde and tannin content in seed, flowerbuds, terminals and leaves of 39 cotton genotypes. Terpenoid aldehyde content ranged from 0.18 to 1.29 percent in seed, 0.11 to 0.83 percent in flowerbuds, 0.09 to 0.44 percent in terminals, and 0.11 to 0.24 percent in leaves.

Damage from cabbage loopers (*Trichoplusia ni* Hubner) was negatively correlated (-0.60) with terpenoid concentrations in terminals. Two genotypes HG-BR-BN and HG-6N-1 had desirable combinations of high flowerbud and terminal terpenoid content with moderate levels in seed.

The genetics of pigment gland formation and terpenoid aldehyde synthesis has been reviewed by Bell and Stipanovic (1977). Six different genes have been shown to control gland density, but the major controlling genes are  $G1_2$  and  $G1_3$ . Lee (1977) has shown that the expressions of  $G1_2$  and  $G1_3$  depend on the overall genetic background of a given cotton stock. The monomers  $G1_2G1_2g1_3g1_3$  and  $g1_2g1_2G1_3G1_3$  produced 3.03 and 1.18 percent gossypol in seed in the '3-T' genetic background but only 0.69 and 0.24 percent in the Acala 4-42 background, respectively. Lee (1978) and Wilson and Smith (1977) have shown that  $G1_3$  alleles from different cotton species or stocks may give different levels of terpenoid aldehydes and pigment gland density in bolls and flower buds. The allele designated as  $G1'_3$  or  $G1r_3$  was more potent than  $G1^{rm}_3$ , which in turn was more potent than  $G1_3$ . Monomeric  $G1r_3$  gave 97.2 glands/cm<sup>2</sup> on bolls compared to only 19.6 for monomeric  $G1_3$ .  $G1'_3$  and  $G1r_3$  probably both designate the  $G1_3$  allele obtained originally from the Socorro Island wild accession of *G. hirsutum*. Progress in using various genes to breed high terpenoid cottons for insect resistance has been reviewed by Sappenfield and Dilday (1980).

## UNIQUE FATTY ACIDS AND LIPIDS

Cotton, like several other malvaceous plants, produces the cyclopropene fatty acids, malvalic and sterculic acid (Figure 9), and the cyclopropane fatty acids, dehydromalvalic and dehydrosterculic acid. These fatty acids make up 1-2 percent of the weight of oil from cottonseed (Bianchini *et al.*, 1981) and 0.02-0.10 percent of total dry weight (5-8 percent of the total fatty acids) of flower buds (Chan *et al.*, 1978). Similar amounts of each of the four acids, with a slight preponderance of malvalic, occur in cottonseed oils. The methyl esters of cyclopropene fatty acids are toxic to insects, but only at concentrations (0.3-0.6 percent) far greater than found in foliage and flowers. Cyclopropene fatty acids enhance the toxicity of terpenoid aldehydes to animals when the compounds are mixed (see references in Bell and Stipanovic, 1977). A possible similar role in pest resistance should be evaluated. Nothing is known about the effects of genotype or environment on the cyclopropenoid fatty acid content of cotton tissues.

Vick and Zimmerman (1981) have shown that young cotton seedlings contain the enzymes lipoxygenase, hydroperoxide isomerase and hydroperoxide cyclase. These enzymes convert linolenic acid to the compounds shown in Figure 9. When linolenic acid was reacted with crude enzymes from 4-day-old etiolated cotton seedlings, 10 percent 9-hydroxy-12-oxo-*cis*-15, *trans*-10-octadecadienoic acid ( $\gamma$ -ketol; Figure 9), 60 percent 12-oxo-13-hydroxy-*cis*-9, *cis*-15-octadecadienoic

acid ( $\alpha$ -ketol; Figure 9) and 25 percent 12-oxo-phytodienoic acid (12-oxo-PDA; Figure 9) were obtained. These compounds are formed by a number of plant species, but their physiological importance is unknown. Their resemblance to prostaglandins and leukotrienes formed from arachidonic acid by similar enzymes in animals is striking. The latter compounds are extremely potent regulators of immune reactions and other biological functions.

The surface wax of glabrous 'Bayou SM1' (*G. hirsutum*) was analyzed by Hanny and Gueldner (1976). They recovered 0.68 mg of wax/g fresh terminal shoot. The wax contained 49.9 percent n-alkanes, 5.5 percent n-primary alcohols and 44.6 percent sterols and related triterpenoids. The predominant alkane was n-

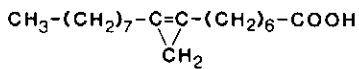

malvalic acid

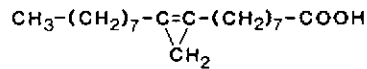

sterculic acid

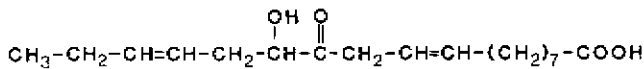
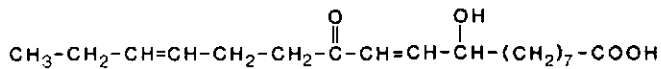
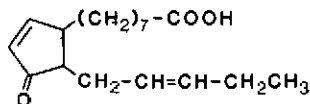
 $\alpha$ -ketol $\gamma$ -ketol

12-oxo-PDA

Figure 9. Structures of cyclopropene fatty acids and fatty acid derivatives of linolenic acid.

nonacosane ( $C_{29}H_{60}$ ) and the predominant alcohol was n-octacosanol ( $C_{28}H_{58}O$ ). Various sterols each made up 0.4 to 6.5 percent of the wax. Nine of nineteen detected sterols and triterpenoids were identified. Cuticular extracts from cotton are toxic to various fungi (Wang and Pinckard 1973), but the specific toxic compounds have not been identified. Terpenoid aldehydes from pigment glands might also occur in such preparations, because these are readily eluted by solvents used to extract waxes.

## SUMMARY

The secondary products of cotton make up a considerable percentage of the weight of the plant and apparently are essential for the plant to cope with pests and stress. Many of these compounds have been identified, but we know very little about their biochemistry or physiology. These compounds can be manipulated by genetic hybridization and selection and by environmental manipulation. Studies on the physiology of secondary products should be a fruitful area of future research and are essential before secondary products can be used judiciously for pest control.

## Chapter 39

ORGAN AND TISSUE CULTURE  
OF COTTON

James McD. Stewart<sup>1</sup>  
USDA-ARS  
Knoxville, Tennessee

## INTRODUCTION

The use of organ and tissue culture as a research tool is well established, but the use of these techniques on cotton has been relatively limited in the past, considering the importance of the crop. Current trends indicate that past neglects are being rectified. Historically most of the work on cotton was with ovule culture both for developmental and physiological studies on the seed and fiber and for interspecific hybridization. Recent activity, especially in the private sector, has centered on developing systems for organogenesis from unorganized tissues.

The purpose of this chapter is to summarize the work done on cotton organ and tissue culture to this point without detailing the methodologies and media involved. Those interested in specific details are directed to the original references. Since tissue culture in cotton is an area that is now progressing rapidly, this review should be considered only as a starting point for the serious student interested in using the techniques.

## EMBRYO CULTURE

The first use of embryo culture in cotton was reported by Skovsted (1935). A weak embryo of *Gossypium davidsonii* x *G. sturtianum* was rescued and cultured on sterile glucose-agar. Beasley (1940) and Weaver (1958) used a similar approach but included White's minerals in the medium to rescue hybrid embryos of diploid and tetraploid cottons. Supplements to White's medium such as coconut milk, tomato-juice extract or casein hydrolysate failed to improve the growth of cotton embryos younger than 27 days postanthesis (DPA) (Lofland, 1950). Embryos older than 27 days grew rapidly on basal medium without supplements. Dure and Jensen (1957) examined the capacity of immature embryos (approx. 37 mg and 64 mg fresh weight) to respond in culture, especially with respect to the presence of indole acetic acid (IAA) or gibberellic acid (GA). The embryos were placed for 10 days on a 2 percent sucrose-agar base containing a modified White's medium (Randolph and Cox, 1943) plus or minus the hormone additive. The

<sup>1</sup>Presently with University of Arkansas, Fayetteville, Arkansas

younger embryos responded very little. In the larger embryos GA promoted cell expansion and inhibited reserve accumulation. Stewart and Hsu (1977b) subcultured embryos, which were obtained through *in ovulo* culture (see below), on a low salt medium that contained a higher level of  $\text{NH}_4^+$  and  $\text{NO}_3^-$  than White's medium. Also, vitamin supplements improved results. Subsequently, they found that rescued embryos grew better when the medium was adjusted to pH 7.0 compared to pH 5.5 (Stewart, 1979).

The most successful culture of isolated, immature embryos was reported by Mauney (1961). Although results were highly variable, he found that a high salt medium, and particularly a high osmolarity (circa 10 atm.), was essential for embryo development. He and coworkers (Mauney *et al.*, 1968) analyzed the liquid endosperm of cotton for organic acids and found a high level of what appeared to be malic acid. Subsequently, addition of ammonium or calcium malate (4 mg malate per ml) to the culture medium gave much better survival of heart stage embryos. Sodium malate was inhibitory, and salts of succinate and citrate were inferior to ammonium malate. The optimum osmotic balance also declined to about 8 atmospheres when malate was present.

No additional work on the culture of isolated zygotic embryos of cotton has been reported because *in ovulo* embryo culture (see discussion this chapter) has proven to be a simpler and more successful method for rescuing embryos. However, with the current efforts to obtain somatic embryogenesis from callus or suspension cells (see discussion this chapter), there is increased interest in techniques that will promote development of viable embryos and, subsequently, plants.

## OVULE CULTURE

Ovule culture has received the most attention and has been used for a wider range of objectives than any other aspect of *in vitro* culture of cotton. This organ is particularly attractive as an explant for physiological research because it bears both the fibers and the embryo. Accordingly, it has served, and continues to serve, as a model system to study nutrition, phytohormone regulation, differentiation, cellulose synthesis, fertilization and embryogenesis, and interspecific hybridization. These systems are aided by the fact that sterile culture of cotton ovules is relatively easy compared to many crop species because of their size (1-2 mm length), number per ovary (32-40) and ease of excision.

The first reported attempt to culture ovules was by Joshi (1960). Six DPA ovules were excised and cultured on a low salt medium containing casein hydrolysate, vitamins, IAA, and GA. Growth of the ovules was generally abnormal and fibers did not continue to grow. Nevertheless, this method was later used in exploratory work to obtain interspecific hybrids of Asiatic and Upland cottons (Joshi and Pundir, 1966; Pundir, 1972). The original culture method was later elaborated and various ovule growth responses documented (Joshi and Johri,



1972). A few complete but small embryos were obtained in this case. Their observation of polyembryony is interesting in view of the efforts to obtain regeneration from unorganized tissue (see *Regeneration* below).

Rapid progress in the culture of cotton ovules began in the early 1970's and continued through the decade. The research objectives of the period can be placed in two broad categories: (1) culture to determine the physiological and biochemical determinants of fiber and seed growth, and (2) culture to optimize *in ovulo* embryogenesis. The two objectives are not mutually exclusive, and both areas of research have provided a much greater understanding of the physiology of seed and fiber development in cotton.

### CULTURE FOR SEED AND FIBER DEVELOPMENT

The first indications of a successful method of ovule culture for fiber development were preliminary reports of Beasley and coworkers (Beasley, 1971; Beasley and Ting, 1971; Beasley *et al.*, 1971). The essential features for success were the use of a high salt medium [a modification of Murashige and Skoog, 1962 medium, (MS)] and use of liquid culture rather than agar solidified medium. The preliminary reports were followed by two classic papers (Beasley and Ting, 1973; 1974) which described the effects of phytohormones on fiber development on fertilized and unfertilized ovules. Independently, reports concerned with fiber development on cultured ovules were published by a Belgium group (DeLange and Eid, 1971; Waterkeyn *et al.*, 1975; Baert *et al.*, 1975). This group also found that MS medium was superior to media with lower mineral concentrations. They examined the effects of auxin and GA and reached the same conclusions as Beasley and Ting (1971), namely, growth of fertilized ovules with their associated fibers was greatly stimulated, if GA were added to the medium. Auxin was much less stimulatory. If the ovules were not fertilized, auxin was a requirement for fiber growth. Beasley and Ting (1973, 1974) found that kinetin slightly inhibited growth of fertilized ovules and fibers but stimulated unfertilized ovule growth. In this latter case the unfertilized ovules did not produce fibers. ABA was inhibitory in either case.

More detailed discussions on the role of phytohormones in fiber development are found in Chapters 23 and 25. Details concerning the culture system and subsequent observations by Beasley and coworkers may be found in three reviews (Beasley, 1974; Beasley *et al.*, 1974; Beasley, 1977b).

The culture system developed by Beasley became the standard procedure from which a number of additional physiological studies were launched. For example, growth of fibers on unfertilized ovules in culture was found to depend not only upon IAA but also upon temperature (Beasley, 1977a). Below 34C many ovules did not produce fibers even though they enlarged. If  $\text{NH}_4^+$  were included in the medium, more ovules produced fibers at temperatures below 28-32C than when the cation was absent. Birnbaum *et al.* (1974) showed that boron was essential for normal growth of ovules with their associated fibers. When boron was absent

from the medium, fibers were not produced and the ovules formed extensive callus. The influence of ethylene on cultured ovules was reported by Hsu and Stewart (1976). Ethylene supplied as 2-chloroethylphosphonic acid inhibited normal growth of the ovule but promoted callus growth from the micropylar end of the ovule. A synergistic production of callus from the entire ovule resulted if GA were in the medium, but IAA tended to suppress the callus growth (Stewart and Hsu, 1977a). The tendency for ovules cultured for more than 2-3 weeks to form callus even in the absence of exogenous ethylene was used by Hsu and Stewart (1979) to generate callus cultures of cotton (see below).

The ovule culture system was also used to study the enzymology of fiber development. Dhindsa *et al.* (1975) were able to demonstrate that ovules and fibers grew better when CO<sub>2</sub> was present in the culture environment than when it was absent. Later it was demonstrated that GA stimulated phosphoenolpyruvate carboxylase and other enzymes involved in nonphotosynthetic CO<sub>2</sub> fixation (Dhindsa 1978b). Delmer and coworkers made limited use of the ovule culture system to examine glucan synthesis in fibers (Delmer *et al.*, 1977; Meinert and Delmer, 1977; Maltby *et al.*, 1979). Additional discussion on these reports as they relate to fiber development may be found in Chapter 23.

### IN OVULO EMBRYO CULTURE

The second general objective for culturing ovules is to obtain embryogenesis in a controlled environment. The major impetus to develop a suitable culture system has been to overcome the interspecific incompatibility that occurs between many of the *Gossypium* species. The barriers were of major significance since these prevented hybridization of the diploid Asiatic cottons with the tetraploid American cottons. Weaver (1958) showed that the incompatibility resulted from premature degeneration of the endosperm so that the embryo starved. In those hybrid crosses where incompatibility is due to failure of the endosperm to develop, one might expect ovule culture to be most successful.

As mentioned earlier, Joshi and Johri (1972) tried to culture ovules on a low salt medium, but they had only marginal success. Eid *et al.* (1973) compared four media with respect to their ability to support ovule and embryo development. The high salt medium of Murashige and Skoog (1962) was superior to three low salt media when ovules aged 5, 10, 15 and 20 DPA were cultured. The authors obtained normal embryos from ovules placed in culture at 10 days postanthesis. Five-day-old ovules also produced embryos that could be subcultured on MS but these grew abnormally. Stewart and Hsu (1977) subsequently reported a method of *in ovulo* embryo culture that had features of both the Beasley-Ting technique for fibers and the technique of Eid *et al.* (1973) for embryos. With their modifications they were able to grow self-pollinated ovules from 2 DPA (zygote stage) to maturity (germination). The basic culture techniques were those elaborated by Beasley (1974), and the medium (BT) contained the phytohormones recommended for optimum fiber growth. An essential ingredient for embryo development was the presence of ammonium ions (NH<sub>4</sub><sup>+</sup>). Stewart and Hsu (1977) speculated

that the high  $\text{KNO}_3$  of the BT medium was necessary for early embryo growth and that the ammonium was essential for later embryo growth.

Stewart and Hsu (1978) used their ovule culture technique to obtain interspecific hybrids between the Asiatic diploid cottons and the American tetraploid cottons in all possible combinations. In most cases the presence of GA and kinetin in the culture medium was deleterious to recovery of hybrid plants. Consequently, they recommended that only auxin be used when culturing ovules of species other than *G. hirsutum*. Also, they found that the ovules of *G. arboreum* and *G. herbaceum* were prone to callus formation, but that this did not prevent embryogenesis. However, callus growth did cause ovules to sink in the medium, resulting in anoxia of the embryo. A filter paper bridge was constructed and placed in the culture flask to prevent this (Stewart and Hsu, 1978).

The basic *in ovulo* embryo culture technique was subsequently used to make interspecific hybrids between the four cultivated species of cotton and a wide variety of wild *Gossypium* species (Stewart, 1979, 1981). Many of these hybrids had not been obtained by conventional techniques of cross-fertilization.

### IN VITRO FERTILIZATION

*In vitro* fertilization is a technique that is dependent upon an adequate procedure to culture ovules. With a system available to culture cotton ovules from anthesis to maturity, direct fertilization of the ovules should be possible. Stewart (1981) made a preliminary report of successful *in vitro* fertilization, but additional work has not been reported.

## TISSUE CULTURE

### CALLUS INDUCTION AND CULTURE

Callus formation in cotton was first reported by Beasley (1971) as an outgrowth from the micropylar end of ovules cultured on MS medium. The tissue did not grow well when subcultured. Results reported by Hsu and Stewart (1976) indicated that the callus from the micropylar end of ovules was induced by ethylene. In the presence of ethylene and GA, the entire outer integument of the cultured ovules formed callus (Stewart and Hsu, 1977a). The callus from these cultures, although extensive, was not subcultured.

Schenk and Hildebrandt (1972)[SH] included cotton as one of the many species they used to develop their medium. In that case callus was derived from mesocotyl explants cultured with 0.5 mg/l 2,4-dichlorophenoxyacetic acid (2,4-D), 2 mg/l *p*-chlorophenoxyacetic acid (*p*-CPA), and 0.1 mg/l kinetin (K) with sucrose and the SH salts. Davis *et al.* (1974) were the first to specifically examine the induction of callus from cotton (cotyledon tissue). Since that time numerous reports have appeared concerning the induction and maintenance of callus from various cotton tissues and species (Sandstedt, 1975; Rami and Bhojwani, 1976; Katterman *et al.*, 1977; Smith *et al.*, 1977; Price *et al.*, 1977).

The hormonal regimes and media adjuvants used to induce callus growth varied widely among investigators. In all cases either IAA or a synthetic auxin was used, but the concentration ranged from 0.1 mg/l 2,4-D (Davis *et al.*, 1974) to 17 mg/l NAA (Katterman *et al.*, 1977). In most reports a low level of cytokinin was included in the induction medium. Myoinositol was 100 mg/l in all reports except Davis *et al.* (1974) who reduced the level to 5 mg/l. Most media formulations called for glucose rather than sucrose to decrease the amount of pigment production by the tissue (Sandstedt, 1975; Katterman *et al.*, 1977; Smith *et al.*, 1977). In other efforts to reduce pigment in the cultures, Davis *et al.* (1974) added ascorbic acid, and Katterman *et al.* (1977) added dithiothreitol. Apparently a chemically reducing environment inhibits the formation of the characteristic brown pigmentation that is a common feature of cotton tissue cultures.

In some cases the medium that supported optimum callus induction did not support optimum callus growth on subculture. Price *et al.* (1977) induced callus from six species of *Gossypium* with 2 mg/l IAA and 1 mg/l kinetin, but they found that the best conditions for subculture varied with the species. In most cases the cytokinin, 2iP, and the auxin, NAA, at species specific concentrations gave good callus growth and maintenance over many subcultures. Smith *et al.* (1977) found that NAA and benzyladenine at 2 mg/l and 1 mg/l, respectively, gave good subculture growth after induction with IAA and kinetin.

From the foregoing it is obvious that a standard method for induction and maintenance of cotton callus has not been established. However, only a few criteria seem essential for callus induction. Namely, a high salt medium such as SH or MS and an auxin source such as IAA, NAA or 2,4-D. Cytokinins are beneficial but may or may not be essential. Use of glucose reduces tissue browning, or, if sucrose is used, a reducing agent can be included in the medium for that purpose. Different cotton species have different requirements for optimum hormone levels. In fact, genotypes within *G. hirsutum* respond differently to regimes designed to induce callus growth (Umbeck and Stewart, unpublished data; Fischer, personal communication).

## SUSPENSION CELL CULTURE

Culture of cotton cells in suspension has been a natural outgrowth of callus culture and has been of more general use than callus. Davis *et al.*, (1974) first reported suspension cultures of cotton as an appendix to their paper. The successful culture in suspension of cells derived from anthers was accomplished by Barrow *et al.* (1978). Other reports of *G. hirsutum* cell suspension cultures for specific applications will be discussed below. *G. klotzschianum* (Price and Smith, 1979) and *G. arboreum* (Hsu and Stewart, 1979; unpublished data) cells also have been grown in liquid culture. Generally, media that supported actively growing friable callus on agar also supported cell growth in liquid when agitated for aeration.

Cotton suspension cultures have been used effectively for specific purposes. Frear and Swanson (1975) examined the metabolism of cisanilide, an experimen-

tal herbicide. Ruyack *et al.* (1979) developed both callus and suspension cultures from bacterial blight resistant and susceptible cottons. The cultures responded to the pathogen challenge in the same manner as the source plant; thus, they could be used in place of intact plants to study the mechanisms of resistance. The susceptible culture was subsequently used to examine induction of  $\beta$ -galactosidase activity (Mitchell *et al.*, 1980).

Cultures high and low in gossypol production were developed by Heinsteins (1981) to examine the biosynthetic reactions leading to gossypol. Rapidly growing light or white cultures had very little gossypol while dark brown cultures were high in gossypol. There was an inverse relation between growth rate and gossypol synthesis.

### ANTHER AND MICROSPORE CULTURE

Cell cultures derived from microspores are particularly useful in generating large numbers of haploid plants, if regeneration can be accomplished. A preliminary report by Barrow (1977) was the first indication of success in establishing anther-derived callus cultures from upland cotton. Subsequently, Barrow *et al.* (1978) reported in detail the initiation of callus from anthers of both *G. hirsutum* and *G. barbadense*. Cell suspension cultures were produced from the *G. hirsutum* callus. Most of the cultures were diploid, but approximately 3 percent contained haploid cells. Haploid cells were found to grow more rapidly than diploid cells in culture. Baluch (1979) also reported callus from anthers of *G. hirsutum* and certain interspecific hybrids. He stated that "the callus seemed to be of microspore origin", but no evidence was presented. No one has obtained plant regeneration from anther-derived callus.

Barrow (personal communication) attempted to establish a medium in which cotton microspores would survive. From that effort a number of essential features are evident. Most importantly, the pH must be above 6.5, with 7.0 being optimal. A high level of  $K^+$ , such as is found in MS, is beneficial, but  $NH_4^+$  and  $Ca^+$  are toxic and tolerated only at very low concentration. Other constituents frequently used in media are more or less neutral and are tolerated at standard media concentrations. Long term survival of the microspores requires glucose as the carbohydrate source, but ribose may be helpful also. While microspores survive with the medium adjustments described, cell division has not been observed, even under the influence of various auxins and cytokinins (Barrow, personal communication.)

### PROTOPLASTS

The potential for using plant protoplasts for somatic cell hybridization and other genetic engineering techniques has stimulated interest in using the technology for crop improvement. Beasley *et al.* (1975) were the first to indicate the possibility of obtaining protoplast from cotton ovules, but their preliminary work was not carried further. A specific effort to obtain cotton protoplasts was reported by Bhojwani *et al.* (1977). The source of material used in that case was a callus

derived from hypocotyl tissue. A mixture of three enzymes with 11 percent mannitol and inorganic salts was used to remove cell walls. Survival of the protoplasts required a temperature above 25C and the presence of ammonium nitrate and calcium chloride in the medium. Cell wall regeneration occurred, but only about 1-2 percent of the protoplasts were competent to form small colonies of cells. Large callus was not obtained. Khasanov and Butenko (1979) succeeded in isolating protoplasts from cotyledons and leaves, but again, only small colonies could be obtained from surviving protoplasts. They reported that galactose aided in the regeneration of cell wall. Finer and Smith (1982) isolated and cultured protoplasts from *G. klotzschianum*, a wild relative of cotton. Small colonies of about 50 cells were obtained from surviving protoplasts, but these did not grow upon subculture.

One of the interesting developments in cotton protoplast work was that reported by Gould and coworkers (Gould and Dugger, 1982; Gould *et al.*, 1983; Gould, personal communication). Protoplasts were isolated from the epidermal layer of ovules on the day of anthesis. Many of these doubtlessly were fiber initials that could be used for additional research into differentiation. They were also able to isolate subprotoplasts from 14 day-old fiber cells of ovules grown in the culture system of Beasley and Ting (1974). Most of these subprotoplasts were anucleate but were capable of wall synthesis, nevertheless. These isolates also hold some potential for nuclear transfer experiments.

The few reports on cotton protoplasts demonstrate that they can be obtained by more or less standard techniques. On the other hand, adequate techniques are yet to be reported for returning the protoplasts to actively growing cell suspension cultures or calli. A number of commercial companies are actively working with cotton cultures, so it is possible that techniques have been developed that are not in the public domain.

## REGENERATION OF PLANTS

One goal in most tissue culture research is to induce cells that have proliferated in an unorganized manner to undergo either embryogenesis or organogenesis so that intact plants are obtained. Until recently this had been a seemingly difficult task in cotton. Root regeneration apparently occurs rather frequently (Sandstedt, 1975; Rani and Bhojwani, 1976; Katterman *et al.*, 1977; Smith *et al.*, 1977; Smith and Price, 1978). Price and Smith (1979) reported somatic embryogenesis in suspension cultures of *Gossypium klotzschianum*. Although the cultures were highly embryogenic after recurrent embryogenic callus selection, the embryoids that developed rarely continued development into a complete plant. The first report for efficient and repeatable regeneration of cotton (*G. hirsutum*) plants from callus was that of Davidonis and Hamilton (1983). Their report highlights a significant feature. As in other species, selection of specific types of callus was necessary; namely, repetitive selection of embryogenic callus from non-embryogenic callus. The addition of GA to the medium in order to promote leaf (shoot?) development may also be a factor. Other conditions were those commonly used in

tissue culture. A number of companies involved in genetic engineering have now indicated that their scientists also have regenerated cotton.

The ground work has been laid for the various techniques needed in order to use tissue culture as a tool for cotton improvement. Although a number of difficulties remain, the technology is progressing rapidly, especially in the private sector. A fully established cycle for callus induction (or protoplast production), cell cloning, resistance selection or other genetic modification, followed by plant regeneration holds great promise for cotton. Not only will cotton producers benefit in terms of more efficient crop production, but the genetic engineering concerns will benefit in terms of technology-derived sales.

## Chapter 40

# THE INTERFACE BETWEEN PLANT PHYSIOLOGY AND GENETICS

Jerry E. Quisenberry  
USDA-ARS  
Lubbock, Texas

## INTRODUCTION

When a researcher attempts to interface the plant physiology and plant genetic disciplines, he or she is immediately confronted by “jargon” from both disciplines. Jargon is defined as “obscure and often pretentious language marked by the use of an unnecessarily large number of words to express an idea or the technical terminology of a special group or activity.” Before an effective dialogue can take place between researchers in the two disciplines, terms used by each discipline must be defined in such a way that they clearly relate what each discipline is trying to express. We must constantly recognize that if we expect our research to be used, our results should be clear to our prospective “user” and to cooperating researchers from various disciplines.

## PLANT PHYSIOLOGY

*Plant physiology* is “the study of plant function.” This definition does not exclude plant structure, but it places the primary emphasis on plant function. The basic study of plant function has been a very challenging and rewarding intellectual pursuit, but there are also several practical reasons for studying plant function. These include contributions to the basic principles of crop management for optimum production and perhaps to a lesser degree to the development of crop germplasm. In crop management, plant physiology has contributed basic concepts in mineral nutrition, irrigation management, weed control, allelopathy, growth regulators, seed production and food technology. Plant physiology has contributed much less to the development of crop germplasm. Future inputs of plant physiological research into germplasm development probably will be made through the study of physiological ecology or environmental physiology.

*Ecology* is “the study of organisms in relation to their environment.” It follows from this definition that *environmental physiology* is “the study of plant ecology through an understanding of plant function.” The effects of various environmen-



tal parameters on physiological responses make up the heart of environmental physiology. One of the primary questions of environmental physiology is: "Why does a plant occur in a certain environment?" The answers to this question are: (1) by chance it happened to be there; (2) it can survive, grow and reproduce in that environment; or (3) it has not been eliminated by competition from other plants or animals. Environmental physiology is only concerned with the answer to how a plant survives, grows and reproduces. In developing new crop germplasm adapted to specific environments, the plant breeder depends on the environmental physiologist to provide this information for a specific plant and in terms he can understand and, more importantly, use.

## PLANT GENETICS

*Plant genetics*, the scientific discipline of plant breeding, is "the study of the heredity mechanisms through which traits are passed from generation to generation" (Burns, 1969). Genetics is usually divided into the study of quantitative (differences among individuals that are of degree) and qualitative (differences among individuals that are of kind) traits. Virtually every organ and function of a plant have individual differences of a quantitative degree. Quantitative differences form a continuous series from one extreme to the other and do not fall naturally into sharply demarcated types. In contrast, qualitative differences separate individuals into distinct types with little or no connection by intermediate types. Examples of qualitative traits in cotton are red and green plant color, okra and normal leaf shape, etc. The mechanism of inheritance between quantitative and qualitative genetics is related to the number of genes that causes the observed differences. Quantitative differences, in so far as they are inherited, depend on gene differences at many locations on the chromosomes, the effects of which are not individually distinguishable (Falconer, 1960).

## PHYSIOLOGICAL GENETICS

Most of the available literature shows clearly that the study of plant physiology and the study of plant genetics have proceeded largely independently of each other. The geneticist, preoccupied with the study of easily defined, mainly morphologic or agronomic traits, has tended to ignore possible genetic components of physiological traits. Reasons for this approach have been: (1) the greater difficulty in measuring physiological traits as compared with morphological ones; (2) the lack of available data supporting the importance of physiological traits; and (3) the lack of adequate training in plant physiology among plant geneticists. On the other hand, plant physiologists have given little attention to potential genetic components of physiology. Much of the physiology data assumes a relatively constant response for a crop species. This relatively constant genetic type is surveyed for a series of physiological responses so that the responses themselves

are the variables under study (Ehrman and Parsons, 1976).

In both physiology and genetics, the organism of primary importance is the plant. Through measurement, the plant is given a value which is the phenotype. The phenotypic value results from the interaction of the plant's genes with its previous or present growth environment. In a mathematical sense, a plant's phenotype can be expressed as its genotype + the environment + the interaction of these two. An example of this type of interaction is shown in Figure 1. Verhalen and Murray (1970) showed the interaction of lint yield among several cotton (*Gossypium hirsutum* L.) cultivars and locations. The cultivars produced different yields depending on the location where they were grown. Through statistical

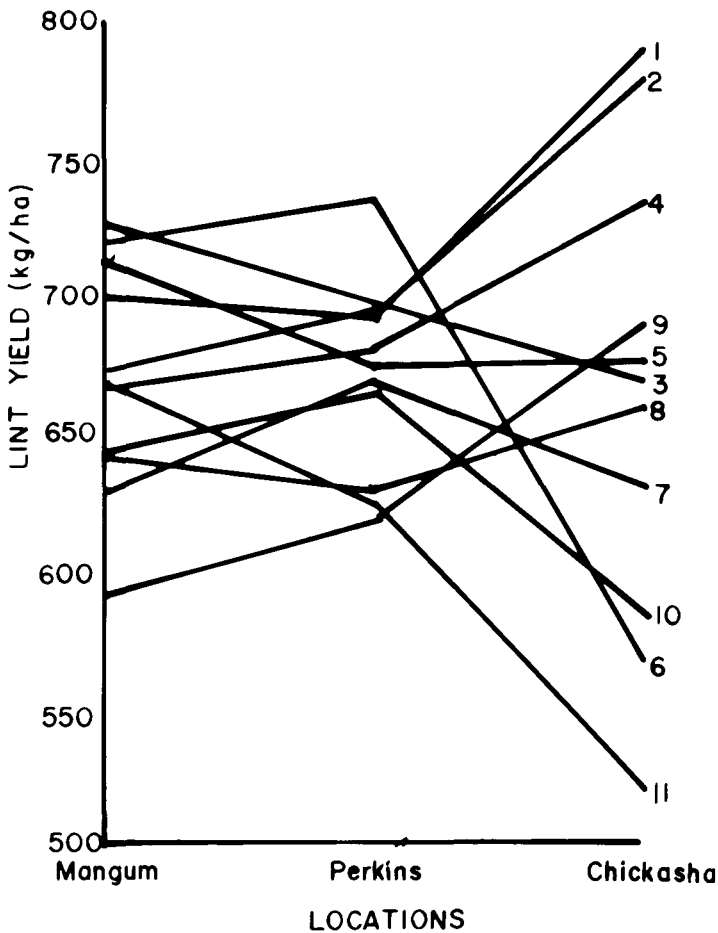

Figure 1. Genotype by environment interactions for lint yield of 11 cultivars at three locations in Oklahoma (from Verhalen and Murray, 1970).

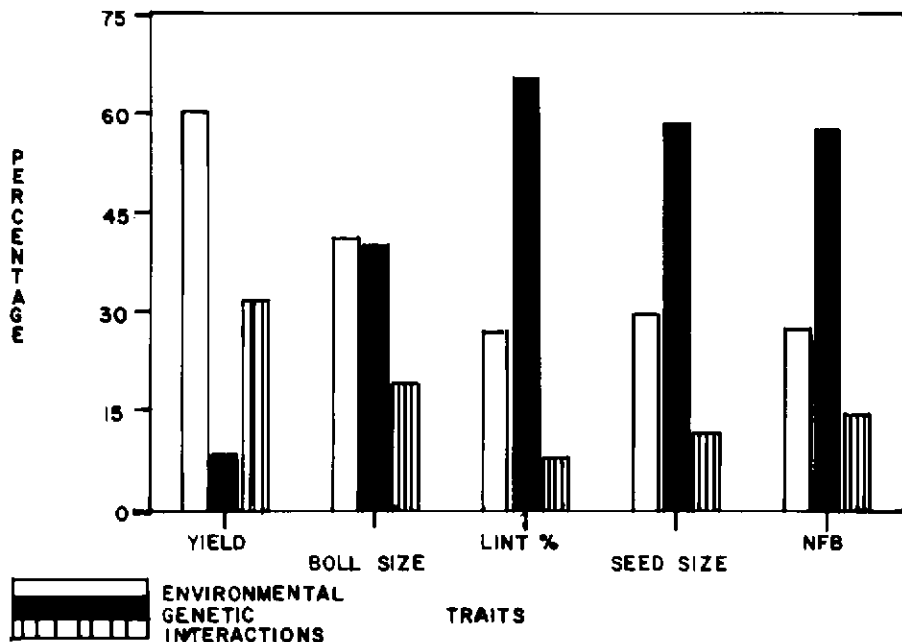

Figure 2. Partitioning of the phenotypic variance for five traits grown at three locations. Traits were lint yield, boll weight (size), lint percentage (%), seed weight (size) and node of first fruiting branch (NFB). Traits were measured in a two-year study at locations in Texas (from Quisenberry, unpublished).

partitioning, it is possible to calculate the percentage of the total variation contributed by the environment, genetics and the interaction of genetics with the environment (Figure 2). The data were taken from a two-year study of randomly selected cotton lines grown at three locations. Genetic variation was small for lint yield while much higher for the other four traits. This suggested that most of the variation observed in the population under study was caused by the environment and the interaction of the genetic and environmental components.

These data further suggested that yield improvement should come by making the best use of the environment. In fact, we know that the most productive research approaches to increase crop yields have been those directed to alleviate environmental barriers to crop production (reducing weed competition, optimizing available water and nutrients, improving soil conditions, etc.). This agronomic-oriented research has been the basis for most of the increases in crop yields in the past 100 years.

For the last 15 years, cotton yields have reached a plateau. I contend that this plateau has been a result of decreased environmental inputs related to their

increased cost. For optimum cotton production in the future, an attempt must be made to maximize yield with continuous reductions in environmental inputs. This presents tremendous opportunities and challenges to those scientists involved in cotton research. Plant physiologists will be needed to define factors limiting plant development and growth. Defining these limiting factors will not be enough, they must also cooperate with the plant breeder to find biochemical, morphological or physiological methods to circumvent these factors. They must do this in the face of declining environmental inputs (water, insecticides, herbicides, fertilizer, etc.). Cotton cultivars must be developed that can make maximum use of these limiting environmental inputs.

How can a useful physiological trait be identified and used in a plant or breeding program? A diagrammatic representation of one approach is shown in Figure 3. The initial step is the generation of new ideas or concepts through basic or fundamental research. Since the ultimate use of this basic research is to develop improved crop cultivars, the research may require unique germplasm on which to explore basic concepts or ideas. Early in the research effort, the basic researcher needs to interface closely with a plant breeder. The basic research can

### DEVELOPMENT OF A USEFUL PHYSIOLOGICAL TRAIT

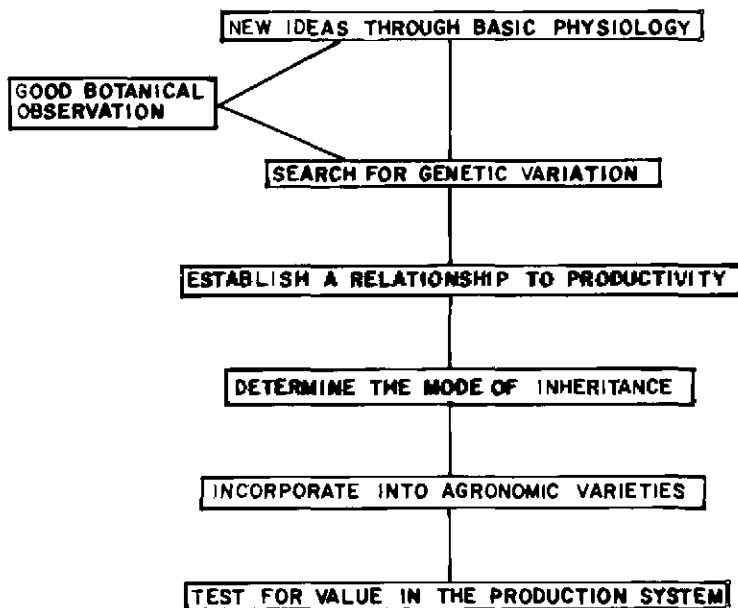

Figure 3. An approach toward using physiological traits and responses for genetic improvement.

be aided by the expert botanical observations made by plant breeders. Since plant breeding consists of qualified observations coupled with statistical quantification, observation is a key part of a successful plant breeding program. Most of a plant breeder's time is spent observing plant growth and development and trying to identify obviously superior plant-types. If the basic scientist can communicate to the plant breeder the type of mechanisms or strategies expected from a predicted physiological response, the probability is great that the plant breeder has observed such a response in some of his breeding material. Observation is a strong scientific tool.

As new concepts and ideas are generated, a search of available germplasm is needed to identify germplasm that encompasses the genetic concept or idea. As the research progresses to this point, it is no longer the primary responsibility of the plant physiologist but is passed on to the plant geneticist. The geneticist still needs the assistance of the plant physiologist in developing suitable methods to measure a large number of plants for the identified trait. These methods may require significant changes in techniques from those used in the original research. Often, the time consuming, exacting techniques used to develop basic concepts are modified through the development of new equipment or through the correlative identification of responses related to the original concept.

After a desirable trait is identified and a suitable technique to measure the trait developed, the geneticist will evaluate the available germplasm for genetic variability. The initial evaluations should be conducted on available cultivars. If useful variability can be found among these, the time required to incorporate the trait into new cultivars will be greatly reduced. If significant variability is not found among cultivars, then the search for variability will be expanded to include primitive germplasm, closely related species, and in some cases, closely related genera. The use of these more exotic sources of germplasm will increase the plant breeding problems.

When useable variability in a trait is found, the relationship between the trait and productivity and other quality traits should be determined. The determination of these relationships is some of the most difficult research to conduct. A correlative response among random lines from a population constructed by crossing genotypes with extreme expression of the trait is a useful approach. A positive correlation between the trait and productivity is suggestive but does not prove a cause-and-effect relationship. The comparison of isoline with and without the trait is better, but great difficulty exists in developing isolines, especially for quantitatively inherited traits.

As the plant breeder uses a physiological trait, he should have some information about how the trait is inherited. A comparison of the mode of inheritance between the new trait and other traits such as crop yield or quality will help to determine the plant breeding approaches that should be most productive.

The final two steps consist of: (1) incorporating the new response or trait into agronomic cultivars and (2) the evaluation of these cultivars in conventional

production systems. A cultivar that has the new physiological trait may not be adapted to conventional production systems and, therefore, may require additional research to develop a production system where the trait can best confer its inherent advantages.

## SUMMARY

The interface between physiology and genetics involves the desire of both disciplines to cooperate in mutually advantageous research. Difficulty exists in exchanging and understanding the technical terminology related to each discipline. All research should be oriented towards a "user" and the ultimate desire of the researcher to apply the research results. Application of research results requires that scientists communicate their findings in clear, precise terms that can be understood by scientists trained in other disciplines. The potential of applying basic physiological research to develop new cotton cultivars is an application worthy of the efforts.

## A

- Abdul-Baki, A. A.  
1980. Biochemical aspects of seed vigor. *HortSci* 15:765-771
- Abdul-Baki, A.A., and Anderson, J. D.  
1970. Viability and leaching of sugars from germinating barley. *Crop Sci.* 10 31-34.
- Abdul-Baki, A.A., and Anderson, J.D.  
1973. Vigor determination in soybean seed by multiple criteria. *Crop Sci.* 13 630-633.
- Abeles, F.B.  
1967. Mechanism of action of abscission accelerators. *Physiol. Plant* 20:442-454.
- Abeles, F.B.  
1969. Abscission. Role of cellulase. *Plant Physiol* 44:447-452.
- Abeles, F.B.  
1973. Ethylene in Plant Biology. Acad. Press, New York and London. pp. 302.
- Abeles, F.B.; Craker, L.E.; and Leather, G.R.  
1971a. Abscission: The phytoherontological effects of ethylene. *Plant Physiol.* 47:7-9
- Abeles, F.B.; Holm, R.E.; and Gahagan, H.E.  
1968. Abscission. Induction of degradative enzymes during aging. *In* Biochemistry and Physiology of Plant Growth Substances, F. Wightman and G. Setterfield, (eds.), pp. 1515-1523. The Runge Press Ltd., Ottawa, Canada
- Abeles, F.B., and Leather, G.R.  
1971. Abscission: Control of cellulase secretion by ethylene. *Planta* 97:87-91.
- Abeles, F.B.; Leather, G.R., Forrence, L.E.; and Craker, L.E.  
1971b. Abscission: Regulation of senescence, protein synthesis, and enzyme secretion by ethylene. *HortSci* 6:371-376
- Acevedo, E.; Hsiao, T.C., and Henderson, D.W.  
1971. Immediate and subsequent growth responses of maize leaves to changes in water status. *Plant Physiol.* 48:631-636.
- Ackerson, R.C.  
1980. Stomatal response of cotton to water stress and abscisic acid as affected by water stress history. *Plant Physiol.* 65:455-459.
- Ackerson, R.C.  
1981. Osmoregulation in cotton in response to water stress. II. Leaf carbohydrate status in relation to osmotic adjustment. *Plant Physiol* 67:489-493.
- Ackerson, R.C.  
1982. Synthesis and movement of abscisic acid in water-stressed cotton leaves. *Plant Physiol.* 69:609-613
- Ackerson, R.C., and Hebert, R.R.  
1981. Osmoregulation in cotton in response to water stress. I. Alteration in photosynthesis, leaf conductance, translocation, and ultrastructure. *Plant Physiol* 67:484-488.
- Ackerson, R.C., and Krieg, D.R.  
1977. Stomatal and non-stomatal regulation of water use in cotton, corn, and sorghum. *Plant Physiol.* 60:850-853.
- Ackerson, R.C., Krieg, D.R., Haring, C.L.; and Chang, N.  
1977. Effects of plant water status on stomatal activity, photosynthesis and nitrate reductase activity of field grown cotton. *Crop Sci* 17:81-84
- Ackerson, R.C., and Radin, J.W.  
1983. Abscisic acid accumulation in cotton leaves in response to dehydration at high pressure. *Plant Physiol.* 71:432-433.
- Adams, D.O., and Yang, S.F.  
1979. Ethylene biosynthesis. Identification of 1-amino-cyclopropane-1-carboxylic acid as an intermediate in the conversion of methionine to ethylene. *Proc. Natl. Acad. Sci.* 76 170-174.

- Adedipe, N.O., and Fletcher, R.A.  
1971. Retardation of leaf senescence by benzyladenine in bean plants is not dependent on mobilization. *Can. J. Bot.* 49:59-61.
- Addicott, F.T.  
1969. Aging, senescence, and abscission in plants. *Phyto gerontology. HortSci* 4:114-116.
- Addicott, F.T.  
1970. Plant hormones in the control of abscission. *Biol. Rev. Cambridge Phil. Soc.* 45:485-524.
- Addicott, F.T., Carns, H.R.; Lyon, J.L.; Smith, O.E.; and McMeans, J.L.  
1964. On the physiology of abscisins. *In* J.P. Nitsch, (ed.), *Regulateurs Naturels de la Croissance Vegetale*, pp. 687-703.
- Addicott, F.T., and Lynch, R.S.  
1955. Physiology of abscission. *Ann. Rev. Plant Physiol.* 6:211-238.
- Addicott, F.T.; Lynch, R.S.; and Carns, H.R.  
1955. Auxin gradient theory of abscission regulation. *Science* 121:644-645.
- Addicott, F.T., and Lyon, J.L.  
1969. Physiology of abscisic acid and related substances. *Ann. Rev. Plant Physiol.* 20:139-164.
- Addicott, F.T., and Lyon, J.L.  
1973. Physiological ecology of abscission. Chapter 3. *In* T.T. Kozlowski (ed.), *Shedding of Plant Parts*, pp. 85-124. Acad. Press, New York.
- Addicott, F.T., and Wiatr, S.M.  
1977. Hormonal controls of abscission: Biochemical and ultra-structural aspects. *In* *Plant Growth Regulation*, P.E. Pilet (eds.), pp. 249-257. Springer-Verlag, Berlin.
- Agrawal, P.K.  
1977. Germination, fat acidity and leaching of sugars from five cultivars of paddy (*Oryza sativa*) seeds during storage. *Seed Sci. and Technol.* 5:489-498.
- Ainsworth, S.K.; Neuman, R.E.; and McCormick, J.P.  
1979b. *Chemotaxis and histamine releasing properties of compounds in cotton mill dust*. Proc. Beltwide Cotton Prod. Res. Conf. pp. 21-29.
- Ainsworth, S.K.; Neuman, R.E.; and Harley, R.A.  
1979a. Histamine release from platelets for assay of byssinogenic substances in cotton mill dust and related materials. *Brit. J. Indust. Med.* 36:35-42.
- Aiyangar, G.S.  
1951. Origin and development of lint and fuzz in cotton. *Ind. J. Agr. Sci.* 21:293-312.
- Akazawa, T.  
1979. Ribulose 1,5-bisphosphate carboxylase, *In* *Photosynthesis II. Photosynthetic Carbon Metabolism and Related Processes*. pp. 208-299. (ed.) M. Gibbs and E. Latzko. *Encyclopedia of Plant Physiology*. Vol. 6. Springer-Verlag, NY.
- Akhtar, P., and Shaikat, S.S.  
1976. Role of dew in the survival and phenology of *Gossypium hirsutum* cv. *Qalandri*. *Pak. J. Bot.* 8:151-155.
- Akita, S., and Moss, D.N.  
1972. Differential stomatal response between C<sub>3</sub> and C<sub>4</sub> species to atmospheric CO<sub>2</sub> concentration and light. *Crop Sci.* 12:789-793.
- Akita, S., and Moss, D.N.  
1973. Photosynthetic response to CO<sub>2</sub> and light by maize and wheat leaves adjusted for constant stomatal apertures. *Crop Sci.* 13:234-237.
- Akita, S., and Tanaka, I.  
1973. Studies on the mechanism of differences in photosynthesis among species. IV. The differential response in dry matter production between C<sub>3</sub> and C<sub>4</sub> species to atmospheric carbon dioxide enrichment. *Proc. Crop Sci. Japan* 42:288-295.
- Albersheim, P.  
1975. The walls of growing plant cells. *Sc. American*, n<sup>o</sup> 4:81-95.



- Albersheim, P.; McNeil, M.; and Labavitch, J.M.  
1977. The molecular structure of the primary cell wall and elongation growth. In "Plant Growth Regulation" (ed.), Pilet pp. 1-12
- Albersson, D.M.  
1964. Materials handling—mechanical conveyors. In Handbook for Cotton Ginners, pp. 68-70. Agriculture Research Service, USDA. Agriculture Handbook No. 260.
- Ali, M., and Ullah, R.H.  
1963. Oil content in cotton at various stages of boll development. Pakistan Cottons 1963:1-14.
- Al-Kawas, G M  
1967. Growth and development of grain sorghum (*Sorghum vulgare*, Pers.) in an enclosed environment. MS Thesis, Dept. of Agronomy, University of Arizona, Tucson.
- Allaway, W G, and Mansfield, T A  
1967. Stomatal responses to changes in carbon dioxide concentrations in leaves treated with 3-(4-chlorophenyl)-1,1-dimethylurea. New Phytol. 66:57-63
- Allaway, W G, and Mansfield, T A.  
1970. Experiments and observations on the after effect of wilting on stomata of *Rumex sanguineus*. Can. J. Bot. 48:513-521.
- Allen, L H, Jr  
1979. Potentials for carbon dioxide enrichment. In B.J. Barfield and J.F. Gerber (eds.), Modification of the Aerial Environment of Crops. pp. 500-519. American Society of Agricultural Engineers, St. Joseph, Michigan.
- Allen, L.H., Jr., and Boote, K J  
1981. Response of Vegetation to Carbon Dioxide. Progress Report of Research: Effects of Increased Carbon Dioxide on Photosynthesis and Agricultural Productivity of Soybeans. No. 003. Agronomy Department, University of Florida, Gainesville, Florida. Joint Program of the U.S. Department of Energy and the U.S. Department of Agriculture. pp. 131.
- Allen, L H, Jr; Jensen, S E, and Lemon, E.R  
1971. Plant response to carbon dioxide enrichment under field conditions: A simulation. Science 173:256-258
- Altschul, A M  
1948. Biological processes of the cottonseed. In A.E. Bailey (ed.), Cottonseed and Cottonseed Products, Interscience Publishers, Inc., NY. pp. 157-212
- Altschul, A.M.  
1964. Seed Proteins. In H W. Schultz and H.F. Anglemier (eds.), Symposium of Food Proteins and Their Reaction. Avi Publishing Co., Inc., Westport, Conn.
- American Oil Chemists' Society.  
1976. Official and tentative methods. The Society: Chicago, Ill.
- Ames, R.B.  
1981. Status of HARVADE 5F as a cotton defoliant. Proc. Beltwide Cotton Prod. Res. Conf. pp. 71-72.
- Amin, J.V  
1969. Some aspects of respiration and respiration inhibitors in low temperature effects on the cotton plant. Physiol. Plant 22:1184-1191
- Amin, J.V., and Joham, H E  
1960. Growth of cotton as influenced by low substrate molybdenum. Soil Sci. 89:101-107.
- Ammirato, P V  
1974. The effects of abscisic acid on the development of somatic embryos from cells of caraway (*Carum carvi* L.) Bot. Gaz. 135:328-337
- Andersen, A.M., Hart, J.R.; and French, R C  
1964. Comparison of germination techniques and conductivity tests of cotton seeds. Proc. Int. Seed Test Assoc. 29:81-96.

- Anderson, A.S.  
1976. Regulation of apical dominance by ethephon, irradiance and CO<sub>2</sub>. *Physiol. Plant.* 37:303-308.
- Anderson, A.S., and Muir, R.M.  
1969. Gibberellin induced changes in diffusible auxins from savoy cabbage. *Physiol. Plant.* 22:354-363
- Anderson, D.B., and Kerr, T.  
1938. Growth and structure of cotton fiber. *Ind. Eng. Chem.* 30:48-54.
- Anderson, D.B., and Kerr, T.  
1943. A note on the growth behavior of cotton bolls. *Plant Physiol.* 18:261-269.
- Anderson, J.M.  
1981. Consequences of spatial separation of photosystem 1 and 2 in thylakoid membranes of higher plant chloroplasts. *FEBS Lett.* 124:1-9.
- Anderson, L.E.  
1979. Interaction between photochemistry and activity of enzymes. *In* M. Gibbs and E. Latzko (eds.), *Encyclopedia of Plant Physiology, New Series, Vol 6*, pp. 271-281. Springer-Verlag, Berlin.
- Anderson, M.C.  
1975. Solar radiation and carbon dioxide in the plant communities—conclusions. Chapter 15. *In* J.P. Cooper (ed.), *Photosynthesis and Productivity in Different Environments. International Biological Programme No. 3*, pp. 345-354. Cambridge Univ. Press, pp. 715.
- Anderson, O.C., and Worthington, R.E.  
1971. Boron and manganese effects on protein, oil content, and fatty acid composition of cottonseed. *Agron. J.* 63:566-569.
- Anderson, O.E., and Boswell, F.C.  
1968. Boron and manganese effects on cotton yield, lint quality, and earliness of harvest. *Agron. J.* 60:488-493.
- Anderson, W.K.  
1971a. Responses of five cotton varieties to two field soil temperature regimes at emergence. *Cotton Grow. Rev.* 48:42-50.
- Anderson, W.K.  
1971b. Methods of measuring and relationships between some growth characters of cotton. *Cotton Grow. Rev.* 48:51-59.
- Andreeva, T.F.; Avdeeva, T.A.; Vlasova, M.P.; Thyok, N.T.; and Nichiporovich, A.A.  
1971. Effect of nitrogen nutrition of plants on structure and function of the photosynthetic apparatus. *Fiziol. Rast.* 18:701-707
- Anonymous.  
1918. Relation of oil content to rainfall. *Cotton Oil Press.* 2:44-45.
- Anter, F.; Rasheed, M.A.; El-Salam, A. Abd; and Metwally, A.I.  
1976a. Effect of foliar application of certain micronutrients on fiber qualities of cotton. I. Application of copper, zinc, molybdenum and boron. *Ann. Agric. Sc. (Moshtohor)* 6:303-311.
- Anter, F.; Rasheed, M.A.; El-Salam, A. Abd; and Metwally, A.I.  
1976b. Effect of foliar application of certain micronutrients on fiber qualities of cotton. II. Iron and manganese. *Ann. Agric. Sc. (Moshtohor)* 6:312-319.
- Antony, A.K., and Kutty, K.E.  
1975. Effect of soil and climatic conditions on yield and fibre properties of improved strains of upland cotton. *Ind. J. Agr. Sci.* 45:199-203.
- Aoki, M., and Yabuki, K.  
1977. Studies on the carbon dioxide enrichment for plant growth. VII. Changes in dry matter production and photosynthetic rate of cucumber during carbon dioxide enrichment. *Agr. Meteorol.* 18:475-485.
- Apel, P.  
1976. Grain growth and carbohydrate content in spring wheat at different CO<sub>2</sub> concentrations. *Biochem. Physiol. Pflanzen.* 169:355-362.

- Archibald, R.G.  
1927. Sulfuric acid treatment of cottonseed. *Soil Sci.* 23:1-3.
- Arle, H.F.  
1976. Conditioning cotton for defoliation. *Proc. Beltwide Cotton Prod. Res. Conf.* pp. 49
- Arndt, C.H.  
1937. Water absorption in the cotton plant as affected by soil and water temperature. *Plant Physiol.* 12:703-720.
- Arndt, C.H.  
1945a. Viability and infection of light and heavy cotton seeds. *Phytopath.* 35:747-753
- Arndt, C.H.  
1945b. Temperature-growth relation of the roots and hypocotyls of cotton seedlings. *Plant Physiol.* 20:200-219.
- Arnison, P.G.  
1980. A redox model of the mechanism of action of Indole Acetic Acid (auxin) and other plant growth regulators. *Spec. in Sci. and Techn.* 3:5-15.
- Arnon, I.  
1972. Cotton. Chapter 7. *In Crop Production in Dry Regions. Vol. II. Systematic Treatment of the Principal Crops.* Leonard Hill, London. pp. 261-344.
- Arntzen, C.J.  
1978. Dynamic structural features of chloroplast lamellae. *In D.R. Sanadi and L.P. Vernon (eds.), Current Topics in Bioenergetics, Vol. 8,* pp. 111-160. Academic Press, NY.
- Arntzen, C.J., and Briantais, J.M.  
1975. Chloroplast structure and function. *In Govindjee (ed.), Bioenergetics of Photosynthesis,* pp. 51-113. Acad. Press, NY.
- Arteca, R.N., Pooviah, B.W., and Smith, O.E.  
1979. Changes in carbon fixation, tuberization, and growth induced by CO<sub>2</sub> application to the root zone of potato plants. *Science* 205:1279-1280.
- Ashley, D.A.  
1972. <sup>14</sup>C-labeled photosynthate translocation and utilization in cotton plants. *Crop Sci.* 12:69-74
- Ashley, D.A., Doss, B.D., and Bennett, O.L.  
1965. Relation of cotton leaf area index to plant growth and fruiting. *Agron. J.* 47:61-64
- Ashley, D.A., and Goodsen, R.D.  
1972. Effect of time and plant K status on <sup>14</sup>C-labeled photosynthate movement in cotton. *Crop Sci.* 12:686-690.
- Associated Seed Growers, Inc.  
1942. A study of mechanical injury to seed beans. Associated Seed Growers, Inc., New Haven, Conn. *Asgrow Monograph No. 1.*
- Association of Official Seed Analysts.  
1976. Progress report on the seed vigor testing handbook. *Assoc. Off. Seed Anal. NewsLetter* 50:1-78.
- Association of Official Seed Analysts  
1978. Rules for testing seed. *Jour. Seed Tech.* 3:1-126
- Association of Official Seed Analysts  
1981. Rules for testing seed. *Jour. Seed Tech.* 6:1-126.
- Association of Official Seed Analysts  
1983. Seed vigor testing handbook. *Contr. No. 32.* pp. 1-88.
- Atkin, J.C.  
1957. Bean seed injury and germination. *NY Agr. Exp. Sta. Farm Research.* April, 1957. pp. 10-11.
- Attiwill, P.M.  
1971. Atmospheric carbon dioxide and the biosphere. *Environ. Pollut.* 1:249-261.
- Aung, L.H.  
1974. Root-shoot relationships. *In E.W. Carson (ed.) The Plant Root and Its Environment.* pp. 29-63. University Press of Virginia

Ayers, R.S., and Westcot, D.W.

1977. Water quality for agriculture. Proc. Int. Conf. on Managing Saline Water for Irrigation Planning for the Future. pp 400-430.

Ayyangar, G.S.

1948. Some observations on stomata found on cotton ovules. Ind. Cotton Rev. (Bombay) 2:187-192.

Azcon-Bieto, J.; Farguhar, G.D.; and Caballero, A.

1981. Effects of temperature, oxygen concentration, leaf age and seasonal variations on the CO<sub>2</sub> compensation point of *Lotium perenne* L.: Comparison with a mathematical model including non-photorespiratory CO<sub>2</sub> production in the light. Planta. 152:497-504.

## B

Babaev, D., and Agakishiev, D

1977. Natural regulators of fine-fibered cotton seeds. Izv. Akad. Nauk.; Turkm. SSR Ser. Biol. Nauk. 71-74.

Backhaus, R.; Jones, D.A., and Kimball, B A.

1979. The influence of CO<sub>2</sub> fertilization on seedling growth in guayule HortSci. 14:463-464.

Baert, T.; De Langhe, E.; and Waterkeyn, L.

1975. *In vitro* culture of cotton ovules. III. Influence of hormones upon fiber development. La Cellule, 71:55-63.

Baes, C.F., Jr.; Goeller, H.E.; Olson, J.S.; and Rotty, R.M.

1976. The Global Carbon Dioxide Problem. ORNL-5194. Oak Ridge National Laboratory, Knoxville, TN. pp 78.

Bahr, J.T., and Jensen, R.G.

1978. Activation of ribulose biphosphate carboxylase in intact chloroplasts by CO<sub>2</sub> and light. Arch. Biochem. Biophys. 185:39-48.

Bailey, A.V.; Harris, J.A.; and Skau, E L.

1966. Cyclopropanoid fatty acid content and fatty acid composition of crude oils from twenty-five varieties of cottonseed. J. Amer. Oil Chem. Soc. 43:107-110.

Bailey, C.J., and Boulter, D.

1970. The structure of legumin, a storage protein of broad bean (*Vicia faba*) seed. Eur. J. Biochem. 17:460-466

Bailey, W A.; Klueter, H.H.; Krizek, D.T.; and Stuart, N.W.

1970. CO<sub>2</sub> systems for growing plants. Transactions Amer. Soc. Ag. Eng. 13:263-268.

Baker, D.N.

1965. Effects of certain environmental factors on net assimilation in cotton. Crop Sci. 5:53-56.

Baker, D.N

1966. "Microclimate in the Field." Trans. ASAE 9:77-84.

Baker, D.N.; Allen, L.H. Jr.; and Lambert, J.R.

1981. Effects of increased CO<sub>2</sub> on photosynthesis and agricultural productivity. In Carbon Dioxide Effects Research and Assessment Program 013. Vol. 2. U.S. Dept. of Energy, Office of Environment.

Baker, D.N.; Bruce, R.R.; and McKinion, J.M.

1973. An analysis of the relation between photosynthetic efficiency and yield of cotton. Proc. 1973 Beltwide Cotton Res. Conf. pp. 110-114.

Baker, D.N., and Enoch, H.Z.

1982. Plant growth and development. In Proceedings of an International Conference on Rising Atmospheric Carbon Dioxide and Plant Productivity. Athens, Georgia, May 23-28, 1982. American Association for the Advancement of Science.

Baker, D.N., and Hesketh, J.D.

1969. Respiration and the carbon balance in cotton. Proc. Cotton Phys. Conf. pp. 60-64.

- Baker, D.N.; Hesketh, J.D.; and Duncan, W.G.  
1972. "The Simulation of Growth and Yield in Cotton" I. Gross Photosynthesis, respiration and growth. *Crop Sci.* 12 431-435.
- Baker, D.N.; Hesketh, J.D.; and Weaver, R.E.C.  
1978. Crop architecture in relation to yield. *In Crop Physiology—U.S. Gupta (ed.)*, Oxford and IBH Publishing Co., New Delhi.
- Baker, D.H.; Lambert, J.R., and McKinion, J.M.  
1983 Gossym: A simulator of cotton growth and yield. *South Carolina Agr. Exp. Sta. Bull.* 1089. pp. 134.
- Baker, D.N.; Lambert, J.R.; Phene, C.J.; and McKinion, J.M.  
1976 "GOSSYM. A Simulator of Cotton Crop Dynamics." *In Computers Applied to the Management of Large-Scale Agricultural Enterprises*. Proc. U.S.—U.S.S.R. Seminar. Moscow, Riga, Kishiniev, pp. 100-133.
- Baker, D.N.; Landivar, J.A., and Lambert, J.R.  
1979a "Model Simulation of Fruiting." *Proc. Cotton Prod. Res. Conf.* Phoenix, Az. pp 261-263.
- Baker, D.N., Landivar, J.A.; Whisler, F.D., and Reddy, V.R.  
1979b. "Plant Responses to Environmental Conditions and Modeling Plant Development." *Weather and Agr. Symp.*, Kansas City, MO., pp. 69-135 Oct. 1-2.
- Baker, D.N., and McKinion, J.  
1971. Annual report Boll Weevil Research Laboratory Soil and Water Conservation Research Division, Starkville, Mississippi.
- Baker, D.N., and Meyer, R.E.  
1966. Influence of stand geometry on light interception and net photosynthesis in cotton. *Crop Sci.* 6:15-19.
- Baker, D.N., and Myhre, D.L.  
1968. Leaf shape and photosynthetic potential in cotton. *Proc. 19th Cotton Phys. Conf.* pp. 57-70.
- Baker, D.N., and Myhre, D.L.  
1969. Effects of leaf shape and boundary layer thickness on photosynthesis in cotton (*Gossypium hirsutum*). *Physiol. Plant* 22:1043-1049
- Baker, T.S., Eisenberg, D., and Eisenberg, F.  
1977. Ribulose biphosphate carboxylase: A two-layered square-shaped molecule of symmetry 422. *Science* 196:293-295.
- Ballard, W.W.  
1925. Behavior of cotton planted at different dates in weevil control experiments in Texas and South Carolina USDA Bul. No. 1320.
- Balls, W.L.  
1915 *The Development and Properties of Raw Cotton*. A.C. Black. Ltd. London
- Balls, W.L.  
1919a. *The Cotton Plant in Egypt*. MacMillan and Co., London. pp. 202.
- Balls, W.L.  
1919b. The existence of daily growth rings in the cell wall of cotton hairs. *Proc. Roy. Soc. London B* 95:72-89.
- Baluch, Z.A.M.  
1979 *In vitro* anther culture of *Gossypium* species. *Pakist. Cottons* 23:161-163
- Bamann, E., and Ullmann, E.  
1940. Untersuchungen über die Lipase höherer Pflanzen *Biochem. Z.* 312:9-40.
- Baranov, P.A., and Maltzev, A.M.  
1937. The structure and development of the cotton plant. Laboratory of cytology and anatomy of the central plant Breeding Station Moscow-Leningrad
- Barber, J.  
1977. *Primary Processes of Photosynthesis* Elsevier Publishing Co., Amsterdam.

- Barlow, P.  
1970. Vacuoles in the nucleoli of *Zea Mays* root apices and their possible significance in nucleolar physiology. *Caryologia* 23, 61.
- Barritt, N.W.  
1929. The structure of the seed coat in *Gossypium* and its relation to the growth and nutrition of lint hairs. *Ann. Bot.* 42:483-489.
- Barrow, J.R., and Davis, D.D.  
1974. G1<sub>2</sub>—A new allele for pigment glands in cotton. *Crop Sci.* 14:325-327.
- Barrow-Agee Laboratories, Inc.  
1918. Rainfall and oil content. *Cotton Oil Press* 2:44-45.
- Barrow, J.R.  
1977. The cytology of callus tissue produced from cotton anthers. *Agron. Abstr.* pp. 49.
- Barrow, J.R.  
1984. The conditions required to isolate and maintain viable cotton microspores. *Gossypium hirsutum* L.
- Barrow, J.R.; Katterman, F.R.; and William, D.  
1978. Haploid and diploid callus from cotton anthers. *Crop Sci.* 18 619-622.
- Bartee, S.N., and Krieg, D.R.  
1974. Cottonseed density: Associated physical and chemical properties. *Agron. J.* 66:433-435.
- Bartkowski, E.J.; Katterman, F.R.H.; and Buxton, D.R.  
1978. Influence of exogenous fatty acids on cottonseed germination. *Physiol. Plant* 44:153-56.
- Baskin, C.C.  
1976a. Seed cotton storage and planting seed quality. *Cotton Gin and Oil Mill Press* 77.17, 24.
- Baskin, C.C.  
1976b. Seed cotton storage and planting seed quality. In *Summary Proceedings Seed Cotton Handling Seminar*, Cotton Incorporated, Raleigh, N.C. pp. 911
- Baskin, C.C.  
1976c. The effects of modular storage of seed cotton on planting seed quality. Terminal Report to Cotton Incorporated. pp. 20.
- Baskin, C.C.  
1979. Germination test is not enough. *Proc. Beltwide Cotton Prod. Mech. Conf.* pp. 53-54.
- Baskin, C.C.  
1981a. Storage of seed cotton and bulk cottonseed for planting purposes. *Proc. Beltwide Cotton Prod. Res. Conf.* pp. 306-311
- Baskin, C.C.  
1981b. Tetrazolium test for evaluation of cottonseed. *Proc. Beltwide Cotton Prod. Res. Conf.* 1981: pp. 312.
- Baskin, C.C.  
1981c. Tetrazolium test. In *Association of Official Seed Analyst Vigor Testing Handbook*, contribution No. 32 to the handbook on seed testing.
- Baskin, C.C.; Bryson, C.P.; and Rushing, K.W.  
1972. Harvest high quality cottonseed. *Miss. Coop. Ext. Ser. Inf. Sheet* 527 (2M-7-72).
- Bassett, D.M.; Anderson, W.D.; and Werkhoven, C.H.E.  
1970. Dry matter production and nutrient uptake in irrigated cotton (*Gossypium hirsutum* L.). *Agron. J.* 62:299-303.
- Bassham, J.A.  
1977. Increasing crop production through more controlled photosynthesis. *Science* 197:630-638.
- Bassham, J.A.  
1979. The reductive pentose phosphate cycle and its regulation, pp. 9-30. In *Photosynthesis II. Photosynthetic Carbon Metabolism and Related Processes*. M. Gibbs and E. Latzko. (eds.), *Encyclopedia of Plant Physiology*. Vol. 6. Springer-Verlag, N.Y.

- Bassham, J.A., and Calvin, M.  
1957 The Path of Carbon in Photosynthesis Prentice-Hall, Inc., N.J.
- Bates, G.H.  
1937. Advice for the observation of root growth in the soil. *Nature (Lon.)* 139:966-967
- Baur, A.H., Yang, S.F.; Pratt, H.K.; and Biale, J.B.  
1971. Ethylene biosynthesis in fruit tissues. *Plant Physiol.* 47:696-699.
- Bazanova, T.B.  
1966. Effect of gibberellins on the growth and yield of cotton growth under different nutrient regimes. *Izv Akad Nauk. Turkmen. SSR Ser. Biol. No.* 1:79-82.
- Bazanova, T.B.  
1977. Effect of cycloaliphatic compounds upon the growth and auxin-inhibiting activity of fine-fibre cotton with regard to the type of nitrogen nutrition. *Proc. Acad. Sci. Turk SSR Ser Biol. Sci.* 1:11-17
- Beal, J.M.  
1928. A study of heterotypic prophase in the microsporogenesis of cotton. *Cellule* 38:245-268.
- Beardsell, M.F., and Cohen, D.  
1975. Relationships between leaf water status, abscisic acid levels and stomatal resistance in maize and sorghum. *Plant Physiol.* 56:207-212.
- Beasley, C.A.  
1971. *In vitro* culture of fertilized cotton ovules. *Bioscience*, 21:906-907.
- Beasley, C.A.  
1973. Hormonal regulation of growth in unfertilized cotton ovules. *Science* 197:1003-1005.
- Beasley, C.A.  
1974. Glasshouse production of cotton flowers, harvest procedures, methods of ovule transfer, and *in vitro* development of immature seed. *Cotton Grow. Rev.* 51:293-301.
- Beasley, C.A.  
1977a. Temperature dependent response to indolacetic acid is altered by  $\text{NH}_4^+$  in cultured ovules. *Plant Physiol.* 59:203-206
- Beasley, C.A.  
1977b. Ovule culture. Fundamental and pragmatic research for the cotton industry. *Plant Cell, Tissue and Organ Culture.* Springer-Verlag pp. 160-178
- Beasley, C.A.  
1979. Cellulose content in fibers of cottons which differ in their lengths and extent of fuzz. *Physiol. Plant* 45:77-82.
- Beasley, C.A., and Ting, I.P.  
1971. Development of procedures for *in vitro* culture of cotton ovules. *Beltwide Cotton Prod. Res. Conf.* pp. 48.
- Beasley, C.A., and Ting, I.P.  
1973. The effects of plant growth substances on *in vitro* fiber development from fertilized cotton ovules. *Amer. J. Bot.* 60:130-139
- Beasley, C.A., and Ting, I.P.  
1974. Effects of plant growth substances on *in vitro* fiber development from unfertilized cotton ovules. *Amer. J. Bot.* 61:188-194.
- Beasley, C.A., Ting, I.P., and Feign, L.A.  
1971. Test tube cotton. *California Agriculture* 25:6-8.
- Beasley, C.A., Ting, I.P.; Linkins, A.E.; Birnbaum, E.H.; and Delmer, D.P.  
1974. Cotton ovule culture: A review of progress and a preview of potentiality. In: *Tissue Culture and Plant Science.* H.E. Street (ed.) Acad. Press, London-New York, pp. 169-192.
- Beasley, C.A., and Egh, E.  
1977. Fiber production *in vitro* from a conditional fiberless mutant of cotton. *Devel. Biol.* 57:234-237.

- Beasley, C.A.; Egli, M.A.; Chane, S.R.; and Radin, J.W.  
1979. Independent control of fiber development and nitrate reduction of cultured cotton ovules. *Plant Physiol.* 63:57-60.
- Beasley, J.O.  
1940. Hybridization of American 26-chromosome and Asiatic 13-chromosome species of *Gossypium*. *J. Agr. Res.* 60:175-182.
- Beckett, R.E.  
1927. Growth of fruiting parts in *Gossypium cernuum*, an Asiatic cotton. *J. Agr. Res.* 35:97-106.
- Beckett, R.E., and Hubbard, J.W.  
1932. The shedding of 4-lock and 5-lock bolls in upland cotton. *USDA Tech. Bull.* 277.
- Beevers, H.  
1979. Microbodies in higher plants. *Ann. Rev. Plant Physiol.* 30:159-193.
- Begg, J.E., and Turner, N.C.  
1976. Crop water deficits. *Adv. Agron.* 28:161-217.
- Beier, R.C., and Greenblatt, G.A.  
1981. A novel solvent strategy for Sep-Pak C<sub>18</sub> elution of hydrophobic compounds: Applications to lacimlenes and cadalenes from cotton bract. *J. Liq. Chromo.* 4:515-524.
- Beighley, D.H., and Hopper, N.W.  
1981. The relationship of chemical composition and electrical conductivity of cowpea seed to field performance. *Agron. Abstr.* 1981:117.
- Bell, A.A.  
1967. Formation of gossypol in infected or chemically irritated tissues of *Gossypium* species. *Phytopath.* 57:759-764.
- Bell, A.A.  
1969. Phytoalexin production and *Verticillium* wilt resistance in cotton. *Phytopath.* 59:1119-1127.
- Bell, A.A.  
1973. Nature of disease resistance. In *Verticillium Wilt of Cotton*, pp. 47-62. *USDA Publ. ARS-S-19*.
- Bell, A.A.  
1981. Biochemical mechanisms of disease resistance. *Ann. Rev. Plant Physiol.* 32:21-81.
- Bell, A.A., and Christiansen, M.N.  
1968. Gossypol synthesis in chilled cotton tissues. *Phytopath.* 58:883.
- Bell, A.A., and Stipanovic, R.D.  
1977. The chemical composition, biological activity, and genetics of pigment glands in cotton. *Proc. Beltwide Cotton Prod. Res. Conf.* pp. 244-258.
- Bell, A.A., and Stipanovic, R.D.  
1978. Biochemistry of disease and pest resistance in cotton. *Mycopathologia* 65:91-106.
- Bell, A.A.; Stipanovic, R.D.; Howell, C.R.; and Fryxell, P.A.  
1975. Antimicrobial terpenoids of *Gossypium*. Hemigossypol, 6-methoxyhemigossypol, and 6-deoxyhemigossypol. *Phytochem.* 14:225-231.
- Bell, A.A.; Stipanovic, R.D.; O'Brien, D.H.; and Fryxell, P.A.  
1978. Sesquiterpenoid aldehyde quinones and derivatives in pigment glands of *Gossypium*. *Phytochem* 17:1297-1305.
- Benedict, C.R.  
1984. Physiology. In R.J. Kohel and C.F. Lewis. *Cotton Amer. Soc. Agronomy Madison, WI.* pp. 151-200.
- Benedict, C.R.; McCree, K.J., and Kohel, R.J.  
1972. High photosynthetic rate of a chlorophyll mutant of cotton. *Plant Physiol.* 49:968-971.
- Benedict, C.R., and Kohel, R.J.  
1975. Export of <sup>14</sup>C-assimilates in cotton leaves. *Crop Sci.* 15:367-372.
- Benedict, C.R.; Kohel, R.J.; and Schubert, A.M.  
1976. Transport of <sup>14</sup>C-assimilates to cottonseed: Integrity of funiculus during seed filling stage. *Crop Sci.* 16:23-27.



- Benedict, C.R.; Schubert, A.M.; and Kohel, R.J.  
1980. Carbon metabolism in developing cottonseed. Sink demand and the distribution of assimilates. pp. 346-351. *In* Proc. Beltwide Cotton Prod. Res. Conf. St. Louis, MO.
- Benedict, C.R.; Smith, R.H.; and Kohel, R.J.  
1973. Incorporation of  $^{14}\text{C}$ -photosynthate into developing cotton bolls *Gossypium hirsutum* L. *Crop. Sci.* 13:88-91.
- Benedict, J.H., and Bird, L.S.  
1981. Relationship of microorganisms within the plant and resistance to insects and diseases. Proc. Beltwide Cotton Prod. Res. Conf. pp. 149-150
- Bennett, J.H.  
1969. Effects of ozone on leaf metabolism. Ph.D. Dissertation, University of Utah, pp. 96.
- Bennett, O.L.; Ashley, D.A.; and Doss, B.P.  
1964. Methods of reducing soil crusting to increase cotton seedling emergence. *Agron. J.* 56:162-165.
- Bennett, O.L.; Erie, L.J.; and MacKenzie, A.J.  
1967. Boll, fiber and spinning properties of cotton as affected by management practices. USDA Tech. Bull. 1372.
- Bennett, O.L.; Rouse, R.D.; Ashley, D.A.; and Doss, B.D.  
1965. Yield, fiber quality and potassium content of irrigated cotton plants as affected by rates of potassium. *Agron. J.* 57:296-299.
- Berardi, L.C.; Martinez, W.H.; and Fernandez, C.F.  
1969. Cottonseed protein isolates: Two step extraction procedure. *Food Technol.* 23:75-82.
- Berkey, D.A.  
1974. Factors conditioning seed dormancy in cotton (*Gossypium hirsutum* L.) Ph.D. Dissertation. Mississippi State University, Miss. State, MS. pp. 53.
- Berkley, E.E.  
1931. Studies of the effect of different lengths of day, with variations in temperature on vegetative growth and reproduction in cotton. *Ann. Mo. Bot. Gard.* 18:573-601.
- Berkley, E.E.  
1949. Certain variations in the structure and properties of natural cellulose fibers. *Text. Res. Journ.* 19:363-367.
- Berkley, E.E., and Kerr, T.  
1974. Structure and plasticity of Undried Cotton Fibers. *Ind. Eng. Chem.* 38 304-309.
- Berlin, J.D.  
1970. The fine structure of cell wall formation in cotton fibers. 2nd Quarter Report, Cotton Producers Institute.
- Berlin, J.D.  
1977. The fine structure of the non-fiber epidermal cell during cottonseed development. Proc. Beltwide Cotton Prod. Res. Conf. pp. 69.
- Berlin, J.D., Quisenberry, J.E.; McMichael, B.L.; Woodworth, M.; and Phillips, W.O.  
1981a. Morphometric analysis of water stressed cotton leaves. Proc. Beltwide Cotton Prod. Res. Conf. 35.45.
- Berlin, J.D., and Ramsey, J.C.  
1970. Electron microscopy of the developing cotton fiber. *In* C.J. Arceneaux (ed.), Proceedings of the 28th Annual Meeting of the Electron Microscope Society of America. Claitor's Publishing Division. Baton Rouge, La.
- Berlin, J., and Smutzer, G.  
1976. An autoradiographic study of the outer epidermis of the cotton ovule. Proc. Beltwide Cotton Prod. Res. Conf. pp. 45.
- Berlin, J.D.; Worley, S.; Ramey, H.H., and Linkous, S.S.  
1981b. Measuring the cross-sectional area of cotton fibers with an image analyzer. *Text. Res. J.* 51:109-113.

- Bernstein, L.  
1955. Salt tolerance of field crops-cotton. U.S. Salinity Lab Rept. to Collaborators, Riverside, CA. pp. 37-41.
- Bernstein, L., and Hayward, H.E.  
1958. Physiology of salt tolerance. *Ann. Rev. Plant Physiol.* 9:25-46.
- Berriman, L.P., and Benedict, H.M.  
1963. Growth rings in cotton. *Text. Res. Journ.* 33:1926-1927.
- Berry, J.A.; Osmond, C.B.; and Lorimer, G.H.  
1978. Fixation of  $^{18}\text{O}_2$  during photorespiration. *Plant Physiol.* 62:954-967.
- Beutelmann, P., and Kende, H.  
1976. The effect of senescence and ethylene on membrane-lipid levels in excised flower tissue of *Ipomoea tricolor*. *Plant Physiol.* 57S:97.
- Beyer, E.M., Jr., and Morgan, P.W.  
1969. Ethylene modification of an auxin pulse in cotton stem sections. *Plant Physiol.* 44:1690-1694.
- Beyer, E.M., Jr., and Morgan, P.W.  
1970. Effect of ethylene on the uptake, distribution, and metabolism of indoleacetic acid-1- $^{14}\text{C}$ -and-2- $^{14}\text{C}$  and naphthaleneacetic acid-1- $^{14}\text{C}$ . *Plant Physiol.* 46:157-162.
- Beyer, E.M., Jr., and Morgan, P.W.  
1971. Abscission: The role of ethylene modification of auxin transport. *Plant Physiol.* 48:208-212.
- Bevan, M., and Northcote, D.H.  
1981. Some rapid effects of synthetic auxins on mRNA levels in cultured plant cells. *Planta* 152:32-35
- Bhardwaj, S.N., and Dua, I.S.  
1972. Physiology of boll shedding in cotton. VI. Evaluation of hormonal basis of varietal variation of boll shedding in American cotton (*Gossypium hirsutum* L.). *Indian J. Agric. Sci.* 42:300-307.
- Bhardwaj, S.N.; Dua, I.S.; and Nath, V.  
1975. Boll-shedding in cotton—VII. Role of growth regulating substances. *Indian J. Plant Physiol.* 18:127-130.
- Bhardwaj, S.N., and Sharma, P.N.  
1971. Influence of IAA and  $\text{GA}_3$  on fibre properties and growth of cotton bolls. *Ind. J. Agric. Sci.* 41:524-527.
- Bhardwaj, S.N.; Sonthanam, V.; and Krishnamourthy, R.  
1963. Influence of pretreating the seeds with NAA on yield and growth of cotton. *The Indian Cotton Grow Rev.* 17:5-11.
- Bhatt, J.G.; Raman, C.V.; Sankaranarayanan, T.G.; and Iyer, S.K.  
1972. Changes in lint characters of cotton varieties by growth regulators. *Cotton Grow Rev.* 49:160-165.
- Bhatt, J.G., and Ramanujam, T.  
1971. Some responses of a short-branch cotton variety to gibberellin. *Cotton Grow Rev.* 48:136-139.
- Bhojwani, S.S.; Power, J.B.; and Cocking, E.C.  
1977. Isolation, culture and division of cotton callus protoplasts. *Plant Sci. Lett.* 8:85-89.
- Bianchini, J.P.; Rafalimanarivo, A.; and Gaydou, E.M.  
1981. Determination of cyclopropanoic and cyclopropanoic fatty acids in cottonseed and kapok seed oils by gas-liquid chromatography. *Anal. Chem.* 53:2194-2201.
- Bidwell, R.G.S., and Turner, W.B.  
1966. Effect of growth regulators on  $\text{CO}_2$  assimilation in leaves, and its correlation with the bud break response in photosynthesis. *Plant Physiol.* 41:267-270.
- Bielorai, H., and Hopmans, P.A.M.  
1975. Recovery of leaf water potential, transpiration and photosynthesis of cotton during irrigation cycles. *Agron. J.* 67:629-632.

- Bierhuizen, J.F., and Slatyer, R.O.  
1964. Photosynthesis of cotton leaves under a range of environmental conditions in relation to internal and external diffusive resistances. *Aust. J. Biol. Sci.* 17:348-359.
- Bierhuizen, J.F., and Slatyer, R.O.  
1965. Effect of atmospheric concentration of water vapour and CO<sub>2</sub> in determining transpiration and photosynthesis relationships in cotton leaves. *Agr. Meteor.* 2:259-270.
- Bilbro, J.D.  
1962. Fruiting pattern, fiber properties and yields of three cotton varieties grown under three soil-moisture regimes on the High Plains of Texas, 1958. *Tex. Agr. Exp. Sta. MP-611:1-8.*
- Bilbro, J.D.  
1974. Effect of pre-plant only irrigation on cotton yields. *Agron. J.* 66:833-834
- Bilbro, J.D.  
1975. Relationship of air temperatures to first-bloom dates of cotton. *Tex. Agr. Exp. Sta. Misc. Publ. MP-1186.*
- Bilbro, J.D., and Ray, L.L.  
1961. Performance of four cotton varieties in relation to planting date on the High Plains of Texas, 1960. *Tex. Agr. Exp. Sta., Progress Report 2197*
- Bilbro, J.D., and Ray, L.L.  
1973. Effect of planting date on yield and fiber properties of three cotton cultivars. *Agron. J.* 65:606-609.
- Bilbro, J.D., and Wajura, D.F.  
1982. Reduced cotton productivity from delayed emergence. *Trans. ASAE* 25:1484-1487.
- Bingham, G.E.; Gillespie, C.H.; and McQuaid, J.H.  
1978. Development of a miniature, rapid-response carbon dioxide sensor. Lawrence Livermore Laboratories. UCRL-52440. pp. 19.
- Bird, L.S.  
1973. Effect of resistance and escape from pathogens of cotton on yield. *Proc. Beltwide Cotton Prod. Res. Conf., Cot. Dis. Council* 33:102-107.
- Bird, L.S.  
1978. Determining biological performance for cotton planting-seed. *Proc. Beltwide Cotton Prod. Res. Conf. Proc. Cot. Dis. Council* 38:217-219.
- Bird, L.S., and Ergle, D.R.  
1961. Seedling growth differences of several cotton varieties and the influence of gibberellin. *Agr. J.* 53:171-172
- Bird, L.S.; Liverman, C.; Percy, R.G.; and Bush, D.L.  
1979. The mechanism of multi-adversity resistance in cotton: Theory and results. *Proc. Beltwide Cotton Prod. Res. Conf.* 1979:226-228.
- Bird, I. S., and Reyes, A.A.  
1967. Effects of cottonseed quality on seed and seedling characteristics. *Proc. Beltwide Cotton Prod. Res. Conf.* 1967:199-206.
- Birnbaum, E.H.; Beasley, C.A.; and Dugger, W.M.  
1974. Boron deficiency in unfertilized cotton (*Gossypium hirsutum*) ovules grown *in vitro*. *Plant Physiol.* 54:931-935.
- Birnbaum, E.H.; Dugger, W.M.; and Beasley, C.A.  
1977. Interaction of boron with components of nucleic acid metabolism in cotton ovules cultured *in vitro*. *Plant Physiol.* 59:1034-1038.
- Bishnoi, U.R.  
1971. Deterioration of cotton seed under warm, moist conditions and its consequence in terms of seed and plant responses. Ph.D. Dissertation. Mississippi State University, Miss. State, MS. pp. 79.
- Bishnoi, U.R., and Delouche, J.C.  
1980. Relationship of vigor tests and seed lots to cotton seedling establishment. *Seed Sci. and Tech.* 8:341-346.

- Bishop, J.O.; Morton, J.G.; Roshbash, M. and Richardson, M.  
1971. Three abundance classes in HeLa cell messenger RNA. *Nature* 250:199-204.
- Bishop, P.M., and Whittingham, C.P.  
1968. The photosynthesis of tomato plants in a carbon dioxide enriched atmosphere. *Photosynthetic* 2:31-38.
- Bjorkman, O.; Gauth, E.; Hiesey, W.M.; Nicholson, F.; and Nobs, M.A.  
1968. Growth of *Minulus*, *Marchantia* and *Zea* under different oxygen and carbon dioxide levels. *Carnegie Inst. Wash. Yearbook* 67:477-478.
- Bjorkman, O., and Pearcy, R.W.  
1982. Physiological responses to increasing atmospheric carbon dioxide. *In Proc. of an Int'l Conf. on Rising Atmospheric Carbon Dioxide and Plant Productivity*. Athens, Georgia, May 23-28, 1982. Amer. Assoc. for the Advancement of Science, Washington, D.C.
- Black, M.  
1980/81. The role of endogenous hormones in germination and dormancy. *Isr. J. Bot.* 29:181-192.
- Blizzard, W.E., and Boyer, J.S.  
1980. Comparative resistance of the soil and the plant to water transport. *Plant Physiol.* 66:809-814.
- Bloodworth, M.E.  
1960. Effect of soil temperature on water use by plants. *Trans. Seventh Int'l. Cong. Soil Science.* 1:153-163.
- Blouin, F.A., and Cherry, J.P.  
1980. Identification of color-causing pigments in biscuits containing cottonseed flour. *J. Food Sci.* 45:953-957.
- Blouin, F.A.; Zarins, Z.M.; and Cherry, J.P.  
1981a. Color. *In J.P. Cherry (ed.), Protein Functionality in Foods*, pp. 21-39. American Chemical Society.
- Blouin, F.A.; Zarins, A.M.; and Cherry, J.P.  
1981b. Role of flavonoids in the production of color in biscuits prepared with wheat and cottonseed flours. *J. Food Sci.* 46:266-271.
- Bockholt, A.J.; Rodgers, J.S.; and Richmond, T.R.  
1969. Effects of various storage conditions on longevity of cotton, corn and sorghum seeds. *Crop Sci.* 9:151-153.
- Bodie, J.M.; Limperis, T.; and Steve, W.C.  
1978. New test for determining cotton seed germination. *Proc. Beltwide Cotton Prod. Mech. Conf.* 1978:76.
- Bohm, W.  
1974. Mini-Rhizotrons for root observations under field conditions. *Z. Ackerpflanzenbau.* 140:282-287.
- Bohm, W.  
1979. *Methods of Studying Root Systems*. Springer-Verlag.
- Bohorquez, J.O.  
1977. Temperature relations of cotton seed germination. M.S. Thesis. Mississippi State University, Miss. State, MS. pp. 41.
- Bollenbacher, K.; Fulton, N.D.; and McCutchen, B.E.  
1963. Behaviour of artificially deteriorated cottonseed after various storage periods. *Agron. J.* 55:521-523.
- Bollini, R.; Alessandro, V.; and Chrispeels, M.J.  
1983. Processing of seed reserve protein in the endoplasmic reticulum: Evidence for two glycosylation steps. *J. Cell. Biol.* 96:999-1007.
- Boote, K.J.  
1975. Photosynthate distribution into fruits of Florunner peanut relative to location. pp. 72. *Proc. Amer. Peanut Res. Ed. Assoc.*

- Boote, K.J.; Gallaher, R.N.; Robertson, W.K.; Hinson, K.; and Hammond, L.C.  
1978. "Effect of Foliar Fertilization on Photosynthesis, Leaf Nutrition, and Yield of Soybeans." *Agron. J.* 70:787-791.
- Bondie, J.M., Limperis, T.; and Steere, W.C.  
1978. A new test for determining cottonseed germination. *Proc. Beltwide Cotton Prod. Mech. Conf* 1978 76
- Bortman, S.J.; Trelease, R.N.; and Miernyk, J.A.  
1981. Enzyme development and glyoxysome characterization in cotyledons of cotton seeds. *Plant Physiol.* 68:82-87
- Bouma, D.  
1970. Effects of nitrogen nutrition on leaf expansion and photosynthesis of *Trifolium subterraneum* L. I. Comparison between different levels of nitrogen supply. *Ann. Bot.* 34:1131-1142.
- Bourland, F.M., and Ibrahim, A.A.L.  
1980a. Effects of delinting and drying methods on cotton seed quality. *Proc. Beltwide Cotton Prod Res. Conf* pp 75-77.
- Bourland, F.M., and Ibrahim, A.A.L.  
1980b. Differential effects of seed deterioration on cotton cultivars. *Agron. Abstr.*, pp 108
- Boveys, B.R., and Kriedmann, P.E.  
1974. Hormonal regulation of gas exchange. *In* Mechanisms of Regulation of Plant Growth. R.L. Bieleski, A.R. Ferguson, and M.M. Cressell (eds.), *Bull. 12* Royal Society of New Zealand, Wellington, N.Z.
- Bowen, H.D.  
1961. Oxygen and physical impedance affecting germination. *Cotton Gin and Oil Mill Press* 62 37-38.
- Bower, C.A., and Fireman, M.  
1957. Saline and alkali soils. *In* USDA Yearbook of Agriculture, Soil pp 282-290. U.S. Gov. Print Office, Washington.
- Bowes, G., and Ogren, W.L.  
1972. Oxygen inhibition and other properties of soybean ribulose 1,5-diphosphate carboxylase. *J. Biol. Chem.* 247:2171-2176.
- Bowman, F.H.  
1882. *The Structure of the Cotton Fiber.* Manchester.
- Boyd, J.D., and Foster, R.C.  
1975. Microfibrils in primary and secondary wall growth develop trellis configuration. *Can. J. Bot* 53:2687-2701.
- Boyer, J.S.  
1965. Effects of osmotic water stress on metabolic rates of cotton plants with open stomata. *Plant Physiol.* 40:229-234
- Boyer, J.S.  
1970. Leaf enlargement and metabolic rates in corn, soybean, and sunflower at various leaf water potentials. *Plant Physiol.* 46:233-235.
- Boyer, J.S.  
1976a. Photosynthesis at low water potentials. *Phil. Trans. R. Soc. Lond. B.* 273:501-512.
- Boyer, J.S.  
1976b. Water deficits and photosynthesis. *In* T.T. Kozlowski (ed.), *Water Deficits and Plant Growth.* Vol. 4. Soil and Water Measurements, Plant Response, and Breeding for Drought Resistance. Acad. Press, New York.
- Bradford, M.M.  
1976. A rapid and sensitive method for the quantitation of microgram quantities of protein utilizing the principle of protein-dye binding. *Anal. Biochem.* 72:248-254.

- Brashears, A.D.; Minton, E.B.; and Green, J.A.  
1979 Potential of the ASI seed analyzer for evaluating cotton seed quality. Proc. Beltwide Cotton Prod. Res. Conf. 1979:111-112.
- Brauns, F.E., and Brauns, D.A.  
1960. The Chemistry of Lignin. Acad. Press. New York.
- Brazzel, J.R., and Gaines, J.C.  
1956. The effect of pink bollworm infestations on yield and quality of cotton. J. Econ. Entomol. 49:852-854.
- Brazzel, J.R., and Gaines, J.C.  
1957. Cotton yield and quality losses caused by various levels of pink bollworm infestations. J. Econ. Entomol. 50:609-613.
- Brevedan, R.E.; Egli, D.B.; and Leggett, J.E.  
1978. "Influence of N Nutrition on Flower and Pod Abortion and Yield of Soybeans." Agron. J. 70:81-84.
- Brewer, F.R., and Ferry, G.  
1974. Effects of air pollution on cotton in the San Joaquin Valley, Calif. Agr. 28:6-7.
- Brian, P.W.; Petty, J.H.T.; and Richmond, P.T.  
1959 Effect of gibberellic acid on development of autumn color and leaf fall of deciduous woody plants. Nature 183:58-59.
- Bridges, J.C., Jr.  
1962. Vigor testing of cottonseed. M.S. Thesis. Mississippi State University, Miss. State, MS. pp. 102.
- Briggs, R.E.  
1981 Varietal response to Pix treated cotton in Arizona. Proc. Beltwide Cotton Prod. Res. Conf. pp. 47.
- Briggs, R.E.; Maatoug, M.A.; Hofmann, W.C.; Taylor, B.B.; and Stedman, S.W.  
1983. Flowering, boll set, and yield in drip irrigated cotton in Arizona. University of Arizona Cotton Report. pp. 37-40.
- Brinkerhoff, L.A., and Hunter, R.E.  
1963. Internally infected seed as a source of inoculum for the primary cycle of bacterial blight of cotton. Phytopath. 53:1397-1401.
- Bronkers, F.  
1961. Une technique simple pour la germination du pollen de cotonnier. Acad. Roy. des Sci. d'Outremer. Bull. des Seances 7:601-603.
- Bronkers, F.; Dekeyser, B.; and Staincr, F.  
1972. Etude de la germination du pollen de cotonnier (*Gossypium hirsutum* L.) *in vitro*. Cot. Fib. Trop. 27:395-402.
- Brouwer, R., and Hoogland, A.  
1964. Responses of bean plants to root temperatures: II. Anatomical aspects. Jaafb. I.B.S.:23-31.
- Brown, A.H.  
1933. Effects of sulfuric acid delinting on cottonseeds. Bot. Gaz. 94:755-770.
- Brown, C.M., Ashworth, L.J., Jr., and McMeans, J.L.  
1975. Differential response of cotton varieties to infection by *Aspergillus flavus*. Crop Sci. 15:276-279.
- Brown, H.  
1927. Cotton. McGraw-Hill, New York. pp. 517.
- Brown, H.B.  
1938. Cotton. McGraw-Hill, New York.
- Brown, H.B., and Pope, H.W.  
1939. Effect of nitrogen, phosphorus and potassium on the earliness of cotton. Louisiana Agr. Exp. Sta. Bull. 206.

- Brown, H.B., and Ware, J.O.  
1958. Cotton McGraw-Hill, New York. pp. 566.
- Brown, H.F., and Escombe, F.  
1902. The influence of varying amounts of carbon dioxide in the air on the photosynthetic process of leaves and on the mode of growth of plants. Proc. Royal Soc. Lond. 70B:397-413
- Brown, H.S., and Addicott, F.T.  
1950. The anatomy of experimental leaflet abscission in *Phaseolus vulgaris*. Amer. Jour. Bot. 37:650-656.
- Brown, J.W.S., Ersland, D.R., and Hall, T.C.  
1982. Molecular aspects of storage protein synthesis during seed development. In: The Physiology and Biochemistry of Seed Development, Dormancy, and Germination. A.A. Khan, ed. Elsevier, Biomedical Press, NY pp. 3-42.
- Brown, K.J.  
1968. Translocation of carbohydrate in cotton. Movement to the fruiting bodies. Ann. Bot. 32:703-713.
- Brown, K.J.  
1971. Plant density and yield of cotton in Northern Nigeria. Cotton Grow. Rev. 48:255-266.
- Brown, K.J.  
1973. Factors affecting translocation of carbohydrates to fruiting bodies of cotton. Cotton Grow. Rev. 50:32-42.
- Brown, K.W.; Jordan, W.R.; and Thomas, J.C.  
1976. Water stress induced alterations of the stomatal response to decreases in leaf water potential. Physiol. Plant. 37:1-5
- Brown, L.C.  
1957. Chemical defoliation of cotton. VII. Effectiveness of adjuvants under several specific plant and environmental conditions. Agron. J. 49:563-566.
- Brown, L.C.; Cathey, G.W.; and Lincoln, C.  
1962. Growth and development of cotton as affected by toxaphene-DDT, methyl parathion, and calcium arsenate. Jour. Econ. Ent. 55:298-301.
- Brown, L.C., and Hyer, A.H.  
1954. A preliminary report on the influence of varying periods of darkness on the defoliability of several varieties of cotton. Proc. Beltwide Cotton Def. Conf. 8:44
- Brown, L.C., and Hyer, A.H.  
1956. Chemical defoliation of cotton. V. Effects of premature defoliant and desiccant treatments on boll components, fiber properties, germination and yield of cotton. Agron. J. 48:50-55.
- Brown, L.C., and Kurtz, E.B.  
1959. The *in vitro* synthesis of fats in cottonseed. Agron. J. 51:49-50
- Brown, L.C.; Lincoln, C.; Frans, R.F.; and Waddle, B.A.  
1961. Some effects of toxaphene-DDT and calcium arsenate on growth and development of cotton. Jour. Econ. Ent. 54:309-311
- Brown, L.C., and Rhyne, C.L.  
1954. Chemical defoliation of cotton. II. The influence of boll maturity on the defoliability of species and varieties of cotton. Agron. J. 46:128-132.
- Brown, L.C., and Wilson, C.C.  
1952. Some effects of zinc on several species of *Gossypium L.* Plant Physiol. 27:812-817
- Brown, L.E.  
1969. Methods for the determination of cyclopropanoid fatty acids: VIII. The HBr titration method applied to small samples. J. Amer. Oil Chem. Soc. 46:654-656.
- Brown, R.M., and Montezinos, D.I.  
1976. Cellulose microfibrils. Visualization of the biosynthetic and orienting complexes in the plasma membrane. Proc. Nat. Acad. Sci. U.S.A. 73:143-147

- Browning, V.D.; Taylor, H.M.; Huch, M.G.; and Klepper, B.  
1975. Water relations of cotton: A rhizotron study. Agr. Exp. Sta. Auburn Univ. Bull. No. 467.
- Bruce, R.R., and Romkens, M.J.M.  
1965. Fruiting and growth characteristics of cotton in relation to soil moisture tension. Agron. J. 57:135-140.
- Bruce, R.R., and Shipp, C.D.  
1962. Cotton fruiting as affected by soil moisture regime. Agron. J. 54:15-18.
- Brun, W.A., and Cooper, R.L.  
1967. Effects of light intensity and carbon dioxide concentration on photosynthetic rate of soybean. Crop Sci. 7:451-454.
- Bruyn, L. P. de  
1964. Influence of soil moisture deficit on growth and production of cotton. Abstr. Emp. Cotton Growing Rev. 43:69.
- Buchanan, B.B.  
1980. Role of light in the regulation chloroplast enzymes. Ann. Rev. Plant Physiol. 31:341-374.
- Buchanan, B.B., and Schurmann, P.  
1973. Regulation of ribulose-1,5-diphosphate carboxylase in the photosynthetic assimilation of carbon dioxide. J. Biol. Chem. 248:4956-4964.
- Bugbee, W.M., and Sappenfield, W.P.  
1970. Effect of *Verticillium* wilt on cotton yield, fiber properties and seed quality. Crop Sci. 10:649-652.
- Buie, T.S.  
1929. Fruiting habit of the cotton plant. South Carolina Agr. Exp. Sta. Bull. No. 261.
- Bunch, H.D.; Dale, J.J., Jr.; and Guerry, W.W.  
1961. Separation of cockleburrs from acid-delinted cottonseed. Miss. Agr. Exp. Sta. Inf. Sheet No. 714.
- Bunce, J.A.  
1977a. Effects of water stress on leaf expansion, net photosynthesis, and vegetative growth of soybeans and cotton. Can. J. Bot. 56:1492-1498.
- Bunce, J.A.  
1977b. Nonstomatal inhibition of photosynthesis at low water potentials in intact leaves of species from a variety of habitats. Plant Physiol. 59:348-350.
- Bunce, J.A.  
1981. Relationships between maximum photosynthetic rates and photosynthetic tolerance of low leaf water potentials. Can. J. Bot. 59:769-774.
- Burch, T.A., and Delouche, J.C.  
1959. Absorption of water by seeds. Proc. Ass. Offic. Seed Analysts. North America 49:142-150.
- Burg, S.P.  
1968. Ethylene, plant senescence, and abscission. Plant Physiol. 43:1503-1511.
- Burns, G.N.  
1969. The Science of Genetics. An Introduction to heredity. The MacMillan Co., London.
- Burriss, J.S.  
1976. Seed/seedling vigor and field performance. Jour. Seed Tech. 1:58-74
- Burriss, R.H., and Black, C.C.  
1976. CO<sub>2</sub> Metabolism and Productivity. University Park Press, Baltimore, MD. pp. 432.
- Buxton, D.R.; Briggs, R.E.; Patterson, L.L.; and Watkins, S.D  
1977. Canopy characteristics of narrow row cotton as influenced by plant density. Agronomy Journal 69:929-933.
- Buxton, D.R.; Patterson, L.L., and Briggs, R.E.  
1979. Fruiting pattern in narrow row cotton. Crop Science 19:17-22.
- Buxton, D.R.; Melick, P.J.; Patterson, L.L.; and Godinez, C.A.  
1977a. Evaluation of seed treatments to enhance Pima cotton seedling emergence. Agron. J. 69:672-676.



- Buxton, D.R., Melick, P.J.; Patterson, L L ; and Pegelow, E.L., Jr.  
1977b. Relationships among cotton seed vigor and emergence. *Agron. J.* 69:677-681.
- Buxton, D.R., and Sprenger, P.J  
1976. Genetic variability for cottonseed germination at favorable and low temperatures. *Crop Sci.* 16:243
- Buxton, D.R., Sprenger, P.J., and Pegelow, E.J., Jr.  
1976. Periods of chilling sensitivity in germinating Pima cottonseed. *Crop Sci.* 16:471-474.
- Buxton, D.R.; Stapleton, H.N.; Makki, Y.; and Briggs, R.E.  
1973. Some effects of field weathering of seed cotton in desert environment. *Agron. J.* 65:14-17
- Bykov, O.D.; Koshkin, V.A.; and Catsky, J.  
1981. Carbon dioxide compensation concentration of C<sub>3</sub> and C<sub>4</sub> plants. Dependence on temperature. *Photosynthetica*, 15:114-121

## C

- Cabangbang, R.P., and Covar, F.P.  
1978. Variation among cotton seeds derived from different primings. *Phillip. J. Crop Sci.* 3:215-220
- Calahan, J.S.  
1977. Some physiological effects of high sodium, calcium, and chloride concentrations on cotton. Ph.D. Dissertation, Texas A&M University.
- Calahan, J.S., Jr., and Joham, H.E.  
1974. Sodium and calcium interactions in the salt tolerance of cotton. *Proc. Beltwide Cotton Prod. Res. Conf. National Cotton Council, Memphis.* pp. 38-39.
- Caldwell, R.L.; Stith, L.S.; and Weinberg, B.B.  
1966. A qualitative chemical difference in cotton in response to infection by *Verticillium albo-atrum*. *Proc. Ann. Cotton Disease Council, Cotton Defoliation Physiology Conf., and Cotton Improvement Conf.* pp. 113-116
- Caldwell, W.P.  
1962. Relationship of preharvest environmental factors to seed deterioration in cotton. Ph.D. Dissertation, Mississippi State University, Mississippi State, MS.
- Calkins, E.W.S.  
1961. Cotton fiber weight distribution (2) *Text Res. Journ.* 31:176-177.
- Calvert, A., and Slack, G.  
1975. Effects of carbon dioxide enrichment on growth, development and yield of glasshouse tomatoes. I. Responses to controlled concentrations. *J. Hort. Sci.* 50:61-71
- Camp, C.R., and Lund, Z.F.  
1964. Effect of soil compaction on cotton roots. *Crops and Soils.* Nov. 8-9
- Camp, A.F., and Walker, M.N.  
1927. Soil temperature studies with cotton. *Univ. of Fla. Agr. Expt. Sta. Bull. No. 189* 1-32
- Cannon, W.A.  
1925. Physiological features of roots, with special reference to the relation of roots to the aeration of the soil. *Carnegie Inst. Pub. No. 368.* Washington, D.C.
- Caplan, A., Herrera-Estrella, L.; Inze, D.; Van Haute, E.; Van Montagu, M.; Schell, J.; and Zambryski, P.  
1983. Introduction of genetic material into plant cells. *Science* 222 815-821.
- Carlson, R.W.  
1983. The effect of SO<sub>2</sub> on photosynthesis and leaf resistance at varying concentrations of CO<sub>2</sub>. *Environ. Pollut. Ser. A.* 30:309-321
- Carlson, R.W., and Bazzaz, F.A.  
1980. The effects of elevated CO<sub>2</sub> concentrations on growth, photosynthesis, transpiration, and water use efficiency of plants. *In* J.J. Singh and A. Deepak (eds.), *Environmental and Climatic Impact of Coal Utilization*, pp 609-623. *Acad. Press.* New York.

- Carlson, R.W., and Bazzaz, F.A.  
1982. Photosynthetic and growth response to fumigation with SO<sub>2</sub> at elevated CO<sub>2</sub> for C<sub>3</sub> and C<sub>4</sub> plants. *Oecologia* 54:50-54.
- Carns, H.R.  
1951. Oxygen, respiration, and other critical factors in abscission. Ph.D. Dissertation, University of California, Los Angeles.
- Carns, H.R.  
1958. Present status of the abscission accelerator from young cotton bolls. Proc. 13th Cotton Defoliation and Physiology Conf., Houston pp. 39.
- Carns, H.R.  
1966. Abscission and its control. *Ann. Rev. Plant Physiol.* 17:295-314.
- Carns, H.R.; Addicott, F.T.; Baker, K.C.; and Wilson, R.K.  
1961. Acceleration and retardation of abscission by gibberellic acid. *In Int. Conf. on Plant Growth Regulation.* pp. 559-566. Iowa State University Press, Ames
- Carns, H.R.; Addicott, F.T.; and Lynch, R.S.  
1951. Some effects of water and oxygen on abscission *in vitro*. *Plant Physiol.* 26:629-630.
- Carns, H.R., Hacskeylo, J.; and Embry, J.L.  
1955. Relation of an indole-3 acetic acid inhibitor to cotton boll development. Proc. 9th Ann. Beltwide Cotton Defoliation Conf., pp. 65-68.
- Carns, H.R., and Mauney, J.R.  
1968. Physiology of the cotton plant. *In F.C. Elliott, M. Hoover, and W.K. Porter (eds.), Advances in Production and Utilization of Quality Cotton: Principles and Practices,* pp. 41-43. Iowa State University Press, Ames, Iowa.
- Carpita, N.C., and Delmer, D.P.  
1980. Protection of cellulose synthesis in detached cotton fibers by polyethylene glycol. *Plant Physiol.* 66:911-916.
- Carpita, N.C., and Delmer, D.P.  
1981. Concentration and metabolic turnover of UDP—Glucose in developing cotton fibers. *J. Biol. Chem.* 256:308-315.
- Carson, E.W.  
1974. *The Plant Root and Its Environment.* University of Virginia Press.
- Carter, D.L.; Wiegand, C.L.; and Allen, R.R.  
1964. The salinity of non-irrigated soils in the Lower Rio Grande Valley of Texas. USDA, ARS. pp. 41-98.
- Carter, M.E., Cherry, J.P.; and Miller, P.A.  
1979. Science and Education Administration's program on maintaining and improving quality of cottonseed for processing. *Oil Mill Gaz.* 83:22-27.
- Cathey, G.W.  
1978. Evaluation of potassium 3,4-dichloroisothiazole-5-carboxylate as a harvest-aid chemical on cotton. *Crop Sci.* 18:301-304.
- Cathey, G.W.  
1979. Harvest-aid chemicals and practices for cotton. *Outlook Agr.* 10:191-197.
- Cathey, G.W.  
1980. Chemical plant growth regulators: Mid south cotton. Proc. Plt. Grow. Reg. Work. Gro. Conf. pp. 197-198.
- Cathey, G.W., and Barry, H.R.  
1977. Evaluation of glyphosate as a harvest-aid chemical on cotton. *Agron. J.* 69:11-14.
- Cathey, G.W.; Elmore, C.D., and McMichael, B.L.  
1981c. Some physiological responses of cotton leaves to foliar application of potassium 3,4-dichloroisothiazole-5-carboxylate and S,S,S-tributyl phosphotriothoate. *Physiol. Plant.* 51:140-144.

- Cathey, G.W., and Hacskaylo, J.  
1971 Prolonged foliar contact as a possible means of increasing the effectiveness of defoliant. Proc. Beltwide Cotton Prod. Res. Conf. pp 31-33.
- Cathey, G.W., and Luckett, K.E.  
1980. Some effects of growth regulator chemicals on cotton earliness, yield, and quality Proc. Beltwide Cotton Prod. Res. Conf. pp 35.
- Cathey, G.W., Luckett, K.E.; and Rayburn, S.T.  
1982. Accelerated cotton boll dehiscence with growth regulator and desiccant chemicals. Field Crops Res 5:113-120
- Cathey, G.W.; Ross, B.W., and Harvey, A.J.  
1981a. Some effects of acephate on growth and development of cotton Proc. Beltwide Cotton Prod. Res. Conf. pp. 45.
- Cathey, G.W.; Ross, B.W.; and Harvey, A.J.  
1981b. Absorption, translocation, and accumulation of <sup>14</sup>C-acephate in cotton plants. Proc. Plt. Grow. Reg. Work Gro. Conf pp. 165.
- Catsimpooulas, N.; Kenney, J.A., Meyer, E.W., and Szuhaj, B.F.  
1971. Molecular weight and amino acid composition of glycinnin subunits J. Sci. Fd. Agric. 22:448-450.
- Cave, G., Tolley, L.C.; and Strain, B.R.  
1981. Effect of carbon dioxide enrichment on chlorophyll content, starch content and starch gran structure in *Trifolium subterraneum* leaves Physiol. Plant. 51:171-174.
- Chabot, B.F., and Bunce, J.A.  
1979 Drought stress effects on leaf carbon balance In O.T. Solbrig, S. Jain, G.H. Johnston, and P.H. Raven (eds.), Topics in Plant Population Biology, pp 338-355. Columbia University Press, New York.
- Chailakhyan, M. Kh.  
1968 Flowering hormones of plants In F. Wightman and G. Setterfield (eds.), Biochemistry and Physiology of Plant Growth Substances, pp. 1317-1340. The Runge Press, Ltd., Ottawa, Canada.
- Chailakhyan, M. Kh.  
1979 Genetic and hormonal regulation of growth Flowering and sex expression in plants. Amer. J. Bot. 66:717-936.
- Chan, B.G., and Waiss, A.C., Jr.  
1981 Evidence for acetogenic and shikimic pathways in cotton glands. Proc. Beltwide Cotton Prod. Res. Conf. pp. 49
- Chan, B.G.; Waiss, A.C., Jr., and Lukefahr, M.  
1977. Condensed tannin, an antibiotic chemical from *Gossypium hirsutum* L. J. Insect Physiol. 24:113-118 pp. 49-51.
- Chan, B.G., Waiss, A.C., Jr.; Binder, R.G.; and Elliger, C.A.  
1978. Inhibition of *Lepidopterous* larval growth by cotton constituents Ent. Exp. & Appl. 24:94-100
- Chandler, W.H.  
1951 "Deciduous Orchards." Lee and Febiger, Philadelphia, Penn.
- Chang, C.S.; Clark, R.L.; and Welch, G.B.  
1967. The effect of static loads and energy on the germination of cottonseed. Miss. Agr. Exp. Sta. Inf. Sheet No. 980.
- Chang, C.W.  
1975. Carbon dioxide and senescence in cotton plants. Plant Physiol. 55:515-519.
- Chang, C.W.  
1979. Starch and its component ratio in developing cotton leaves. Plant Physiol. 63:973-977.
- Chang, C.W.  
1980. Starch depletion and sugars in developing cotton leaves. Plant Physiol. 65:844-847.

- Chang, Y.P., and Jacobs, W.P.  
1973 The regulation of abscission and IAA by senescence factor and abscisic acid. *Amer. J. Bot.* 60:10-16.
- Chapman, H.W., and Loomis, W.E.  
1953. Photosynthesis in the potato under field conditions. *Plant Physiol.* 28:703-716.
- Chatterjee, S.  
1977. Studies on the abscission of flowers and fruits of cotton (*Gossypium barbadense* L.). *Biol. Plant.* 19:81-87.
- Chatterjee, S., and Chatterjee, S.K.  
1972. Ethrel effect on senescence of cotyledonary leaves of *Gossypium barbadense* L. *Science and Culture* 38:32-34.
- Chatterjee, S., and Leopold, A.C.  
1963. Auxin structure and abscission activity. *Plant Physiol.* 38:268-273.
- Chements, F.E.  
1921. Aeration and air content. The role of oxygen in root activity. Carnegie Inst. Pub. No. 315, Wash. D.C.
- Cherry, J.P.  
1977. Oilseed enzymes as biological indicators for food uses and applications. *In Enzymes in Food and Beverage Processing*. R.L. Ory and A.J. St. Angelo, (eds.), ACS Symposium Series, No 47. American Chemical Society, Washington, D.C. pp 209-228.
- Cherry, J.P.  
1978. Enzymes as quality indicators in edible plant tissues. *In Postharvest Biology and Biotechnology*. H.O. Hultin and M. Milner, (eds.), Food and Nutrition Press, Inc. Westport, Conn. pp. 370-399.
- Cherry, J.P.; Berardi, L.C.; Zarins, Z.M.; Wadsworth, J.I.; and Vinnett, C.H.  
1978c. Cottonseed protein derivatives as nutritional and functional supplements in food formulations. *In Improvement of Protein Nutritive Quality of Foods and Feeds*. M. Friedman, (ed.), Plenum Publish Co., New York, NY., pp. 767-796.
- Cherry, J.P., and Goodwin, S.D.  
1978. Composition of cottonseed from bolls contaminated with varying numbers of pink bollworms. *Proc. Beltwide Cotton Prod. Res. Conf* pp. 51-53.
- Cherry, J.P., and Katterman, F.R.H.  
1971. Nonspecific esterase isozyme polymorphism in natural populations of *Gossypium thurberi*. *Phytochem.* 10:141-145
- Cherry, J.P.; Katterman, F.R.H.; and Endrizzi, J.E.  
1970. Comparative studies of seed proteins of species of *Gossypium* by gel electrophoresis. *Evolution* 24:431-447.
- Cherry, J.P., Katterman, F.R.H., and Endrizzi, J.E.  
1971. A comparative study of seed proteins of allopolyploids of *Gossypium* by gel electrophoresis. *J. Genet. and Cytol.* 13:155-158.
- Cherry, J.P.; Katterman, F.R.H.; and Endrizzi, J.E.  
1972. Seed esterases, leucine aminopeptidases and catalases of species of the genus *Gossypium*. *Theoret. and Appl. Genet.* 42:218-226.
- Cherry, J.P., and Leffler, H.R.  
1984. Seed. In: Cotton. R.S. Kohel and C.F. Lewis, eds. *Agronomy Monograph no 24, ASA-CCSA-SSSA*, Madison, WI. pp. 511-569.
- Cherry, J.P.; Simmons, J.G.; Hyer, A.H.; Garber, R.H.; Carter, L.M.; and Cooper, H.B.  
1979a. Quality of module-stored cottonseed in California. *Proc. Beltwide Cotton Prod. Res. Conf.*, pp. 36-40.
- Cherry, J.P.; Simmons, J.G.; and Kohel, R.J.  
1978a. Potential for improving cottonseed quality by genetic and agronomic practices. *In Nutritional Improvement of Food and Feed Proteins*. M. Friedman (ed.), Plenum Press, NY. pp. 343-364.

- Cherry, J.P.; Simmons, J.G.; and Kohel, R.J.  
1978c. Cotton seed composition of National Variety Test cultivars grown at different Texas locations. Proc. Beltwide Cotton Prod. Res. Conf., pp. 47-50.
- Cherry, J.P.; Simmons, J.G.; Kohel, R.J.; Cooper, H.B.; Lehman, M.; Dobbs, J.; Fry, K.E.; Kittock, D.L.; and Henneberry, T.J.  
1979b. Relationship of cotton seed quality to genetic and agronomic practices. Cotton Gin and Oil Mill Press 80:18-21.
- Cherry, J.P.; Simmons, J.G.; Nelson, M.L.; Colwick, R.F.; Barker, G.L.; Wesley, R.A.; and Williford, J.R.  
1980. Quality of artificially dried (forced heated air, microwaved, lyophilized) cottonseed from unopened bolls. Proc. Beltwide Cotton Prod. Res. Conf., pp. 43-51.
- Cherry, J.P.; Simmons, J.G.; and Tallant, J.D.  
1977. Cottonseed protein composition and quality of *Gossypium* species and cultivars. Proc. Beltwide Cotton Prod. Res. Conf. pp. 46-49.
- Cherry, T.  
1976. Planting seed quality control. California-Arizona programs. Proceedings of the 1976 Beltwide Production Mechanization Conference. pp. 3739.
- Chester, K.S.  
1938. Gravity grading, a method for reducing seed borne disease of cotton. Phytopath. 28:745-749.
- Chester, K.S.  
1940. Field results with gravity graded cottonseed. Phytopath. 30:703.
- Chester, K.S.  
1941. The probability law in cotton seedling disease. Phytopath. 31:1078-1088.
- Childers, N.F., and Cowart, F.F.  
1935. The photosynthesis, transpiration, and stomata of apple leaves as affected by certain nutrient deficiencies. Proc. Amer. Soc. Hort. Sci. 33:160-163.
- Ching, T.M., and Schoolcraft, I.  
1968. Physiological and chemical differences in aged seeds. Crop Sci. 8:407-409.
- Chlan, C.A., and Dure, L. III  
1983. Plant seed embryogenesis as a tool for molecular biology. Mol. & Cell Biochem. 55:5-15.
- Choinski, J.S., Jr., and Trelease, R.N.  
1978. Control of enzyme activities in cotton cotyledons during maturation and germination. II. Glyoxysomal enzyme development in embryos. Plant Physiol. 62:141-145.
- Choinski, J.S., Jr., Trelease, R.N., and Doman, D.C.  
1981. Control of enzyme activities in cotton cotyledons during maturation and germination. III. *In vitro* development in the presence of abscisic acid. Planta 152:428-435.
- Chollet, R., and Anderson, L.L.  
1976. Regulation of ribulose 1,5-bisphosphate carboxylase/oxygenase activities by temperature pretreatment and chloroplast metabolites. Arch. of Biochem. and Biophys. 176:344-351.
- Chollet, R., and Ogren, W.L.  
1975. Regulation of photorespiration in  $C_3$  and  $C_4$  species. Bot. Rev. 41:137-179.
- Chrispeels, M.J., Higgin, T.J.U.; Craig, S.; and Spencer, D.  
1982. Role of the endoplasmic reticulum in the synthesis of reserve proteins and the kinetics of their transport to protein bodies in developing pea cotyledons. J. Cell Biol. 93:5-14.
- Christiansen, M.N.  
1960. A study of the effect of temperature levels of germination environment on chemical and physical characteristics of cotton seedlings. Ph.D. Dissertation Department of Field Crops, N.C. State.
- Christiansen, M.N.  
1961. A method of measuring and expressing epigeous seedling growth rate. Crop Sci. 2:487-489.
- Christiansen, M.N.  
1963. Influence of chilling upon seedling development of cotton. Plant Physiol. 38:520-522.

- Christiansen, M.N.  
1964 Influence of chilling upon subsequent growth and morphology of cotton seedlings. *Crop Sci.* 4:584-586.
- Christiansen, M.N.  
1967. Periods of sensitivity to chilling in germinating cotton. *Plant Physiol.* 42:431-433.
- Christiansen, M.N.  
1968 Induction and prevention of chilling injury to radicle tips of imbibing cottonseed. *Plant Physiol.* 43:743-746
- Christiansen, M.N.  
1969. Seed moisture content and chilling injury to imbibing cotton seed. *Proc. Beltwide Cotton Prod. Res. Conf.* 1969:50-51.
- Christiansen, M.N.  
1978. The physiology of plant tolerance to temperature extremes. In G.A. Jung (ed.), *Crop Tolerance to Suboptimal Land Conditions*, ASA Special Publication No. 32, pp. 173-191, American Society of Agronomy, Madison, Wisconsin.
- Christiansen, M.N.  
1979. Physiological bases for resistance to chilling. *Hort Sci.* 14:583-586.
- Christiansen, M.N., and Ashworth, E.N.  
1978. Prevention of chilling injury to seedling cotton with anti-transpirants. *Crop Sci.* 18:907-908.
- Christiansen, M.N.; Carns, H.R.; and Slyter, D.J.  
1970. Stimulation of soluble loss from radicles of *Gossypium hirsutum* L. by chilling anaerobiosis, and low pH. *Plant Physiol.* 46:53-56.
- Christiansen, M.N., and Justus, N.  
1963. Prevention of field deterioration of cotton seed by an impermeable seed coat. *Crop Sci.* 3:439-440.
- Christiansen, M.N., and Lewis, C.F.  
1973. Reciprocal differences in tolerance to seed-hydration chilling in F<sub>1</sub> progeny of *Gossypium hirsutum* L. *Crop Sci.* 13:210-212.
- Christiansen, M.N., and Moore, R.P.  
1959. Seed coat structural differences that influence water uptake and seed quality in hardseed cotton. *Agron J.* 51:582-584.
- Christiansen, M.N.; Moore, R.P.; and Rhyne, C.L.  
1960. Cotton seed quality preservation by a hard seed characteristic which restricts internal water uptake. *Agron. J.* 52:81-84.
- Christiansen, M.N., and Thomas, R.O.  
1969. Season long effects of chilling treatment applied to germinating cotton seed. *Crop Sci.* 9:672-673.
- Christiansen, M.N., and Thomas, R.O.  
1971. Seed hydration-chilling treatment effects on germination and subsequent growth and fruiting of cotton. *Crop Sci.* 11:454-456.
- Christidis, B.G.  
1955. Dormancy in cotton seed. *Agron. J.* 47:400-403.
- Christidis, B.G., and Harrison, G.J.  
1955. *Cotton Growing Problems*. McGraw-Hill Book Company, Inc. New York, Toronto, London.
- Chytiris, T.  
1961. Cotton fiber weight distribution (1). *Text. Res. Journ.* 31:175-176.
- Clark, B.E.  
1953. Relationship between certain laboratory tests and the field germination of sweet corn. *Proc. Assoc. Off. Seed Anal.* 1953:42-44.
- Clark, R.L.; Welch, G.B.; and Anderson, J.H.  
1969. Effect of high-velocity impact on germination and crackage of cottonseed. *Trans. of the ASAE* 12:748-751.

- Clark, W.C.  
1982. Carbon Dioxide Review, 1982. Institute for Energy Analysis. Oak Ridge Assoc Universities. Oak Ridge, TN. Oxford University Press, New York. pp 440.
- Clay, W.F., Katterman, F.R.H.; and Hammett, J.R.  
1975. Nucleic acid metabolism during germination of Pima cotton (*Gossypium barbadense*). Plant Physiol. 55:231-236
- Cleland, R.E.  
1977. The control of cell enlargement. In D.H. Jennings (ed.), Integration of Activity in the Higher Plant, The University Press, Cambridge.
- Cleland, R.E.  
1979. Auxin and H<sup>+</sup>-excretion: The state of our knowledge. In F. Skoog (ed.), Plant Growth Substances, Springer Verlag, New York.
- Clough, J.M., and Peet, M.M.  
1981. Effects of intermittent exposures at high atmospheric CO<sub>2</sub> on vegetative growth in soybean. Physiol. Plant. 53:565-569.
- Clough, J.M.; Peet, M.M.; and Kramer, P.J.  
1981. Effects of high atmospheric CO<sub>2</sub> and sink size on rates of photosynthesis of a soybean cultivar. Plant Physiol. 67:1007-1010
- Coats, G.E.  
1966. Effects of NAA on early growth of cotton. Proc. 1966 Beltwide Cotton Prod. Res. Conf. pp. 228-236
- Cock, J.H., and Yoshida, S.  
1973. Changing sink and source relations in rice (*Oryza sativa* L.) using carbon dioxide enrichment in the field. Soil Sci. Plant Nutr. 19:229-234.
- Cogneć, M.  
1976. Variations in the physiological and hormonal states of cotton fruit and their relationship with the initiation of abscission (Translated from French) Ph.D. Dissertation, Univ. of Paris VI. pp 245.
- Cole, D.F., and Christjansen, M.N.  
1975. Effect of chilling duration on germination of cotton seed. Crop Sci. 15:410-412.
- Cole, D.F., and Wheeler, J.E.  
1974. Effect of pre-germination treatments on germination and growth of cotton at sub-optimal temperatures. Crop Sci. 14:451-454.
- Collings, G.H., and Warner, J.D.  
1927. Root development of cotton on Cecil sandy loam during 1926. Agron. J. 19:839-842
- Collins, W.B.  
1976. Effect of carbon dioxide enrichment on growth of the potato plant. Hort Sci. 11:467-469.
- Colvin, J.R.  
1972. Structure and biosynthesis of cellulose. Macromol. Sci. 1:47
- Colwick, R.F.; Garner, T.H.; Christenbury, G.D.; Welch, G.B.; Clark, R.L.; Delouche, J.C.; Baskin, C.C.; Sorenson, J.W.; Wilkes, L.H.; Person, N.K., and Schroeder, H.W.  
1972. Factors affecting cotton seed damage in harvesting and handling. Agricultural Research Service, USDA Prod. Res. Rept. No. 135.
- Conner, J.W., Krieg, D.R.; and Gipson, J.R.  
1972. Accumulation of simple sugars in developing cotton bolls as influenced by night temperatures. Crop Sci. 12:752-754.
- Constable, G.A.  
1976. Temperature effects on the early field development of cotton. Austr. Jour. Exp. Agr. and Anim. Husb. 16:905-910.
- Constable, G.A.  
1977a. Narrow row cotton Naomi Valley. 1. Growth, yield and quality of four cultivars. Austr. J. of Exp. Agr. and Husb. 17:135-142.

- Constable, G.A.  
1977b. Narrow row cotton Naomi Valley. 2. Plant population and row spacing. *Austr. J. of Exp Agr. and Husb.* 17:143-148.
- Constable, G.A. and Gleeson, A.C.  
1977. Growth and distribution of dry matter in cotton (*Gossypium hirsutum* L.). *Austr. J. Agr. Res.* 28:249-256
- Constable, G.A. and Hearn, A.B.  
1981. Irrigation for crops in a sub-humid environment. VI. Effect of irrigation and nitrogen fertilizer on growth, yield and fiber quality. *Irrig. Sci.* 3:17-28.
- Constable, G.A. and Rawson, H.M.  
1980. Carbon production and utilization in cotton: inferences from a carbon budget. *Austr. J. Pl. Physiol.*
- Constantin, M.J.  
1964. Fertilization and embryogenesis in *G. hirsutum* X *G. Barbadosense* L. hybrids. *Proc. 16th Ann. Cott. Imp. Conf.* pp 47.
- Cook, M.G., and Evans, L.T.  
1978. Effect of relative size and distance of competing sinks on the distribution of photosynthetic assimilates in wheat. *Aust. J. Plant Physiol.* 5:495-509
- Cooper, H.B.; Cherry, J.P.; Simmons, J.G.; Lehman, M.; and Dobbs, J.  
1979. Seed quality traits of Acala cottonseed grown in California. *Proc. Beltwide Cotton Prod. Res. Conf.* pp. 40.
- Cooper, H.B., and Hyer, A.H.  
1977. Glandless cotton breeding in the far west. A progress report. *Proc. Glandless Cotton Conf.* 1:84-92.
- Cooper, H.P.; Paden, W.R., and Phillippe, M.M.  
1953. Effects of applications of sodium in fertilizer on yields and composition of the cotton plants. *Soil Sci.* 76:19-28.
- Cooper, R.L., and Brun, W.A.  
1967. Response of soybeans to a carbon dioxide-enriched atmosphere. *Crop Sci.* 7:455-457
- Cooper, T.G., and Beevers, H.  
1969.  $\beta$ -oxidation in glyoxysomes from castor bean endosperm. *J. Biol. Chem.* 244:3514-3520.
- Cooper, W.C., and Horanic, G.  
1973. Induction of abscission at hypobaric pressures. *Plant Physiol.* 51:1002-1004.
- Cornelius, J.; Bassi, J., and Holloway, J.  
1970. The aspects of defoliation based on tests conducted to compare phosphate and chlorate defoliant and their additives with RP2929 and Wiltz 65. *Proc. Beltwide Cotton Prod. Res. Conf.* pp 38-39.
- Cothren, J.T.  
1980. Boll opening responses of cotton to ethrel and GAF-7767141. *Proc. Plt. Grow. Reg. Work. Gro. Conf.* pp. 83.
- Cothren, J.T., and Cotterman, C.D.  
1980. Evaluation of cytozyme Crop as a foliar application to enhance cotton yields. *Ark. Farm Res.* 29:2-3.
- Cotton, J.R.  
1965. Breeding cotton for tolerance to *Verticillium* wilt. U.S. Department of Agriculture, ARS 34-80.
- Cowan, I.R.  
1977. "Stomatal Behavior and Environment." *In Advances in Botanical Research Vol. 4* Acad. Press, pp. 117-227
- Cowan, I.R., and Farquhar, G.D.  
1977. Stomatal function in relation to leaf metabolism and environment. *Symp. Soc. Exp. Biol.* 31:471-505.



- Cowan, I.R., and Milthorpe, F.L.  
1968. Plant factors influencing the water status of plant tissues. In T.T. Kozlowski (ed.), *Water Deficient and Plant Growth*. Vol. 1, pp. 137-193. Acad. Press, New York.
- Cowan, I.R.; Raven, J.A.; Hartung, W.; and Farquhar, G.D.  
1982. A possible role for abscisic acid in coupling stomatal conductance and photosynthetic carbon metabolism in leaves. *Aust. J. Plant Physiol.* 9:489-498.
- Cowan, I.R., and Troughton, J.H.  
1971. The relative role of stomata in transpiration and assimilation. *Planta* 97:325-336.
- Cracker, L.E., and Abeles, F.B.  
1969. Abscission: Role of abscisic acid. *Plant Physiol.* 44:1144-1149
- Crane, J.C.  
1964. Growth substances in fruit setting and development. *Ann. Rev. Plant Physiol.* 15:303-326.
- Crawford, S.II.  
1981. Effects of mequiquat chloride on cotton in Northeast Louisiana. *Proc. Beltwide Cotton Prod. Res. Conf.*, pp. 45-46.
- Creelman, R.A.  
1975. The effects of boll produced abscisic acid upon the terminal growth and fruit retention of *Gossypium hirsutum* L. cv. Deltapine 16. Doctoral Dissertation, University of Arkansas, Fayetteville, Ark.
- Creelman, R.A., and Sabbe, W.E.  
1976. The effects of exogenous ABA (abscisic acid) upon cotton plant terminal growth. *Proc. 28th Cotton Improvement Conf.* pp. 104-107.
- Crowther, F.  
1934a. Studies in growth analysis of the cotton plant under irrigation in the Sudan. I. The effects of different combination of nitrogen applications and water supply. *Ann. Bot.* 48:877-913
- Crowther, F.  
1934b. Studies in growth of the cotton plant under irrigation on the Sudan. II. Seasonal development and yield. *Ann. Bot.* 49:509-533.
- Crowther, F.  
1941. Studies in growth analyses of the cotton plant under irrigation in the Sudan. II. Seasonal variations in development and yield. *Ann. Bot.* 509-533.
- Cummins, W.R., Kende, H., and Raschke, K.  
1971. Specificity and reversibility of the rapid stomatal response to abscisic acid. *Planta* 99:347-351
- Cummings, M.B., and Jones, C.H.  
1918. The aerial fertilization of plants with carbon dioxide (sic). *Vermont Sta. Bull.* 211, pp. 56.
- Curley, R.G., Kepner, R.A.; Hoover, M.; McCutcheon, U.U.; Stronberg, L.K., and Yeary, E.A.  
1973. Seed cotton storage, and aid to both growers and ginners. *Calif. Agric.* 27:7-9.
- Cutler, J.M., and Rains, D.W.  
1977. Effects of irrigation history on responses of cotton to subsequent water stress. *Crop Sci.* 17:329-335.
- Cutler, J.M., and Rains, D.W.  
1978. Effects of water stress and hardening on the internal water relations and osmotic constituents of cotton leaves. *Physiol. Plant* 42:261-268.
- Cutler, J.M.; Rains, D.W.; and Loomis, R.S.  
1977a. Role of changes in solute concentration in maintaining favorable water balance in field-grown cotton. *Agron J* 69:773-779.
- Cutler, J.M.; Rains, D.W.; and Loomis, R.S.  
1977b. The importance of cell size in the water relations of plants. *Physiol. Plant.* 40:255-260

## D

Dalianis, C.D.

- 1982 Rate of radicle emergence as a measure of seedling emergence and vigor in cotton. (*Gossypium hirsutum*). Seed Sci & Technol 10:35-45.

Dale, J.E.

- 1959 Some effects of the continuous removal of floral buds on the growth of the cotton plant. Ann Bot. 23:636-649.

Dale, J.E.

1961. Investigations into the stomatal physiology of upland cotton. I. The effects of hour of day, solar radiation, temperature, and leaf water content on stomatal behaviour. Ann. Bot. 25:39-52.

Dalc. J.E., and Milford, G.F.

1965. The role of endogenous growth substances in the fruiting of upland cotton. New Phytol 64:28-37.

Darnell, J.E., Jr.

1982. Variety in the level of gene control in eukaryotic cells. Nature 297:365-371.

Dashek, W.V.; and Llewellyn, G.C.

1977. Aflatoxin toxicity and mode of action in plant tissues. Ann. Nutr. Alim. 31:841-858.

Da Silva, J.V., Naylor, A.W.; and Kramer, P.J.

- 1974 Some ultrastructural and enzymatic effects of water stress in cotton (*Gossypium hirsutum* L.) leaves. Proc. Nat. Acad. Sci. 71:3243-3247.

Dastur, R.H.

1948. Scientific monography. No. 2. Indian Central Cotton Comm. 2nd. ed. (Bombay).

Dastur, R.H.

1959. Physiological studies on the cotton crop and their practical applications. The Indian Central Cotton Committee, Bombay. Vol. 2. pp. 1-105.

Dastur, R.H., and Asana, R.D.

1960. Physiology. In Cotton in India, a Monograph. Vol. 2. The Indian Central Cotton Committee, Bombay. pp. 1-105.

Dave, Y.C.; Douglas, A.G.; and Andries, J.A.

1971. Cotton seed density within plants and varieties and its influence on growth and performance. Proc. Beltwide Cotton Prod. Res. Conf. 1971:64-65.

Davenport, T.L., Jordan, W.R., and Morgan, P.W.

- 1977a. Movement and endogenous levels of abscisic acid during water stress-induced abscission in cotton seedlings. Plant Physiol. 59:1165-1168

Davenport, T.L.; Jordan, W.R.; and Morgan, P.W.

1979. Movement of kinetin and gibberellic acid in leaf petioles during water stress-induced abscission in cotton. Plant Physiol. 63:152-155.

Davenport, T.L.; Morgan, P.W.; and Jordan, W.R.

- 1977b. Auxin transport as related to leaf abscission during water stress in cotton. Plant Physiol. 59:554-557.

Davidonis, G.H., and Hamilton, R.H.

1983. Plant regeneration from callus tissue of *Gossypium hirsutum* (L.) Plant Sci. Lett. 32:89-93.

Davidson, E.H., and Britten, R.J.

1979. Regulation of gene expression. Possible role of repetitive sequences. Science 204:1052-1059.

Davidson, E.H.; Jacobs, H.T.; and Britten, R.J.

1983. Very short repeats and coordinate induction of genes. Nature 301:468-470.

Davies, W.J.

1978. Some effects of abscisic acid and water stress on stomata of *Vicia faba* L. J. Exp. Bot. 29:175-182

- Davis, D.G.; Dusbabek, K.; and Hoerauf, R.A.  
1974 *In vitro* culture of callus tissue and cell suspensions from okra (*Hibiscus esculentus* L.) and cotton (*Gossypium hirsutum* L.). *In Vitro* 9:395-398.
- Davis, J.T.; Sterrett, J.P.; and Leather, G.R.  
1972 Ethephon-endothall as a chemical abscissor of bean leaves. *Hortscience* 57:478-480.
- Davis, L.A.  
1968 "Gas Chromatographic Identification and Measurement of Abscisic Acid and Other Hormones in Developing Cotton Fruit." Ph D. Dissertation, University of Calif.
- Davis, L. A., and Addicott, F.T.  
1972. Abscisic acid: Correlation with abscission and with development in the cotton fruit. *Plant Physiol* 49:644-648.
- Davis, R.G.  
1977. *Fusarium* species in the internal microflora of Mississippi cottonseed. *Seed Sci & Technol* 5:587-591.
- Davis, W.J.  
1977. Stomatal responses to water stress and light in plants grown in controlled environments and in the field. *Crop Sci* 17:735-740.
- De Bary, Th ; Deltur, R.; and Bronchart, R.  
1974 Study of nucleolar vacuolation and RNA synthesis in embryonic root cells of *Zea Mays*. *J. Cell. Sci.* 19:95-112.
- Dechary, J.M., and Pradel, P.  
1971. The occurrence of (+)-gossypol in *Gossypium* species. *J. Amer. Oil Chem. Soc.* 48:563-564
- Dechary, J.M , Talluto, K.F.; Evans, W.J ; Carney, W.B.; and Altschul, A.M.  
1961.  $\alpha$ -Conarachin. *Nature* 190:1125-1126
- DeJong, T.M., and Phillips, D.A.  
1981 Nitrogen stress and apparent photosynthesis in symbiotically-grown *Pisum sativum* L. *Plant Physiol* 68:309-313.
- De la Fuente, R.K., and Leopold, A C.  
1968 Senescence processes in leaf abscission. *Plant Physiol*. 43:1496-1502.
- DeLanghe, E.  
1973. Influence of the sympodial structure of the cotton plant on the activity of plant hormones in flowering and fruiting. *Med. Fac Landb* 38:1061-1067
- DeLanghe, E., Demul, J; Marechal, R.; Raes, G.; Franssen, J., Verschraeghe, L.; and Waterkeyn, L.  
1979. Genetical, physiological and ecological influences on the structure and technological properties of cotton fibers. In "Cotton in a Competitive World " P.W. Harrison (ed.), The Textile Institute, Manchester.
- DeLanghe, E , and Eid, A A H.  
1971. Preliminary studies on the *in vitro* culture of fertilized cotton ovules. *Annales Scientifiques Textiles Belges*. 4:65-73
- DeLanghe, E ; Kosmodou-Dimitropoulou, S., and Waterkeyn, L.  
1978. Effect of hormones on nucleolar growth and vacuolation in elongating cotton fibers. *Planta* 140:269-273
- DeLanghe, E., and Vermeulen, J  
1972. Evolution of abscisic acid in the tissues of a cotton boll. *Meded. Fak. Landbouwwetensch. Gent*. 37 634-640.
- Delmer, D.P.  
1976. The biosynthesis of cellulose and other plant cell wall polysaccharides. In *Recent advances in Phytochemistry* Vol. 11, Chap. 2, pp 45-76. Frank A. Loewus and V C. Runeckless (eds ), (Plenum press, N.J.).
- Delmer, D P.; Beasley, C.A.; and Ordın, L.  
1974. Utilization of nucleoside diphosphate glucoses in developing cotton fibers. *Plant Physiol*. 53:149-153

- Delmer, D.P.; Heiniger, U.; and Kulow, C.  
1977. UDP-glucose. Glucan Synthetase in Developing Cotton Fibers. I. Kinetic and physiological properties. *Plant Physiol.* 59:713-718.
- Delouche, J.C.  
1969. Planting seed quality. *Proc. Beltwide Cotton Prod. Mech. Conf.* 1969:16-18.
- Delouche, J.C.  
1974. Maintaining soybean seed quality. *In Soybean: Production, Marketing, and Use.* NFDC, TVA, Muscle Shoals., Alabama, Bull. Y-69:46-62.
- Delouche, J.C.  
1976. Standardization of vigor tests. *Jour. Seed Tech.* 1:75-85.
- Delouche, J.C., and Baskin, C.C.  
1970. Vigor determines performance of cottonseed. *Cotton International.* 37th Annual Ed pp. 68-70
- Delouche, J.C., and Baskin, C.C.  
1973. Accelerated aging techniques for predicting the relative storability of seed lots. *Seed Sci. and Technol.* 1:427-452
- Delouche, J.C., and Caldwell, W.P.  
1960. Seed vigor and vigor tests. *Proc. Assoc. Off. Seed Anal.* 50:124-129.
- Delouche, J.C.; Stull, T.C.; Raspet, M.; and Lienhard, M.  
1962. The tetrazolium test for seed viability. *Miss. Ag. & Forestry Exp. Sta. Tech. Bull.* 51. pp 63.
- Deltour, R., and Bronchant, R.  
1971. Changements de l'ultrastructure des cellules radicales de *Zea mays* au debut de la germination. *Planta* 97:197.
- Derman, E.; Krauter, K.; Walling, L.; Weinberger, C.; Ray, M.; and Darnell, J.E., Jr.  
1981. Transcriptional control in the production of liver specific mRNAs. *Cell* 23:731-739.
- De Silva, W.H.  
1971. Some effects of the growth retardant chemical CCC on cotton in Uganda. *Cotton Grow. Rev.* 48:131-135.
- de Villis, J., Shannon, L.M.; and Yew, J.Y.  
1963. Malonic acid biosynthesis in bush bean roots. I. Evidence for oxalacetate as immediate precursor. *Plant Physiol.* 38:686-690.
- de Wit, C.T.  
1958. Transpiration and crop yields. *Ag. Res. Rep. Wageningen* 64:1-88.
- de Wit, C.T.  
1978. *Simulation of Assimilation, Respiration and Transpiration of Crops.* Halsted Press, New York
- Dewez, J.  
1964. Water uptake and heat evolution by germinating cotton seed. *Plant Physiol.* 39:240-244.
- Dzawan, K.; Bassi, P.; and Spencer, M.  
1981. Effects of carbon dioxide on ethylene production and action in intact sunflower plants. *Plant Physiol.* 68:831-834.
- Dhindsa, R.S.  
1978a. Hormonal regulation of cotton ovule and fiber growth: Effects of bromodeoxyuridine, AMO-1618, and p-chlorophenoxyisobutyric acid. *Planta* 141:269-272.
- Dhindsa, R.S.  
1978b. Hormonal regulation of enzymes of nonautotrophic CO<sub>2</sub> fixation in unfertilized cotton ovules. *Z. Pflanzenphysiol. Bd.* 89:355-362.
- Dhindsa, R.S.; Beasley, C.A.; and Ting, I.P.  
1975. Osmoregulation in cotton fiber. Accumulation of potassium and malate during growth. *Plant Physiol.* 56:394-398.
- Dhindsa, R.S.; Beasley, C.A.; and Ting, I.P.  
1976. Effect of abscisic acid on *in vitro* growth of cotton fiber. *Planta* 130:197-201.

- Dieckert, J.W.; and Dieckert, M.C.  
1976a. Production of vacuolar protein deposits in developing seeds and seed protein homology. *In* Genetic Improvement of Seed Proteins, pp. 18-51. National Academy of Science, Washington, D.C.
- Dieckert, J.W., and Dieckert, M.C.  
1976b. The chemistry and cell biology of the vacuolar proteins of seeds. *J. Food Sci.* 41:475-482
- Dieckert, J.W., and Dieckert, M.C.  
1978. The comparative anatomy of the principal reserve proteins of seeds. *In* D. Muntz, (ed.), Seed Proteins of Dicotyledonous Plants, pp. 73-86. Abhandlungen der Akademie der Wissenschaften der DDR. Abt. Mathematic-Naturwissenschaften-Technik, Akademie of Sciences, GDR, Gatersleben, German Democratic Republic.
- Dilday, R.H., and Shaver, T.N.  
1976a. Survey of the regional *Gossypium hirsutum* L. primitive race collection for flowerbud gossypol. USDA Publ. ARS-S-80. pp. 7.
- Dilday, R.H., and Shaver, T.N.  
1976b. Survey of the regional *Gossypium hirsutum* L. primitive race collection for flowerbud gossypol and seasonal variation between years in gossypol percentage. USDA Publ. ARS-S-146 pp. 6.
- Dilday, R.H., and Shaver, T.N.  
1980. Variability in flower-bud gossypol content and agronomic and fiber properties within the primitive race collection of cotton. *Crop Sci.* 20:91-95
- Dilday, R.H., and Shaver, T.N.  
1981. Seasonal variation in flowerbud gossypol content in cotton. *Crop Sci.* 21:956-960.
- Dlouhá, V.; Keil, B.; and Sorm, F.  
1963. Structure of the peptides isolated from the tryptic hydrolysate of the A chain of edestin. *Coll. Czech. Chem. Commun.* 29:1835-1850
- Doolan, J.; Gilbert, R.D.; and Fornes, R.E.  
1982. Quantitative analyses of scopoletin and lacinilene C 7-methyl ether in cotton leaves and bracts by HPLC. *Proc. Sixth Cotton Dust Res. Conf.* pp. 42-46
- Dorffling, K.; Streich, J.; Kruse, W., and Muxfeldt, B.  
1977. Abscisic acid and the after-effect of water stress on stomatal opening potential. *Z. Pflanzenphysiol.* 81:43-56.
- Dorffling, K.; Tietz, D.; Streich, J., and Ludewig, M.  
1980. Studies on the role of abscisic acid in stomatal movement. *In* F. Skoog (ed.), *Plant Growth Substances*, 1979, pp. 274-285. Springer-Verlag, Berlin, Heidelberg, New York.
- Dornhoff, G.M., and Shibles, R.  
1976. Leaf morphology and anatomy in relation to CO<sub>2</sub> exchange rate of soybean leaves. *Crop Sci.* 16:377-381.
- Douglas, A.G., Brooks, O.L.; and Perry, C.E.  
1967. Influence of mechanical harvester damage on cotton seed germination and seedling vigor. *Proc. Beltwide Cotton Prod. Res. Conf.* 1967:129-134.
- Douglas, A.G.; Brooks, O.L.; and Winstead, E.E.  
1965. Effect of mechanical harvester damage on germination and vigor of cotton seed. *Proc. Assoc. Off. Seed Anal.* 55:97-103.
- Downs, R.J.  
1975. *Controlled environments for plant research*. Columbia University Press, New York. pp. 449.
- Downs, R.J., and Hellmers, H.  
1975. *Environment and the Experimental Control of Plant Growth*. Acad. Press, New York. pp. 145.
- Downton, W.J.S.; Bjorkman, O., and Pike, C.  
1981. Consequences of increased atmospheric concentrations of carbon dioxide for growth and photosynthesis of higher plants. *In* G.I. Pearman (ed.), *Carbon Dioxide and Climate: Australian Research*, pp. 143-151. Australian Academy of Science, Canberra, Australia.

- Drake, B., and Raschke, K.  
1974. Prechilling of *Xanthium strumarium* L. reduces net photosynthesis and, independently, stomatal conductance, while sensitizing the stomata to CO<sub>2</sub>. *Plant Physiol.* 53:808-812.
- Dransfield, M.  
1961. Some effects of gibberellic acid on cotton. *Empire Cotton Growing Rev.* XXXVIII:3-16.
- Dubbe, D.R.; Farquhar, G.D.; and Raschke, K.  
1978. Effect of abscisic acid on the gain of the feedback loop involving carbon dioxide and stomata. *Plant Physiol.* 62:413-417.
- Dube, P.A.; Stevenson, K.R.; Thurtell, G.W.; and Newmann, H.H.  
1975. Steady state resistance to water flow in corn under well watered conditions. *Can. J. Plant Sci.* 55:941-948.
- Duckett, K.E., and Goswami, B.C.  
1979. The transverse dimensions and mechanical properties of cotton fibres. In "Cotton in a Competitive World". P.W. Harrison (ed.), The Textile Institute, Manchester
- Duggar, J.F., and Cauthen, F.F.  
1911. Experiments with cotton. *Ala. Agr. Exp. Sta. Bull.* 153.
- Duggar, W.M., Jr.; Koukol, J.; and Palmer, R.L.  
1966. Physiological and biochemical effects of atmospheric oxidants on plants. *J. Air Pollut. Contr. Assoc.* 16:467-471.
- Dugger, W.M., and Palmer, R.L.  
1980. Effect of boron on the incorporation of glucose from UDP-glucose into cotton fibers grown in vitro. *Plant Physiol.* 65:266-273.
- Duncan, W.G.; McCloud, D.E.; McGraw, R.L., and Boote, K.J.  
1978. Physiological aspects of peanut yield improvement. *Crop Sci.* 18:1015-1020.
- Dunlap, A.A.  
1943. Low light intensity and cotton-boll shedding. *Science.* 98 568-569.
- Dunlap, A.A.  
1945. Fruiting and shedding of cotton in relation to light and other limiting factors. *Texas Agr. Exp. Sta. Bull. No. 677*
- Dupré, M., Jr.  
1959. Permanent set in cotton and the physical mechanism of wrinkle resistant treatments. *Text. Res. Journ.* 29:151-155.
- Durbin, M.L.; Sexton, R.; and Lewis, L.N.  
1981. The use of immunological methods to study the activity of cellulase isozymes (B 1:4 glucan 4-glucan hydrolase) in bean leaf abscission. *Plant, Cell and Env.* 4:67-73.
- Dure, L.S. III  
1975. Seed Formation. *Ann. Rev. Plant Physiol.* 26:259-278.
- Dure, L.S. III.  
1977. Stored messenger ribonucleic acid and seed germination. In A.A. Khan (ed.), *The Physiology and Biochemistry of Seed Dormancy and Germination*, pp. 335-346. Elsevier/North Holland Press.
- Dure, L., III, and Chlan, C.  
1981. Developmental biochemistry of cottonseed embryogenesis and germination XII. Purification and properties of principal storage proteins. *Plant Physiol.* 68:180-186.
- Dure, L. III, and Chlan, C.  
1985. Cotton seed storage proteins: Products of three gene families. In L. Van Vloten-Doting, G.S.P. Groot, and T.C. Hall (eds) *Molecular Form and Function of the Plant Genome*. Plenum Press, New York.
- Dure, L., III, and Galau, G.A.  
1981. Developmental biochemistry of cottonseed embryogenesis and germination XIII. Regulation of biosynthesis of principal storage proteins. *Plant Physiol.* 68:187-194.

- Dure, L., III, Galau, G.A., Chlan, C.A., and Pyle, J.B.  
1983b Developmentally regulated gene sets in cotton embryogenesis. In: Plant Molecular Biology. R.B. Goldberg, ed. A.R. Liss, Inc., N.Y., pp 331-342.
- Dure, L., III, Greenway, S.G., and Galau, G.A.  
1981. Developmental biochemistry of cottonseed embryogenesis and germination: Changing messenger ribonucleic acid populations as shown by *in vitro* and *in vivo* protein synthesis. *Biochemistry* 20:4162-4168.
- Dure, L.S., and Jensen, W.A.  
1957 The influence of gibberellic acid and indoleacetic acid on cotton embryos cultured *in vitro*. *Bot. Gaz.* 119:254-261.
- Dure, L., III; Pyle, J.B.; Chlan, C.A., Baker, J.C.; and Galau, G.A.  
1983a. Developmental biochemistry of cottonseed embryogenesis and germination XVII. Developmental expression of genes for the principle storage proteins. *Plant Mol. Biol.* 2:199-206

## E

- Easton, J.D., Haskins, F.A., Sullivan, C.Y., and van Bavel, C.H.M.  
1969. *Physiological Aspects of Crop Yield*. Amer. Soc. Agron. and Crop Sci. Soc., Madison, Wisconsin. pp. 396.
- Eaton, F.M.  
1931. Root development as related to character of growth and fruitfulness of the cotton plant. *J. Agric. Res.* 43:875-883.
- Eaton, F.M.  
1932. Boron requirements of cotton. *Soil Sci.* 34:301-305.
- Eaton, F.M.  
1944. Deficiency, toxicity, and accumulation of boron in plants. *J. Agric. Res.* 69:237-277.
- Eaton, F.M.  
1955. Physiology of the cotton plant. *Ann. Rev. Plant Physiol.* 6:299-328.
- Eaton, F.M., and Ergle, D.R.  
1948. Carbohydrate accumulation in the cotton plant at low moisture levels. *Plant Physiol.* 23:169-187.
- Eaton, F.M., and Ergle, D.R.  
1952. Fiber properties and carbohydrate and nitrogen levels of cotton plants as influenced by moisture supply and fruitfulness. *Plant Physiology* 27:541-562.
- Eaton, F.M., and Ergle, D.R.  
1953. Relationship of seasonal trends in carbohydrate and nitrogen levels and effects of girdling and spraying with sucrose and urea to the nutritional interpretations of boll shedding in cotton. *Plant Physiol.* 28:503-520.
- Eaton, F.M., and Ergle, D.R.  
1954. Effects of shade and partial defoliation on carbohydrate levels and the growth, fruiting, and fiber properties of cotton plants. *Plant Physiol.* 29:39-49.
- Eaton, F.M., and Joham, H.E.  
1944. Sugar movement to roots, mineral uptake, and the growth cycle of the cotton plant. *Plant Physiol.* 19:507-518.
- Eaton, F.M.; Lyle, E.W.; Rouse, J.T.; Pfeifferberger, G.W., and Tharp, W.H.  
1946. Effect of immaturity on characters of cotton fiber, yarn and seed. *J. Amer. Soc. Agron.* 38:1018-1033.
- Eaton, F.M., and Rigler, N.E.  
1945. Effect of light intensity, nitrogen supply, and fruiting on carbohydrate utilization by the cotton plant. *Plant Physiol.* 20:380-411.

- Egamberdiyev, A.R.; Aliev, K.A.; and Hasyrov, Yu. S.  
 1963. (The movement of the products of photosynthesis ( $C^{14}$ ) from cotton leaves into the bolls).  
 Temat. Sb. Otd. Fiziol. Biofiz. Rast., Akad. NAUK Tadzh. SSR. 4:36-41. Biol. Abstr. 1965.  
 No. 17292.
- Ehleringer, J., and Bjorkman, O.  
 1977. Quantum yields for  $CO_2$  uptake in  $C_3$  and  $C_4$  plants. Dependence on temperature,  $CO_2$  and  
 $O_2$  concentration. *Plant Physiol.* 59:86-90
- Ehlig, C.F.  
 1969. Effect of fruit load, salinity and spacing on rate of flower production and growth of cotton.  
 Proc. Beltwide Cotton Prod. Res. Conf. National Cotton Council, Memphis. pp. 103-105.
- Ehlig, C.F., and Le Mert, R.D.  
 1973. Effects of fruit load, temperature, and relative humidity on boll retention of cotton. *Crop Sci.*  
 13:168-171.
- Ehrler, W.L.; Nakayama, F.S.; and van Bavel, C.H.M.  
 1965. Cyclic changes in water balance and transpiration of cotton leaves in a steady environment  
*Physiol. Plant.* 18:766-775.
- Ehrler, W.L.; van Bavel, C.H.M.; and Nakayama, F.S.  
 1966. Transpiration, water absorption, and internal water balance of cotton plants as affected by  
 light and changes in saturation deficit. *Plant Physiol.* 41:71-74.
- Ehrman, Lee; and Parsons, P.A.  
 1976. The genetics of behavior. Sinauer Associates, Inc., Sunderland, Massachusetts.
- Eickhoff, W.D., and Willcutt, M.H.  
 1978. Guidelines—seed cotton modules. Sum Proc. West. Cotton Prod. Res. Conf., pp 53-63.
- Eid, A.A.H.; DeLanghe, E.; and Waterkeyn, L.  
 1973. *In vitro* culture of fertilized cotton ovules. I. The growth of cotton embryos. *La Cellule*  
 63:361-371.
- El-Baz, F.K.; El-Fouly, M.M.; and Salib, J.G.  
 1971. An investigation on the interaction effect of cycocel, nitrogen fertilization and spacing on  
 cotton plants. *Agrochimica* 15:351-355.
- El-Hinnawy, S.; Erian, N.S.; Shehata, F.W.; and Moawad, F.G.  
 1980. IR and NMR spectra of cotton stalk lignin. *Ain Shams Univ. Fac. Agric. Res. Bull.* 1333, pp.  
 27.
- Elissalde, M.H., Jr.; Stipanovic, R.D.; Bell, A.A.; and Elissalde, G S  
 1983. Degranulation of mast cells by terpenoid aldehydes of cotton mill dust. *Proc. Seventh Cotton  
 Dust Res. Conf.* 7:84-86.
- Elliger, C.A., Chan, B.G.; and Waiss, A C., Jr.  
 1978. Relative toxicity of minor cotton terpenoids compared to gossypol. *J. Econ. Entomol.* 71:161-  
 164.
- Ellinger, C.A.; Chan, B.G., and Waiss, A.C., Jr.  
 1980. Flavonoids as larval growth inhibitors, structural factors governing toxicity. *Naturwissens-  
 chaften* 67:358-359.
- Elliott, F.C.; Hoover, M., and Porter, W.K., Jr.  
 1968. *Advances in Production and Utilization of Quality Cotton: Principles and Practices.* Iowa  
 State University Press, Ames, Iowa pp. 532.
- Elmore, C.D.  
 1980. The paradox of no correlation between leaf photosynthetic rates and crop yield. *In* J.D.  
 Hesketh and J.W. Jones, (eds ), *Predicting Photosynthesis for Ecosystem Models.* Vol. II.  
 pp. 155-167. CRC Press, Boca Raton, Florida
- Elmore, C.D., and HacsKaylo, J.  
 1973. Some source sink relationships in the cotton plant. *Plant Physiol.* 51S:62.
- Elmore, C.D., Hesketh, J.D.; and Muramoto, H.  
 1967. A survey of rates of leaf growth, leaf aging, and leaf photosynthetic rates among and within  
 species. *J. Ariz. Acad. Sci.* 4:215-219.



- Elmore, C.D., and Leffler, H.R.  
1976. Development of cotton fruit. III. Amino acid accumulation in protein and nonprotein nitrogen fractions of cottonseed. *Crop Sci.* 16:867-871
- Elmore, C.D., and McMichael, B.L.  
1975. Growth,  $^{14}\text{C}$  uptake, and translocation by cotton bracts. pp. 54-56. *In Proc. Beltwide Cotton Prod. Res. Conf. New Orleans, La*
- Elmore, C.D., McMichael, B.L.; and Cathey, G.W.  
1978. Effects of a phosphate defoliant on cotton leaves: Water relations and free amino acids. *Crop Sci.* 18:645-648.
- El-Nockrashy, A.S.; Mostafa, H.M.; El-Fouly, M.M.; and El-Shattory, Y.  
1976. Biochemical changes in cottonseed during development and maturity. *Nahrung* 20 125-132
- El-Nockrashy, A.S.; Simmons, J.G.; and Frampton, V.L.  
1969. A chemical survey of seeds of the genus *Gossypium*. *Phytochem.* 8 1949-1958.
- El-Sharkawy, M.A., and Hesketh, J.D.  
1964. Effects of temperature and water deficit on leaf photosynthetic rates of different species. *Crop Sci.* 4:514-518
- El-Sharkawy, M.A., and Hesketh, J.D.  
1965. Photosynthesis among species in relation to characteristics of leaf anatomy and  $\text{CO}_2$  diffusion resistance. *Crop Sci.* 5:517-521.
- El-Sharkawy, M.A., Hesketh, J.D.; and Muramoto, H.  
1965. Leaf photosynthetic rates and other growth characteristics among 26 species of *Gossypium*. *Crop Sci.* 5:173-175.
- El-Zik, K.M., and Bird, L.S.  
1969. Inheritance of final seedling stand ability and related components of cotton. *Proc. Beltwide Cotton Prod. Res. Conf.* pp. 119-120.
- El-Zik, K.M., Walhood, V.T.; and Yamada, H.  
1977. Effect of management inputs on yield and fiber quality of cotton (*Gossypium hirsutum* L.) grown in different row patterns. *Agron. Abstr.* pp. 98
- Endrizzi, J.E.  
1974. Survival of seed of *Gossypium thurberi*. *Cotton Grow. Rev.* 51:35-38.
- Enoch, H.Z.  
1978a. A theory for optimization of primary production in protected cultivation. *Acta Hort.* 76:31-57.
- Enoch, H.Z.  
1978b. The role of carbon dioxide in productivity of crops under protected cultivation. *Acta Hort.* 87 125-129
- Enoch, H.Z., and Hurd, R.G.  
1977. Effect of light intensity, carbon dioxide concentration, and leaf temperature on gas exchange of spray carnation plants. *J. Exp. Bot.* 28:84-95
- Enoch, H.Z., and Hurd, R.G.  
1979. The effect of elevated  $\text{CO}_2$  concentrations in the atmosphere on plant transpiration and water use efficiency. A study with potted carnation plant. *Int. J. Biometeor.* 23:343-351.
- Enoch, H.Z.; Rylski, I.; and Samish, Y.  
1970.  $\text{CO}_2$  enrichment to cucumber, lettuce, and sweet pepper plants grown in low plastic tunnels in a subtropical climate. *Israel J. Agr. Res.* 20:63-69
- Enoch, H.Z., and Sachs, J.B.  
1978. An empirical model of  $\text{CO}_2$  exchange of a  $\text{C}_3$  plant in relation to light,  $\text{CO}_2$  concentration, and temperature. *Photosynthetica* 12:150-157.
- Enoch, H.Z.; Zieslin, N.; Biran, Y.; Halevy, A.H.; Schwarz, M.; Kesler, B.; and Shimshi, D.  
1973. Principles of  $\text{CO}_2$  nutrition research. *Acta Hort.* 32:97-118.
- Ergle, D.R.  
1936. Carbohydrate content of cotton plants at different growth periods and the influence of fertilizers. *J. Amer. Soc. Agron.* 28:775-786.

- Ergle, D.R.  
1958. Compositional factors associated with the growth response of young cotton plants to gibberellic acid. *Plant Physiol.* 33:344-346.
- Ergle, D.R., and Bird, L.S.  
1958. Preliminary experiments employing gibberellic acid as a cottonseed treatment. *Plant Dis. Reprtr.* 42:320-323.
- Ergle, D.R., and Eaton, F.M.  
1951. Sulfur nutrition of cotton. *Plant Physiol.* 26:639-654.
- Ergle, D.R., and Eaton, F.M.  
1957. Aspects of phosphorus metabolism in the cotton plant. *Plant Physiol.* 32:106-113.
- Ergle, D.R., and Guinn, G.  
1959. Phosphorus compounds of cotton embryos and their changes during germination. *Plant Physiol.* 34:476-482.
- Ergle, D.R.; Hessler, L.E.; and Adams, J.E.  
1938. Carbohydrates of the cotton plant under different seasonal conditions and fertilizer treatments. *J. Amer. Soc. Agron.* 30:951-959.
- Ergle, D.R., and McIlrath, W.J.  
1952. Response of the cotton plant to late and localized applications of maleic hydrazide. *Bot. Gaz.* 114:114-122.
- Ericson, M.C., and Chrispeels, M.J.  
1973. Isolation and characterization of glucosamine containing storage glycoproteins from the cotyledons of *Phaseolus aureus*. *Plant Physiol.* 52:98-104.
- Erwin, D.C.; Fasi, S.D.; and Kahn, R.A.  
1979. Growth retardants mitigate *Verticillium* wilt and influence yield of cotton. *Phytopath.* 69:283-287.
- Erwin, D.C.; Isom, W.H.; and Garber, M.J.  
1964. Flax seedling emergence as affected by harvester injury, fungicidal treatments and age of seed. *Crop Sci.* 4:217-219.
- Esipova, I.V.  
1959. After effects of high and low temperatures on the photosynthesis of the cotton plant. *Fiziologiya rastenii.* 6:104-106.
- Essenberg, M.; Doherty, M.D.; Hamilton, B.K.; Henning, V.T.; Cover, E.C.; McFaul, S.J.; and Johnson, W.M.  
1982. Identification and effects on *Xanthomonas campestris* pv. *malvacearum* of two phytoalexins from leaves and cotyledons of resistant cotton. *Phytopath.* 72:1349-1356.
- Evans, L.T.  
1969. *The Induction of Flowering.* Cornell University Press, Ithaca, New York. pp. 488.
- Evans, L.T.  
1975. The physiological basis of crop yield. Chapter 11. In L.T. Evans (ed.), *Crop Physiology: Some Case Histories*, pp. 327-355. Cambridge University Press, London.
- Ewing, E.C.  
1918. A study of certain environmental factors and varietal differences influencing the fruiting of cotton. *Miss. Agr. Exp. Sta. Bull.* No. 8.

## F

- Fares, Y.; Goeschl, J.D.; Magnuson, C.E.; Nelson, C.E.; Strain, B.R.; Jaeger, C.H.; and Bilpuch, E.G.  
1983. A system for studying carbon allocation in plants using <sup>14</sup>C-labeled carbon dioxide. *Radiocarbon.* 25:429-439.
- Farmer, J.B.; and Chandler, S.E.  
1902. On the influence of carbon dioxide in the air on the form and internal structure of plants. *Proc. Roy. Soc. Lond.* 70:413-423.

- Farquhar, G.D., and Cowan, I.R.  
1974 Oscillations in stomatal conductance *Plant Physiol.* 54:769-772
- Farquhar, G.D.; Dubbe, D.R.; and Raschke, K.  
1978. Gain of the feedback loop involving carbon dioxide and stomata Theory and measurement. *Plant Physiol.* 62:406-412.
- Farquhar, G.D., and Sharkey, T.D.  
1982. Stomatal conductance and photosynthesis. *Ann. Rev. Plant Physiol.* 33 317-345
- Farquhar, G.D., von Caemmerer, S.; and Berry, J.A  
1980 A biochemical model of photosynthetic CO<sub>2</sub> assimilation in leaves of C<sub>3</sub> species. *Planta* 149:78-90.
- Farr, W.K.  
1931. Cotton Fibers I Origin and early stages of elongation *Contr. Boyce Thompson Inst.* 3:441-458
- Farr, W.K  
1933. Cotton fibers III Cell divisions in the epidermal layer of the ovule subsequent to fertilization. *Contr. Boyce Thompson Inst.* 5:167-172
- Feaster, C.V., Briggs, R.E., and Turcotte, E.L.  
1980. Pima cultivar responses to Pix. *Proc. Beltwide Cotton Prod. Res. Conf.* pp 81
- Feder, H., and O'Brien, T.P.  
1968. Plant microtechnique: Some principles and new methods. *Amer. J. Bot.* 55 123-142.
- Fenton, R.A ; Mansfield, T.A , and Jarvis, R.G.  
1982. Evaluation of the possibilities for modifying stomatal movement *In* J.S McLaren (ed.), *Chemical Manipulation of Crop Growth and Development.* pp. 19-37 Butterworth's, London
- Ferguson, C.H.R., and Simon, E.W.  
1973 Membrane lipids in senescing green tissues. *J. Exp. Bot.* 24 307-316
- Ferguson, D., and Turner, J.H.  
1971. Influence of unfilled cotton seed upon emergence and vigor. *Crop Sci.* 11:713-715.
- Finer, J.J., and Smith, R.H.  
1982. Isolation and culture of protoplasts from cotton (*Gossypium klotzschianum* Anders.) callus cultures. *Plant Sci. Lett.* 26:147-151.
- Finley, I.; Oliver, A D; and Sloan, L.W.  
1964. Effect of planting date, time of fruiting and use of insecticides on yield and fiber quality of cotton Louisiana Agr Exp. Sta. Bull. 584.
- Finn, G.A., and Brun, W.A.  
1982. Effect of atmospheric CO<sub>2</sub> enrichment on growth, nonstructural carbohydrate content, and root-nodule activity in soybean. *Plant Physiol.* 69:327-331.
- Fiori, L.A.; Louis, G L, and Sands, J.E.  
1959. Blending cottons differing widely in maturity I Effect on properties of single yarns *Text. Res. Journ.* 29:706-716.
- Fiori, L.A.; Sands, J.E ; Louis, G.L ; and Tallant, J.D.  
1961 Cotton fiber weight distribution (4) *Text. Res. Journ.* 31:178-180.
- Fischer, R.A., and I. Aguilar, M.  
1976. Yield potential in a dwarf spring wheat and the effect of carbon dioxide fertilization. *Agron. J.* 68 749-752
- Fisher, C.E., and Burnett, E.  
1953 Conservation and utilization of soil moisture *Texas Agr. Exp. Sta. Bull.* 767.
- Fisher, D.B.; Jensen, W A ; and Ashton, M.E.  
1968. Histochemical studies of pollen: Storage pockets in the endoplasmic reticulum (ER). *Histochemie* 13:169-182.
- Fisher, R.A.  
1970. "After-Effect of Water Stress on Stomatal Opening Potential" *J. of Exp. Botany* 21:386-404.

- Fisher, W.D.  
1973. Association of temperature and boll set. Proc. Beltwide Cotton Prod. Res. Conf. pp. 72-73.
- Fisher, W.D.  
1975. Heat induced sterility in upland cotton. Proc. Beltwide Cotton Prod. Res. Conf. pp. 85.
- Flaconer, D.S.  
1960. Introduction to quantitative genetics. The Ronald Press Co., New York.
- Follin, J.C.  
1973. Remarkable action of two growth regulators—BAS 0660W and BAS 0640W—on the cotton plant. *Coton et Fibres Trop.*, Eng. Ed. 29:449-451.
- Ford, M.A., and Thorne, G.N.  
1967. Effect of CO<sub>2</sub> concentration on growth of sugar-beet, barley, kale, and maize. *Ann. Bot.* 31:629-644.
- Ford, R.F., and Waddle, B.A.  
1970. The use of commercial Accelerate and DEF as an aid in defoliation. Proc. Beltwide Cotton Prod. Res. Conf. pp. 38.
- Fowler, J.L.  
1979. Laboratory and field response of pre-conditioned upland cottonseed to minimal germination temperatures. *Argon. J.* 71:223-228.
- Franks, G.N., and Oglesbee, J.C., Jr.  
1957. Handling cotton planting seed at cotton gins. USDA Prod. Res. Report No. 7. pp. 14.
- Fransen, T., and Verschraeghe, L.  
1967. A study of the reversal phenomenon in the fibrillar structure of the cotton fibre. *Annales scientifiques Belges*. n° 3.40-69.
- Fransen, T. and Verschraeghe, L.  
1985. Short Fibres of Cotton Seed in Cotton Bales and Card Lint, and their Influence on Spinnability. In: International Institute of Cotton Cotton Fibres: Their Development and Properties. pp. 5-7. International Institute for Cotton, Manchester, UK.
- Frear, D.S., and Swanson, H.R.  
1975. Metabolism of cisanilide (cis-2,5-dimethyl-1-pyrrolidinedicarboxanilide) by excised leaves and cell suspension cultures of carrot and cotton. *Pest Biochem. Physiol.* 5:73-80.
- Freeman, D.W.; Kadan, R.S.; Ziegler, G.M.; and Spadaro, J.J.  
1979. Processing factors affecting air classification of defatted cottonseed flour for production of edible protein products. *Cereal Chem.* 56:452-454.
- Frevert, J., Koller, W.; and Kindl, H.  
1980. Occurrence and biosynthesis of glyoxysomal enzymes in ripening cucumber seeds. *Hoppe-Seyler's Z. Physiol. Chem.* 361:1557-1565.
- Freytag, A.H., and Coleman, E.A.  
1973. Effect on multiple applications of 2,3,5-triiodobenzoic acid (TIBA) on yield of stormproof and nonstormproof cotton. *Agron. J.* 65:610-612.
- Frey-Wyssling, A., and Muhlethaler, K.  
1965. *Ultrastructural Plant Cytology*. Elsevier Publishing Co. New York.
- Friedrich, J.W., and Huffaker, R.C.  
1980. "Photosynthesis, Leaf Resistances, and Ribulose-1,5-bisphosphate Carboxylase Degradation in Senescing Barley Leaves." *Plant Physiol.* 65:1103-1107.
- Fry, K.E.  
1970. Some factors affecting the Hill reaction activity in cotton chloroplasts. *Plant Physiol.* 45:465-469.
- Fry, K.E.  
1972. Inhibition of ferricyanide reduction in chloroplasts prepared from water-stressed cotton leaves. *Crop Sci.* 12:698-701.
- Fry, K.E.  
1980. Light interception and leaf area in the cotton canopy. University of Arizona Cotton Report. pp. 80-81.

- Fry, K.E.  
1983. Heat unit calculations in cotton crop and insect models USDA, ARS, Adv. Agric. Tech., AAT-W-23, pp 23
- Frydrych, J.  
1976. Photosynthetic characteristics of cucumber seedlings grown under two levels of carbon dioxide. *Photosynthetica* 10:335-338.
- Fryxell, P.A.  
1963 Morphology of the base of seed hairs of *Gossypium*. I Gross Morphology *Bot. Gaz.* 124:196-199.
- Fryxell, P.A.  
1964. Morphology of the base of seed hairs of *Gossypium* II. Comparative morphology. *Bot. Gaz.* 125:108-114.
- Fryxell, P.A.  
1965 Stages in the evolution of *Gossypium* *Advanc Frontiers Plant Sci* 10 31-56
- Fryxell, P.A.  
1979 The Natural History of the Cotton Tribe. Texas A&M University Press, College Station and London. xviii + pp. 245.
- Fulton, N.D.; Bollenbacher, K.; and Moore, B.J.  
1960. A chlorosis of cotton seedlings caused by *Alternaria tenuis*. *Phytopath* 50:575
- Funsch, R.W., Mattson, R.H., and Mowry, G.W.  
1970 CO<sub>2</sub>-supplemented atmosphere increases growth of *Pinus strobus* seedlings *Forest Sci.* 16:459-460.

## G

- Gaastra, P.  
1959. Photosynthesis of crop plants as influenced by light, carbon dioxide, temperature, and stomatal diffusion resistances *Meded. Landbouwhogeschool Wageningen*. 59:1-68.
- Gaastra, P.  
1963. Climatic control of photosynthesis and respiration. *In* L.T. Evans (ed.), *Environmental Control of Plant Growth*, pp 113-140. Acad. Press, New York
- Gaastra, P.  
1966 Some physiological aspects of CO<sub>2</sub>-application in glasshouse culture *Acta. Hort.* 4:111-116
- Galan-Cano, J.; Risueno, M.C.; and Gimenez-Martin, G.  
1975 Nucleolar ultrastructure in megaspore mother cells of *Pisum sativum* L. *Cytobiologie* 10, 475.
- Galau, G.A.; Chlan, C.A.; and Dure, L., III  
1983. Developmental biochemistry of cottonseed embryogenesis and germination XVI Analysis of the principle cotton storage protein gene family with cloned cDNA probes. *Plant Mol. Biol.* 2:189-198
- Galau, G.A., and Dure, L. III  
1981. Developmental biochemistry of cottonseed embryogenesis and germination: Changing messenger ribonucleic acid populations as shown by reciprocal heterologous complementary deoxyribonucleic acid-messenger ribonucleic acid hybridization. *Biochemistry* 20:4169-4178.
- Galau, G.A.; Legocki, A.B.; Greenway, S.C.; and Dure, L.S., III  
1981. Cotton messenger RNA sequences exist in both polyadenylated and non-polyadenylated forms. *J. Biol. Chem.* 256:2551-2560
- Gale, J.; Kohl, H.C.; and Hagan, R.M.  
1967. Changes in water balance and photosynthesis of onion, bean, and cotton plants under saline conditions. *Phys. Plant.* 20:408-420.

- Gallup, W.D.  
1932. Cottonseed studies. Okla. Exp. Sta. Rep. 4, pp. 178-184.
- Galston, A.W., and Purves, W.K.  
1960. The mechanism of action of auxin. *Annu. Rev. Plant Physiol* 11:237-276.
- Garber, R.H., and Hoover, M.  
1973. A comparison of acid- and machine-dehnted cotton seed planted at two fungicide seed treatment rates. *Proc. Beltwide Cotton Prod. Res. Conf.* pp. 30.
- Gardner, B.R., and Tucker, T.C.  
1967. Nitrogen effects on cotton: I. Vegetative and fruiting characteristics. *Soil Sci. Soc. Am. Proc.* 31:780-785.
- Gardner, H.K.; Hron, R.J.; and Vix, H.L.E.  
1976. Removal of pigment glands (gossypol) from cottonseed. *Cereal Chem.* 53:549-560
- Gardner, W.R.  
1964. Relation of root distribution to water uptake and availability. *Agron. J.* 56:41-45.
- Gardner, W.R., and Ehlig, C.F.  
1962. Some observations on the movement of water to plant roots. *Agron. J.* 54 453-456.
- Garner, W.W., and Allard, H.A.  
1923. Further studies in photoperiodism, the response of the plant to relative length of day and night. *J. Agr. Res.* 23:871-920.
- Garner, W.W., Allard, H.A.; and Foubert, C.L.  
1914. Oil content of seeds as affected by the nutrition of the plant. *J. Agr. Res.* 3:227-249.
- Gates, D.M.; Strain, B.R., and Weber, J.A.  
1983. Changing atmospheric CO<sub>2</sub> concentration and plant responses. *Handbook of Plant Physiology*. Springer Verlag, Berlin.
- Geever, R.F.  
1980. The evolution of single-copy nucleotide sequences in the genome of *Gossypium hirsutum* L. Ph.D. Dissertation, University of Arizona.
- Geiger, D.R.  
1976. Effects of translocation and assimilate demand on photosynthesis. *Can. J. Bot.* 54 2337-2345.
- Gelmond, H.  
1979. A review of factors affecting seed quality distinctive to cotton seed production. *Seed Sci. and Tech.* 7:39-46.
- Gerard, C.J.  
1980. Emergence force by cotton seedlings. *Agron. J.* 72:473-476.
- Gibbs, M.  
1969. Photorespiration, Warburg effect and glycolate. *Ann. N.Y. Acad. Sci.* 168:356-368.
- Gifford, R.M.  
1977. Growth pattern, carbon dioxide exchange and dry weight distribution in wheat growing under differing photosynthetic environments. *Aust. J. Plant Physiol.* 4:99-110
- Gifford, R.M.  
1979a. Carbon dioxide and plant growth under water and light stress: Implications for balancing the global carbon budget. *Search* 10:316-318
- Gifford, R.M.  
1979b. Growth and yield of CO<sub>2</sub>-enriched wheat under water-limited conditions. *Aust. J. Plant Physiol* 6:367-378.
- Gifford, R.M.  
1980. Carbon storage by the biosphere. *In* G.J. Pearman (ed.), *Carbon Dioxide and Climate*. Australian Research, pp. 167-181. Australian Academy of Science, Canberra, Australia.
- Gifford, R.M., and Evans, L.T.  
1981. Photosynthesis, carbon partitioning and yield. *Ann. Rev. Plant Physiol.* 32:485-509.

- Gifford, R. M. and Jenkins, C. L.  
1981 Prospects of applying knowledge of photosynthesis toward improving crop production. In Govindjee (ed.), Photosynthesis-Applications to Food and Agriculture, Acad. Press, New York.
- Gilbert, R.D.; Fornes, R.E.; Wang, A., and Lee, K.S.  
1980. The isolation of cotton plant components by high performance liquid chromatography. *Tex Res. J.* 50:29-33
- Gill, H S., and Delouche, J.C  
1973 Deterioration of seed corn during storage. *Proc. Assoc. Off. Seed Anal.* 63:33-50
- Gilliland, M.G.; Bornman, C.H.; and Addicott, F.T  
1976. Ultrastructure and acid phosphatase in pedicel abscission of *Hibiscus*. *Amer. J. Bot.* 63:925-935.
- Ginzburg, C.  
1967 The relation of tannins to the differentiation of the root tissues in *Reaumuria palaestina* *Bot Gaz* 128:1-10
- Gipson, J R  
1974. Effect of temperature and methyl parathion on vegetative development and fruiting of the cotton plant *Agron. J.* 66:337-341.
- Gipson, J.R., and Joham, H.E.  
1968a Influence of night temperature on growth and development of cotton (*Gossypium hirsutum* L.) I. Fruiting and boll development *Agron. J.* 60:292-295.
- Gipson, J.R., and Joham, H.E.  
1968b Influence of night temperature on growth and development of cotton (*Gossypium hirsutum* L.) II Fiber properties. *Agron J.* 60:296-298.
- Gipson, J R., and Joham, H.E  
1969a. Influence of night temperature on growth and development of cotton (*Gossypium hirsutum* L.). III. Fiber elongation. *Crop Sci.* 9 127-129.
- Gipson, J.R., and Joham, H.E.  
1969b. Influence of night temperature on growth and development of cotton (*Gossypium hirsutum* L.). IV. Seed Quality. *Agron. J.* 61 365-367.
- Gipson, J.R., and Ray, L.L.  
1968 Fiber elongation rates in different varieties of cotton *Beltwide Cotton Prod. Res. Conf.* pp 212-217
- Gipson, J.R., and Ray, L.L.  
1969a. Fiber elongation rates in five varieties of cotton (*Gossypium hirsutum* L.) as influenced by night temperature *Crop Sci.* 9:339-341.
- Gipson, J.R., and Ray, L.L.  
1969b. Influence of night temperature on boll development and fiber properties of five varieties of cotton. *Proc. Beltwide Cotton Prod. Res. Conf.* pp. 94-96.
- Gipson, J.R., and Ray, L.L  
1970. Temperature variety interrelationships in cotton, 1. Boll and fiber development. 2. Seed development and composition. *Cotton Grow. Rev.* 47:257-271.
- Gipson, J.R., and Ray, L.L.  
1974 Response of early maturing strains to temperature stress. *Proc. Beltwide Cotton Prod. Res. Conf.* pp 36-38.
- Gipson, J R., and Ray, L.L.  
1976. The effect of temperature on certain seed and lint parameters of selected cotton cultivars *Proc. Beltwide Cotton Prod. Res. Conf.* pp. 45-46.
- Gipson, J.R., Ray, L.L.; and Flowers, C.L.  
1969. Influence of night temperatures on seed development of five varieties of cotton. *Proc. Beltwide Cotton Prod. Res. Conf.* pp. 117-118

- Glat, D.; Taylor, B.B.; and Williams, M.D.  
1982. The relationship of predictive tests for planting seed quality and field performance. Proc. Beltwide Cotton Prod. Res. Conf. 1982:65-67.
- Goldbach, E.; Goldbach, H.; Wagner, H.; and Michael, G.  
1975. Influence of N-deficiency on the abscisic acid content of sunflower plants. *Physiol. Plant.* 34 138-140
- Goldberg, R.B.; Hoschek, G.; Ditta, G.S.; and Breidenbach, R.W.  
1981a. Abundance, diversity, and regulation of mRNA sequence sets in soybean embryogenesis. *Dev. Biol.* 83:201-217.
- Goldberg, R.B.; Hoschek, G.; Ditta, G.S.; and Breidenbach, R.W.  
1981b. Developmental regulation of cloned superabundant embryo mRNAs in soybean. *Dev. Biol.* 83:218-231.
- Goodman, A.  
1955. Correlation between cloud shade and shedding in cotton. *Nature* 176:39.
- Gore, U.R.  
1932. Development of the female gametophyte and embryo in cotton. *Amer. J. Bot.* 19:795-808.
- Gore, U.R.  
1943. Delinting and treating cotton seed in Georgia. *Ga. Agr. Exp. Sta. Circular* 141. pp. 18.
- Goudriaan, J., and Ajtay, G.L.  
1979. The possible effects of increased CO<sub>2</sub> on photosynthesis. In B. Bolin, E.T. Degens, S. Kempe, and P. Ketner (eds.), *The Global Carbon Cycle, SCOPE 13*, pp. 237-249, Wiley, New York.
- Gourdriaan, J.; Ajtay, G.L.; and van Laar, H.H.  
1978. Relations between leaf resistance, CO<sub>2</sub> concentration and CO<sub>2</sub> assimilation in maize, beans, lalang grass, and sunflower. *Photosynthetica* 12:241-249.
- Gould, J., and Dugger, W.M.  
1982. Glucan biosynthesis by cotton ovule epidermal protoplasts. *Plant Physiol.* 69:26.
- Gould, J.; Palmer, R.L.; and Dugger, W.M.  
1983. Wall synthesis by subprotoplasts of cotton fibers. *Plant Physiol.* 72:73.
- Govilla, O.P., and Rao, C.H.  
1969. Studies on the *in vitro* germination and storage of cotton pollen. *J. Polymol.* 5:37-41.
- Govindjee  
1975. *Bioenergetic of Photosynthesis*. Acad. Press, N.Y.
- Grabe, D.F.  
1976. Measurement of seed vigor. *Jour. Seed Tech.* 1:18-32.
- Graecen, E.L.; Ponsana, P.; and Barley, K.P.  
1976. Resistance to water flow in the roots of cereals. In O.L. Lange, L. Kappen, and E.D. Schulze (eds.), *Water and Plant Life: Problems and Modern Approaches*, pp. 86-100. Springer-Verlag, Berlin.
- Grant, J.N., and De Gruy, I.V.  
1972. Effects of environment on cell wall structure of *Gossypium hirsutum* fibers. *Cotton Grow. Rev.* 49:359-368.
- Grant, J.N.; Ergle, C.J., Jr.; Mitcham, D.; and Powell, R.D.  
1970. Structure and properties of cotton fibers from controlled environments. *Text. Res. Journ.* 40:740-749.
- Grant, J.N., and Morlier, O.W.  
1948. Relation of specific strength of cotton fibers to fiber length and testing method. *Text. Res. Journ.* 18 481-487
- Grant, J.N.; Orr, R.S.; and Powell, R.D.  
1966. Cotton fiber structure and physical properties altered by environment. *Text. Res. J.* 36:432-440.
- Green, D.E.; Cavanah, L.E.; and Pinnell, E.L.  
1966. Effect of seed moisture content, field weathering, and combine cylinder speed on soybean seed quality. *Crop Sci.* 6:7-10.



- Green, J.A., and Minton, E.B.  
1980. Influence of mechanical damage and fungicide seed treatments on germination and stand with cottonseed. *Crop Sci.* 20:235-239
- Green, K., and Wright, R.  
1977. Field response of photosynthesis to CO<sub>2</sub> enhancement in ponderosa pine. *Ecology* 58:687-692.
- Gregg, B.R.  
1969. Association among selected physical and biological properties of gravity-graded cotton seed. Ph.D. Dissertation. Mississippi State University, Miss. State, MS pp. 199
- Gribbin, J.  
1981. The politics of carbon dioxide. *New Scientist* 9:82-84.
- Grierson, D.; Thompson, J.R.; Garcia-Mora, R.; and Slater, R.J.  
1980. Ribonucleic Acid synthesis by isolated Mung Bean nucleoli. *Z. Pflanzenphysiol. Bd.* 97. s. 437-447.
- Griffin, A.C., and McCaskill, O.L.  
1964. Storage of seed cotton in trailers. USDA ARS Prod. Res. Report No. 81. pp. 18
- Grimes, D.W., Dickens, W.L., and Anderson, W.D.  
1969. Functions for cotton (*Gossypium hirsutum* L.) production from irrigation and nitrogen fertilization variables II. Yield components and quality characteristics. *Agron. J.* 61:773-776.
- Grimes, D.W., Miller, R.J., and Dickens, W.L.  
1970. Water stress during flowering of cotton. *Calif. Agr.* 24:4-6
- Grimes, D.W.; Miller, R.J.; and Schweers, V.H.; Smith, R.B.; and Wiley, P.L.  
1972. Soil Strength Modification of Root Development and Soil Water Extraction. *California Agriculture* Nov 1972. pp 12-14
- Grimes, D.W., Miller, R.J.; and Wiley, P.L.  
1975. Cotton and corn root development in two field soils of different strength characteristics. *Agron. J.* 67:519-523.
- Grimes, D.W., and Yamada, H.  
1982. Relation of cotton growth and yield to minimum leaf water potential. *Crop Sci.* 22:134-139
- Grindley, D.N.  
1950. Changes in composition of cottonseed during development and ripening. *J. Sci. Food Agric* 5:147-151.
- Guerra, A.A., and Shaver, T.N.  
1969. Feeding stimulants from plants for larvae of the tobacco budworm and bollworm. *J. Econ Entomol.* 62:98-100
- Guilfoyle, T.J.; Lin, C.Y.; Chen, Y.M.; Nagao, R.T.; and Key, J.L.  
1975. Enhancement of soybean RNA polymerase I by auxin. *Proc. Nat'l. Acad. Sci. (U.S.)* 72:69-72
- Guinn, G.  
1967. An ultrasensitive chemical test for quantitative chromatography of sugars. *J. Chromatog.* 30:178-182.
- Guinn, G.  
1971a. Chilling injury in cotton seedlings. Changes in permeability of cotyledons. *Crop Sci.* 11:101-102
- Guinn, G.  
1971b. Changes in sugars, starch, RNA, protein, and lipid-soluble phosphate in leaves of cotton plants at low temperatures. *Crop Sci.* 11:262-265.
- Guinn, G.  
1972a. Effects of CO<sub>2</sub> level on fruiting and shedding. *Univ. Ariz. Coop. Ext. Ser. Sta. P-24.* Tucson, Ariz. pp. 79.
- Guinn, G.  
1972b. Effects of spacing and humidity on fruiting and shedding. *Univ. Ariz. Coop. Ext. Ser. Sta. P-24.* Tucson, Ariz. pp 77-78

- Guinn, G.  
1973. Effects of environment on cotton plant productivity. Univ. Ariz. Coop. Ext. Ser. Sta P-30. Tucson, Ariz. pp. 111-112.
- Guinn, G.  
1974a. Abscission of cotton floral buds and bolls as influenced by factors affecting photosynthesis and respiration. *Crop Sci.* 14:291-293.
- Guinn, G.  
1974b. Abscission, ethylene evolution, and abscisic acid content of young bolls in response to low light intensity. Proc. 28th Cotton Defoliation Physiol. Conf., pp. 40.
- Guinn, G.  
1976a. Nutritional stress and ethylene evolution by young cotton bolls. *Crop Sci.* 16:89-91.
- Guinn, G.  
1976b. Water deficit and ethylene evolution by young cotton bolls. *Plant Physiol.* 57:403-405
- Guinn, G.  
1977. Effects of some organic solvents on ethylene evolution from young cotton bolls. *Plant Physiol.* 60:446-448.
- Guinn, G.  
1979. Hormonal relations in flowering, fruiting, and cutout. *In: Cotton Physiology—A Treatise.* Proc. Beltwide Cotton Prod. Res. Conf. pp. 265-276.
- Guinn, G.  
1982a. Fruit age and changes in abscisic acid content, ethylene production, and abscission rate of cotton fruits. *Plant Physiol.* 69:349-352.
- Guinn, G.  
1982b. Causes of square and boll shedding in cotton. USDA Tech. Bull. 1672. pp. 21.
- Guinn, G., and Eidenbock, M.P.  
1982. Catechin and condensed tannin contents of leaves and bolls of cotton in relation to irrigation and boll load. *Crop Sci.* 22:614-616.
- Guinn, G.; Hesketh, J.D.; Fry, K.E.; Mauney, J.R.; and Radin, J.W.  
1976. Evidence that photosynthesis limits yield of cotton. Proc. 30th Cotton Physiol. Conf., pp. 60-61.
- Guinn, G., and Hunter, R.E.  
1968. Root temperature and carbohydrate status of young cotton plants. *Crop Sci.* 8:67-70
- Guinn, G.; Jordan, K.; Eidenbock, M.; and Pinter, P.  
1978. Bloom production, ethylene evolution, and boll abscission as affected by water deficit. Proc. 32nd Cotton Physiol. Conf., pp. 53.
- Guinn, G., and Mauney, J.R.  
1980. Analysis of CO<sub>2</sub> exchange assumptions. Feedback control. *In* J.D. Hesketh and J.W. Jones (eds), *Predicting Photosynthesis for Ecosystem Models*, Vol. II, pp. 1-16. CRC Press, Boca Raton, Florida.
- Guinn, G.; Mauney, J.R.; and Fry, K.E.  
1981. Irrigation scheduling and plant population effects on growth, bloom rates, boll abscission, and yield of cotton. *Agron. J.* 73:529-534.
- Guinn, G., and Mauney, J.R.  
1984a. Fruiting of cotton I. Effects of moisture status on flowering. *Agron. J.* 76:90-94.
- Guinn, G., and Mauney, J.R.  
1984b. Fruiting of cotton I. Effects of moisture status in boll retention. *Crop Sci. Agron. J.* 76:94-98

## H

- Hacskaylo, J., and Scales, A.L.  
1959. Some effects of Guthion alone and in combination with DDT and of Dieldrin-DDT mixture on growth and fruiting of the cotton plant. *J. Econ. Entomol.* 52:396-398.

- Halevy, A H.  
1972. Phytohormones in flowering regulation of self-inductive plants. Proc Int Hort. Congr 5:187-198.
- Hall, W C.  
1958. Physiology and biochemistry of abscission in the cotton plant. Texas Agr. Exp Sta. MP 285. pp. 23.
- Hall, W.C., and Morgan, P W.  
1964. Auxin-ethylene interrelationships, pp 727-745. *In* Régulateurs Naturels de la Croissance Vegetale, J.P Nitsch (ed.), Centre National de la Recherche Scientifique, Paris
- Hall, W C., Truchelut, G.B.; Leinweber, C.L.; and Herrero, F.A.  
1957. Ethylene production by the cotton plant and its effects under experimental and field conditions. *Physiol Plant.* 10:306-317.
- Halloin, J M.  
1974. Inhibition of cottonseed germination by abscisic acid Proc. Beltwide Cotton Prod Res Conf. pp. 36
- Halloin, J.M  
1975a. Postharvest infection of cottonseed by *Rhizopus arrhizus*, *Aspergillus niger*, and *Aspergillus flavus*. *Phytopath.* 65:1229-1232.
- Halloin, J M.  
1975b. Solute loss from deteriorated cottonseed. Relationship between deterioration, seed moisture, and solute loss. *Crop Sci.* 15 11-15
- Halloin, J.M.  
1976a. Inhibition of cottonseed germination with abscisic acid and its reversal *Plant Physiol.* 57:454-455.
- Halloin, J M.  
1976b. The effect of oxygen on changes in cotton seed color and hardness during ripening. *In* Proc Beltwide Cotton Prod. Res. Conf pp 42.
- Halloin, J M.  
1977. Effects on cotton seed of immersion in acetone or methylene chloride. *Crop Sci* 17:867-869
- Halloin, J M.  
1981a. Deterioration of cottonseed during weathering and accelerated aging: The role of microorganisms Proc. Beltwide Cotton Prod. Res Conf , Jan. 4-8, 1981, New Orleans, LA pp. 29
- Halloin, J M.  
1981b. The influence of premature boll termination on cotton planting seed quality. Proc. Beltwide Cotton Prod. Res. Conf. pp 256-257.
- Halloin, J M  
1982. Localization and changes in catechin and tannins during development and ripening of cottonseed. *New Phytol.* 90:651-657
- Halloin, J.M , and Bell, A.A.  
1979. Production of nonglandular terpenoid aldehydes within diseased seeds and cotyledons of *Gossypium hirsutum* L. *Agric. Food Chem.* 27.1407-1409.
- Halloin, J M., Turner, J H ; and Hoskinson, P.E  
1978. Comparison of seed and fiber properties and yield of glanded and glandless cottons. *Crop Sci* 18:519-520.
- Halloin, J.M , and Greenblatt, G A.  
1982. Localized fluorescence of cotton boll tissues in association with resistance to infection by *Diplodia gossypina*. Proc Beltwide Cotton Prod Res Conf. pp. 46
- Hammett, J R., and Katterman, F.R.  
1975. Storage and metabolism of poly(adenylic acid)-mRNA in germinating cotton seeds. *Biochem* 14:4375-4379.
- Hancock, N.J  
1941. Relative growth rate of the main stem of the cotton plant and its relationship to yield. *J. Amer. Soc Agron.* 33.590-602

- Hancock, N.I.  
1942. Factors in the breeding of cotton for increased oil and nitrogen content. *Tenn. Agr. Exp. Sta. Cir.* 79. pp. 7.
- Hancock, N.I.  
1944. Length, fineness, and strength of cotton lint as related to heredity and environment. *J. Amer. Soc. Agron.* 35:530-536.
- Hancock, N.I.  
1949. Cotton varieties and related studies. *Univ. Tenn. Ag. Exp. Sta. Bull.* No. 211. pp. 55
- Hand, D.W., and Postlethwaite, J.D.  
1971. The response of CO<sub>2</sub> enrichment of capillary-watered single truss tomatoes at different plant densities and seasons. *J. Hort. Sci.* 46:461-470
- Hand, D.W., and Soffe, R.W.  
1971. *Light-modulated temperature control and response of greenhouse tomatoes to different CO<sub>2</sub> regimes.* *J. Hort. Sci.* 46:381-396.
- Hanny, B.W.  
1980. Gossypol, flavonoid, and condensed tannin content of cream and yellow anthers of five cotton (*Gossypium hirsutum* L.) cultivars. *J. Agric. Food Chem.* 28:504-506.
- Hanny, B.W., and Gueldner, R.C.  
1976. An investigation of the surface lipids of the glabrous cotton (*Gossypium hirsutum* L.) strain, Bayou SM1. *J. Agric. Food Chem.* 24:401-403.
- Hanny, B.W.; Meredith, W.R., Jr.; Bailey, J.C.; and Harvey, A.J.  
1978. Genetic relationships among chemical constituents in seeds, flower buds, terminals, and mature leaves of cotton. *Crop Sci.* 18:1071-1074.
- Hanny, B.W.; Meredith, W.R., Jr., and M.L. Laster  
1975. Emergence and lint yield of cotton from seeds produced under plant bug *Lygus lineolaris* infestations. *Proc. Beltwide Cotton Prod. Res. Conf.* 1975:97-98.
- Hansen, J.; Johnson, D.; Lacin, A.; Lebedeff, S.; Lee, P.; Rind, D.; and Russeli, G.  
1981. Climate impact of increasing atmospheric carbon dioxide. *Science* 213:957-966.
- Hardman, L.L., and Brun, W.A.  
1971. Effect of atmospheric carbon dioxide enrichment at different developmental stages on growth and yield of components of soybeans. *Crop Sci.* 11 886-888.
- Hardy, R.W.F.  
1978. Rate-limiting steps in biological photoproductivity, *In Proceedings of Conf on Genetic Eng. for Nitrogen Fixation.* Acad. Press, New York. pp. 369-380.
- Hardy, R.W.F., and Havelka, U.D.  
1973. Symbiotic N<sub>2</sub> fixation. Multifold enhancement by CO<sub>2</sub> enrichment of field-grown soybean. *Plant Physiol* 51:5-35.
- Hardy, R.W.F., and Havelka, U.D.  
1975. Photosynthate is a major factor limiting nitrogen fixation by field grown legumes with emphasis on soybeans, pp. 58-76. *In Contributions to the Scientific Literature, Section IV, Biology.* E.I. DuPont de Nemours, Wilmington, Del.
- Hardy, R.W.F., and Havelka, U.D.  
1977. Possible routes to increase the conversion of solar energy to food and feed by grain legumes and cereal grains (crop production): CO<sub>2</sub> and N<sub>2</sub> fixation, foliar fertilization, and assimilate partitioning. *In A. Mitsui, S. Mayachi, A. San Pietro, and S. Tamura (eds.), Biological Solar Conversion,* Acad. Press, New York. pp 299-322
- Hare, C.L.  
1914. Studies of the chemical composition of the cottonseed. *Science* 39:363.
- Harland, S.C.  
1949. Methods and results of selection on experiments with Peruvian Tanguis cotton. II The "Mass Pedigree System" in practice. *Emp. Cotton Grow. Rev.* 26:247-255.

- Harper, L.A.  
1971. Mass and energy transfer between the atmosphere and two plant canopy types. Ph.D. Dissertation, Univ. of Georgia. pp 122.
- Harper, L.A.; Baker, D.N.; and Box, J.E., Jr.  
1973c. Fertilize the air over a field. *Crops and Soils Mag* 26:8-9.
- Harper, L.A.; Baker, D.N.; Box, J.E., Jr., and Hesketh, J.D.  
1973a. Carbon dioxide and the photosynthesis of field crops: A metered carbon dioxide release in cotton under field conditions. *Agron. J* 65:7-11.
- Harper, L.A.; Baker, D.N.; Box, J.E., Jr.; and Hesketh, J.D.  
1973b. Carbon dioxide and the photosynthesis of field crops. A tracer examination of turbulent transfer theory. *Agron. J.* 65:574-578.
- Harrington, M.T.  
1928. A chemical study of varieties of cottonseed. *Texas Agr. Exp. Sta., Bull.* 374. pp 19
- Harris, B., and Dure, L.S., III.  
1978. Developmental regulation in cotton seed germination: Polyadenylation of stored messenger RNA. *Biochemistry* 17:3250-3256.
- Harris, M J., and Heath, R.L.  
1981. Ozone sensitivity in sweet corn (*Zea mays* L.) plants: A possible relationship to water balance. *Plant Physiol* 68:885-890.
- Harrison, N.A., and Beckman, C.H.  
1982. Time/space relationships of colonization and host response in wilt-resistant and wilt-susceptible cotton (*Gossypium*) cultivars inoculated with *Verticillium dahliae* and *Fusarium oxysporum* f.sp. *vasinfectum*. *Physiol. Plant Pathol* 21:193-207.
- Harrison, G.J., and Fulton, J.H.  
1934. Storage of cotton pollen. *J. Agr. Res.* 49:891-896
- Hart, C.E.  
1970. Effect of nitrogen deficiency upon translocation of  $^{14}\text{C}$  in sugarcane. *Plant Physiol.* 46:419-422.
- Hartung, W., Heilmann, B.; and Gimmler, H.  
1981. "Do chloroplasts play a role in abscisic acid synthesis?" *Plant Sci Lett* 22:235-242.
- Havelka, U D., and Hardy, R.W.F.  
1976. Legume  $\text{N}_2$  fixation as a problem in carbon nutrition, *In* W.E. Newton and C.J. Nyman (eds), *Proc. 1st Int'l Symposium on Nitrogen Fixation*. Vol. 2. Washington State University Press, Pullman. pp. 456-475.
- Hawkins, B.S., and Peacock, H.A.  
1968. Effect on skip-row culture on agronomic and fiber properties of upland cotton (*Gossypium hirsutum* L.) varieties. *Agron. J.* 60:189-191.
- Hawkins, B.S. and Peacock, H.A.  
1973. Influence of row width and population density on yield and fiber characteristics of cotton. *Agronomy Journal* 65:47-51.
- Hawkins, B.S.; Matlock, R.L.; and Hobart, C.  
1933. Physiological factors affecting the fruiting of cotton with special reference to boll shedding. *Univ. of Arizona. Agric. Exp. Sta. Tech. Bull. No* 46. pp 361-407.
- Hawkins, R.S., and Serviss, G.H.  
1930. Development of cotton fibers in the Pima and Acala varieties. *J. Agric. Res.* 40.1017-1029.
- Hayward, H.E.  
1938. *The Structure of Economic Plants*. The MacMillan Co., New York.
- Hayward, H.E., and Wadleigh, C.H.  
1949. Plant growth on saline and alkali soils. *Adv Agron.* 1:1-38.
- Heagle, A.S.; Body, D.E.; and Heck, W.W.  
1973. An open-top field chamber to assess the impact of air pollution on plants. *J Environ Qual.* 2:365-368.

- Hearn, A.B.  
1968. Notes on *Gossypium* and *Cienfuegosia* in southern Yemen. *Cotton Grow. Rev.* 45:287-295.
- Hearn, A.B.  
1969. Growth and performance of cotton in a desert environment. Research Memoirs #77. Cotton Res. Corp., London. *J. Agric. Sci.* 73:65-97.
- Hearn, A.B.  
1972. The growth and performance of rain-grown cotton in a tropical upland environment. *J. Agric. Sci.* 79:121-145.
- Hearn, A.B.  
1975. Response of cotton to water and nitrogen in a tropical environment II. Date of last watering and rate of application of nitrogen fertilizer. *J. Agric. Sci., Camb.* 84:419-430.
- Hearn, A.B.  
1976. Response of cotton to nitrogen and water in a tropical environment III. Fibre quality. *J. Agric. Sci., Camb.* 86:257-269.
- Hearn, A.B.  
1979. Water relationships in cotton. *Outlook in Agric.* 10:159-166.
- Heath, O.V.S.  
1930. Plant development and climatic conditions Reports of Exp. Stations. Empire Cotton Corp. Reports 1930.
- Heath, O.V.S.  
1948. Studies in stomatal action. Control of stomatal movement by a reduction in the normal carbon dioxide content of the air. *Nature* 161:179-181
- Heath, O.V.S.  
1949. Carbon dioxide in the intercellular spaces of leaves during photosynthesis. *Nature* 164:822.
- Heath, O.V.S.  
1950. Studies in stomatal behaviour. V. The role of carbon dioxide in the light response of stomata. Part I. Investigation of the cause of abnormally wide stomatal opening with porometer cups. *J. Exp. Bot.* 1 29-62
- Heath, O.V.S.  
1959. Light and carbon dioxide in stomatal movements. *In* W. Ruhland (ed.), *Encyclopedia of Plant Physiology*, Vol. 17. pp. 415-464. Springer-Verlag, Berlin, New York.
- Heath, O.V.S., and Meidner, H.  
1981. Feedback processes in the opening of the leaf stomata in light. *Proc. Roy. Soc. Lond. B* 231 161-170
- Heath, O.V.S., and Milthorpe, F.L  
1950. Studies in stomatal behaviour. V. The role of carbon dioxide in the light responses of stomata. Part 2. Preliminary experiments on the interrelations of light intensity, carbon dioxide concentration and rate of air flow in controlling the movement of wheat stomata. *J. Exp. Bot.* 1:227-243.
- Heath, O.V.S., and Russell, J.  
1954. Studies in stomatal behaviour. VI An investigation of the light responses on wheat stomata with the attempted elimination of control by mesophyll. 2. Interactions with external CO<sub>2</sub> and general discussion. *J. Exp. Bot.* 5:269-292.
- Hector, J.M.  
1936. Introduction to the Botany of Field Crops. Vol. II. Non-Cereals. Central News Agency, Ltd., Johannesburg, South Africa. pp. 1127.
- Hedden, P.; MacMillan, J.; and Phinney, B.O.  
1978 The metabolism of gibberellins. *Ann Rev Plant Physiol* 29:149-191.
- Hedin, P.A.  
1976. Seasonal variations in the emission of volatiles by cotton plants growing in the field. *Environ. Entomol.* 5:1234-1238.

- Hedin, P.A.; Collum, D.H.; White, W.H.; Parrott, W.L.; Lane, H.C.; and Jenkins, J.N.  
1981. The chemical basis for resistance in cotton to *Heliothis* insects. In M. Kloza (ed.), Regulation of Insect Development and Behaviour. Part II. pp. 1071-1086. Wroclaw Technical Univ Press.
- Hedin, P.A.; Jenkins, J.N., Collum, D.H., White, W.H., and Parrott, W.L.  
1982. Multiple factors contributing to cotton plant resistance to the tobacco budworm. Proc. 183rd ACS Natl Meeting, Div. of Pesticide Chemistry. (Abstract #39).
- Hedin, P.A.; Lindig, O.H.; Sikorowski, P.P.; and Wyatt, M.  
1978. Suppressants of gut bacteria in the boll weevil from the cotton plant. J. Econ. Entomol. 71:394-396
- Hedin, P.A.; Miles, L.R., Thompson, A.C.; and Minyard, J.P.  
1968. Constituents of a cotton bud. Formulation of a boll weevil feeding stimulant mixture. J. Agric Food Chem. 16:505-513.
- Hedin, P.A., Minyard, J.P.; and Thompson, A.C.  
1967. Constituents of the cotton bud. VII. Identification of the anthocyanin as chrysanthemun. Phytochem. 6:1165-1167.
- Hedin, P.A., Thompson, A.C.; and Gueldner, R.C.  
1975a. A survey of the volatile constituents of cotton lint and waste with regard to byssinosis. J. Agric. Food Chem. 23:698-703
- Hedin, P.A.; Thompson, A.C.; and Gueldner, R.C.  
1975b. Constituents of cotton bud essential oil. Phytochem. 14:2087-2088.
- Hedin, P.A., Thompson, A.C.; and Gueldner, R.C.  
1975c. Survey of the air space volatiles of the cotton plant. Phytochem. 14:2088-2090
- Hedin, P.A.; Thompson, A.C.; Gueldner, R.C.; Rizk, A.M.; and Salma, H.S.  
1972. Malvaceae Egyptian cotton leaf essential oil. Phytochem. 11:2356-2357.
- Heen, A.  
1980. Methods for root studies of annual plants. Agric. University of Norway, Dept. of Farm Crops Rep. No. 197. 59.nr 16
- Heggestad, H.E., and Christiansen, M.N.  
1978. Variation in the response of cotton varieties to oxidant (ozone) Air Pollution 32nd Cotton Physiology Conf., pp. 40.
- Heggestad, H.E., and Christiansen, M.N.  
1982. Effects of air pollutants on cotton. In Effects of Air Pollution on Farm Commodities. Proc. Symp. Hyatt Regency Hotel, Washington, D.C., Feb. 18, 1982. pp 9-32 Izaak Walton League, Washington, D.C.
- Heggestad, H.E.; Christiansen, M.N., Craig, W.L.; and Heartley, W.H.  
1977. Effects of oxidant air pollutants on cotton in greenhouses at Beltsville, Maryland. In Air Pollution and Its Impact on Agriculture, Cottrell Centennial Symp., Calif State College, Stanislaus, Calif., Jan. 13-14, 1977. pp. 101-127. \*
- Heilman, M.D.  
1981. Interactions of nitrogen with Pix on the growth and yield of cotton. Proc. Beltwide Cotton Prod. Res. Conf., pp 47.
- Heilman, M.D.; Meredith, F.I.; and Gonzalez, C.L.  
1971. Ethylene production in the cotton plant (*Gossypium hirsutum* L.) canopy and its effect on fruit abscission. Crop Sci. 11:25-27
- Heiniger, U., and Delmer, D.P.  
1977. UDP-glucose Glucan synthetase in developing cotton fibers II. Structure of the reaction product. Plant Physiol. 59:719-723.
- Heinstein, P.  
1980. Partial purification of an elicitor of *Gossypium arboreum* phytoalexins from the fungus *Verticillium dahliae*. Planta Medica. 39:196-197.

- Heinstein, P., and El-Shagi, H.  
1981. Formation of gossypol by *Gossypium hirsutum* L. cell suspension cultures. *J. Nat. Prod.* 44:1-6.
- Heinstein, P.; Widmaier, R.; Wegner, P.; and Howe, J.  
1979. Biosynthesis of gossypol. *In* T. Swain, J.B. Harborne, and C.F. Van Sumere (eds.), *Biochemistry of Plant Phenolics*, Plenum Press. pp. 313-337.
- Heldt, H.W.  
1979. Light dependent changes of stromal H<sup>+</sup> and Mg<sup>2+</sup> concentrations controlling CO<sub>2</sub> fixation, *In* Photosynthesis II. Photosynthetic Carbon Metabolism and Related Processes. M. Gibbs and E. Latzko (eds.), *Encyclopedia of Plant Physiology*. Vol. 6. pp. 202-207. Springer-Verlag, New York.
- Heldt, H.W.; Chon, C.J.; Maronde, D.; Herold, A.; Stankovic, Z.S.; Walker, D.A.; Krominer, A.; Kirk, M.R.; and Heber, U.  
1977. Role of orthophosphate and other factors in the regulation of starch formation in leaves and isolated chloroplasts. *Plant Physiol.* 59:1146-1155.
- Helgerson, S.L., Cramer, W.A.; and Morr , D.J.  
1976. Evidence for an increase in microviscosity of plasma membranes from soybean hypocotyls induced by the plant hormone, indole-3-acetic acid. *Plant Physiol.* 58:548-551.
- Helmer, J.D.  
1965a. Field and laboratory performance of cottonseed processed by different methods. Ph.D. Dissertation. Mississippi State Univ., Miss. State, MS. pp. 88.
- Helmer, J.D.  
1965b. 1964 Mississippi cottonseed survey. *Miss. Farm Res.* 28:3.
- Helmer, J.D. and Abdel-Al, M.S.  
1965. Some aspects of seed and boll maturation in cotton. *Proc. Assoc. Off. Seed Anal.* 55:154-162.
- Helmy, H.; Joham, H.E.; and Hall, W.C.  
1960. Magnesium nutrition of American Upland and Egyptian cottons. MP-411. Texas Agric. Exp. Sta.
- Henderson, J.H.M., and Nitsch, J.P.  
1962. Effects of certain phenolic acids on the elongation of *Avena* first internodes in the presence of auxins and tryptophan. *Nature* 195:780-782.
- Hensarling, T.P.; Yatsu, L.Y.; and Jacks, T.J.  
1969. Extraction of lipids from cottonseed tissue: II. Ultrastructural effects of lipid extraction. *J. Amer. Oil Chem. Soc.* 47:224-225.
- Henson, J.E.  
1981. Changes in abscisic acid content during stomatal closure in pearl millet (*Pennisetum americanum* (L) Leeke). *Plant Sci. Lett.* 21:121-127.
- Herold, A.  
1980. Regulation of photosynthesis by sink activity—the missing link. *New Phytol.* 86:131-144.
- Herold, A.; Lewis, D.H.; and Walker, D.A.  
1976. Sequestration of cytoplasmic orthophosphate by mannose and its differential effect on photosynthetic starch synthesis in C<sub>3</sub> and C<sub>4</sub> species. *New Phytol.* 76:397-407.
- Hesketh, J.D.  
1963. Limitations to photosynthesis responsible for differences among species. *Crop Sci.* 3:493-496.
- Hesketh, J.D.  
1967. Enhancement of photosynthetic CO<sub>2</sub> assimilation in the absence of oxygen as dependent upon species and temperature. *Planta* 76:371-374.
- Hesketh, J.D.  
1968. Effects of light and temperature during plant growth on subsequent leaf CO<sub>2</sub> assimilation rates under standard conditions. *Aust. J. Biol. Sci.* 21:235-241.
- Hesketh, J.D., and Baker, D.N.  
1967. Light and carbon assimilation by plant communities. *Crop Sci.* 7:285-293.



- Hesketh, J.D.; Baker, D.N ; and Duncan, W.G.  
1971. Simulation of growth and yield of cotton: Respiration and the carbon balance. *Crop Sci.* 11:394-398.
- Hesketh, J.D , Baker, D.N ; and Duncan, W.G.  
1972a. Simulation of growth and yield in cotton. II. Environmental control of morphogenesis. *Crop Sci* 12.436-439
- Hesketh, J.D.; Fry, K.E., Guinn, G ; and Mauney, J.R.  
1972b. Experimental aspects of growth modeling: Potential carbohydrate requirement of cotton bolls. *In* C. Murphy *et al.* (eds ), *Modeling the Growth of Trees, Proc. of a Workshop on Tree Growth Dynamics and Modeling*, Duke Univ., Oct. 12, 1971. pp. 123-127.
- Hesketh, J.D., and Hellmers, H.  
1973. Floral initiation in four plant species growing in CO<sub>2</sub> enriched air. *Environ. Control in Biol.* 11.51-53.
- Hesketh, J.D , Lane, H.C , and Thompson, A.C.  
1976. Partitioning photosynthate in a field N-trial, with emphasis on internodal wood and bark growth. *In* Proc. Beltwide Cotton Prod. Res. Conf., Las Vegas, NV. pp 61-67.
- Hesketh, J.D., and Low, A.  
1968. Effect of temperature and fiber quality of cotton varieties of diverse origin. *Emp Cotton Grow. Rev.* 45.243-257.
- Hess, D C  
1976. Prospects for glandless cottonseed. *Oil Mill Gaz.* 81:20-26.
- Hess, D.C.  
1977a. Genetic improvement of gossypol-free cotton varieties. *Cereal Foods World* 22:98-105
- Hess, D C  
1977b. Selecting for increased seed density in cotton. *Proc. Beltwide Cotton Prod. Res. Conf.* pp. 84-86.
- Hessler, L.E.  
1961. The relationship between cotton fiber development and fiber properties. *Text. Res. Journ.* 31:38-43
- Hessler, L.E.; Lane, H.C.; and Young, A.W  
1959. Cotton fiber development studies at suboptimum temperatures *Agron. J.* 51:125-128
- Hessler, L.E.; Simmons, C.R.; and Lane, H.C  
1957. The effect of temperature on the physical and chemical development of cotton fiber. *Text Res. Journ.* 27 412-416.
- Hessler, L.E.; Simpson, M.E.; and Berkley, E.E.  
1948. Degree of polymerization, spiral structure and strength of cotton fiber. *Text Res. Journ* 18:679-683.
- Heydecker, W.; Higgins, J.; and Gulliver, R.L  
1973. Accelerated germination by osmotic seed treatment. *Nature* 246:42-44
- Heydecker, W.; Higgins, J ; and Turner, Y.J.  
1975. Invigoration of seeds? *Seed Sci. and Technol.* 3:881-888
- Hibbard, R.P., and Miller, E.V.  
1928. Biochemical studies on seed viability I Measurements of conductance and reduction. *Plant Physiol.* 3:335-352
- Hicklenton, P.R., and Jolliffe, P.A.  
1978. Effects of greenhouse CO<sub>2</sub> enrichment on the yield and photosynthetic physiology of tomato plants. *Can. J. Plant Sci.* 58.801-817.
- Hicklenton, P.R., and Jolliffe, P.A  
1980a. Alterations in the physiology of CO<sub>2</sub> exchange in tomato plants grown in CO<sub>2</sub>-enriched atmospheres. *Can. J. Bot.* 58:2181-2189
- Hicklenton, P.R , and Jolliffe, P A  
1980b. Carbon dioxide and flowering in *Pharbitis nil* Choisy. *Plant Physiol.* 66 13-17

- Hill, A.C.; Pack, M.R.; Treshow, M.; Downs, R.J.; and Transtrum, L.G.  
1961. Plant injury induced by ozone. *Phytopath.* 51:356-363.
- Hill, R., and Bendall, F.  
1960. Function of the two cytochrome components in chloroplasts: A working hypothesis. *Nature* 186:136-137.
- Hillel, D., van Beek, C.G.E.M., and Talpaz, H.  
1975. A microscope-scale model of soil water uptake and salt movement to plant roots. *Soil Sci.* 120:385-399.
- Hilton, J.L.; St. John, J.B.; Christiansen, M.N.; and Norris, K.H.  
1971. Interaction of lipoidal materials and a pyridazinone inhibitor of chloroplast development. *Plant Physiol.* 48:171-177.
- Hintz, G.D., and Green, J.H.  
1954. Components of earliness in upland cotton varieties. *Agron. J.* 46:114-118
- Hiron, R.W.P., and Wright, S.T.C.  
1973. The role of endogenous abscisic acid in the response of plants to stress. *J. Exp. Bot.* 24:769-781.
- Hirs, C.H.W.  
1967. Determination of cystine as cysteic acid. *In* C.H.W. Hirs (ed.), *Methods in Enzymology* XI:59-62. Acad. Press, New York.
- Hiyama, T., and Ke, B.  
1971. A new photosynthetic pigment "P430." Its possible role as the primary electron acceptor of photosystem I. *Proc. Natl. Acad. Sci. USA* 68:1010-1013.
- Ho, L.C.  
1977. Effects of CO<sub>2</sub> enrichment on the rates of photosynthesis and translocation of tomato leaves. *Ann. Appl. Biol.* 87:191-200.
- Ho, L.C.  
1978. The regulation of carbon transport and the carbon balance of mature tomato leaves. *Ann. Bot.* 42:155-164.
- Hock, C.W.; Ramsay, R.C.; and Harris, M.  
1941. *Text Res. Journ.* 11:200 (in Kerr, 1946)
- Hoffman, G.J., and Phene, C.J.  
1971. Effect of constant salinity levels on water use efficiency of bean and cotton. *Trans. Amer. Soc. Agric. Eng.* 1103-1106.
- Hoffman, G.J., and Rawlings, S.L.  
1970. Infertility of cotton flowers at both high and low relative humidities. *Crop Sci.* 10:721-723.
- Hoffman, G.J.; Rawlins, S.L.; Garber, M.J.; and Cullen, E.M.  
1971. Water relations and growth of cotton as influenced by salinity and relative humidity. *Agron. J.* 63:822-826.
- Hoffpauir, C.L.; Petty, D.H.; and Guthrie, J.D.  
1947. Germination and free fatty acid in individual cotton seeds. *Science* 106:344.
- Hoffpauir, C.L.; Poe, S.E.; Wiles, L.U.; and Hicks, M.  
1950. Germination and free fatty acids in seed stock lots of cotton seed. *J. Amer. Oil Chem.* 9:347-348.
- Hofmann, W.C., and Taylor, B.B.  
1980. An evaluation of field weathering and late-set bolls on the quality of cotton planting seed. *Proc. Beltwide Cotton Prod. Res. Conf.* pp. 39-40.
- Hofstra, G., and Hesketh, J.D.  
1975. The effects of temperature and CO<sub>2</sub> enrichment on photosynthesis in soybean. *In* R. Marcelle (ed.), *Environmental and Biological Control of Photosynthesis*, pp. 71-80. Junk, The Hague.
- Holekamp, E.R.; Hudspeth, E.B.; and Ray, L.L.  
1960. Soil temperature—A guide to timely cotton planting. *Texas Agric. Exp. Sta. MP.* pp. 465.

- Holley, W.D.  
1970. CO<sub>2</sub> enrichment for flower production. *Trans. Amer. Soc. Agr. Eng.* 13:257-258
- Holmgren, P.; Jarvis, P.G.; and Jarvis, M.S.  
1965. Resistance to carbon dioxide and water vapor transfer in leaves of different plant species. *Physiol. Plant.* 18:557-573
- Hood, J.T., and Ensminger, L.E.  
1964. The effect of ammonium phosphate and other chemicals on the germination of cotton and wheat seeds. *Proc. Soil Sci. Soc. Am.* 28:251-253.
- Hopen, H.J., and Ries, S.K.  
1962. The mutually compensating effect of carbon dioxide concentrations and light intensities on the growth of *Cucumis sativus* L. *Proc. Amer. Soc. Hort. Sci.* 81:358-364.
- Hopkins, A.R., and More, R.F.  
1980. Thidiazuron: Effect of application on boll weevil and bollworm population densities, leaf abscission, and growth of the cotton plant. *J. Econ. Entomol.* 73:768-770.
- Hopper, N.W.  
1981. Significance and evaluation of vigor. *Proc. Beltwide Cotton Prod. Res. Conf.* 1981:312-314
- Hopper, N.W., and Hinton, H.R.  
1980. Use of electrical conductivity as a measure of cottonseed quality. *Agron. Abstr.* 1980:109
- Horowitz, H.  
1962. Influence des conditions du milieu sur la formation et la chute des organes floraux chez le cotonnier. *Coton et Fibres Trop.* 17:23-40.
- Horrocks, R.D.; Kerby, T.A.; and Buxton, D.R.  
1978. Carbon source for developing bolls in normal and superokra leaf cotton. *New Phytol.* 80:335-340.
- Horton, R.F.  
1971. Stomatal opening. The role of abscisic acid. *Can. J. Bot.* 49:583-585
- Horton, R.F., and Osborne, D.J.  
1967. Senescence, abscission and cellulase activity in *Phaseolus vulgaris*. *Nature (London)* 214:1086-1088.
- Hou, L.A.; Hill, A.C.; and Soleimani, A.  
1977. Influence of CO<sub>2</sub> on the effects of SO<sub>2</sub> and NO<sub>2</sub> on alfalfa. *Environ. Pollut.* 12:7-16
- Howell, C.R., Bell, A.A.; and Stipanovic, R.D.  
1976. Effect of aging on flavonoid content and resistance of cotton leaves to *Verticillium* wilt. *Physiol. Plant. Pathol.* 8:181-188.
- Hoyt, D.V.  
1979. An empirical determination of the heating of the earth by the carbon dioxide greenhouse effect. *Nature* 282:388-390.
- Hsi, D.C., and Reeder, H.M.  
1953. Dormancy of upland and American-Egyptian cotton seed. *Agron. J.* 45:454
- Hsiao, T.L.  
1973. Plant responses to water stress. *Ann. Rev. Plant Physiol.* 24:519-570.
- Hsu, C.L., and Stewart, J. McD.  
1976. Callus induction by (2-chloroethyl) phosphonic acid on cultured cotton ovules. *Physiol. Plant.* 36:150-153.
- Hsu, C.L., and Stewart, J. McD.  
1979. Initiation of ovular callus and growth of cells in suspension of *Gossypium arboreum* L. *Proc. Beltwide Cotton Prod. Res. Conf., Nat. Cotton Council, Memphis, TN* pp. 44.
- Hubbard, J.W.  
1931. Farm study of the cotton plant. *USDA Farmers Bull. #1661*. pp. 17
- Huber, S.C.  
1981a. Inter- and intra-specific variation in photosynthetic formation of starch and sucrose. *Z. Pflanzenphysiol.* 102:443-450.

- Huber, S.C.  
1981b. Interspecific variation in activity and regulation of leaf sucrose phosphate synthetase. *Z Pflanzenphysiol.* 102:443-450
- Huber, S.C.  
1983. The role of sucrose phosphate synthetase in partitioning of carbon in leaves. *Plant Physiol.* 71:818-821.
- Huber, S.C., and Israel, D.W.  
1982. Biochemical basis for partitioning of photosynthetically fixed carbon between starch and sucrose in soybean (*Glycine max* Merr.) leaves. *Plant Physiol.* 69:691-696
- Huber, S.C.; Kerr, P.S.; Rufty, T.R., Jr.; Rogers, H.H.; and Israel, H.H.  
1982. B. Photosynthesis and carbohydrate metabolism in soybean leaves as affected by CO<sub>2</sub> enrichment. In H.H. Rogers, G.E. Bingham, *et al.* (eds.), *Response of Vegetation to Carbon Dioxide*. Progress Report No. 009. pp. 74-103.
- Huck, M.G.  
1970. Variation in taproot elongation rate as influenced by composition of the soil air. *Agron. J.* 62:815-818.
- Hudspeth, E.B., and Jones, D.L.  
1954. Emergence and yield of cotton as affected by depth of covering seed. *Texas Agr. Exp. Sta. Prog. Report* 1688.
- Huelsen, W.A., and Brown, W.N.  
1952. Physical damage to sweet corn seed. *Ill Agr. Exp. Sta. Bull.* 561.
- Hughes, D.W., and Galau, G.A.  
1984. Addition of proteins to the cylindrical gel embedding medium for transverse molecular weight markers in two dimensional gel electrophoresis. *Anal. Biochem.* 140:320-325.
- Hughes, L.C.  
1966. Factors affecting numbers of ovules per loculus in cotton. *Emp. Cotton Grow. Rev.* 43:273-285.
- Hughes, L.C.  
1968. Motes in varieties of *Gossypium barbadense*. *Cotton Grow. Rev.* 45:266-280.
- Hulme, A.C.; Rhodes, M.J.C.; Galliard, T., and Wooltorton, L.S.C.  
1968. Metabolic changes in excised fruit tissue IV Changes occurring in discs of apple peel during the development of the respiration climacteric. *Plant Physiol.* 43:1154-1161.
- Hunter, R.E.  
1974. Inactivation of pectic enzymes by polyphenols in cotton seedlings of different ages infected with *Rhizoctonia solani*. *Physiol. Plant Pathol.* 4:151-159.
- Hunter, R.E.  
1978. Effects of catechin in culture and in cotton seedlings on the growth and polygalacturonase activity of *Rhizoctonia solani*. *Phytopath.* 68:1032-1036.
- Hunter, R.E.; Halloin, J.M.; Veech, J.A.; and Carter, W.W.  
1978a. Exudation of terpenoids by cotton roots. *Plant and Soil* 50:237-240.
- Hunter, R.E.; Halloin, J.M.; Veech, J.A.; and Carter, W.W.  
1978b. Terpenoid accumulation in hypocotyls of cotton seedlings during aging and after infection by *Phizoctoma solani*. *Phytopath.* 68:347-350.
- Hunter, R.E., and Presley, J.T.  
1963. Morphology and histology of pinched root tips of *Gossypium hirsutum* L. seedlings grown from deteriorated seeds. *Can. J. Plant. Sci.* 43:146-150.
- Hurd, R.G.  
1968. Effects of CO<sub>2</sub> enrichment on the growth of young tomato plants in low light. *Ann. Bot.* 32:531-542.
- Hutchison, J.B.  
1959. *The Application of Genetics to Cotton Improvement*. Cambridge Univ. Press. Cambridge, England.

- Hutchison, J.B.; Silow, R.A.; and Stephens, S.G.  
1947 *The Evolution of Gossypium and the Differentiation of the Cultivated Cottons*. Oxford University Press, London.
- Hutmacher, R.B., and Krieg, D.R.  
1981. Photosynthesis: Transpiration ratios in cotton. Proc. Beltwide Cotton Prod. Res. Conf. 35:52-53
- Hutmacher, R.B., and Krieg, D.R.  
1982 Stomatal and non-stomatal inhibition of photosynthesis in cotton. Proc. Beltwide Cotton Prod. Res. Conf. 36:50
- Hutton, D., and Stumpf, P.K.  
1969. Fat metabolism in higher plants. XXXVII. Characterization of the  $\beta$ -oxidation systems from maturing and germinating castor bean seeds. *Plant Physiol.* 44:508-516.
- Huwylar, H.R.; Franz, G.; and Meier, H.  
1978  $\beta$ -1, 3-glucans in the cell walls of cotton fibers (*Gossypium aboreum*). *Plant Sci. Lett.* 12:55-62
- Huwylar, H.R.; Franz, G., and Meier, H.  
1979. Changes in the composition of cotton fiber cell walls during development. *Planta* 146:635-642.
- Hyer, A.H.; Carter, L.M., Garber, R.H.; and Ferguson, D.L.  
1980. Cottonseed germination evaluation by measuring electrical conduction of seed exudate. Proc. Beltwide Cotton Prod. Res. Conf. 1980:80.

## I

- Idso, S.B.  
1980. The climatological significance of a doubling of earth's atmospheric carbon dioxide concentration. *Science* 207:1462-1463.
- Idso, S.B.  
1982. An empirical evaluation of Earth's surface air temperature response to an increase in atmospheric carbon dioxide concentration. *In* AIP Conference Proc. No. 82 "Interpretation of climate and Photochemical Models, Ozone and Temperature Measurements." R.A. Reek and J.R. Hummel (eds.), American Institute of Physics, New York, pp. 119-124.
- Idso, S.B.  
1983. Carbon dioxide and global temperature: What the data show. *J. Env. Qual.* 12:159-163.
- Ihle, J.N., and Dure, L.S., III  
1969. Synthesis of a protease in germinating cotton cotyledons catalyzed by mRNA synthesized during embryogenesis. *Biochem. Biophys. Res. Commun.* 36:705-710
- Ihle, J.N., and Dure, L.S., III  
1970. Hormonal regulation of translation inhibition requiring RNA synthesis. *Biochem. Biophys. Res. Comm.* 38:995-1001.
- Ihle, J.N., and Dure, L.S., III  
1972. The developmental biochemistry of cottonseed embryogenesis and germination. III. Regulation of the biosynthesis of enzymes utilized in germination. *J. Biol. Chem.* 247:5048-5055
- Imai, K., and Murata, Y.  
1976. Effect of carbon dioxide concentration on growth and dry matter production of crop plants. I. Effects on leaf area, dry matter, tillering, dry matter distribution ratio, and transpiration. *Proc. Crop Sci. Japan* 45:598-606.
- Imai, K., and Murata, Y.  
1977. Effect of carbon dioxide concentration on growth and dry matter production of crop plants. II. Specific and varietal differences in the response of dry matter production. *Japan J. Crop Sci.* 46:291-297.

- Imai, K., and Murata, Y.  
 1978a. Effect of carbon dioxide concentration on growth and dry matter production of crop plants. III. Relationship between CO<sub>2</sub> concentration and nitrogen nutrition in some C<sub>3</sub>- and C<sub>4</sub>-species. Japan J. Crop. Sci. 47:118-123.
- Imai, K., and Murata, Y.  
 1978b. Effect of carbon dioxide concentration on growth and dry matter production of crop plants. IV. After-effects of carbon dioxide treatments on the apparent photosynthesis, dark respiration and dry matter production. Japan J. Crop Sci. 47:330-335
- Imai, K., and Murata, Y.  
 1979a. Effect of carbon dioxide concentration on growth and dry matter production of crop plants. VI. Effect of oxygen concentration on the carbon dioxide-dry matter relationship in some C<sub>3</sub> and C<sub>4</sub> crop species. Japan J. Crop Sci. 48:58-65.
- Imai, K., and Murata, Y.  
 1979b. Effect of carbon dioxide concentration on growth and dry matter production of crop plants. VII. Influence of light intensity and temperature on the effect of carbon dioxide enrichment in some C<sub>3</sub> and C<sub>4</sub> species. Japan J. Crop Sci. 48:409-417.
- Imazu, T.; Yabuki, K.; and Oda, Y.  
 1965. The mutually compensating effect of carbon dioxide concentration and solar radiation on the growth of leaf beet. J. Ag. Meteor. 21:41-46.
- Ingram, P.; Woods, D.K.; Peterlin, A.; and Williams, J.L.  
 1974. Never-dried cotton fibers. Part I: Morphology and Transport Properties. Text. Res. Journ. 44:96-105.
- Innes, N.L.  
 1974. Genetic variability for lint quality in upland cotton. Cotton Grow. Rev. 51:85-98.
- Irvine, J.E.  
 1957. Studies on the development of ovules of *Gossypium hirsutum* and *G. klotzschianum* v. *davidsonii* and their failure in interspecific crosses. Ph D. Dissertation. Univ. Virginia.
- Isely, D.  
 1957. Vigor tests. Proc. Assoc. Off. Seed Anal. 47:176-182.
- Ishihara, K.; Ebara, H.; Hirasawa, T., and Ogura, T.  
 1978. The relationship between environmental factors and behaviour of stomata in the rice plants. VII. The relation between nitrogen content in leaf blades and stomatal aperture. Japan J. Crop Sci. 47:664-673.
- Ishihara, K.; Iida, O.; Hirasawa, T.; and Ogura, T.  
 1979a. Relationship between nitrogen content in leaf blades and photosynthetic rate of rice plants with reference to stomatal aperture and conductance. Japan J. Crop Sci. 48:543-550.
- Ishihara, K.; Kuroda, E.; Ishii, R.; and Ogura, T.  
 1979b. Relationship between nitrogen content in leaf blades and photosynthetic rate in rice plants measured with an infrared gas and analyzer and an oxygen electrode. Japan J. Crop Sci. 48:551-556.
- Isings, J.  
 1964. The influence of stress and deformation on the structure of the cotton fiber. Text. Res. Journ. 34:236-246.
- Ishy, D.  
 1950. The Cold Test for Corn. Proc. Intern. Seed Test. Assoc. 16:299-311.
- Ito, T.  
 1973. Plant growth and physiology of vegetable plants as influenced by carbon dioxide environment. Trans. Fac. Hort., Chiba Univ. 7:1-134.
- Ito, T.  
 1976. A guide to CO<sub>2</sub> fertilization for vegetable crops. Seibundo-Shinkosha, Tokyo. pp. 1-116.
- Iyengar, N.K.  
 1938. Pollen-tube studies in *Gossypium hirsutum*. J. Genet. 37:69-107

- Iyengar, R.L.N.  
1939 Variations in the measurable characters of cotton fiber I. Variation with respect to the length of the fiber. The Ind. Jnl. of Agr. Sci., IX:305-327
- Iyengar, R.L.N.  
1941a. Variation in the measurable characters of cotton fibers. II. Variation among seeds within a lock. The Ind. Jnl. of Agr. Sci. XI:703-735
- Iyengar, R.L.N.  
1941b. Variation in the measurable characters of cotton fibers III. Variation of maturity among the different regions of the seed surface The Ind. Jnl. of Agr. Sci. XI:866-875
- Iyengar, R.L.N.  
1947 Variation of fiber length in a sample of cotton The Ind. Cotton Grow. Rev. 1:179-183.
- Iyengar, R.L.N.  
1961. Cotton fiber weigh distribution (3). Text Res. Journ 31 177-178.

## J

- Jacks, T.J.; Barker, R.H., and Wiegand, O.E., Jr.  
1973. Conformations of oilseed storage proteins (globulins) determined by circular dichroism J Peptide Protein Research. 5:289-291.
- Jacks, T.J., Neucere, N.J., and McCall, E.R.  
1975. Thermally induced permutations of arachin (peanut globular protein) J. Peptide Protein Res. 7 153-157.
- Jackson, E.B., and Tilt, P.A.  
1968. Effects of irrigation intensity and nitrogen level on the performance of eight varieties of upland cotton, *Gossypium hirsutum* L. Agron. J. 60:13-17.
- Jackson, J.E., and Fadda, N.R.  
1962 Effects of gibberellic acid on the flowering and fruiting of *Gossypium barbadense*. Empire Cotton Growing Rev. XXXIX:125-130.
- Jackson, M.B., and Osborne, D.J.  
1972. Abscisic acid, auxin, and ethylene in explant abscission. J Exp Bot. 23 849-862
- Jarvis, P.G.  
1971. The estimation of resistances to carbon dioxide transfer. In Z. Sestak, J. Catsky, and P.G. Jarvis (eds.), Plant Photosynthetic Production: Manual of Methods, pp. 566-631. W. Junk. The Hague.
- Jarvis, P.G., and Mansfield, T.A.  
1980. Reduced stomatal responses to light, carbon dioxide and abscisic acid in the presence of sodium. Plant Cell and Environ. 3:279-283.
- Jasdanwala, R.T.; Singh, Y.D.; and Chinoy, J.J.  
1977 Auxin metabolism in developing cotton hairs J. Exp Bot. 28:1111-1116
- Jensen, C.O.; Sacke, W.; and Boldauski, F.A.  
1951. The reduction of triphenyl tetrazolium chloride by dehydrogenases of corn embryos Science 113:6566.
- Jensen, R.G., and Bahr, J.T.  
1977 Ribulose 1,5-biphosphate carboxylase/oxygenase. Ann. Rev. Plant Physiol. 28 379-400.
- Jensen, W.A.  
1963. Cell development during plant embryogenesis. Brookhaven Symposium in Biology. 16 179-202.
- Jensen, W.A.  
1965. The ultrastructure and composition of the egg and central cell of cotton. Amer. J. Bot 52.781-797
- Jensen, W.A.  
1968a. Cotton embryogenesis: The zygote. Planta 79.346-366.

- Jensen, W.A.  
1968b. Cotton embryogenesis: The polysome formation in the zygote. *J. Cell. Biol.* 36:403-406.
- Jensen, W.A., and Fisher, D.B.  
1967. Cotton embryogenesis: Double fertilization. *Phytomorph.* 17:261-269.
- Jensen, W.A., and Fisher, D.B.  
1968. Cotton embryogenesis: The sperm. *Protoplasma* 65:277-286.
- Jensen, W.A.; Fisher, D.B.; and Ashton, M.E.  
1968. Cotton embryogenesis: The pollen cytoplasm. *Planta* 81:206-228.
- Jensen, W.A.; Schulz, P.; and Ashton, M.E.  
1977. An ultrastructural study of early endosperm development and synergid changes in unfertilized cotton ovules. *Planta* 133:179-189.
- Joham, H.E.  
1952. Accumulation and distribution of molybdenum in the cotton plant. *Plant Physiol.* 28:275-280.
- Joham, H.E.  
1955. The calcium and potassium nutrition of cotton as influenced by sodium. *Plant Physiol.* 30:4-10.
- Joham, H.E.  
1957. Carbohydrate distribution as affected calcium deficiency in cotton. *Plant Physiol.* 32:113-117.
- Joham, H.E.  
1974. The regulation of photosynthetically fixed carbon translocation by calcium and sodium. *Proc. Cotton Defol.-Phy. Conf.* 28:35.
- Joham, H.E., and Amin, J.V.  
1965. Role of sodium in the potassium nutrition of cotton. *Soil Sci.* 99:220-226.
- Joham, H.E., and Amin, J.V.  
1967. The influence of foliar and substrate applications of manganese on cotton. *Plant and Soil* 26:369-379.
- Joham, H.E., and Johanson, L.  
1973. The effect of sodium and calcium on the translation of <sup>14</sup>C-sucrose in excised cotton roots. *Physiol. Plant.* 28:121-126.
- Joham, H.E., and Parekh, M.C.  
1970. The tolerance of two varieties of cotton to high levels of Na and Mg. *Proc. Beltwide Cotton Prod. Res. Conf., Nat'l Cotton Coun., Memphis, TN.* pp. 35.
- Joham, H.E., and Rowe, V.  
1975. Temperature and zinc interactions on cotton growth. *Agron. J.* 67:313-317.
- Johansson, N.  
1932. A field experiment with the growth of sugar-beets at different carbon dioxide content of the air. *Svensk Botanisk Tidskrift* 26:70-75.
- Johnson, B., and Wadleigh, C.H.  
1939. Certain ecological factors and the cotton plant. *Arkansas Agr. Exp. Sta., Bull.* 376.
- Johnson, B.L., and Thien M.M.  
1970. Assessment of evolutionary affinities in *Gossypium* by protein electrophoresis. *Amer. J. Bot.* 59:1081-1092.
- Johnson, J.R.  
1970. Relation of bulk density of acid delinted cottonseed to performance in laboratory and field tests. MS Thesis, Mississippi State University, Miss. State, MS. pp. 64.
- Johnson, J.R.; Baskin, C.C.; and Delouche, J.C.  
1973. Relation of bulk density of acid delinted cottonseed to field performance. *Proc. Assoc. of Off. Seed Anal.* 63:63-66.
- Johnson, P., and Shooter, E.M.  
1950. The globulins of the groundnut (*Arachis hypogaea*). I. Investigation of arachin as a dissociation system. *Biochim. Biophys. Acta* 5:361-375.



- Johnson, R.E.  
1966. Influence of leaf area on fruiting and yield of cotton. Proc. Beltwide Cotton Prod. Res. Conf. pp. 236-237.
- Johnson, R.E., and Addicott, F.T.  
1967. Boll retention in relation to leaf and boll development in cotton. Crop Sci. 7:571-574.
- Joliot, P., and Kok, B.  
1975. Oxygen evolution in photosynthesis. In Govindjee (ed.), Bioenergetics of Photosynthesis, pp. 387-412. Acad. Press, NY.
- Jolliffe, P.A., and Tregunna, E.B.  
1968. Effect of temperature, CO<sub>2</sub> concentration, and light intensity on oxygen inhibition of photosynthesis in wheat leaves. Plant Physiol. 43:902-906.
- Jones, H.G.  
1973. Moderate-term water stresses and associated changes in some photosynthetic parameters in cotton. New Phytol. 72:1095-1105.
- Jones, H.G.  
1978. How plants respond to stress. Nature 271:610.
- Jones, J.K., Jiriden, G.M., and Slayter, G.A.  
1974. Gas-acid delinting of cotton planting seed. Cotton Inc., Memphis, TN. Special Research Report. April, 1974. pp. 15.
- Jones, J.K.  
1976. New methods in seed cotton handling. In Public-Supported Cotton Research, Proc. Conf. Collab. South. Agr. Exp. Sta., New Orleans, La., April 2-3, 1973. U.S. Dept. Agr. Res. Serv. ARS-S70, pp. 31-33.
- Jones, J.K.  
1980. Acid delinting cottenseed for oil milling and cubic acid delinted hulls. Oil Mill Gaz. Sept., 1980. pp. 11-22.
- Jones, J.K., and Slater, G.A.  
1976. Dilute sulfuric acid cotton planting seed delinting process. Cotton, Inc., Memphis, TN. Agro-Industrial Rept. 3:1-26.
- Jones, J.W.; Brown, L.G.; and Hesketh, J.  
1980. COTCROP: A computer model for cotton growth and yield. In J.D. Hesketh and J.W. Jones (eds.), Predicting Photosynthesis for Ecosystem Models. Vol. II. pp. 209-241. CRC Press, Boca Raton, Florida.
- Jones, J.W.; Colwick, R.F.; Barker, G.L.; and McClendon, R.W.  
1977. Optimum time for harvesting cotton: A new concept. Am. Soc. Agric. Eng. Trans. 22:291-296.
- Jones, M.M., and Rawson, H.M.  
1979. Influence of rate of development of leaf water deficits upon photosynthesis, leaf conductance, water use efficiency, and osmotic potential in sorghum. Physiol. Plant. 45:103-111.
- Jones, P.H., Allen, L.H., Jr.; Jones, J.W.; and Valle, R.  
1985. Photosynthesis and transpiration responses of soybean canopies to short-and-long-term CO<sub>2</sub> treatments. Agron. Jour. 77:119-126.
- Jones, R.L.  
1973. Gibberellins: Their physiological role. Ann. Rev. Plant Physiol. 24:571-598.
- Joo, P.K.; Orman, B.A.; Moustafa, A.M.; and Hafsdahl, M.P.  
1980. Can leucate electroconductivity be a useful tool for corn seed emergence potential evaluation? Agron. Abstr. 1980:109.
- Jordan, E.G., and Chapman, J.M.  
1973. Nucleolar and nuclear envelope ultrastructure in relations to cell activity in discs of carrot root (*Daucus carota* L.). J. Exp. Bot. 24:197.
- Jordan, W.R.  
1970. Growth of cotton seedlings in relation to maximum daily leaf-water potential. Agron. J. 62:699-701.

- Jordan, W.R.  
1979. Influence of edaphic parameters on flowering, fruiting, and cutout. A. Role of plant water deficit. *In Cotton Physiology—A Treatise*. Proc. Beltwide Cotton Prod. Res. Conf. pp. 297-301.
- Jordan, W.R.  
1982. Water relations of cotton. *In I.D. Teare and M.M. Peets (eds.) Crop Water Relation*. Wiley Interscience, New York.
- Jordan, W.R.; Brown, K.W.; and Thomas, J.C.  
1975. Leaf age as a determinant in stomatal control of water loss from cotton during water stress. *Plant Physiol.* 56:595-599.
- Jordan, W.R.; Morgan, P.W.; and Davenport, T.L.  
1972. Water Stress enhances ethylene-mediated leaf abscission in cotton. *Plant Physiol.* 50:756-758.
- Jordan, W.R., and Ritchie, J.T.  
1971. Influence of soil water stress on evaporation, root absorption and internal water status of cotton. *Plant Physiol.* 48:783-788.
- Joshi, P.C.  
1960. *In Vitro* growth of cotton ovules. Symposium on Plant Embryology. Council of Scientific and Industrial Research, New Delhi. pp. 199-204.
- Joshi, P.C., and Johri, B.M.  
1972. *In vitro* growth of ovules of *Gossypium hirsutum*. *Phytomorph.* 22:195-209.
- Joshi, P.C., and Pundir, N.S.  
1966. Growth of ovules in the cross *Gossypium arboreum* x *G. hirsutum* *in vivo* and *in vitro*. *Indian Cotton J.* 20:23-29
- Joshi, P.C.; Wadhvani, A.M., and Johri, B.M  
1967. Morphological and embryological studies of *Gossypium* L. *Proc. Nat. Inst. Sci. India* 33:37-93.
- Justice, N; Lee, L.H.; Dick, J.B. and Christensen, M.N.  
1965. Effect of gravity separation on cotton seed. *Miss. Farm Res.* 28.No. 3.
- Justus, N.  
1965. Effect of gravity separation on cotton seed. *Miss. Agr. Exp. Sta. Inf. Sheet* 880.

## K

- Kaiser, F.E.; Gehrke, C.W.; Zumwalt, R.W.; and Kuo, K.C.  
1974. Amino acid analysis. Hydrolysis ion-exchange cleanup, derivatization, and quantitation by gas-liquid chromatography. *J. Chromatog.* 94:113-133.
- Kajimoto, G; Yoshida, H.; Shibahara, A.; and Yamashoji, S.  
1979. Changes in the composition of lipids and fatty acids in cottonseeds during maturation. *Nippon Nogeikagaku Kaishi* 53:317-320.
- Kamalay, J.C., and Goldberg, R.B.  
1983. Organ specific nuclear RNAs in tobacco. *Proc. Natl. Acad. Sci. USA.* 81:2801-2805.
- Karami, E.; Krieg, D.R.; and Quisenberry, J.E.  
1980. Water relations and carbon-14 assimilation of cotton with different leaf morphology. *Crop Sci.* 20:421-426
- Kassenbeck, P  
1970. Bilateral structure of cotton fibers as revealed by enzymatic degradation. *Text. Res. J.* 40:330-334.
- Katterman, F.R.; Williams, M.D., and Clay, W.F.  
1977. The influence of a strong reducing agent upon the initiation of callus from the germinating seedlings of *Gossypium barbadense*. *Physiol. Plant.* 40:98-100.

- Kaufman, Z.; Netzer, D.; and Barash, I.  
1981. The apparent involvement of phytoalexins in the resistance response of cotton plants to *Fusarium oxysporum* f. sp. *vasinfectum*. *Phytopath. Z.* 102:178-182.
- Kearney, T.H.  
1926. Correlations of seed, fiber, and boll characteristics in cotton. *J. Agric. Res.* 33:781-796.
- Kechagia-Michailidou, U.  
1977. Cotton fiber technological characteristics are predetermined by cytological events at anthesis. Ph.D. Dissertation.
- Keeling, C.D.  
1970. Atmospheric carbon dioxide: Long term trends (unpublished background paper for SCEP). Cited in *Man's Impact on the Global Environment*, pp. 50. Report of the Study of the Critical Environmental Problems (SCEP). MIT Press, Massachusetts. pp. 318.
- Keeling, C.D., and Bacastow, R.B.  
1977. Impact of industrial gases on climate. *In Energy and Climate: Outer Limits to Growth*, pp. 110-160. National Academy of Sciences Geophysical Research Board, Geophysical Study Committee.
- Keeling, C.D., Bacastow, R.B.; Bainbridge, A.E.; Ekdahl, C.A., Jr.; Guenther, P.R.; Waterman, L.S.; and Chin, J.F.S.  
1976. Atmospheric carbon dioxide variations at Mauna Loa Observatory. *Hawaii Tellus* 28:538-551.
- Keillogg, W.W., and Schware, R.  
1981. *Climate Change and Society: Consequences of Increasing Atmospheric Carbon Dioxide*. Westview Press, Boulder, Colorado. pp. 178.
- Kefeli, V.I., and Kutacek, M.  
1977. "Phenolic substances and their possible role in plant growth regulation" *In Plant growth regulation*, P.E. Pilet (ed.), pp. 181-188.
- Keith, G.  
1972. The challenge in producing seed quality soybeans. *In Grain Damage Symposium*, D. Byg, Chm. Ohio State University, Columbus, Ohio. pp. 53-57.
- Kelly, G.J., and Latzko, E.  
1976. Regulatory aspects of photosynthetic carbon metabolisms. *Ann. Rev. Plant Physiol.* 27:181-205.
- Kepner, R.A., and Curley, R.G.  
1976. Handling seed cotton modules without pallets. Costs of hauling from field to storage. *Calif. Agric.* 30:6-8.
- Kerby, T.A., and Buxton, D.R.  
1978. Effect of leaf shape and plant population on rate of fruiting position appearance in cotton. *Agron. J.* 70:535-538.
- Kerby, T.A.; Wilson, L.T.; and Jackson, S.  
1985. Upper thresholds required for heat unit calculations for cotton growth in the Far West. *Proc. Beltwide Cotton Res. Conf.*, Jan. 4-6, 1985 New Orleans, LA. pp. 366-368.
- Kerr, R.A.  
1977. Carbon dioxide and climate: Carbon budget still unbalanced. *Science* 197:1352-1353.
- Kerr, T.  
1937a. The structure of the growth rings in the secondary wall of cotton hairs. *Protoplasma* 27:229-240.
- Kerr, T.  
1937b. The visible structure of natural fibers. Presented at the convention of the Technical Association of the Pulp and Paper Industry at Savannah, Georgia, Oct. 18-20.
- Kerr, T.  
1946. The outer wall of the cotton fiber and its influence on fiber properties. *Text. Res. Journ.* 16:249-254.

- Khan, A.A.  
1980/81. Hormonal regulation of primary and secondary seed dormancy. *Isr. J. Bot.* 29:207-224.
- Khan, A.A.; Braun J.W.; Tao, K.L.; Miller, W.F.; and Bensin, R.F.  
1976. Methods for maintaining seed vigor and improving performance. *J. Seed Tech.* 1:33-57.
- Khasanov, M.M., and Butenko, R.G.  
1979. Cultivation of isolated protoplasts from cotyledons of cotton (*Gossypium hirsutum*) Soviet Plant Physiol. 26:77-81.
- Khaund, R.N.  
1971. A study of the separation of coconut protein isolates and of some of their physical and chemical characteristics. Dissertation. Texas A&M University, College Station, Texas.
- Kilburn, K H  
1974. Acute bronchitis due to cotton plant polyphenols. *Ann. N.Y. Acad. Sci.* 221:335-339.
- Kilburn, K.H.; Lynn, D.G., McCormick, J.P.; and Schafer, T R.  
1979. Effects of synthetic lacinlene C 7-methyl ether on hamster airways. Proc. Third Special Session on Cotton Dust Res., Beltwide Cotton Prod. Res. Conf. pp. 19-20
- Kilburn, K H; Lynn, W.S.; Tres, L.L.; and McKenzie, W.N.  
1973. Leukocyte recruitment through airway walls by condensed vegetable tannins and quercetin. *Lab. Invest.* 28:55-59.
- Kimball, B.A., and Idso, S.B.  
1982. Increasing Atmospheric CO<sub>2</sub>: Effects on Crop Yield, Water Use, and Climate. Proceedings Plant Production and Management Under Drought Conditions. Tulsa, Oklahoma, October 4-6, 1981.
- Kimball, B.A., and Mitchell, S.T  
1978. CO<sub>2</sub> enrichment of tomatoes in unventilated greenhouses in an arid climate. *Acta Hort.* 87:131-137.
- Kimball, B A , and Mitchell, S.T.  
1979. Tomato yields from CO<sub>2</sub>-enrichment in unventilated and conventionally ventilated greenhouses. *J. Amer. Soc. Hort. Sci.* 104:515-520.
- Kimball, B.A., and Mitchell, S.T  
1981. Effects of CO<sub>2</sub> enrichment, ventilation, and nutrient concentration on the flavor and vitamin content of tomato fruit. *HortSci.* 16:665-666
- Kimball, B A , and Mitchell, S.T.  
1982. Carbon dioxide and agricultural yield: An assemblage and analysis of 430 prior observation. WCL Report.
- Kindl, H.  
1982. Glyozysome biogenesis via cytoplasmic pools in cucumber. *Proc. N.Y. Acad. Sci.* 386:314-328.
- King, C.C.; Ni, T.S; Tank, Y.W.; Cheng, C.W.; Chang, C.L.; Lu, S.F.; Lui, W.Y.; and Lee, S.G.  
1956. The role of organic food substances in the boll shedding of cotton plant. *Acta Botanica Sinica* 5:101-102.
- King, C.J  
1930 Development of axillary buds on fruiting branches of Pima and upland cotton. *J. Agric. Res* 41:697-714.
- King, C.J., and Loomis, H.F.  
1932. Agricultural investigations at the U.S. Field Station, Sacaton, Arizona. 1925-1930. U.S. Dept. Agr. Cir. No. 206.
- King, E.E., and Lamlin, G.E.  
1979. Uniform quality cotton seed for laboratory and field use. Proc. Beltwide Cotton Prod. Res. Conf pp 32
- King, E.E , and Leffler, H R.  
1979. Nature and patterns of proteins during cotton seed development. *Plant Physiol.* 63:260-263.

King, R.W.

1982. Abscisic acid in seed development. *In* The Physiology and Biochemistry of Seed Development, Dormancy and Germination. A. A. Khan (ed.), Elsevier Biomedical Press, Amsterdam

Kinsinger, W.G., and Hock, C.W.

1948 Electron microscopical studies of natural cellulose fibers. *Ind. Eng. Chem.* 40:1711-1716.

Kirby, B.W., and Stelzer, L.R.

1968. Paraquat as a harvest-aid chemical: Effect on lint and seed quality. *Proc. Beltwide Cotton Prod. Res. Conf.* pp. 68.

Kirk, I.W., and McLeod, H.E.

1967 Cottonseed rupture from static load and impact velocity. *Trans. of the ASAE.* 10:217-219

Kirk, T.G., and Krieg, D.R.

1982 Source-sink relations of cotton: Carbon assimilation and partitioning. *Proc. Beltwide Cotton Prod. Res. Conf.* 36:50.

Kitamura, K., and Shibasaki, K.

1975. Isolation and some physico-chemical properties of the acidic subunits of soybean 11S globulin. *Agr. Biol. Chem.* 39:945-951.

Kittock, D.L., and Arle, H.F.

1977. Termination of late season cotton fruiting with plant growth regulators. *Crop Sci.* 17:320-324

Kittock, D.L.; Arle, H.F.; and Bariola, L.A.

1974 Current status of chemical termination of cotton fruiting. *Proc. Beltwide Cotton Prod. Res. Conf.* pp. 55-56.

Kittock, D.L.; Arle, H.F.; and Bariola, L.A.

1975 Chemical termination of cotton fruiting in Arizona in 1974. *Proc. Beltwide Cotton Prod. Res. Conf.* pp. 71

Kittock, D.L.; Arle, H.F.; Henneberry, T.J.; and Bariola, L.A.

1978. Chemical termination of late-season cotton fruiting in Arizona and California: 1972-76. *USDA Publ. ARS-W52*

Kittock, D.L.; Mauney, J.R.; Arle, H.F., and Bariola, L.A.

1973. Termination of late season cotton fruiting with growth regulators as an insect control technique. *J. Environ. Quality.* 2:405-408.

Kittock, D.L., and Pinkas, L.L.H.

1971. The effect of number of seeds per boll on some components of yield of Pima cotton. *Proc. Beltwide Cotton Prod. Res. Conf.* pp. 30.

Kittock, D.L.; Pinkas, L.L.H., and Fry, K.E.

1979 Branch node location and competition effects on yield components of Pima cotton bolls. *Proc. Beltwide Cotton Prod. Res. Conf.* pp. 53-56.

Klein, L.M., and Harmond, J.E.

1966. Effect of cylinder speed and clearance on threshing cylinders in combining crimson clover. *Trans. of the ASAE* 9:499-500, 506

Kleinkopf, G.E.; Huffaker, R.C.; and Matheson, A.

1970. Light-induced de novo synthesis of ribulose-1,5-diphosphate carboxylase in greening leaves of barley. *Plant Physiol.* 46:416-418.

Kleppler, B.T.; Huck, H.M.; and Fiscus, E.L.

1973 Water relations and growth of cotton in drying soil. *Agron. J.* 65:307-310.

Klocke, J.A., and Chan, B.G.

1982 Effects of cotton condensed tannin on feeding and digestion of the cotton pest insect, *Heliothis zea*. *J. Insect Physiol.*

Knecht, G.N.

1975 Response of radish to high CO<sub>2</sub>. *HortSci.* 10:271-275

- Knecht, G.N., and O'Leary, J.W.  
1974. Increased tomato fruit development by CO<sub>2</sub> enrichment. *J. Amer. Soc. Hort. Sci.* 99:214-216.
- Knecht, G.N., and O'Leary, J.W.  
1983. The influence of carbon dioxide on the growth, pigment, protein, carbohydrate, and mineral status of lettuce. *J. Plant Nut.* 6:301-312.
- Koehler, B.  
1957. Pericarp injuries in seed corn. *Ill. Agr. Exp. Sta. Bull.* 617.
- Kochler, D.E., and Varner, J.E.  
1971. Gibberellic acid enhanced phospholipid synthesis in aleurone layers. *Plant Physiol.* 47S:24.
- Koehler, D.E., and Varner, J.E.  
1973. Hormonal control of orthophosphate incorporation into phospholipids of barley aleurone layers. *Plant Physiol.* 52:208-214.
- Kohel, R.J.  
1978a. Breeding for cottonseed quality. *Proc. Beltwide Cotton Prod. Res. Conf.* pp. 223-225.
- Kohel, R.J.  
1978b. Survey of *Gossypium hirsutum* L. germplasm collections for seed-oil percentage and seed characteristics. USDA, ARS-S-187, pp. 38.
- Kohel, R.J.  
1980. Genetic studies of seed oil in cotton. *Crop Sci.* 20:784-789.
- Kohel, R.J., and Lewis, C.F.  
1970. Texas Marker-1: A description of a genetic standard for *Gossypium hirsutum* L. *Crop Sci.* 10:670-673.
- Kohel, R.J.; Lewis, C.F.; and Richmond, T.R.  
1965. The genetics of flowering response in cotton. V. Fruiting behavior of *Gossypium hirsutum* L. and *Gossypium barbadense* in interspecific hybrids. *Genetics* 51:601-604.
- Kohel, R.J.; Quisenberry, J.E.; and Benedict, C.R.  
1974a. Fiber elongation and dry weight changes in mutant lines of cotton. *Crop Sci.* 14:471-474.
- Kohel, R.J., and Richmond, T.R.  
1962. The genetics of flowering response in cotton. IV. Quantitative analysis of photoperiod of Texas 86, *Gossypium hirsutum* L. race *latifolium* in a cross with an inbred line of cultivated American upland cotton. *Genetics* 47:1535-1542.
- Kohel, R.J.; Richmond, T.R.; and Lewis, C.F.  
1974b. Genetics of Flowering. VI. Flowering behavior of *Gossypium hirsutum* L. and *Gossypium barbadense* L. Hybrids. *Crop Sci.* 14:696-699.
- Koli, S.E., and Morrill, L.G.  
1976. Effects of narrow row, plant population, and nitrogen application on cotton fiber characteristics. *Agron. J.* 68:794-797.
- Köller, W.; Frevert, J.; and Kindl, H.  
1979. Albumins, glyoxysomal enzymes, and globulins in dry seeds of *Cucumis sativus*: Qualitative and quantitative analysis. *Hoppe-Seyler's Physiol. Chem.* 360:167-176.
- Körner, C.H.; Scheel, J.A.; and Bauer, H.  
1979. Maximum leaf diffusive conductance in vascular plants. *Photosynthetica* 13:45-82.
- Kosmidou-Dimitropoulou, K.  
1976. Physiological identification of cotton fiber technological characteristics: Hormonal action in fiber initiation and development. Doctoral Dissertation, State University of Ghent, Belgium.
- Kosmidou-Dimitropoulou, K.  
1981. Influence of gibberellins on cotton. *In* Abstracts of Panhellenic Congress of Geotechnical Research, Halkidiki, May 5-8, 1981. pp. 18.
- Koziol, M.J., and Cowling, D.W.  
1978. Changes in carbohydrate levels in red kidney beans (*Phaseolus vulgaris* L.) exposed to sulphur dioxide. *J. Exp. Bot.* 29:1037-1043.

- Kozlowski, T.T.  
1973 *Shedding of Plant Parts* pp. 560 Acad. Press, New York
- Kramer, P.J.  
1940 Root resistance as a cause of decreased water absorption by plants at low temperature *Plant Physiol.* 15:63-79.
- Kramer, P.J.  
1959. "Transpiration and Water Economy of Plants " *In Plant Physiology V* F.C. Steward (ed.), New York
- Kramer, P.J.  
1969. *Plant and Soil Water Relationships A Modern Synthesis*. McGraw-Hill, New York
- Kramer, P.J.  
1981 Carbon dioxide concentration, photosynthesis, and dry matter production. *Bioscience* 31:29-33.
- Krause, G.H., and Heber, U.K.  
1976 Energetics of intact chloroplasts. *In* J. Barber (ed.), *The Intact Chloroplast*, pp 171-214. Elsevier Publish. Co., Amsterdam.
- Krenzer, F.G., Jr., and Moss, D.N.  
1975. Carbon dioxide enrichment effects upon yield and yield components in wheat. *Crop Sci* 15:71-74
- Kretchman, D.W.  
1969. An interim report. CO<sub>2</sub> enrichment of outdoor crops. Ohio Agr. Res. and Dev. Center, Wooster, Ohio. pp 67.
- Kretchman, D.W.  
1970 Interim report III. CO<sub>2</sub> enrichment of outdoor crops Ohio Agr. Res. and Dev. Center, Wooster, Ohio. pp. 22.
- Kretchman, D.W., and Howlett, F.S.  
1970. CO<sub>2</sub> enrichment for vegetable production. *Trans. Amer. Soc. Agr. Eng.* 13 252-256
- Kriedemann, P.E., Loveys, B.R.; and Downton, W.J.S.  
1975. Internal control of stomatal physiology and photosynthesis II Photosynthetic response to phaseic acid *Aust. J. Plant Physiol.* 2:553-567
- Kriedemann, P.E.; Loveys, B.R., Fuller, G.L., and Leopold, A.C.  
1972. Abscisic acid and stomatal regulation. *Plant Physiol.* 49 842-847.
- Kriedemann, P.E.; Loveys, B.R.; Possingham, J.V., and Satoh, M.  
1976 Sink effects on stomatal physiology and photosynthesis. *In* J.F. Wardlaw and J.B. Passioura (eds.). *Transport and Transfer Processes in Plants*, pp 401-414. Acad. Press, New York.
- Krieg, D.R.  
1981. Leaf development and function as related to water stress *Proc. Beltwide Cotton Prod. Res. Conf.* 35:41-42.
- Krieg, D.R.  
1983a. Photosynthetic activity in stressed plants. *J. Agron. Water Manage.* 7:249-263.
- Krieg, D.R.  
1983b. Whole plant response to water stress II. Carbon assimilation and utilization *In* H.M. Taylor, W.R. Jordan, and T.R. Sinclair (eds.), *Limitation to Efficient Water Use in Crop Production* pp. 319-330. Amer. Soc. Agron., Madison.
- Krieg, D.R., and Bartee, S.N.  
1975. Cotton seed density. Associated germination and emergence properties *Agron. J.* 67 343-347.
- Krieg, D.R.; Connor, J.W.; and Gipson, J.R.  
1972. The effect of controlled night temperatures on the accumulation of simple sugars in the developing cotton boll. 26th Cotton Defoliation—Physiology Conference. pp. 29-31.

- Krieg, D.R.; Gipson, J.R.; and Barnes, L.W.  
1973 The chemical composition of cotton bolls and seeds developed under controlled night temperatures. *Proc. Beltwide Cotton Prod. Res. Conf.* pp. 42-45.
- Krieg, D.R., and Sung, J.M.  
1979. *Source-sink relations of cotton as affected by water stress during boll development.* In *Cotton Physiology—A Treatise: Section I Flowering, Fruiting and Cutout.* J. McD Stewart (ed.), *Proc. Beltwide Prod. Res. Conf. Phoenix, Az.,* pp. 302-305.
- Krishnan, T.V., and Iyengar, R.L.N.  
1960. Study of the variation of fiber length within and between seeds of the same strain. *The Ind. Cotton Grow. Rev.* XIV:395-406.
- Krizek, D.T.  
1969. *Enriched environments for starting seedlings.* *Proc. 24th Amer. Hort. Cong.* pp. 12-16. Philadelphia, Pennsylvania.
- Krizek, D.T.  
1970. *Introduction Proceedings: Controlled Atmospheres for Plant Growth.* *Trans. Amer. Soc. Ag Eng* 13:237
- Krizek, D.T.  
1972. Accelerated growth of birch in controlled environments. *Proc. Intl. Plant Prop. Soc.* 22:390-395.
- Krizek, D.T.  
1974. Maximizing plant growth in controlled environments. In P. Chouard and N.deBilderling (eds.), *Phytotronics III. Phytotronics in Agricultural and Horticultural Research,* pp. 6-13. Gauthier-Villars, Paris
- Krizek, D.T.  
1979a. Carbon dioxide: Guidelines. In T.W. Tibbitts and T. T. Kozlowski (eds.), *Controlled Environment Guidelines for Plant Research.* pp. 241-269. Acad. Press, New York.
- Krizek, D.T.  
1979b. "Carbon Dioxide Enrichment." *Proc. Cotton Prod. Res. Confs.* pp. 283-290.
- Krizek, D.T.  
1982. Plant response to atmospheric stress caused by waterlogging. In M.N. Christiansen and C.F. Lewis (eds.), *Breeding Plants for Less Favorable Environments,* pp. 241-269. Wiley, New York.
- Krizek, D.T., and Ambler, J  
1979. Influence of relative humidity and type of container on the uptake of Ca, Fe, P, and Zn by cotton plants under greenhouse and growth chamber conditions. *Proc. 33rd Cotton Physiol. Conf.* pp. 53.
- Krizek, D.T.; Bailey, W.A.; and Klueter, H.H.  
1970a. A "head start" program for bedding plants through controlled environments. In W.W. Carlson (ed.), *Proceedings 3rd Natl. Bedding Plant Conf.,* pp. 43-53. East Lansing, Michigan.
- Krizek, D.T.; Bailey, W.A.; Klueter, H.H.; and Cathey, H.M.  
1968. Controlled environments for seedling production. *Proc. Intl. Plant Prop. Soc.* 18:273-280.
- Krizek, D.T.; Bailey, W.A.; Klueter, H.H.; and Liu, R.C.  
1974. Maximizing growth of vegetable seedlings in controlled environments at elevated temperature, light, and CO<sub>2</sub>. *Acta Hort.* 38:89-102.
- Krizek, D.T., and Mandava, N.B.  
1983a. Influence of spectral quality on the growth response of intact bean plants to brassinosteroid: A growth promoting steroidal lactone. I. Stem elongation and morphogenesis. *Physiol. Plant.* 57:317-323.
- Krizek, D.T., and Mandava, N.B.  
1983b. Influence of spectral quality on the growth response of intact bean plants to brassinosteroid: A growth promoting steroidal lactone. II. Chlorophyll content and partitioning of assimilate. *Physiol. Plant.* 57:324-329.



- Krizek, D.T.; Zimmerman, R.H.; Klueter, H.H., and Bailey, W.A.  
1970b. Growth and development of crabapple seedlings in controlled environments: Effects of light intensity and CO<sub>2</sub> concentration. *Plant Physiol.* 46:5-7.
- Krizek, D.T.; Zimmerman, R.H.; Klueter, H.H.; and Bailey, W.A.  
1971. Growth of crabapple seedlings in controlled environments. Effects of CO<sub>2</sub> level and time and duration of CO<sub>2</sub> treatment. *J. Amer. Soc. Hort. Sci.* 96:285-288
- Krzyzanowski, F.C.  
1980. Factors affecting the germination and emergence of cotton seed. Ph.D. Dissertation. Mississippi State University, Miss. State, MS pp. 106.
- Ku, S.B., and Edwards, G.E.  
1977. Oxygen-inhibition of photosynthesis. I. Temperature dependence and relation to O<sub>2</sub>/CO<sub>2</sub> solubility ratio. *Plant Physiol.* 59:986-990
- Kuc, J.  
1982. Plant immunization-mechanisms and practical implications. In R.K.S. Wood (ed.), *Active Defense Mechanisms in Plants*, pp. 157-178. Plenum Publ. Corp.
- Kumar, C.R., and Subramanian, D.  
1980. Studies on *Fusarium* wilt of cotton. III. Role of gossypol in disease resistance. *Phytopath.* 70:193-204
- Kunze, O.R.  
1978. Seed density: Culling by floatation. Summary Proceedings Western Cotton Production Conference, Phoenix, AZ pp. 50-54.
- Kunze, O.R.; Wilkes, L.H.; and Niles, G.A.  
1969. Field emergence and growth response related to the physical characteristics of cottonseed. *Trans. Amer. Soc. Agr. Eng.* 12:608-610, 613.
- Kuo-Fen, C., Wei-Yu, W.; Min-Yi, T.; and Peng-Ti, C.  
1980. Endometrial changes after administration of gossypol for menorrhagia. *Amer. J. of Obstet and Gyn.* 138:1227-1229.

## L

- Laemmli, U.K.  
1970. Cleavage of structural proteins during the assembly of the head of bacteriophage T<sub>4</sub>. *Nature* 227:680-685.
- Lai, C.S.  
1972. Comparison of fractionating aspirator and gravity separator in the processing of acid-delinted cottonseed. M.S. Thesis, Mississippi State University, Miss. State, MS pp. 67.
- Lanche, A.J.  
1978. Effects of refrigeration, CO<sub>2</sub>, and photoperiod on the initial and subsequent growth of rooted cuttings of *Hex cornuta* Lindl. et Paxt. cv. *Burfordii*. *Plant Prop.* 24:8-10.
- Lang, W.A.; Ogren, W.A., and Hageman, R.H.  
1974. Regulation of soybean net photosynthetic CO<sub>2</sub> fixation by the interaction of CO<sub>2</sub>, O<sub>2</sub>, and ribulose 1,5-diphosphate carboxylase. *Plant Physiol.* 54:678-685.
- Lambert, J.R., and Baker, D.N.  
1984. "RHIZOS: A Simulator of Row Crop Rhizospheres." *South Carolina Agr. Exp. Sta. Bull.* 1080.
- Lancaster, J.D., Andrews, W.B., and Jones, U.S.  
1953. Influence of sodium on yield and quality of cotton lint and seed. *Soil Sci.* 76:29-40.
- Lane, H.C.  
1958. Response of cotton on the Texas high plains to foliar treatments of gibberellic acid. *Proc. 13th Cotton Defoliation-Physiol. Conf.*, pp. 26.
- Lane, H.C.; Hall, W.C.; and Johnson, S.P.  
1954. Effects of temperature on foliar abscission of cotton. *Proc. Beltwide Cotton Def. Conf.* 8:48.

- Lane, H.C., and Schuster, M.F.  
1981. Condensed tannins of cotton leaves. *Phytochemistry* 20:425-427.
- Lang, A.G.  
1938. The origin of lint and fuzz fibers of cotton. *J. Agric. Res.* 56:507-521.
- Lang, A.R.G.  
1973. Leaf orientation of a cotton plant. *Agric. Met.* 37:37-51.
- Lang, J.M.; Eisinger, W.R.; and Green, P.B.  
1982. Effects of ethylene on the orientation of microtubules and cellulose microfibrils of Pea epicotyl cells with polylamellate cell walls. *Protoplasma* 110:5-14
- Lange, O.L.; Losch, R.; Schulze, E.D.; and Kappen, L.  
1971. "Responses of stomata to changes in humidity." *Planta* 100:76-86.
- Lasky, R.A., and Mills, A.D.  
1975. Quantitative film detection of  $^3\text{H}$  and  $^{14}\text{C}$  in polyacrylamide gels by fluorography. *Eur. J. Biochem.* 56:335-341.
- Latzko, E., and Kelly, S.J.  
1979. Enzymes of the reductive pentose phosphate cycle, pp 239-250. *In* Photosynthesis II. Photosynthetic Carbon Metabolism and Related Processes, M. Gibbs and E. Latzko (eds.), *Encyclopedia of Plant Physiology*. Vol. 6. Springer-Verlag, N.Y.
- Lauchli, A.; Kent, L.M.; and Turner, J.C.  
1981. Physiological responses of cotton genotypes to salinity. *Proc. Beltwide Cotton Prod. Res. Conf. National Cotton Council, Memphis*. pp. 40.
- Law, T.C.  
1919. Why does protein and oil vary in cottonseed? *Cotton Oil Press* 3:37-38.
- Lawhon, J.T.; Carter, C.M.; and Mattil, K.F.  
1976. Evaluation of the food use potential of sixteen varieties of cottonseed. *J. Amer. Oil Chem. Soc.* 54:75-80.
- Lawlor, D.W.  
1976. Water stress induced changes in photosynthesis, photorespiration, and  $\text{CO}_2$  compensation concentration of wheat. *Photosynthetica* 10:378-387.
- Lawlor, D.W.  
1979. Effects of water and heat stress on carbon metabolism of plants with  $\text{C}_3$  and  $\text{C}_4$  photosynthesis. *In* H. Mussell and R.C. Staples (eds.) *Stress Physiology in Crop Plants*. John Wiley & Sons Inc., pp. 303-326.
- Lawson, J.P., McCoy, P.A.; McSay, A.E.; and Moore, F.D. III.  
1978. Mulch-covered straw provides  $\text{CO}_2$  enrichment. *Experiment Station Progress Report 22*, Colorado State University. Fort Collins, Colorado, pp. 2.
- Leding, A.R., and Lytton, L.R.  
1933. Effects of plant spacing and irrigation on number of locks in cotton bolls *J. Agric. Res.* 47:33-52.
- Lee, J.A.  
1962. Genetical studies concerning the distribution of pigment glands in the cotyledons and leaves of upland cotton. *Genetics* 47:131-142.
- Lee, J.A.  
1964. Some problems in breeding for increased gossypol level in upland cotton. *Agron. Abstr.* 56th Ann. Mtg. Am. Soc. Agron. pp. 72
- Lee, J.A.  
1975. Inheritance of hard seed in cotton. *Crop Sci.* 15:149-152.
- Lee, J.A.  
1977. Inheritance of gossypol level in *Gossypium*. III. Genetic potentials of two strains of *Gossypium hirsutum* L. differing widely in seed gossypol level. *Crop Sci.* 17:827-830.
- Lee, J.A.  
1978. Allele determining rugate fruit surface in cotton. *Crop Sci.* 18:251-254.

- Leffler, H.R.  
1976a. Altered development of ribonuclease activity and formation of polyribosomes in chilled cotton cotyledons. *Crop Sci.* 16:71-75.
- Leffler, H.R.  
1976b. Carbohydrate composition of developing cottonseed. *Agron. Abstr.* 68:73.
- Leffler, H.R.  
1976c. Development of cotton fruit. I. Accumulation and distribution of dry matter. *Agron. J.* 68:855-857.
- Leffler, H.R.  
1980a. Cultivar and physiology influence planting quality of cotton seed. *Agron. Abstr.* 72:110.
- Leffler, H.R.  
1980b. Early termination of maturation reduces the biological quality of cottonseed. *Plant Physiol.* 65:141
- Leffler, H.R.; Elmore, C.D.; and Hesketh, J.D.  
1977. Seasonal and fertility-related changes in cottonseed protein quantity and quality. *Crop Sci.* 17:953-956.
- Leffler, H.R., and King, E.E.  
1977. Histochemistry of cottonseed development. *Agron. Abstr.* 69:88.
- Leffler, H.R.; Meredith, W.R., Jr.; and Chandler, J.M.  
1978. Canopy physiology and seasonal patterns affect the composition and yield capacity of cottonseed. *Agron. Abstr.* 70:79-80.
- Leffler, H.R., and Tubertini, B.S.  
1976. Development of cotton fruit. II. Accumulation and distribution of mineral nutrients. *Agron. J.* 68:858-861
- Leffler, H.R., and Williams, R.D.  
1983. Seed density classification influences germination and seedling growth of cotton. *Crop Sci.* 23:161-165.
- Leigh, T.F.; Grimes, D.W.; Dickens, W.L.; and Jackson, C.E.  
1974. Planting pattern, plant population, irrigation, and insect interaction in cotton. *Environ. Entomol.* 3:492-496.
- Leinweber, C.L., and Hall, W.C.  
1959b. Foliar abscission in cotton. II. Influence of age and defoliants on chemical composition of blades and pulvinoids. *Bot. Gaz.* 120:144-151.
- Lemon, E.R.  
1977. The land's response to more carbon dioxide. *In* N.R. Anderson and A. Malahoff (eds.), *The Fate of Fossil Fuel CO<sub>2</sub> in the Oceans*, pp 97-129. Plenum Press, New York
- Lemon, E., Stewart, D.W.; and Sahwcraft, R.W.  
1971. The sun's work in a cornfield. *Science* 174:374-378
- Leonard, O.A., and Pinckard, J.A.  
1946. Effects of various oxygen and carbon dioxide concentrations on cotton root development. *Plant Physiol.* 21:18-36.
- Leonhardt, J.L.; Zoerb, G.C.; and Harmann, D.D.  
1961. Investigation of factors affecting impact damage to sorghum seed. *Amer. Soc. Agr. Eng. St. Joseph, MI.* 1961 Ann. Meeting. Paper No. 61-125.
- Leopold, A.C.  
1971. Physiological processes involved in abscission. *Hort. Sci.* 6:376-378.
- Leopold, A.C., and Kriedemann, P.E.  
1975. *Plant growth and development* 2nd ed. McGraw-Hill, New York.
- Lacey, J.; Stolzy, L.H.; Blank, G.B.; and Lunt, O.R.  
1961. Effect of temperature on oxygen-diffusion rates and subsequent shoot growth and mineral content of two plant species. *Soil Sci.* 92:314-321
- Latham, D.S.  
1967. Chemistry and physiology of kinetin-like compounds. *Ann. Rev. Plant Physiol.* 18:349-364.

- Levengood, W.C.; Bondie, J.; and Chen, Chi-Ling  
1975. Seed selection for potential viability. *J. Exp. Bot.* 26:911-919.
- Levitt, J.  
1972. Responses of Plants to Environmental Stresses. Acad. Press, New York.
- Levy, W.B., and McCarthy, B.J.  
1975. Messenger RNA complexity in *Drosophila melanogaster*. *Biochemistry* 14:2440-2446.
- Lewin, B.M.  
1980. Gene Expression 2 (2nd Edition) John Wiley and Sons, N.Y. pp. 1160.
- Lewis, C.F., and Richmond, T.R.  
1957. The genetics of flowering response in cotton. I. Fruiting behavior of *Gossypium hirsutum* L. var. *mariegalante* in a cross with a variety of American upland cotton. *Genetics* 42:499-500.
- Lewis, C.F., and Richmond, T.R.  
1968. Cotton as a crop. In F.C. Elliot, M. Hoover, and W.K. Porter, Jr. (eds.), *Advances in Production and Utilization of Quality Cotton. Principles and Practices.* pp. 1-21 Iowa State University Press, Ames.
- Lewis, H.L.  
1969a. Effects of cottonseed free fatty acids on developing cotton seedlings. *Proc. Beltwide Cotton Prod. Res. Conf.* 1969:64-70.
- Lewis, H.L.  
1969b. The relationships of delinting methods to cottonseed exudates. *Proc. Beltwide Cotton Prod. Res. Conf.* 1969:130-132.
- Lewis, L.N., and Varner, J.E.  
1970. Synthesis of cellulase during abscission of *Phaseolus vulgaris* leaf explants. *Plant Physiol.* 46:194-199
- Lieberman, M.; Kunishi, A.; Mapson, L.W.; and Wardale, D.A.  
1966. Stimulation of ethylene production in apple tissue slices by methionine. *Plant Physiol.* 41:376-382
- Lieberman, M., and Mapson, L.W.  
1964. Genesis and biogenesis of ethylene. *Nature* 204:343-345.
- Lin, W.C., and Molnar, J.M.  
1982. Supplementary lighting and CO<sub>2</sub> enrichment for accelerated growth of selected woody ornamental seedlings and rooted cuttings. *Can. J. Plant Sci.* 62:703-707.
- Lipe, J.A., and Morgan, P.W.  
1972a. Ethylene: Role in fruit abscission and dehiscence processes. *Plant Physiol.* 50:759-764.
- Lipe, J.A., and Morgan, P.W.  
1972b. Ethylene: Response of fruit dehiscence to CO<sub>2</sub> and reduced pressure. *Plant Physiol.* 50:765-768.
- Lipe, J.A., and Morgan, P.W.  
1973a. Location of ethylene production in cotton flowers and fruits. *Planta* 115:93-96.
- Lipe, J.A., and Morgan, P.W.  
1973b. Ethylene, a regulator of young fruit abscission. *Plant Physiol.* 51:949-953.
- Little, C.H.A., and Eidt, D.C.  
1968. Effect of abscisic acid on bud break and transpiration in woody species. *Nature (London)* 220:489-499.
- Liu, T.Y., and Chang, Y.H.  
1971. Hydrolysis of proteins with p-toluenesulfonic acid. *J. Biol. Chem.* 246:2842-2848.
- Lloyd, F.E.  
1920. Environmental changes and their effect upon boll—boll-shedding in cotton (*Gossypium herbaceum*). *Ann. N.Y. Acad. Sci.* 29:1-131
- Lockwood, J.G.  
1982. Increasing atmospheric carbon dioxide and its consequences. *Nature* 299:203.

- Loewenschuss, H., and Wakelyn, P.J.  
1972. Occurrence of gossypol in dried bract of the cotton plant. *J. Amer. Oil Chem. Soc.* 49:678-680
- Lofland, H.B.  
1950. *In vitro* culture of the cotton embryo. *Bot. Gaz.* 111:307-311
- Longenecker, D.E., and Erie, L.J.  
1968. Irrigation water management. *In Advances in production and utilization of quality cotton: Principles and practices.* F.C. Elliott, M. Hoover and W.K. Porter (eds.). Iowa State University Press, Ames, Iowa, pp. 321-345
- Longo, G.P., and Longo, C.P.  
1975. Development and mitochondrial enzyme activities in germinating maize scutellum. *Plant Sci Lett.* 5:339-346.
- Longstreth, D.J., and Nobel, P.S.  
1979. Salinity effects on leaf anatomy. *Plant Phys.* 63:700-703
- Loomis, H.F.  
1927. Development of flowers and bolls of Pima and Acala cotton in relation to branching. USDA Bul. No. 1365
- Loomis, R.S., and William, W.A.  
1963. Maximum crop productivity. An estimate. *Crop Sci.* 3:67-72
- Lord, E.  
1961. The characteristics of raw cotton. The textile institute and Butterworth, London. (Vol. 2, part 1).
- Lorimar, G.H.; Badger, M.R., and Andrews, T.J.  
1977. D-Ribulose-1, 5-bisphosphate carboxylase-oxygenase: Improved methods for the activation and assay of catalytic activities. *Analytical Biochem.* 78:66-75.
- Louwerse, W.  
1980. Effects of CO<sub>2</sub> concentration and irradiance on the stomatal behavior of maize, barley and sunflower plants in the field. *Plant Cell and Environ.* 3:391-398.
- Loveys, B.R.  
1977. The intracellular location of abscisic acid in stressed and nonstressed leaf tissue. *Physiol Plant.* 40:6-10.
- Loveys, B.R., and Kriedmann, P.E.  
1974. Internal control of stomatal physiology and photosynthesis. I. Stomatal regulation and associated changes in endogenous levels of abscisic acid and phaseic acids. *Aust. J. Plant Physiol.* 1:407-415
- Low, A.; Hesketh, J.; and Muramoto, H.  
1969. Some environmental effects on the varietal node number of the first fruiting branch. *Cotton Grow. Rev.* 46:181-188
- Lowry, O.H., Rosebrough, N.; Farr, A.L.; and Randall, R.J.  
1951. Protein measurement with the Folin phenol reagent. *J. Biol. Chem.* 193:265-275.
- Ludlow, M.M., and Ng, T.T.  
1976. Effect of water deficit on carbon dioxide exchange and leaf elongation rate of *Panicum maximum* var. *trichoglume*. *Aust. J. Plant Physiol.* 3:401-413.
- Ludwig, C.A.  
1932. The germination of cottonseed at low temperatures. *J. Agr. Res.* 44:367-380.
- Lukefahr, M.J., and Fryxell, P.A.  
1967. Content of gossypol in plants belonging to genera related to cotton. *Econ. Bot.* 21:128-131.
- Lukefahr, M.J., and Martin, D.F.  
1963. Evaluation of damage to lint and seed of cotton caused by pink bollworm. *J. Econ. Entomol.* 56:710-713.
- Lukefahr, M.J., and Martin, D.F.  
1966. Cotton-plant pigments as a source of resistance to the bollworm and tobacco budworm. *J. Econ. Entomol.* 59:176-179.

- Lurie, S., and Hendrix, D.L.  
1979. Differential ion stimulation of plasmalemma adenosine triphosphatase from leaf epidermis and mesophyll of *nicotiana rustica* L. *Plant Physiol.* 63:936-939.
- Lürssen, K.; Naumann, K.; and Schröder, R.  
1979. 1-Aminocyclopropane-1-carboxylic acid—an intermediate of the ethylene biosynthesis in higher plants. *Z. Pflanzenphysiol.* 92:285-294.
- Lyman, C.M.; Chang, W.Y.; and Couch, J.R.  
1953. Evaluation of protein quality in cottonseed meals by chick growth and by a chemical index method. *J. Nutr.* 49:679-690.
- Lynn, D.G., and Jeffs, P.W.  
1975. Isolation and structure of 1-hydroxy-7-methoxy-4-isopropyl-1,6-dimethyl-2(1H)-naphthalenone from cotton. *J. Org. Chem.* 40:2958-2960.
- Lyons, J.M., and Raison, J.K.  
1970. Oxidative activity of mitochondria isolated from plant tissue sensitive and resistant to chilling injury. *Plant Physiol.* 45:386-389.
- Ljutova, M.I.  
1962. The effect of heat hardening on photosynthesis and respiration of higher plants. *Botanicheski Zhurnal* 47:1761-1774.

## M

- Maas, E.V., and Hoffman, C.J.  
1977. Crop salt tolerance—current assessment. *J. of Irrig. and Drain. Div. ASCE* Ir2:115-134.
- Mabry, T.J., Markham, K.R.; and Thomas, M.B.  
1970. *The Systematic Identification of Flavonoids.* Springer-Verlag. New York.
- MacDonald, D., Fielding, W.L.; and Ruston, D.F.  
1947. Sulfuric acid treatment of cotton seed and its effect on germination, development, and yield. *J. Agr. Sci.* 37:291-296.
- MacDowell, F.D.H.  
1972. Growth kinetics of Marquis wheat. II. Carbon dioxide dependence. *Can. J. Bot.* 50:883-889.
- Mace, M.E.  
1978. Contributions of tyloses and terpenoid aldehyde phytoalexins to *Verticillium* wilt resistance in cotton. *Physiol. Plant Pathol.* 12:1-11.
- Mace, M.E., and Bell, A.A.  
1981. Flavanol and terpenoid aldehyde synthesis in tumors associated with genetic incompatibility in a *Gossypium hirsutum* X *G. gossypoides* hybrid. *Can. J. Bot.* 59:951-955.
- Mace, M.E., and Howell, C.R.  
1974. Histochemistry and identification of condensed tannin precursors in roots of cotton seedlings. *Can. J. Bot.* 52:2423-2426.
- Mace, M.E.; Bell, A.A.; and Beckman, C.H.  
1976. Histochemistry and identification of disease-induced terpenoid aldehydes in *Verticillium*-wilt-resistant and -susceptible cottons. *Can. J. Bot.* 54:2095-2099.
- Mace, M.E.; Bell, A.A.; and Stipanovic, R.D.  
1974. Histochemistry and isolation of gossypol and related terpenoids in roots of cotton seedlings. *Phytopath.* 64:1297-1302.
- Mace, M.E.; Bell, A.A.; and Stipanovic, R.D.  
1978. Histochemistry and identification of flavanols in *Verticillium* wilt-resistant and -susceptible cottons. *Physiol. Plant Pathol.* 13:143-149.
- MacKenzie, A.J., and van Schaik, P.H.  
1963. Effect of nitrogen on yield, boll, and fiber properties of four varieties of irrigated cotton. *Agron. J.* 55:345-347.

- Maclachlan, G.A.  
1977. Cellulose metabolism and cell growth. *In* "Plant Growth Regulation" Pilet (ed.), pp 13-20 Springer-Verlag.
- Madsen, E.  
1968. Effect of CO<sub>2</sub> concentration on the accumulation of starch and sugar in tomato leaves. *Physiol. Plant.* 21:168-175
- Madsen, E.  
1971a. Cytological changes due to the effect of carbon dioxide concentration on the accumulation of starch in chloroplasts of tomato leaves. Royal Veterinary and Agricultural University Yearbook, Copenhagen, pp. 191-194.
- Madsen, E.  
1971b. The effect of carbon dioxide concentration on the photosynthetic rate in tomato leaves. Royal Veterinary and Agricultural University Yearbook, Copenhagen, pp. 195-200.
- Madsen, E.  
1973. The effect of CO<sub>2</sub> concentration on development and dry matter production in young plants *Acta Agric. Scand.* 23:234-240.
- Madsen, E.  
1974. Effect of CO<sub>2</sub> concentration on growth and fruit production of tomato plants. *Acta Agric. Scand.* 23:242-246.
- Madsen, E.  
1976. Effect of CO<sub>2</sub> concentration on morphological, histological, cytological and physiological processes in tomato plants. Dissertation pp 246 State Seed Testing Station, Lyngby, Denmark.
- Maga, J.A., and Lorenz, K.  
1974. Gas-liquid chromatography separation of the free phenolic acid fractions in various oilseed protein sources. *J. Sci. Food Agric.* 25:797-802
- Magstad, O.C.; Ayers, A.D.; Wadleigh, C.H.; and Gauch, H.G.  
1943. Effect of salt concentration, kind of salt, and climate on plant growth in sand cultures. *Plant Physiol.* 18:151-166.
- Magnuson, C.E.; Fares, Y.; Goeschl, J.D.; Nelson, C.E.; Strain, B.R.; Jaeger, C.H.; and Bilpuch, E.G.  
1982. An integrated tracer kinetics system for studying carbon uptake and allocation in plants using continuously produced <sup>14</sup>C<sub>2</sub> Rad and Environ Biophysics. 21:51-65.
- Mahdi, M.T., Lotfi, A.A.; Shiltawy, E.; and Farag, F.F.  
1971. Cold test for cotton seed. *Proc. Int. Seed Test. Assoc.* 36:279-287.
- Mahon, J., and Low, A.  
1972. Growing degree days as a measure of temperature effects on cotton. *Cotton Grow. Rev.* 49:39-49.
- Majernik, O., and Mansfield, T.A.  
1970. Direct effect of SO<sub>2</sub> pollution on the degree of opening of stomata. *Nature, Lond.* 227:377-378.
- Majernik, O., and Mansfield, T.A.  
1972. Stomatal response to raised atmospheric CO<sub>2</sub> concentrations during exposure of plants to SO<sub>2</sub> pollution. *Environ. Pollut.* 3:1-7.
- Maleki, P.  
1966. Microenvironmental influence on cottonseed deterioration in the field. M.S. Thesis Mississippi State University, Mississippi State, MS.
- Malik, M.N.A.; Edwards, D.G.; and Evenson, J.P.  
1981. Effects of flower bud removal on nitrogen supply and growth and development of cotton. *Aust. J. Plant Physiol.* 8:285-291
- Malkin, R.  
1982. Photosystem I. *Ann. Rev. Plant Physiol.* 33:455-479.

- Malloch, K.R., and Fenton, R.  
1979. Inhibition of stomatal opening by analogues of abscisic acid. *J. Exp. Bot.* 30:1201-1209.
- Maltby, D.; Carpita, N.C.; Montezinos, D.; Kulow, C.; and Delmer, D.P.  
1979  $\beta$ -1,3-Glucan in developing cotton fibers. *Plant Physiol.* 63:1158-1164.
- Mansfield, T.A.  
1973. The role of stomata in determining the responses of plants to air pollutants. *Current Adv. Plant Sci.* 2:11-20.
- Mansfield, T.A.  
1976. Delay in the response of stomata to abscisic acid in CO<sub>2</sub>-free air. *J. Exp. Bot.* 27:559-564.
- Mansfield, T.A., and Majernik, O.  
1970. Can stomata play a part in protecting plants against air pollutants? *Environ. Pollut.* 1:149-154.
- Mansfield, T.A., and Meidner, H.  
1966. Stomatal opening in light of different wavelengths: Effects of blue light independent of carbon dioxide concentration. *J. Exp. Bot.* 17:510-521.
- Mansfield, T.A.; Travis, A.J., and Jarvis, R.G.  
1981. Responses to light and CO<sub>2</sub>. *In* P.G. Jarvis and T.A. Mansfield (eds.), *Stomatal Physiology*, Society for Experimental Biology Seminar Series, Vol. 8, pp. 119-135. Cambridge University Press, Cambridge.
- Mansfield, T.A., Wellburn, A.R.; and Moreira, T.J.S.  
1978. The role of abscisic acid and farnesol in the alteration of water stress. *Philos. Trans. Roy. Soc. London B.* 284:471-482.
- Marani, A., and Amirav, A.  
1970. Effect of delinting and of genetical factors on the germination of cotton seeds at low temperatures. *Crop Sci.* 10:509-511.
- Marani, A., and Amirav, A.  
1971. Effects of soil moisture stress on two varieties of upland cotton in Israel. I. The coastal plain region. *Experimental Agriculture* 7:213-224.
- Marani, A., and Baker, D.N.  
1981. "Development of a Predictive Dynamic Simulation Model of Growth and Yield in Acala Cotton." Science Report to U.S.—Israel Binational Foundation. pp. 177., April 30, 1981.
- Marani, A.; Baker, D.N.; Reddy, V.R.; and McKinion, J.M.  
1981. "The Effect of Water Stress on Canopy Senescence and Apparent Photosynthesis in Cotton."
- Marani, A., and Dag, J.  
1962a. Germination of seeds of cotton varieties at low temperatures. *Crop Sci.* 2:267.
- Marani, A., and Dag, J.  
1962b. Inheritance of the ability of cotton seeds to germinate at low temperature in the first hybrid germination. *Crop Sci.* 2:243-245.
- Marani, A., and Levi, D.  
1973. Effect of soil moisture during early stages of development on growth and yield of cotton plants. *Agron. J.* 65:637-641.
- Marani, A.; Zur, M.; Eshel, A.; Zimmerman, H.; Carmeli, R.; and Karadvaïd, B.  
1973. Effect of time and rate of application of two growth retardants on growth, flowering, and yield of upland cotton. *Crop Sci.* 13:429-435.
- Marin, B., and Vieira da Silva, J.B.  
1972. Effect of water stress on distribution of RNA in cells of cotton leaves. *Physiol. Plant* 27:150-155.
- Markhart, A.H.; Fiscus, E.L.; Naylor, A.W.; and Kramer, P.J.  
1979a. Effect of temperature on water and ion transport in soybean and broccoli systems. *Plant Physiol.* 64:83-87.
- Markhart, A.H.; Fiscus, E.L.; Naylor, A.W.; and Kramer, P.J.  
1979b. Effect of abscisic acid on root hydraulic conductivity. *Plant Physiol.* 64:611-614.



- Marsh, P.B., Merola, G.V., Bollenbacher, K., Butler, M.L., and Simpson, M.  
1954. The effect of weathering prior to harvest on certain properties of cotton fiber. *Plant Dis. Repr.* 38:106-119.
- Marshall, J.G., and Strugis, M.B.  
1953. Effects of sodium fertilizers on yield of cotton. *Soil Sci.* 76:75-79
- Martin, C., and Thimann, K.V.  
1972. Role of protein synthesis in the senescence of leaves. II. The influence of amino acids on senescence. *Plant Physiol.* 50:432-437.
- Martin, R.D.; Ballard, W.W., and Simpson, D.M.  
1923. Growth of fruiting parts in cotton plants. *J. Agr. Res.* 25:195-208.
- Martinez, W.H.; Berardi, I. C., and Goldblatt, L.A.  
1970. Cottonseed protein products—composition and functionality. *Agric. and Food Chem.* 18:961-968.
- Marx-Figini, M.  
1966a. Comparison of the Biosynthesis of Cellulose *in vitro* and *in vivo* in cotton bolls. *Nature* 210:754-755
- Marx-Figini, M.  
1966b. Kinetics of the Biosynthesis of Cellulose in cotton bolls by different light intensities. *Nature* 210:755.
- Marynick, M.C.  
1976. Studies on abscission in cotton explants. Ph.D. Dissertation, University of California, Davis.
- Marynick, M.C.  
1977. Patterns of ethylene and carbon dioxide evolution during cotton explant abscission. *Plant Physiol.* 59:484-489.
- Maskell, E.J., and Mason, T.G.  
1930. Studies of the transport of nitrogenous substances in the cotton plant. V. Movement to the boll. *Ann. Bot.* 44:657-688
- Mason, T.G.  
1922. Growth and abscission in Sea Island cotton. *Ann. Bot.* 36:457-483
- Mason, T.G., and Maskell, E.J.  
1928a. Studies on the transport of carbohydrates in the cotton plant. I. A study of diurnal variation in the carbohydrates of the leaf, bark, and wood, and the effects of ringing. *Ann. Bot.* 42:189-253.
- Mason, T.G., and Maskell, E.J.  
1928b. Studies on the transport of carbohydrates in the cotton plants. II. The factors determining the rate and direction of movement of sugars. *Ann. Bot.* 42:571-636
- Masterson, C.L., and Sherwood, M.T.  
1978. Some effects of increased atmospheric carbon dioxide on white clover (*Trifolium repens*) and pea (*Pisum sativum*). *Plant and Soil* 49:421-426.
- Mathers, A.C.  
1967. Effect of radial restriction on lateral growth of the root-shoot axis of young cotton plants. *Agron. J.* 59:379-381.
- Matthews, M.A.  
1978. Effects of shedding in cotton on carbohydrate partitioning in adjacent fruiting positions—M.S. Thesis. University of Arizona, Tucson.
- Matthews, S., and Bradnock, W.T.  
1968. Relationship between seed exudation and field emergence in peas and French beans. *Hort. Res.* 8:89-93.
- Matthews, S., and Whitbread, R.  
1968. Factors influencing pre-emergence mortality in peas. I. An association between seed exudates and the incidence of pre-emergence mortality in wrinkled-seeded peas. *Plant Path.* 17:11-17

- Mauney, J.R.  
1961. The culture *in vitro* of immature cotton embryos. *Bot. Gaz.* 122:205-209.
- Mauney, J.R.  
1963. Initiation of flowering in upland cotton. *Proc. Cotton Physiology Defoliation Conference*. Dallas, Texas. Jan. 1963. pp. 33-34.
- Mauney, J.R.  
1966. Floral initiation of upland cotton *Gossypium hirsutum* L. in response to temperatures. *J. Exp. Bot.* 17:452-459.
- Mauney, J.R.  
1968. Morphology of the cotton plant. *In Cotton: Principles and Practices*. Edited by F.C. Elliot, M. Hoover, and W.K. Porter, Jr. Iowa State Univ. Press, Ames.
- Mauney, J.R.  
1978. The cotton plant: Is it as efficient as it could be? *Proc. Beltwide Cotton Prod. Res. Conf.* pp. 52.
- Mauney, J.R.  
1984a. Anatomy and Morphology of Cultivated Cotton. *In Cotton* R.J. Kohel and C.H. Lewis, (eds.), Amer. Soc. Agron. Madison.
- Mauney, J.R.  
1984b. Cotton square shedding: Why they fall; what it means to yields. *Crops and Soils* 37(1):20-22.
- Mauney, J.R., and Ball, E.  
1959. The axillary buds of *Gossypium*. *Bull. Torey Bot. Club.* 86:236-244.
- Mauney, J.R., Chappell, J.; and Ward, B.J.  
1967. Effect of malic acid salts on growth of young cotton embryos *in vitro*. *Bot. Gaz.* 128:198-200
- Mauney, J.R.; Fry, K.E.; and Guinn, G.  
1978. Relationship of photosynthetic rate to growth and fruiting of cotton, soybean, sorghum, and sunflower. *Crop Sci.* 18:259-263.
- Mauney, J.R.; Guinn, G.; and Fry, K.E.  
1977. Relationship of photosynthetic rate to growth and fruiting of cotton plants. *Proc. 31st Cotton Physiol. Conf.* pp. 74.
- Mauney, J.R.; Guinn, G.; and Fry, K.E.  
1980. Analysis of increases of flowers in moisture stressed cotton. *Proc. Beltwide Cotton Prod. Res. Conf.*, pp. 38.
- Mauney, J.R.; Guinn, G.; Fry, K.E.; and Hesketh, J.D.  
1979. Correlation of photosynthetic carbon dioxide uptake and carbohydrate accumulation in cotton, soybean, sunflower, and sorghum. *Photosynthetica* 13:260-266
- Mauney, J.R., Guinn, G.; Hesketh, J.D.; Fry, K.E.; and Radin, J.W.  
1976. Inhibition of photosynthesis by leaf starch. *In Proc. Beltwide Cotton Prod. Res. Conf. Las Vegas, Nev.* pp. 60.
- Mauney, J.R., and Henneberry, T.J.  
1984. Causes of square abscission in cotton in Arizona. *Crop Sci.* 24:1027-1030.
- Mauney, J.R.; Kittock, D.L.; and Bariola, L.A.  
1972. Limitation of late season bolls in cotton. A possible new control for pink bollworm. *Proc. 1972 Beltwide Cotton Prod. Res. Conf.* pp. 103-105.
- Mauney, J.R., and Phillips, L.L.  
1963. Influence of daylength and night temperature on flowering of *Gossypium*. *Bot. Gaz.* 124:278-283.
- Mauney, J.R., and Szarek, S.R.  
1981. Drought tolerant plants: Dry matter production of crop and native species. *In C.C. Black and A.M. Tsui (eds.), Handbook of Biosolar Resources, Vol. I. Fundamental Principles*, pp. 379-386. CRC Press, Boca Raton, FL.

- Mayak, S., Vaadia, Y.; and Dilley, D.R.  
1977 Regulation of senescence in carnation (*Dianthus caryophyllus*) by ethylene. Mode of action. *Plant Physiol* 59:591-593.
- Mayne, R.Y.  
1956. Lipolytic microorganisms associated with prime and deteriorated cottonseed. *Appl. Microbiol.* 4:263-269.
- Mayne, R.Y., Harper, G.A.; Franz, A.O., Jr.; Lee, L.A.; and Goldblatt, L.A.  
1969. Retardation of the elaboration of aflatoxin in cottonseed by impermeability of the seedcoats. *Crop Sci* 9:147-150.
- McAfee, J.A., and Morgan, P.W.  
1971 Rates of production and internal levels of ethylene in the vegetative cotton plant. *Plant Cell Physiol.* 12:839-847.
- McArthur, J.A.; Hesketh, J.D., and Baker, D.N.  
1975. Cotton. Chapter 10. *In* L.T. Evans (ed.), *Crop Physiology: Some Case Histories*, pp. 297-325. Cambridge University Press, London.
- McClelland, C.K., and Neely, J.W.  
1931. The order, rate and regularity of blooming in the cotton plant. *J. Agric. Res.* 42:751-764.
- McClelland, J.H.  
1962. The relationship between the thickness of deciduous leaves and their maximum photosynthetic rate. *Amer. J. Bot.* 49:320-322.
- McCormick, J.P.; Pachlatko, J.P.; and Schafer, T.R.  
1978. Total synthesis of lacinilene C methyl ether, a probable byssinotic agent. *Tetrahedron Lett.* 3993-3994.
- McCoy, P.A.  
1978. Carbon dioxide in the tomato plant microenvironment. M.S. Thesis, Colorado State University, Fort Collins, Colorado, pp. 44.
- McDaniel, R.G.  
1977. New test prejudices cotton seed performance. *Crops and Soils*. April/May, 1977. pp. 24.
- McDaniel, R.G.  
1979. Physiological and scanning electron microscopic evaluations of cotton seed quality. *Proc Beltwide Cotton Prod. Res. Conf.* 1979:40-42.
- McDaniel, R.G.  
1982. The physiology of temperature effects on plants. *In* M.N. Christiansen and C.F. Lewis (eds.), *Breeding Plants for Less Favorable Environments*. pp. 13-45. Wiley, New York.
- McDaniel, R.G., and Taylor, B.B.  
1979. Treatments to enhance cottonseed germination and emergence under field stress. 1979 *Agron. Abstr.* pp. 115.
- McDonald, L.D., and Stitt, L.S.  
1972. Effect of temperature and humidity on pollen dehiscence in cytoplasmic male-sterile stocks of *Gossypium*. *Proc Beltwide Cotton Prod. Res. Conf.* pp. 60.
- McDonald, M.B., Jr.  
1975. A review and evaluation of seed vigor tests. *Proc. Assoc. Off. Seed Anal.* 65:109-139.
- McDonald, M.B., Jr.  
1980a. Assessment of seed quality. *Hort. Sci.* 15:784-788.
- McDonald, M.B., Jr.  
1980b. Vigor test subcommittee report. *Assoc. Off. Seed Anal. Newslett.* 54:37-40.
- McDonald, M.B., Jr., and Wilson, D.O.  
1979. An assessment of the standardization and ability of the ASA-610 to rapidly predict soybean germination. *J. Seed Technol.* 4:1-11.
- McDonald, M.B., Jr. and Wilson, D.O.  
1980. ASA-610 ability to detect changes in soybean seed quality. *J. Seed Technol.* 5:56-66.

- McIlrath, W.J.  
1956. Lipase activity in cotton seedlings. III. Acad. Sci. Transact. 48:42-48.
- McKibben, G.H.; Mitchell, E.B.; Scott, W.P.; and Hedin, P.A.  
1977. Bull weevils are attracted to volatile oils from cotton plants. Environ. Entomol. 6:804-806.
- McKinion, J.M.; Hesketh, J.D.; and Baker, D.N.  
1974. Analysis of the exponential growth equation. Crop Sci. 14:549-551.
- McMeans, J.L.; Brown, C.M.; McDonald, R.L.; and Parker, L.L.  
1977. Aflatoxins in cottonseed: A comparison of two cultivars. Crop Sci. 17:707-709.
- McMichael, B.L.  
1979. The influence of water stress on flowering and fruiting in cotton. In Cotton Physiology—A Treatise. Proc. Beltwide Cotton Prod. Res. Conf. pp. 301-302
- McMichael, B.L.  
1980. Water stress adaptation. In Predicting Photosynthesis for Ecosystem Models. J.D. Hesketh and J.D. Jones (eds.), CRC Press pp. 183-204.
- McMichael, B.L.; Burke, J.J.; Berlin, J.; and Quisenberry, J.E.  
1983. Variability in root morphology in exotic cotton. Proc. Beltwide Cotton Prod. Res. Conf. 37:59.
- McMichael, B.L., and Elmore, C.D.  
1976. The effects of plant water status on cotton boll growth and water relations. Proc. Beltwide Cotton Prod. Res. Conf. pp. 80.
- McMichael, B.L., and Elmore, C.D.  
1981. Proline accumulation by water and nitrogen stressed cotton. Crop Sci. 21:244-248.
- McMichael, B.L., and Guinn, G.  
1980. The effects of moisture deficits on square shedding. Proc. Beltwide Cotton Prod. Res. Conf. 34:38.
- McMichael, B.L., and Hanney, B.W.  
1977. "Endogenous Levels of Abscisic Acid in Water-Stressed Cotton Leaves." Agron. J. 69:979-982.
- McMichael, B.L., and Hesketh, J.D.  
1982. Field investigations of the response of cotton to water deficits. Field Crops Res. 5:319-333.
- McMichael, B.L.; Jordan, W.R.; and Powell, R.D.  
1972a. An effect of water stress on ethylene production by intact cotton petioles. Plant Physiol. 49:658-660.
- McMichael, B.L.; Jordan, W.R.; and Powell, R.D.  
1973. Abscission processes in cotton. Induction by plant water deficit. Agron. J. 65:202-204.
- McMichael, B.L., and Quisenberry, J.E.  
1983. Unpublished Results.
- McMichael, S.C.  
1959. Hopi cotton a source of cottonseed free of gossypol pigments. Agron. J. 51:630.
- McMichael, S.C.  
1960. Combined effects of glandless genes  $gl_2$  and  $gl_3$  on pigment glands in the cotton plant. Agron. J. 52:385-386.
- McNamara, H.C.; Hubbard, J.W.; and Beckett, R.E.  
1927. Growth and development of cotton plants at Greenville, Texas. USDA Cir. 401.
- McNamara, H.C.; Hooten, D.R.; and Porter, D.D.  
1940. Differential growth rates in cotton varieties and their response to seasonal condition at Greenville, Texas, USDA Tech. Bull. 710.
- McQuigg, J.D., and Calvert, O.H.  
1966. Influence of soil temperatures on the emergence and initial growth of upland cotton. Agr. Meteorol. 3:179-185.

- McWilliam, J.R.  
1983. Physiological basis for chilling stress and the consequences for crop production *In* C.D Raper, Jr. and P.J. Kramer (eds.), *Crop Reactions to Water and Temperature Stresses in Humid, Temperate Climates*, Westview Press, Boulder, Colorado. pp. 113-132.
- McWilliams, H.M.  
1961. Germination testing of cotton seed M.S. Thesis Mississippi State University, Miss State, MS. pp. 48.
- Medira, E.  
1970 Relationships between nitrogen level, photosynthetic capacity, and carboxydismutase activity in *Atriplex patula* leaves. Carnegie Inst. Wash. Yearbook 69:655-662.
- Medina, E.  
1971. Effect of nitrogen supply and light intensity during growth on the photosynthetic capacity and carboxydismutase activity of leaves of *Atriplex patula* Carnegie Inst. Wash. Yearbook 70:551-559.
- Meidner, H.  
1969. "Rate limiting" resistances and photosynthesis. *Nature* 222:876-877
- Meidner, H., and Mansfield, T.A.  
1965. Stomatal responses to illumination. *Biol. Rev.* 40:483-509.
- Meidner, H., and Mansfield, T.A.  
1968. *Physiology of Stomata*. pp. 87-91. McGraw-Hill Book Co., London.
- Meinert, M.C., and Delmer, D.P.  
1977. Changes in Biochemical Composition of the cell wall of the cotton fiber during development. *Plant Physiol.* 59:1088-1097.
- Meisner, J., Ascher, K.R.S., and Zur, M.  
1977a. Phagodeterrence induced by pure gossypol and leaf extracts of a cotton strain with high gossypol content in the larva of *Spodoptera littoralis* *J. Econ. Entomol.* 70:149-150.
- Meisner, J.; Kehat, M.; Zur, M.; and Ascher, K.R.S.  
1977b. The effect of gossypol on the larvae of the spiny bollworm, *Earias insulana* *Ent. exp. & appl.* 22:301-303.
- Meisner, J.; Navon, A.; Zur, M.; and Ascher, K.R.S.  
1977c. The response of *Spodoptera littoralis* larvae to gossypol incorporated in an artificial diet. *Environ. Entomol.* 6:243-244
- Meisner, J.; Zur, M.; Kabonci, E.; and Ascher, K.R.S.  
1977d. Influence of gossypol content of leaves of different cotton strains on the development of *Spodoptera littoralis* larvae. *J. Econ. Entomol.* 70:714-716.
- Menz, K.M., Moss, D.N., Cannell, R.Q.; and Brun, W.A.  
1969. Screening for photosynthetic efficiency *Crop Sci.* 9:692-694
- Meredith, W.R., Jr., and Bridge, R.R.  
1973. Yield, yield component and fiber property variation of cotton (*Gossypium hirsutum* L.) within and among environments *Crop Sci.* 13:307-312.
- Meredith, W.R.; Bridge, R.R., and Chism, J.F.  
1967. Seasonal changes in yield and fiber properties of four varieties of cotton. *Miss. Agr. Exp. Sta. Info. Sheet* 998, pp. 2
- Mergeai, G.; Verschraege, L.; and Demol, J.  
1985. The Influence of Temperature on Fibre Production and Fibre Physical Properties. *In* International Institute of Cotton *Cotton Fibres: Their Development and Properties*. pp.13-16. International Institute for Cotton, Manchester, UK.
- Metzer, R.B.  
1961a Effects of the pneumatic conveyer on seed viability. *Tex. Agr. Exp. Sta.* MP-508
- Metzer, R.B.  
1961b The relationship of tetrazolium stain ratings and certain growth tests of cotton seed. *Proc. Assoc. Off. Seed Anal.* 51:99-105.

- Metzer, R.B.; Johnson, S.P.; and Coffey, L.C.  
1961. Effects of calcium treatment on the quality of cottonseed. *Agron. J.* 53:316-319.
- Metzger, H.; Shapiro, M.B.; Mosimann, J.E.; and Vinton, J.E.  
1968. Assessment of compositional relatedness between proteins. *Nature* 219:1166-1168.
- Meyer, V.G.  
1966. Environmental effects on the differentiation of abnormal cotton flowers. *Amer. J. Bot.* 53:976-980.
- Meyer, V.G.  
1969. Some effects of genes, cytoplasm, and environment on male sterility of cotton (*Gossypium*). *Crop Sci.* 9:237-242.
- Mezynski, P.R.  
1966. Mechanical and electrical separation of despined cockleburs from mechanically delinted cotton seed. Ph.D. Dissertation. Mississippi State University, Miss. State, MS. pp. 81
- Michaelidis, Z.  
1977. Cotton fiber length distribution generation. Ph.D. Dissertation.
- Miernyk, J.A., Thomas, J.; and Trelease, R.N.  
1982. A novel role for peroxisomes in oilseed development. *Proc. N.Y. Acad. Sci.* 386:426-429.
- Miernyk, J.A., and Trelease, R.N.  
1981a. Control of enzyme activities in cotton cotyledons during maturation and germination. IV.  $\beta$  oxidation. *Plant. Physiol.* 67:341-346.
- Miernyk, J.A., and Trelease, R.N.  
1981b. Role of malate synthase in citric acid synthesis by maturing cotton embryos: A proposal. *Plant Physiol.* 67:875-881.
- Miernyk, J.A.; Trelease, R.N.; and Choinski, J.S., Jr.  
1979. Malate synthase activity in cotton and other ungerminated oilseeds. *Plant Physiol.* 63:1068-1071.
- Milborrow, B.V.  
1974a. Biosynthesis of abscisic acid by a cell-free system. *Phytochem.* 13:131-136.
- Milborrow, B.V.  
1974b. The chemistry and physiology of abscisic acid. *Ann. Rev. Plant Physiol.* 25:259-307.
- Milborrow, B.V.  
1979. Antitranspirants and the regulation of abscisic acid content. *Aust. J. Plant Physiol.* 6:249-254.
- Milborrow, B.V.  
1980. Abscisic acid. *In* F. Skoog (ed.), *Plant Growth Substances*, pp. 262-273. Springer-Verlag, Berlin.
- Miles, D.F., and Copeland, L.O.  
1980. The relationship of vigor tests and field performance in soybeans (*Glycine max* (L.) Merr.). *Agron. Abstr.* 1980:111.
- Miller, L.T.  
1967. Maintenance of planting cottonseed quality. *Proc. Beltwide Cotton Prod. Mech. Conf.* 1967:23-24.
- Millican, A.A.  
1976. A survey and assessment of air pollution damage to California vegetation 1970 through 1974. Dept of Food and Agriculture, California. pp. 47.
- Milthroe, F.L.  
1969. The significance and mechanism of stomatal movement. *Aust. J. Sci.* 32:31-35
- Milthroe, F.L., and Spencer, E.J.  
1957. Experimental studies of the factors controlling transpiration. III. The interrelations between transpiration rate, stomatal movement and leaf water content. *J. Exp. Bot.* 8:414-437.
- Minton, E.B.  
1980. Effects of row spacing and cotton cultivars on seedling diseases *Verticillium* (caused by *Verticillium dahliae*), and yield. *Crop Sci.* 20:347-350.

- Minton, E.B., and Quisenberry, J.E.  
1980 Comparison of cottonseed delinting methods in evaluating seed-treatment fungicides. *Agron. J.* 72:573-575.
- Minton, E.B., and Supak, J.R.  
1980 Effects of seed density on stand, *Verticillium* wilt, and seed and fiber characteristics. *Crop Sci.* 20:345-347.
- Minyard, J.P., Hardec, D.D.; Gueldner, R.C., Thompson, A.C.; Wiygul, G.; and Hedin, P.A.  
1969. Constituents of the cotton bud compounds attractive to the boll weevil. *J. Agric. Food Chem* 17:1093-1097.
- Minyard, J.P.; Thompson, A.C., and Hedin, P.A  
1968. Constituents of the cotton bud. VIII.  $\beta$ -Bisabolol, a new sesquiterpene alcohol. *J. Org. Chem.* 33:909-911.
- Minyard, J.P.; Tumlinson, J.H., Thompson, A.C.; and Hedin, P.A  
1966 Constituents of the cotton bud. Sesquiterpene hydrocarbons. *J. Agric. Food Chem.*
- Mirvalle, R.J  
1965. Germination of cotton pollen *in vitro*. *Emp. Cotton Grow. Rev.* 42:287-289.
- Mirsky, A.E.  
1951. Some chemical aspects of the cell nucleus *In Genetics in the Twentieth Century*. L.C. Dunn (ed.), MacMillan, NY. pp. 127-153.
- Mirsky, A.E.  
1953. The chemistry of heredity. *Sci. Amer.* 188:47-57.
- Mitchell, E.D.; Johnson, B.B., and Whittle, T  
1980.  $\beta$ -Galactosidase activity in cultured cotton cells (*Gossypium hirsutum* L.): A comparison between cells growing on sucrose and lactose. *In vitro* 16:907-912
- Mittelheuser, C.J., and van Steveninck, R.F.M.  
1969 Stomatal closure and inhibition of transpiration induced by (RS)-abscisic acid. *Nature (London)* 221:281-282.
- Mittelheuser, C.J., and van Steveninck, R.F.M.  
1971. Rapid action of abscisic acid on photosynthesis and stomatal resistance. *Planta* 97:83-86
- Mizrabi, J., Blumenfeld, A., and Richmond, A.E.  
1970. Abscisic acid and transpiration in leaves in relation to osmotic root stress. *Plant Physiol.* 46:169-171
- Mizrabi, Y., and Richmond, A.E.  
1972. Abscisic acid in relation to mineral deprivation. *Plant Physiol.* 50:667-670
- Moffett, J.O.; Stith, L.S.; Morton, H.L.; and Shipman, C.W.  
1980. Effect of 2,4-D on cotton yield, floral nectar, seed germination and honeybee visits. *Crop Sci.* 20:747-750.
- Mohapatra, N.; Smith, E.W.; Fites, R.C.; and Noggle, G.R.  
1970. Chilling temperature depression of isocitratase activity from cotyledons of germinating cotton. *Biochem. Biophysics Res. Commun.* 40:1253-1258.
- Moline, H.E.; LaMotte, C.E.; Gochnauer, C.; and McNamer, A.  
1972. Further comparative studies of pectin esterase in relation to leaf and flower abscission. *Plant Physiol.* 50:655-659.
- Monteith, J.L.  
1962. Measurement and interpretation of carbon dioxide fluxes in field. *J. Agr. Sci.* 10:334-346
- Monteith, J.L.  
1965 Carbon dioxide and crop production. *Agr. Prog.* 40:75-82.
- Montezinos, D., and Delmer, D.P.  
1980. Characterization of inhibitors of cellulose synthesis in cotton fibers. *Planta* 148:305-311
- Moore, J.H.  
1941 The distribution and relation of fiber population, length, breaking load, weight, diameter, and percentage of thin-walled fibers on the cottonseed in five varieties of American upland cotton. *J. Agr. Rev.* 62:255-302.

- Moore, T.C.  
1979. "Biochemistry and Physiology of Plant Hormones." Springer-Verlag, New York, Inc.
- Moore, V.P., and Shaw, C.S.  
1967. Mechanical damage to cottonseed . . . ginning effects. The Cotton Gin and Oil Mill Press, March 11, 1967 issue.
- Mooseberg, C.A.  
1969. Breeding for earliness of maturity in upland cotton. Ark. Agr. Exp. Sta. Bull. 730.
- Moraghan, B.J.; Hesketh, J.D.; and Low, A.  
1968. "Effects of temperature and photoperiod on floral initiation among strains of cotton." Cotton Grow. Rev. 45:91-100.
- Moreno-Diaz de la Espina, S.; Medina, F.J.; and Risueño, M.C.  
1980. Correlation of nucleolar activity and nucleolar vacuolation in plant cells. Eur. J. Cell Biol. 22:724-729.
- Morgan, P.W.  
1980. Synthetic growth regulators: Potential for development. Bot. Gaz. 141:337-346.
- Morgan, P.W.; Beyer, E., Jr.; and Gausman, H.W.  
1968. Ethylene effects on auxin physiology. In Biochemistry and Physiology of Plant Growth Substances, F. Wightman and G. Setterfield (eds.), pp. 1255-1273. The Runge Press, Ottawa, Canada.
- Morgan, P.W., and Durham, J.I.  
1975. Ethylene-induced leaf abscission is promoted by gibberellic acid. Plant Physiol. 55:308-311.
- Morgan, P.W., and Gausman, H.W.  
1966. Effects of ethylene on auxin transport. Plant Physiol. 41:45-52.
- Morgan, P.W., and Hall, W.C.  
1962. Effect of 2,4-dichlorophenoxyacetic acid on the production of ethylene by cotton and grain sorghum. Physiol. Plant 15:420-427.
- Morgan, P.W., and Hall, W.C.  
1964. Accelerated release of ethylene by cotton following application of indolyl-3-acetic acid. Nature 201:91.
- Morgan, P.W.; Jordan, W.R.; Davenport, T.L.; and Durham, J.I.  
1977. Abscission responses to moisture stress, auxin transport inhibitors, and ethephon. Plant Physiol. 59:710-712.
- Morlier, O.W.; Orr, R.S.; and Grant, J.N.  
1951. The relation of length to other physical properties of cotton fibers. Text. Res. Jour. 21:6-13.
- Morré, D.J.  
1968. Cell wall dissolution and enzyme secretion during leaf abscission. Plant Physiol. 43:1545-1559.
- Morris, D.A.  
1962. Elongation of lint hairs in upland cotton in Uganda. Emp. Cotton Grow. Rev. 39:270-276.
- Morris, D.A.  
1963. Variation in the boll maturation period of cotton. Emp. Cotton Grow. Rev. 40:114-123.
- Mortensen, L.M., and Moe, R.  
1983a. Growth responses of some greenhouse plants to environment. V. Effect of CO<sub>2</sub>, O<sub>2</sub>, and light on net photosynthetic rate in *Chrysanthemum morifolium*. Ramat. Scientia Hort. 19:133-140.
- Mortensen, L.M., and Moe, R.  
1983b. Growth responses of some greenhouse plants to environment. VI. Effect of CO<sub>2</sub> and artificial light on growth of *Chrysanthemum morifolium* Ramat. Scientia Hort. 19:141-147.
- Morton, A.G., and Watson, D.J.  
1948. A physiological study of leaf growth. Ann. Bot. 12:281-310.
- Moss, D.N.  
1962. The limiting carbon dioxide concentration for photosynthesis. Nature 193:587.



- Moss, D.N.  
1976. Studies on increasing photosynthesis in crop plants. In R.H. Burris and C.C. Black (eds ), CO<sub>2</sub> Metabolism and Plant Productivity, pp. 31-41. University Park Press, Baltimore
- Moss, D.N.; Musgrave, R.B.; and Lemon, E.R.  
1961. Photosynthesis under field conditions. III. Some effects of light, carbon dioxide, temperature, and soil moisture on photosynthesis, respiration, and transpiration of corn. *Crop Sci.* 1:83-87.
- Moss, D.N., and Peaslee, D.E.  
1965. Photosynthesis of maize leaves as affected by age and nutrient status. *Crop Sci.* 5:280-281.
- Moss, D.N., and Rawlins, S.L.  
1963. Concentration of carbon dioxide inside leaves. *Nature* 197:1320-1321.
- Motta, N., and Medina, E.  
1978. Early growth and photosynthesis of tomato (*Lycopersicon esculentum* L.) under nutritional deficiencies. *Turrialba* 28:135-141
- Mueller, S.; Brown, R.M., Jr.; and Scott, T.K.  
1976. Cellulosic microfibrils: Nascent stages of synthesis in a higher plant cell. *Science* 194:949-951.
- Munro, J.M.  
1971. An analysis of earliness in cotton. *Cotton Grow. Rev.* 48:28-41.
- Muramoto, H.  
1969. Hexaploid cottons: Some plant and fiber properties. *Crop Sci.* 9:27-29.
- Muramoto, H.; Hesketh, J.D.; and Elmore, C.D.  
1967. Leaf growth, leaf aging and leaf photosynthetic rates of cotton plants. *Beltwide Cotton Prod. Res. Conf. Proc.* pp. 161-165.
- Muramoto, H.; Hesketh, J.D.; and El-Sharkawy, M.  
1965. Relationships among rate of leaf area development, photosynthetic rate, and rate of dry matter production among American cultivated cotton and other species. *Crop Sci.* 5:163-166.
- Murashige, T., and Skoog, F.  
1962. A revised medium for rapid growth and bioassays with tobacco tissue cultures. *Physiol. Plant* 15:473-496.
- Murthi, A.N., and Weaver, J.B.  
1974. Histological studies on five male-sterile strains of upland cotton. *Crop Sci.* 14:658-663.
- Murty, P.S.S.; Ragu, D.N.; and Rao, G.V.H.  
1976. Effect of plant growth regulators on flower and boll drop in cotton. *Food Farming and Agric.*, Feb. 1976, pp. 9-12.
- Mussels, H., and Staples, R.C.  
1979. *Stress Physiology in Crop Plants*. Wiley Interscience N.Y.
- Mutsaers, H.J.W.  
1976. Growth and assimilate conversion of cotton bolls. 2. Influence of temperature on boll maturation period and assimilate conversion. *Ann. Bot.* 40:317-324.
- Mutsaers, H.J.W.  
1983a. Leaf growth in cotton. 1. Growth in area of main-stem and sympodial leaves. *Ann. Bot.* 51:503-520.
- Mutsaers, H.J.W.  
1983b. Leaf growth in cotton. 2. The influence of temperature, light, water stress and root restriction on growth and initiation of leaves. *Ann. Bot.* 51:521-529.
- Myers, J.  
1971. Enhancement studies in photosynthesis. *Ann. Rev. Plant Physiol.* 22:289-312

## N

- Nafziger, E.D., and Köller, H.R.  
1976. Influence of leaf starch concentration on CO<sub>2</sub> assimilation in soybean. *Plant Physiol.* 57:560-563.
- Nagarajah, S.  
1975a. Effect of debudding on photosynthesis in leaves of cotton. *Physiol. Plant.* 33:28-31.
- Nagarajah, S.  
1975b. The relation between photosynthesis and stomatal resistance of each leaf surface in cotton leaves. *Physiol. Plant.* 34:62-66.
- Nagarajah, S.  
1981. The effect of nitrogen on plant water relations in tea (*Camellia sinensis*). *Physiol. Plant.* 51:304-308.
- Naithani, S.C.; Rama Rao, N.; Krishnan, P.N.; and Singh, V.D.  
1981. Changes in *o*-diphenol oxidase during fiber development in cotton. *Ann. Bot.* 48:379-385.
- Nakayama, F.S., and Bucks, D.A.  
1980. Using subsurface trickle system for carbon dioxide enrichment. *In* Tomorrow's Agriculture Today Proc. Fifteenth Natl. Agr. Plastics Cong., April 13-17, 1980. pp. 13-18.
- Namken, L.N.; Heilman, M.D.; and Brown, R.G.  
1975. Flowering intervals, days to initial flower, and seedling uniformity as factors for development of short-season cotton cultivars. *Proc. 27th Cotton Improvement Conf.*, pp. 80-85.
- Namken, L.N.; Heilman, M.D.; and Dilday, R.H.  
1978. The relationship of fruiting characters in earliness and yield of selected genotypes. *Proc. 1978 Beltwide Cotton Res. Conf.* pp. 93.
- Nanjundayya, C.  
1951. Variation in weight per unit length along the length of a cotton fiber and its effect on the determination of other fiber properties. *The Ind. Cotton Grow. Rev.* VI. :171-183.
- Naryanan, K.  
1981. Demonstration of auxin binding to strawberry fruit. *Plant Physiol.* 68:1289-1293.
- National Academy of Sciences  
1979. Carbon Dioxide and Climate: A Scientific Assessment. National Research Council, Washington, D.C.
- National Cotton Council.  
1947-82. Proceedings of Annual Beltwide Cotton Defoliation and Physiology Conferences. National Cotton Council, Memphis.
- National Cotton Council  
1949. Cotton Defoliation: Report of Progress, National Cotton Council, Memphis. pp. 20.
- National Cotton Council  
1950. Chemical Defoliation of Cotton: Second Report of Progress. National Cotton Council, Memphis. pp. 25.
- National Cotton Research Task Force  
1979. Research Opportunities—Seed Quality, Processing, and End Use. *In* The 1979 National Cotton Research Task Force Report, USDA, the State Agricultural Experiment Station, and Cotton Industry Cotton Research Task Force.
- National Cottonseed Products Association.  
1977/78. Rules of the National Cottonseed Products Association. *Ann. Session of the Assoc.* 81:57-61.
- Natr, L.  
1970. Gas exchange of barley leaves as influenced by mineral nutrient deficiency. *Sci. Agr. Boh* 2:211-218.

Natr, L.

1975. Influence of mineral nutrition on photosynthesis and the use of assimilates. *In* J.P. Cooper (eds.), *Photosynthesis and Productivity in Different Environments*, pp 537-555. Cambridge University Press, Cambridge.

Neales, T.F., and Incoll, L.D.

1968. The control of leaf photosynthesis by the level of assimilate concentration in the leaf: A review of the hypothesis. *Bot Rev.* 34:107-125.

Neales, T.F., and Nicholls, A.O.

1978. Growth responses of young wheat plants to a range of ambient CO<sub>2</sub> levels *Aust J. Plant Physiol.* 5:45-59.

Negi, L.S., and Singh, A.

1956. A preliminary study on the effect of some hormones on yield of cotton. *Ind. Cotton Grow. Rev.* 10:153-156.

Nielsen, K.F., Halstead, R.L.; Maclean, A.J.; Bourget, S.J.; and Holmes, R M.

1961 The influence of soil temperature on the growth and mineral composition of corn, bromegrass, and potatoes. *Soil Sci. Soc. Amer. Proc.* 25:369-372.

Nelson, M.L.; Rousselle, M.A.; Ramey, H H , Jr ; and Barker, G.L.

1980. Closed-boll cotton I. Properties of never-dried cotton fibers before and after aqueous formaldehyde treatment. *Textile Res J.* 50:491-499.

Nelson, W.L.

1949 The effect of nitrogen, phosphorous and potash on certain lint and seed properties of cotton. *Agron. J.* 41:289-293.

Nevins, D.J , and Loomis, R.S.

1970. Nitrogen nutrition and photosynthesis in sugar beet (*Beta vulgaris* L.). *Crop Sci* 10:21-25.

Newcomb, E.H.

1969. Plant microtubulus. *Ann. Rev. Plant Physiol.* 20:253-288.

Newman, E.I

1966. A method of estimating the total length of root in a sample. *Jour. Appl. Ecol.* 3:139-145.

Newman, E.I

1974. Root and soil water relations. *In* E.W Carson (ed.), *The Plant Root and Its Environment*. pp. 363-441., University Press of Virginia

Newman, J.S.

1967. Yields and fiber properties of cotton planted in solid and skip-row systems under minimal soil moisture levels. *Texas Agr. Exp. Sta.*, MP 843.

Newton, P.

1966 The influence of increased CO<sub>2</sub> concentration and supplementary illumination on growth of tomato seedlings during the winter months. *Ann. Appl. Biol.* 57 345-353

Nielsen, K.F.

1974 Roots and root temperatures. *In* E W Carson (ed ), *The Plant Root and Its Environment*. pp 293-335 University Press of Virginia.

Nielsen, K.F., and Humphries, E.C.

1966. Effects of root temperature on plant growth. *Soils Fertility.* 29:1-7

Nieman, R H , and Paulsen, L.L.

1967. Interactive effects of salinity and atmospheric humidity on the growth of bean and cotton plants. *Bot Gaz* 128:59-73

Niles, G.A.

1967. Cotton seed quality (from the agronomist-geneticist viewpoint). *Proc. Beltwide Cotton Prod Res. Conf* 1967:177-188.

Niles, G.A.

1974. Growth and fruiting characteristics of short-season cottons. *Proc. 26th Cotton Improvement Conf.*, pp. 80.

- Nilsen, S.; Hovland, K.; Dons, C.; and Sletten, S.P.  
1983. Effect of CO<sub>2</sub> enrichment on photosynthesis, growth and yield of tomato. *Scientia Hort.* 20:1-14.
- Nilwik, H.J.M.; Gosiewski, W.; and Bierhuizen, J.F.  
1982. The influence of irradiance and external CO<sub>2</sub>-concentration on photosynthesis of different tomato genotypes. *Scientia Hort.* 16:117-123.
- Nobel, P.S.  
1974. *Biophysical Plant Physiology*. W.H. Freeman and Co., pp. 302-364.
- Nobel, P.S.  
1977. Internal leaf area and cellular CO<sub>2</sub> resistances: Photosynthetic implications of variations with growth conditions and plant species. *Physiol. Plant.* 40:137-144.
- Noggle, G.R.  
1971. Getting and maintaining a stand: Seed germination and seedling emergence. *Proc. Beltwide Cotton Prod. Res. Conf.* pp. 72-73.
- Noodén, L.D.  
1980. Senescence in the whole plant. *In* K.V. Thimann (ed.), *Senescence in Plants*, pp. 219-257. CRC Press, Boca Raton, FL.
- Noodén, L.D., and Leopold, A.C.  
1977. Hormonal control of senescence and abscission. *In* *Plant Hormones and Related Compounds*, D.S. Letham (ed.), pp. 179-213. Elsevier, Amsterdam.
- Nowak-Ossorio, M.; Gruber, E.; and Schurz, J.  
1976. Untersuchungen zur cellulosebildung in Baumwollsamem. *Protoplasma* 88:255-263.

## O

- Oakley, B.R.; Kirsh, D.R.; and Morris, N.R.  
1980. A simplified ultrasensitive silver stain for detecting proteins polyacrylamide gels. *Anal. Biochem.* 105:361-363.
- Oatout, C.H.  
1928. The vitality of soybean seed as affected by storage conditions and mechanical injury. *Agron. J.* 20:837-855.
- O'Farrell, P.H.  
1975. High resolution two-dimensional electrophoresis of proteins. *J. Biol. Chem.* 250:4007-4021.
- Ojima, M.; Fukui, S.; and Watanabe, I.  
1965. Studies on the seed production of soybean. II. Effect of three major nutrient elements supply and leaf age on the photosynthetic activity and diurnal changes in photosynthesis of soybean under constant temperature and light intensity. *Proc. Crop Sci. Soc. Japan* 33:437-442.
- O'Kelly, J.O.  
1953. The use of C<sup>14</sup> in locating growth regions in the cell wall of elongating cotton fibers. *Plant Physiol.* 28:281-286.
- O'Kelly, J.O., and Carr, P.H.  
1953. Elongation of the cotton fiber. *In* W.E. Loomis (ed.), *Growth and differentiation in plants*. Iowa State College Press. pp. 55-68.
- Olcott, H.S., and Fontaine, T.D.  
1941. The absence of lipase in cottonseed. *Oil and Soap* 18:123-124.
- O'Leary, J.W., and Knecht, G.N.  
1981. Elevated CO<sub>2</sub> concentration increases stomate numbers in *Phaseolus vulgaris* leaves. *Bot. Gaz.* 142:438-441.
- Olson, S.R., and Bledsoe, R.K.  
1942. The chemical composition of the cotton plant and the uptake of nutrients at different stages of growth. *Georgia Exp. Sta. Bull.* 222, pp. 1-16.

- Oimstead, C.E.  
1951 Experiments on photoperiodism dormancy and leaf age and abscission in sugar maple. *Bot. Gaz.* 112:365-393.
- Olvey, J.M.; Fisher, W.D.; and Patterson, L.L.  
1981 TD-1123. A selective male gametocide. *Proc. Beltwide Cotton Prod. Res. Conf.* pp. 84.
- Oosterhuis, D.M., and Wiebe, H.H.  
1980 Hydraulic conductivity and osmotic adjustment in drought acclimated cotton. *Plant Physiol.* 65:S-6 (suppl.)
- Osborne, D.J.  
1962 Effect of kinetin on protein and nucleic acid metabolism in *Xanthium* leaves during senescence. *Plant Physiol.* 37:595-602
- Osborne, D.J.  
1973. Internal factors regulation abscission. *In* *Shedding of Plant Parts*, T.T. Kozlowski (ed.), pp. 125-147. Acad. Press, New York and London.
- Osborne, D.J.  
1974. Hormones and the shedding of leaves and bolls. *Cotton Grow. Rev.* 51:256-265.
- Osborne, D.J.  
1978. Target cells—New concepts for plant regulation in horticulture. *Sci. Hort.* 30:1-13.
- Osborne, D.J.; Jackson, M.B., and Milborrow, B.V.  
1972. Physiological properties of abscission accelerator from senescent leaves. *Nature New Biol* 240:98-101
- Osborne, D.J., and Manchester, J.  
1979. Guard cell starch concentration quantitatively related to stomatal aperture. *Plant Physiol.* 64:79-82
- Osborne, D.J., and Moss, S.E.  
1963 Effect of kinetin on senescence and abscission in explants of *Phaseolus vulgaris*. *Nature (London)* 200:1299-1301.
- Osman, A.M., and Milthrope, F.L.  
1971. Photosynthesis of wheat leaves in relation to age, illuminance, and nutrient supply. II. Results. *Photosynthetica* 5:61-70.
- Osmond, C.B.; Winter, K.; and Powles, S.B.  
1980. Adaptive significance of carbon dioxide cycling during photosynthesis in water stressed plants. *In* N.C. Turner and P.J. Kramer (eds.), *Adaptation of Plants to Water and High Temperature Stress*. Wiley Interscience, N.Y. pp. 139-154.
- Owens, L.D.; Lieberman, M., and Kunishi, A.  
1971. Inhibition of ethylene production by rhizobitoxine. *Plant Physiol.* 48:1-4.

## P

- Paez, A., Hellmers, H.; and Strain, B.R.  
1980 CO<sub>2</sub> effects on apical dominance in *Pisum sativum*. *Physiol. Plant* 50:43-46.
- Paez, A., Hellmers, H.; and Strain, B.R.  
1983. CO<sub>2</sub> enrichment, drought stress and growth of Alaska pea plants (*Pisum sativum* L.). *Physiol. Plant.* 58:161-165.
- Paizieva, R.Z., Baram, N.I., Sagdieva, M.G.; and Ismailov, A.I.  
1977. A study of gossypolone and some of its derivatives. *Khim. Prir. Soedin.* (Tashk) pp. 858-859.
- Pallas, J.E., Bertrand, A.R.; Harris, D.G.; Elkins, C.B., Jr.; and Parks, C.L.  
1962. "Research in Plant Transpiration. 1962." Production Research Report No. 87. ARS-USDA-Georgia Agr. Exp. Sta. and Meteorology Dept. U.S. Army Electronics Research and Dev. Activity.

- Pallas, J.E., Jr.  
1965. Transpiration and stomatal opening with changes in carbon dioxide content of the air. *Science* 147:171-173
- Pallas, J.E., Jr.  
1970. Theoretical aspects of CO<sub>2</sub> enrichment. *Transactions of the Amer. Soc. Agric. Eng.* 13:240-245.
- Pallas, J.E., Jr.  
1973. Diurnal changes in transpiration and daily photosynthetic rate of several crop plants. *Crop Sci.* 13:82-84.
- Pallas, J.E., Jr.  
1979. Carbon dioxide. In T.W. Tibbitts and T.T. Kozlowski (eds.), *Controlled Environment Guidelines for Plant Research*, Acad. Press, New York, pp. 207-228.
- Pallas, J.E., Jr.; Michel, B.E.; and Harris, D.G.  
1967. Photosynthesis, transpiration, leaf temperature, and stomatal activity of cotton plants under varying water potentials. *Plant Physiol.* 42:76-88
- Pallas, J.E., Jr., and Wright, B.G.  
1973. Organic acid changes in the epidermis of *Vicia faba* and their implication in stomatal movement. *Plant Physiol.* 51:588-590.
- Pandey, S N., and Thejappa, N.  
1975. Study on the relationship between oil, protein and gossypol in cottonseed kernels. *J. Amer. Oil Chem. Soc.* 52:312-315.
- Parks, C.R.  
1965a. Floral pigmentation studies in the genus *Gossypium*. I. Species specific pigmentation patterns. *Amer. J. Bot.* 52:309-316.
- Parks, C.R.  
1965b. Floral pigmentation studies in the genus *Gossypium*. II. Chemotaxonomic analysis of diploid *Gossypium* species. *Amer. J. Bot.* 52:849-856.
- Parks, C.R., Ezell, W.L.; Williams, D.E.; and Dreyer, D.L.  
1975. VII. The application of flavanoid distribution to taxonomic problems in the genus *Gossypium*. *Bull. Torrey Bot. Club* 102:350-361.
- Parks, C.R.; Sandhu, S.S.; and Montgomery, K.R.  
1972. Floral pigmentation studies in the genus *Gossypium*. IV. Effects of different growing environments on flavonoid pigmentation. *Amer. J. Bot.* 59:158-164.
- Parrot, W.L., Jenkins, J.N.; and McCarty, J.C., Jr.  
1981. Performance of the high gossypol strain test under artificial infestation of tobacco budworm. *Proc. Beltwide Cotton Prod. Res. Conf.* pp. 82.
- Parrot, W.L., and Lane, H.C.  
1980. The effect of methomyl treatment on anthocyanin, chlorophyll and condensed tannin content of cotton leaves. *Proc. Beltwide Cotton Prod. Res. Conf.* pp. 88.
- Passioura, J.B.  
1972. The effect of root geometry on the yield of wheat growing on stored water. *Aust. J. Agric. Res* 23:745-752.
- Pate, J.B., and Duncan, E.N.  
1964. Viability of cottonseed after long periods of storage. *Crop Sci.* 4:342-343.
- Patrick, J.W., and Wareing, P.F.  
1976. Auxin-promoted transport of metabolites in stems of *Phaseolus vulgaris* L. *J. Exp. Bot.* 27:969-982
- Patterson, D.T., Bunce, J.A.; Alberte, R.S.; and van Volkenburgh, E.  
1977. Photosynthesis in relation to leaf characteristics of cotton from controlled and field environments. *Plant Physiol.* 59:384-387.
- Patterson, D.T., and Flint, E.P.  
1979. Effects of chilling on cotton (*Gossypium hirsutum*), Velvetleaf (*Abutilon theophrasti*), and Spurred Anoda (*Anoda cristata*). *Weed Sci.* 27:473-478.

- Patterson, D.T., and Flint, E.P.  
1980 Potential effects of global atmospheric CO<sub>2</sub> enrichment on the growth and competitiveness of C<sub>3</sub> and C<sub>4</sub> weed and crop plants. *Weed Sci.* 28:71-75.
- Patterson, D.T., and Flint, E.P.  
1982 Interacting effects of CO<sub>2</sub> and nutrient concentration on soybean (*Glycine max*), sicklepod (*Gassia obtusifolia*), and showy crotonaria (*Crotalaria spectabilis*). *Weed Sci.* 30:389-394.
- Patterson, L.L.; Buxton, D.R.; and Briggs, R.E.  
1978 Fruiting in cotton as affected by controlled boll set. *Agron J.* 70:118-122.
- Parvin, D.W., Jr.; Cooke, F.T.; and Stennis, E.A.  
1978. The economics of cotton seed quality. Proc. Beltwide Cotton Prod. Res. Conf. 1978 210-212.
- Paxton, K.W., and Roberts, D.L.  
1973. Economic feasibility of storing seed cotton in modules under Louisiana conditions. Field storage processing costs. Dept. Agric. Econ. Agribus, Louisiana State University Agric. Mech. Coll. Agric. Exp. Sta. Rep. No. 456, pp. 99.
- Peacock, H.A., and Hawkins, B.S.  
1970. Effect of seed source on seedling vigor, yield and lint characteristics of upland cotton. *Gossypium hirsutum* L. *Crop Sci.* 10:668-670.
- Peacock, H.S.; Reid, J.T.; and Hawkins, B.S.  
1971 Cotton (*Gossypium hirsutum* L.) yield, stand and bolls per plant as influenced by seed class and row width. *Crop. Sci.* 11:743-746.
- Pearson, C.J.  
1973 Daily changes in stomatal aperture and in carbohydrates and malate within epidermis and mesophyll of leaves of *Commelina cyanea* and *Vicia faba*. *Aust. J. Biol. Sci.* 26:1035-1044.
- Pearson, N.L.  
1949a. False moths in cotton: Their origin, description, and variation in number. *J. Agr. Res.* 78:705-717.
- Pearson, N.L.  
1949b. Mote types in cotton and their occurrence as related to variety, environment, position in lock, lock size, and number of locks per boll. *USDA Tech. Bull.* No. 100.
- Pearson, R.W.  
1974. Significance of rooting pattern to crop production and some problems of root research. In E.W. Carson (ed.), *The Plant Root and Its Environment* pp. 247-270. University Press of Virginia.
- Pearson, R.W., and Lund, Z.F.  
1968. Direct observation of cotton root growth under field conditions. *Agron. J.* 60:442-443.
- Pearson, R.W.; Ratliff, L.F.; and Taylor, H.M.  
1970. Effects of soil temperature, strength, and pH on cotton seedling root elongation. *Agron. J.* 62:243-246.
- Pearson, G.I.  
1980. Carbon Dioxide and Climate: Australian Research. Australian Academy of Science, Canberra, Australia. pp. 217.
- Peavey, D.G.; Stup, M.; and Gibbs, M.  
1977 Characterization of starch breakdown in isolated spinach chloroplasts. *Plant Physiol.* 60:305-308.
- Peet, M.M.; Bravado, A.; Wallace, D.H., and Oxbun, J.L.  
1977 Photosynthesis, stomatal resistance, and enzyme activities in relation to yield of field-grown dry bean varieties. *Crop Sci.* 17:287-293.
- Peet, M.M., and Kramer, P.J.  
1980. Effects of decreasing source/sink ratio in soybeans on photosynthesis, photorespiration, transpiration and yield. *Plant, Cell and Environment* 3:201-206.
- Pegelow, E.J., Jr.; Buxton, D.R.; Briggs, R.E.; Muramoto, H.; and Gensler, W.G.  
1977. Canopy photosynthesis and transpiration of cotton as affected by leaf type. *Crop Sci.* 17:1-4.

- Perchorowicz, J.T.; Raynes, D.A.; and Jensen, R.G.  
1981. Light limitation of photosynthesis and activation of ribulose biphosphate carboxylase in wheat seedlings. Proc. Nat'l. Acad. Sci. USA 78:2985-2989.
- Perchorowicz, J.T.; Raynes, D.A.; and Jensen, R.G.  
1982. Measurement and preservation of the *in vivo* activation of ribulose 1,5-biphosphate carboxylase in leaf extracts. Plant Physiol. 69:1165-1168.
- Perkins, H.F., and Douglas, A.G.  
1965. Effects of nitrogen on yield and certain properties of cotton. Agron. J. 57:383-384.
- Perry, D.A.  
1970. The relation of seed vigor to field establishment of garden pea cultivars. J. Agric. Sci., Camb. 74:343-348.
- Perry, D.A.  
1978. Report of the vigor test committee 1974-1977. Seed Sci. and Tech. 6:159-181.
- Perry, J.S., and Hall, C.W.  
1965. Mechanical properties of pea beans under impact loading. Trans. of the ASAE 8:891-893.
- Perry, S.W.  
1981. Photosynthesis: Photorespiration ratios of cotton as affected by genotype and environment. M.S. Thesis. pp. 64.
- Perry, S.W., and Krieg, D.R.  
1981. Gross: Net Photosynthesis ratios of cotton as affected by environment and genotype. Proc. Beltwide Cotton Prod. Res. Conf. 35:51-52.
- Peterschmidt, N.A., and Quisenberry, J.E.  
1981. Plant water status among cotton genotypes. Proc. 1981 Beltwide Cotton Prod. Res. Conf. pp. 43-44.
- Petkar, B M.; Oka, P.G.; and Sundaram, V.  
1977. Cross-sectional shape of fibers of different group lengths in a sample of cotton. ISCI Journal: 23-27.
- Phelps, R.A., Cherry, J.P.; Hyer, A.H.; Cavanagh, G.C.; Harper, G.A.; Jernigan, J.E.; Hess, D.C.; and Lorraine, D.G.  
1979. Advancements in cottonseed quality-Industry's viewpoint. Cotton Gin and Oil Mill Press 80:14-15.
- Phillips, J.R.; Herzog, G.A.; and Nicholson, W.F.  
1977. Effect of chlordimeform on fruiting characteristics and yield of cotton. Ark. Farm. Res. 27:4-5.
- Phillips, M  
1964. Ribonucleoprotein particles from storage tissue of mature seeds. Biochem. Biophys. Acta 91:350-351.
- Pillay, K P., and Shankaranarayana, K S.  
1961. Variation in the properties of cotton fibers with length. Text Res. J. 31:515-525.
- Pillet, P.E., et Collet, G.  
1960. Etude du nanisme I. Action de l'acide gibberellique sur la croissance et la destruction *in vitro* des auxines. Bull. Soc. Bot. Suisse, 70:180-194.
- Pinckard, J.A., and Melville, D.  
1977. Cottonseed quality affects stand and yield. Proc. Beltwide Cotton Prod. Res. Conf. pp. 25-26.
- Pinkas, L.L.H.  
1972. Modification of flowering in Pima cotton with ethephon. Crop Sci. 12:465-466.
- Pinkhasov, Y.I.  
1981. Photosynthesis, transport of photosynthetic products, and development of methods of regulating transport in cotton. Biology Bulletin of the Academy of Sciences of the USSR. 8:231-241.
- Pinkhasov, Y.I. and Tkachenko, L.V.  
1981. Competitive relations in assimilate consumption between different fruits of cotton plants. Translated from Fiziologiya Rastanii 28:130-135.



- Plaut, Z.; Halevy, A.H., and Diskin, Y.  
1975 Diurnal pattern of plant water status and CO<sub>2</sub> fixation of roses as affected by irrigation regimes. J. Amer. Soc. Hort. Sci. 100:191-194.
- Pollock, E.G., and Jensen, W.A.  
1964. Cell development during early embryogenesis in *Capsella* and *Gossypium*. Amer. J. Bot. 51:915-921.
- Pollock, B.M., and Roos, E.E.  
1972. Seed and seedling vigor Vol. 1:314-388. In T.T. Kozlowski (ed.), Seed Biology. Acad. Press, New York.
- Pons, W.A., Hoffpauir, C.L.; and Hopper, T.H.  
1953. Gossypol in cottonseed. Influence of variety of cottonseed environment Agric. Food Chem. 1:1115-1118.
- Pope, O.A., and Ware, J.O.  
1945. Effect of variety, location and season on oil, protein, and fuzz on cottonseed and on fiber properties of lint. USDA Tech. Bull. No. 903
- Popova, P.Y.; Nuritdinova, F.N., Imamaliyev, A.I.; and Madzhitova, K.D.  
1979. Differences in phenol-compound content and character of fiber formation in wild and cultivated cotton. Sel'sk. Nauk. Im. V.I. Lenina No. 8 pp. 22-25.
- Porter, D.D.  
1936. Positions of seeds and nodes in locks and lengths of cotton fibers from bolls borne at different positions on plants at Greenville, TX. USDA Tech. Bull. 509.
- Porterfield, J., and Smith, E.M.  
1956. Physical characteristics and field performance of mechanically graded acid-delinted cottonseed. Okla. Agr. Sta. Tech. Bull. T-60. pp. 24.
- Portis, A.R., Jr.; Chon, C.J.; Mosbach, A.; and Heldt, H.W.  
1977. Fructose and sedoheptulose bisphosphatase: The sites of a possible control of CO<sub>2</sub> fixation by light-dependent changes of the stromal Mg<sub>2+</sub> concentration. Biochimica et Biophysica Acta, 461:313-325
- Potter, J.R., and Breen, P.J.  
1980. Maintenance of high photosynthetic rates during the accumulation of high leaf starch levels in sunflower and soybean. Plant Physiol. 66:528-531.
- Potts, H.C.  
1978. Hard seeded soybeans. Proc. 8th Soybean Seed Res. Conf. (ASTA) 8:33-42.
- Potts, H.C.; Daungapatra, J.; Hairston, W.G.; and Delonche, J.C.  
1975. Some influences of hardseededness on soybean seed quality. Crop Sci. 18:221-224.
- Powell, R.D.  
1969. Effect of temperature on boll set and development of *Gossypium hirsutum*. Cotton Grow Rev. 46:29-36.
- Powell, R.D., and Morgan, P.W.  
1973. A test system for the germination of cotton seed. Cotton Grow. Rev. 50:268-273.
- Powles, S.B.  
1979. The role of carbon assimilation and photorespiratory carbon cycling in the avoidance of photoinhibition in intact leaves of C<sub>3</sub> and C<sub>4</sub> plants. Ph.D. Dissertation, Australian National University.
- Prakash, G.  
1976. A senescence factor and foliar abscission in *Catharanthus roseus*. Ann. Bot. 40:537-541.
- Pratt, C., and Wender, S.H.  
1959. Identification of rutin and isoquercitrin in cottonseed. J. Amer. Oil Chem. Soc. 36:392-394.
- Pratt, C., and Wender, S.H.  
1961. Identification of kaempferol-3-rhamnoglucoside and quercetin-3-glucoglucoside in cottonseed. J. Amer. Oil Chem. Soc. 38:403-404.
- Prentice, A.N.  
1972. Cotton with Special Reference to Africa. Longman, London. pp. 282.

- Preiss, J., and Levi, C.  
1979. Metabolism of starch in leaves. *In* Photosynthesis II. Photosynthetic Carbon Metabolism and Related Processes, M. Gibbs, and E. Latzko (eds.), Encyclopedia of Plant Physiology, Vol. 6. Springer-Verlag, N.Y. pp. 282-312
- Preiss, J., and Levi, C.  
1980. Starch biosynthesis and degradation. *In* P.K. Stumpf and E.E. Conn (eds.), The Biochemistry of Plants, Vol. 3, Acad Press, N.Y. pp. 371-423.
- Presley, J.T.  
1958. Relation of protoplast permeability to cottonseed and predisposition to seedling disease. *Plant Dis. Repr.* 42:852.
- Presley, J.T., and Christiansen, M.N., and Carns, H.R.  
1967. Pathological and physiological aspects of seed quality. *Proc. Beltwide Cotton Prod. Res Conf.* 1967:189-192.
- Presley, J.T., and Leonard, O.A.  
1948. The effect of calcium and other ions on the early development of the radicle of cotton seedlings. *Plant Physiol.* 23:516-525.
- Price, H.J., and Smith, R.H.  
1977. Tissue culture of *Gossypium* species and its potential in cotton genetics and crop improvement. *Beltwide Cotton Prod. Res Conf. National Cotton Council, Memphis, TN.* pp. 51-55.
- Price, H.J., and Smith, R.H.  
1979. Somatic embryogenesis in suspension cultures of *Gossypium klotzschium* Anderss. *Planta* 145:305-307.
- Prokofev, A.A.; Rasulov, S., and Bokarev, K.S.  
1977. Physiologically active substances as regulators of cotton growth and productivity. *Soviet Plant Physiol.* 24:597-601.
- Puente, F.  
1966. Some effects of soil temperature and phosphorus and calcium levels on cotton seedling growth. *Dissertation Abstr.* XXVI:4157.
- Pundir, N.S.  
1972. Experimental embryology of *Gossypium arboreum* L. and *G. Hirsutum* L. and their reciprocal crosses. *Bot Gaz* 133:7-26.
- Purohit, A.W., and Tregunna, E.B.  
1974. Effects of carbon dioxide on *Pharbitis*, *Xanthium*, and *Silene* in short days. *Can. J. Bot.* 52:1283-1291.

## Q

- Quarrie, S.A.  
1980. Genotypic differences in leaf water potential, abscisic acid and proline concentrations in spring wheat during drought stress. *Ann. Bot.* 46:383-394.
- Quintanilha, A.; Salazar, D'Eca L.; and Cabral, A.  
1962. Desenvolvimento do butao flora do algodoeiro em funcao do tempo. *Bol. Soc. Broteriana* 36 (Ser. 2a).189-215.
- Quisenberry, J.E., and Gipson, J.R.  
1974. Growth and productivity of cotton grown from seed produced under four night temperatures. *Crop Sci.* 14:300-302.
- Quisenberry, J.E.; Jordan, W.R.; Roark, B.A.; and Fryrear, D.W.  
1981. Exotic cotton as genetic sources for drought resistance. *Crop Sci.* 21:889-895.
- Quisenberry, J.E., and Kohel, R.J.  
1975. Growth and development of fiber and seed in upland cotton. *Crop Sci.* 15:463-467

- Quisenberry, J.E., Ray, L.L.; and Jones, D.L.  
1975. Responses of upland cotton to selection for fiber length and fineness in a nonirrigated semiarid environment. *Crop Sci.* 15:407-409.
- Quisenberry, J.E., and Roark, B.  
1976. Influence of indeterminate growth habit on yield and irrigation water-use efficiency in upland cotton. *Crop Sci.* 16:762-765

## R

- Radin, J.W.  
1977 Contributions of the root systems to nitrate assimilation in whole cotton plants. *Aust. J. Plant Physiol.* 4:811-819.
- Radin, J.W.  
1981. Water relations of cotton plants under nitrogen deficiency. IV. Leaf senescence during drought and its relation to stomatal closure. *Physiol. Plant.* 51:145-149
- Radin, J.W.  
1983a. Control of plant growth by nitrogen: Differences between cereals and broadleaf species. *Plant Cell, and Env.* 6:65-68.
- Radin, J.W.  
1983b. Physiological consequences of cellular water deficits: Osmotic adjustment. *In* H.M. Taylor, W.R. Jordan, and T.R. Sinclair (eds.), *Limitations to Efficient Water Use in Crop Production*. American Society of Agronomy, Madison, Wisconsin. pp 267-276
- Radin, J.W., and Ackerson, R.C.  
1981. Water relations of cotton plants under nitrogen deficiency. III. Stomatal conductance, photosynthesis, and abscisic acid accumulation during drought. *Plant Physiol.* 67:115-119
- Radin, J.W., and Boyer, J.S.  
1982. Control of leaf expansion by nitrogen nutrition in sunflower plants: Role of hydraulic conductivity and turgor. *Plant Physiol.* 69:771-775.
- Radin, J.W., and Elmore, C.D.  
1980. Concepts of translocation with special reference to the assimilation of nitrogen and its movement into fruits. *In* J.D. Hesketh and J.W. Jones (eds.), *Predicting Photosynthesis for Ecosystem Models*, Vol. II. CRC Press, Boca Raton, FL. pp 143-154.
- Radin, J.W., and Parker, L.L.  
1979a. Water relations of cotton plants under nitrogen deficiency I. Dependence upon leaf structure. *Plant Physiol.* 64:495-498
- Radin, J.W., and Parker, L.L.  
1979b. Water relations of cotton plants under nitrogen deficiency II. Environmental interactions on stomata. *Plant Physiol.* 64:499-501.
- Radin, J.W.; Parker, L.L.; and Gunn, G.  
1982. Water relations of cotton plants under nitrogen deficiency V. Control of abscisic acid accumulation and stomatal sensitivity to abscisic acid. *Plant Physiol.* 70:1066-1070.
- Radin, J.W.; Parker, L.L., and Sell, C.R.  
1978. Partitioning of sugar between growth and nitrate reduction in cotton roots. *Plant Physiol.* 62:550-553.
- Radin, J.W., and Sell, C.R.  
1975. Some factors limiting nitrate reduction in developing ovules of cotton. *Crop Sci.* 15:713-715
- Radin, J.W., and Trelease, R.N.  
1976. Control of enzyme activities in cotton cotyledons during maturation and germination. I. Nitrate reductase and isocitrate lyase. *Plant Physiol.* 57:902-905.
- Raes, G.; Franssen, T.; and Verschraege, L.  
1968. Study of the reversal phenomenon in the fibrillar structure of the cotton fiber. *Text. Res. Journ.* 38:182-195

- Racs, G.; Franssen, T.; and Verschraege, L.  
1971. Headlines of a study reversal phenomenon in the fibrillar structure of the cotton fibers. *Ann. Sci. Text. Belg.* pp. 68-90.
- Rajanna, B.  
1972. Heat damage to cottonseed (*Gossypium hirsutum* L.) and its effects on seed quality and plant growth and development. Ph.D. Dissertation. Mississippi State University, Miss. State, MS. pp. 100.
- Rajaraman, S., and Nanjundayya, C.  
1955. Variation of certain fiber properties with group-lengths of a cotton with special reference to pressley strength index. *The Ind. Cotton Grow. Rev.* X:236, 242.
- Ramakrishnon, C.U., and Nevgi, G.U.  
1951. Studies on enzyme lipase. *Proc. Indian Acad. Sci.* 33B, pp. 268-276.
- Ramchandani, S.; Joshi, P.C.; and Pundir, N.S.  
1966. Seed development in *Gossypium* L. *Indian Cotton Journ.* 20:97-106.
- Ramey, H.H., Jr.  
1970. Quality control concepts in cotton production. *Cotton Grow Rev.* 47:305-309.
- Ramey, H.H., Jr.  
1980. Fiber crops, Chapter 2. In C.S. Hoveland (ed.), *Crop Quality, Storage and Utilization*, Crop Science Society of America, Madison, Wisconsin pp. 35-39.
- Ramey, H.H., Jr.; Lawson, R.; Duckett, K.E.; and French, A.L.  
1982. Effect of boll age and mercerization on cotton fiber properties. *Text. Res. Journ.* 52:250-255.
- Ramey, H.H., Jr., and Worley, S., Jr.  
1973. Use of yield models to compare products of breeding programs. *Beltwide Cotton Prod. Res. Conf. Proc.* pp. 63.
- Ramsey, J.C., and Berlin, J.D.  
1976a. Ultra-structure of early stages of fiber differentiation. *Bot. Gaz.* 139:11-19.
- Ramsey, J.C., and Berlin, J.D.  
1976b. Ultra-structural aspects of early stages in cotton fiber elongation. *Amer. J. Bot.* 63:868-876.
- Randolph, L.F., and Cox, L.G.  
1943. Factors influencing the germination of Iris seed and the relation of inhibiting substances of embryo dormancy. *Proc. Amer. Soc. Hort. Sci.* 43:284-304.
- Rani, A., and Bhojwani, S.S.  
1976. Establishment of tissue cultures of Cotton. *Plant Sci. Lett.* 7:163-169.
- Ranney, C.D., and Wooten, O.B.  
1966. Effect of petroleum mulch on the growth and yield of cotton. *Proc. Joint Mtg. 26th Cotton Dis Council, 20th Cotton Defol.—Physiol. Conf. and 18th Cotton Improvement Conf.* pp. 327-335.
- Rao, S.R.; Carter, F.L.; and Frampton, V.L.  
1963. Determination of available lysine in oilseed meal proteins. *Anal. Chem.* 35:1927-1930.
- Raper, C.D., Jr., and Downs, R.J.  
1973. Factors affecting the development of flu-cured tobacco grown in artificial environments. IV. Effects of carbon dioxide depletion and light intensity. *Agron. J.* 65:247-252.
- Raper, C.D., Jr., and Peedin, G.F.  
1978. Photosynthetic rate during steady-state growth as influenced by carbon-dioxide concentration. *Bot. Gaz.* 139:7-149.
- Rappaport, L.  
1980. Plant growth hormones: Internal control points. *Bot. Gaz.* 141:125-130.
- Raschke, K.  
1972. Saturation kinetics of the velocity of stomatal closure in response to CO<sub>2</sub>. *Plant Physiol* 49:229-234.
- Raschke, K.  
1974. Abscisic acid sensitizes stomata to CO<sub>2</sub> in leaves of *Xanthium strumarium* L. *Proc. 8th International Conf. on Plant Growth Substances, Tokyo.* pp. 1151-1158.

- Raschke, K  
1975a. Simultaneous requirement of carbon dioxide and abscisic acid for stomatal closing in *Xanthium strumarium* L. *Planta* 125:243-259
- Raschke, K  
1975b. Stomatal action. *Ann. Rev. Plant Physiol.* 26:309-340.
- Raschke, K.  
1976. How stomata resolve the dilemma of opposing priorities. *Philos. Trans. Roy. Soc. London Ser. B* 273:551-560.
- Raschke, K.  
1979. Movements of stomata. Chapter 4. In W. Haupt and M.E. Feinleib (eds), *Encyclopedia of Plant Physiology* new series, Vol 7. pp. 383-441. Springer-Verlag, Berlin.
- Raschke, K.; Pierce, M., and Popielka, C.C.  
1976. Abscisic acid content and stomatal sensitivity to CO<sub>2</sub> in leaves of *Xanthium strumarium* L. after pretreatments in warm and cold growth chambers. *Plant Physiol.* 57:115-121.
- Rast, L.E.  
1917. Cotton varieties in Georgia. Variation of the oil content of cottonseed and resistance to disease. *Bull. Ga. Coll. Agric.* 121. pp.36.
- Ratner, A.; Goren, R., and Monselise, S P  
1969. Activity of pectin esterase and cellulase in the abscission zone of citrus leaf explants. *Plant Physiol.* 44:1717-1723.
- Raven, J.A., and Rubery, P.H.  
1982. Coordination development: Hormone receptors, hormone action and hormone transport. In H. Smith and D. Grierson (eds), *The Molecular Biology of Plant Development*, Blackwell Scientific, Oxford, pp 28-48.
- Ray, L.L.  
1963. Systemic induction of parthenocarpic fruit set in cotton with gibberellin. *Crop Sci.* 3:448-449
- Ray, L.L.  
1972. Growth and fruiting comparisons of early maturing lines of cotton. *Proc. 24th Cotton Improvement Conf.*, pp. 64-65.
- Ray, L.L., and Minton, E.B.  
1973. Effects of field weathering on cotton lint yield-seed quality-fiber quality. *Texas Agr. Exp. Sta. Bull.* MP-1118.
- Ray, L.L., and Richmond, T.R.  
1966. Morphological measures of earliness of crop maturity in cotton. *Crop Sci.* 6:527-531.
- Ray, L.L., and Supak, J.  
1977. Performance of glandless cotton varieties in the Texas High Plains. *Texas Agr. Exp. Sta. Misc. Publ.* 1338, pp. 4.
- Ray, P.M  
1980. Early auxin and fusaric acid effects on β-glucan synthetase activity in peas. *Plant Physiol (suppl.)* 65(b):131.
- Rea, H.E.  
1928. Location of "motes" in the upland cotton lock. *Agron. J.* 20:1064-1068
- Rea, H.E.  
1929. Varietal and seasonal variation of "motes" in upland cotton. *Agron. J.* 21 481-486.
- Reddy, V R.  
1981. "Validation of the Cotton Simulation Model GOSSYM." Ph.D. Dissertation. Mississippi State University.
- Reddy, V.R.; Sekhara, C; and Prabhaker, A S  
1979. Preliminary studies on the effect of seed soaking with cycocel on the germination and early growth of groundnut and cotton. *Food, Farming and Agr.* 10:330-332.
- Reeves, R.G.  
1936. Comparative anatomy of the seeds of cotton and other malvaceous plants. *Amer. J. Bot.* 23:394-405.

- Reeves, R.G., and Beasley, J.O.  
1935. The development of the cotton embryo. *J. Agric. Res.* 51:935-944.
- Rehm, M.M., and Cline, M.G.  
1973. Rapid growth inhibition of *Avena* coleoptile segments by abscisic acid. *Plant Physiol.* 51:93-96.
- Reicosky, D.C.; Millington, R.J.; Klute, A.; and Peters, D.B.  
1972. Patterns of water uptake and root distribution of soybeans (*Glycine max.*) in the presence of a water table. *Agron. J.* 64:292-297.
- Reid, P.D.; Lew, F.T.; and Lewis, L.N.  
1971. Cellulase isozymes in *Phaseolus vulgaris* abscission zones. *Plant Physiol.* 47S:42.
- Reid, P.D.; Strong, P.G.; Lew, F.; and Lewis, L.N.  
1974. Cellulase and abscission in the red kidney bean (*Phaseolus vulgaris*). *Plant Physiol.* 53:732-737.
- Reyes, L.  
1980. Performance of Texas A&M multi-adversity resistant (TAM-MAR) cottons in the Texas Coastal Plains. *Texas Agr. Exp. Sta. Prog. Rept.* 3757. pp. 13.
- Reynolds, A.C., and Maravolo, N.C.  
1973. Phenolic compounds associated with development in the liverwort *Marchantia polymorpha*. *Amer. J. Bot.* 60:406-413.
- Reynolds, R.  
1968. Quick-starting cotton. *The Furrow.* April/March pp. 10.
- Ribereau-Gayon, P.  
1972. *Plant Phenolics.* Hafner Publishing Co. N.Y.
- Richards, R.A., and Passioura, J.B.  
1981a. Seminal root morphology and water use of wheat. I. Environmental effects. *Crop Sci.* 21:249-252.
- Richards, R.A., and Passioura, J.B.  
1981b. Seminal root morphology and water use of wheat. II. Genetic variation. *Crop Sci.* 21:253-255.
- Richmond, T.R., and Fulton, H.J.  
1936. Variability of fiber length in a relatively uniform strain of cotton. *J. Agric. Res.* 53:749-761.
- Richmond, T.R., and Radwan, S.R.H.  
1962. Comparative study of seven methods of measuring earliness of crop maturity in cotton. *Crop Sci.* 2:397-400.
- Rijks, D.A.  
1965. The use of water by cotton crops in Abyan, South Arabia. *J. Appl. Ecol.* 2:317-343.
- Rikin, A.; Atsmon, D.; and Giller, C.  
1979. Chilling injury in cotton (*Gossypium hirsutum* L.): Prevention by abscisic acid. *Plant & Cell Physiol.* 20:1537-1546.
- Riley, J.A.; Newton, D.H.; Measells, J.W.; Downey, D.A.; and Hand, L.  
1964. Soil temperatures and cotton planting in the mid-South. *Miss. Agr. Exp. Sta. Bull.*, pp. 678.
- Riov, J.  
1974. A polygalacturonase from citrus leaf explants: Role in abscission. *Plant Physiol.* 53:312-316.
- Ritchie, J.T., and Burnett, E.  
1971. Dryland evaporative flux in a subhumid climate: II. Plant influences. *Agron. J.* 63:56-62.
- Rivera, C.M. and Penner, D.  
1978. Effect of calcium and nitrogen on soybean (*Glycine max*) root fatty acid composition and uptake of linuron. *Weed Sci.* 26:647-650.
- Roane, C.W., and Starling, T.M.  
1958. Effects of mercury fungicides and insecticides on germination, stand, and yield of sound and damaged seed wheat. *Phytopath.* 48:219-233.

- Roark, B.; Pfrimmer, T R.; and Merkle, M.E.  
1963. Effect of some formulations of methyl parathion, toxaphene, and DDT on the cotton plant. *Crop Sci* 3:338-341.
- Roark, B , and Quisenberry, J.E  
1977 Environmental and genetic components of stomatal behavior in two genotypes of upland cotton. *Plant Physiol.* 59:354-356.
- Roberts, D.L.; Paxton, K.W., and Gill, R.L.  
1973. The module system: A new approach in storing seed cotton. *La. Agric.* 16.4-5, 7.
- Roberts, D.L ; Paxton, K W.; and Koonce, K.L.  
1974. The effect of module storage on cotton quality. D.E.A. Research Report No 471. Louisiana State University, Baton Rouge, ALA pp. 37.
- Robertson, F.R , and Campbell, J.G.  
1933. Some observations on the increase of free fatty acid in cottonseed. *Oil and Soap* 10:146-147.
- Rodgers, J.P.  
1980a. Cotton fruit development and abscission: Growth and morphogenesis. *South African J of Sci.* 76 90-92
- Rodgers, J.P.  
1980b. "Cotton Fruit Development and Abscission Changes in Endogenous Abscisic Acid-like Substances." *South African J. of Sci.* 76 471-474.
- Rodgers, J.P.  
1981a Cotton fruit development and abscission Variations in the level of auxins *Trop Agr (Trin.)* 58 63-72
- Rodgers, J.P  
1981b. Cotton fruit development and abscission: Fluctuations in the level of cytokinins. *J. of Hort. Sci.* 56 99-106.
- Rodgers, J.P.  
1981c. Cotton fruit development and abscission. The role of gibberellin-like components. *South African J. of Sci.* 77:363-366.
- Roelofsen, A.  
1959. The plant cell wall in *Handbuch der Pflanzenanatomie*. Gebrüder Borntraeger, Berlin pp 227-242
- Rogers, H.H., Beck, R.D.; Gingham, G E.; Cure, J.D., Davis, J.M.; Heck, W W ; Rawlings, J.D ; Riordan, A J ; Stonit, N ; Smith, J M.; and Thomas, J.F.  
1981. Response of Vegetation to Carbon Dioxide. Progress Report of Research. Field Studies of Plant Responses to Elevated Carbon Dioxide Levels. No. 005 Botany Department, North Carolina State University, Raleigh
- Rogers, H.H., Bingham, G.E ; Cure, J.D.; Heck, W W.; Heagle, A.S ; Israel, D.W ; Smith, J.M., Surano, K.A.; and Thomas, J.F.  
1980 Response of Vegetation to Carbon Dioxide Progress Report of Research Field Studies of Plant Responses to Elevated Carbon Dioxide Levels No 001. Botany Department, North Carolina State University.
- Rogers, H.H.; Bingham, G.E.; and Thomas, J.F.  
1982a Response of Vegetation to Carbon Dioxide. Progress Report of Research: Field Studies of Plant Responses to Elevated Carbon Dioxide Levels No. 009. Joint Program of the U.S Department of Energy and the USDA Botany Department, North Carolina State University, Raleigh. pp. 231.
- Rogers, H.H ; Bingham, G.E ; Thomas, J.F.; Smith, J.M.; Israel, D.W.; and Surano, K.A  
1982b. Effects of long-term carbon dioxide concentrations on field grown crops and trees. *In* Global Dynamics of Biospheric Carbon, U.S. Department of Energy, Washington, D.C. pp. 9-45.
- Rogers, H.H.; Heck, W W., and Heagle, A S  
1982c A field technique for the study of plant responses to elevated carbon dioxide concentrations. *J. Air Pollution Control Assoc.* 33:42-44

Roland, J.C.; Vian, B.; and Reis, D.

1975. Observations with cytochemistry and ultracyotomy on the fine structure of the expanding walls in actively elongating plants. *J. Cell. Sci.* 19:239-259.

Rollins, M.L.

1945. Applications of Nitrogen dioxide treatment to the microscopy of fiber cell wall structure. *Text. Res. Journ.* 15:65-77.

Rollins, M.L.

1968a. The cotton fiber. Chap. 3 in *The American Cotton Handbook*.

Rollins, M.L.

1968b. Cell wall structure and cellulose synthesis. *Forest Products Journ.* 18:91-100.

Roncadori, R.W.; McCarter, S.M.; and Crawford, J.L.

1971. Influence of fungi on cotton seed deterioration prior to harvest. *Phytopath.* 61:1326-1328

Rose, C.W., and Stern, W.R.

1967. Determination of withdrawal of water from soil by crop roots as a function of depth and time. *Aust. J. Soil Res.* 5:11-19.

Rose, R.J.; Setterfield, G.; and Fowke, L.C.

1972. Activation of nucleoli in tuber slices and the function of nucleolar vacuoles. *Expt. Cell Res.* 71:1-16.

Rosenberg, N.J.

1981. The increasing CO<sub>2</sub> concentration in the atmosphere and its implication in agricultural productivity. I. Effects in photosynthesis, transpiration, and water use efficiency. *Climate Change* 3:265-279.

Ross, A.F., and Wilhamson, C.E.

1951. Physiologically active emanations from virus infected plants. *Phytopath.* 41:431.

Rossi-Fanelli, A.

1968. Investigations of the physical and physico-chemical properties of cottonseed proteins to obtain basic information needed for the increased utilization of cottonseed. Project UR-15-(40)-33, Istituto di Chimica Biologica, Rome, Italy.

Rossi-Fanelli, A.; Antonini, E.; Brunori, M.; Bruzzesi, M.R.; Caputo, A.; and Satriani, F.

1964. Isolation of a monodisperse protein fraction from cottonseeds. *Biochem. Biophys. Res. Comm.* 15:110-115

Rossi-Fanelli, A.; Cavallini, D.; Mondoni, B.; Wolf, A.M.; Scioscia-Santoro, A.; and Riva, F.

1965. *Asch Biochem, Biophysics* 110:85-90.

Rousselle, M.A.; Nelson, M.L.; Ramey, H.H., Jr.; and Barker, G.L.

1980. Closed-boll cotton. III. Effect of treatment with propylene oxide on sorptive and mechanical properties of fibers and yarns. *Ind. Eng. Chem. Prod. Res. Dev.* 19:654-659.

Rubern, P.H.

1981. Auxin receptors. *Ann. Rev. Plant Physiol.* 32:569-596.

Rubinstein, B., and Leopold, A.C.

1962. Effects of amino acids on bean leaf abscission. *Plant Physiol.* 37:398-401.

Rubinstein, B., and Leopold, A.C.

1963. Analysis of auxin control of bean leaf abscission. *Plant Physiol.* 38:262-267.

Rubinstein, B., and Leopold, A.C.

1964. The nature of leaf abscission. *Quart. Rev. Biol.* 39:356-372.

Rusca, R.A., and Gerdes, F.L.

1942. Effects of artificially drying seed cotton on certain quality elements of cottonseed in storage. *USDA Circular No. 615*.

Russell, E.J., and Appleyard, A.

1915. The atmosphere of the soil: Its composition and the causes of variation. *J. Agric. Sci.* 7:1-48.

Russell, R.A., and Goss, M.J.

1974. Physical aspects of soil fertility—The response of roots to mechanical impedance. *Neth. J. Agric. Sci.* 22:305-318.



- Russell, R.S.  
1977. *Plant Root Systems, Their Function and Interaction With the Soil*. McGraw-Hill Book Co. London.
- Russell, T.E., Watson, T.F.; and Ryan, G.F.  
1976. Field accumulation of aflatoxin in cottonseed as influenced by irrigation termination dates and pink bollworm infestation. *Appl. and Environ. Microbiol.* 31:711-713.
- Ruyack, J., Downing, M.R.; Chang, J.S.; and Mitchell, E.D.  
1979. Growth of callus and suspension culture cells from cotton varieties (*Gossypium hirsutum* L.) resistant and susceptible to *Xanthomonas malvacearum* (E.F. Sm.). *Dows In vitro* 15:368-373.
- Ryffel, G.U., and McCarthy, B.J.  
1975. Complexity of cytoplasmic RNA in different mouse tissues measured by hybridization of polyadenylated RNA to complementary DNA. *Biochemistry* 14:1379-1385.
- Ryle, G.J.A., and Hesketh, J.D.  
1969. Carbon dioxide uptake in nitrogen-deficient plants. *Crop Sci.* 9:451-454.
- Ryser, J.  
1977. Cell wall growth in elongating cotton fibers: An autoradiographic study. *Cytobiologie*, 15:78-84.
- Rzedowski, J.  
1979. *Vegetación de México*. Editorial Limusa, Mexico City pp. 432.
- ## S
- Saad, S.I.  
1951. Studies on the physiology of the cotton plant. III. Effect of shading, defoliation, and debudding on development, flowering and shedding of the cotton plant. *Proc. Egypt Acad. Sci.* 7:59-74.
- Sabino, N.P.  
1975. Efeitos da aplicacao de calcario, fosforo e potassio, na qualidade da fibra do algodociro cultivado em latossolo roxo. *Bragantia* 34:153-161.
- Sacher, J.A.  
1957. Relationship between auxin and membrane-integrity in tissue senescence and abscission. *Science* 125:1199-1200.
- Sacher, J.A.  
1969. Hormonal control of senescence of bean endocarp: Auxin suppressor of RNase. *Plant Physiol.* 44:313-314.
- Sadykov, A.S.  
1972. Polyphenolic compounds of *Gossypium* and *Hibiscus* species. *In Chemistry of Natural Products*, pp. 256-264.
- St. Angelo, A.J., and Altschul, A.M.  
1964. Lipolysis and the free fatty acid pool in seedlings. *Plant Physiol.* 39:880-883.
- St. Omer, L., and Horvath, S.M.  
1983a. Elevated CO<sub>2</sub> atmospheres and whole plant senescence. *Ecology* Submitted.
- St. Omer, L., and Horvath, S.M.  
1983b. Potential effects of elevated carbon dioxide levels on seed germination of three native plant species. *Environ. Exp. Bot.* Submitted.
- St. John, J.B., and Christiansen, M.N.  
1976. Inhibition of linolenic acid synthesis and modification of chilling resistance in cotton seedlings. *Plant Physiol.* 57:257-259.
- Sokoluk, M.  
1948. Seed treatment with mercury dusts injurious to corn with mechanical injuries to embryos. *Phytopath.* 38:82-87.

- Saleem, M.B., and Buxton, D.R.  
1976 Carbohydrate status of narrow row cotton as related to vegetative and fruit development. *Crop Sci.* 16:523-526.
- Saminy, C.  
1967. The effect of plant population and carbon dioxide on the growth and yield of soybeans (*Glycine max.* L. Merr.) grown in a modified environment of plastic greenhouses. M.S. Thesis, Department of Agronomy, University of Arizona, Tucson.
- Sanders, J.L., and Brown, D.A.  
1979. Measurement of rooting patterns for determinate and indeterminate soybean genotypes with a fiberoptic scope. *In* J.L. Harley and R. Scott Russell (eds.), *The Soil-Root Interface*, Acad. Press. pp. 369-379.
- Sandstedt, R.  
1971. Cytokinin activity during development of cotton fruit. *Physiol. Plant.* 24:408-410.
- Sandstedt, R.  
1975 Habituated cultures from two cotton species. *Beltwide Cotton Prod. Res. Conf. National Cotton Council*, Memphis, TN. pp. 52-53.
- Santelmann, P.W.; Scifres, C.J.; and Murray, J.  
1966. Influence of postemergence herbicides on the fiber quality of selected cotton varieties. *Crop Sci.* 6:561-562
- Sappenfield, W.P., and Dilday, R.H.  
1980 Breeding high terpenoid cottons the 1978 regional tests *Proc. Beltwide Cotton Prod Res. Conf.* pp. 92-93.
- Sarvella, P.  
1964. Variation of cytoplasmic male-sterile cotton with environment. *Agron. Abstr.* pp. 78-79.
- Sarvella, P.  
1966. Environmental influences on sterility in cytoplasmic male-sterile cottons. *Crop Sci.* 6:361-364.
- Satler, S.O., and Thimann, K.V.  
1983. Metabolism of oat leaves during senescence. VII. The interaction of carbon dioxide and other atmospheric gases with light in controlling chlorophyll loss and senescence. *Plant Physiol.* 71:67-70.
- Sattelmacher, B., and Marschner, H.  
1978 Nitrogen nutrition and cytokinin in *Solanum tuberosum*. *Physiol. Plant.* 42:185-189.
- Scarth, G.W.  
1932. Mechanism of the action of light and other factors on stomatal movement. *Plant Physiol.* 7:481-504
- Schenk, R.V., and Hildebrandt, A.C.  
1972 Medium and techniques for induction and growth of monocotyledonous and dicotyledonous plant cell cultures. *Can. J. Bot.* 50:199-204.
- Schnarrenberger, C., and Fock, H.  
1976. Interactions between organelles involved in photorespiration. *In* C.R. Stocking and U Heber (eds.), *Encyclopedia of Plant Physiology*, New Ser. 3:185-234.
- Scholl, R.L.  
1974. Inheritance of isocitratase activity and its relationship to seedling vigor in a cross of upland cotton. *Crop Sci.* 14:296-300.
- Scholl, R.L.  
1976. Variability within *Gossypium hirsutum* L. for seedling isocitratase activity. *Crop Sci.* 16:701-703.
- Scholl, R.L., and Miller, P.A.  
1976. Genetic association between yield and fiber strength in upland cotton. *Crop Sci.* 16:780-783.
- Schubert, A.M.; Benedict, C.R.; Berlin, J.D.; and Kohel, R.J.  
1973. Cotton fiber development kinetics of cell elongation and secondary wall thickening. *Crop Sci.* 13:704-709.

- Schubert, A.M.; Benedict, C.R.; Gates, C.E.; and Kohel, R.J.  
1976. Growth and development of the lint fibers of Pima S-4 cotton. *Crop Sci.* 16:539-543
- Schult, S., and Dörffling, K.  
1981. Evidence against an intermediary role of abscisic acid in stomatal closure induced by phenylmercuric acetate and farnesol. *Physiol. Plant.* 53:487-490
- Schulz, P., and Jensen, W.A.  
1977. Cotton embryo-genesis: The early development of the free nuclear endosperm. *Amer. J. Bot.* 64:384-394.
- Schuster, M.F., and Lane, H.C.  
1980. Evaluation of high-tannin cotton lines for resistance to bollworms. *Proc. Beltwide Cotton Prod. Res. Conf.* pp. 83-84.
- Scott, C.L.  
1979. Production practices for better quality planting seed. *Proc. Beltwide Cotton Prod. Mech. Conf.* pp. 54-56.
- Seaman, F.; Lukefahr, M.J.; and Mabry, T.J.  
1977. The chemical basis of the natural resistance of *Gossypium hirsutum* L. to *Heliothis*. *Proc. Beltwide Cotton Prod. Res. Conf.* pp. 102-103.
- Seale, C.C.  
1942. Studies in oil formation in the V 135 and MSI varieties of sea island cotton in St. Vincent, B.W.I. *Trop. Agric.* 19:210-214.
- Scarle, N.E.  
1965. Physiology of flowering. *Ann. Rev. Plant Physiol.* 16:97-118.
- Sellschop, J.P.F., and Salmon, S.C.  
1928. The influence of chilling, above freezing point on certain crop plants. *J. Agric. Res.* 37:315-338
- Sestak, Z.; Catsky, J.; and Jarvis, P.G.  
1971. *Plant Photosynthetic Production: Manual of Methods.* Dr. W. Junk, N.V. Publishers, The Hague. pp. 818.
- Setter, T.L.; Brun, W.A.; and Brenner, M.L.  
1980. Stomatal closure and photosynthetic inhibition in soybean leaves induced by petiole girdling and pod removal. *Plant Physiol.* 65:884-887.
- Sevacharian, V., and El-Zik, K.M.  
1983. A slide rule for cotton crop and insect management. Univ. of California Cooperative Ext. Serv., Leaflet 21361, pp. 13. Davis, CA.
- Sexton, P.D., and Gerard, C.J.  
1982. Emergence force of cotton seedlings as influenced by salinity. *Agron. J.* 74:699-702.
- Sexton, R., and Hall, J.L.  
1974. Fine structure and cytochemistry of the abscission zone cells of *Phaseolus* leaves. I. Ultrastructural changes occurring during abscission. *Ann. Bot.* 38:849-854.
- Shannon, L.M.; de Vellis, J., and Yew, J.Y.  
1963. Malonic acid biosynthesis in bush bean roots. II. Purification and properties of the enzyme catalyzing oxidative decarboxylation of oxalacetate. *Plant Physiol.* 38:691-697.
- Shannon, M.C., and Francois, L.E.  
1977. Influence of seed pre-treatments on salt tolerance of cotton during germination. *Agron. J.* 69:619-622.
- Sharkey, T.D., and Raschke, K.  
1981. Separation and measurement of direct and indirect effects of light on stomata. *Plant Physiol.* 68:33-40.
- Sharpe, P.J.H.  
1973. Adaxial and Abaxial stomatal resistance of cotton in the field. *Agron. J.* 65:570-574
- Shaver, T.N.; Dilday, R.H.; and Wilson, F.D.  
1980. Use of glandless stocks to evaluate unknown *Heliothis* growth inhibitors (X-factors) in cotton. *Crop Sci.* 20:545-548.

- Shaver, T.N., and Lukefahr, M.J.  
1969. Effect of flavonoid pigments and gossypol on growth and development of the bollworm, tobacco budworm, and pink bollworm. *J. Econ. Entomol.* 62:643-646.
- Shaw, C.S., and Franks, G.N.  
1962. Cottonseed drying and storage at cotton gins. Technical Bulletin No. 1262. USDA-ARS U.S. Government Printing Office, Washington, D.C.
- Shaw, C.S., and Franks, G.N.  
1963. Cottonseed handling at gins. ARS, USDA. Production Research Report No. 66.
- Shaw, C.S., and Franks, G.N.  
1964. Cotton seed handling and storage at gins. *In Handbook for Cotton Ginners.* ARS, USDA. Agriculture Handbook No. 260. pp. 70-81.
- Shawcroft, R.W.; Lemon, E.R.; Allen, L.H., Jr.; Stewart, D.W.; and Jensen, S.E.  
1974. The soil-plant-atmosphere model and some of its predictions. *Agr. Meteorol.* 14:287-307.
- Shear, C.B.; Cranc, H.L.; and Myers, A.T.  
1946. Nutrient element balance A fundamental concept in plant nutrition. *Proc. Amer. Soc. Hort. Sci.* 47:239-248.
- Sheffield, F.M.L.  
1936. The early development of the cotton fiber. *Emp. Cotton Grow. Rev.* pp. 177-280.
- Sherbakoff, C.D.  
1927. A modified method of delinting cottonseed with sulfuric acid. *Phytopath.* 17:189-193.
- Sheriff, D.W.  
1979. Stomatal aperture and the sensing of the environment by guard cells. *Plant, Cell. and Env.* 2:15-22.
- Shimshi, D.  
1970a. The effect of nitrogen supply on transpiration and stomatal behaviour of beans (*Phaseolus vulgaris* L.). *New Phytol.* 69:405-412.
- Shimshi, D.  
1970b. The effect of nitrogen supply on some indices of plant-water relations of beans. (*Phaseolus vulgaris* L.). *New Phytol.* 69:413-424.
- Shimshi, D., and Kafkafi, U.  
1978. The effect of supplemental irrigation and nitrogen fertilization on wheat (*Triticum aestivum* L.). *Irr. Sci.* 1:27-38.
- Shimshi, D., and Marani, A.  
1971. Effects of soil moisture stress on two varieties of upland cotton in Israel II. The northern negev region. *Experimental Agriculture* 7:225-239.
- Shindy, W.W., and Smith, O.E.  
1975. Identification of plant hormones from cotton ovules. *Plant Physiol.* 55:550-554.
- Sicher, R.C.; Hatch, A.L.; Stumpf, D.K.; and Jensen, R.C.  
1981. Ribulose 1-5 bisphosphate and activation of carboxylase in the chloroplast. *Plant Physiol.* 68:252-255.
- Sievers, A.F., and Lowman, M.S.  
1932. Study of cottonseed with reference to varietal characteristics and sources of production. USDA, Bull. Plant Ind., pp. 20.
- Sigman, J.C., Jr.  
1973. Characterization and treat-ability studies of acid cottonseed delinting waste. M.S. Thesis. Mississippi State University, Miss. State, MS. pp. 88.
- Silhavy, T.J.; Benson, S.A.; and Emr, S.D.  
1980. Mechanisms of protein localization. *Micro. Rev.* 47:313-344.
- Simon, E.W.  
1978. Membranes in dry and imbibing seeds. *Dry Biological Systems* ISBN.
- Simmons, J.G.; Cherry, J.P.; Colwick, R.F.; Barker, G.L.; Wesley, R.A.; Williford, J.; Hudspeth, E.B.; Laird, J.W.; and Baker, R.V.  
1979. Unopened cottonboll harvesting—evaluation of cottonseed quality. *Proc. Beltwide Cotton Prod. Res. Conf.* pp. 32-36.

- Simpson, D.M.  
1935a. Dormancy and maturity of cottonseed. *J. Agr. Res.* 50:429-434
- Simpson, D.M.  
1935b. Relation of moisture content and method of storage to deterioration of stored cottonseed. *J. Agr. Res.* 50:449-456.
- Simpson, D.M.  
1942. Factors affecting the longevity of cottonseed. *J. Agr. Res.* 64:407-419
- Simpson, D.M.  
1946. The longevity of cottonseed as affected by climate and seed treatments. *J. Amer. Soc. Agron.* 38:32-45
- Simpson, D.M.; Adams, C.L.; and Stone, G.M.  
1940. Anatomical structure of the cottonseed coat as related to problems of germination. USDA Tech Bull No 734.
- Simpson, D.M., and Miller, P.R.  
1944. The relation of atmospheric humidity to moisture in cottonseed. *J. Amer. Soc. Agron.* 36:957-959.
- Simpson, D.M., and Stone, B.M.  
1935. Viability of cottonseed as affected by field conditions. *J. Agric. Res.* 50:435-447
- Simpson, M.E., and Marsh, P.B.  
1977. Vascular anatomy of cotton carpels as revealed by digestion in ruminal fluid. *Crop Sci.* 17:819-821.
- Simpson, M.E.; Marsh, P.B.; Merola, G.V.; Ferretti, R.J.; and Filsinger, E.C.  
1973. Fungi that infect cottonseeds before harvest. *Appl. Microbiol.* 26:608-613.
- Simpson, R.J.; Neuberger, M.R.; and Liu, T.Y.  
1976. Complete amino acid analysis of proteins from a single hydrolysate. *J. Biol. Chem.* 251:1936-1940.
- Singh, G., and Kumar, S.  
1978. Effect of some defoliants on boll opening and yield of cotton. *Ind. J. Agr. Sci.* 48:632-636.
- Singh, J., and Diekert, J.W.  
1973. Types and molecular weights of subunits of arachin-P<sub>6</sub>. *Prep. Biochem.* 3:73-82
- Singh, O., and Singh, O.S.  
1975. Effect of growth regulators on early fibre development in cotton. *Ind. J. Exp. Biol.* 13:411-412.
- Singh, S.  
1970. Revolution in cotton yield with CCC. *Indian Fmg.* 20:5-6.
- Singh, S., and Singh, K.  
1972. Effect of seed treatment with succinic acid on the performance of cotton (*Gossypium arboreum* L.) *Indian J. Agric. Sci.* 42:112-114.
- Singh, S.P.  
1975. Studies on the effects of soil moisture stress on the yield of cotton. *Ind. J. Plant Physiol.* 18:49-55.
- Sionit, N.  
1983. Response of soybean to two levels of mineral nutrition in CO<sub>2</sub>-enriched atmosphere. *Crop Sci.* 23:329-333
- Sionit, N.; Mortensen, D.A.; Strain, B.R., and Hellmers, H.  
1981a. Growth response of wheat to CO<sub>2</sub> enrichment and different levels of mineral nutrition. *Agron. J.* 73:1023-1027.
- Sionit, N.; Strain, B.R.; and Beckford, H.A.  
1981b. Environmental controls on the growth and yield of okra. I. Effects of temperature and of CO<sub>2</sub> enrichment at cool temperature. *Crop Sci.* 21:885-888.
- Sionit, N.; Strain, B.R.; and Hellmers, H.  
1981c. Effects of different concentrations of atmospheric CO<sub>2</sub> on growth and yield components of wheat. *J. Agr. Sci., Cambridge.* 79:335-339.

- Sionit, N.; Strain, B.R.; Hellmers, H.; and Kramer, P.J.  
1981d. Effects of atmospheric CO<sub>2</sub> concentration and water stress on water relations of wheat. *Bot. Gaz.* 142:191-196.
- Sionit, N.; Hellmers, H.; and Strain, B.R.  
1980. Growth and yield of wheat under CO<sub>2</sub> enrichment and water stress. *Crop Sci.* 20:687-690.
- Sionit, N.; Hellmers, H.; and Strain, B.R.  
1982. Interaction of atmospheric CO<sub>2</sub> enrichment and irradiance on plant growth. *Agron. J.* 74:721-725
- Sitaram, M.S., and Abraham, E.S.  
1973. Note on effect of gibberellic acid on quality of *Tamxi* cotton. *Cotton Grow. Rev.* 50:150-151.
- Sitton, D.; Itai, C.; and Kende, H.  
1967. "Decreased Cytokinin Production in the Roots as a Factor in Shoot Senescence." *Planta* 73:297-300.
- Sjogren, B., and Spychalski, R.  
1930. The molecular weight of cocosin. *J. Amer. Chem. Soc.* 52:4400-4404.
- Skoog, F.  
1940. Relationships between zinc and auxin in the growth of higher plants. *Amer. J. Bot.* 27:939-951.
- Skoog, F., and Armstrong, D.J.  
1970. Cytokinins. *Ann. Rev. Plant Physiol.* 21:359-384.
- Skovsted, A.  
1935. Cytological studies in cotton. III. A hybrid between *Gossypium davidsoni* Kell, and *G. sturtii* F. Muell. *J. Genet.* 30:397-405.
- Slatyer, R.O.  
1967. *Plant-Water Relationships*. Acad. Press, New York. pp. 366.
- Slatyer, R.O., and Bierhuizen, J.F.  
1964a. The influence of several transpiration suppressants on transpiration, photosynthesis, and water-use efficiency of cotton leaves. *Aust. J. Biol. Sci.* 17:131-146.
- Slatyer, R.O., and Bierhuizen, J.F.  
1964b. Transpiration from cotton leaves under a range of environmental conditions in relation to internal and external diffusive resistances. *Aust. J. Biol. Sci.* 17:115-130.
- Salvik, B.  
1965. *In Water Stress in Plants*. The Hague: W. Junk. pp. 322.
- Smith, E.W.  
1972. Biochemical effects of low temperature on cottonseed germination. Ph.D. Dissertation, N.C. State University, Raleigh, Niv. Microfilms, Ann Arbor, MI
- Smith, E.W., and Fites, R.C.  
1973. The influence of chilling temperature alteration of glyoxysomal succinate levels on isocitrate activity from germinating seedlings. *Biochem. Biophys. Res. Commun.* 55:647-654.
- Smith, E.W.; Fites, R.C.; and Noggle, G.R.  
1971. Effects of chilling temperature on isocitrate and malate synthetase levels during cotton seed germination. *Beltwide Cotton Prod. Res. Conf.*, pp. 45-47
- Smith, F.G.  
1952. The mechanism of the tetrazolium reaction in corn embryos. *Plant Physiol.* 27:445-456.
- Smith, J.H.C.  
1944. Concurrency of carbohydrate formation and carbon dioxide absorption during photosynthesis in sunflower leaves. *Plant Physiol.* 19:394-402.
- Smith, K.A., and Russell, R.S.  
1969. Occurrence of Ethylene and its significance in anaerobic soil. *Nature (London)* 222:769-771.
- Smith, L.L.  
1975. Aeration of cottonseed in storage. Market Research Report No. 1020. USDA-ARS, U.S. Government Printing Office, Washington, D.C.

- Smith, R.H., and Price, H.J.  
1978. Root organogenesis from *Gossypium* callus. Beltwide Cotton Prod. Res. Conf. Proc. pp 38-39. National Cotton Council, Memphis, TN
- Smith, R.H., Price, H.J.; and Thaxton, J.B.  
1977. Defined conditions for the initiation and growth of cotton callus *in vitro* I. *Gossypium arboreum*. *In vitro* 13:329-334.
- Smith, R.H.; Schubert, A.M.; and Benedict, C.R.  
1974. Development of isocitrate lyase activity in germinating cotton seed. *Plant Physiol* 54:197-200.
- Smutzer, G., and Berlin, J.D.  
1976. The use of Nomarski interference contrast microscopy as an alternative to the staining of Epon sections following autoradiography. *Trans. Amer. Micro. Soc* 95:109-112.
- Smutzer, G., and Berlin, J.D.  
1975. Ultrastructural aspects of cotton fiber differentiation as influenced by night temperature. *Texas Rep. Biol. and Med* 33:362-363.
- Snow, J.P.; Crawford, S.H.; Berggren, G.T.; and Marshall, J.G.  
1981. Growth regulator tested for boll rot control. *Louisiana Agric.* 24:3-24.
- Snyder, F.W., and Carlson, G.E.  
1978. Photosynthate partitioning in sugarbeet. *Crop Sci.* 18 657-661.
- Sonneborn, T.M.  
1950. The cytoplasm in heredity. *Heredity* 4:11-36.
- Sood, D.R., Kumar, V; and Dhindsa, K.S.  
1976. Composition of cottonseed as affected by N, P, and K application. *Agrochimica* 20 77-81.
- Sorour, F.A.  
1963. Certain factors affecting manganese and molybdenum accumulation and distribution in the cotton plant. Ph.D. Dissertation. Texas A&M University.
- Sorour, F.A., and Rassoul, S.F.A.  
1974. Effect of shading at different stages of growth of the cotton plant on flowering and fruiting, boll shedding, yield of seed cotton and earliness. *Libyan J. Agr.* 3:39-43
- Sorenson, J.W., and Wilkes, L.H.  
1959. Storage of cottonseed for planting purposes. MP-326. Texas Agr. Exp. Sta., College Station, TX
- Sorenson, J.W., and Wilkes, L.H.  
1973. Seed quality and moisture relationships in harvesting and storing seed cotton. Report to Cotton Incorporated. Raleigh, NC
- Spieth, A.M.  
1933. Anatomy of the transition region in *Gossypium*. *Bot. Gaz.* 95:338-347.
- Spooner, A.E.; Brown, D.A., and Waddle, B.A.  
1958. Effects of irrigation on cotton fiber properties. *Univ. Ark. Agr. Exp. Sta. Bull.* 601 pp. 27.
- Spreafico, L.  
1965. Injured seed, germination and abnormal seedlings in wheat. *Proc. Int. Seed Test Assoc.* 30:727-736
- Staelin, L.A.  
1976. Reversible particle movements associated with unstacking and restacking of chloroplast membranes *in vitro*. *J. Cell Biol.* 71:136-158.
- Stalfelt, M.G.  
1959. The effect of carbon dioxide on hydroactive closure of the stomatal cells. *Physiol. Plant.* 12:691-705.
- Stansbury, M.F.; Cucullu, A.F.; and Hartog, G.T.D.  
1954. Cottonseed contents variation. Influence of variety and environment on oil content of cottonseed kernels. *Agr. Food Chem.* 2 692-696.

- Stansbury, M.F.; Hoffpauir, C.L.; and Hopper, T.H.  
1953a. Influence of variety and environment of the iodine value of cottonseed oil. *J. Amer. Oil Chem. Soc.* 30:120-123.
- Stansbury, M.F.; Pons, W.A.; and Hartog, G.T.D.  
1956. Relations between oil, nitrogen, and gossypol in cottonseed kernels. *J. Amer. Oil Chem. Soc.* 33:282-286.
- Stansbury, M.F.; Pons, W.A.; and Hoffpauir, C.L.  
1953b. Phosphorus compounds in cottonseed kernels. Influence of variety of cottonseed and environment. *Agric. Food Chem.* 1:75-78
- Stanway, V  
1960. Laboratory germination of cottonseed at three different temperatures. *Proc. Assoc. Off. Seed Anal.* 50:97-100.
- Stanway, V.  
1962. Rate of germination of cottonseed at a constant and two alternating temperatures. *Proc. Assoc. Off. Seed Anal.* 52:104-108.
- Stedbronsky, V.L.  
1964. Materials handling fans and piping. *In Handbook for Cotton Ginners.* pp. 60-68. ARS, USDA. Agriculture Handbook No. 260.
- Stedman, E., and Stedman, E.  
1950. Cell specificity of histones. *Nature* 166:780-781.
- Steel, R.G.D., and Torrie, J.H.  
1960. Principles and Procedures of Statistics. McGraw-Hill Book Co., New York, NY. pp. 481.
- Steele, J.A.; Uchytel, T.F.; Durbin, R.D.; Bhatnagar, P.; and Rich, D.H.  
1976. Chloroplast coupling factor 1: A species-specific receptor for tentoxin. *Proc. Natl. Acad. Sci., USA*, 73:2245-2248.
- Steen, D.A., and Chadwick, A.V.  
1981. Ethylene effects in Pea stem tissue. Evidence of microtubule mediation. *Plant Physiol.* 67:460-466.
- Stepanichenko, N.N.; Ten, L.N.; Tyshchenko, A.A.; Avazkhodzhaev, M.K.; Mukhamedzhanov, S.Z.; and Otroshchenko, O.S.  
1980. Metabolites of the pathogenic fungus *Verticillium dahliae*. X. Induction of phytoalexins in the cotton plant by metabolites in the pathogen. *Khim. Prir. Soedin. (Tashk)* 3 397-406.
- Sterrett, J.P.; Leather, G.R.; and Tozer, W E.  
1973. Synergistic interaction between endothal and ethephon in abscission. *Plant Physiol.* 51:(S-29)37.
- Stewart, J. McD.  
1972. Histochemistry of cotton fiber initiation. Beltwide Cotton Prod. Res. Conf. Proc. Memphis, TN. pp. 102.
- Stewart, J. McD.  
1974. Relationship between fiber length increase and seed volume increase-revisited. *Proc. Beltwide Cotton Prod Res. Conf.* pp. 142-143.
- Stewart, J. McD.  
1975. Fiber initiation on the cotton ovule [*Gossypium hirsutum*]. *Amer. J. Bot.* 62:723-730.
- Stewart, J. McD.  
1979. Use of ovule cultures to obtain interspecific hybrids of *Gossypium*. *In J.T. Barber (ed.), Plant tissue culture.* pp. 44-56. Symposium So Sec Am. Soc. Plant Physiol., Tulane Univ., New Orleans.
- Stewart, J.M.  
1981. *In vitro* fertilization and embryo rescue. *Envir. Exp. Bot.* 21:301-315.
- Stewart, J. McD., and Cunningham, S.  
1985. Two New *Gossypium* Species From Western Australia. *Proc. Beltwide Cotton Res. Conf. New Orleans, La.*



- Stewart, J. McD., and Duncan, E.N.  
1976. Cottonseed viability after long-time storage. *Agron. J.* 68:243-244.
- Stewart, J. McD., and Guinn, G.  
1971. Response of cotton mitochondria to chilling temperatures. *Crop Sci.* 11:908-910
- Stewart, J. McD., and Hsu, C.L.  
1977a. In-ovulo embryo culture and seedling development of cotton (*Gossypium hirsutum* L.). *Planta* 137:113-117
- Stewart, J. McD., and Hsu, C.L.  
1977b. Influence of phytohormones on the response of cultured cotton ovules to (2-chloroethyl) phosphonic acid. *Physiol. Plant.* 39:79-85.
- Stewart, J. McD., and Hsu, C.L.  
1978. Hybridization of diploid and tetraploid cottons through in-ovulo embryo culture. *J. Hered.* 69:404-408
- Stewart, J. McD., and Kerr, T.  
1974. Relationship between fiber-length increase and seed-volume increase in cotton (*Gossypium hirsutum* L.). *Crop Sci.* 14:118-120
- Stipanovic, R. D.; Bell, A.A.; and Lukefahr, M. J.  
1977. Natural insecticides from cotton (*Gossypium*). In P.A. Hedin (ed.), ACS Symposium Series. No. 62. Host Plant Resistance to Pests, Amer. Chem. Soc.
- Stipanovic, R. D.; Bell, A. A.; and O'Brien, D.H.  
1980. Raimondal, a new sesquiterpenoid from pigment glands of *Gossypium raimondii*. *Phytochem.* 19:1735-1738.
- Stipanovic, R. D.; Greenblatt, G.A.; Beier, R. C.; and Bell, A.A.  
1981. 2-Hydroxy-7-methoxycadalene. The precursor of lacinilene C 7-methyl ether in *Gossypium*. *Phytochem.* 20:729-730.
- Stipanovic, R.D.; Wakelyn, P.J., and Bell, A.A.  
1975. Lacinilene C, a revised structure, and lacinilene C 7-methyl ether from *Gossypium* bracts. *Phytochem.* 14:1041-1043
- Stutt, M., and Heldt, H.W.  
1981. Physiological rates of starch breakdown in isolated intact spinach chloroplasts. *Plant Physiol.* 68:755-761.
- Stocking, C.R., and Ongun, A.  
1962. The intracellular distribution of some metallic elements in leaf. *Amer. J. Bot.* 49:284-289.
- Stockton, J. R.; Doneen, L. D.; Walhoad, J.T.  
1961. Boll shedding and growth of the cotton plant in relation to irrigation frequency. *Agron. J.* 53:272-275
- Stockton, J.R., and Walhoad, V.T.  
1960. Effect of irrigation and temperature on fiber properties. *Proc. 14th Ann. Beltwide Cotton Defol. Physiol. Conf.* pp. 11-14.
- Stolzy, L.H.  
1974. Soil atmosphere. In E.W. Carson (ed.), pp. 335-363. *The Plant Root and Its Environment*, University Press of Virginia.
- Stone, R.B.; Christiansen, M.N.; Nelson, S.O.; Webb, J.C.; Goodenough, J.L.; and Statson, L.E.  
1973. Induction of germination of impermeable cottonseed by electrical treatment. *Crop Sci.* 13:159-161
- Strain, B.R.  
1978a. Effects of global carbon dioxide enrichment on plants; A Partially annotated bibliography. U.S. Dept. of Energy and Environ. Protection Agency, Washington, D.C.
- Strain, B.R.  
1978b. Report of the workshop on anticipated plant response to global carbon dioxide enrichment, 4-5 August 1977, Dept. of Botany, Duke University, Durham, NC. pp. 91.

Strain, B.R.

1982. Ecological aspects of plant responses to carbon dioxide enrichment. *In* S. Brown (ed.), *Global Dynamics of Biospheric Carbon*, pp. 46-55, U.S. Dept. of Energy CONF-8108131 pp. 194.

Strain, B.R., and Armentano, T.V.

1982. Environmental and societal consequences of a possible CO<sub>2</sub> industrial climate change Response of "unmanaged" ecosystems. National Technical Information Service, U.S. Dept. of Commerce, Springfield, VA 22161. DOE/EV/10019-12. pp. 46.

Strain, B.R., and Bazzaz, F.

1983. Terrestrial communities. *In* E. Lemon (ed.), *CO<sub>2</sub> and plants: The Response of Plants to Rising Levels at Atmospheric Carbon Dioxide*. AAAS Publ., Washington, D.C. pp. 280.

Strain, B.R.; Goeschl, J.D.; Jaeger, C.H.; Fares, Y.; Magnuson, C.E.; and Nelson, C.E.

1983. Measurement of carbon fixation and allocation using <sup>14</sup>C-labeled carbon dioxide. *Radiocarbon*. In Press.

Strain, B.R., and Sionit, N.

1982. *Direct Effects of Carbon Dioxide on Plants: A Bibliography*. Department of Botany, Duke University, Durham, NC. pp. 66

Struck, R.F., and Kirk, M.C.

1970. Methylated flavonols in the *Gossypium*. *J. Agric. Food Chem* 18:548-549.

Subbiah, K.K., and Mariakulandai, A.

1972. Application of gibberellic acid and naphthalene acetic acid in preventing bud and boll shedding in Cambodia cotton. *Madras Agric. J.* 59:350-352.

Stumpf, P.K.

1976. Lipid metabolism, *In* *Plant Biochemistry* J. Bonner, and J.E. Varner (eds.), Acad. Press, NY. pp. 428-462.

Sung, F.J.M., and Krieg, D.R.

1979. Relative sensitivity of photosynthetic assimilation and translocation of <sup>14</sup>C to water stress. *Plant Physiol.* 64:852-856.

Sturkie, D.G.

1934. A study of lint and seed development in cotton as influenced by environmental factors. *J. Amer. Soc. Agron.* 26:1-24.

Sturkie, D.G.

1947. Effects of some environmental factors on the seed and lint of cotton. *Alabama Agr. Exp. Sta., Bull.* 263.

Suryatmana, G.; Copeland, L.O.; and Miles, D.F.

1980. Comparison of laboratory indices of seed vigor with field performance of navy bean. (*Phaseolus vulgaris L.*). *Agron. Abstr.* 1980:113.

Suy, T.B.

1979. Contribution of l'étude de la croissance des tubes polliniques chez *Gossypium hirsutum L.* en fonction des conditions du milieu. *Cot. Fib. Trop.* 34:295-300.

Svedberg, T., and Pederson, K.O.

1940. *The Ultracentrifuge*. Clarendon Press, Oxford.

Swain, T.

1965. The tannins, *In* *Plant Biochemistry* J. Bonner, and J. E. Varner (eds.), Acad. Press, New York.

## T

Tackett, J.L., and Pearson, R.W.

1964. Oxygen requirements of cotton seedling roots for penetration of compacted soil cores. *Proc. Soil Sci. Amer.* 28:600-605.

Takami, S., and van Bavel, C.H.M.

1975. Numerical experiments on the influence of CO<sub>2</sub> release at ground level on crop assimilation and water use. *Agr. Meteor.* 15:193-203.

- Tamas, I.A., Atkins, B.D.; Ware, S.M.; and Bidwell, R.G.S.  
1972. Indoleacetic acid stimulation of phosphorylation and bicarbonate fixation by chloroplast preparations in light. *Can. J. Bot.* 50:1523-1527.
- Tamas, I.A.; Schwartz, J.W.; Hagin, J.M., and Simonds, R.  
1974. Hormonal control of photosynthesis in isolated chloroplasts. *In Mechanisms of Regulation of Plant Growth*, R.L. Bialeski, A.R. Ferguson, and M.M. Cresswell (eds.), Bull. 12, pp. 261-268. Royal Soc. New Zealand, Wellington.
- Tao, K.J.  
1980a. Vigor "referee" test for soybean and corn. *Assoc. Off. Seed Anal. Newslett.* 54:40-58.
- Tao, K.J.  
1980b. The 1980 vigor "referee" test for soybean and corn seed. *Assoc. Off. Seed Anal. Newslett.* 54:53-68.
- Tao, K.J.  
1980c. Effect of seed treatment on the conductivity vigor test for corn. *Plant Physiol.* 65.S 141.
- Tarчевskit, I.A.; Lozovaya, V.V.; Ruseva, L.G.; and Markova, M.N.  
1980. The supply of macroergic phosphates in synthesis of cotton cellulose. *Fizid. Rast.* 27 1052-1055.
- Tarter, C.K.  
1983. Carbon dioxide levels in the plant microenvironment as influenced by a poly-coated paper mulch, M.S. Thesis, Colorado State University, Fort Collins, CO. pp. 85
- Taylor, D.M.  
1965. The manganese nutrition of cotton. Ph.D. Dissertation. Texas A&M University.
- Taylor, H.M.  
1983. Managing root systems for efficient water use: An overview. *In Limitations to Efficient Water Use in Crop Production*, H.M. Taylor, W.R. Jordan, and T.R. Sinclair (eds.) pp.87-113. Amer. Soc. Agron., Madison
- Taylor, H.M., and Gardner, H.R.  
1963. Penetration of cotton seedling taproots as influenced by bulk density, moisture content, and strength of soil. *Soil Sci.* 96 153-156.
- Taylor, H.M.; Huck, M.G.; and Klepper, B.  
1972. Root development in relation to soil physical conditions. *In D.I. Hillel (ed.), Optimizing the Soil Physical Environment Toward Greater Crop Yields* pp. 57-77. Acad. Press, New York.
- Taylor, H.M.; and Klepper, B.  
1971. Water uptake by cotton roots during an irrigation cycle. *Aust. J. of Biol. Sci.* 24:853-859
- Taylor, H.M., and Klepper, B.  
1974. Water relations of cotton. I. Root growth and water use as related to top growth and soil water content. *Agron. J.* 66:584-588
- Taylor, H.M., and Klepper, B.  
1975. Water uptake by cotton root systems: An examination of assumptions in the single root model. *Soil Sci.* 120 57-67.
- Taylor, H.M., and Klepper, B.  
1978. The role of rooting characteristics in the supply of water to plants. *Advances in Agronomy* 30:99-128.
- Taylor, H.M., and Ratliff, L.F.  
1969. Root elongation rates of cotton and peanuts as a function of soil strength and soil water content. *Soil Sci.* 108:113-119.
- Taylor, O.C., and Mersereau, J.D.  
1963. Smog damage to cotton. *Calif. Agr.* 2:March 1963.
- Taylor, R. M.  
1972. Germination of cotton (*Gossypium Hirsutum* L.) pollen on an artificial medium. *Crop Sci.* 12:243-244
- Taylor, R. M. and Lankford, M.K.  
1972. Secondary dormancy in cotton. *Crop Sci.* 12:195-196.

- Taylor, W.K.  
1981. DROPP: Thidiazuron experimental cotton defoliant. Proc. Beltwide Cotton Prod. Mech. Conf. pp. 70-71.
- Templeton, G.E.; Meyer, W.L.; Grable, C.I.; and Sigel, C.W.  
1967. The chlorosis toxin from *Alternaria tenuis* is a cyclotetrapeptide. *Phytopath.* 57:833.
- Tenhunen, J.D.; Weber, J.A.; Yocum, C.S.; and Gates, D.M.  
1979. Solubility of gases and the temperature dependent of whole leaf affinities for carbon dioxide and oxygen. *Plant Physiol.* 63:916-923.
- Tesha, A.J., and Kumar, D.  
1978. Effect of fertilizer nitrogen on drought resistance in *Coffea arabica* L. *J. Agric. Sci.* 90:625-631.
- Tharp, W.H.  
1961. Getting a stand (Area II.) Blueprint for Cotton Research. Nat. Cotton Coun. America. Dec., 1961 pp. 36
- Tharp, W.H.  
1965. The cotton plant. How it grows and why its growth varies. Agric. Handbook No. 178, USDA, ARS.
- Tharp, W.A.  
1962. Blueprint for cotton research: Area VII Fruiting Control. National Cotton Council, Memphis, Tenn.
- Tharp, W.H.  
1948. Cottonseed composition—relation to variety, maturity, and environment of the plant *In* Cottonseed and cottonseed products. A.E. Bailey (ed.). Interscience, NY. pp. 117-156.
- Tharp, W.H., Thomas, R.O.; Walhood, V.T.; and Carns, H.R.  
1961. Effect of cotton defoliation on yield and quality. USDA, Production Research Report 46.
- Tharp, W.H.; Skinner, J.J.; Turner, J.H.; Bledsoe, R P., and Brown, H.B.  
1949. Yield and composition of cottonseed as influenced by fertilization and other environmental factors. USDA Tech. Bull. No. 974, pp. 153.
- Thimann, K.  
1978. Senescence. *Bot. Mag. Tokyo*, Special Issue. 1 19-43.
- Thomas, J.C.; Brown, K.W.; and Jordan, W.R.  
1976. Stomatal response to leaf water potential as affected by preconditioning water stress in the field. *Agron. J.* 68:706-708.
- Thomas, J.D., and Hill, G.R.  
1949. Photosynthesis under field conditions. *In* J. Franck and W. Loomis (eds.), Photosynthesis in Plants, pp. 19-52. Iowa State College Press, Ames.
- Thomas, J.F.; Raper, C.D., Jr.; Anderson, C.E.; and Downs, R.J.  
1975. Growth of young tobacco plants as affected by carbon dioxide and nutrient variables. *Agron J.* 67.685-689.
- Thomas, J.R.  
1980. Osmotic and specific salt effects on growth of cotton. *Agron. J.* 72:407-412.
- Thomas, R.O.  
1964. Effect of application and concentration of 2-chloroethyltrimethylammonium chloride on plant size and fruiting response of cotton. *Crop Sci.* 4:403-406.
- Thomas, R.O.  
1965. Some effect of boll maturity associated with bottom defoliation timing and with partial crown defoliation. Cotton Def. and Physiol. Conf. pp. 92.
- Thomas, R.O.  
1967. Effect of two growth retardants on flowering and boll production of greenhouse cotton plants. Proc. Beltwide Cotton Prod. Res. Conf. pp.222-226.
- Thomas, R.O.  
1972. Field comparisons of selected growth retardants. Proc. Beltwide Cotton Prod. Res. Conf. pp. 49.

- Thomas, R.O.  
1975 Cotton flowering and fruiting response to application timing of chemical growth retardants. *Crop Sci.* 15:87-90.
- Thomas, R.O.; Cleveland, T.C., and Cathey, G.W.  
1979. Chemical plant growth suppressants for reducing late—season cotton bollworm-budworm feeding sites. *Crop Sci.* 19:861-863.
- Thomas, R.O., and Hacskaylo, J.  
1973. Cotton response to DPX-1840 growth retardant following root and foliar uptake. *Proc Beltwide Cotton Prod. Res. Conf.* pp. 36.
- Thomas, R.O., and Hacskaylo, J.  
1974. Cotton fruiting and yield responses to growth retardants used for suppressing late-season plant development. *Proc. Beltwide Cotton Prod. Res. Conf.* pp. 61.
- Thompson, A.C.; Hanny, B.W.; Hedin, P.A.; and Guelöner, R.C.  
1971. Phytochemical studies in the family *Malvaceae*. I. Comparison of essential oils of six species by gas-liquid chromatography. *Amer. J. Bot.* 58:803-807.
- Thompson, A.C., Lane, H.C.; Jones, J.W.; and Hesketh, J.D.  
1975. Soluble and insoluble sugars in cotton leaves, squares, and bolls. *In Proc. Beltwide Cotton Prod. Conf. New Orleans, La.* pp. 59, 61-63.
- Thorne, D.W., and Peterson, H.B.  
1954 *Irrigated soils—their fertility and management.* The Blakiston Co., Inc., New York.
- Thorne, G.N.  
1971. Physiological factors limiting the yield of arable crops. Chap. 9. *In P.F. Wareing and J.P. Cooper (eds.), Potential Crop Production. A Case Study,* pp. 143-158. Heinemann Educational Books, London.
- Thorne, J.H., and Koller, H.R.  
1974. Influence of assimilate demand on photosynthesis, diffusive resistances, translocation, and carbohydrate levels of soybean leaves. *Plant Physiol.* 54:201-207.
- Tibbitts, T.W., and Krizek, D.T.  
1978. Carbon dioxide. Chap. 4. *In R.W. Langhans (ed.), A Growth Chamber Manual: Environmental Control for Plants,* pp. 80-100. Cornell University Press, Ithaca, New York.
- Ting, I.P., and Dugger, W.M., Jr.  
1968. Factors affecting ozone sensitivity and susceptibility of cotton plants. *J. Air Poll. Contr. Assoc.* 18:810-813.
- Tinus, R.W.  
1972. CO<sub>2</sub> enriched atmosphere speeds growth of ponderosa pine and blue spruce seedlings. *Tree Plant. Notes* 23:12-15.
- Tinus, R.W.  
1974. Impact of the CO<sub>2</sub> requirement on plant water use. *Agric. Meteorol.* 14:99-112.
- Tobin, A.J.  
1979. Evaluating the contribution of post transcriptional processing to differential gene expression. *Dev. Biol.* 68:47-58.
- Tognoni, F.; Halevy, A.H.; and Wittwer, S.H.  
1967. Growth of bean and tomato plants as affected by root absorbed growth substances and atmospheric carbon dioxide. *Planta* 72:43-52.
- Tognoni, F.; Halevy, A.H.; and Wittwer, S.H.  
1967. Growth of bean and tomato plants as affected by root absorbed growth substances and atmospheric carbon dioxide. *Planta* 72:43-52.
- Tolbert, N.E.  
1973. Glycolate biosynthesis. *In B.L. Horecker, and E.R. Stadtman (eds.), Curr. Top. Cell Regul* 7:21-50.
- Tolbert, N.E.  
1980. Photorespiration. *In P.K. Stumpf and E.E. Conn (eds.), The Biochemistry of Plants, Vol. 2,* pp. 487-523.

Tolbert, N.L., and Zelitch, I.

1982. Carbon metabolism. *In* Proceedings of an International Conference on Rising Atmospheric Carbon Dioxide and Plant Productivity, Athens, Georgia, May 23-28, 1982. American Association for the Advancement of Science, Washington, D.C.

Tollervey, F.E.

1970. Physiology of the cotton plant. *Cotton Grow. Rev.* 47:245-256.

Tomar, D.P.; Mehra, R.B.; Shukla, D.S.; and Singh, S.P.

1965. Photoperiodic study on cotton. *Indian Cotton J.* 19:378-384.

Toole, E.H., and Drummond, P.L.

1924. The germination of cotton seed. *J. Agr. Res.* 28 285-292.

Toole, E.H., and Toole, V.K.

1951. Injury to seed beans during threshing and processing. USDA. Circular No. 874.

Torrey, J.G.

1976. Root hormones and plant growth. *Ann. Rev. Plant Physiol.* 27:435-459.

Touma-Touchan, H.

1977. Etudes biochimiques et ultrastructurales des lipides dans la graine du cotonnier. *J. Ultrastruct. Res.* 58:271-288.

Towers, B., and Harrison, G.J.

1949. Viability tests of cotton seed. California Dept. of Agriculture. *The Bulletin* 38:25-31.

Trebst, A., and Avron, M.

1977. *Photosynthesis I: Photosynthetic Electron Transport and Photophosphorylation*. Springer-Verlag, Berlin.

Trcharnc, K.J.

1982. Hormonal control of photosynthate and assimilate distribution. *In* J.S. McLaren (ed.), *Chemical Manipulation of Crop Growth and Development*, pp. 55-66 Butterworth's, London

Trelease, R.N., Miernyk, J.A.; Choinski, J.S., Jr.; and Bortman, S.J.

1980. Enzyme synthesis in developing cotton embryos. *Proc. Beltwide Cotton Prod. Res. Conf.* pp. 355-366

Trewavas, A.J.

1981. How do plant growth substances work? *Plant, Cell, and Env.* 4:203-228.

Tripp, V.W.; Moore, A.T.; and Rollins, M.L.

1951. Some observations on the constitution of the primary wall of the cotton fiber. *Text. Res. Journ.* 21:886-894

Troughton, J.H.

1969. Plant water status and carbon dioxide exchange of cotton leaves. *Aust. J. Biol. Sci.* 22:289-302.

Troughton, J.H.

1975. Photosynthetic mechanisms in higher plants. Chap. 16. *In* J.B. Cooper (ed.), *Photosynthesis and Productivity in Different Environments*. IBP 3, pp. 357-391. Cambridge University Press, Cambridge.

Troughton, J.H., and Slatyer, R.O.

1969. Plant water status, leaf temperature, and the calculated mesophyll resistance to carbon dioxide of cotton leaves. *Aust. J. Biol. Sci.* 22:815-827.

Tsui, C.

1948. The role of zinc in auxin synthesis in the tomato plant. *Amer. J. Bot.* 35:172-179.

Tucker, T.C., and Tucker, B.B.

1968. Nitrogen nutrition. *In* F.C. Elliot, M. Hoover, and W.K. Porter, Jr. (eds.), *Advances in Production and Utilization of Quality Cotton: Principles and Practices*, pp. 183-211. Iowa State University Press, Ames, Iowa.

Tugwell, N.P., and Waddle, B.A.

1964. Yield and lint quality of cotton as affected by varied production practices. *Arkansas Arg. Exp. Sta., Bull.* 682.

- Tuchibaev, M., and Kruzhiln, A.S.  
1965 Translocation of labeled assimilates from individual cotton leaves. *Soviet Plant Physiol.* 12:918-922.
- Tupper, G.R.  
1969. Physical characteristics of cottonseed related to seedling vigor and design parameters for seed selection. Ph.D. Dissertation. Texas A&M University, College Station, TX. pp. 159.
- Tupper, G.R., Clark, L.E.; and Kunze, O.R.  
1970 The measurement of certain physical characteristics related to rapid germination and seedling vigor in cottonseed. *Proc. Assoc. of Off. Seed Anal.* 60:138-148
- Tupper, G.R., Kunze, O.R.; and Wilkes, L.H.  
1971. Physical characteristics of cottonseed related to seedling vigor and design parameters for seed selection. *Trans. of the ASAE* 14:890-893.
- Turner, A.J.  
1929. Cotton seeds. Their absorption of water and specific gravity. *The Ag. J. of India.* 24 83-90.
- Turner, J.H., and Ferguson, D.  
1972. Field performance of cotton grown from filled and partially filled seeds. *Crop Sci.* 12:868-871.
- Turner, J.H.; Ramey, H.H.; and Worley, S.  
1976a. Influence of environment on seed quality of four cotton cultivars. *Crop Sci.* 16:407-409.
- Turner, J.H.; Ramey, H.H.; and Worley, S.  
1976b. Relationship of yield, seed quality, and fiber properties in upland cotton. *Crop Sci.* 16:578-580.
- Turner, J.H.; Stewart, J. McD.; Hoskinson, P.E.; and Ramey, H.H.  
1977. Seed setting efficiency in eight cultivars of upland cotton. *Crop Sci.* 17:769-772.
- Turner, J.H., Jr.; Worley, S., Jr.; Ramey, H.H. Jr.; Hoskinson, P.E., and Stewart, J. McD.  
1979 Relationship of week of flowering and parameters of boll yield in cotton. *Agron. J.* 71:248-251
- Turner, N.C.  
1969 Stomatal resistance to transpiration in three contrasting canopies. *Crop Sci.* 9:300-307
- Turner, N.C.  
1974 Stomatal response to light and water under field conditions. *In Mechanisms of Regulation of Plant Growth*, Royal Soc. N.Z. Bull. No. 12.
- Turner, N.C.  
1979. Drought resistance and adaptation to water deficits in crop plants. *In H. Mussell and R.C. Staples (eds.), Stress Physiology in Crop Plants*, pp. 343-372. John Wiley and Sons, New York.
- Turner, N.C., and Kramer, P.J.  
1980 *Adaptation of Plants to Water and High Temperature Stress*. Wiley Interscience, NY.
- Turner, T.W.  
1922. Studies of the mechanism of the Physiological effect of certain mineral salts in altering the ratio of top growth to root growth in seed plants. *Amer. J. Bot.* 9:415-445.
- Turner, W.B., and Bidwell, R.G.S.  
1965. Rates of photosynthesis in attached and detached bean leaves, and the effect of spraying with indoleacetic acid solution. *Plant Physiol.* 40:446-451.

## U

- Unsworth, M.H.  
1981. Air pollution and plant productivity. *In C.B. Johnson (ed.), Physiological Processes Limiting Plant Productivity*, pp. 293-306. Butterworth's, London.

- Unsworth, M.H.; Biscoe, P.V.; and Black, V.J.  
 1976. Analysis of gas exchange between plants and polluted atmospheres. *In* T.A. Mansfield (ed.), *Effect of Air Pollutants on Plants*, pp. 6-16. Cambridge University Press, Cambridge.
- Unsworth, M.H., and Black, V.J.  
 1981. Stomatal responses to pollutants. *In* P.E. Jarvis and T.A. Mansfield (eds.), *Stomatal Physiology*, pp. 187-203. Cambridge University Press, Cambridge.
- Upmeyer, D.J., and Küller, H.R.  
 1973. Diurnal trends in net photosynthetic rate and carbohydrate levels of soybean leaves. *Plant Physiol.* 51:871-874.
- USDA, Bureau of Plant Industry, Beltsville, MD.  
 1947. *Better Cottons*. pp. 928-945.
- USDA Southern Cooperative Series.  
 1965. *Mechanized harvesting of cotton*. Bulletin No. 100 USDA ARS, U.S. Government Printing Office, Washington, D.C.
- U.S. Salinity Laboratory Staff.  
 1954. *Diagnosis and improvement of saline and alkali soils*. USDA Handbook 60.

## V

- Vaadia, Y.  
 1976. Plant hormones and water stress. *Phil. Trans. R. Soc. London B.* 273:513-522.
- van Bavel, C.H.M.  
 1972a. Water use efficiency in plant growth and ambient carbon dioxide level. Tech. Rep. No. 42. Texas Water Resources Institute, Texas A&M University. pp. 115, pp. 1-38.
- van Bavel, C.H.M.  
 1972b. Toward realistic simulation of the natural plant climate. *In* *Plant Response to Climatic Factors*, pp. 441-446. Proc. Uppsala Sympos., UNESCO.
- van Bavel, C.H.M.  
 1974. Antitranspirant action of carbon dioxide on intact sorghum plants. *Crop Sci.* 14:208-212
- van Bavel, C.H.M.; Demichele, D.W.; and Ahmed, J.  
 1973. A model of gas and energy exchange regulation by stomatal action in plant leaves. *Texas Agr. Exp. Sta. Misc. Publ.* 1078.
- van den Honert, T.H.  
 1930. Carbon dioxide assimilation and limiting factors. *Rec. Trav. Bot. Neerlandais* 27:149-286.
- Valdovinos, J.G., and Ernest, L.C.  
 1967. Effect of protein synthesis inhibitors, auxin, and gibberellic acid on abscission. *Physiol. Plant* 20:1027-1038.
- Vanderhoef, L.N., and Dute, R.R.  
 1981. Auxin regulated wall loosening and sustained growth in elongation. *Plant Physiol.* 67:146-149.
- Vanderhoef, L.N., and Stahl, C.A.  
 1975. Separation of two responses to auxin by means of cytokinin inhibition. *Proc. Nat'l. Acad. Sci. USA* 72:1822-1825.
- Vanderhoef, L.N., Stahl, C.; Siegel, N.R.; and Zeigler, R.  
 1973. The inhibition by cytokinin of auxin-promoted elongation in excised soybean hypocotyl. *Physiol. Plant* 29:22-27.
- Varma, S.K.  
 1976a. Reversal of abscisic acid promoted abscission of flower buds and bolls of cotton (*Gossypium hirsutum* L.) and its reversal with other plant regulators. *Biol. Plant.* 18:421-428.
- Varma, S.K.  
 1976c. Role of gibberellic acid in the phenomena of abscission in flower buds and bolls of cotton (*Gossypium hirsutum* L.) *Indian J. Plant Physiol.* 19:40-46.



- Varma, S.K.  
1976d. Effect of localized application of ascorbic acid and other plant regulators singly and in combination with abscisic acid on boll shedding in cotton (*Gossypium hirsutum* L.). *Indian J. Exp. Biol.* 14:305-308
- Varma, S.K.  
1978. Variations in the endogenous growth regulators and nitrogen content in retained and abscising bolls of cotton. *Indian J. Plant Physiol.* 21:18-23.
- Vasil, I.K.  
1958. The cultivation of excised anthers and the culture and storage of pollen. Ph.D. Dissertation. University of Delhi, Delhi, India.
- Vaughan, A.K.F., and Bate, G.C.  
1977. Changes in the levels of ethylene, abscisic-acid like substances and total non-structural carbohydrate in young cotton bolls in relation to abscission induced by a dark period. *Rhod. J. Agr. Res.* 15:51-63.
- Veech, J.A.  
1978. An apparent relationship between methoxy-substituted terpenoid aldehydes and the resistance of cotton to *Meloidogyne incognita*. *Nematologica* 24:81-87.
- Veech, J.A.  
1979. Histochemical localization and nematotoxicity of terpenoid aldehydes in cotton. *J. Nematol.* 11:240-246.
- Veech, J.A.; Stupanovic, R.D., and Bell, A.A.  
1976. Peroxidative conversion of hemigossypol to gossypol. A revised structure for isohemigossypol. *J.C.S. Chem. Comm.*, pp. 144-145.
- Veksler, N.S.; Smirnova, L.S.; and Abduazimov, K.A.  
1977. Changes in the structural elements of cotton lignins in the different periods of vegetation. *Khim. Prir. Soedin. (Tashk)* pp. 100-107
- Veksler, N.A.; Smirnova, L.S.; and Abduazimov, K.A.  
1978. Isolation and study of individual dioxane lignin fractions from cotton stems. *Khim. Prir. Soedin. (Tashk)*. 122-125.
- Velthuys, B.R.  
1980. Mechanisms of electron flow in photosystem II and toward photosystem I. *Ann. Rev. Plant Physiol.* 31:545-567
- Vencro, R.J.  
1980. Role of peroxidase in cotton resistant to bacterial blight. *Plant Sci. Lett.* 20:47-56.
- Verhalen, L.M., and Murray, J.C.  
1970. Genotype by environment interaction study of cotton in Oklahoma. *Proc. Beltwide Cotton Prod. Res. Conf., Nat'l. Cotton Coun., Memphis, TN.* pp. 52-54.
- Verhalen, L.M.; Mamaghani, R.; Morrison, W.C., and McNew, R.W.  
1975. Effect of blooming data on boll retention and fiber properties in cotton. *Crop Sci.* 15:47-52.
- Vernon, L.P., and Seely, G.R.  
1966. *The Chlorophylls*. Acad. Press, NY.
- Vick, B.A., and Zimmerman, D.C.  
1981. Lipoxygenase, hydroperoxide isomerase, and hydroperoxide cyclase in young cotton seedlings. *Plant Physiol.* 67:92-97.
- Vieira da Silva, J.B.  
1976. Water stress, ultrastructure and enzymatic activity. In O.L. Lange, L. Kappen, and E.D. Schulze (eds.), *Water and Plant Life, Ecological Studies*, Vol. 19, pp. 207-224. Springer-Verlag
- Vieira da Silva, J.B.  
1973. Influence de la secheresse sur la photosynthese et la croissance du Cotonnier. (Influence of drought on the photosynthesis and growth of the cotton plant) *Reponse des Plantes aux Facteurs Climatiques, Actes Coll. Uppsala, 1970 (Ecologie et Conservation, 5.)*, pp. 213-220. UNESCO, New York

- Vieira da Silva, J.B.; Naylor, A.W.; and Kramer, P.J.  
1974. Some ultrastructural and enzymatic effects of water stress in cotton (*Gossypium hirsutum* L.) leaves. Proc. Nat. Acad. Sci. USA 71:3243-3247.
- Vimes, H.M., Grierson, W., and Edwards, G.J.  
1968. Respiration, internal atmosphere and ethylene evolution of citrus fruit. Proc. Amer. Soc. Hort Sci. 92:227
- Vincke, H.; DeLanghe, E.; Fransen, T.; and Verschraege, L.  
1985. Cotton Fibers are Uniform in Length Under Natural Conditions In: International Institute of Cotton. Cotton Fibres: Their Development and Properties. pp. 2-4. International Institute for Cotton, Manchester, UK.
- Vix, H.L.E., Spadaro, J.J.; Murphey, C.H.; Persell, R.M.; Pollard, E.F.; and Gastrock, E.A.  
1949. Pilot-plant fractionation of cottonseed. II. Differential settling. J. Amer. Oil Chem. Soc. 26:526-530.
- Vlasova, N.A.  
1971. Interaction between nucleus and cytoplasm in the ontogenesis of epidermal and fibrillar cells of cotton ovules. Ontogenez. 2:88-99.
- Vreugdenhil, D.; Burgers, A.; Harkes, P.A.A.; and Libbenga, K.R.  
1981. Modulation of the number of membrane-bound auxinbinding sites during the growth of batch-cultured tobacco cells. Planta 152:415-419.

## W

- Waddington, J.  
1971. Observation of plant roots 'in situ'. Can. J. Bot. 49:1850-1852.
- Waddle, B.M.  
1954. The inheritance of photoperiodic response in short day X day neutral cotton hybrids. Ph.D. Dissertation, Texas A&M College, College Station.
- Waddle, B.M.; Lewis, C.R.; and Richmond, T.R.  
1961. The genetics of flowering response in cotton. III. Fruiting behavior of *Gossypium hirsutum* race *latifolium* in a cross with a variety of cultivated American Upland Cotton. Genetics. 46:427-437.
- Wadleigh, C.H.  
1944. Growth status of the cotton plant as influenced by the supply of nitrogen. Arkansas Agr. Exp. Sta., Bull. 446.
- Wadleigh, C.H.  
1968. Wastes in relation to agriculture and forestry. USDA Misc. Pub. 1065.
- Wadleigh, C.H., and Gauch, H.G.  
1948. Rate of leaf elongation as affected by the intensity of the total soil moisture stress. Plant Physiol. 23:485-495.
- Waggoner, P.E.  
1969. Environmental manipulation for higher yields. Chap. 15. In J.D. Eastin, F.A. Haskins, C.Y. Sullivan, and C.H.M. van Bavel (eds), Physiological Aspects of Crop Yield. pp. 343-373. Amer. Soc. Agron. and Crop Sci. Soc., Madison, Wisconsin.
- Wainwright, I.M.; Palmer, R.L.; and Dugger, W.M.  
1980. Pyrimidine pathway in boron-deficient cotton fiber, Plant Physiol. 65:893-896.
- Waiss, A.C., Jr.; Chan, B.G.; Elliger, C.A.; and Binder, R.G.  
1981. Biologically active cotton constituents and their significance in HPR. Proc. Beltwide Cotton Prod. Res. Conf. pp. 61-63.
- Wakeham, H.  
1955. Cotton fiber length distribution. An important factor. Text. Res. Journ. 24:422-429.
- Wakelyn, P.J.  
1975. Amino-acid composition of total protein of cotton. Text. Res. Journ. 45 419-420.

- Wakelyn, P.J.; Stipanovic, R.D., and Bell, A.A.  
1974. Identification of scopoletin in dried bract of the cotton plant. *J. Agric. Food Chem.* 22:567-568.
- Walbot, V., and Dure, L.S., III  
1976. Developmental biochemistry of cottonseed embryogenesis and germination VII Characterization of the cotton genome. *J. Mol. Biol.* 101:503-536.
- Walbot, V.; Harris, B., and Dure, L.S., III  
1975. The regulation of enzyme synthesis in the embryo-germination and germination of cotton. *In C. Markert (ed.), The Developmental Biology of Reproduction (33rd Symp Soc Dev. Biol.)*, pp 165-187. Acad. Press, NY
- Walhood, V.T  
1956. A method of reducing the hard seed problem in cotton. *Agron. J.* 48:141-142
- Walhood, V.T.  
1957. The effect of gibberellins on boll retention and cutout in cotton. *Proc. 12th Cotton Defoliation-Physiol. Conf.*, pp 24-30
- Walhood, V.T  
1958. Effect of gibberellins on yield and growth of cotton. *Proc. 13th Cotton Defoliation-Physiol Conf.*, pp. 27-30.
- Walhood, V.T., and Addicott, F.T.  
1968. Harvest-aid programs: Principles and practices. *In F.C. Elliot, M. Hoover, and W.K. Porter, Jr (eds.), Advances in Production and Utilization of Quality Cotton. Principles and Practices*, pp. 407-431. Iowa State University Press, Ames.
- Walhood, V.T., and Counts, B.  
1955. Boll, fiber and seed properties of early and late season bolls. *Proc. 10th Ann Beltwide Cotton Defol. Conf* pp. 51-53.
- Walhood, V.T., and McMeans, J.L.  
1964. Seed number as a factor in fruit retention in cotton. *Proc. 18th Ann. Beltwide Cotton Defol Physiol Conf* pp. 30-33
- Walker, D.A.  
1976. Regulatory mechanisms in photosynthetic carbon metabolism. *In B.L. Horecker and E.R. Stadtman (eds.), Current Topics in Cellular Regulation, Vol. II*, pp 203-241. Acad. Press, NY.
- Walker, J.R.L.  
1975. *The Biology of Plant Phenolics*. E. Arnold (Publishers), London
- Wall, J.H.; Muller, L.L.; and Berni, R.J.  
1980a. Quantization of lacinilene C 7-methyl ether in cotton dust. *Proc. Fourth Cotton Dust Research Conf.* pp. 58-61.
- Wall, J.H.; Muller, L.L., and Berni, R.J.  
1980b. Determination of lacinilene C 7-methyl ether by high performance liquid chromatography. *J. Liq. Chromatography* 4 561-572
- Wallace, R.W.  
1976. Isolation and partial characterization of the acaln A and B fractions of cottonseed globulins. *Dissertation. Texas A&M University, College Station, Texas.*
- Wallace, R.W., and Dieckert, J.W.  
1976. Isolation of coconut storage proteins by polyacrylamide gel electrophoresis. *Anal. Biochem* 75:498-508.
- Wallace, R.W.; Yu, P.H.; Dieckert, J.P., and Dieckert, J.W.  
1974. Visualization of protein-SDS complexes in polyacrylamide gels by chilling. *Anal. Biochem.* 61:86-92.
- Wallach, D.; Marani, A.; and Kletter, E  
1978. The relation of cotton crop growth and development to final yield. *Field Crops Res* 1:283-294.

- Waller, D.P.; Zaneveld, L.J.D.; and Fong, H.H.S.  
1980. *In vitro* spermicidal activity of gossypol. *Contraception* 22: 183-188.
- Walter, H.; Gausman, H.W.; Rittig, F.R.; Namken, L.N.; Escobar, D.E., and Rodriguez, R.R.  
1980. Effect of mepiquat chloride on cotton plant leaf and canopy structure and dry weights of its components. *Proc. Beltwide Prod. Res. Conf.*, pp. 32-35.
- Walters, L.G., and Dure, L.S.  
1966. Ribonucleic acid synthesis in germinating cotton seeds. *J. Mol. Biol.* 19:1-27.
- Walton, D.C.  
1977. Abscisic acid and seed germination. *In* A.A. Khan (ed.), *The Physiology and Biochemistry of Seed Dormancy and Germination*, pp. 145-178. Elsevier/North-Holland Press.
- Walton, D.C.  
1980/81 Does ABA play a role in seed germination? *Isr. J. Bot.* 29:168-180.
- Walton, D.C.; Galson, E.; and Harrison, M.A.  
1977. The relationship between stomatal resistance and abscisic acid levels in leaves of water stressed bean plants. *Planta* 133:145-148.
- Walton, J., and Ray, P.M.  
1981. Receptor function of auxin binding sites in maize. *Plant Physiol.* 68:1334-1338.
- Wang, S.C., and Pinckard, J.A.  
1973. Cotton boll cuticle, a potential factor in boll rot resistance. *Phytopath.* 63:315-319.
- Wanjura, D.F.  
1982. Reduced cotton productivity from delayed emergence. *Trans. ASAE* 25:1536-1539.
- Wanjura, D.F., and Buxton, D.R.  
1971. A model for simulating cotton seedling emergence. *Proc. Beltwide Cotton Prod. Res. Conf.* pp. 78-79.
- Wanjura, D.F., and Buxton, D.R.  
1972a. Water uptake and radicle emergence of cottonseed as affected by soil moisture and temperature. *Agron. J.* 64:427-431.
- Wanjura, D.F., and Buxton, D.R.  
1972b. Hypocotyl and radicle elongation of cotton as affected by soil environment. *Agron. J.* 64:431-434.
- Wanjura, D.F.; Hudspeth, E.B., Jr.; and Bilbro, J.D., Jr.  
1969. Emergence time, seed quality, and planting depth effects on yield and survival of cotton (*Gossypium hirsutum* L.). *Agron. J.* 61:63-65.
- Wanjura, D.F., and Minton, E.B.  
1974. Evaluation of cottonseed hydration-chilling treatments for improving seedling emergence. *Agron. J.* 66:217-220.
- Wanjura, D.F., and Minton, E.B.  
1981. Delayed emergence and temperature influences on cotton seedling vigor. *Agron. J.* 73:594-597.
- Wardel, W.L., and Skoog, F.  
1969. Flower formation in excised tobacco stem segments: I. Methodology and effect of plant hormones. *Plant Physiol.* 44:1402-1406.
- Wardlaw, I.F.  
1968. The control and pattern of movement of carbohydrate in plants. *Bot. Rev.* 34:79-105.
- Wardlaw, I.F.  
1980. Translocation and source-sink relationships pp. 297-339. *In* P.S. Carlson (ed.), *The biology of crop productivity*. Acad. Press, New York, NY.
- Wardlaw, I.F., and Moncur, L.  
1976. Source, sink, and hormonal control of translocation in wheat. *Planta* 128:93-100.
- Ware, J.O.  
1931. Selection of cotton plants for protein and oil content. *Ark. Agr. Exp. Sta. Bull.* 268. pp. 34-35.

- Wareing, P.F., and Patrick, J.  
1975 Source-sink relations and the partition of assimilates in the plant *In* J.P. Cooper (ed.), *Photosynthesis and Productivity in Different Environments*, pp 481-494 Cambridge University Press, London.
- Wareing, P.F.; Khalifa, M.M.; and Treharne, K.J.  
1968. Rate-limiting process in photosynthesis at saturating light intensities *Nature* 220:453-457.
- Warwicker, J.O., Jeffriss, R., Colbran, A.L., and Robinson, R.N.  
1966. A review of the literature as the effect of caustic soda and other swelling agents on the fine structure of cotton. Shirley Institute Pamphlet, nr 93.9-54.
- Waterkeyn, L.  
1974. Analyse des divers facteurs conditionnant la résistance mécanique des poils végétaux. Etude des structures membranaires et des moyens d'intervention permettant de les modifier en vue d'une amélioration des propriétés technologiques Rapport final de l'étude F.R.F.C., nr 702.
- Waterkeyn, L.  
1981. Cytochemical localization and function of  $\beta$ , 3-glucan callose in the developing cotton fiber cell wall *Protoplasma*. 106:49-67.
- Waterkeyn, L.  
1985. Light Microscopy of the Cotton Fibre. In: International Institute of Cotton. *Cotton Fibres: Their Development and Properties*. pp. 17-20. International Institute for Cotton, Manchester, UK.
- Waterkeyn, L., De Langhe, E.; and Eid, A.A.H.  
1975. *In vitro* culture of fertilized cotton ovules. II. Growth and differentiation of cotton fiber. *La Cellul*, 71 41-51
- Watson, D.J.  
1952. The physiological basis of variation in yield. *Adv. Agron.* 4:101-145
- Watson, H., and Helmer, J.D.  
1964 Cottonseed quality as affected by ginning process—a progress report. USDA, ARS 42-107. Dec. 1964
- Watson, M.W., and Berlin, J.D.  
1973. Differentiation of lint and fuzz fibers on the cotton ovule. *J. Cell Biol.* 59 360a.
- Wauford, S.H.  
1979. *In vitro* germination of upland cotton pollen: An analysis of parameters affecting germination and tube length M.S. Thesis University of Tennessee, Knoxville, TN.
- Weaver, J.E.; Jean, F.C.; and Crist, J.W.  
1972. Development and activities of roots of crop plants. Carnegie Inst. Wash. Pub. No. 316.
- Webb, J.C.; Stone, R.B., Jr.; and McDow, J.J.  
1966. Response of cottonseed to audiofrequency gas plasma. *Trans. of the ASAE* 9 872-874, 879.
- Webb, J.C.; Stone, R.B., Jr.; and Pate, J.B.  
1964. Results of laboratory and field tests of gas plasma irradiated cottonseed. *Trans. of the ASAE* 7:412-417
- Webber, H.J., and Boykin, E.B.  
1907. The advantage of planting heavy cotton seed *USDA Farmer's Bulletin* 285. pp. 16
- Webster, B.D.  
1973. Anatomical and histochemical changes in leaf abscission. *In* *Shedding of Plant Parts*, T.T. Kozlowski (ed.), pp. 45-83. Acad. Press, New York and London.
- Weintraub, I.A., and Tuen, N.T.  
1971 On the quarternary structure of the vetch seed legumin (In Russian) *Molekulyarnaya Biologiya* 5:59-68.
- Weir, H.L.  
1959. Germination of cottonseed (*Gossypium hirsutum* L.). *Proc. Assoc. Off. Seed Anal.* 49:77-79.
- Went, F.W., and Carter, M.  
1948. Growth response of tomato plants to applied sucrose. *Amer. J. Bot.* 35:95-106.

- West, N.E., and Klemmedson, J.O.  
1978. Structural distribution of nitrogen in desert ecosystems. *In* N.E. West and J. Skujins (eds.), Nitrogen in Desert Ecosystems, pp. 1-16. Dowden, Hutchinson, and Ross, Stroudsburg, Pennsylvania.
- Westafer, J.M., and Brown, R.M., Jr.  
1976. Electron microscopy of the cotton fibre. New observations on cell wall formation. *Cytobios* 15:111-138.
- Weaver, J.B.  
1958. Embryological studies following interspecific crosses in *Gossypium* II. *G. arboreum* x *G. hirsutum*. *Amer. J. Bot.* 45:10-16.
- White, A.B., Jr.  
1958. Fat utilization and composition in germinating cottonseed. *Plant Physiol.* 33:218-226.
- Whiteman, P.C., and Köller, D.  
1967. Interactions of carbon dioxide concentration, light intensity and temperature on plant resistances to water vapour and carbon dioxide diffusion. *New Phytol.* 66:463-473.
- Whitney, J.B.  
1941. Effects of the composition of the soil atmosphere on the absorption of water by plants. *Amer. J. Bot.* 28:14
- Widholm, J.M., and Ogren, W.L.  
1969. Photorespiratory-induced senescence of plants under conditions of low carbon dioxide. *Proc. Nat. Acad. Sci. USA* 63:668-675.
- Widmaier, R.; Howe, J.; and Heinstein, P.  
1980. Prenyltransferase from *Gossypium hirsutum*. *Arch. Biochem. and Biophys.* 200:609-616.
- Wiese, M.V., and DeVay, J.E.  
1970. Growth regulator changes in cotton associated with defoliation caused by *Verticillium albo-atrum*. *Plant Physiol.* 45:304-309.
- Wiles, A.B.  
1959. Beneficial effects of calcium on cotton seedlings. *Miss. Agr. Exp. Sta. Info. Sheet* 637.
- Wiles, A.B.  
1960. Low vigor seed may cause poor stand of cotton. *Miss. Farm. Res.* 23:1.
- Wiles, A.B., and Presley, J.T.  
1960. Seed deterioration as a factor in nub-root production in cotton. *Plant Dis. Repr.* 44:472-473.
- Wilkes, L.H.  
1969. Physical properties of seed and environmental factors affecting emergence. *Proc. Beltwide Cotton Prod. Mech. Conf.* pp. 15-16.
- Wilkes, L.H.  
1970. What is quality--as it relates to planted seed? *Proc. Beltwide Cotton Prod. Res. Conf.* pp. 90-93
- Wilkes, L.H.  
1978. Seed cotton storage: Effects on seed quality. *Proc. Beltwide Cotton Prod. Res. Conf.* pp. 215-217.
- Wilkes, L.H.; Jones, R.; Underbrink, G.; and Alden, W.H.  
1972. Design and development of a seed cotton handling and storage system. *Proc. Beltwide Cotton Prod. Res. Conf.* pp. 73.
- Wilkes, L.H.; Kunze, O.R.; and Niles, G.A.  
1968. Field emergence of cotton as affected by seed density, *Texas Agr. Exp. Sta. Pro. Rpt.* 2508.
- Wilkes, L.H., and Sorenson  
1973. Effect of field storage and handling on seed and lint quality. *Sum. Proc. West. Cotton Prod. Conf.* pp. 50-52
- Williams, C.B.  
1906. The cotton plant. *The Bulletin, North Carolina State Board of Agric.* Vol. 27.

- Williams, J.  
1978. Carbon Dioxide, Climate and Society. Proceedings of a IIASA Workshop Cosponsored by WMO, UNEP, and SCOPE, February 21-24, 1978 Pergamon Press, New York pp 332
- Williams, J.L.; Ingram, P., Peterlin, A.; and Woods, D.K.  
1974 Never-dried cotton fibers: Part II: Fixation on the never-dried state. *Text Res. Journ.* 44:370-377.
- Williamson, C.E., and Dimmock, A.W.  
1953. Ethylene from diseased plants. *USDA Yearbook Agr.* pp. 881-886.
- Willison, J H M.  
1978. Cell wall biosynthesis in the cotton fiber; in 176th ACS National Meeting Cellulose, Paper and Textile Chemistry Division American Chemical Society
- Willison, J H.M., and Brown, R M., Jr.  
1977 An examination of the developing cotton fiber: Wall and plasmalemma. *Protoplasma* 92:21-44
- Willison, J.H.M., and Brown, R.M , Jr.  
1978 A model for the Pattern of deposition of microfibrils in the Cell wall of Glaucocysts. *Planta*, 141:51-58.
- Wilson, J.T., Katterman, F.R.H., and Endrizzi.  
1976. Analysis of repetitive DNA in three species of *Gossypium*. *Biochem. Genet* 14:1 1071-1075
- Wilson, F.D., and Lee, J A.  
1971. Genetic relationship between tobacco budworm feeding response and gland number in cotton seedlings. *Crop Sci.* 11:419-421.
- Wilson, F.D., and Smith, J N.  
1977 Variable expressivity and gene action of gland-determining alleles in *Gossypium hirsutum* L. *Crop Sci.* 17:539-543.
- Wit, C.T de.  
1958. Transpiration and crop yields. *Agr. Res Rep. Wageningen* 64:1-88.
- Wit, C T de  
1978. Simulation of Assimilation, Respiration, and Transpiration of Crops. Halsted Press, New York.
- Witt, H T  
1975. Primary acts of energy conservation in the functional membrane of photosynthesis. *In* Govindjee (ed.), *Bioenergetic of Photosynthesis* pp. 493-554 Acad Press, NY
- Wittenbach, V.A., and Bukovac, M.J.  
1973. Cherry fruit abscission: Effect of growth substances, metabolic inhibitors and environmental factors. *J Amer. Soc. Hort Sci.* 98:348-351
- Wittwer, S H  
1970a. Aspects of CO<sub>2</sub> enrichment for crop production. *Trans. Ameri. Soc Agr Eng.* 13:249-251.
- Wittwer, S.H.  
1970b Fertilizing with CO<sub>2</sub>. *Crops and Soils* 23:10-12.
- Wittwer, S.H.  
1978a Carbon Dioxide fertilization of crop plants. Chap. 9. *In* U.S. Gupta (ed ), *Crop Physiology*, pp. 310-333, Oxford and IBH Pub. Co., New Delhi, India
- Wittwer, S.H.  
1978b. Production potential of crop plants. *In* U.S. Gupta (ed ), *Crop Physiology*. pp. 334-373, Oxford and IBH Pub. Co., New Delhi, India.
- Wittwer, S.H.  
1980. Carbon dioxide and climate change. An agricultural perspective. *J Soil Water Conserv* 35:116-120.
- Wittwer, S H  
1981. Advances in protected environments for plant growth *In* J. Manassah and E.J. Briskey (eds.), *Advances in Food Production Systems for Arid and Semi-Arid Lands*, pp. 679-715 Acad. Press, New York

- Wittwer, S.H.  
1982a. Agricultural adaptation to the rising level of atmospheric carbon dioxide. *In* W.C. Clark (ed.), *Carbon Dioxide Review*, pp. 320-324. Oxford University Press, New York.
- Wittwer, S.H.  
1982b. Carbon Dioxide and crop productivity. *New Scientist* 95:233-234.
- Wittwer, S.H.  
1983. Rising atmospheric carbon dioxide and crop productivity. *HortSci.* 16:667-673.
- Wittwer, S.H., and Robb, W.M.  
1964. Carbon dioxide enrichment of greenhouse atmospheres for food crop production. *Econ. Bot* 18:34-56.
- Wold, B.J.; Klein, W.H.; Hough-Evans, B.R.; Britten, R.J.; and Davidson, E.H.  
1978. Sea urchin embryo mRNA sequences expressed in the nuclear RNA of adult tissues. *Cell* 14:941-950.
- Wolf, W.J., and Briggs, D.R.  
1959. Purification and characterization of the 11S component of soybean proteins. *Arch. Biochem. Biophys.* 85:186-199.
- Wolfenbarger, D.A., and Davis, J.W.  
1976. Termination of cotton plants with chemicals and the effect on populations of boll weevils and tobacco budworms. *Proc. Beltwide Cotton Prod. Res. Conf.* pp. 46-48.
- Wong, J.R., and Sussex, I.M.  
1980a. Isolation of abscisic acid-resistant variants from tobacco cell cultures I. Physiological bases for selection. *Planta* 148:97-102.
- Wong, J.R., and Sussex, I.M.  
1980b. Isolation of abscisic acid-resistant variants from tobacco cell cultures. II Selection and characterization of variants. *Planta* 148:103-107.
- Wong, S.C.  
1979. Elevated atmospheric partial pressure of CO<sub>2</sub> and plant growth. I. Interactions of nitrogen nutrition and photosynthetic capacity in C<sub>3</sub> and C<sub>4</sub> plants. *Oecologia* 44:68-74.
- Wong, S.C.  
1980. Effects of elevated partial pressure of CO<sub>2</sub> on rate of CO<sub>2</sub> assimilation and water use efficiency in plants. *In* G.I. Pearman (ed), *Carbon Dioxide and Climate: Australian Research*, pp. 159-166. Australian Academy of Science, Canberra, Australia.
- Wong, S.C.; Cowan, I.R.; and Farquhar, G.D.  
1979. Stomatal conductance correlates with photosynthetic capacity. *Nature* 282:424-426.
- Woo, K.C., and Osmond, C.B.  
1976. Glycine decarboxylation in mitochondria isolated from spinach leaves. *Aust. J. Plant Physiol.* 3:771-785.
- Woo, K.C., and Wong, S.C.  
1983. Inhibition of CO<sub>2</sub> assimilation by supraoptimal CO<sub>2</sub>: Effect of light and temperature. *Aust. J. Plant Physiol.* 19:75-85.
- Woodruff, J.M.; McCain, F.S.; and Hoveland, C.S.  
1967. Influence of relative humidity, temperature and light during boll maturation on cottonseed quality. *Proc. Beltwide Cotton Prod. Res. Conf.* 1967:206.
- Woodstock, L.W.  
1973. Physiological and biochemical tests for seed vigor. *Seed Sci. and Technol.* 1:127-157.
- Woodward, W.T.W., and Malm, N.R.  
1976. Influence of lint percentage on yield, boll, and fiber characteristics in acala strains of upland cotton. *Crop Sci.* 16:594-596.
- Worley, S., Jr.; Tuner, J.H.; and Ramey, H.H., Jr.  
1974. Lint density index as a component of yield. 1974 Beltwide Cotton Prod. Res. Conf. Proc. pp. 142.
- Worley, S.; Ramey, H.H.; Harrell, D.C.; and Culp, T.W.  
1976. Ontogenetic model of cotton yield. *Crop Sci.* 16:30-34.



- Wortman, L.S., and Rinke, E.H.  
1951. Seed corn injury at various stages of processing and its effect upon cold test performance  
*Agron. J.* 43:299-305.
- Wright, D.J., and Boulter, D.  
1974. Purification and subunit structure of legumin of *Vicia faba* L. (Broad Bean) *Biochem. J.* 141:413-418.
- Wright, S.T.C., and Hiron, R.W.P.  
1969. Abscisic acid, the growth inhibitor induced in detached wheat leaves by a period of wilting.  
*Nature (London)* 224:719-720.
- Wulff, R., and Strain, B.R.  
1982. Effects of CO<sub>2</sub> enrichment on growth and photosynthesis in *Desmodium paniculatum*. *Can. J. Bot.* 60:1084-1091.
- Wysc, R.  
1980. Growth of sugar beet seedlings in various atmospheres of oxygen and carbon dioxide. *Crop Sci.* 20:456-458.

## Y

- Yager, R.E.  
1960. Possible role of pectic enzymes in abscission. *Plant Physiol.* 35:157-162.
- Yaklich, R.W., and Abdul-Baki, A.A.  
1975. Variability in metabolism of individual axes of soybean seeds and its relationship to vigor  
*Crop Sci.* 15:424-426.
- Yamaguchi, S.  
1954. Some interrelationships of oxygen, carbon dioxide, sucrose, and ethylene in abscission. Ph.D. Dissertation, University of California, Los Angeles.
- Yatsu, L.Y., and Jacks, T.J.  
1981. An ultra structural study of the relationship between microtubules and microfibrils on cotton (*Gossypium hirsutum* L.) cell wall reversals. *Am. J. Bot.* 68:771-777.
- Yeatman, C.W.  
1971. Genetics of jack pine seedling response to CO<sub>2</sub> and pollination studies. Petawa, 1968-70. In Proceedings of the Twelfth Meeting of the Committee on Forest Tree Breeding in Canada, Universite Laval, Quebec, pp. 101-105.
- Yfoulis, A., and Fasoulas, A.  
1978. Role of minimum and maximum environmental temperature on maturation period of the cotton boll. *Agron. J.* 70:421-425.
- Yimbo, P.O.  
1980. Relative contribution of turgor pressure and available substrate for leaf growth. M.S. Thesis, Plant and Soil Science Dept., pp. 62.
- Yoshida, S.  
1972. Physiological aspects of grain yield. *Ann. Rev. Plant Physiol.* 23:437-464.
- Yoshida, S.  
1973. Effects of CO<sub>2</sub> enrichment at different stages of panicle development on yield components and yield of rice (*Oryza sativa* L.). *Soil Sci. Plant Nutr.* 19:311-316.
- Yoshida, S.; Cock, J.H.; and Pararo, F.T.  
1971. Physiological aspects of high yields. Symposium on Rice Breeding Intl Rice Res. Inst., Los Banos, Philippines.
- Young, D.H.  
1942. Cottonseed treatments and angular leaf spot control. *Phytopath.* 32:651.
- Young, E.F., Jr.; Taylor, R.M.; and Petersen, H.D.  
1980. Day-degree units and time in relation to vegetative development and fruiting for three cultivars of cotton. *Crop Sci.* 20:370-374.

Yu, P.H.

1977. Isolation and partial characterization of arachin and  $\alpha$  conarachin from the seeds of *Arachis hypogaea* L. Dissertation. Texas A&M University, College Station, Texas.

Yue-Quing, S.; Bing-Chu, F.; and Min-Zhi, S.

1980a. Approach to physiological functions of ethrel in the ripening of cotton boll. *Act. Bot. Sin.* 22:236-240.

Yue-Quing, S.; Bing-Chu, F.; and Min-Zhi, S.

1980b. The effect of photosynthesis and translocation in cotton leaf. *Act. Bot. Sin.* 22:136-140.

## Z

Zaitlin, M., and Coltrin, D.

1964. Use of pectic enzymes in a study of the nature of intercellular cement of tobacco leaf cells. *Plant Physiol.* 39:91-95.

Zaitzev, G.S.

1928. Effect of temperature on the development of the cotton plant. *Trans. Turkestan Plant Breeding Sta. Tashkent*, No. 2 (as quoted in J.M. Hector, *Introduction to Botany of Field Crops* Vol. 2, pp. 894. Central News Agency, (Johannesburg)

Zarins, Z.M., and Cherry, J.P.

1981. Storage proteins of glandless cottonseed flour. *J. Food Sci.* 46:1855-1859.

Zeevaart, J.A.D.

1976. Physiology of flower formation. *Ann. Rev. Plant Physiol.* 27:321-348.

Zelitch, I.

1963. The control and mechanisms of stomatal movement. *Bull. Conn. Agr. Exp. Sta.* 664.

Zelitch, I.

1965. Environmental and biochemical control of stomatal movements in leaves. *Biol. Rev.* 40:463-482.

Zelitch, I.

1969. Stomatal control. *Ann. Rev. Plant Physiol.* 20:329-350.

Zelitch, I.

1971. Photosynthesis, Photorespiration, and Plant Productivity. *Acad. Press, New York*, pp. 347

Zelitch, I.

1979. Photorespiration: Studies with whole tissues, pp. 353-367. *In Photosynthesis II. Photosynthetic Carbon Metabolism and Related Processes*, M. Gibbs and E. Latzko (eds.), *Encyclopedia of Plant Physiology* Vol. 6. Springer-Verlag, NY.

Zenk, M.H., and Müller, G.

1963. *In vivo* destruction of exogenously applied indolyl-3-acetic acid as influenced by naturally occurring phenolic acids. *Nature* 200:761-763.

Zimmerman, R.H.; Krizek, D.T.; Klueter, H.H.; and Bailey, W.A.

1970. Growth of crabapple seedlings in controlled environments: Influence of seedling age and CO<sub>2</sub> content of the atmosphere. *J. Amer. Soc. Hort. Sci.* 95:323-325.

Zur, M.; Maram, A.; and Carmeli, R.

1970. Effect of CMH (N-dimethyl-N-chloroethyl-hydrazonium chloride) as compared with that of CCC (2-chloroethyl trimethylammonium chloride) on height, earliness and yield of cotton. *Israel J. Agric. Res.* 20:133-144.

Zur, M.; Marani, A.; and Karadavid, B.

1972. Effects of growth retardants CCC and CMH on cotton. *Cotton Grow. Rev.* 49:250-257.

Zurfluh, L.L., and Guilfoyle, T.J.

1980. Auxin induced changes in the pattern of protein synthesis in soybean hypocotyl. *Proc. Nat'l. Acad. Sci. USA*, 77:357-361.

Zurfluh, L.L., and Guilfoyle, T.J.

1982. Auxin- and ethylene-induced changes in the population of translatable messenger RNA in basal sections and intact Soybean hypocotyl. *Plant Physiol.* 69:338-340.

## A

- ABA, *see* abscisic acid
- abscisic acid, 42-44, 70-71, 94, 97-99, 114-115, 119-120, 123, 126-127, 138, 146, 217, 284, 362
- abscission and, 119-120, 147
- boll age and, 127, 129
- dormancy, 475, 514
- embryo culture, 456-460
- embryo levels, 458-459
- fiber elongation, 278-279, 330, 369-371
- functions, 125
- gene induction, 430
- germination enzymes, 457-460
- maturation phase, 286
- mRNA modulation, 437-438
- nucleolar size, 368
- precocious germination, 457
- secondary wall formation, 371-372
- seed development, 285
- stimulation of ethylene, 119
- stress induction of, 42
- vivipary, 460, 448, 457
- abscission, 41, 43
- abscisic acid and, 119-120, 147
- after irrigation, 70
- amino acids and, 122-123, 148
- CO<sub>2</sub> and, 43, 218-222
- cytokinin and, 121, 148
- enzymes, 116
- ethylene and, 118, 219
- fruit, 115-123
- gibberellin and, 120-121
- hormonal control, 44, 130-131, 144
- leaf, 143-144
- mechanisms, 143-146
- rate and boll age, 129-130, 133
- square, 115, 262
- temperature responses, 43
- water deficit effects, 68-71, 144
- zone, 116-118, 144-150, 219
- acalin A, 415
- chemistry, 416-417
- molecular weight, 416-417
- subunit homology, 418-419
- subunits, 417
- vicilin protein, 419, 421
- acalin B, 415
- chemistry, 416-417
- legumin protein, 419, 421
- molecular weight, 416-417
- subunits, 417-419
- acephate, 139
- ACC *see* L-aminocyclopropane-1-carboxylic acid
- accumulation phase, 282, 284-286, 466
- mineral compartmentation, 307
- aconitase, 445, 449
- adaptation, 1
- aflatoxins, 479
- air pollution, 42-43, 45
- CO<sub>2</sub> moderation of injury, 223
- flowering response, 40
- aleurins, 415
- allometric growth, 280-281
- amino acids
- abscission promotion, 148
- fiber age and incorporation, 407-408
- genotype-environment interaction, 576, 578, 580-583
- ovule incorporation, 407-408
- seed development, 468
- storage protein, 433, 570, 579
- L-aminocyclopropane-1-carboxylic acid, 122
- aminoethoxyvinyl glycine, 119
- ammonium and ovule development, 290
- anthesis, 114
- anthesis, 269-272
- fiber initiation, 327, 377
- anthocyanins
- budworm toxicity, 605
- structure, 604
- tissue location, 604
- ascorbic acid, 123, 146
- asparagine, 289
- Aspergillus flavus*, 478-479
- assimilates, 73-74
- boll sources, 312
- competition, 315
- partitioning *see* partitioning
- supply, 311-314
- transport duration, 323
- auxin, 41, 117, 123
- abscission, 117
- changes with boll age, 127-128
- ethylene interaction, 117, 147
- exogenous application, 133-134
- fiber elongation, 369-371
- fiber quality and, 141
- functions, 125
- mode of action, 371
- nucleolus and, 330, 368
- pollination and, 127
- secondary wall formation, 371-372
- tissue culture, 625-629
- auxin-gradient theory, 117, 146-147
- AVG *see* aminoethoxyvinyl glycine
- axillary branches, 11-13
- schematic representation, 12
- axillary buds, 11
- azinphosmethyl, 138

## B

- beta-1,3-glucan, 337, 343
- beta-oxidation enzymes, 444-445, 449, 454, 457-458
  - mature embryos, 453
  - maturing embryos, 451-452
- BGR *see* boll growth rate
- blooms per day, 469
- boll
  - accumulation phase *see* accumulation phase
  - age vs. assimilation, 316, 318
  - assimilate sources, 312
  - carbohydrate sink, 124
  - competition, 294
  - dehiscence, 286
  - development *see* boll development
  - dry weight, 50, 57-62, 185
  - enlargement phase *see* enlargement phase
  - growth rate, 189, 316, 318
  - load *see* boll load
  - maturation phase *see* maturation phase
  - nutrient transport, 289
  - opening, 286-287
  - period, 51, 53-54, 57, 272-297
  - period vs. temperature, 54, 291-293, 352-353
  - plant location, 23
  - retention *see* boll retention
  - rot, 478
  - set, 272-274
  - shedding *see* shedding
  - sugars vs. temperature, 353
  - water potential, 287
- boll development, 51-54
  - calcium compartmentation, 305-306
  - competitive interactions, 293-297
  - dry weight distribution, 302
  - environment, 287-293
  - events, 298-299
  - magnesium compartmentation, 306-307
  - mineral environment, 288-291
  - N compartmentation, 303
  - nitrogen, 288-289
  - phases, 299
  - phosphorus compartmentation, 303-304
  - potassium compartmentation, 304-305
  - temperature, 291-293
  - water stress, 287
- boll load, 187-188
  - cutout, 124
  - hormone balance and, 126
  - leaf area and, 100
  - root growth response to, 125
  - soil water interaction, 67
- boll retention, 60, 62
  - gibberellin and, 132
  - nitrogen, 102

- borescope, 33
- boron and
  - earliness, 85
  - fiber development, 291
  - fruiting index, 84-85
  - relative fruitfulness, 84-85
- bracts, 5, 261
- budworm (*Heliothis*), 59
- bur, 298, 302-308
  - potassium sink, 304
- byssinosis
  - flavonols, 603
  - terpenoid aldehydes, 618

## C

- C<sub>2</sub> pathway *see* glycolate pathway
- C<sub>2</sub>-PCO *see* glycolate pathway
- C<sub>2</sub>-photosynthetic carbon oxidation (PCO), *see* glycolate pathway
- C<sub>3</sub> plants, 216-217, 223
  - CO<sub>2</sub> enrichment and, 194, 197-198
- C<sub>4</sub> plants, 175, 206, 216-217, 223
  - CO<sub>2</sub> enrichment and, 196-198
  - photosynthetic pathway, 167
- C<sub>5</sub>-PCR *see* Calvin cycle
- cacodylic acid, 149
- calcium and
  - boll compartmentation, 305-306
  - fruiting index, 83-84
  - relative fruitfulness, 83-84
- calcium arsenate, 138
- callose *see* beta-1,3-glucan
- Calvin cycle, 167-169, 176-177, 232
- canopy, 184
  - carbohydrate production, 183-191
  - development, 68
  - interception of sunlight, 186-187
- carbohydrate
  - canopy production, 183-191
  - distribution in boll, 311-324
  - distribution in the canopy, 183-191
  - elements controlling translocation, 86
  - nitrogen and, 98, 102
  - sink, 27
  - status, 44
  - stress, 252-254
  - translocation pattern, 184
- carbon
  - enzyme regulation of flow, 235
  - exchange rate (CER), 183, 187, 230, 233, 311-314
  - photosynthetic metabolism, 167-180
  - reduction pathway *see* Calvin cycle
- carbon dioxide, 41
  - abscission response, 43

- antitranspirant role, 216-217  
 canopy fixation rates, 186  
 compensation point, 169, 180, 229, 231, 235, 240  
 conductance, 230-232  
 ethylene interaction, 219, 221  
 flowering response, 40  
 global increase, 223-224  
 greenhouse effect, 223-224  
 interaction with environmental factors, 222-223  
 nitrogen fertility interaction, 198-199  
 photosynthesis and, 169  
 carbon dioxide enrichment, 193-225  
   atmospheric, 194-196  
   beneficial effects, 194  
   controlled environments, 194-195  
   crops tested under, 193-194  
   dry matter production under, 209-214  
   economic costs, 195-196  
   frequency of exposure, 212  
   length of exposure, 200  
   metabolic effects, 197-222  
   time of exposure, 212  
   under field conditions, 195-196  
 carbon dioxide enrichment and  
   abscission, 218-222  
   air pollution injury, 223  
   apical dominance, 214  
   branching, 214  
   chlorophyll, 204  
   dehiscence, 219  
   dry weight, 211  
   flowering, 194-195  
   fruiting position number, 218  
   growth, 209-214  
   leaf area, 211, 213  
   leaf plastochron, 212  
   photosynthesis, 197-203, 312, 314  
   plant structure, 204  
   reproductive development, 218  
   senescence, 218-222  
   square retention, 218  
   stomatal conductance, 214-218  
   sugar level, 204-205  
   transpiration, 214-218  
   water use efficiency, 215-218  
 carotene, beta, 160  
 carotenoids, 159-161  
 carotenols *see* xanthophylls  
 carpel  
   number and environment, 263-265  
   vascular system, 287  
 CCC *see* cycocel  
 cell division *see* mitosis  
 cellulase, 116, 118, 144, 147-148, 219  
 cellulose  
   degree of polymerization, 55, 336-337, 341  
   percent, 55  
   cellulose synthesis, 52-55, 283, 342-343  
   fiber age, 337  
   metabolic inhibitors, 372  
   rate, 321  
   cellulose synthetase, 392, 395  
   central vacuole, 388-389, 391-392  
   CER *see* carbon exchange rate  
   CF, *see* chloroplast-coupling factor 1  
   CGR *see* crop growth rate  
   chilling injury  
     cortex, 48  
     membrane integrity, 539  
     metabolic effects, 538-539  
     symptoms, 538  
     radicle tip, 48  
   Chl *see* chlorophyll  
   chlorate, Na, Mg, 149  
   chlordimeform, 139  
   chlorflurenol, 135, 141-142  
   chlormequat *see* cycocel  
   chlorophyll a, 159-161, 163-164  
     absorption maxima, 159  
     CO<sub>2</sub> enrichment and, 204  
   chlorophyll b, 159-160  
   chloroplast, 92-93, 161, 165, 167, 169-178, 203, 229-230, 235-236  
     coupling factor 1, 166  
     enzymes, 174  
     intrachloroplast bodies, 240  
     morphology, 157-159  
     nitrogen site in leaf, 92  
     starch accumulation, 173-174  
   chlorosis  
     CO<sub>2</sub> enrichment and, 204, 208  
   cold tolerance, 6  
   competition  
     boll to boll, 124-125, 294  
     seed to seed, 294  
   condensed tannins, 606-608  
   conditioning, 475, 502-504, 544  
   convolution angle and fiber tenacity, 344  
   crop  
     dry weight accumulation, 189  
     growth rate (CGR), 183-187, 189  
     modelling *see* crop simulation  
   crop simulation, 183, 245-258  
     carbohydrate stress, 252-254  
     nitrogen stress, 256-257  
     water stress, 254-256  
   crop termination  
     early harvest and, 141-142  
     growth terminators, 141-142  
     insect control and, 141-142  
   cortex, 29, 48  
   COTCROP, 183

cotyledon enzymes, 445, 449  
 crowding, 3  
 crystallinity, 55  
 cuticular wax, 620-621  
 cut-out, 18, 21, 57-62, 115, 123-127  
   boll load and, 124  
   environmental stress and, 45  
   factors affecting, 124-127  
   insect shedding and, 124  
   soil type and, 124  
 cyclopropene fatty acids, 619-620  
   relative to nitrogen and water, 104  
   seed improvement, 593  
 cyococel, 134-135, 141  
   fiber quality and, 140-141  
   plant height and, 139-140  
 cyt *see* cytochrome  
 cytochrome f, 161-165  
 cytochrome b, 161-162, 164-165  
 cytokinins, 114, 125-126, 138, 146  
   activity in bolls, 121, 362  
   changes with boll age, 129, 132  
   endosperm and, 280  
   functions, 125  
   role in abscission, 121, 148  
   senescence delay, 121

## D

2,4-D, 135, 141-142, 367  
 damping-off, 546  
 day length, 49  
 DD *see* degree-day units  
 DDT, 138-139  
 DEF, 149  
 defloration, 124, 187-188  
 defoliant, 149  
   physiological action, 149-151  
 defoliation, 143-154  
   as a cultural practice, 143  
   exogenous chemicals, 149-153  
   factors limiting efficiency, 152  
   optimum conditions, 151-152  
   surfactants, 152  
 defruiting, 61, 124-125  
   photosynthesis and, 313  
 degree-day units, 15-16, 27, 54, 185-186  
   methods of calculating, 27  
   summations for crop phases, 27  
 delinting, 495-501  
   acid gas process, 496-497  
   dilute wet-acid process, 497-498  
   disease control, 499  
   flame process, 495-496  
   germination and, 500-501  
   mechanical, 487-488, 495  
   wet-acid process, 497-498

dicamba, 141  
 dictyosome, 390, 415  
   cisternae fibrils, 392, 395  
   fiber primordia, 386-388  
   ovule epidermis, 383-385  
 dieldrin, 138  
 dimethylmorpholinium chloride, 135, 140  
 DMC *see* dimethylmorpholinium chloride  
 dormancy  
   ABA, 514  
   seedcoat impermeability, 515  
 Dropp *see* thidiazuron  
 drought, 68, 74, 97, 103-104  
   avoidance, 103-104  
   resistance, 74, 103  
   senescence, 256  
 dry weight, 66, 68, 101, 189  
   CO<sub>2</sub> enrichment and, 197, 209-214  
   defloration and, 187-188  
   nitrogen and, 101  
   partitioning *see* dry weight  
     partitioning  
     sinks, 188  
 dry weight partitioning, 67, 188-191  
   accumulation phase, 284-285  
   boll, 302  
   enlarging phase, 282  
   mechanisms, 190-191  
   seed, 275-277, 281-283  
 dryland production, 64, 103-104  
 DSF, *see* flower

## E

earliness, 24-25, 48, 79-81  
   boron and, 85  
   nitrogen and, 87, 100  
   phosphorus and, 82  
   potassium and, 83  
   salinity and, 110  
   stratified harvest, 471  
 EC *see* electrical conductivity  
 ecology, 1-7  
   biotic factors, 3  
   climatic cycles, 4  
   coastal habitats, 6  
 electrical conductivity (EC), 108  
   germination correlation, 530  
   membrane integrity, 528  
   planting seed quality, 527-531  
   seed vigor correlation, 528-530  
 elongation (E<sub>0</sub> & E<sub>1</sub>), 356  
   fibril angle relationship, 356  
 embryo  
   culture *see* embryo culture  
   development, 285  
   dry weight gain, 285

- elongation, 283
  - fiber competition, 296-297
  - IAA source, 127
  - temperature and development, 293
  - embryo culture, 444, 623-627
    - ABA, 456-460
    - germination enzymes, 456-460
    - in ovulo*, 626-627
    - isolated embryos, 623-624
    - methods, 456
    - protein inhibitors, 459-460
  - embryogenesis
    - experimental system, 427
    - gene activity, 425-439
    - gene transcript number, 430-432
    - mRNA, 428
    - temporal gene expression, 429
  - emergence, 48
    - function of temperature, 48
    - rate, 48
  - endodermis, 29, 98
  - endoplasmic reticulum, 342, 386, 390-391, 415
  - endosperm, 279-280
    - cellular, 283
    - development, 280
    - free-nuclear, 280
  - endosperm-embryo complex, 280
    - development, 283
  - endothall, 152
  - enlargement phase (boll), 280-284, 466
    - mineral compartmentation, 307
    - phytohormone interactions, 284
    - water stress and, 287
  - enzymes
    - abscission zone, 144
    - chloroplasts, 174
    - compartmentalization, 454
    - germination, 447-455
    - glyoxysomal, 454
    - isolation methods, 443
    - maturing embryos, 447
    - mitochondrial, 454
    - regulators of carbon flow, 235
    - seed maturation, 441-462
  - ET *see* evapotranspiration
  - ethephon, 135, 141-142
  - ethylene, 42-44, 70-71, 114, 117-118, 123, 126-128, 130, 146, 217, 274, 368
    - abscission hormone, 110, 147
    - assimilate transport, 372-373
    - auxin and, 147
    - boll dehiscence, 286
    - boll levels, 362
    - cellulase synthesis, 118
    - CO<sub>2</sub> and, 219, 221
    - flowering and, 115
    - microfibril orientation, 342
    - microtubule orientation, 373
    - O<sub>2</sub> and, 219
    - pectinase synthesis, 118
    - stress and, 42, 219
  - evapotranspiration, 66, 68-69
- F**
- fatty acids
    - free *see* free fatty acids
    - genotype-environment interaction, 577-578
    - oil composition, 562-563, 580
  - Fd *see* ferredoxin
  - feed-back control
    - photosynthesis, 207-209, 214, 227-243
  - ferredoxin, 162-164, 172
  - fertilization, 272-274, 278
    - boll retention, 273
    - events associated, 274
    - in vitro*, 625
  - fiber
    - age vs. assimilation, 317, 319-320
    - bilateral structure, 344
    - cellular morphology, 377-383
    - cellulose synthesis and temperature, 347-348
    - cytoplasm changes, 342
    - dehydration, 344
    - development *see* fiber development
    - differentiation, 278-279, 363-365
    - elbow, 399
    - elongation *see* fiber elongation
    - elongation (E<sub>0</sub> & E<sub>1</sub>) *see* elongation
    - elongation-deposition transition, 336
    - embryo competition, 296-297
    - epidermal cell ratio, 412-413
    - fibril angle, 339
    - fineness, 346
    - foot, 331, 399
    - growth rings, 52
    - index, 285
    - initiation *see* fiber initiation
    - lamellae, 397
    - lateral expansion, 327
    - length *see* fiber length
    - mature structure, 338
    - maturity, 345-346, 353
    - mechanical breakage, 346-347
    - mechanical properties, 356-357
    - microtubules, 342
    - morphogenetic relations, 346-347
    - nitrogen, 352
    - nucleolus *see* nucleolus
    - nucleus, 329, 393
    - number per unit area, 278
    - overlapping phase, 336-339
    - polarity of growth, 327
    - polysomes, 342, 392

- potassium sink, 304-305
- primordial cells *see* fiber primordia
- protein synthesis, 407-408
- quality *see* fiber quality
- reversals *see* reversals
- ribosomes, 342
- RNA synthesis, 279, 406-407
- S<sub>1</sub> layer *see* S<sub>1</sub> layer
- S<sub>2</sub> layers *see* S<sub>2</sub> layers
- secondary wall *see* secondary wall
- shank, 331, 399-401, 412
- spiral growth, 329
- strength, 55, 346, 356-357
- tenacity (T<sub>0</sub> & T<sub>1</sub>) *see* tenacity
- tip ultrastructure, 389-390
- wall composition, 336-337
- weight gain, 317, 319-320
- ultrastructure, 388-402
- fiber development, 325-349
  - boron, 291, 352
  - period, 55
  - phytohormones, 361-373
  - stress influences, 351-359
- fiber elongation, 140, 327-332, 356-357
  - ABA and, 330, 369-371
  - auxin, 369-371
  - dictyosomes, 335
  - GA and, 278, 329-331, 369-371
  - growth curve, 382
  - intercalary addition, 335
  - morphogenetic aspects, 327-329
  - phytohormones, 368-371
  - potassium malate and, 290
  - rate, 330
  - temperature and, 51-52, 291-292, 347
  - ultrastructure, 329
- fiber initiation, 326-327
  - anthesis, 327, 377
  - GA, 364
  - IAA, 364
  - phenolics, 326, 363-364
  - phytohormones, 363-368
  - temperature, 292
  - ultrastructure, 388-393
- fiber length
  - distribution, 344-345
  - loc position, 294-295
  - moisture supply, 354
  - nucleolus size, 367
  - ovule volume, 280-281
  - perimeter relationship, 346
  - temperature, 353
  - variation, 345
  - weight relationship, 295
- fiber primordia, 363, 377-378
  - ultrastructure, 385-388
- fiber quality
  - auxin and, 141
  - environment and, 347-348, 358
  - gibberellin and, 141
  - growth regulators, 355
  - humidity and, 348
  - minerals and, 290-291
  - models, 348-349
  - nitrogen and, 289
  - parameters, 54-55
  - pesticides, 355
  - Phymatotrichum*, 355
  - temperature, 352-353
  - Verticillium*, 355
  - water stress and, 287
- fibril, 329, 338
  - angle, 339
  - dictyosome cisternae, 392, 395
  - orientation, 333
  - primary wall, 332-333
  - secondary wall, 340-341
- filling phase *see* accumulation phase
- flavanols, 605-609
  - adverse effects, 608
  - disease resistance, 608
  - insect resistance, 608-609
  - seed quality and, 608
  - structures, 605
  - tissue levels, 605-607
- flavones, 604-605
- flavonoids, 599-609
- flavonols, 599-604
  - byssinosis, 603
  - cottonseed flour and, 603
  - insect responses, 602
  - structure, 600
  - tissue location, 599, 601, 603
- florigen, 114
- FLOSS, 248
  - fruit loss function of GOSSYM, 250-251
- flower
  - abscission, 41
  - bud development, 262
  - days to first (DSF), 15-16, 24
  - development rate, 14, 16, 22
  - induction, 2
  - initiation, 15, 39-40, 113-115
  - opening, 269
  - structures, 261-262
- flowering, 15-17
  - air pollution and, 40
  - CO<sub>2</sub> enrichment and, 40, 194-195
  - determinant, 123
  - ethylene stimulation, 115
  - G. aridum*, 4
  - gibberellin and, 114
  - horizontal interval (HF1), 16-17, 19, 22, 24-25



- indeterminant, 123
  - inheritance, 40
  - night temperature and, 113-115
  - plant bug, 115
  - rate, 264
  - stress stimulation, 115
  - temperature and, 40, 113-115
  - vegetative growth and, 16
  - vertical interval (VFI), 16-19, 22, 24-25
  - water stress and, 264
  - zinc and, 86
  - fluorescence, 161
  - Folex *see* merphos
  - fraction I protein *see* ribulose-P<sub>2</sub>
    - carboxylase/oxygenase
  - free fatty acids
    - seed density relation, 504
    - seed deterioration, 476
  - fruit abscission, 41, 115-123
    - controlled retention, 62
    - function in GOSSYM, 246, 251
  - fruiting
    - capacity, 59
    - efficiency, 79-81, 100
    - environment and, 43-45
    - first cycle, 60
    - plant height and, 64-66
    - prime sites, 19, 248
  - fruiting branch, 20-21, 39, 51, 102
    - nitrogen stress and, 102
    - node of first (NFB), 15, 24, 26, 40, 50
  - fruiting index, 80-89
    - elements affecting, 81
    - elements not affecting, 81
  - fruiting index and
    - boron, 84-85
    - calcium, 83-84
    - magnesium, 84
    - manganese, 88
    - molybdenum, 88-89
    - nitrogen, 87, 101
    - phosphorus, 82
    - potassium, 83
    - zinc, 85-86
  - fruiting nodes, 19-20, 102
    - nitrogen level and, 102
    - percent yield at, 20
    - physiological limitation, 20
  - FSTRES, 248
    - CHO-N stress function of GOSSYM, 250-251
  - funiculus, 323
    - atrophy, 442-443
    - functional period, 285
  - fuzz fibers, 337
    - development, 283
    - epidermal cell ratio, 413
  - initiation, 380, 383
    - nucleolus, 366
    - pigmentation, 396-397
    - shank, 399-402, 412
    - ultrastructure, 394, 396-397
- G**
- GDD, *see* degree days
  - gene activity
    - coordinate regulation, 432, 438
    - embryogenesis, 425-439
    - multigene families, 438
  - genetic-physiology interaction, 631-637
  - genotype-environment interactions, 633
  - genotypic differences in
    - drought tolerance, 104
    - fiber initiation pattern, 410
    - fiber vs. environment, 355-356
    - gossypol, 561-562, 564
    - nucleolus size, 366
    - oil percent, 560-564
    - pollen heat sensitivity, 268
    - protein percent, 560-562, 564
    - response to gibberellin, 138
    - salinity tolerance, 110
  - germination
    - accelerated ageing, 503
    - chemical aids, 540-541
    - cold test, 503
    - electrical conductivity and, 530
    - environment and, 537-540
    - enzymology, 444-446, 455, 461-462, 536-537
    - dehiscing and, 500-501
    - gene expression, 430
    - genetic modification, 549
    - mechanical seed damage and, 494-495
    - minerals and, 540
    - oxygen requirements, 539
    - precocious, 430, 457
    - rate vs. stand establishment, 546
    - seed density, 503, 532, 534
    - seed hydration, 535-536
    - seed impact and, 493
    - stand establishment *see* stand establishment
    - standard test, 509
    - static loading and, 490, 493
    - storage and, 506-507
    - transient dormancy, 475
  - germination temperature, 537
    - chilling sensitive stages, 537-538
    - fruiting and, 40
    - minimum, 47, 538
  - germplasm utilization, 638
  - gibberellic acid, 114, 126, 146, 274, 280, 284
    - abscisic acid antagonist, 120
    - defoliant aid, 152

functions, 125  
 genotype response to, 138  
 mode of action, 371  
 gibberellic acid and  
   abscission, 120-121, 147-148  
   boll age, 128-129, 131, 362  
   boll retention, 132-133  
   fiber elongation, 278-279, 329-331, 369-371,  
     397  
   fiber initiation, 364  
   fiber quality, 141  
   flowering, 114  
   glyphosate, 141  
   nucleolar size, 368  
   square development, 262  
   tissue culture, 624-625  
 ginning seed damage, 486-488  
 glands, 614  
 glandless seed, 566-570  
 glanded comparisons, 567-570  
 gluconeogenesis, 441  
 glycolate  
   biosynthesis, 176-177  
   oxidation in peroxisomes, 176-177  
 glycolate pathway, 167, 169, 176-178, 232  
   glycine and, 176-178  
   serine and, 176-178  
 glyoxylate cycle, 441-442, 444, 537  
   enzymes, 442, 444-454  
 glyoxysomes, 442, 445  
   biosynthesis, 455  
   enzyme activity, 447, 450  
 golgi apparatus, 335  
 GOSSYM, 183, 248-258  
   FLOSS variable, 248  
   FSTRES variable, 248, 250-251  
   fruit abscission function in, 251  
*Gossypium*, 1-7  
   habitats, 1-4  
   wild species, 1-7  
 gossypol, 617-619  
   biosynthesis, 616  
   environment and, 561-562  
   genotype-environment interaction, 574-575,  
     580-583  
   seed quality improvement, 593  
 grana, 157-160, 163  
 green boll harvesting, 585-586  
 growing degree days (GDD) *see* degree days  
 growth  
   atmospheric parameters, 39-46, 241  
   available soil water and, 13, 97  
   isophases, 17  
   limitation, 13  
   maximum rate, 184-186  
   retardants, 134-135  
   stage, 27

growth regulators  
   crop modification, 131-135, 137-142  
   fiber quality, 355  
   pollen tube growth and, 270-271  
 guard cell  
   abscisic acid, 99  
   ovule epidermis, 379

## H

habitats, 1  
 hard seedcoat  
   hot water treatment, 535  
   seed deterioration, 480  
 Harvade *see* dimethipim  
 harvest index, 67, 80, 313-314  
 harvestable boll, 20  
 heat  
   stress, 57-60  
   units, 54, 185-186, 291, 553  
*Heliothis*, 59  
 hexose monophosphate shunt, 168-169  
 Hill reaction, 237  
 hormones *see* phytohormones  
 hot water treatment, 535  
 hydraulic conductivity, 94-99  
   nitrogen and, 94-99

## I

IAA *see* indole-3-acetic acid  
 IAA oxidase, 118, 326  
 indole-3-acetic acid, 117-118, 126, 146, 270,  
   274, 280, 284  
   boll levels, 362  
   fiber initiation, 364  
 inhibitors  
   cellulose synthesis, 372  
   growth, 134-135  
   protein synthesis, 459-460  
   starch synthesis, 174  
 insect damage, 26  
 insecticides  
   as growth regulators, 138-139  
 integument  
   cell division, 279, 403-405  
   development, 278-280  
   differentiation and potentiation, 278-280  
   starch, 279-280, 466-467  
 internode  
   length and salinity, 109  
 ion toxicity, 108  
 irrigation, 104  
   frequency, 69  
   water salinity, 107

## L

- LAI, *see* leaf area index
- lamellae  
epidermal cells, 399-400  
fuzz fibers, 399
- leaf  
development rate, 14  
differentiation, 13  
expansion and nitrogen, 94-96  
growth rate (LGR), 189  
heliotropic movement, 187  
main stem, 17  
unit number, 16  
water conductance, 238
- leaf area, 13-14, 74  
CO<sub>2</sub> and, 197, 213  
index (LAI), 66-68, 185-187  
leaf perforator (*Bucculatrix*), 59
- leaf-stem ratio  
salinity and, 108
- leaf water potential, 68  
photorespiration and, 237-239  
photosynthetic rate and, 237-239
- legumins, 419-421  
*see* acalin B
- LGR *see* leaf growth rate
- light  
conversion to chemical energy, 229  
interception, 188-189  
photorespiration and, 180  
response curve, 184  
saturation of photosynthesis, 184  
shedding and, 221
- lignin, 598-599
- lint per seed, 294-295
- lipid  
accumulation, 285-286  
bodies, 388-390  
chloroplasts, 240-241  
mobilization, 441  
protection against photoinhibition, 241-242  
vs. starch in chloroplasts, 241
- lipolysis seed deterioration, 479
- locs per boll, 263-264
- lumen, 52
- Lygus, 154
- M
- magnesium,  
activation of ribulose-P<sub>2</sub>-carboxylase,  
170-171  
boll compartmentation, 306-307  
fruiting index, 84  
relative fruitfulness, 84
- main stem nodes *see* nodes, main stem
- malate  
endosperm and, 279, 283  
fibers and, 279, 331  
manganese, 88, 92, 163, 235  
earliness and, 88  
yield and, 88
- MAR *see* multi-adversity resistance
- maturation phase, 286-287, 301, 466  
mineral compartmentation, 307-308
- membrane integrity, 121-122
- mepiquat chloride, 134-135, 140, 142
- 2-mercaptoethanol, 135
- merphos, 149
- mesophyll resistance, 199, 203, 207, 230-232,  
235, 237  
salinity and, 110  
starch accumulation and, 240
- messenger ribonucleic acid, 425-426  
ABA modulated set, 437-438  
abundance groups, 430-432  
developmental changes, 431-432  
developmental regulation, 429  
embryogenesis, 428  
frequency distribution, 431-432  
late embryo abundant, 436-438  
translatable, 428  
translation techniques, 427-428
- MET *see* 2-mercaptoethanol
- methyl parathion, 138-139
- microfibril *see* fibril
- micronaire, 53-55, 355  
fibers per seed and, 295  
moisture supply, 354  
oil correlation, 296  
seed per boll and, 294  
temperature and, 292, 353  
tenacity relationship, 357
- microsporogenesis, 267-269
- microtubules, 342, 392, 395
- middle lamella, 116, 123, 144, 219
- mineral compartmentation, 301, 466  
dynamic relationships, 307-308
- minirhizotron, 32-33
- mitochondria, 165, 441-442  
glycolate pathway and, 177-178  
ovule epidermis, 383-385, 390
- mitosis  
ovule epidermis, 327-328, 377, 380, 386,  
403-405  
thymidine incorporation, 403-405
- modelling crop responses, 245-258
- moisture, seed deterioration, 477
- molybdenum, 88-89  
growth and, 89
- monopodium, 11, 115 (*also see* vegetative  
branches)
- morphological development, 11

motes, 265, 273-274  
 environment and, 273  
 fertilization efficiency and, 273  
 ovary position, 274  
 mRNA *see* messenger ribonucleic acid  
 MSN, *see* nodes, main stem  
 multi-adversity resistance, 549  
 multinet theory, 333

## N

NAA *see* naphthalene acetic acid  
 naphthalene acetic acid, 117, 120, 133-134, 146  
 NAR *see* net assimilation rate  
 net assimilation rate (NAR), 94-95, 207, 211-212, 222  
 NFB, *see* fruiting branch  
 nitrogen,  
 boll compartmentation, 303  
 deficiency, 87  
 transport form, 289  
 water relations, 96-98  
 nitrogen and  
 boll development, 288-289  
 boll retention, 102  
 carbohydrates, 102  
 dry matter partitioning, 94  
 earliness, 100  
 fiber quality, 289, 352  
 fruiting efficiency, 100  
 fruiting nodes, 102  
 growth, 87  
 leaf area, 94-95  
 leaf expansion, 94  
 leaf water potential, 97  
 partitioning, 91  
 planting seed quality, 473  
 seed oil, 288-289  
 seed protein, 288-289  
 shedding, 102  
 termination of flowering, 87  
 tissue sugar levels, 101  
 nitrogen stress, 91-105  
 characteristics affected by, 103  
 characteristics not affected by, 103  
 plant responses, 91  
 syndrome, 91-105  
 water stress similarity, 95-97  
 nitrogen-stress and  
 hydraulic conductivity, 95-98  
 leaf water deficit, 95  
 mesophyll resistance, 93  
 photosynthesis, 91-94  
 ribulose-P<sub>2</sub> carboxylase, 92  
 stomata, 93-94, 96-97  
 transpiration, 93, 256

water uptake rate, 256  
 water use efficiency, 216  
 node  
 first sympodium, 25, 50  
 main stem (MSN), 17, 23, 26, 248  
 simulation of main stem, 247  
 nub-root, 476-477  
 nucleolus, 327, 377-378, 380, 393  
 auxin action, 330  
 diameter vs. age, 330, 365, 381  
 fiber length correlation, 279, 329-331, 365-367  
 genotypic differences, 366  
 phytohormones and, 330-331, 365-368  
 pollination, 366, 368  
 ribosome synthesis, 365-366, 368, 381  
 size vs. ovule position, 366  
 structure, 389-390  
 vacuolation, 365-366, 368  
 nucleus, 393  
 nutrient elements, 79-89  
 fruiting index and, 81-89  
 balance, 79, 81  
 nutritional theory, 41, 43, 69-70, 137-138, 221

## O

oil  
 environment and, 558-560, 562, 565-566  
 fatty acid composition, 562-563  
 genotype-environment interaction, 574, 580-583  
 micronaire correlation, 296  
 nitrogen and, 288-290  
 protein correlation, 296, 469, 559-566  
 seed development and, 467-468  
 water availability and, 287  
 organelle  
 isolation, 444  
 marker enzymes, 446  
 osmoregulation, 68, 255  
 osmotic potential  
 potassium malate in fiber, 352  
 soil water, 108  
 ovary development, 263-266  
 ovule  
 ABA levels, 370-371  
 auxin levels, 369  
 culture *see* ovule culture  
 cytokinin levels, 370  
 development *see* ovule development  
 epidermis *see* ovule epidermis  
 GA levels, 370  
 outer epidermis *see* ovule epidermis  
 ovule culture, 274, 284, 290, 291, 372  
 ammonium, 364  
 fiber studies, 363, 625-626

*in ovulo* embryo culture, 626-627  
interspecific hybridization, 624, 627  
phytohormones, 363, 370  
temperature, 364  
unfertilized, 364  
ovule development, 265-266  
  ammonium and, 290  
  temperature and, 265  
ovule epidermis, 328  
  autoradiographic analyses, 403-410  
  cell number, 379  
  cell wall, 383  
  cellular morphology, 376-383  
  guard cells, 379  
  mature structure, 399-400  
  mitosis, 327, 377, 380  
  preanthesis, 376-377, 383-387  
ovule number  
  nitrogen and, 265  
  potassium and, 265  
  seasonal trend, 265-266  
  temperature and, 265  
oxygen, 41  
  ethylene interaction, 219  
  evolution in photosynthesis, 163  
  low levels, 214  
  photorespiration and, 179  
ozone, 42, 44  
  inhibition of photosynthesis, 42

## P

P-700, 163-165  
  primary donor of PS I, 161  
palisade layer, 283, 285  
PAR *see* photosynthetically active radiation  
paraquat  
  defoliant aid, 152  
partitioning, 77  
  boll age and, 317-319  
  fiber age and, 317, 319-321  
  nitrogen and, 101  
  potassium and, 322  
  sucrose phosphate synthetase and, 209  
PC *see* plastocyanin  
pectinase, 116, 118, 144, 147-148, 219  
penetrometer, 35  
pericycle, 29  
peroxisomes  
  glycolate pathway, 176-178  
pH  
  photorespiration and, 180  
phenolics, 383-385, 597-599  
  fiber initiation, 326, 363  
  fiber primordia, 386-388  
  nonfiber epidermal cells, 380-382  
  phenylalanine, 408  
  phenotypic variance, 634  
phenylalanine  
  ovule epidermis incorporation, 408-410  
  phenolic precursor, 408  
phloem, 29, 34-35  
phosphoenolpyruvate carboxylase pathway  
  CO<sub>2</sub> fixation via, 279  
  fiber expansion and, 279, 331  
phosphorus and  
  boll compartmentation, 303-304  
  earliness, 82  
  fiber length, 290  
  fruiting index, 81-82  
  relative fruitfulness, 81-82  
  starch synthesis, 236  
photoinhibition, 175, 229  
  lipid role, 241  
photoperiod, 39, 50  
  shedding and, 220-221  
  sugar content and, 220  
photophosphorylation, 165-166  
  coupling sites, 165  
  cyclic, 162, 166  
  noncyclic, 161  
photorespiration, 167, 170, 174-180, 232, 240  
  carbon pathway, 176-178  
  CO<sub>2</sub>:O<sub>2</sub> ratio, 233  
  competition with photosynthesis, 179  
  definition, 174  
  factors affecting, 175, 180  
  inhibitors, 235  
  light and, 180  
  oxygen and, 175, 179, 233  
  pH and, 180  
  protection against photoinhibition, 175  
  rates, 179  
  temperature and, 180, 233-234  
photosynthate, 59, 73  
photosynthesis, 41, 176, 197-207, 223  
  biochemical limitations, 180-181  
  biochemistry, 157-182  
  CO<sub>2</sub> and, 180, 197-203, 312, 314  
  CO<sub>2</sub>-nitrogen interaction, 198-199  
  carbon metabolism, 167-180  
  carbon reduction pathway, 167-169  
  carbon reduction-oxidation cycle, 233  
  dark reactions, 159  
  decline during drought, 70  
  deficiency, 25  
  defruiting and, 313  
  electron flow, 161-162  
  electron transport intermediates, 164-165  
  end products, 207-208, 227-228  
  energy processes, 159-166  
  enzyme activation mechanisms, 172  
  feedback control, 203-209, 227-243  
  field vs. environmental chamber plants,

- 201-203
- leaf water potential, 237-239
- light-effect mediators, 172
- light reactions, 159
- light regulated enzymes, 172
- nitrogen-stress and, 91-94, 97
- organ rates, 311
- PAR and, 201-202
- peak time, 311
- photorespiration competition, 179
- pigment systems, 159-160
- pseudocyclic electron transport, 166
- rate, 73-75
- regulation of CO<sub>2</sub> fixation, 169
- salinity and, 110
- starch accumulation and, 173-174, 203-209, 231, 313
- stress and, 227-243
- sugar and, 173, 206
- temperature and, 239-240
- translocation and, 313
- water potential, 76
- water stress and, 313
- yield relationships, 211-212
- Z-scheme of electron flow, 162
- photosynthetically active radiation (PAR), 196, 199, 213, 217, 220-221
- photosynthesis and, 201-202
- photosystem I, 159-162, 164, 166
- composition, 160
- Q, primary electron acceptor, 162-163
- reduction of NADP<sup>+</sup>, 163-164
- spatial orientation, 160-161
- photosystem II, 159-160, 164, 229
- composition, 160
- evolution of oxygen, 162-163
- oxidation of water, 161
- spatial orientation, 160-161
- X, primary electron acceptor, 161-162
- physiology-genetics interaction, 633-639
- phytin, 290
- phytochrome, 114
- phytohormones, 70-71, 113-114
- abscission and, 117-121, 130-131, 146-148
- auxin *see* auxin
- boll levels, 362
- cytokinin *see* cytokinins
- ethylene *see* ethylene
- external application to flowers, 362
- gibberellic acid *see* gibberellic acid
- ovule and fiber culture, 370
- reproduction and, 113-136
- research methods on fibers, 362-363
- secondary wall, 371-372
- theory, 41, 44, 69-70, 138, 221
- water deficits and, 70-71
- pink bollworm (*Pectinophora*), 59
- PIX *see* mepiquat chloride
- plant bugs and flowering, 115
- plant height simulation, 247
- plant water deficit, 67-71
- fruiting and, 71
- stomatal and growth sensitivity, 68
- planting density, 21
- shading effects with high, 221
- planting seed quality, 519-534
- characteristics, 507, 454
- conditioning *see* conditioning
- date of bloom, 469
- density *see* density
- earliness, 471
- electrical conductivity *see* electrical conductivity
- emergence rate, 470
- evaluation, 470-472, 509-515, 525-534
- factors, 483-484, 470, 508
- genetic selection, 472
- germination tests, 509-510
- gin damage, 484
- harvester damage, 484-485
- heat in storage, 505-506
- improvement, 515-517
- mechanical damage *see* seed mechanical damage
- moisture in storage, 504-507
- moisture-temperature relationship, 521
- N fertilization and, 473
- percentage germination, 470
- plant population density, 473
- seasonal distribution, 473
- seedcoat, 484
- seed production, 472-474
- seed quality curve, 543-546
- seed quality index, 470
- stand establishment, 472, 543-550
- stratified harvests, 471-472
- temperature, 470, 473
- tetrazolium test, 526-527
- weight, 531-532
- yield, 471-472
- plasmalemma, 333
- globules, 341
- vesicles, 388-390
- plastids
- outer epidermis, 383-385, 390
- plastochron, 13, 21
- CO<sub>2</sub> enrichment and, 212
- plastocyanin, 162-165
- plastoquinone, 162, 164
- Pn *see* photosynthesis
- pollen, 269-272
- germination *in vitro*, 270-271
- germination media, 270
- growth regulators and, 270-271

sterility, 45, 267-269  
 sterility and temperature, 267  
 storage, 271  
 TD-1123 as chemical sterilant, 140  
 tube growth, 270-272  
 pollination, 272  
 pollution tolerance, 44  
 polysomes in fibers, 392  
 potassium, 83, 217  
   boll compartmentation, 304-305  
   malate and osmotic potential, 290, 352  
 potassium and,  
   earliness, 83  
   fruiting index, 83  
   relative fruitfulness, 83  
   seed weight, 290  
 PQ *see* plastoquinone  
 precipitation  
   seasonal distribution, 2-3  
 Pressley Index *see* tenacity  
 primary wall, 332-336  
   Albersheim model, 333, 335  
   chemical composition, 332  
   extension, 333-336  
   microfibrils, 332-333  
   synthesis, 334-335  
 prophyll, 16-17  
 protein  
   accumulation, 285  
   nitrogen fertilization and, 288-290  
   oil correlation, 296  
   ovule epidermis synthesis, 407-408  
   storage *see* storage proteins

## Q

Q, primary acceptor of photosystem I, 161-164  
 quantum

## R

R<sub>A</sub> *see* relative leaf growth rate  
 relative fruitfulness, 80-89  
   elements affecting, 81  
   elements not affecting, 81  
 relative fruitfulness and  
   boron, 85  
   calcium, 83-84  
   magnesium, 84  
   nitrogen, 87, 99-100  
   phosphorus, 82  
   potassium, 83  
 relative growth rate (RGR), 211-212  
 relative humidity, 44-45

  defoliant and, 152  
 relative leaf growth rate (R<sub>A</sub>), 94-95  
 relative water content, 237  
 respiration, 41  
   growth rates, 184, 186  
   maintenance rates, 184, 186  
 reversals, 338, 340, 348  
   fiber strength and, 341-342  
 RF *see* relative fruitfulness  
 RGR *see* relative growth rate  
 rhizobotoxin, 43  
 RHIZOS, 248  
 rhizotron, 31, 33  
 ribosomes, 342  
   elongating fiber, 392  
   fiber primordial, 386-387  
   maturing fiber, 392  
 ribulose-P<sub>2</sub> carboxylase/oxygenase, 158,  
   169-172, 176, 179-180, 211, 232, 238  
   activation, 170-171  
   carboxylation:oxygenation ratio, 233  
   effectors, 232  
   mechanisms of activation, 171  
   photosynthesis limited by, 181  
   structure, 169-170  
   substrate kinetics, 170  
 root  
   anatomy, 29-31  
   carbohydrate content, 38  
   density, 34  
   development, 33-34  
   distribution, 33  
   elongation rate, 33  
   epidermis, 29, 98  
   lateral, 29, 33-34  
   length, 32-33  
   length density, 32-33, 37  
   penetration, 35  
   primary, 29-30, 33  
   primordia, 29  
   secondary, 29  
 root growth, 13-14, 29-38  
   high strength soils and, 35-36  
   hormone balance and, 126  
   methods for measuring, 31-33  
   soil water and, 37  
   temperature and, 35  
 root/leaf ratio, 34  
   nitrogen stress and, 96  
 root-shoot relationships, 37-38  
 Roundup *see* glyphosate  
 row  
   orientation, 187  
 RuBPCase *see* ribulose-P<sub>2</sub>  
   carboxylase/oxygenase  
 RWC *see* relative water content

## S

- S<sub>1</sub> layer, 337-338, 342  
 S<sub>2</sub> layers, 338-339  
 salinity, 107-111
  - genotypic differences in tolerance, 109
  - irrigation water, 107
  - plant response, 108
  - salts contributing to, 107
  - seedling emergence, 554
  - tolerance, 6, 108-109
  - tolerance classification, 108
  - yield-decline threshold, 108
 salinity effects on
  - growth, 109
  - internode length, 109
  - leaf:stem ratio, 108
  - photosynthesis, 110
  - physiological functions, 110
  - transpiration, 110
  - water use efficiency, 110
  - yield, 109-110
 S/B *see* seeds per boll  
 secondary products, 597-618  
 secondary wall
  - abscisic acid, 371-372
  - auxin, 371-372
  - beta-1,3-glucan, 343
  - chemical composition, 340-341
  - formation, 341-342
  - growth rings, 339-340
  - microfibrils, 340
  - physical composition, 339-340
  - phytohormones and, 371-373
  - plasmalemma globules, 341
  - thickening, 52-54, 140
  - UDPG-glucose glucan synthetase, 343
  - ultrastructure, 392-402
 seed
  - ABA and hardness, 286, 514
  - competition, 294
  - conditioning *see* conditioning
  - density *see* seed density
  - deterioration *see* seed deterioration
  - development *see* seed development
  - dry weight distribution, 275-277
  - feeding quality *see* seed feeding quality
  - fiber number, 410
  - germination enzymes, 461-462
  - hydration, 535-536
  - longevity, 521
  - maturation and amino acids, 585
  - maturation enzymes, 441-462
  - maturation oil synthesis, 585-586
  - mechanical damage *see* seed mechanical damage
  - parameters and environment, 294
  - phosphorus sink, 304
  - planting quality *see* planting seed quality
  - set, 272-274
  - setting efficiency, 273-274
  - storage *see* seed storage
  - surface area, 296, 410-411
  - surface cell number, 410
  - surface morphology, 410-413
  - viability *see* seed viability
  - volume, 296
  - water impermeability and hardness, 286
  - weathering *see* seed deterioration
  - weight and potassium, 290
 seed density
  - germination and, 502-503, 532, 534
  - seedling performance and, 532, 534
  - separation methods, 533
 seed deterioration 475-481
  - avoidance, 480
  - biological processes, 477-480
  - boll rot, 478
  - environmental factors, 477
  - field fungi, 478
  - free fatty acids, 476
  - hard loc, 478
  - hard seed coat, 480
  - indeterminant fruiting, 477
  - lipolysis, 476, 479
  - microorganisms, 477-479
  - moisture, 477
  - nub-root, 476-477
  - pinched root tip, 476
  - resistance, 480
  - secondary products, 479-480
  - seed changes, 476-477
  - specific gravity, 476
  - storage fungi, 478
  - tight loc, 478
  - toxins, 479
 seed development, 466-468
  - amino acids, 468
  - date of bloom, 469
  - integument starch, 466-467
  - oil, 467-468
  - phases, 466
  - storage protein, 468
  - sugars, 467
 seed feeding quality, 557-595
  - environment-genotype interaction, 572-583
  - factors affecting value, 571
  - genetic resources, 590
  - improvement approaches, 589-590
  - improvement goals, 592-595
  - module storage, 584
  - pink bollworm contamination, 583
  - quality factor-environment, 572-583
  - quality factor-genotype, 572-583



- seed index, 285
  - environment and, 565-566
  - water stress and, 287
- seed mechanical damage
  - acid delinting, 494
  - cold test emergence, 494-495
  - delinting, 487-488
  - germination percentage, 488, 494-495
  - gin, 484, 486-489
  - ginning rate and, 487
  - handling and conveying, 489
  - harvester, 484-486
  - impact, 491-492
  - microorganisms, 493-494
  - moisture and, 487, 490-492
  - radicle, 491-493
  - seedcoat, 484
  - static loading, 490
- seed planting quality *see* planting seed quality
- seed quality curve, 543-546
  - field performance correlations, 547
- seed storage, 520-525
  - drying and aeration, 524-525
  - field, 524
  - heat, 505
  - moisture, 504-507, 520
  - trailer, 524
  - trash moisture, 522-523
- seed viability
  - electrical conductivity, 510
  - free fatty acid content, 511
  - tetrazolium test, 510
- seed vigor, 511-514
  - cold germination tests, 513
  - cool germination test, 513
  - electrical conductivity, 513
  - field emergence, 512
  - productivity, 512
  - tetrazolium test, 513
- seedcoat, 286
  - energy to rupture, 489
  - mechanical properties, 489-493
  - ultrastructure, 394
- seedling emergence
  - crusting, 553-554
  - oxygen, 554
  - salinity, 554
  - soil parameters, 551
  - stand yield potential, 551-552
- seeds per ball, 265, 294-295
  - micronaire and, 294
- senescence, 43-45, 98, 121-123, 138, 256
  - CO<sub>2</sub> enrichment and, 218-222
  - cytokinin and, 125
  - induced, 144
  - precedent to abscission, 144
- senescence factor, 122, 146, 148
- sesquiterpenoids, 611-612
  - byssinosis, 612
  - pest resistance, 612
  - stress response, 612
  - structure, 612
- SF *see* senescence factor
- SGR *see* stem growth rate
- shade tolerance, 6
- shading, 3, 26
  - fiber quality and, 354-355
  - shedding response to, 220
- shedding
  - delay by flower removal, 124
  - environmental factors and, 220
  - hormonal factors and, 220
  - light effects and, 221
  - nitrogen and, 102
  - shading and, 220
- short season cotton, 104
- side-by-side (opposite) sympodia, 25
- sieve tubes, 31
- simulation of
  - boll number with age, 249
  - crop responses, 245-258
  - fruit abscission, 246
  - fruit abscission function, 251
  - fruiting sites, 247
  - main stem nodes, 247
  - plant height, 247
  - square number with age, 249
- sink strength, 124, 314-321
  - metabolic demand and, 315
- sodium substitution for K, 83
- soil
  - aeration, 36
  - carbon dioxide, 36
  - osmotic water potential, 108
  - oxygen, 36
  - resistance, 35
  - strength, 35
  - temperature, 34-35
  - type, 3
  - water, 36, 63, 65, 67-68
  - water deficit, 237
- source-sink relations, 73-77, 228, 236, 241, 246
  - basis of simulation model, 251
  - efflux-influx, 322
  - proximity, 317, 322
  - sink response to water stress, 76-77
  - source response to water stress, 74-76
- species, 1
  - geographic locations, 5
  - xeromorphic adaptations, 5
- specific gravity
  - seed deterioration, 477
- sperm cells, 274

- square, 11, 21, 248  
   abscission, 115  
   abscission and temperature, 263  
   abscission and water stress, 262-263  
   development, 261-262  
   development and temperature, 263  
   period, 19, 261-272  
   period and environment, 262-263  
   production vs. plant height, 64-65  
   production vs. vegetative growth, 64  
   second axillary, 24-25  
   shedding, 26, 80  
   time to first, 25  
 stag plants, 26  
 stamen development, 267-269  
   environment and, 267  
 stand establishment, 535-541  
   field environment, 551-554  
   planting date, 553  
   planting depth, 552  
   planting seed quality, 472, 543-550  
   post-planting factors, 552-554  
   soil crusting, 553-554  
 starch, 173-174  
   biosynthesis, 173-174  
   CER and, 313-314  
   CO<sub>2</sub> compensation point and, 231  
   correlation with photosynthetic rate, 204-209  
   degradation vs. leaf age, 322  
   inhibitors of biosynthesis, 174  
   integumental, 279-280, 466-467  
   mobilization at night, 174  
   phosphorus effects on synthesis, 236  
   photosynthesis and, 173, 229, 231  
   seed, 466-467  
 starch accumulation, 228  
   CO<sub>2</sub> enrichment and, 203-205  
   CER and, 187  
   mesophyll resistance and, 240  
   nitrogen-stress and, 92  
 stele, 29, 34, 98  
 stem growth rate, 189  
 stomata,  
   factors controlling behavior, 246  
   ovular, 279, 328  
   sensitivity to CO<sub>2</sub>, 93-94  
   sensitivity to water stress, 96-97, 99  
 stomatal conductance, 70, 97, 230, 237  
   CO<sub>2</sub> enrichment and, 214-218  
   relation to CER, 230  
 stomatal resistance, 110, 181, 199, 203, 207,  
   230, 232, 235  
   leaf age effects, 217  
 storage protein, 415-422  
   acalin A *see* acalin A  
   acalin B *see* acalin B  
   amino acid composition, 433, 570, 579  
   cDNA clones, 434-435  
   coordinate regulation, 434  
   genotype-environment interaction, 574-575,  
     580-583  
   *in vitro* translation, 433-434  
   model requirements, 422  
   mRNAs, 433-436  
   oil correlation, 296, 559-566  
   processing scheme, 434-435  
   regulatory sequences, 436  
   seed development and, 468  
   transcript families, 435  
   wild species, 587-589  
 stratified harvests, 471  
 stress  
   carbohydrate, 252-254  
   photosynthesis response, 236-242  
   stimulation of flowering, 115  
   unified theory, 252  
 stroma, 157-160, 172  
 sucrose  
   photosynthesis and, 173  
 sugar  
   levels in developing bolls, 44  
   nitrogen and, 101  
   seed development, 467  
   translocation vs. starch degradation, 322  
 sulfur, 88  
   relative fruitfulness and, 88  
 sunlight, 3  
 supply/demand ratio *see* source-sink ratio  
 sympodium, 11, 18-19, 21, 26, 115  
   initiation, 13  
   reversion to monopodium, 115-116  
 synergids, 274
- T**
- T<sub>0</sub> *see* tenacity gauge  
 T<sub>1</sub> *see* tenacity gauge  
 taproot, 34  
 TD-1123, 140-142  
   chemical male sterility, 140  
   defoliant aid, 152-153  
 temperature  
   adverse high, 57-60  
   cold tolerance, 6  
   day-night regimes, 49-50  
   extremes, 2  
   fluctuations, 2  
   maximum, 2  
   minimum, 2  
   minimum for germination, 47  
   soil, 34-35  
   species adaptation, 2  
 temperature and  
   boll development, 291-293  
   boll maturation period, 54, 291-293, 352-353

- boll retention, 45  
 CO<sub>2</sub> compensation point, 235, 240  
 CO<sub>2</sub>-O<sub>2</sub> solubility ratio, 233, 240  
 cellulose synthesis, 297  
 embryo development, 293  
 flowering, 40, 49-50  
 fiber elongation, 291-292  
 fiber initiation, 292  
 fiber length, 55  
 fiber quality, 352-354  
 fruiting index, 86  
 germination, 47  
 micronaire, 292  
 ovules per ovary, 265-266  
 photorespiration, 180, 233-234  
 photosynthesis, 41, 239-240  
 planting seed quality, 473  
 pollen sterility, 267-269  
 square abscission, 263  
 squaring, 49  
 VFI, 18
- tenacity, 55, 356  
   convolution angle and, 347  
   environment and, 356-357  
   guage, 357  
   micronaire and, 357  
   secondary wall thickness, 356-357
- terpenes, 609-611  
   volatile *see* volatile terpenes
- terpenoid aldehydes, 614-619  
   biological activities, 616-617  
   byssinosis, 618  
   defense response, 614  
   gossypol biosynthesis, 616  
   structures, 615-616  
   tissue location, 614
- terpenoids  
   sesquiterpenes *see* sesquiterpenes
- thidiazuron, 141, 149
- thioredoxin, 172
- thylakoid, 157-161, 163, 165-166, 172, 229
- thymidine  
   epidermal incorporation, 403-406  
   incorporation vs. age, 405
- TIBA *see* 2,3,5-triiodobenzoic acid
- tight loc, 478
- tissue culture, 625-631  
   anther and microspore, 629  
   callus, 627-628  
   ovule, 624-627  
   protoplasts, 630  
   regeneration of plantlets, 630-631  
   suspension cells, 628-629
- toxaphene, 138-139
- translocation, 76, 228  
   photosynthesis and, 313  
   water potential and, 76
- transpiration, 68, 93, 110, 246  
   CO<sub>2</sub> enrichment and, 214-218  
   N-stress and, 93  
   salinity and, 110
- 2,3,5-triiodobenzoic acid, 132, 140
- tryptophan, 126
- two-stage theory, 146-147
- U**
- UDP-glucose glucan synthetase, 343
- uridine  
   fiber incorporation, 405-407
- V**
- vacuoles  
   electron dense pigment, 384  
   elongating fiber, 377-380  
   ovule epidermis, 383-385  
   storage protein, 415
- vascular bundle, 29-30, 34
- vegetative branches, 21, 51
- vegetative growth, 13, 26  
   CO<sub>2</sub> enrichment and, 194-195  
   water status and, 64
- vegetative-fruitlet ratio, 26-27, 63, 81-86  
   nutrient elements affecting, 81-86
- vesicles  
   dictyosome, 390, 392  
   plasmamembrane-associated, 388-390
- vicilins, 419, 421  
   *see* acalin A
- vivipary, 439, 448, 457, 460
- volatile terpenes, 609-611  
   boll weevil attractants, 611  
   structures, 610  
   tissue concentrations, 610
- W**
- water  
   deficit, 63  
   potential, 74-75  
   stress, 15, 74-75, 217, 222-223, 237-239
- water stress and  
   assimilation, 74  
   carbohydrate utilization, 222-223  
   CER, 313  
   fiber quality, 287  
   flowering, 264  
   photosynthesis, 237-239  
   seed index, 287  
   source-sink activity, 75  
   square abscission, 262-263  
   stomatal response, 217  
   translocation, 74-75

- yield, 222-223
- water-use-efficiency, 67, 110
  - CO<sub>2</sub> enrichment and, 215-218
  - nitrogen and, 216
  - salinity and, 110
- wild species, 1
  - storage protein, 587-589
- winding layer *see* S<sub>1</sub> layer

### X

- X, primary acceptor of photosystem II,  
161-162, 164-165
- xanthophylls, 160
- xylem, 29, 35, 98-99

### Y

- yield
  - CO<sub>2</sub> enrichment and, 195-196, 210
  - components, 210, 245
  - photosynthesis relationship, 211
  - theoretical maximum, 184-186
  - water stress and, 222-223

### Z

- Z, primary electron donor, 163
- zinc
  - flowering and, 86
  - fruiting index and, 85
  - partitioning and, 86
  - tryptophan synthesis and, 86
  - yield and, 85