

**TAXONOMIC STUDIES OF NORTH AFRICAN
CARYOPHYLLACEAE WITH SPECIAL
REFERENCE TO THE FLORA OF
LIBYA**

**BY
MOHAMED NURI ABUHADRA**

**THESIS PRESENTED FOR THE DEGREE
OF DOCTOR OF PHILOSOPHY
UNIVERSITY OF GLASGOW**

1996

ProQuest Number: 11007819

All rights reserved

INFORMATION TO ALL USERS

The quality of this reproduction is dependent upon the quality of the copy submitted.

In the unlikely event that the author did not send a complete manuscript and there are missing pages, these will be noted. Also, if material had to be removed, a note will indicate the deletion.



ProQuest 11007819

Published by ProQuest LLC (2018). Copyright of the Dissertation is held by the Author.

All rights reserved.

This work is protected against unauthorized copying under Title 17, United States Code
Microform Edition © ProQuest LLC.

ProQuest LLC.
789 East Eisenhower Parkway
P.O. Box 1346
Ann Arbor, MI 48106 – 1346

Thesis
10665
Copy 1

GLASGOW
UNIVERSITY
LIBRARY

ABSTRACT

The thesis deals with the Caryophyllaceae, a family well represented in the countries of North Africa including Libya which has about 22 genera and 80 species within the three subfamilies as currently recognised. The principal part of the thesis concerns the description of the seeds of the Libyan species primarily with the use of scanning electron microscope (SEM). SEM produces very revealing images of the testa cells and their often striking ornamentation. These seed characters as well as seed colour, shape and size, hilum position and radicle shape have been applied to particular problems at several taxonomic levels up to that of the subfamilies, the limits of which have long been controversial. Within the Caryophyllaceae, whatever its scope, seed characters have always been given importance but that importance is often under-rated.

A survey of the calcium oxalate crystals in the genera *Arenaria*, *Minuartia* and *Moehringia* has been undertaken to an extent and in a detail not previously carried out within any large genus of the family. The size, type and distribution of the foliar crystals has taxonomic significance particularly at the sectional and series. There are especially large crystals in *Minuartia* subgenus *Minuartia* which appear to be of taxonomic importance.

The micromorphology of the capsular walls of *Silene* and a few other genera has been investigated and has taxonomic importance but the results are not discussed in detail. Presented as appendices, there are keys for the identification of the seeds of Libyan Caryophyllaceae, for fruiting material of Libyan *Silene* as well as for the infrageneric taxa of *Arenaria*, *Minuartia* and *Moehringia* based on crystals.

CONTENTS

ACKNOWLEDGEMENTS	
LIST OF FIGURES	
LIST OF PLATES	
LIST OF TABLES	
CHAPTER 1. GENERAL INTRODUCTION	13
CHAPTER 2. MATERIALS AND METHODS	20
2.1 PLANT MATERIAL	20
2.2 SEEDS	20
2.3 CRYSTALS	21
2.4 CAPSULES	22
CHAPTER 3. SEEDS	
3.1 INTRODUCTION	24
3.1.1 HISTORY OF THE USE OF SEED	
MORPHOLOGY	24
3.1.2 SCANNING REFLECTION ELECTRON	
MICROSCOPY (SEM) AND SEED	
MORPHOLOGY	28
3.2 SEED MORPHOLOGY OF THE LIBYAN	
SPECIES	29
3.2.1 LAYOUT	29
3.2.2 GLOSSARY	32
3.2.3 DESCRIPTIONS	33
3.3 DISCUSSION	94
CHAPTER 4. CRYSTALS	
4.1 INTRODUCTION.	154
4.2 MORPHOLOGY AND DISTRIBUTION OF FOLIAR	

CRYSTALS IN THE GENERA <i>ARENARIA</i>,	
<i>MOHERINGIA</i> AND <i>MINUARTIA</i>	157
4.3 DISCUSSION	181
CHAPTER 5. CAPSULES AND NUTLETS	
5.1 INTRODUCTION	198
5.2 <i>SILENE</i>	198
5.3 OTHER GENERA	202
CHAPTER 6. GENERAL DISCUSSION AND	
CONCLUSIONS	215
6.1 CHAPTER 2 METHODS	215
6.2 CHAPTER 3	215
6.2.1 TESTA MICROMORPHOLOGY: SPECIES AND	
 INFRASPECIFIC TAXA	215
6.2.2 SEED SHAPE AND TESTA MICROMORPHOLOGY	
 GENERA/SUBGENERA	217
6.2.3 SEED SHAPE AND TESTA MICROMORPHOLOGY:	
 <i>TELEPHIUM</i>	218
6.2.4 SEED SHAPE: THE DORSIVENTRAL GENERA	219
6.2.5 SEED CHARACTERS: THE TRIBES	220
6.2.6 SEED SHAPES AND TESTA MICROMORPHOLOGY:	
 SUBFAMILIES AND ILLECEBRACEAE	225
6.3 CHAPTER 4	232
6.4 CHAPTER 5	234
6.5 SOME GENERAL CONCLUDING POINTS.	235
REFERENCES	237
APPENDIX I. LIST OF SPECIES WITH AUTHORITIES	252
APPENDIX II. LIST OF STUDIED SPECIMENS	258

APPENDIX III. AN ARTIFICIAL KEY TO THE LIBYAN SPECIES BASED ON SEED CHARACTERS	271
APPENDIX IV. AN ARTIFICIAL KEY TO THE LIBYAN SPECIES OF <i>SILENE</i> USING FRUITING PLANTS	281
APPENDIX V. AN ARTIFICIAL KEY FOR THE IDENTIFICATION OF THE SUBGENERA, SECTIONS AND SERIES OF THE GENERA <i>ARENARIA</i>, <i>MOEHRINGIA</i> AND <i>MINUARTIA</i> USING CRYSTALS	283

LIST OF FIGURES

	page
Fig 1. Typical seed measurements.	120
Fig 2. Range of outline shapes in the subfamilies.	121
Fig 2A. Subfamily Paronychioideae.	”
Fig 2B. Subfamily Alsinoideae.	”
Fig 2C. Subfamily Caryophylloideae.	”
Fig 3. Range of radicle outlines in the subfamilies.	122
Fig 3A. Subfamily Paronychioideae.	”
Fig 3B. Subfamily Alsinoideae.	”
Fig 3C. Subfamily Caryophllyoideae.	”
Fig 4. Shapes and distribution of calcium oxalate in mature leaves of <i>Arenaria</i> , <i>Minuartia</i> and <i>Moehringia</i> .	191

LIST OF PLATES

The plates from no. 1 to 31 are SEMs of the seeds showing details of the testa ornamentation located near the midzone of the lateral face, the marginal face, the radicle and the hilar notch as following.

1. <i>Spergula fallax</i> (1,2,3), <i>Spergularia bocconii</i> (4,5,6), <i>Spergularia diandra</i> (7,8,9).	123
2. <i>Spergularia maritima</i> (1,2,3), <i>Spergularia rubra</i> (4,5), <i>Spergularia salina</i> (6,7,8).	124
3. <i>Spergularia salina</i> (1,2), <i>Polycarpaea carnosae</i> (3,4,5,6), <i>Polycarpaea divaricata</i> (7,8).	125
4. <i>Polycarpaea divaricata</i> (1), <i>Polycarpaea repens</i> (2,3,4,5,6), <i>Polycarpaea robbarieae</i> (7,8).	126

5. *Polycarpaea smithii* (1,2,3,4), *Polycarpaea tenuis* (5,6,7,8). 127
6. *Polycarpon prostratum* (1,2), *Polycarpon tetraphyllum* (3,4), *Loeflingia hispanica* (5,6,7,8). 128
7. *Pteranthus dichotomus* (1,2), *Sclerocephalus arabicus* (3,4,5), *Gymnocarpos decander* (6,7,8). 129
8. *Paronychia arabica* (1,2,3), *Paronychia argentea* (4,5,6), *Paronychia capitata* (7,8). 130
9. *Paronychia capitata* (1), *Paronychia chlorothyrsa* (2,3,4,5), *Paronychia kapela* (6,7,8). 131
10. *Herniaria cinerea* (1,2), *Herniaria cyrenaica* (3,4), *Herniaria ericifolia* (5,6,7,8). 132
11. *Herniaria fontanesii* (1,2,3), *Herniaria glabra* (4,5,6,7), *Herniaria hemistemon* (8). 133
12. *Herniaria hemistemon* (1,2), *Telephium sphaerospermum* (3,4,5), *Arenaria serpyllifolia* (6,7,8). 134
13. *Arenaria serpyllifolia* (1,2,3,4), *Arenaria leptoclados* (5,6), *Arenaria leptoclados* Davis 50344 (7,8,9). 135
14. *Cerastium dichotomum* (1,2), *Cerastium glomeratum* (3,4), *Cerastium comatum* (5,6), *Cerastium ligusticum* (7,8). 136
15. *Cerastium pumilum* (1,2), *Cerastium semidecandrum* (3,4), *Cerastium siculum* (5,6), *Stellaria media* (7,8,9). 137
16. *Stellaria media* subsp. *cupanina* (1,2,3,4), *Stellaria media* (5,6,7,8). 138
17. *Stellaria pallida* (1,2,3,4), *Minuartia campestris* (5,6), *Minuartia geniculata* (7,8). 139
18. *Minuartia geniculata* (1,2,3,4,5,6,7,8,9). 140
19. *Minuartia geniculata* (1,2), *Minuartia hybrida* (3,4)

- Minuartia mediterranea* (5,6,7), *Minuartia montana*. (8,9). 141
20. *Sagina apetala* (1,2,3,4), *Sagina maritima* (5,6) , *Gypsophila elegans* (7,8). 142
21. *Gypsophila pilosa* (1,2,3,4,5), *Vaccaria pyramidata* (6,7,8). 143
22. *Vaccaria pyramidata* (1,2), *Dianthus crinitus* (3,4,5,6,7,8). 144
23. *Petrorhagia illyrica* (1,2), *Petrorhagia velutina* (3,4,5,6) *Silene apetala* morphotype A (7,8). 145
24. *Silene apetala* morphotype B (1,2,3), *Silene apetala* morphotype C (4,5,6), *Silene articulata* (7,8). 146
25. *Silene articulata* (1), *Silene behen* (2,3), *Silene cerastoides* (4,5) *Silene colorata* subsp. *colorata* (6,7,8). 147
26. *Silene colorata* subsp. *lasiocalyx* (1,2) *Silene conoidea* (3,4), *Silene cyrenaica* (5,6,7) , *Silene fruticosa*.(8). 148
27. *Silene fruticosa* (1,2), *Silene fuscata* (3,4), *Silene gallica* (5,6), *Silene italica* (7,8). 149
28. *Silene longipetala* (1,2,3,4), *Silene marmarica* (5,6,7), *Silene muscipula* (8). 150
29. *Silene muscipula* (1), *Silene nocturna* (2,3,4), *Silene rubella* (5,6), *Silene sedoides* (7,8). 151
30. *Silene sedoides* (1,2,3) *Silene succulenta* (4,5), *Silene tridentata* (6,7), *Silene villosa* (8). 152
31. *Silene villosa* (1,2), *Silene vivianii* (3,4) *Silene vulgaris* (5,6), *Agrostemma githago* (7,8). 153

The plates from no. 32 to 37 are photomicrographs and SEMs of crystals in tissues of mature leaves.

32. *Moehringia stellarioides* (1), *Arenaria alsinoides* (2,3), *A. cucabaloides* (4), *A. grandiflora* (5,6), *A. montana* (7,8). 192

33. *Arenaria kingii* (1,2), *A. paludicola* (3,4,5), *A. pungens* (6), *Minuartia rimarum* (7), *M. bulgarica* (8). 193
34. *Minuartia campestris* (1,2), *M. geniculata* (3), *M. globulosa* (4), *M. hybrida* (5,6), *M. mediterranea* (7,8). 194
35. *Minuartia mesogitana* (1), *M. hamata* (2), *M. montana* (3), *M. saxifraga* (4), *M. stricta* (5), *M. dichotoma* (6), *M. douglasii* (7), *M. pestalozzae* (8). 195
36. *Arenaria alsinoides* (1), *Moehringia trinervia* (2), *Arenaria steveniana* (3,4), *Minuartia cerastifolia* (5), *M. bulgarica* (6,7,8). 196
37. *Minuartia mediterranea* (1), *M. tenella* (2), *M. mediterranea* (3,4), *M. montana* (5,6). 197

The plates from no. 38 to 44 are SEMs of capsule wall (midzone) and LMs of impressions of capsule wall of *Silene*.

38. *Silene acaulis* (1,2), *S. fruticosa* (3), *S. nicaeensis* (4), *S. succulenta* (5), *S. villosa* (6), *S. armeria* (7), *S. atlantica* (8). 204
39. *Silene dioica* (1,2), *S. alba* (3), *S. dioica* (4), *S. nutans* (5,6), *S. noctiflora* (7), *S. nutans* (8). 205
40. *S. conoidea* (1,2), *S. colorata* (3,4), *S. apetala* (5), *S. colorata* (6), *S. cyrenaica* (7), *S. rubella* (8). 206
41. *S. longicaulis* (1,2,3), *S. neglecta* (4), *S. longipetala* (5,6,7), *S. calaryi* (8). 207
42. *S. italica* (1,2), *S. boryi* (3), *S. italica* (4), *S. mollissima* (5), *S. protensis* (6), *S. pomelii* (7,8). 208
43. *S. tridentata* (1,2,3), *S. gallica* (4), *S. cerastoides* (5), *S. conica* (6,7,8). 209
44. *S. colirosa* (1,2,3,4), *S. laeta* (5,6,7), *Lychnis flos-cuculi* (8) 210

The plates no 45 and 46 are LMs of capsule walls showing cell shape and ornamentation in the midzone areas of *Polycarpon*, *Polycarpaea*, *Spergula* and *Spergularia* .

45. *Polycarpon arabicum* (1), *P. bivonae* (2), *P. depressum* (3),
P. eploides (4), *P. polycarpoides* (5), *P. tetraphyllum* (6),
Polycarpaea repens (7), *P. robbairea* (8) 211
46. *Spergula arvensis* (1), *S. fallax* (2), *S. morisonii* (3),
S. pentandra (4), *S. viscosa* (5), *Spergularia salina* (6), *S. maritima*
(7), *S. rubra* (8). 212

The plates no. 47 and 48 are SEMs of capsule wall showing surface ornamentation of *Arenaria*, *Paronychia* and *Herniaria*

47. *Arenaria serpyllifolia* (1), *A. leptoclados* (2), *Paronychia arabica* (3), *P. argentea* (4), *P. capitata* (5), *P. chlorothyrsa* (6), *P. kapela* (7,8). 213
48. *Herniaria cinera* (1), *H. cyrenaica* (2), *H. glabra* (3,4), *H. fontanesii*
(5,6), *H. hemistemon* (7,8). 214

LIST OF TABLES

	page
Table 1. Classification of Caryophyllaceae in different Floras.	18
Table 2. Number of genera and species of Caryophyllaceae family in North Africa.	19
Table 3. Measurements of British in (GL) and Mediterranean specimens of <i>Arenaria leptoclados</i> .	98
Table 4. Measurements of British in (GL) and North African specimens of <i>Arenaria serpyllifolia</i>	99
Table 5. Comparison between <i>Polycarpaea</i> , <i>Polycarpon</i> and <i>Robbairea</i> seeds.	109

- Table 6.** Seed characteristics of the subfamily Alsinoideae (genera found in Libya). 228
- Table 7.** Seed characteristics of the subfamily Paronychioideae (genera found in Libya). 229
- Table 8.** Seed characteristics of the subfamily Paronychioideae (genera found in Libya). 230
- Table 9.** Seed characteristics of the subfamily Caryophylloideae (genera found in Libya). 231

ACKNOWLEDGEMENTS

I am indebted to the Nasser University and Ministry of Higher Education for financial support.

I wish to thank my supervisor, Dr. J. Dickson for his advice, help and encouragement throughout the period of research.

I am grateful to the Department of Botany, Glasgow University for allowing me to carry out this work and to the Regius Keeper, Curator and staff of the Royal Botanic Gardens, Edinburgh, for allowing me to work in the herbarium during this study. Dr. R. R. Mill, Prof. J. Morton of the University of Waterloo Canada and Dr. D. Hind of Kew made helpful comments and advice. I would like to thank all members of the Botany Department, also P. Ainsworth in the electron microscopy laboratory and photographer D. Maclean in the Geology Department who have helped me.

I wish to thank my colleague M. Magrabi in the Tripoli National Herbarium for helping me to obtain recent collections of plants and seeds from Libya material.

I would also like thank my parents, my wife and my children for their support through some very difficult periods.

Chapter 1

General Introduction

The title of this thesis is taxonomic studies of North African Caryophyllaceae with particular reference to the flora of Libya. The thesis has three main aims, the first being the taxonomic revision of all the Libyan Caryophyllaceae *sensu lato* with reference to seed morphology. Scanning electron microscopy (SEM) in particular has been used to investigate seed morphology in relation to taxonomic value at various levels from infraspecific to subfamilial. The second aim was to investigate the taxonomic significance of calcium oxalate crystals in the genera *Arenaria*, *Moehringia* and *Minuartia* of subfamily Alsinoideae. The third aim was the study of capsular micromorphology of the genus *Silene*, subfamily Silenoideae particularly species of North African origin; a few other genera were also examined in this way.

In the family Caryophyllaceae as now recognised, Linnaeus (1753) recorded 24 genera and about 132 species. *Genera Plantarum* (1789) of de Jussieu contained only 31 genera of the family. By 1904 Willis in the second edition of his well known dictionary listed 60 genera and 1300 species, but in the (1966) seventh edition the figures had become 70 and 1750. Heywood (1978) and Abdul Gafoor (1987) gave totals of 80 genera and 2000 species, and more recently Mabberley (1987) recorded 89 genera and 2070 species. According to Bittrich (1993) the family consists of about 86 genera and about 2200 species. More than half of the Caryophyllaceae belong to only 6 genera, *Silene* has 400 species, *Dianthus* 250, *Arenaria* 250, *Gypsophila* 125, *Stellaria* 100 and *Cerastium* 100 according to Cronquist (1981). According to Bittrich (1993), however, the genus *Silene* has nearly 700 species, *Dianthus* about 300, *Arenaria* 150, *Gypsophilla* 150, *Stellaria* about 150-200, and *Cerastium* about 100.

The following diagnosis of the family is taken from Bittrich (1993), but with additions and alterations from various other sources.

Caryophyllaceae A. L. de Jussieu, Gen. Plant. : 299 (1789), nom. cons. Annual or perennial herbs, rarely shrubs or small trees, usually hermaphrodite, rarely gynodioecious or dioecious. Stems often swollen at the nodes, usually with anomalous secondary growth in older stems, often woody at base, erect to prostrate, branching often dichotomous, rarely irregular; leaves opposite, occasionally alternate or spirally arranged, sometimes whorled, entire, often petiolate, occasionally connate at base, or rarely with completely adnate margins, exstipulate or with usually membranous stipules. Inflorescence dichasial cymose or monochasial, flowers terminal or in axils of leaves solitary or in clusters, sessile or on long peduncles. Flowers actinomorphic, 5- rarely 4- merous hypogynous or perigynous. Sepals (4-)5 or rarely more or fewer, free or connate into a tube, or only slightly adnate at base, green or with membranous margins, glabrous or hairy; petals (4-)5 or rarely more, usually conspicuous, occasionally small, inconspicuous (subfamily Paronychioideae) stamens up to 10, rarely fewer by abortion, usually in 2 whorls of 5, the second whorl often absent or reduced into staminodes, free from one another, inserted with the petals in the rim of the cup-shaped receptacle or in a perigynous disc; gynoecium of 3-5 carpels, rarely more or only 2; ovary superior, 1-loculed or 3-5 imperfectly celled at base, 1- numerous ovules in commonly free central placentation; styles 2-5, free or united, ending with simple capitate or lobed stigmas. Petals stamens and ovary sometimes borne on an elongate internode (asithophore). Fruit usually a dehiscent capsule, with more or less numerous seeds, opening by as many or twice as many valves or teeth as the number of styles; rarely an indehiscent achene, enclosed in

a persistent calyx or a berry or pseudo-berry. Seed small, reniform or globose to pyriform, rarely peltate, usually with variously sculptured testa, rarely smooth, the back sometimes caniculate or winged, mostly exarillate or rarely arillate; embryo peripherally curved around the starchy perisperm, sometimes \pm straight, rarely spiral, endosperm little or absent. $x = 5-19$, sometimes polyploid series occur.

This large family of relatively uniform characters is usually conceived in modern treatments such as Bittrich (1993) as comprising three subfamilies: Alsinoideae, Paronychioideae and Caryophylloideae. The Caryophylloideae are sometimes referred to as Silenoideae, as in *Flora Europaea*. The subdivision of the family has long been controversial, particularly the status of Subfamily Paronychioideae. The Illecebraceae is classified within the Caryophyllaceae by some e. g. Tutin *et al.* (1964-93), Zohary (1966), and Stace (1991), but by others is classified as a separate family e.g. Davis (1967), Meikle (1977) and Abdul Gafoor (1977). The anatomical characters of the genera included by Bentham and Hooker in family Illecebraceae are so similar to those of the Caryophyllaceae that both groups have been described together as in the system of Engler and Prantl (Metcalf & Chalk, 1950). Boulos (1979) listed Paronychiaceae separately from Caryophyllaceae.

The arrangement of the genera into subfamilies and tribes varies with the author. See Table 1. In *Flora Europaea* and *Flora Palestina* the genera are separated into three subfamilies Alsinoideae, Paronychioideae, Silenoideae (Tutin *et al.* 1964-1993, Zohary 1966). In *Flora of Turkey* the genera are split into five groups and three subfamilies (Davis, 1966). *Flora of Cyprus* divided the genera into tribes Caryophylleae, Alsineae, Polycarpeae (Meikle, 1977). The *New Flora of the British Isles* arranged the

genera in to three subfamilies Alsinoideae, Paronychioideae and Caryophylloideae (Stace, 1991).

The detailed account by Bittrich (1993) is the most up-to-date of the family and he adopted this classification.

I. Subfam. Paronychioideae (A. L. Juss.) Meisn. (1838)

1. Tribe Polycarpeae DC. (1828)
2. Tribe Paronychieae (A. L. Juss.) Dumort. (1827)
3. Tribe Corrigioleae Dumort. (1827)

II. Subfam. Alsinoideae (DC.) Fenzl (1840)

1. Tribe Alsineae DC. (1824)
2. Tribe Pycnophylleae Mallfeld (1922)
3. Tribe Geocarpeae Palmer & Steyermark (1950)
4. Tribe Habrosieae (Fenzl) Pax (1927)
5. Tribe Scleranthae (A. L. Juss.) DC. (1828)

III. Subfam. Caryophylloideae

1. Tribe Caryophylleae
2. Tribe Drypideae Fenzl (1840)
3. Tribe Sileneae DC. (1824)

According to Cronquist (1981) the relationship of the Caryophyllaceae to the other families of the order Caryophyllales was confirmed by embryology, pollen morphology, the frequent occurrence of anomalous secondary growth and a special type of sieve-tube plastid. The book *Caryophyllales Evolution and Systematics* by Behnke and Mabry (1994) deals with many modern aspects such as DNA, gene sequences, chemotaxonomy and cladistics. There is, however, little or no treatment of seeds.

The Caryophyllaceae is mainly distributed in the temperate regions of the northern hemisphere with a centre in the Mediterranean and Iran-Turanean region (Bittrich, 1993) (Table 2). There are 10 species belonging to 7 genera (*Arenaria*, *Cerastium*, *Melandrium*, *Minuartia*, *Sagina*, *Silene*, *Stellaria*), growing in Greenland between Victoria Fjord, and Danmark Fjord, the northernmost land in the world, (Holmen, 1957) and the species, *Colobanthus quitensis*, is one of only two species of Angiospermae growing on the Mainland of Antarctica (Green, 1970).

NAME OF WORK	SYSTEM OF CLASSIFICATION
Flora Europaea 1962,93 (following Pax and Hoffman) Flora Palestina 1966 New Flora of the British Isles 1991	Subfamilies: Alsinoideae, Paronychioideae, Silenoideae/Caryophylloideae
Flora of Turkey 1966	Group I Subfam. Alsinoideae, Group II Sub fam.Paronychioideae, Group III Subfam. Paronychioideae, Group IV one genus <i>Thurya</i> , Group V Subfam. Silenoideae.
Flora of Cyprus 1977	Tribe 1. Caryophylleae, Tribe 2 Alsineae, Tribe 3 Polycarpeae.

Table 1. Classification of Caryophyllaceae in different Floras.

COUNTRY	NO OF GENERA	NO. OF SPP.
Britain	19	91
Egypt	20	57
Libya	22	80
Tunisia	25	115
Algeria	27	175
Morocco	26	229

Table 2. Approximate numbers of genera and species of the Caryophyllaceae in North Africa, and in Britain.

Chapter 2.

MATERIALS AND METHODS

2.1 Plant Material

The plant material used in this study was entirely dried specimens obtained from many herbaria (BM, E, GL, K, L, M, ULT, T). Full details are given in Appendix 1, which is a list of all the taxa studied during this research.

2.2 Seeds

In obtaining material from herbarium specimens great care was taken to select only fully ripe, undamaged seeds from mature capsules. In the early stages of the research the seeds were examined using a Philips 500 electron microscope in the Biological Science Electron Microscopy Laboratory. Seeds were mounted on stubs with double sided sticky tape (Sellotape), surrounded by conductive silver paint, and vapor coated with gold (200-400 Å thickness) while being rotated at an angle of 45°.

Later it was found that the use of the Leo Microscopy Stereoscan 360 and the Emscope sputter coater with a gold target, in the Geology Department and a different technique in mounting the seeds produced results of better quality. With few exceptions, the photographs presented here were obtained with that microscope and the following technique.

The heated stubs were evenly rubbed with wax sticks to leave a smooth, thin layer which hardened after a few seconds. Using a dissecting microscope, the seeds were carefully placed on the wax layer. Material was then kept in a dry and dust-free place to avoid dust contamination and to stop hydration. Measurements of the seed size were made using a micrometer eyepiece.

2.3 Crystals

The morphology and distribution of calcium oxalate crystals in the leaves of the genera *Arenaria*, *Moehringia* and *Minuartia* was studied. The technique devised was modified from the method used by Bokhari (1970) in order to reduce the time needed for clearing. Two or many mature leaves from herbarium sheets were placed in a small tube, a few drops of 10% KOH were added, and boiled in a water bath for five minutes. After washing with distilled water, the material was spread on a slide, blotted dry with a clean tissue and mounted in New Aquamount.

By far the most common component of crystals in plants is calcium oxalate; see Section 4.1 No elaborate procedure was undertaken to prove that the crystals studied were calcium oxalate. However, following Dormer (1961), it was shown that the crystals were soluble in HCl but not in acetic acid.

SEM photographs were taken of crystals from different species of *Arenaria*, *Moehringia* and *Minuartia* to show the difference in shape and fine structure between the druses and the sandy crystals, particularly the elongate ones in *Minuartia*. Mature leaves were kept over night in 10% KOH containing a few drops of H₂O₂. They were then boiled in distilled water until the tissues macerated. Crystals and macerated cells were selected by using a needle and forceps under the light microscope and placed on the stubs, following the same technique used for the seeds.

2.4 Capsules

The methods used were those of Payne (1970) and a new technique detailed below. A complete capsule of *Silene* (or fragment from the middle) was laid on a watch glass, flooded with acetone, and a small square of cellulose acetate film placed over the capsule before flooding again with acetone. The acetone dissolves the acetate, which settles against the surface of the specimen and in a few moments the acetone evaporates and the rehardened acetate film is peeled away (Payne 1970). It was found that the peels obtained by this technique were not very satisfactory because a dense cover of air bubbles often obscured the preparation. In trying to make better preparations, it was

decided to use superglue. In testing a few brands, Loctite was found to be the most satisfactory. Impressions of fully ripe capsules were made as follows. One or two drops of superglue were put on a slide and the middle of the capsule rather than the upper part was pressed into the superglue and left for one to two minutes to harden. Then the capsule was removed. No coverslip was placed over the sample. Photographs can be taken by using a light microscope. Only one capsule was, in general, examined of each specimen. Capsule epidermal cells of *Polycarpon*, *Polycarpaea*, *Spergula* and *Spergularia* were studied by clearing the whole capsule using the same method used for studying the crystals. A few SEMs were taken of the *Silene* capsules and the nutlets of *Herniaria* and *Paronychia*.

Chapter 3.

Seeds

3.1 Introduction

3.1.1 History of the Use of Seed Morphology

The taxonomic value of seed morphology had been realised in the eighteenth century by Linnaeus in his book *Genera Plantarum* (1737-1767)

The examples quoted below are taken from genera No 567, 569 and 586

567- *Silene* --- plurima, reniformia . 569 - *Arenaria* --- Plurima, reniformia

586 - *Spergula*--- plurima, depresso-globosa, margine emarginato cineta

However in his book *Species Plantarum* he makes no mention of seeds .

A.De. Jussieu (1791) in his book *Genera Plantarum*, used different sexual organs in his descriptions and ignored seed characters. De Candolle in

1828 published the first of the many volumes of *Prodromus systematis naturalis regni vegetabilis*. For the Caryophyllaceae he used various

taxonomic characters but made almost no use of seed morphology.

Endlicher however in his *Genera Plantarum* (1836-1840) treated 6235 species of vascular plants. He used detailed seed characters as part of the diagnoses of genera. In the Caryophyllaceae, for instance, he described seed shape and colour as well as ornamentation of the testa. The examples quoted below are taken from page 959 and onwards.

TRIBUS II. PTERANTHEAE R. Brown in Wallich Plant. As. rar. I. 17

Seminum chalaza lateralis, ab umbilico distincta. Embryo planus, rectus, albuminis farinacei lateri adplicitus .

Pteranthus Forsk.

Semen erectum, oblongum, compressum, testa tenui, laevissima, chalaza infra medium laterali. Embryo semini conformis, rectus, albuminis lateri hinc applicitus, radícula tereti, prominula infera .

TRIBUS IV. Telephieae DC. Prodr. III . 366 .

***Telephium* Tournef.**

Semina plurima, columellae centrali liberae affixa, globuloso-reniformia.
Embryo fere annularis, albumen farinaceum cingens.

TRIBUS V. Polycarpeae DC. Prodr. III. 373.

***Spergularia* Pers.**

Semina plurima, pyriformia, lenticulari-compressa, saepissime margine scarioso cincta, laevia, granulata v. muricata. Embryo uncinatus v. annularis, albumen farinaceum cingens. Cotyledonibus incumbentibus.

Within the Tribe Sileneae De Candolle described the seeds of *Dianthus* as follows (p. 355). "Semina compressa hinc convexa inde concava, peltata". However, Endlicher used seed shape as parts of tribal diagnoses. Within Subordo IV Sileneae DC., his Tribus I Diantheae Kunth Flor. berol. I. 106 has the following.

" Semina oblonga v. ovalia, compressa, dorso convexa, facie plana v. convexiuscula, medio longitudinaliter carinata. v. marginibus involutis canaliculata, placentae centrali columellari peltatim affixa."

And his Tribus II Lychnideae Fenzl msc.

"Semina globosa, reniformia v. lenticularia, umbilico marginali funiculus distinctis affixa."

Bentham and Hooker (1862-67) in their *Genera Plantarum* used seed morphological characters for most genera under ordo Caryophyllaceae but do not give detailed descriptions. Within their Tribus I. Sileneae they separated the genera *Velezia*, *Dianthus* and *Tunica* because of " Semina peltata, hilo faciali". In his *Flora of Syria, Palestine, and Sinai* , Post (1883) had two tribes within the order Sileneae as follows.

"Tribe I. Diantheae. Seeds shield-shaped, with hilum on face. Styles 2. Embryo straight."

"Tribe II. Lychnideae. Seeds kidney-shaped or nearly globular, with lateral hilum. Embryo peripheral or spiral."

In his monograph of the genus *Silene* published in 1868, Rohrbach used seed characters in a key to genera. For instance he separated *Petrocoptis* from *Lychnis* by "semina barbata" and "semina ebarbata". He included two plates of drawings showing seed shape, ornamentation and sections and he gave detailed seed descriptions for each species of *Silene*. For *S. cucubalus* (p.85, =*S.vulgaris*) he stated "semina magnetudine variantia, rotundata-reniformia, dorso plano-convexiuscula, faciebus levisime concava vel plano-concaviuscula rarove plana, seriatim tuberculata." For *S. maritima* With. (p.84, = *S. uniflora*) "semine dorso leviter canaliculata, faciebus plana tuberculata "These are two highly polymorphic species which since Rohrbach's day have received much study. In their well-known book *The Bladder Campions*, Marsden-Jones and Turrill (1957) illustrated a series of seeds of *S.uniflora* ssp. *uniflora* that varied from markedly papillate to non-papillate and used the terms armadillo and tubercled. These terms have been adopted by Aeschimann in his numerous studies of *S. vulgaris* as for instance in his 1985 paper.

In 1882 Luerssen in his book *Handbuch der systematischen Botanik* gave very brief information about the seeds of some genera of Caryophyllaceae. Because of these taxonomic uses of seed morphology, it is somewhat surprising that Pax (1894), and Pax and Hoffman (1934) in the highly significant work *Die natuerlichen Pflanzenfamilien* make little mention of seed characters within the Caryophyllaceae.

Various seed atlases and books of drawings of plants have depicted seeds of Caryophyllaceae; only four examples are mentioned here. Bertsch's *Fruchte und Samen* (1941) has four plates of seeds and Beijerinck's *Zadenatlas Der Nederlandsche Flora* (1947) has six. The well

known *Drawings of British Plants* by Ross-Graig include drawings of seeds and fruits; part 5 devoted to Caryophyllaceae has seeds drawn with the attention to detail typical of the artist. Much more important to this thesis is the work of Berggren (1981) whose work covers seeds and small fruits of northwest European plants. Part 3 deals with the Caryophyllaceae.

In the first and second editions of *Flora Europaea*, seed shape, colour, size and ornamentation have been used with the other morphological characters to describe most genera, sections and species eg. *Arenaria*, *Petrorhagia* and *Silene*. On the other hand for some genera and species, the seeds have been ignored or largely so eg. in the genera of subfamily Paronychioideae.

Variation in seed coat morphology between different populations of the same species has been noted in *Spergula arvensis* (New 1958) and he showed that the smooth and papillate seed coat forms of *Spergula arvensis* responded differently to temperature and humidity. According to Ball and Heywood (1964), the only reliable morphological character which can be used to distinguish between *Petrorhagia velutina*, *P. prolifera* and *P. nanteuillii* is the structure of the seed coat or testa. Seed morphology and anatomy of 42 species and 3 varieties of the genus *Dianthus* have been described by Kowal & Wojterska (1966). Wojterska (1969) gives results for the genus *Cerastium*. Because seed characters are only very slightly influenced by environmental factors, these features are very important criteria for the classification of species and genera. The genera and species of *Dianthus*, *Petrorhagia*, *Silene*, and *Spergula* show this very well. In many cases seed morphology varies at infraspecific level e. g. *Spergula arvensis* and *Spergularia media* with or without wings (Stace 1989).

In his recent survey of the family Bittrich, (1993, p. 214) stated "Seed morphology, especially the form of testa cells was variously found to be of

great diagnostic value mainly for separating taxa at the species level". He gave no importance to seed characters at the subfamily and tribal levels but often listed seed size, colour and ornamentation as significant at the generic level.

3.1.2 Scanning Reflection Electron Microscopy (SEM) and seed morphology

Since the late 1960s the scanning reflection electron microscope has been used to provide much taxonomic information about plant surfaces, particularly those of pollen and seeds. As early as 1969 Heywood (p.7) stated " The Caryophyllaceae in fact shows a very wide range of external features of the seed, including elaiosomes, and these are often related to reproductive capacity, germination differences and other biological problems as many studies have already shown. A detailed survey of the seeds in this family is needed and scanning electron microscopy now available as a rapid technique it is likely that such a survey will be undertaken".

The taxonomic significance of seed morphology of 15 species of *Sagina* from North America, Europe and eastern Asia was studied utilizing SEM (Crow 1979). Seeds of 13 southeastern United States taxa of *Arenaria* were examined with SEM. With a few exceptions, the external morphology was distinctive and valuable for separation at the species level (Wofford 1981). The seed-coat of twenty nine taxa belonging to the section *Minuartia* of the genus *Minuartia*, has been investigated by SEM. Almost all species, and sometimes several varieties of the same species could be identified by the details of their fine structure (Celebiogiu *et al.* 1983). With SEM the seed-coat was described in detail as one of the major morphological characters in *Minuartia glaucina*, *Minuartia smejkalii* and

M. orthophylla by Dvorakova (1985,1988,1991). A seed-coat study by SEM was made concerning *Arenaria tetraquetra* populations in southern Spain by Fararger *et al.* (1988). The papillae of the seed-coat cells possess a very distinct morphology, which enables the four subspecies of *Moehringia intricata* to be clearly distinguished (Guardia *et al.* 1991) .

Melzheimer (1980) revised some Balkan species of *Silene* sec. inflatae using several taxonomic features including SEM micrographs of the seed coat as a good diagnostic character. In *Flora Iranica* Rechinger *et al.* (1988) dealt with about 140 species of the large genus *Silene* . For many of these species they provided high quality SEM micrographs of the mid-zone testa cells; this revealed striking differences between the species. Since this important investigation there have been at least two more SEM studies of *Silene*. Testa cells were used with other characters to diagnose a new subsp., *Silene bupleuroides* L. ssp. *ganiatsasiana*, in the Greek flora (Voliotis 1991). The seed colour and testa ornamentation were used to separate *Silene haussknechtii* from *S. laconica* and the petal, capsule and the ridge on the seed back were used to distinguish *Silene. aegaea* from *S. pentelica* (Oxelman 1995).

3.2 Seed Morphology of the Libyan Species.

3.2.1 Layout

Subfamilies, tribes and genera are laid out in the order of Bittrich (1993). Within each genus the species are in alphabetical order. Nomenclature follows Greuter *et al.* (1984).

The description for each species begins with a direct quotation from the *Flora of Libya* (Fl. Lib.). Abdul Ghafoor's

statements on seed shape, size and colour are terse and necessarily based solely on light microscopy. He provided drawings of the seeds of most species at x10, 15, 25, 30 or even 50. These drawings by Mohamed Rafiq are mostly very satisfactory but SEM inevitably reveals important details very difficult or impossible to observe by light microscopy.

Abdul Ghafoor considered 59 species of Caryophyllaceae and 14 species of Illecebraceae in FL. Lib. He gave descriptions of the seeds of 56 and 13 of these species respectively and he illustrated 38 species in Caryophyllaceae and 3 species in Illecebraceae. The species listed by Abdul Ghafoor and not described are *Dianthus serrulatus*, *Petrorhagia illyrica* and *Silene biappendiculata*. The following descriptions total 57 of the Caryophyllaceae and all 14 of the Illecebraceae. Where relevant, descriptions have been given of the seeds of subspecies.

The following species are listed from Libya by Greuter *et al.* (1984) but have not been studied for this thesis: *Dianthus serratifolius* Sm., *Minuartia sandwithii* Maire & Simpson, *Petrorhagia rupestris* Brullo & Furnari, *Silene uniflora* Roth, *Spergularia munbyana* Pomel, *Telephium barbeanum* Born.? Additionally, within the taxonomically and nomenclaturally difficult genus *Cerastium* under "*semidecandrum* aggr." Greuter *et al.* (1984, p. 183) list *C. balearicum* F. Hermann and *C. diffusum*

Pers. Neither has been studied. Monnier (1975) provided fine line drawings of the seeds of *Spergularia munbyana*. *Minuartia sandwithii* from one locality in cyrenaica has been discussed by McNeill (1963) who thought that it may be conspecific with *M. meryeri* (Boiss.) Bornm.

The new descriptions in this thesis are based primarily on Libyan material but often supplemented by material from other Mediterranean countries, mostly North African, but also where appropriate from countries such as Britain and the Arabian states.

With regard to size, the seeds have been placed into three categories of length with few exceptions: < 1mm, 1-2 mm and > 2 mm. The length measurement was taken as shown in (Figure.1). The few exceptions are as follows.

In the case of dorsiventrally flattened seeds, the length measurements was taken from the tip of radicle to the opposite end of the seed. In the case of more or less globular seeds the diameter was measured. Each species description ends with a statement on geographical distribution derived from various Floras and Greuter *et al.* (1984).

3.2.2 Glossary

Capitate papillae or tubercles : Long papillae or tubercles ending with structure like a head.

Callus : A brittle, membranous ring around the hilum (cf. Berggren)

Caruncle : An outgrowth near the micropyle and the seed (Usher, 1966).
Strophiole = Caruncle.

Cogwheel : Testa cells with an outline resembling a cogwheel.

Collar cells : Cells often distinctive, around the hilum and the radicle (Chuang & Ornduff, 1992).

Discoid : Referring to a protuberance ending with a more or less flat, circular head.

Granule : Minute or very minute protuberance on testa cell; granules may densely cover the cells, (adj. granular).

Hilar notch : Indentation in which the hilum is situated.

Keeled : With a ridge along the periphery.

Midzone : Middle area of the lateral face of a seed (Figure. 1).

Pad : Padlike structure on each side of the hilar notch in *Silene* (cf. Berggren).

Papilla : Single pimplelike protuberance, only one from the middle of a lateral face of a testa cell, and large in comparison with overall size of the cell (adj. papillate).

Prickle : Small, sharp protuberance from testa cell; cf. *Spergularia*.

Revolvute : With the margin rolled so that the upper side is expanded and concealed the lower side .

Spurs : Arms of a testa cell, short to long, unbranched or branching a few times, with sharp or blunt ends.

Stelliform : Testa cell with radiating branches so as to appear starlike.

Tubercle : Single large, conspicuous, pimplelike protuberance from a testa cell of the marginal face (adj. tuberculate).

Wart : Small, pimplelike protuberance from testa cell; usually there are more than one or several or more per cell and small in comparison with overall size of the cell.

3.2.3 Descriptions

I. Subfamily Paronychioideae (A. L. Juss.) Meisn. (1838)

1. Tribe Polycarpeae DC. (1828)

Spergula L.

Spergula L., Sp. Pl.:440 (1753).

S.fallax (Lowe) E. H. L. Krause **(Plate 1)**

Fl.Lib. Seeds winged, lenticular, c. 1 mm in diam. (Excl.d.wing), black, wing nearly as broad as seed, tubercular or smooth.

Shape, size and colour: Circular, 1-2 mm, dark brown.

Testa surface: Lateral face convex, cells stelliform, flat or slightly convex; spurs regular, pinnate, each spur ending in one small but distinct pore-like depression; marginal cells, stelliform, raised into conical papillae; surface very fine granular; wing membranous, pale, up to half or more the width of the seed, with a deep V-shaped notch opposite the hilum, edge mostly entire; small prickles merging into papillae where the wing joins the seed; surface mostly smooth or slightly wrinkled .

Measurements: Mid zone cells 45-50 μm long, 20-25 μm wide;

spurs 12-16 μm long.

Specimens examined: Appendix 2 No 628, 630.

Distribution: N. Africa, Saharo Arabian and Sudanian territories

Spergularia (Pers.) J. Presl and C. Presl, nom. cons.

Spergularia (Pers.) J. Presl and C. Presl, Fl. Cech.:94 (1819).

S. bocconei (Scheele) Graebner in Ascherson & Graebner

(Plate 1)

Fl.Lib. Seeds triangular-ovate, c.0.5 mm long, all wingless, greyish-brown, finely tubercled.

Shape, size and colour: obovate-obtriangular, < 1 mm, brown.

Testa surface: Lateral faces slightly convex, cells irregularly and deeply lobed, papillae sparse, scattered irregularly, spurs irregular with very faint margins; marginal face surrounded with a distinct raised rim leaving a groove between lateral and marginal faces, cells faint, covered with conical papillae, whole papillae crowned with a flat-topped head-like structure; radicle compressed laterally, slightly tapering; surface granular.

Measurements: Lateral face cells 40-60 μm long, 10-20 μm wide; marginal face papillae c. 6 μm long, radicle 30 μm wide near apex.

Specimens examined: Appendix 2 No 638, 639.

Distribution: S.W. Europe, North Africa, S. Britain, eastwards to Iran, Atlantic Islands .

Spergularia diandra (Guss.) Boiss. (Plate 1)

Fl.Lib. Seeds triangular-obovate, c. 0.5 mm long, all wingless, dark brown to black, beset with rigid bristly papillae or rugulose.

Shape, size and colour : Obovate, < 1mm, dark brown .

Testa surface: Lateral faces slightly biconvex, cells mostly have the same shape (i.e. Jigsaw like), protrusive, irregular, deeply lobed, spurs broad, few in number, with blunt apices, papillae very small and indistinct, marginal surface broad with a distinct raised rim, shallowly grooved between lateral and marginal faces, tip of radicle slightly curved; Surface, finely granular.

Measurement: Testa surface cells 18-48 μm long, c.10 μm wide; spurs 13, c.7 μm long; radicle extended, c. 20 μm long.

Specimens examined: Appendix 2 No 643, 644.

Distribution: Mediterranean region and eastward to Afghanistan, Iran, Pakistan and India .

S. maritima (All.) Chiov. (Plate 2)

in Fl.Lib. [***S.media*** (L.) C. Presl]

Fl.Lib. Seeds brown, compressed, rounded, smooth or tubercled, c. 0.8-1 mm in diameter, mostly all winged, wavy membranous, entire or laciniate.

Shape, size and colour: Obovate, < 1 mm, red-brown.

Testa surface: Lateral faces slightly biconvex, cells irregular, jigsaw like, raised into blunt papillae; spurs lobed with blunt apices; marginal face with slightly raised rim, cells raised into distinct conical papillae, with a very shallow groove between the lateral and marginal face; wing margin slightly sinuate, making a V shape towards the hilum, covered with small prickles along the marginal face; surface minutely granular.

Measurements: wing c. 312 μm wide; radicle extended up to c. 63 μm ; papillae 6-14 μm long; spurs 6-9 μm long.

Specimens examined: Appendix 2 No 648, 649.

Distribution: Europe, Russia, Mediterranean region, China and S. W.Asia.

S.rubra (L.) J. Presl & C. Presl

(Plate 2)

Fl.Lib.Seeds obovate triangular or \pm trigonous, c. 0.5mm long, all wingless, dark brown or black, finely tuberculate.

Shape, size and colour: Obovate, <1 mm, red brown.

Testa surface: Lateral faces biconvex, cells mostly elongate, distinct or faint, some cells raised into globular papillae; spurs deeply lobed irregular; radicle mostly straight, tip broad, thick and round; marginal face with thick rim, most cells raised into distinct conical papillae with discoid heads, with a narrow groove between lateral face and marginal face; surface covered with dense granules.

Measurements: Lateral face cells c. 65 μm long, c. 10 μm wide ; spurs number 9-11, c. 10 μm long; papillae on lateral surface 10-14 μm long, papillae on marginal surface 10-20 μm long; radicle up to c. 50 μm long, c. 70 μm wide near apex.

Specimen examined: Appendix 2 No 653, 654.

Distribution: Widespread in N. hemisphere, Mediterranean and Euro-siberian, in some parts of Asia .

S.salina J. Presl & C. Presl

(Plate 2)

[in Fl.Lib.*S. marina* (L.) Gariseb.]

Fl.Lib. Seeds light brown, compressed, rounded, smooth or tubercled, c.0.6-0.8 mm in diameter, wingless or winged, both in the same fruit, wings scarious, erose to laciniate .

Shape, size and colour: Circular-obovate, < 1mm, red brown.

Testa surface: Lateral faces slightly biconvex, cells elongate or ovate, with sparse spherical or elongate papillae; spurs lobed, irregular and faint ; marginal face rounded and thick, papillae club shape dispersed on marginal side, shallowly grooved between lateral face and marginal face, wings covered with dense minute granules or prikcles, margin irregular, deeply sinuate; surface minutely granular.

Note : Winged and unwinged seeds have the same features.

Measurement: papillae 6-30 μm long ; radicle extended up 1 mm .

Specimens examined: Appendix 2 No 655, 656.

Distribution: Widespread in temperate, costal areas of the northern hemisphere in Europe, North Africa, India, Pakistan, China .

***Polycarpaea* Lam.**

Polycarpaea Lam., J. Hist. Nat.2:3, t.25 ("*Polycarpea*") (1792)

***P. repens* (Forsk.) Asch. & Schweinf. (Plate 4)**

Fl.Lib. Seeds obovoid-oblong, less than 1mm long, slightly compressed.

Shape, size and colour: Oblong-curved (crescent-shaped) tapering to radicle, <1 mm, creamy.

Testa surface: Lateral faces slightly biconvex, cells indistinct with no distinct spurs; dorsal surface strongly convex, with distinct, shallow furrow, cells indistinct; ventral surface concave; radicle terminal, slightly curved, surrounded by distinct cells; hilum subterminal; surface mostly smooth .

Measurements: Hilar cells c.13 μm long; radicle c. 78 μm long.

Specimens examined: Appendix 2 No 434, 435.

Distribution: Saharo Arabian region, North Africa

***P. robbairea* (O. Kuntze) Greuter & Burdet (Plate 4)**

[In Fl. Lib. *Robbairea delileana* Milne-Redhead]

Fl. Lib. Seeds minute, smooth, shiny.

Shape, size and colour: Broadly elongate tapering to radicle, <1 mm, colour creamy.

Testa surface: Lateral faces biconvex, cells indistinct, dorsal face convex with distinct furrow; ventral face concave; radicle terminal, slightly curved, surrounded by a collar of cells; hilum subterminal; short, smooth line connecting the radicle and the hilum; surface generally glossy, smooth .

Measurements: Radicle cells 8-10 μm long, 6-8 μm wide; short smooth line c. 50 μm long.

Specimens examined: Appendix 2 No 436, 437, 438.

Distribution: N. Africa, Egypt, Palestine, Iraq and Saudi Arabia and Sudan.

***Polycarpon* L.**

Polycarpon L. syst. Nat., ed. 10:881, 1360 (1759)

***P. prostratum* (Forsk.) Aschers & Schweinf. (Plate 6)**

Fl.Lib. Seeds \pm triangular - reniform , light brown , nearly 0.5 mm long.

Shape, size and colour: Cuneate, tapering to the radicle, <1 mm, creamy.

Testa surface: Lateral faces biconvex, cells raised into big papillae (dome-shaped), spurs indistinct; dorsal face strongly convex, cells similar to those of the lateral face; ventral face concave, covered with very dense papillaeas compared with the

lateral and dorsal faces; radical terminal, slightly curved, surrounded by elongate cells, dark brown; hilum subterminal; surface finely granular.

Measurements: Lateral face cells 15-30 μm diam , radicle cells 16-27 μm long, c. 8 μm wide .

Specimens examined: Appendix 2 No 455, 457.

Distribution: Tropical and subtropical countries .

P. tetraphyllum (L.) L.

(Plate 6)

Fl.Lib. Seeds \pm triangular-ovoid, brown, usually c.0.5 mm long, punctulate.

Shape, size and colour: Cuneate, tapering to the radicle, <1 mm, creamy.

Testa surface: Lateral faces biconvex, cells raised into globular, domed papillae surrounded by irregular, thick structures at the base, spurs indistinct; dorsal face convex, cells ovate or elongate arranged in rows; ventral face concave, cells irregular ; radicle terminal, slightly curved, surrounded by mostly elongate cells; hilum subterminal; surface smooth .

Measurements: Lateral face papillae 10-20 μm diam., dorsal face cells 30-54 μm long, c. 18 μm wide, radicle cells 12-36 μm long, c. 12 μm wide.

Specimens examined: Appendix 2 No 463, 465, 466.

Distribution: central Europe, Euro-Siberian region, Arabia and

Sudan; now cosmopolitan as a weed .

***Loeflingia* L.**

Loeflingia L., Sp. Pl.: 35 (1753).

***Loeflingia hispanica* L. (Plate 6)**

Fl. Lib. Seeds \pm compressed, obliquely obovate, c. 0.5 mm long, finely papillose, white.

Shape, size and colour: Broadly elongate, tapering to the radicle, <1 mm, white-gray .

Testa surface: Lateral faces biconvex, cells indistinct or faint, spurs faint, blunt with thick walls; dorsal surface keeled, compressed laterally. covered with distinct papillae; ventral surface slightly curved, papillae concentrated at the top and the base; radicle terminal, slightly curved, micropyle discoid, ornamentation indistinct surrounded by collar of papillae; hilum raised into an elongate ridge; surface smooth.

Measurements: Lateral surface cells 39-65 μm long, 10-26 μm wide; spurs 5-10, 3-13 μm long; radicle c. 83 μm long, micropyle c. 42 μm diam., papillae c. 10 μm long; dorsal face keel 17 μm high.

Specimen examined: Appendix 2 No 248.

Distribution: Mediterranean area, South Iran.

2. Tribe Paronychieae (A. L. Juss.) Dumort. (1827)

Pteranthus Forssk.

Pteranthus Forssk., Fl. Aegypt.-Arab.: 36 (1775).

P. dichotomus Forsk.

(Plate 7)

Fl.Lib. Seed erect, compressed, endospermous.

Seed shape, size and colour: Narrow-obovate, slightly dorsiventrally flattened, >2 mm, faint yellow.

Testa surface: Dorsal face convex, cells indistinct, surface wrinkled; dark brown circle near the middle of the dorsal face; no spurs; ventral face similar to the dorsal face; thick rim between the dorsal and ventral faces; radicle flattened, broad and round at apex, cell ornamentation is more distinct than on the other parts of the seed testa; hilum in the ventral surface below radicle; surface smooth not granular.

Measurements: Radicle c. 0.5 mm long.

Specimens examined: Appendix 2 No 468, 469.

Distribution: Mediterranean, Saharo-Arabian and Sudanian territories.

Sclerocephalus Boiss.

Sclerocephalus Boiss., Diagn. Pl. Orient. I, 1(3): 12 (1843);

Chaudhri, Meded. Bot. Mus. Herb. Rijksuniv. Utrecht 285:1-64 (1968), rev.

S.arabicus Boiss.

(Plate 7)

Fl.Lib.Seeds obovate-reniform 2-5-3 X 1.5-2 mm, compressed, glabrous.

Seed shape, size and colour: Obovate, >2 mm, light-brown.

Testa surface: Lateral face flat, compressed laterally, slightly slanted towards the hilum, cells indistinct, raised into wrinkled ridges; no spurs; marginal face flat round with a thick rim and with a distinct groove separating the lateral and marginal faces; radicle dark brown, extended straight to the front, tapering gradually from the base to the apex, cells mixed, mostly elongate or polygonal; hilum subterminal, with deep groove separating between the radicle and the hilum; surface wrinkled, smooth.

Seed measurements: Radicle c. 0.75 mm long, elongate, cells 24-96 μm long, c. 12 μm wide.

Specimen examined: Appendix 2 No 480.

Distribution: N. Africa, lower Jordan Valley, Dead Sea, Arabia and Iran .

Gymnocarpos Forskal

Gymnocarpos Forskal, Fl. Aegypt.: 65(1775).

G.decander Forsskal

(Plate 7)

Fl.Lib.Seed oblong-reniform, compressed.

Seed shape, size and colour: Obovate, 1-2 mm, brown.

Testa surface: Lateral face flat, compressed laterally, cells

faint, elongate; no spurs; marginal face flat, cells similar to the lateral face, slightly concave, groove separating the lateral and marginal faces; radicle tapering gradually from the base to the top, surrounded by elongate or polygonal cells, ending in a flat apex turned over the hilum; a deep groove separates the radicle and the hilum; surface smooth.

Measurements: Radicle c. 403 μm long, elongate cells 24-56 μm long.

Specimens examined: Appendix 2 No 218, 220.

Distribution: N. Africa, Iran, Syria, Jordan, Palestine, Arabia, Afghanistan, W. Pakistan, N. W. China.

***Paronychia* Miller**

Paronychia Miller, Gard. Dict. abr. ed. 4:3 (1754); Chaudhri

***P.arabica* (L.) DC.**

(Plate 8)

Fl.Lib. Seeds lenticular, \pm compressed, c. 0.75-1 mm, glabrous.

Seed shape, size and colour: Circular, <1 mm, light-brown, glossy.

Testa surface: Lateral faces biconvex, cells indistinct; marginal rim thick, laterally compressed; radicle dark-brown, thick, slightly curved, with circular rim around the apex filled with shrunken, surrounded by faint, polygonal cells; hilum subterminal, depression surrounded by a collar of rectangular, square or polygonal cells between the hilum and the radicle;

surface smooth, glossy.

Measurements: Cells around the hilum rectangular 12-18 μm long, 6-14 μm wide; square c. 11 x 11 μm ; radicle apex c. 54 μm diam.

Specimens examined: Appendix 2 No 404, 406.

Distribution: N. Africa, Syria, Lebanon, Palestine, Turkey and Saudi Arabia.

P. argentea Lam.

(Plate 8)

Fl.Lib. Seed ovoid-round, c. 1 mm in diam., brownish-red, glabrous.

Seed shape, size and colour: Circular-obovate, 1-2 mm, brown.

Testa surface: Lateral faces biconvex, cells indistinct or faint, polygonal; marginal face round with thick rim, cells faint, with a shallow groove separating the lateral and marginal faces; radicle curved, tapering gradually from the base to the top, its apex with a circular rim filled with shrunken cells surrounded by distinct, elongate cells; hilum subterminal, raised, surrounded by a collar of protrusive, ovate or elongate cells; surface smooth.

Measurements: Radicle c.1.58 mm long, radicle apex c. 315 μm diam., radicle cells 315-756 μm long, 216-315 μm wide; hilum 378 μm diam, hilum cells 63-189 μm long, c. 63 μm wide.

Specimens examined: Appendix 2 No 410, 412, 413.

Distribution: N. Africa, Europe, Jordan, Syria, Palestine, Sahara-Arabian and Sudanian territories.

P. capitata (L.) Lam.

(Plate 8,9)

Fl.Lib. Seeds oblong-lenticular, c. 1.2-1.5 mm long.

Seed shape, size and colour: Broadly elliptic, 1-2 mm, brown.

Testa surface: Lateral faces biconvex, cells indistinct; marginal rim thick, laterally compressed and shallow-grooved; radicle curved with tapering apex surrounded by mostly narrow, elongate and faint cells; hilum subterminal, surrounded by a conspicuous collar, cells round; surface smooth.

Measurements: Hilum c. 94 μm diam., cells around hilum c. 12 μm diam.; radicle 250 μm long, cells surrounding radicle 31-38 μm long, c. 6 μm wide.

Specimens examined: Appendix 2 No 415, 416.

Distribution: N. Africa, Sahara and south Europe.

P. chlorothyrsa Murb.

(Plate 9)

Fl. Lib. Seeds c. 1 mm long, yellow-brown.

Seed shape, size and colour: Broad elliptic, 1-2 mm, light brown.

Testa surface: Lateral surfaces biconvex, cells indistinct; marginal face keeled compressed laterally, cells faint, wrinkled

on one marginal side, otherwise smooth; radicle flattened, compressed laterally from both sides, surrounded by distinct cells which are mostly elongate; hilum subterminal, strongly protruding, surrounded by conspicuous cells; surface smooth, glossy .

Measurements: Keel c. 65 μm wide; hilum c.75 μm diam.; radicle c. 120 μm long.

Specimens examined: Appendix 2 No 418, 419.

Distribution: South Libya, Egypt to Morocco and Eritrea.

P. kapela (Hacq.) A. Kenner

(Plate 9)

Fl. Lib. Seeds c. 1.25-1.5 mm long, brown.

Seed shape, size and colour: Broadly elliptic, 1-2 mm, brown.

Testa surface: Lateral faces biconvex, cells indistinct; marginal face strongly compressed laterally, surrounded by narrow, elongate cells; radicle tapering gradually, ending in a pointed apex, surrounded by narrow, elongate cells; hilum subterminal, surrounded by an inconspicuous collar of polygonal cells; surface smooth.

Measurments: Radicle c. 330 μm long, surrounding cells 42-90 μm long, c. 12 μm wide; hilum 113 μm diam., surrounding cells 6-13 μm long.

Specimens examined: Appendix 2 No 421, 422.

Distribution: Morocco, S. E. Spain, France, Libya.

***Herniaria* L.**

Herniaria L., Sp. Pl.: 218 (1753); Chaudhri, Meded. Bot. Mus.

Herb. Rijksuniv. Utrecht 285: 297-398 (1968), rev.

H. cinerea* DC.*(Plate 10)**

Fl.Lib. Seeds shining black, lenticulate, c. 0.5 mm long, erect, with brittle testa.

Seed shape, size and colour: Broadly elliptic, <1 mm, brown.

Testa surface: Lateral faces biconvex, cells indistinct; marginal face keeled, compressed laterally, dark brown, around the circumference; radicle thick slightly curved toward the hilum, apex circular, filled with shrunken cells, surrounded by a collar of square and rectangular cells; hilum subterminal, with a plug of many, compressed, small cells, \pm 3 cells high, and with a collar of square or polygonal cells; surface smooth, highly glossy.

Measurements: Radicle apex 60 μ m diam., square cells 18x18 μ m, rectangular cells 9-24 μ m long, 12-15 μ m wide; hilum c.30 μ m.diam., ring cells 6-18 μ m high, collar cells 15-21 μ m long, 12-21 μ m wide.

Specimens examined: Appendix 2 No 224, 226.

Distribution: N. Africa, S. E. Europe, Turkey, Pakistan and Atlantic Islands.

H.cyrenaica F. Hermann

(Plate 10)

Fl. Lib. Seeds lenticular, c. 0.5 mm, shining brown.

Seed shape, size and colour: Circular, <1 mm, glossy brown.

Testa surface: Lateral faces biconvex, cells indistinct; marginal face keeled, strongly compressed laterally; the radicle and the hilum in prominent, terminal positions where the cells have rectangular and polygonal are with deep cavity separating the hilum and the radicle; surface smooth, glossy .

Measurements: Radicle tip 30 μm wide, hilum 30 μm diam., groove 36 μm deep; cells surrounding hilum and radicle 9-18 μm long, 6-15 μm wide.

Specimen examined: Appendix 2 No 227.

Distribution: Endemic to Libya.

H.ericifolia Townsend

(Plate 10)

Fl. Lib. No description.

Seed shape, size and colour: Circular, <1 mm, brown .

Testa surface: Lateral face biconvex, cells indistinct; marginal face keeled around a part of the circumference; radicle slightly curved, surrounded by a collar of conspicuous, narrow, elongate or polygonal cells; hilum subterminal surrounded by a collar of polygonal and rectangular cells, ending in a dome-shaped structure; a shallow groove separates the hilum and the radicle; surface smooth, glossy .

Measurements: Radicle c. 40 μm diam., cells 10-40 μm long, 4-12 μm wide; hilum c. 30 μm diam., cells 6-12 μm long, 4-8 μm wide.

Specimens examined: Appendix 2 No 228, 229.

Distribution: Endemic to Libya along sea shore west of Tripoli .

***H. fontanesii* Gay**

(Plate 11)

Fl.Lib. Seeds compressed, ovoid, c. 0.75 mm, light brown .

Seed shape, size and colour: Broadly elliptic, <1 mm, brown.

Lateral surface: Lateral faces biconvex, indistinct; marginal face is strongly compressed laterally; radicle surrounded by a double collar of elongate and rectangular cells; hilum subterminal, surrounded by a collar of rectangular or polygonal cells; a deep cavity separates the hilum and the radicle; surface smooth, glossy.

Measurements: Radicle apex c. 30 μm diam.; hilum apex c. 36 μm diam.; cavity c. 40 μm long, c. 10 μm wide; rectangular cells 6-18 μm long, 2-6 μm wide.

Specimens examined: Appendix 2 No 231, 234.

Distribution: Spain, Sicily, Canary Is. , N. Africa .

***H. glabra* L.**

(Plate 11)

Fl.Lib. Seeds lenticular, c. .5 mm in diam., glabrous, shining brown.

Seed shape, size and colour: Circular-obovate , <1 mm, dark brown.

Testa surface. Lateral faces biconvex, cells indistinct; marginal face keeled around the circumference; radicle slightly curved, surrounded by a conspicuous ring of cells with faint walls; hilum subterminal, surrounded by a collar of polygonal cells; surface smooth and glossy.

Measurements: Micropyle c. 40 μm diam., hilum apex c. 48 μm diam., space between radicle and hilum c. 60 μm long.

Specimens examined: Appendix 2 No 237, 238.

Distribution: Europe, N. Africa, Iran, Iraq, Turkey and Russia.

H.hemistemon Gay

(Plate 11,12)

Fl.Lib. Seeds ovoid-suborbicular, c. 0.5-0.7 mm long.

Seed shape, size and colour: Circular-obovate, <1 mm, brown.

Testa surface: Lateral faces biconvex, cells indistinct; marginal face keeled, compressed laterally; radicle thick curved ending in a discoid apex filled with shrunken cells; hilum compressed laterally with a thin apex surrounded by a collar of faint, polygonal and elongate cells; a shallow space separates the hilum and radicle; surface smooth and glossy.

Measurements: Radicle apex c. 30 μm diam.; hilum apex c. 40 μm diam.; space between hilum and radicle c. 50 μm .

Specimens examined: Appendix 2 No 240, 241.

Distribution: N. Africa, Iran-Turanian region.

Tribe Corrigioleae Dumort. (1827)

***Telephium* L.**

Telephium L., Sp. Pl. :271 (1753); Willam, J. Bot. 44:289-304, rev.

***Telephium sphaerospermum* Boiss. (Plate 12)**

Fl.Lib.Seeds brown, sphaerical, c. 0.75 mm in diameter, not compressed, papillate.

Seed shape, size and colour: Globose, <1 mm, brown .

Testa surface: Lateral faces convex, cells mostly spherical marginal face convex; radicle slightly curved with discoid apex; rectangular cells in about 10 parallel rows in a band extending about half way round the seed; hilum in marginal notch; a marked feature of this seed is a very distinct small caruncle consisting of a mass of small globular cells; surface rough.

Measurements: Lateral surface cells c.13 μm diam., radicle apex c. 50 μm diam. ; caruncle cells c. 7 μm diam.

Specimens examined: Appendix 2 No 667.

Distribution: N. Africa, Egypt, Saharo-Arabia region.

II. Subfam. Alsinoideae (DC.) Fenzl (1824)

1. Tribe Alsinoideae

***Arenaria* L.**

Arenaria L., Sp. Pl.: 423 (1753); McNeil, Notes R. Bot. Gard.

Edinb.24: 102-129 (1962),245-309 (1963), part. rev., reg. rev.

***A. serpyllifolia* L.**

(Plate 12)

Fl.Lib.Seeds circular-reniform, c. 0.5-0.7 mm long, blackish-brown, with papillate tubercles.

Seed shape, size and colour: Subreniform to circular, <1 mm, brown.

Testa surface: Lateral faces plane or slightly convex, midzone cells mostly ovate, round or elliptic, protrusive; spurs regular cogwheel-like; marginal face plane to slightly grooved with cells in regular rows, raised into blunt, conical tubercles; radicle curved, with distinct cells; hilum terminal in hilar notch; surface granular.

Measurements: Lateral face elliptic cells 80-156 μm long , and c. 45 μm wide, ovate cells 45-78 μm long and 35-45 μm wide; marginal face cells c. 43 μm diam. , spurs 14 - 16 , c. 6 μm long.

Specimens examined: Appendix 2 No 157, 161, 164.

Distribution: N. Africa, Europe, Asia and N. America.

***A.leptocladus* (Reichenb.) Guss.**

(Plate 13)

Fl.Lib. Not included in the Flora of Libya.

Shape, size, and colour: Circular-reniform, <1 mm, brown.

Testa surface: Lateral faces slightly biconvex, midzone cells mostly elongate or elliptic in regular rows; spurs regularly

spaced, mostly short and with single blunt or sharp apices; marginal face mostly convex cells round raised into blunt conical tubercles, in regular rows; radicle curved with elongate cells and sinuate margins; hilum terminal in hilar notch; surface minutely granular.

Measurements: Lateral surface elliptic cells c. 42 μm long and, c. 21 μm wide, elongate cells 42-84 μm long and, c. 14 μm wide; radicle cells 21-56 μm long, c. 14 μm wide; spurs 10-14 , 4-10 μm long.

Specimens examined: Appendix 2 No 98, 100, 111.

A. leptocladus (Davis 50344)

(Plate 13)

Fl. Lib. Not included in the Flora of Libya.

Seed shape, size and colour. Circular-reniform, < 1 mm., dark brown.

Testa surface: Lateral faces biconvex, cells mostly elongate or elliptic, rarely ovate, mostly raised into distinct, round papillae; spurs irregular in length, with sharp or blunt apices; marginal face convex, cells raised into very distinct conical tubercles with regular spaced spurs; radicle cells elongate, covered with 2-5 warts in each cell; hilum mostly terminal, in hilar notch; surface granular.

Measurements: Lateral face cells 48-80 μm long and 16-25 μm wide; radicle cells 18-70 μm long 9-18 μm wide; spurs

5-18, 3-9 μ m long; papillae c. 6 μ m long; tubercles c.18 μ m long.

Specimens examined: Appendix 2 No 101.

***Cerastium* L.**

Cerastium L. Sp. Pl.: 437 (1753).

***C. comatum* Desv.**

(Plate 14)

in Fl. Lib. [*C. illyricum* Desv.]

Fl.Lib. Seeds obovate, c. 0.5 mm long, light brown, minutely tuberculate.

Seed shape, size and colour: Broadly-cuneate, <1 mm, orange-brown.

Testa surface: Lateral faces, flat, slightly sloping to notch, cells elongate in regular rows, slightly curved, long and short, radially arranged; spurs short, regularly spaced; marginal face grooved, cells conically tuberculate; radicle slightly curved; hilum in hilar notch; surface granular.

Measurement: Lateral face cells 60-103 μ m long, and 9 μ m wide; spurs number \pm 17, c. 10 μ m long .

Specimens examined: Appendix 2 No 192, 193.

Distribution: N. Africa, S. Europe, Turkey and Palestine .

***C.dichotomum* L.**

(Plate 14)

Fl.Lib. Seeds \pm obovate, c. 1 mm long, reddish-brown, tuberculate.

Seed shape, size and colour. Broadly cuneate, <1 mm, light orange.

Testa surface.Lateral faces biconvex, cells mostly ovate to circular, raised into blunt or sharp papillae, dome-shaped, smooth at the apices, arranged in regular rows; spurs irregularly branched, covered with small granules, arranged like necklaces; marginal face convex, cells raised into conical tubercles with tapering apices; radicle curved; hilum in hilar notch; surface minutely granular except the upper apices of the cells.

Measurements: Lateral face cells 45-120 μm long and c. 45 μm wide; spurs 8-18, 25-100 μm long; marginal surface tubercles 28-70 μm long.

Specimen examined: Appendix 2 No195, 197.

Distribution: Mediterranean, Western Asia .

C.glomeratum Thuill.

(Plate 14)

Fl.Lib.Seeds subreniform, pale-brown,c. 0.5 mm long, finely tuberculate.

Seed shape, size and colour. Broadly cuneate, <1 mm, orange but marginal face darker.

Testa surface.Lateral faces, flat, slightly sloping to the notch, cells elongate, slightly curved and distinctly raised, radially arranged, mostly regular; spurs long, tapering gradually toward apices; marginal face grooved, cells raised into long tubercles ;

radicle curved about equaling the cotyledons, cells with no, distinct spurs; hilum in hilar notch; surface finely granular.

Measurements: Lateral face cells 33-100 μm long and 10-23 μm wide; spurs 10-16, 4-16 μm long; radicle cells 50 - 60 μm long.

Specimens examined: Appendix 2 No 200, 201.

Distribution: Europe, Mediterranean, Western Asia .

C. ligusticum Viv.

(Plate 14)

Fl.Lib. Seeds ovoid-reniform, c. 0.5-0.9 mm long, brown, sharply and minutely tuberculate.

Seed shape, size and colour: Broadly cuneate, <1 mm, pale brown.

Testa surface: Lateral faces flat, cells narrow, elongate or stelliform, distinctly raised, irregularly distributed; spurs of differing lengths and irregular arrangement, mostly branching at apices; marginal face deeply grooved, cells mostly stelliform raised into short conical tubercles; radicle longer than cotyledons; hilum in hilar notch; the space between the radicle and the hilum wide; surface minutely granular .

Measurements: Lateral face cells 26-63 μm long and 6-16 μm wide, spurs 8-11, 13-20 μm long, tubercles c. 16 μm length.

Specimens examined: Appendix 2 No 202, 203.

Distribution: S. Europe, Asia minor and N. Africa (Libya, Algeria)

C. pumilum Curtis

(Plate 15)

Fl.Lib.Seed ± reniform, pale brown, c. 0.5 mm long, finely tuberculate.

Seed shape, size and colour: Broadly-cuneate, <1 mm, orange-brown.

Testa surface: Lateral faces flat, cells narrowly elongate or stelliform, mostly with distinctly raised ridges, often, slightly curved; spurs of differing lengths and irregular arrangement; marginal face mostly rounded, grooved, cells stelliform and tuberculate; radicle equals cotyledons, curved; hilum in hilar notch; surface minutely granular.

Measurements: Lateral faces cells stelliform, 33 - 50 µm long and 23-33 µm wide; lateral face spurs 12-14, 10-16 µm long; marginal cells rounded, 33 µm diam, marginal cells spurs 11 - 12, 10 - 16 µm long; cells at junction of lateral and marginal faces elongate, 60 - 66 µm long and 15 - 18 µm wide, spurs 10 - 13, c. 8 µm long, tubercles c. 35 µm long.

Specimen examined: Appendix 2 No 206, 207.

Distribution: N. Africa, Iran, Turkey and Caucasia .

Cerastium semidecandrum L.

(Plate 15)

Fl.Lib.Seeds somewhat rounded-reniform, pale brown, c. 0.4-0.5 mm long, finely tuberculate.

Seed shape, size and colour: Broadly cuneate, <1 mm, light orange.

Testa surface: Lateral faces biconvex, slightly sloping to notch, cells mostly elongate or elliptic, with distinctly raised, mostly blunt papillae, radially arranged; spurs long, sharp, sometimes divided at apices; marginal face rounded grooved, cells stelliform and tuberculate; radicle equaling cotyledons, slightly curved; hilum in hilar notch; surface minutely granular.

Measurements: Lateral face long cells 35-67 μm long, and 14-21 μm wide, stelliform cells 21-35 μm diam.; spurs 10 -12 , 12 - 31 μm long; marginal face tubercles c. 20 μm .

Specimens examined: Appendix 2 NO 209, 210.

Distribution: Irano-Turanian region, Europe, N. Africa .

C.siculum Guss.

(Plate 15)

Fl.Lib.Seeds rounded-reniform , 0.4-0.5 mm long, pale-brown, finely tubercled.

Seed shape, size and colour : Broadly cuneate, <1 mm, orange-brown.

Testa surface: Lateral faces flat slightly concave in the middle, cells mostly stelliform, raised into round or conical distinct papillae; spurs sharp, narrow and cogwheel-like; granules arranged in regular rows on spurs; marginal face rounded, cells stelliform raised into conical papillae, dark in

colour; radicle curved, equaling or slightly longer than cotyledons; hilum in hilar notch; surface minutely granular.

Measurements: Lateral face cells stelliform, 12-25 μm in diam.;

spurs 10-30, 10-25 μm long; radicle cells 16-50 μm long, marginal face tubercles c. 18 μm long.

Specimen examined: Appendix 2 No 212, 213.

Distribution: N. Africa, W. Med. from Portugal to Italy and Sicily.

***Stellaria* L.**

Stellaria L., Sp. Pl.: 421 (1753).

***S. media* (L.) Vill.** (Plate 15)

Fl.Lib. Seeds reniform, rounded, up to 1.5 mm long, compressed, light to dark brown.

Subsp. *media*

Shape, size and colour: Circular-reniform, <1mm, dark-brown.

Testa surface: Lateral faces flat, cells stelliform or elongate in concentric regular rows, distinctly raised; spurs many, long, with sharp, single or divided ends, with 2-4 small warts regularly arranged on each spur regularly; marginal face rounded, cells stelliform, raised into long tubercles (tongue-shaped), decreasing gradually towards the hilum, covered by dense warts; radicle equal and very close to the cotyledons, cells elongate with very small or no spurs, warts arranged on margins;

surface finely granular.

Measurements: Lateral face, stelliform cells 30-80 μm diam, elongate cells 60-113 μm long and, c. 26 μm wide; radicle cells c. 7; marginal tubercles 60-120 μm long and, 53-106 μm wide.

Specimens examined: Appendix 2 No 660, 661, 662.

Distribution: Throughout the world.

S. media (L.) Cyrill.

(Plate 16)

Subsp. *cupaniana* (Jordan & Fourr.) Nyman

Fl. Lib. This taxon is not recorded from Libya.

Seed shape, size and colour: Circular-obovate, <1 mm, dark-brown.

Testa surface: Lateral faces slightly convex, cells mostly stelliform or curved, elongate, distinct by raised, in concentric rows; spurs irregular, covered with three or more small warts; marginal face rounded, cells stelliform with very long tubercles, flat (tongue-shaped), spurs covered with small warts; radicle equal and close to the cotyledons, cells elongate, lacking spurs, covered with small warts, arranged on the margins; hilum in hilar notch; surface finely granular.

Measurements: Lateral face stelliform cells 67 μm diam., elongate cells 67-133 μm long and 20-33 μm wide; spurs 11-14, 7-33 μm long; radicle cells c. 7 μm long; marginal tubercles 87-167 μm long, 53-113 μm wide .

Specimen examined: Appendix 2 No 659.

Distribution: Widespread in the Mediterranean area particularly in E. Mediterranean.

S. pallida (Dumort) Pire

(Plate 17)

Fl. Lib. Not described.

Seed shape size and colour: Circular-reniform, <1 mm, red brown.

Testa surface: Lateral faces slightly sloping to the notch, cells mostly stelliform, arranged in concentric rows; spurs short, cogwheel-like, with one or two warts on each spur; marginal face cells round, tuberculate, spurs many, each covered with one or two warts; radicle curved equal to the cotyledons, cells elongate, spurs not distinct or very short, warts dense, arranged on the cell margins; hilum in hilar notch; surface minutely granular.

Measurements: Lateral face stelliform, c. 40 μm diam., elongate cells c. 60 μm long, c. 27 μm wide; spurs 12-14 , 10-20 μm long; radicle cells c. 33 μm long; marginal tubercles c. 47 μm long.

Specimens examined: Appendix 2 No. 665, 666.

Distribution: Mediterranean and Euro-Siberian regions.

***Minuartia* L.**

Minuartia L., Sp. Pl.: 89 (1753), McNeil, Notes R. Bot. Gard.

Edin. 24: 133-150 (1962), 311-401 (1963), veg. rev.

M. campestris* L.*(Plate 17)**

Fl.Lib. Seeds rounded-reniform, 0.4-0.7mm long, brown, finely tuberculate.

Shape, size and colour: Retortiform, <1 mm, orange.

Testa surface: Lateral faces slightly biconvex to plane, cells mixed, mostly ovate or elongate raised into blunt papillae; spurs regularly spaced, cogwheel-like; radicle curved, cells lacking spurs; marginal face convex, cells mostly ovate, rising into blunt tubercles, spurs regular, cogwheel-like, with a few papillae on notch cells; hilum in hilar notch; surface minutely granular.

Measurements: Lateral face cells elongate, 40-80 μm long and 20-24 μm wide, ovate cells 40-72 μm long and 28-40 μm wide near the base; spurs \pm 12-15, 4-12 μm long; radicle cells 13-54 μm long.

Specimen examined: Appendix 2 No 262.

Distribution: S.W. Europe, N. Africa.

M. geniculata* (Poiret) Thell.*(Plate 17)**

Fl.Lib. Seeds rounded-reniform, c.0.5-0.82 mm long, brown, with slightly rugose margin.

Seed shape, size and colour: Reniform, <1 mm, orange, tip of

radicle dark brown.

Testa surface: Lateral faces plane or slightly slanted, cells in concentric rows radially arranged, elongate, smooth; spurs short, blunt and regularly spaced; marginal face slightly concave, cells covered with dense, small warts in the European specimen, the Moroccan and Libyan specimens lack such warts; radicle tapering, curved, with dark brown apex; hilum in hilar notch and the adjacent cells covered with dense small warts, in European and Libyan specimens, but few in the Moroccan material; surface generally smooth .

Measurements: lateral face cells in European and Moroccan specimens 40-120 μm long and 18-20 μm wide but in Libyan specimen 30-75 μm long and c. 15 μm wide; spurs in European and Moroccan material spurs 10-22 but in Libyan material 7-16, spur length in European specimen c. 12 μm but in Libyan and Moroccan specimens c. 6 μm .

Specimens examined: Appendix 2 No 295, 296, 297, 300.

Distribution: Widely distributed in the Mediterranean region.

M.hybrida (Vill.) Siskin

(Plate 19)

Fl.Lib. Seed reniform, 0.3-0.6 mm long, brown, finely tuberculate.

Seed shape, size and colour: Elliptic-retortiform, < 1 mm, orange but radicle dark brown.

Testa surface: Lateral surfaces slightly biconvex, sloping to the notch, cells radially arranged from the notch, mostly elongate; spurs short, blunt, straight or slightly curved; radicle curved, narrowing gradually; marginal face slightly concave, cells raised into blunt tubercles; hilum in hilar notch, adjacent cells raised into elevated, conical papillae; surface minutely granular.

Measurements: Lateral face cells 6-20 μm long and 10-16 μm wide; spurs 10-24; 2-6 μm long; papillae near hilum c. 18 μm , radicle cells 18-42 μm long.

Specimens examined: Appendix 2 No 316, 322, 324.

Distribution: Mediterranean area, S.W. Asia and eastwards to Afganistan.

M. mediterranea (Link) K. Maly in Glasn. **(Plate 19)**

Fl.Lb. Seeds reniform, c. 0.4-0.6 mm long, smooth.

Seed shape, size and colour: Circular-retortiform, <1 mm, orange.

Testa surface: Lateral surfaces slightly biconvex, depressed near hilum, cells elongate, arranged radially, a few with blunt, faint warts; spurs short, blunt and regularly spaced; marginal face convex, shallowly grooved, cells raised into blunt tubercles; radicle curved; hilum in hilar notch surrounded by elongate

papillae; surface minutely granular.

Measurements: Lateral face cells 35-85 μm long and 10-15 μm wide; spurs \pm 20-26, c. 4 μm long, papillae near hilum c.14 μm , marginal tubercles c. 10 μm long.

Specimen examined: Appendix 2 No 331.

Distribution: Throughout the Mediterranean area .

***M. montana* L.**

(Plate 19)

Fl.Lib. Seeds rounded-reniform, 0.6-0.8 mm long, dark brown, obscurely and minutely tuberculate.

Seed shape, size and colour. Circular-reniform, <1 mm, orange .

Testa surface: Lateral faces biconvex, cells mostly ovoid or elliptic; spurs regularly spaced, narrow with sharp apices; marginal face convex, cells elevated into dome-shaped tubercles arranged in \pm 6 rows, spurs regularly cogwheel-like; radicle curved; hilum in hilar notch, adjacent cells raising into distinct papillae; surface fine granular .

Measurements: Lateral face cells 33-83 μm long and c. 26 μm wide; spurs 22, 5-7 μm long; radicle cells 33- 65 μm long; marginal face cells 28-49 diam. .

Specimens examined: Appendix 2 No 336, 339, 341.

Distribution: N. Africa, S. Europe.

***Sagina* L.**

Sagina L. Sp.Pl.: 128 (1753); Crow, Rhodora 80: 1-91 (1971),

reg. rev.

S.apetala* Ard.*(Plate 20)**

Fl.Lib.Seeds compressed, reniform, less than 0.4 mm long, brown.

The illustration cannot be a seed of *Sagina*. It shows a seed closely resembling those of *Polycarpon*.

Shape, size and colour: Cuneate to elongate-reniform, <1 mm, light-brown.

Testa surface: Lateral faces slightly biconvex, cells mostly elongate or round, large and few in number, ± 24 in each face; spurs shortly pinnate or cogwheel-like, with pointed apices; marginal face rounded and grooved, cells stelliform; radicle equaling the cotyledons; hilum near the surface; surface minutely granular.

Measurements : Lateral faces, cells stelliform 25-32 μm in diam. , elliptic, 41 - 50 long , spurs 9 - 15 , 4 - 16 μm long.

Specimens examined: Appendix 2 No 471, 474.

Distribution: N. Africa, Euro-Siberian area.

See 3.3 for a detailed discussion.

S. maritima G. Don

(Plate 20)

Fl.Lib.Seeds compressed, reniform to \pm triangular, c. 0.4 mm long, brown papillose.

Shape, size and colour: cuneate to triangular-reniform, <1 mm, light-brown.

Testa surface: Lateral faces slightly biconcave, cells mostly elongate or stelliform; spurs sharp, pinnate or cogwheel-like; marginal face slightly concave, rounded; radicle slightly curved; hilum near the surface; surface minutely granular.

Measurements: Lateral face cells elliptic 62 - 50 μm long and, 15 - 20 μm wide, stelliform cells c. 25 μm in diam. ; spurs 12 - 13, 4 - 10 μm long.

Crow (1979) published an SEM of a seed of this species from Sweden. This seed appears broadly similar to the Libyan material.

Specimen examined: Appendix 2 No 476, 477.

Distribution: Widespread along the Mediterranean coast, Atlantic Islands, Northern and Western Europe.

III. Subfam.Caryophylloideae

I.Tribe Caryophylleae

Gypsophila L.

Gypsophila L., Sp. Pl.: 406 (1753); Barkoudah, Wentia 9:35-157 (1962).

G.elegans MB.

(Plate 20)

Fl. Lib. Seeds \pm rounded-reniform, c. 1.5 mm long, obtusely tubercled.

Shape, size and colour: Circular-reniform, 1-2 mm, brown.

Testa surface: Lateral faces slightly biconvex, cells arranged in regular rows, mostly elliptic or ovate, raised with blunt papillae; spurs regularly spaced, mostly blunt; marginal face convex, cells stelliform, raised into pointed, conical tubercles; radicle longer than cotyledons, thick and curved, cells mostly similar to those of the lateral face; hilum in hilar notch; surface finely granular.

Measurements: Lateral face elliptic cells 85-187 μm long and c. 51 μm wide, ovate cells 51-85 μm long and c. 45 μm wide; spurs \pm 10-15, 9-30 μm long; marginal face tubercles c. 85 μm long.

Specimen examined: Appendix 2 No 222.

Distribution: Central Europe, Irano-Turanian region.

G. pilosa Hudson

(Plate 21)

Fl.Lib. Seeds reniform, c. 1.5 mm long, obtusely tubercled.

Seed shape, size and colour: Circular-reniform, 1-2, brown.

Testa surface: Lateral faces concave, slanted to the hilum, cells elliptic, raised into distinct conical papillae; spurs blunt, curved down; marginal face broad, cells narrowly elliptic,

arranged in ± 7 regular rows with low or high tubercules; radicle curved; hilum in hilar notch; surface rough and wrinkled.

Measurements: Lateral face cells 100-210 μm long and c.40 μm wide; spurs 20, c. 20 μm long ; marginal face cells 120-250 μm long and c. 40 μm wide .

Specimen examined: Appendix 2 No 223.

Distribution: N. Africa, W. Asia from Turkey and Palestine into adjacent regions.

***Vaccaria* Wolf**

Vaccaria Wolf, Gen. III (1776); Gen. Sp.: 234 (1781); Rechinger, Flora Iranica, Cont. 163: 337-341 (1988), reg. rev.

***V. hispanica* (Miller) Rauschert**

(In Fl. Lib. *Vaccaria pyramidata* Medik.)

(Plate 22)

Fl.Lib. Seeds globose.

Seed shape, size and colour: Globose, 1-2 mm, dark brown-black

Testa surface: Lateral faces strongly convex with mostly broad, elliptic cells, each cell raised into blunt papillae; spurs shallow and curved; radicle indistinct; hilum occupies a terminal depression, surrounded by an inconspicuous collar of polygonal cells; a band of narrowly rectangular cells extend laterally from the hilum about half way round the seed; surface finely granular to smooth.

Measurements: Lateral face cells 62-92 μm long and 34-46 μm wide; spurs 10-15, 2-11 μm long; hilum c. 125 μm diam.; band cells c. 62 μm long and c. 24 μm wide.

Specimens examined: Appendix 2 No 668, 669.

Distribution: S. Europe, N. Africa, Irano-Turanian region.

***Dianthus* L.**

Dianthus L., Sp. Pl.: 409 (1753).

***D. crinitus* Sm.**

(Plate 22)

Fl. Lib. Seeds ovate, 2-3 mm long, finely papillate.

Seed shape, size and colour: Dorsiventrally compressed, broadly elliptic, >2 mm, black.

Testa surface: Dorsal faces plane or slightly concave, cells of two types, one type extended along the radicle to the middle ridge area with differing shapes, mostly elongate, ovate or polygonal, the other type covers the whole area of the dorsal face, mostly narrow and elongate; spurs short, blunt or sharp; ventral face plane, slightly convex near the hilum, cells mostly narrow elongate or with differing shapes, around the hilum mostly round elliptic or ovate; marginal face strongly compressed; radicle straight and extended, longer than cotyledons with round apex; hilum on the surface, crateriform; surface minutely granular.

Measurements: Dorsal face narrow, cells elongate, c. 63-195

μm long and c.17 μm wide, spurs \pm 10-21, c. 3 μm long; ventral face narrow, elongate cells c. 60-120 μm long and c.17 μm wide, spurs c. 3 μm long; radicle c. 264 μm long.

Specimens examined: Appendix 2 No 216, 217.

Distribution: Europe, Asia, Australia. It is cultivated as an ornamental plant.

Petrorhagia (Ser.) Link

Petrorhagia (Ser.) Link, Handb. 2: 235 (1831); Ball and Heywood, Bull. Brit. Mus. (Nat. Hist.) Bot. 3: 121-172 (1964).

P.illyrica (Ard.) Ball & Heywood **(Plate 23)**

Fl.Lib. seeds oblong, black, 1.5 - 2.3 x c. 1mm, smooth, margins thin.

Seed shape, size and colour: Dorsiventrally compressed, broadly elliptic (leaf-shaped), 1-2 mm, black.

Testa surface: Dorsal surface plane, slightly concave near the centre, cells irregular and narrow or broadly elongate; spurs broad, with blunt or sharp apices; ventral face slightly concave, cells mostly elongate; radicle protruding extended with broad, round apex; hilum near the lower third of the seed; surface minutely granular.

Measurements : dorsal face cells 16-33 μm long and c. 13 μm wide, spurs 6-11, 4.2-8.3 μm long; radicle c. 220 μm long.

Specimens examined: Appendix 2 No 423, 424.

Distribution: N. Africa, S. Europe .

P.velutina (Gauss.) P. W. Ball & Heywood (Plate 23)

Fl.Lib. Seed black, boat-shaped, 1-1.3x0.7-0.8 mm, strongly tuberculate or cylindrical-papillate .

Seed shape, size and colour: Dorsiventrally compressed, (boat-shaped), 1-2 mm, black.

Testa surface: Dorsal surface extremely convex, cells mostly stelliform in regular rows, each cell raised into conical papillae with different heights; spurs deeply lobed, often single or bifid with sharp or blunt apices; middle ridge area very distinct in its elongate cells which have blunt warts; radicle broad and conspicuous; ventral side deeply concave, hilum near the lower third, surrounded by prickles or blunt papillae; surface minutely granular.

Measurements: Middle ridge cells 42-70 μm long and c.14 μm wide; dorsal stelliform cells 28-56 μm diam, spurs 10-12 , 14-40 μm long; papillae 21-42 μm long; radicle c. 170 μm long .

Specimens examined: Appendix 2 No 427, 428.

Distribution: N. & S Africa, S. Europe., Cyprus, West Asia, Hawaii, Western Australia.

SEM photographs of seeds of this widespread species were produced by Thomas (1980). They show testa features identical

to those of the seeds described here. She (p. 152) stated that "The morphology of the testa was found to be very consistent between different populations". The SEM of the testa cells papillae and spurs in Cutter (1978) shows strong similarities with our material.

2. Tribe Sileneae DC. (1824)

Silene L.

Silene L. Sp. Pl.: 416 (1753); Melzheimer, Flora Iranica, Cont.

163: 341-508 (1988), reg. rev.

S. apetala Willd. Morphotype A.

(Plate 23)

Fl.Lib. Seeds rounded-reniform, c.1 mm long, dull blackish-brown, faces plane, deeply grooved on back with undulate wings .

Seed shape, size and colour: Circular-reniform, 1-2 mm, with undulate wings, orange-brown.

Testa surface: Lateral faces slightly concave slanted in the middle; cells narrowly elongate, tapering at the ends, in the midzone each cell is raised into one wart, cells of the undulate wings narrow, elongate, raised into 6-9 warts on each cell; the spurs undulate or indistinct in midzone but in the undulate wing the spurs regularly spaced, with sharp or blunt apices; marginal face with deep groove; the radicle equalling cotyledons; the hilum sunken in hilar notch, surrounded by long finger-shaped papillae; pads with distinct cells; surface minutely granular .

Measurements: Lateral face cells 85-175 μm long, 14-21 μm wide; papillae in the midzone area c. 7 μm long, papillae in the hilar notch 14-35 μm long; spurs on the undulate wing spurs number \pm 13-22, c. 7 μm long.

Specimens examined: Appendix 2 No 484, 487, 488, 489.

Distribution: Mediterranean area, SW. Asia, Tropical Africa .

***S. apetala*.** Morphotype B.

(Plate 24)

Fl.Lib. Not included in the *Flora of Libya*.

Seed shape, size and colour: Circular-reniform, 1-2 mm long, with undulate wings, brown.

Testa surface: Lateral face biconcave at the midzone, cells narrow elliptic or elongately, raised into round or blunt warts; spurs broad and very short, the cells of the wings undulate raised into distinct warts; marginal face deeply grooved; pads with distinct cells raised into elongate or conical papillae; radicle equalling the cotyledons; hilum sunken in hilar notch surrounded by elongate papillae; surface finely granular.

Measurements: Lateral face cells 40-136 μm long and 10-24 μm wide, warts c. 3.7 long; papillae of the pads c. 23 μm long; hilum papillae c. 39 μm long.

specimen examined: Appendix 2 No 485.

S. apetala. Morphotype C.

(Plate 24)

Fl. Lib. Not included in the *Flora of Libya*.

Seed shape, size and colour: Circular-reniform, 1-2 mm long, with undulate wings, brown.

Testa surface: Lateral face biconcave near midzone, cells narrowly elliptic and elongate, raised into large conical papillae and small warts; spurs lacking; cells of undulate wings narrow, elongate and raised into many warts; radicle equalling the cotyledons; hilum sunken in the hilar notch, surrounded by dense, long papillae (finger-shaped); surface finely granular.

Measurements: Lateral face cells 34-136 μm long, and 7-20 μm wide, lateral face warts 3.4-34 μm long; papillae of the pads c. 20 μm long; hilum papillae 14-40 μm long.

Specimen examined: Appendix 2 No 486.

S. articulata Viv.

(Plate 25)

Fl. Lib. Seeds Circular-reniform, much compressed, \pm 2 mm long, with 2 undulate wings, finely punctate-papillose.

Seed shape, size and colour: Circular-reniform, 1-2 mm, brown, with undulate wings.

Testa surface: Lateral faces slightly concave, slanted toward the margins, midzone cells narrowly elongate, tapering at apices, without spurs and no papillae; cells of the undulate wing elongate, with many conspicuous regular warts on

each cell; marginal face deeply concave; radicle equalling the cotyledons; hilum sunken in hilar notch; pads lacking; surface finely granular.

Measurements: Lateral face cell 120-160 μm long, and c.14 μm wide .

Specimens examined: Appendix 2 No 495.

Distribution: Endemic.

S. behen L.

(Plate 25)

Fl.Lib. Seeds rounded -reniform , c. 1.5 mm long , faces concave-convex, back wide, 4-5 furrowed with 4 rows of acute, conical tubercles, brown.

Seed shape, size and size: Circular-reniform, <1 mm, orange-brown.

Testa surface: Lateral faces compressed laterally, slightly slanted near hilar notch, cells elongate, arranged in 4 regular rows, mostly simple tapering to one apex but sometimes bifurcate at the other apex, each cell raised into blunt or spherical papillae at one end, in regular rows; spurs regularly spaced, short and mostly with sharp apices; marginal face grooved with distinct tubercles; radicle equalling the cotyledons; hilum sunken in hilar notch; pads large, swollen; surface minutely granular.

Measurements: Lateral face cells 110-185 μm long and 26-56

μm wide; marginal face tubercles c. $53 \mu\text{m}$ long; spurs $\pm 20-30$, c. $5 \mu\text{m}$ long; pad cells $26-86 \mu\text{m}$ long .

Specimen examined: Appendix 2 No 498.

Distribution: N. Africa, S. Europe, W. Syria, Cyprus.

***S. cerastoides* L.**

(Plate 25)

Fl.Lib. Seeds rounded-reniform, dark brown, $\pm 0.6 \text{ mm}$ long, faces deeply concave, striate, back wide, shallow obtusely narrow grooved.

Seed shape, size and colour: Reniform, $< 1 \text{ mm}$, gray.

Seed testa: Lateral faces deeply biconcave, slanted towards the margin, cells mostly elongate and elliptic, radially arranged, each cell raised into 4-10 round warts; spurs regularly spaced, mostly with blunt apices; marginal face slightly grooved, with elongate and ovate cells, each cell raised into blunt tubercles; radicle equalling the cotyledons; hilum sunken in hilar notch, surrounded with long, finger-shaped papillae; pads flat, with polygonal cells; surface mostly smooth.

Measurements: Lateral face cells $36-75 \mu\text{m}$ long and $10-15 \mu\text{m}$ wide; pad cells $23-32 \mu\text{m}$ long; papillae around hilum $10-30 \mu\text{m}$ long .

Specimens examined: Appendix 2 No 503, 504, 505.

Distribution: S. Europe, and N. Africa.

S. colorata Poiret.

Fl. Lib. seeds rounded-reniform, 1-1.5 mm long, dark brown, faces plane and smooth to somewhat tuberculate, deeply grooved with 2 undulate or wavy wings .

Subsp. *colorata* (Plate 25)

Seed shape, size and colour: Circular-reniform, 1-2 mm, with undulate wings, brown.

Testa surface: Lateral faces slightly concave, slanted towards the margin, cells narrow, elongate with tapering apices, lacking papillae and spurs; slightly undulate wings raised into many blunt warts arranged in one line; marginal face deeply concave ; radicle equalling cotyledons; hilum sunken in hilar notch, surrounded by long finger-shaped papillae; pad cells raised into conical papillae; surface finely granular.

Measurements: Lateral face cells 60-185 μm long and c. 8 μm wide; papillae around hilum c. 30 μm long; pad papillae 8-20 μm long.

Specimens examined: Appendix 2 No 509, 511, 512.

Distribution: Mediterranean area, N. Iraq, Syrian Desert, Sinai, eastwards to Arabia and Pakistan.

Subsp. *trichocalycina* Fenzl.

Var. *lasiocalyx* S.-W. et Godr. (Plate 26)

Fl. Lib. Not included in the Flora of Libya.

Seed shape, size and colour: Circular-reniform, 1-2 mm, with undulate wings, brown .

Testa surface: Lateral faces slightly biconcave near the midzone, cells narrowly elongate and lanceolate; spurs very distinct with regularly spaced and blunt apices; undulate wing with narrow, elongate cells, each one raised into many blunt warts; marginal face deeply concave; radicle equalling the cotyledons; hilum sunken in hilar notch; distinct pads with cells raised into round and conical papillae; surface finely granulated .

Measurements: Lateral face cells 54-179 μm long and 10-20 μm wide; spurs 4-8 μm long; papillae around the hilum 100-170 μm long.

Specimens examined: Appendix 2 No 510.

Distribution: Mediterranean, Russia, Turkey and Pakistan.

***S. conoidea* L.**

(Plate 26)

Fl.Lib. Seeds rounded-reniform, 1.25-1.5 mm long, concave on one side, bluntly tuberculate, dark brown.

Seed shape, size and colour: Circular-reniform-, 1-2 mm, dark brown .

Testa surface: Lateral faces plane, slightly slanted towards the hilar notch, cells elliptic narrowly to broadly ovate shapes raised into blunt papillae at the midzone; spurs regularly spaced, with sharp apices; marginal face plane to slightly convex, cells

raised into blunt tubercles; radicle equalling cotyledons; hilum sunken in hilar notch; pads large and globular; surface finely granular.

Specimens examined: Appendix 2 No 517, 520.

Measurements: Lateral face cells 84-217 μ m long and 34-108 μ m wide; spurs \pm 20, c. 4-13 μ m long; pad cells 32- 50 μ m long.

Distribution: Mediterranean region, Iraq, Iran, Turcomania, Afganistan, Pakistan .

The SEM of a seed of this species in Melzheimer (1988) shows strong similarities with the Libyan material.

S.cyrenaica Maire & Weiller

(Plate 26)

Fl. Lib. Seeds rounded reniform, c. 2 mm long, faces plane, back grooved with 2 undulate wings.

Seed shape, size and colour: Circular-reniform, 1-2 mm, with undulate wings, brown.

Testa surface: Lateral faces mostly plane, slanted towards the wing, cells narrowly elongate, tapering to the apices; spurs indistinct or blunt; undulate wing cells distinct in 3 regular rows, each cell raised into many blunt warts, arranged in a single regular line; marginal face deeply grooved; radicle equalling the cotyledons; hilum sunken in hilar notch surrounded by conical papillae and distinct callus; pad cells distinct, irregularly ovate or polygonal, raised into conical or round

papillae; surface finely granular.

Measurements: Lateral face cells 100-238 μm long and 7-18 μm wide; pad cells c. 20 μm long, c.10 μm wide, papillae c.20 μm high.

Specimens examined: Appendix 2 No 523, 524.

Distribution: Endemic.

S.fruticosa L.

(Plate 26)

Fl.Lib. Seeds rounded-reniform c. 1.5 mm long, faces plane or slightly concave, striate, obtusely grooved on the back.

Seed shape, size and colour: Circular-reniform, 1-2 mm, red-brown.

Testa surface: Lateral faces slightly biconcave, cells narrowly elongate or elliptic, many cells raised into conical papillae; spurs distinct, of varied irregular sizes; marginal face concave, cells arranged into \pm 6 regular rows, cells raised into pointed conical tubercles; radicle equalling the cotyledons; hilum sunken in hilar notch; pads distinct; surface granular.

Measurements: Lateral face cells 84-168 μm long and c. 30 μm wide; spurs 15, 5-28 μm long; tubercles c. 79 μm long.

Specimen examined: Appendix 2 No 530.

Distribution: N. Africa, Greece and Med. Islands, from Sicily to Cyprus and, Turkey .

S. fuscata Brot.

(Plate 27)

Fl.Lib. Seeds reniform, c. 1mm long , faces concave or subexcavate and tuberculate, back tuberculate, ungrooved or shallowly grooved, or \pm convex .

Seed shape, size and colour: Reniform, <1 mm, gray .

Testa surface: Lateral face biconvex, slightly concave near midzone area, cells ellipitic or elongate, raised into blunt papillae arranged in \pm 4 regular rows; spurs short, distinct, with regularly spaced and sharp apices; marginal face cells oval or circular, arranged in concentric rows; radicle equalling the cotyledons; hilum sunken in hilar notch; pads distinct, flat black; surface granular .

Measurements: Lateral face cells 103-170 μm and c. 36 μm wide; spurs 12-22, c.8.5 μm long; pad cells 46-51 μm long.

Specimens examined: Appendix 2 No 531, 532.

Distribution: N. Africa, W. Europe, Lebanon, Palestine.

S. gallica L.

(Plate 27)

Fl.Lib. Seeds rounded - reniform , c. 1 mm long , dark brown to black, with deeply concave, striate faces and wide, plane or concave back, slightly tuberculate.

Seed shape, size and colour: Reniform, <1 mm, gray.

Testa surface: Lateral faces biconcave, cells broadly elliptic, each cell raised into 2-3 distinct round warts; spurs lacking or

indistinct, 2-3; marginal face slightly convex cells arranged in dense rows with different shapes, raised into conical tubercles with pointed apices; radicle equalling the cotyledons; hilum sunken in hilar notch, surrounded by figer-shaped papillae; pads globular, dark brown; surface granular.

Measurements: Lateral face cells 66-116 μm long , 23-45 μm wide; papillae c. 9 μm long; pad cells 28-70 μm long, 14 μm wide.

Specimens examined: Appendix 2 No 534, 536, 539.

Distribution: N. Africa, W. Euro-Siberian, E. Tropical Africa and Australia .

S.italica (L.) Pers.

(Plate 27)

Fl.Lib. Seeds rounded-reniform, 1-1,5 mm long, faces plane, obtusely grooved on the back.

Seed shape, size and colour: Reniform, 1-2 mm, brown.

Testa surface: Lateral faces compressed laterally, plane, slightly slanted towards the hilum, cells elliptic or ovate, arranged in ± 5 regular rows, each cell raised into one round or elongate papilla or into small, elongate warts; spurs regularly spaced mostly with sharp apices; marginal face grooved; radicle equalling the cotyledons; hilum sunken in hilar notch; pads large and globular, cells elongate or polygonal, smooth or raised into round papillae; surface finely granular.

Measurements: Lateral face cells 95-186 μm long and 27-53 μm wide; spurs number \pm 5-20 , 5-15 μm long; pad cells 15-50 μm long, c. 15 μm wide

Specimens examined: Appendix 2 No 546, 548.

Distribution: Mediterranean, Turkey and Russia.

S.longipetala Vent.

(Plate 28)

Fl.Lib. Seeds rounded-reniform , \pm 2 mm long, plane or \pm concave on faces, obtusely grooved on the back , finely wrinkled .

Seed shape, size and colour: Broad-reniform, 1-2 mm, red-brown.

Testa surface: Lateral faces compressed laterally, slightly biconcave, cells narrower elongate or elliptic, strongly raised, a few cells with blunt papillae; spurs regularly spaced with sharp apices; marginal face concave, cells mostly elongate, overlapping, arranged in \pm 4 regular rows; spurs indistinct; radicle equalling the cotyledons; hilum sunken in hilar notch; pads distinct, cells mostly ovate; surface granular.

Measurements: Lateral face cells 95-247 μm long and c. 20 μm wide; pad cells 38-76 μm long, c.19 μm wide.

Specimens examined: Appendix 2 No 558, 559.

Distribution: Widespread in Europe, N. Africa, Central Turkey and Northern Iran.

S. marmorica Beguinot

(Plate 28)

Fl.Lib. There is no seed description .

Seed shape, size and colour: Reniform, <1 mm, red brown.

Testa surface: Lateral face compressed laterally, cells narrowly elongate, strongly raised; spurs regularly spaced, apices sharp or blunt; marginal face concave, cells raised into blunt conical tubercles; radicle equalling the cotyledons; hilum sunken in hilar notch; pads large and globular, cells elongate, curved or ovate; surface minutely granular.

Measurements: Lateral face cells 60-160 μm long, 20-40 μm wide, spurs 6-22, 4-13 μm long ; marginal tubercles 64-84 μm long.

Specimens examined: Appendix 2 No 560, 561.

Distribution: Endemic.

S. muscipula L.

(Plate 28,29)

Fl.Lib. Seeds rounded - reniform , c. 1 - 1.2 mm long , faces plane, finely tuberculate, obtusely grooved on back, dark brown to blackish - brown.

Seed shape, size and colour: Reniform, <1 mm, red brown.

Testa surface: Lateral faces plane, slanted toward hilum, cells narrowly elongate or elliptic, arranged in ± 3 regular rows; spurs regular in size and with sharp apices; marginal face slightly grooved, cells raised into blunt tubercles; radicle

equalling the cotyledons; hilum sunken in the hilar notch; pads large and globular, cells elongate or elliptic; surface granular.

Measurements: lateral face cells 76-133 μm long and c. 24 μm wide; spurs number $\pm 12 - 20$, c. 6 μm long , pad cells 33 - 66 μm long.

Specimens examined: Appendix 2 No 566, 567.

Distribution: Mediterranean, extending to S.W. Europe .

***S.nocturna* L.**

(Plate 29)

Fl.Lib. Seeds rounded-reniform c. 0.72-1.2 mm long, with concave faces and wide, obtusely grooved, tuberculate back, un winged .

Seed shape, size and colour: Reniform, <1 mm, dark brown to black.

Testa surface: Lateral faces deeply biconcave, cells narrowly elliptic or elongate in regular rows, each cell raised into many blunt, distinct or indistinct warts, with simple or bifid ends; spurs, regularly spaced, with sharp apices; spurs with sharp apices, cell ends simple or bifid; marginal face plane or grooved, cells, arranged in ± 5 rows, narrow or elliptic, raised up into long or small, blunt warts; radicle equalling cotyledons; hilum sunken in the hilar notch; pads large and globular, cells mostly elongate, spurs indistinct; surface finely granular.

Measurements: Lateral face cells 41-119 μm long and 15-25

μm wide; spurs \pm 16-22, c. 6 μm long; pad cells 36-45 μm long.

Specimens examined: Appendix 2 No 575, 576.

Distribution: Mainly Mediterranean.

S.rubella L.

(Plate 29)

Fl.Lib. Seeds rounded grooved on moderately wide back, tubercled .

Seed shape, size and colour: Reniform, <1 mm, red brown.

Testa surface: Lateral faces biconcave, cells narrowly elongate with tapering ends, each cell raised into many blunt or rarely into distinct, round warts; spurs short, regularly spaced, with sharp apices; marginal face slightly concave, cells bluntly tuberculate; radicle equalling the cotyledons; hilum sunken in hilar notch; pads slightly flattened, cells elliptic or elongate, dark brown; surface minutely granular.

Measurements: Lateral face cells 40-185 μm long and 15-25 μm wide; spurs 8-22 , 5-10 μm long; pads 10-50 μm long, 10-30 μm wide; marginal face tubercles c. 20 μm long.

Specimens examined: Appendix 2 No 590.

Distribution: Mediterranean.

S.sedoides Poiret

(Plate 29)

Fl.Lib. Seeds reniform, 0.3 - 0.5 mm long, faces plane or \pm concave, striate, back obtusely grooved, black .

Seed shape, size and colour: Reniform, <1 mm, dark-brown .

Testa surface: Lateral faces plane, slanted toward the hilum, cells narrowly or broadly elliptic, arranged in ± 4 regular rows, all the cells raised into one distinct papilla at one end; spurs regularly spaced, with sharp apices; marginal face grooved, cells arranged in ± 4 rows, elliptic or elongate, with one distinct papillae on each cell; radicle equalling the cotyledons; hilum sunken in the hilar notch; pad cells mostly ovate, small and few in number ± 3 , one papilla raised on each cell; surface granular.

Measurements: Lateral face cells 41-75 μm long and 20-25 μm wide; spurs 18-20, 5-10 μm long; papillae 3-8 μm long, pads cells 3-8 μm long, 15 μm wide; marginal face cells 15-48 μm long and 15-21 μm wide .

Specimens examined: Appendix 2 No 594, 595.

Distribution: Widely distributed in the Mediterranean area.

S.succulenta Forsskal

(Plate 30)

Fl.Lib. Seeds rounded-reniform, c. 1 mm long, \pm smooth or finely striate, brown.

Seed shape, size and colour: Circular-reniform, <1 mm, brown.

Testa surface: Lateral faces plane, cells faint, elongate or elliptic without papillae and lacking spurs; marginal face flat or slightly concave; radicle equaling cotyledons; hilum sunken in

the hilar notch; pad cells mostly elongate, slightly flattened; surface smooth.

Measurements: Lateral surface cells 53 - 66 μm long and 10-25 μm wide, pad cells 33 -54 μm long and c. 18 μm wide

Distribution: S. Europe, N. Africa, Egypt, Lebanon, Crete, Sardinia, Corsica.

Specimens examined: Appendix 2 No 600, 601.

Distribution: Mediterranean.

S. tridentata Desf.

(Plate 30)

Fl.Lib.Seeds rounded-reniform, c. 0.8 mm long, dark brown, faces concave, striate, back wide with 1 or sometimes 2 shallow grooves .

Seed shape, size and colour: Reniform, <1 mm, dark brown.

Testa surface: Lateral faces deeply biconcave, cells elongate or elliptic, raised into many warts; spurs blunt or indistinct; marginal face concave, cells broadly elliptic and tuberculate; radicle equalling cotyledons; hilum sunken in the hilar notch, surrounded by finger-shaped papille; pad cells mostly ovate, flat or raised into distinct papillae; surface finely granular or smooth.

Measurements: Lateral face cells 20-100 μm long and 10-20 μm wide; pad cells 28-36 μm long, 12-20 μm wide; hilum papillae c. 26 μm long.

Specimen examined: Appendix 2 No 602.

Distribution: Spain, N. Africa, W. Irano-Turanian region, extending towards W. Mediterranean territories.

S.villosa Forsskal

(Plate 30,31)

Fl.Lib. Seeds rounded-reniform, c. 0.75 mm long, brown, reticulate ± convex, grooved on the back, winged.

Seed shape, size and colour: Circular-reniform, <1 mm, orange.

Testa surface: Lateral faces plane, slightly slanted towards the marginal face, cells elliptic, ovate or round, papillae indistinct; spurs lacking, cells surrounded by very thin, thread-like structures (probably artefacts); marginal face shallowly concave; radicle equalling cotyledons; hilum sunk in the hilar notch; pad cells resembling lateral face cells and difficult to distinguish; surface smooth.

Measurements : Lateral face elliptic cells 55-88 µm long and 33 µm wide, ovate cells 44-77 µm long and c. 44 µm wide , round cells 41-100 µm diam.; spurs ± 16-22 , c. 3 µm long.

Specimens examined: Appendix 2 No 606, 607.

Distribution: N. Africa, Saharo-Arabian region.

The SEM in Melzheimer (1988) does not show the testa in great detail but the cells appear elongate in contrast to the Libyan

material, with short, broad cells.

S.vivianii Steudel

(Plate 31)

Fl. Lib. There is no seed description.

Seed shape, size and colour: Circular-reniform, < 1 mm, with undulate wings, brown.

Testa surface: Lateral faces plane, slanted towards the hilum, cells elongate, each cell raised into many blunt, round warts concentrated in the midzone area; spurs regularly spaced, blunt or indistinct; cells of the undulate wings arranged in 2 regular rows, each cell raised into many blunt warts; marginal face concave; radicle equalling the cotyledons; hilum sunken in the hilar notch; pad cells distinct and globular in shape; surface wrinkled, smooth.

Measurements: Lateral face cells 75-150 μm long and 8-20 μm wide; marginal tubercles c. 30 μm long.

Specimens examined: Appendix 2 No 610, 611.

Distribution: N. Africa, Jordan and Palestine.

S.vulgaris (Moench) Garcke

(Plate 31)

Fl.Lib. Seeds rounded - reniform , c. 1.5 mm long, tuberculate.

Seed shape, size and colour: Circular-reniform, 1-2 mm, black.

Testa surface: Lateral faces biconvex, cells elliptic, arranged

in \pm 6 rows, each cell raised into one distinct, conical papilla in the middle, uniform in shape, size and position; spurs distinct with regularly spaced and sharp apices; marginal face convex, cells mostly round-stelliform, each cell raised into a conical tubercle; radicle equalling the cotyledons; hilum sunken in the hilar notch; pad cells elongate and globular; surface finely granular.

Measurements: Lateral face cells 69-207 μm long and 35-69 μm wide; lateral face papillae and marginal face tubercles c. 68 μm long; spurs \pm 11-20, 7-30 μm long; pad cells 69-75 μm long, c. 23 μm wide.

Specimens examined: Appendix 2 No 615, 616.

Distribution: Europe, Mediterranean area, Middle East, Central Asia eastwards to Kamtschatka .

The SEM of testa cell papillae and spurs in Barthlot (1981) shows strong similarities with the Libyan material particularly the cells near the marginal face.

***Agrostemma githago*. L.**

(Plate 31)

Agrostemma L., Sp. Pl.: 453 (1753).

Fl. Lib. Seeds \pm reniform, c. 3 mm or more long, acutely tubercled, black.

Seed shapes, size and colour: Reniform, 1-2 mm, dark brown.

Testa surface: Lateral face plane, slightly slanted near the

hilar notch, cells mostly elongate, arranged \pm 7 regular rows, each cell raised into highly distinct, conical papillae; marginal face broad, plane or slightly concave, cells arranged in many regular rows, each cell raised into long tongue-shaped tubercles; radicle \pm equalling cotyledons, hilum sunken in the hilar notch; surface granular.

Measurements: Lateral face cells c. 100-280 μm long and c. 70 μm wide, papillae c. 30-60 μm long; marginal face tubercles c. 175 μm long.

Specimen examined: Appendix 2 No 1,2.

Distribution: Europe, Canary Island, N. Africa and Asia.

3.3 DISCUSSION

There are examples within the SEM survey of Libyan seed morphology which are very relevant to some taxonomic problems at the subspecies, species, generic and subfamily/ family levels. At the infraspecific level *Silene apetala* and *Silene colorata* subspecies *colorata* are good cases, as are *Arenaria serpyllifolia* and *Sagina apetala*. For species, the endemic taxa of *Silene* are especially good, as is the *Stellaria media* group. At the subfamily level the precise rank of Paronychioideae and the family position of the genus *Telephium* have long been controversial. At the generic level the status of *Gymnocarpos* is considered and *Polycarpon*, *Polycarpaea* and *Robbairea* have been much discussed as has the subgeneric status of *Minuartia geniculata* .

Though not indigenous in Libya *Scleranthus annuus* and *Corrigiola littoralis* have been examined for seed morphology. The seeds are very similar and this has consequences for the tribal divisions.

ARENARIA SERPYLLIFOLIA Group

This group of taxa has been often considered regarding specific or subspecific status. McNeil (1963) regarded seed size as the most satisfactory character separating the tetraploid *A. serpyllifolia* from the diploid *A. leptoclados*, both automatically self-pollinating species. Perring and Sell (1967) used seed characters but not those of the testa to separate the subspecies *leptoclados*, *serpyllifolia* and *macrocarpa* (Lloyd) Perring & Sell. In the first edition of *Flora Europaea* *A. serpyllifolia* and *A. leptoclados* are treated as species but in the second edition they are regarded as subspecies. Greuter *et al.* (1984) recognised as species the following in the Mediterranean area. *A. argaea* Rech. fil., *A. leptoclados* (Reichenb.) Guss., *A. marschlinsii* Koch, *A. ? minutiflora* Loscos [sic], *A. peloponnesiaca* Rech. fil. and *A. serpyllifolia* L. For Britain Stace (1991) accepts subspecific status: *serpyllifolia*, *leptoclados* (Reichenb.) Nyman and *lloydii* (Jordan) Bonnier (*A. macrophylla*). For Libya Abdul Ghafoor lists only *A. serpyllifolia* without any discussion of infraspecific taxa.

Soon after the SEM was available Godeau (1973) published photographs of seeds of Breton origin. On the basis of seemingly only three specimens he considered the value of testa features, including some visible only at x 10,000 or x 30,000; these few observations were scarcely enough to reveal the full range of variation. In his paper on *Arenaria* from the USA Wofford (1981) published an SEM of *A. serpyllifolia* but did not indicate which precise taxon. British, North African and Tenerife material showed that the mid zone cells can vary in shape from more or less isodiametric to

very elongate, even in the seeds from one capsule of *A. serpyllifolia* s.s. However, in most of populations of *A. leptoclados* examined most mid zone cells are narrowly elongate.

The specimen collected by Davis (50344) from Wadi Derna in Cyrenaica is very noteworthy. The specimen is well into the fruiting condition and no petals can be seen. However, it has conspicuously glandular hairiness on the stems, the small leaves and the sepals which are c. 3.5 mm long and narrowly acuminate. These are some of the diagnostic features of *A. minutiflora* Loscos, described from northeastern Spain; see map in Jalas and Suominen (1983). Loscos (1877) in his description of the taxon made no mention of seed characters. Lindberg (1932) made *A. minutiflora* a subspecies of *A. serpyllifolia* and Monserrat (1981) considered it a subspecies of *leptoclados*. Jahandiez and Maire (1934) listed it from Morocco, Ozenda (1977) from Algeria and Maire (1963) gave all of these countries and added Libya. Maire treated *A. serpyllifolia* as having 3 subspecies. These are *typica* (with two varieties), *leptoclados* (also with two varieties) and *minutiflora*. Like Maire Greuter *et al.* (1983) listed Algeria, Libya, Morocco and Tunisia but the species *minutiflora* is qualified by an interrogation mark. In *Flora Iberica* Catroviejo *et al.* (1990) lumped *A. minutiflora* with subspecies *leptoclados* which is also the treatment in the second edition of *Flora Europaea* .

As made clear in the seed description in 3.2 the seeds of Davis (50344) are highly distinctive in their marked papillae. In the absence of examination of Spanish material and in particular Loscos' type specimen it is not known if the seeds are papillate. Should such seeds prove to be papillate the case for recognition of *minutiflora* as a distinct taxon would be strengthened.

About 40 sheets labelled *A. serpyllifolia* s.s. and 18 labelled *A. leptoclados* from North Africa, Tenerife and Britain were studied thoroughly. With the use of a scale lupe 10 X, 36 specimens were measured for sepal length, capsule width and seed diameter. These are three of the characters considered important by Stace (1991) for the separation of these two taxa. See tables 3 and 4. These measurements fit Stace's criteria and were assumed to be adequate grounds for the distinction.

Distinct papillae had been noticed on the capsules but the papillae were not uniformly distributed over the capsules in the two taxa. There appears to be a total separation: *A. serpyllifolia* s.s. has the distinct papillae on the capsule body but not on the teeth whereas *A. leptoclados* has the papillae on both the body and the teeth. These characters can be recognised using a dissecting microscope and be seen very clearly in capsule impressions (Plate 47). Furthermore the teeth of *serpyllifolia* are glossier and blunter than those of *leptoclados*. All these characters of the capsule teeth, unremarked by previous authors, were found in all the material examined, whatever the geographical origin. It should be emphasized that fully ripe capsules are necessary for clear observation. A necessary next step would be to consult the type specimens. If that of *A. serpyllifolia* s.s. lacks distinctly papillose teeth and that of *A. leptoclados* has papillose teeth then this would add weight to the recognition of the specific status of the two taxa. Study of these features in other taxa listed in the first paragraph has yet to be carried out.

The capsular teeth of Davis (50344) are papillate right to the apices and this is further confirmation that the specimen is subspecies *leptoclados*, if it does not prove to be a distinct taxon.

Sepal size mm	Seed size mm	Capsule size mm	Capsule feature
± 3.0	0.3 x 0.4	2.5 x 1.2	*
± 2.5	0.3 x 0.4	3.0 x 2.0	*
± 3.0	~	3.0 x 1.9	*
± 3.0	0.3 x 0.4	3.0 x 2.0	*
± 3.0	0.4 x 0.4	3.5 x 1.5	*
± 2.5	0.3 x 0.4	2.5 x 1.0	*
± 3.5	0.3 x 0.4	3.0 x 1.7	*
± 3.0	0.4 x 0.4	3.0 x 1.8	*
± 3.5	0.3 x 0.4	2.5 x 1.1	*
± 3.0	0.3 x 0.4	3.0 x 1.4	*
± 2.5	0.3 x 0.4	3.0 x 2.0	*
± 3.0	0.3 x 0.4	3.0 x 2.0	*
± 3.0	0.3 x 0.4	3.0 x 2.0	*
± 4	0.4 x 0.5	3.0 x 2.0	*

Table 3. Measurements of British in (GL) and Mediterranean specimens of *Arenaria leptoclados*.

* = Capsule covered with distinct papillae including the teeth.

~ = No seeds present.

Sepal size mm	Seed size mm	Capsule size mm	Capsule feature
± 3.0	0.3 x 0.4	2.5 x 1.2	+
± 2.5	0.3 x 0.4	3.0 x 2.0	+
± 3.0	~	3.0 x 1.9	+
± 3.0	0.4 x 0.4	3.0 x 2.0	+
± 3.0	0.4 x 0.4	3.5 x 2.0	+
± 3.5	0.3 x 0.4	3.0 x 1.7	+
± 3.5	0.3 x 0.4	3.0 x 1.7	+
± 3.0	0.4 x 0.4	3.0 x 1.8	+
± 3.5	0.3 x 0.4	2.5 x 1.1	+
± 3.0	0.3 x 0.4	3.0 x 1.4	+
± 2.5	0.3 x 0.4	3.0 x 2.0	+
± 3.0	0.3 x 0.4	3.0 x 2.0	+
± 3.0	0.3 x 0.4	3.0 x 2.0	+
± 4.0	0.4 x 0.5	3.0 x 2.0	+
± 3.5	0.5 x 0.6	3.5 x 2.5	+
± 3.5	0.5 x 0.6	3.5 x 2.0	+
± 4.0	0.5 x 0.6	3.5 x 2.0	+
± 3.5	~	3.5 x 2.5	+
± 3.0	~	3.5 x 2.5	+
± 3.0	0.5 x 0.6	3.0 x 2.0	+
± 4.0	0.5 x 0.6	4.0 x 2.5	+
± 4.0	0.5 x 0.6	3.5 x 2.5	+

Table 4. Measurements of British in (GL) and North African specimens of *Arenaria serpyllifolia*.

+ = Capsule covered with distinct papillae except the teeth .

~ = No seeds present.

SAGINA APETALA Group

There has been much discussion of infraspecific taxa. The first edition of *Flora European* gives subsp. *apetala* (*S. ciliata* Fries) and subsp. *erecta* (Horneman.) F. Hermann (*S. apetala* auct.). The second edition adds (p. 178) "Intermediates..... are not uncommon, especially in the Mediterranean region where the subspecific distinction is difficult to maintain." In *Flora of Turkey* there had already been the statement (p.92) as follows: "The differences between *S. apetala* and *S.ciliata* are inconstant, and the two cannot be maintained as separate taxa. Stace (1991) recognised the two subspecies but then adds (p. 208) "Possibly these 2 ssp. should be recognised as 2 or 3 vars". None of these works makes any detailed reference to seeds and certainly not to testa micromorphology.

Crow (1979) produced SEM of seeds of 15 species of the genus from North America, Europe and eastern Asia. He included *S. apetala* Ard. (two separate collections from California) but he made no mention of infraspecific taxa. However, he showed SEMs of papillate and non-papillate seeds. The description given in 3.2 deals with non-papillate seeds from Libya, Morocco and Afganistan which closely resembles that in Crow, Fig. 3 d.

Material from high altitude on Tenerife gathered by J. H. Dickson and C. Rodriguez Pinero has markedly papillate seeds (Plate 20). The papillae are sparse but prominent on the lateral face and, in that, the seeds are similar to the seed of the second Californian material illustrated by Crow. It is clear that the seeds of *S. apetala sensu lato* are variable but whether this variation relates discretely to particular infraspecific taxa remains to be seen.

SILENE APETALA

Silene apetala is a polymorphic species; Maire (1962) listed four varieties and four forms. This polymorphism is clearly shown by the marked differences in testa ornamentation in the specimens from different localities in Libya. Most of the specimens examined have the ornamentation of the kind here designated morphotype A (Morocco, Algeria and Libya). The two other morphotypes, B and C, have been encountered in a few specimens, all from Libya, (Plates 23, 24). It may be that the full range of variation in testa micromorphology has not yet been found. Much more work would be needed to formalise this variation taxonomically, if indeed it proved possible.

SILENE ARTICULATA AND S. GALLICA

Silene articulata is an endemic species in Libya. It was treated in many sources as a variety of *Silene gallica*, e.g. Durand and Barratte (1910) and Keith (1965) and as a separate species in other sources e.g. Corti (1942), Maire (1963) and Abdul Ghafoor (1978). Durand and Barratte attached importance in separating var. *articulata* from *S. gallica* on calyx length. Abdul Ghafoor gave differences in carpophore length. In specimens 494 to 496 (Appendix II) and 533 to 539 (Appendix II) the calyx measures 13-15 mm. In var *articulata* the seeds are reniform 1.4 X 1.6 mm, with undulate wings, and in *S. gallica* the seeds are reniform 0.5 x 0.9 mm, without wings.

The difference in seed shape between these two species can be recognised very quickly even without a hand lens. The SEM pictures show great differences, particularly in shape, size and ornamentation of the lateral and marginal face cells as listed in 3.2. Thus, it seems reasonable to claim that the seed results obtained in the present study support the separation of *S. articulata* from *S. gallica* . On the other hand it is worth

pointing out that the seed shape and testa features of *S. gallica* resemble those of *S. nocturna* and *S. cerastoides* and those of *S. articulata* resemble *S. apetala*, *S. colorata* and *S. cyrenaica*.

SILENE CYRENAICA AND S. COLORATA

Silene cyrenaica is another endemic species in Libya and like *S. articulata*, it has been given different ranks. It is very closely related to *S. colorata*. It was treated as a variety of *S. colorata* by Durand and Barratte (1910) but it was classified as a separate species in Corti (1942), Maire (1962), Keith (1967) and Abdul Ghafoor (1978). These two have been recognized as separate species on the basis of floral morphological characters as given by Abdul Ghafoor (1978).

+Flowers in helicoid cymes with zigzag axis.

Calyx antrorsely appressed hairy throughout.....*S. cyrenaica*.

- Flowers in scorpioid cymes, axis not zigzag.

Calyx antrorsely appressed hairy on nerves alone.....*S. colorata*.

The descriptions of the seeds of these two species were given in *Flora of Libya* as follows. *S. colorata*, "seeds rounded-reniform, 1-1.5 mm long, dark brown, faces plane and smooth to somewhat tuberculate, deeply grooved with 2 undulate or wavy wings". *S. cyrenaica*, "seeds rounded-reniform, c. 2 mm long, faces plane, back grooved with 2 undulate wings". However, Maire (1963 p.112-115) described these species as follows.

S. colorata "seeds many, dark chestnut brown or dark brown-black, round-reniform, very compressed, 1.3-1.8 mm long, slanted, with undulate wings, faces plane or slightly concave, with very fine radiate striation, sometimes with a few papillae on the surfaces" and *S. cyrenaica* "seeds many, brown-black, round-reniform, c. 2 mm long, very compressed, with subplane faces, smooth, at back slanted, with undulate wings, elegantly

striated radially, With papillae in rows”.

Abdul Ghafoor (1978 p. 75) said “ [*Silene colorata* is] a very common and widely distributed species, very variable in habit, hairiness, calyx length and petal colour. These characters have insufficient correlation, at least in our area, and hence no infraspecific taxa are worth recognizing here”. According to the material studied now which was collected from Libya in 1939 and 1952, and some more recently, there appear to be two different types of seeds belonging to the infraspecific taxa *S. colorata*, subsp. *colorata*, and subsp. *trichocalycina* Fenzl., var. *lasiocalyx* S.-W. & Godr. The separation between subspecies and varieties of *S. colorata* are based on the presence or absence of hairs on the calyx and seed characters (Maire, 1963). Seed features separate these infraspecific taxa and *S. cyrenaica* as follows.

1A. All lateral face cells with clear sinuate margins.....subsp.

trichocalycina...var. *lasiocalyx*.

1B. Many lateral face cells lacking sinuate margins, mostly with straight or slightly sinuate margins.

2A. Undulate wing cells, in indistinct rows and with blunt warts....subsp.

colorata.

2B. Undulate wing cells in distinct rows and with conspicuous

warts.....*S. cyrenaica*.

The shape of the seeds and the SEM observations show very considerable similarities between *S. cyrenaica* and *S. colorata* subsp. *colorata*. Therefore the micromorphological characters, being only two (wing cell arrangement and ornamentation) give little help in separating these taxa and might be taken as supporting only subspecific rank for *S. cyrenaica*.

SILENE MARMARICA AND S. ITALICA

Silene marmarica is the third endemic species of *Silene* in Libya. It is treated as a separate species by authors such as Pampanini (1931), Corti (1942), Maire (1962), Abdul Ghafoor (1978) and Greuter *et al.* (1984). This plant is distributed in only one region, Cyrenaica. The seeds show very great resemblance to those of *S. italica* which has been reported by Maire (1963) from Cyrenaica. The seeds of these two species are alike in the broad reniform to fan-like shape and the lateral faces being plane with cells arranged in regular rows with distinct spurs and globular pads. The difference between these two taxa lies in the lateral face cells which are mostly elliptic and papillate in *S. italica* and elongate and smooth in *S. marmarica* (Plates 27,28). It appears therefore that use of (SEM) to reveal testa features can aid identification of these closely related species and supports specific rank for *S. marmarica*.

STELLARIA MEDIA GROUP

The taxonomy and nomenclature of the *Stellaria media* group has caused much discussion for many years and in Libya, as elsewhere, different authors have advocated its division into different taxa. Just before SEM was available, Whitehead *et al.* (1967) in a detailed morphological study, considered that seed length and weight, length of testa tubercles and pollen diameter were the most important characters in separating the three species *Stellaria media*, *Stellaria pallida* and *S. neglecta*. Using SEM, Morton (1972) discussed the differences in seed morphology particularly in the separation of North American *S. media* and *S. pallida*. He showed marked differences between the seeds of these species, particularly the tubercles and cells of the midzone area.

Berggren (1981) provided a key for the three species based on seed size and ornamentation. Stamen number and seed size are the best characters to separate *S. media* and *S. neglecta* according to Stace (1991). In the most recent assessment, the second edition of *Flora Europaea* recognised *S. media* (with two subsp.), *S. neglecta* and *S. pallida*. For the separation of the three species and of the subspecies of *S. media* seed size and colour as well as tubercle shape are used.

With regard to Libya, Durand and Barrate (1910) mentioned some characters including smallness of seeds and followed by Corti (1942) recorded only one species *S. pallida* (as *S. apetala* Ucria) from different localities. In the *Flora of Libya*, however, Abdul Ghafoor (1978) took a very wide view of *S. media*, incorporating both *S. pallida* and *S. neglecta*. Greuter *et al.* (1984) listed the presence of just one species of *Stellaria* in Libya namely *S. pallida* (Dumort.) Pire. By using light microscopy and SEM, two species are now confirmed in Libya, one is *S. media* subsp. *media* and the other is *S. pallida*. This separation was based initially on morphological characters particularly, the sepal length, stamen number, and presence or absence of petals. The new (SEM) pictures show marked characters of the seeds to distinguish the two species (Plates 16,17).

Minuartia geniculata* and Status of *Rhodalsine

McNeill (1962 p.135) discussed the geographical distribution and variation of the species *Minuartia geniculata* as follows " plants of subgenus *Rhodalsine* are common throughout the more southerly Mediterranean coasts extending to Portugal and the Canary Islands and with a distinctive species in Somaliland. Throughout the greater part of its range, however, the subgenus is only represented by one rather variable species for which *M. geniculata* is the correct name". This species has a variable leaf shape,

size and pubescence (*Flora Europaea* ; Abdul Ghafoor,1978).

McNeill and Bassett (1974) made a thorough study of the pollen morphology of *Minuartia* with the aim of elucidating the position of *M. geniculata*, one of four species in subgenus *Rhodalsine*. The pollen of that species differed from that of all other species of the subfamily Alsinoideae but resembled that of *Spergularia* of subfamily Paronychioideae. *M. geniculata* and *Spergularia* share similarities of habit and petal colour and the subgenus had formerly been regarded as a genus by Gay (1845) and Williams (1898). Despite their findings McNeill and Bassett rejected the transfer of *M. geniculata* to the *Spergularia* but thought that the case for raising the subgenus to generic status was strong. Greuter *et al.* (1984) accept the generic status of *Rhodalsine*. MacNeill and Bassett were aware that the seeds of *M. geniculata* resemble those of other species of the genus *Minuartia*. The SEM survey of specimens from Libya, Morocco and Spain makes this point very clearly but it does show a certain polymorphism if only in the amount and arrangement of warts and perhaps also in the size of testa cells showing differences between Libyan material and that from other countries.

Polycarpon, Polycarpaea and Robbairea

Polycarpaea and *Robbairea* are very closely related genera. The characters used for their separation differ from one Flora to another, e.g. bracts and stipules with or without a thick green midrib, and glabrous or hairy plants. Zohary (1966, vol.I p. 128) mentioned this resemblance “[*Robbairea*] resembling *Polycarpaea* but differing from it mainly by the clawed petals and absence of staminodes”. *Robbairea delileana* was listed under the genus *Polycarpaea* as *P. prostrata* (Oliver, 1868); *Med-checklist* gives *Robbairea delileana* as *Polycarpaea robbairea* (Greuter *et al.*, 1984)

but other Floras accept the separate genus *Robbairea* (Post, 1883; Tackholm, 1974; Abdul Ghafoor, 1978; Hazim and Daoud, 1985). The genus *Robbairea* may be considered as linking *Polycarpaea* and *Polycarpon*. Post (1883, p. 158-159) mentioned the resemblance of *Robbairea* to *Polycarpon* by describing the former as “Herbs resembling *Polycarpon*” and he described *Polycarpaea* as having “seeds pear-shaped, somewhat incurved - Herbs or shrubs, resembling *Polycarpon*”. Pax (1889) in *Pflanzenfamilien* divided the genus *Polycarpon* into two sections (*Eupolycarpon*, *Robbairea*) and genus *Polycarpaea* into three sections (*Aylmeria*, *Polycarpia*, *Planchonia*), whereas Pax and Hoffman (1934) classified *Polycarpon* as a single genus but they divided *Polycarpaea* into four sections (*Aylmeria*, *Polycarpia*, *Robbairea*, *Planchonia*). Recently Bittrich (1993) has listed the two genera *Polycarpon* and *Polycarpaea* in his classification but he did not accept the genus *Robbairea*.

Seeds of six species of *Polycarpaea* were studied morphologically by using light microscopy and SEM. Five of them are endemic species from Tenerife (*P. carnosae*, *P. divaricata*, *P. latifolia*, *P. smithii*, *P. tenuis*). Also studied were the Libyan species *Polycarpaea repens*, *Polycarpon prostrata*, *P. tetraphyllum* and *Robbairea delileana*. Seeds of these species show strong similarity in shape, colour and size (Table 5), (Plates 3 to 6). The SEM allow the division of these spp. into two groups on the basis of testa surfaces, the first group *Polycarpaea repens*, *P. carnosae*, *Robbairea delileana* having more or less smooth or slightly wrinkled surfaces. The second group *Polycarpaea divaricata*, *P. latifolia*, *P. smithii*, *P. tenuis*, *Polycarpon prostrata* and *P. tetraphyllum*. has papillate surfaces. This second group can be further divided into two, one with smooth papillae e.g. *Polycarpon prostratum* and *P. tetraphyllum*. and the other with rough

granular papillae e.g. *Polycarpaea divaricata* *P. latifolia*, *P. smithii* and *P. tenuis* . A key was made from the SEM pictures to differentiate between *Polycarpon*, *Polycarpaea* and *Robbairaea* species.

- 1A. Lateral face smooth or wrinkled but not papillate.
- 2A. Lateral face smooth.....*Polycarpaea robbairea*.
- 2B. Lateral face wrinkled.....*Polycarpaea carnososa*, *P. repens*.
- 1B. Lateral face papillate.
- 3A. Lateral face papillae smooth.
- 4A. Papillae on lateral faces dense, mostly of uniform size
.....*Polycarpon prostratum*.
- 4B. Papillae on lateral face more widely spaced, less uniform in size
.....*Polycarpon tetraphyllum*.
- 3B. Lateral faces papillae rough, granular.
- 5A. Papillae very closely spaced.....*Polycarpaea divaricata*.
- 5B. Papillae widely spaced.....*Polycarpaea latifolia*, *P. smithii*, *P. tenuis*

Robbairaea, *Polycarpaea* and *Polycarpon* share a common seed shape. With *Polycarpaea* the testa varies from strongly papillate to somewhat wrinkled . Though much of the testa is smooth, *Robbairaea delileana* has indistinct wrinkles at the hilar end. Therefore there are insufficient seed characters to support the generic status of *Robbairaea*. The strikingly papillate testa of *Polycarpon* is very like those of many species of *Polycarpaea* and so that generic separation is not supported by the seed features. However, without a thorough investigation of all the 50 or so species of *Polycarpaea* and the 16 of *Polycarpon* to suggest lumping these genera would be unjustified.

Species name	Shape	Colour	Size L. x W.	Position R & H.	Lateral face	Dorsal face
<i>Polycarpaea</i>						
<i>caronsa</i>	Elongate	Brown	0.4x0.2	T. V.	Convex	Grooved
<i>divaricata</i>	"	"	0.6x0.3	" "	"	"
<i>latifolia</i>	"	"	0.6x0.4	" "	"	"
<i>repens</i>	O. c.	Creamy	0.8x0.3	" "	"	"
<i>smithii</i>	Cuneate	Brown	0.5x0.3	" "	"	"
<i>tenuis</i>	Elongate	"	0.6x0.3	" "	"	"
<i>Polycarpon</i>						
<i>prostratum</i>	"	Creamy	0.5x0.3	" "	"	"
<i>tetraphyllum</i>	"	"	0.5x0.3	" "	"	"
<i>Robbairea</i>						
<i>delileana</i>	B. e.	"	0.4x0.2	" "	"	"

Table 5. Comparison between, *Polycarpaea*, *Polycarpon* and *Robbairea*, seeds.

O. c. = Oblong curved, B. e. = Broad elongate, H. = Hilum, L. = Length, W. = Width, R. = Radicle, T. = Terminal, V. = Ventral

***Gymnocarpus*: Generic Status**

Bittrich (1993) has incorporated the monotypic genus *Gymnocarpus* into the much larger *Paronychia* with c. 50 spp according to Mabberly (1987). Five spp of the latter have been examined and they proved very alike each other in seed shape, circular to broad elliptic, with an annular embryo according to Abdul Ghafoor, but unlike *Gymnocarpus* which has obovate seeds or in the words of Zohary (1966, p. 129) "oblong-reniform, with a horseshoe-shaped embryo." On this basis bearing in mind that many spp of *Paronychia* remain unexamined the genus *Gymnocarpus* seems worthy of recognition.

TELEPHIUM : Family position

The genus *Telephium* with five species has been treated differently regarding family position by many authors. Bentham & Hooker (1867) placed it in tribe Mollugineae of the Ficoideae. Post (1883) in *Flora of Syria, Palestine and Sinai* placed this genus and the genus *Glinus* in Order Mollugineae (= Molluginaceae). In *Flora of Cyprus* Meikle (1977) listed it under the tribe Telephieae of the family Aizoaceae. But Pax and Hoffmann (1934), Davis (1967) and the second edition of *Flora Europaea* included *Telephium* in subfamily Paronychioideae of Caryophyllaceae.

Meikle (1977) described the seeds of some species of the Aizoaceae including *Telephium imperati*. The testas of these species with their verruculose or papillose cells show marked similarities as described below:

Glinus lotoides : Seeds numerous, reniform, testa rich brown, regularly papillose-verruculose.

Mesembryanthemum nodiflorum: Seeds numerous, reniform, testa rich brown, with distinct, bluntly verruculose dorsal ridges. [Verruculosus = covered with small wart-like outgrowth (Stearn 1993). Meikle is here referring to the overall shape of the testa cells and not the minute granules on the surface.]

Telephium imperati : Seeds compressed-subglobose, testa black or dark brown, closely and regularly verruculose.

In a note Meikle (1977, p. 686) discussed the "obscure" affinities of *Telephium* and stressed the importance of the capsular, many-seeded fruit in putting the genus in the Aizoaceae. Gilbert (1987) mentioned that most authors who consider *Telephium* as belonging to the Caryophyllaceae ignore the 3-4 locular capsules, which are anomalous in that family. Recently Bittrich (1993) explained that "The close relationship of the two

families is also demonstrated by the fact that a transfer of certain genera from Caryophyllaceae (Sub. Paronychioideae) to Molluginaceae has occasionally been proposed, recently by Gilbert (1987) for *Telephium* and *Corrigiola*. Both genera show a reduction of the septa although only in the upper part of the ovary in *Telephium*, and perigynous flowers, if weakly in *Telephium*, and lack the bar-like thickenings in the endotegmic walls. Therefore, a transfer would markedly increase the heterogeneity of the Molluginaceae. Unfortunately, the sieve element plastids, which could provide important evidence for or against an inclusion of *Corrigiola* and *Telephium* in Caryophyllaceae, have not been studied yet". However, Behnke (1994, p.107) examined these plastids and considered that their size (average diameter 0.77 μm) and their polygonal crystals fit these two genera into the Caryophyllaceae. Although Hoffman (1994, p.132) indicated that "*Telephium* lacks the thickened and lignified apical ovary walls of most Caryophyllaceae", she stated (p. 164) "The ontogeny of the androecium clearly represents a variant of the caryophyllaceae pattern, similar to that of *Drypis*. Therefore, *Telephium* and *Corrigiola* belong to the Caryophyllaceae."

Telephium sphaerospermum with its globular and carunculate seeds and regular distinctive testa cells differs from all other species of the Caryophyllaceae of whatever subfamily. The genus *Vaccaria* has globular seeds as do some other small genera such as *Pleineuria* and *Ochotonophila* and species of *Silene* such as *S. pendula* and *S. pseudoatiocion* have subglobular seeds. However in these cases and certainly in *Vaccaria* and *Silene* the testa cells are obviously of the types characteristic of the Caryophyllaceae. The genus *Moehringia* is well known to have carunculate (strophiolate) seeds but again the testa cells are spurred as in so many Caryophyllaceae. Furthermore, the large caruncles

in all the 12 species well illustrated by Pignatti (1982) consist of elongate cells very different from the cells of *Telephium*. The eight Pyrenean species of *Petrocoptis* have large caruncles in the form of tufts of hairs, again very unlike *Telephium*.

This distinctive combination of seed characters supports the removal of *Telephium* from the Caryophyllaceae. However, not all the species of *Telephium* have globular seeds. Bittrich (1993, p. 225) describes the seeds of *Telephium* as "globular to reniform." There is a fine drawing of a seed of *T. imperati* L. in Castroveijo *et al.* (1990, p.102) and the seeds are described as "ovaod-reniformes finamente granuladas." In his monograph of the genus, Williams (1904) gave brief descriptions of the seeds of four of the species such as that for *T. oligospermum* Boiss." reniform-compressa, punctata vel subtiliter granulata, umbrinia." (p. 301). In order to have the best evidence from the seeds, all five members of the genus will need to be examined by SEM. Only then would be made a case for or against removal of the genus from the family be strongest.

Subfamilies

As outlined in Chapter 1 the subdivision of the Caryophyllaceae has long been controversial, particularly the status of subfamily Paronychioideae.

The subfamily Paronychioideae is separated from the other subfamilies mostly by the presence or absence of stipules. A typical key to the subfamilies is that of Komarov (1936, p.297).

- 1- Leaves stipulate.....Subfamily Paronychioideae
- + Leaves exstipulate.....2
- 2- Sepals free or, if sometimes to the middle, then perianth
singleSubfamily Alsinoideae

+ Calyx always with connate sepals, often tubular; perianth

always double.....Subfamily Silenoideae

All the previous authors rely heavily on macromorphological characters of vegetative and reproductive organs in their subdivisions and keys and they have often ignored the importance of seeds. In his subfamily diagnosis Bittrich (1993) makes no mention of seed characters.

Seed shape. The reniform shape of the seeds of many members of the Caryophyllaceae was commented on as early as Linnaeus. This shape and variations of it, with a vertical plane of symmetry through the centre of the concave (or notched) and convex margins, is typical of the large genera *Silene*, *Arenaria*, *Stellaria*, *Minuartia* and *Cerastium* as well as many small genera of the Caryophylloideae and Alsinoideae. However, a strictly reniform shape does not occur in the Paronychioideae as represented by the genera studied in this thesis. In considering the shapes of the seeds it is most important to understand the significance of the position of the hilum. In the vast majority of the species within the Caryophyllaceae *sensu lato* the hilum is symmetrically placed at the deepest part of a more or less distinct hilar notch so that it often appears sunken. This is a statement which pertains particularly to the subfamilies Alsinoideae and Caryophylloideae and not to the subfamily Paronychioideae in which the hilum is more or less superficial (and never appears sunken) and is asymmetrically placed as seen

in the outline drawings of Fig. 2.

There are a few exceptions to this generalisation. *Dianthus* and closely related genera are very distinct in being dorsiventrally flattened and in these genera the hilum is superficial but symmetrically placed. *Vaccaria* also has a superficial hilum and is unusual in the globose shape of its seeds. In Alsinoideae *Sagina* cannot be said to have a notch but the hilum is almost centrally placed on the concave margin. In Paronychioideae the hilum may appear in some cases to be in a very shallow groove but this groove runs along the ventral face and not across it as does the hilar notch of the Caryophylloideae and Alsinoideae.

Seed Size. The seeds were placed into three categories: less than 1mm, 1-2 mm and more than 2mm. All the members of Alsinoideae studied here fall into the smallest category. Only a few species of the other two subfamilies have seeds in the largest and in the Libyan flora *Dianthus crinitus*, *Pteranthus dichotomous* and *Sclerocephalus arabicus* are examples.

Seed Colour and Lustre. So many members of Paronychioideae have glossy seeds that this feature can be considered characteristic of the subfamily. Glossiness, however, is not

exclusive to that subfamily. In Alsinoideae some species of *Minuartia* and the monotypic *Honkenya* have shiny seeds. No particular colour can be thought of as so typical of any subfamily as to be important. Brown, orange and black occur in all the subfamilies. Black or dark brown is characteristic of *Dianthus* and related genera, as has often been stated. The seeds of *Loeflingia hispanica* have a very distinct greyish white colour, and *Pteranthus dichotomus* is utterly different from all other species in the Libyan flora in its dark brown spot centrally placed on the dorsal face. Meikle (1977, p. 285) describes this feature as " a very prominent red blotch on one side of the seed". The non-Libyan *Scleranthus annuus* has yellowish seeds with a brown spot at the base of the radicle.

Lateral Faces. Features of the lateral faces have been dealt with in detail in section 3.2.2. In the Paronychioideae and Alsinoideae these faces may be plane or convex but never strongly concave, unlike the Caryophylloideae. In the latter subfamily there are all types of face including the deeply concave as in *Silene*; see Plates 31 (1), 27 (3) and 30 (6). In *Petrorhagia* the dorsal face can be strongly convex and the ventral face strongly concave as in *P. velutina*; see Plate 23 (3,5). In the Paronychioideae as shown in Plates 1 to 11, a more

or less clearcut groove separates the lateral and marginal faces or runs along the dorsal face. This is particularly obvious in *Spergularia* (Plate 1,4), in *Sclerocephalus* Plate 7 (3), in *Paronychia* Plate 8 (1), in *Herniaria* Plate 8 (7) and in *Polycarpaea* Plate 3 (5). The groove is discernable even if only faintly in all the other examples displayed, except *Pteranthus* which is dorsiventrally compressed.

Testa Cell Shape. In Paronychioideae these are smooth, particularly in tribe Paronychieae. The cells may appear wrinkled or very faint. In a few genera the cells may have jigsaw-like shapes e.g. *Spergularia*, Plate 2 (2). *Telephium* with its globular cells is very distinct, Plate 12 (40). In the other two subfamilies the cells are almost always very distinct and often in more or less concentric rows. Good examples of concentric, predominantly uniform, cells whether long or short are round in *Arenaria*, Plate 13 (3,4), *Cerastium*, Plate 14 (5,6), and *Minuartia*, Plate 17 (7,8). The cells can be of mixed shapes as in *Arenaria*, Plate 13 (2), *Cerastium*, Plate 15 (4), *Minuartia*, Plate 17 (5,6), *Silene*, Plate 28 (1,2), and *Petrorhagia*, Plate 23 (1,2). The cells can be few in number as in *Sagina*, Plate 20 (3), *Silene*, Plate 29 (7) or a much greater number as in *Cerastium*, Plate 15 (3), *Vaccaria*, Plate 22 (1) and *Silene*, Plate 26 (5). Exceptionally the cells the testa are smooth as in *Silene succulenta*.

Spurs. These are universal in Alsinoideae and Caryophylloideae. They can be long or short and even very short. Particularly well developed spurs are found in *Arenaria*, Plate 13 (2), *Stellaria*, Plate 15 (8), *Minuartia*, plate 17 (6), *Sagina*, Plate 20 (4), and *Silene*, Plate 28 (2). By contrast in Paronychioideae spurs are absent from tribe Paronychieae and only present in some members of tribe Polycarpeae especially *Spergula*, Plate 1 (2).

Papillae, Tubercles and Warts. These ornamentations are lacking altogether from the seeds of Paronychioideae, tribe Paronychieae. In tribe Polycarpeae conspicuous if sparse papillae are found in *Spergula* and *Spergularia* and very well ornamented, numerous papillae occur in *Polycarpea*. However, no warts occur in these genera nor is there ever the development of large conspicuous tubercles as, for instance, in *Stellaria*.

Pads. This remarkable feature is to be seen only in *Silene* not in any other genus in any subfamily. This permanent character can be useful as a good taxonomic tool at the specific and subspecific levels; see Plate 25 (2), 27 (5,7), 28 (5,8).

Marginal face. In Paronychioideae, tribe Polycarpeae the marginal face differs strongly in morphology: broad e.g. *Spergularia*, Plate 1 (7) and *Loeflingia*, Plate 6 (7), or expanded into a membranous wing e.g. *Spergula*, Plate 1 (1), or with a deep narrow furrow in the dorsal face e.g. *Polycarpaea*, Plates 3 (5) and 4 (8). However, in tribe Paronychieae the marginal face has

only two types, broad e.g. *Pteranthus*, *Sclerocephalus* and *Gymnocarpus*, Plate 7 (1,3 and 6) or strongly compressed e.g. *Herniaria*, Plate 10 (3), and *Paronychia*, Plate 9 (6). In subfamilies Alsinoideae and Caryophylloideae the marginal face has a variety of shapes: convex e.g. *Arenaria*, Plate 13 (7), *Cerastium*, Plate 14 (1), *Sagina*, Plate 20 (1), and *Silene*, Plates 30 (4) and 31 (5), concave in *Cerastium*, Plate 14 (5), *Minuartia*; Plate 18 (7), and *Silene*, Plate 29 (2). Strongly concave marginal faces extended into undulate but not membranous wings are found only in *Silene* e.g. Plate 23 (7) and 27 (5). The marginal cells in these two subfamilies are arranged mostly in regular rows, with cells similar to or different from the cells of the lateral face, see Plates 19 (9), 29 (4), 30 (2), and 21 (4).

Radicle. The radicle is the embryonic first root of a seed. Its tip lies immediately below a more or less distinct pit on the testa called the micropyle. In this study it is the prominence and shape of the radicle, without the removal of the testa, that has been considered. In the Paronychioideae the radicle is very prominent, straight and pointed in *Sclerocephalus* but very prominent radicle usually curved, also occur in Alsinoideae (some species of *Minuartia*) and in Caryophylloideae (*Gypsophila* and *Dianthus*). Because of the collar cells e.g., Plates 6 (7), 8 (6), and 11 (5,6), the micropyle has a clearcutness in *Herniaria*,

Paronychia and *Loeflingia* which is never the case in the other two subfamilies which lack collar cells.

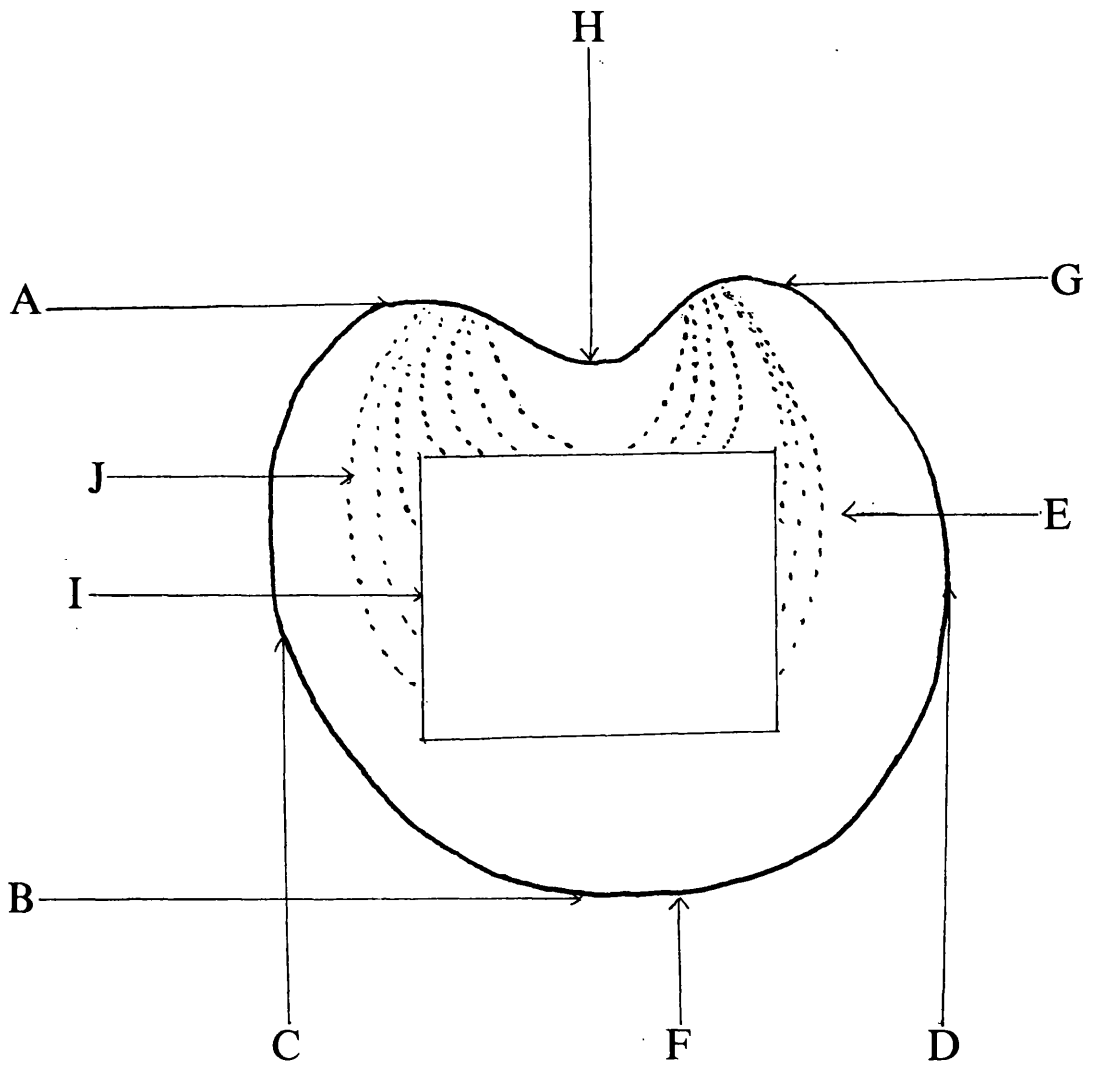

Fig 1. A-B = Length of a seed, C-D = Width of a seed,

E = Lateral face, F = Marginal face, G = Radicle ,

H = Hilum, I = Particular place of lateral face investigation

(midzone), J = Concentric arrangement of cells on lateral face.

Fig.2. Range of outline shapes in the Subfamilies of the

Caryophyllaceae. * = Position of the hilum.

Fig.2A. Subfamily Paronychioideae.

A = Broadly elliptic e.g. *Paronychia chlorothyrsa*.

B = Broadly elongate e.g. *Polycarpaea robbairea*.

C = Circular e.g. *Paronychia arabica*

D = Circular-obovate e.g. *Herniaria glabra*.

E = Crescent-shape e.g. *Polycarpaea repens*.

F = Cuneate e.g. *Polycarpon prostratum*.

G = Globose e.g. *Telephium sphaerospermum*.

H = Obovate e.g. *Spergularia salina*.

I = Narrow-obovate e.g. *Pteranthus dichotomus*.

Fig.2B. Subfamily Alsinoideae.

A = Broadly-cuneate e.g. *Cerastium glomeratum*.

B = Circular-reniform e.g. *Stellaria media* subsp. *media*.

C = Circular-obovate e.g. *Stellaria media* subsp. *cupanina*.

D = Circular-retortiform e.g. *Minuartia mediterranea*.

E = Elliptic-retortiform e.g. *Minuartia hybrida*.

F = Elongate-reniform e.g. *Sagina apetala*.

G = Reniform e.g. *Minuartia geniculata*.

H = Retortiform e.g. *Minuartia campestris*.

I = Triangular-reniform e.g. *Sagina maritima*.

Fig.2C. Subfamily Caryophylloideae.

A = Broadly-elliptic e.g. *Dianthus crinitus*.

B = Circular-reniform e.g. *Gypsophila elegans*.

C = Globose e.g. *Vaccaria hispanica*.

D = Reniform e.g. *Silene cerastoides*.

E = Triangular-reniform e.g. *Agrostemma githago*.

Fig.2A.

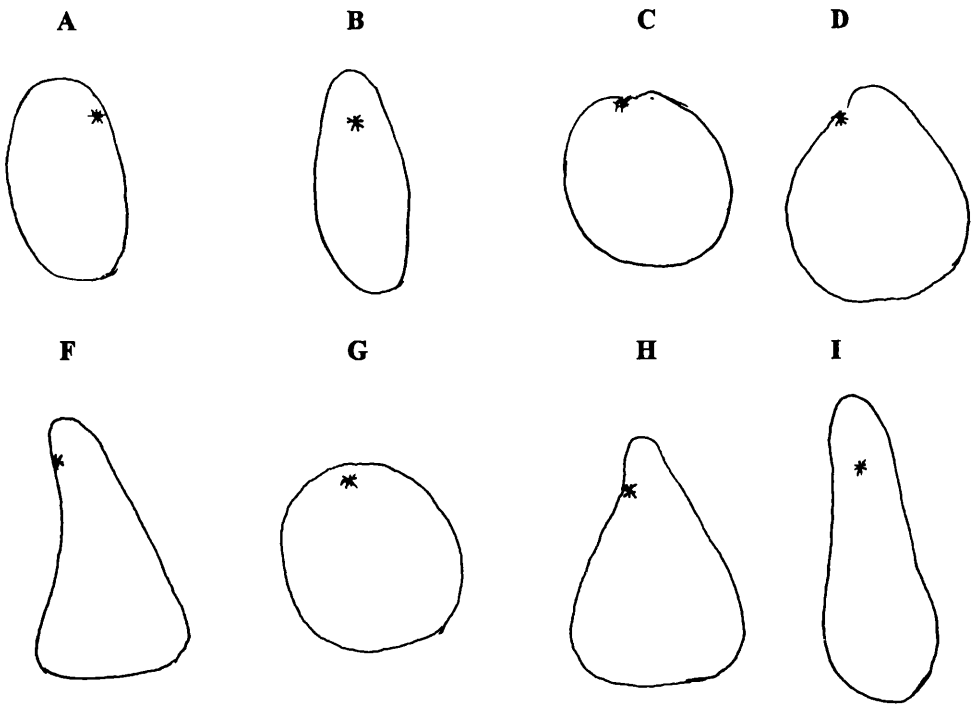

Fig.2B

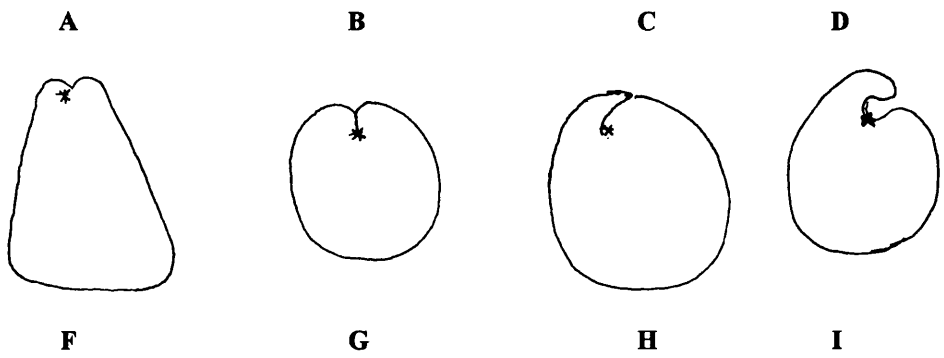

Fig.2C.

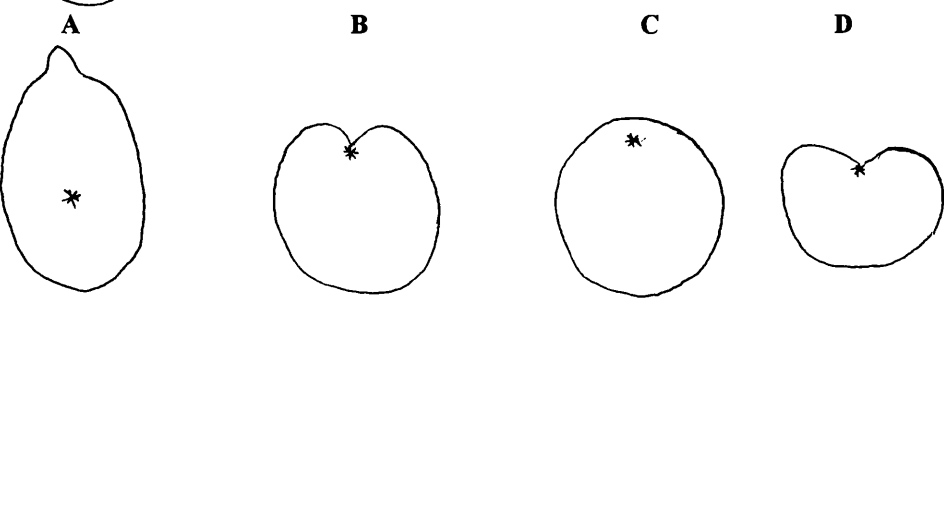

Fig.3. Range of radicle outlines in the Subfamilies of the Caryophyllaceae.

Radicle shown by shading.

Fig.3A. Subfamily Paronychioideae.

A = e.g. *Herniaria glabra*.

B = e.g. *Loeflingia hispanica*.

C = e.g. *Paronychia argentea*.

D = e.g. *Pteranthus dichotomus*.

E = e.g. *Sclerocephalus arabicus*.

F = e.g. *Telephium sphaerospermum*.

Fig.3B. Subfamily Alsinoideae.

A = e.g. *Cerastium pumilum*.

B = e.g. *Minuartia campestris*.

C = e.g. *Sagina apetala*.

D = e.g. *Stellaria media*.

Fig.3C. Subfamily Caryophylloideae.

A = e.g. *Dianthus crinitus*.

B = e.g. *Gypsophila elegans*.

C = e.g. *Silene conoidea*

D = e.g. *Vaccaria hispanica*.

Fig.3A.

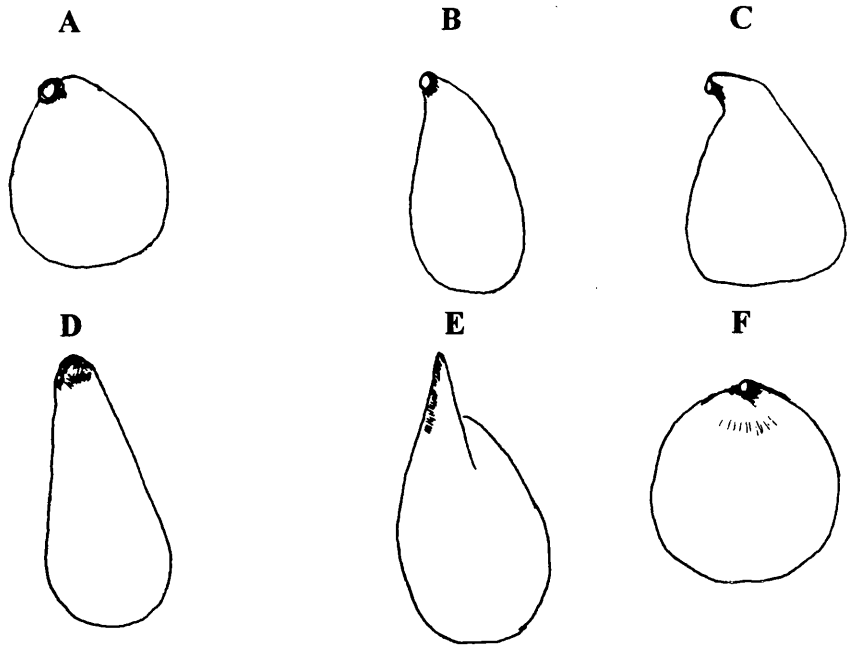

Fig.3B.

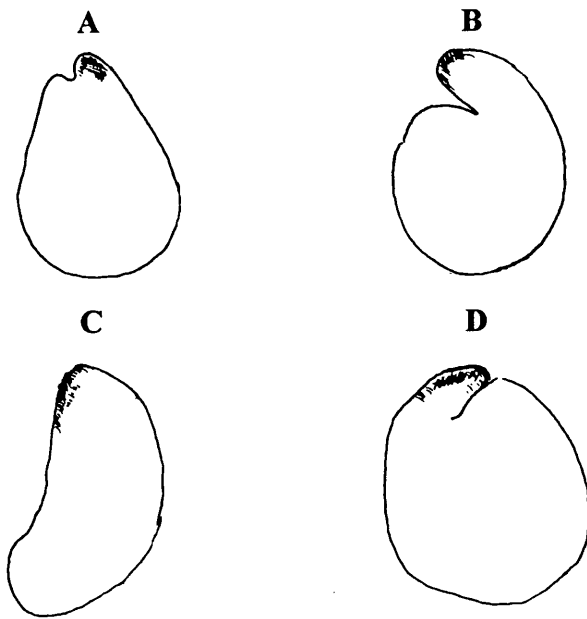
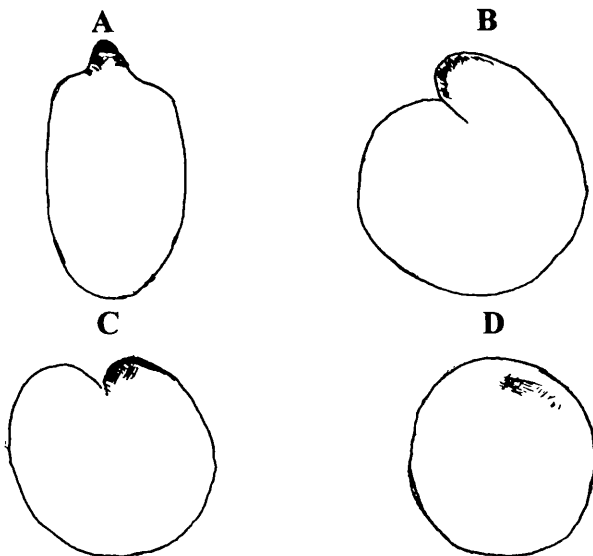

Fig.3C.



LIST OF PLATES

The plates from no. 1 to 31 are SEMs of the seeds showing details of the testa ornamentation located near the midzone of the lateral face, the marginal face, the radicle and the hilar notch as following.

PLATE 1.

1. *Spergula fallax* whole seed.
2. „ „ lateral face (midzone).
3. „ „ near the wing.
4. *Spergularia bocconii* whole seed.
5. „ „ lateral face (midzone).
6. „ „ near the hilum.
7. *Spergularia diandra* whole seed.
8. „ „ lateral face (midzone).
9. „ „ near the hilum.

PLATE 1.

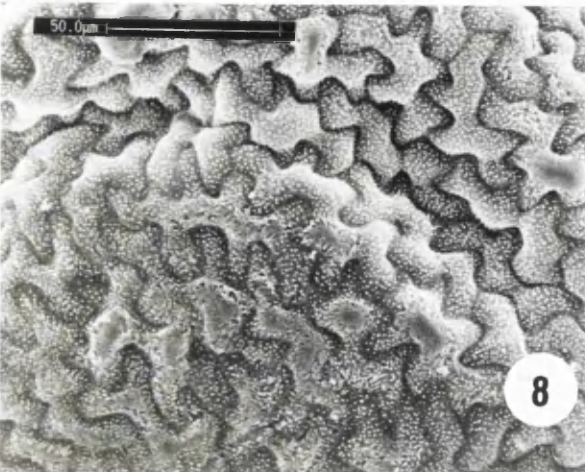
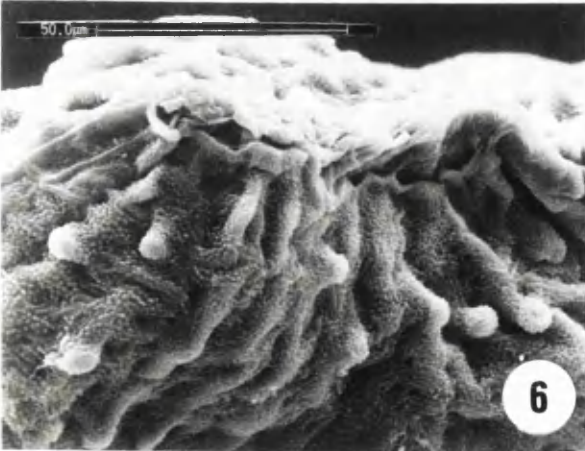
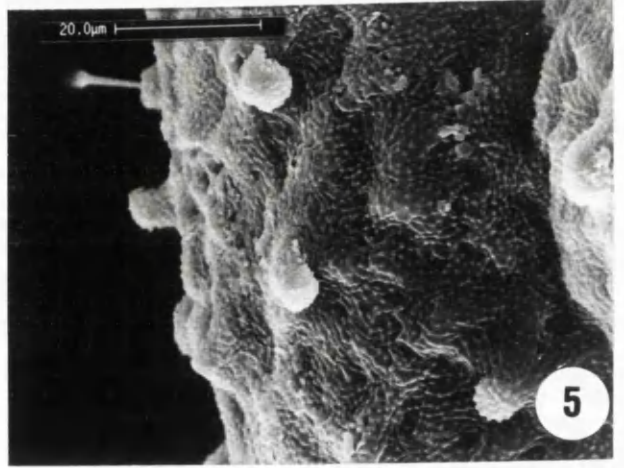
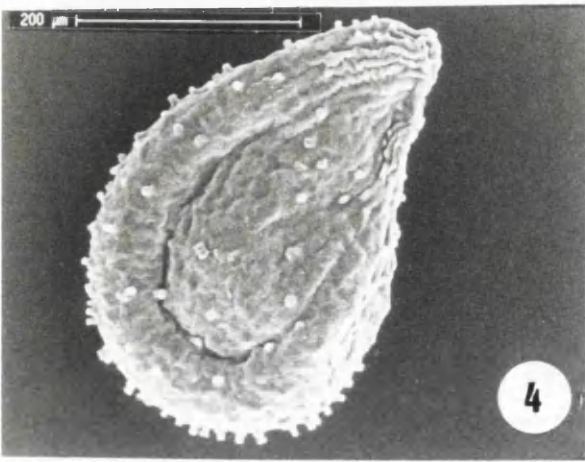
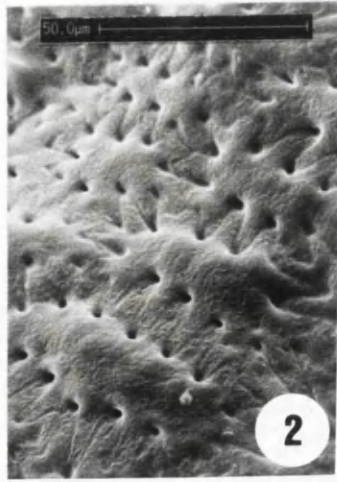
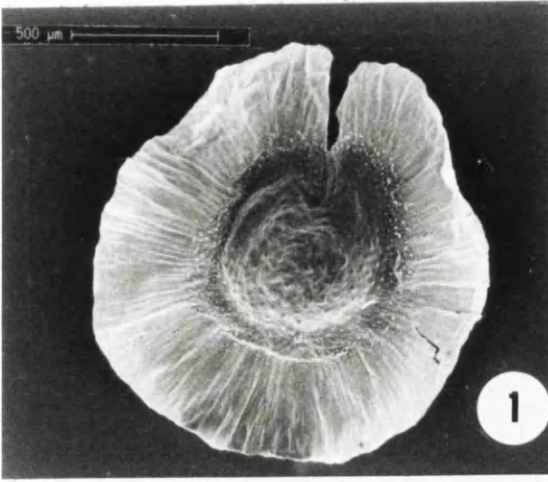

PLATE 2.

1. *Spergularia maritima* whole seed.
2. „ „ lateral face (midzone).
3. „ „ near the marginal face and the wing.
4. *Spergularia rubra* whole seed.
5. „ „ lateral face (midzone).
6. *Spergularia salina* (winged seed) whole seed.
7. „ „ lateral face (midzone).
8. „ „ near the marginal face and the wing.

PLATE 2.

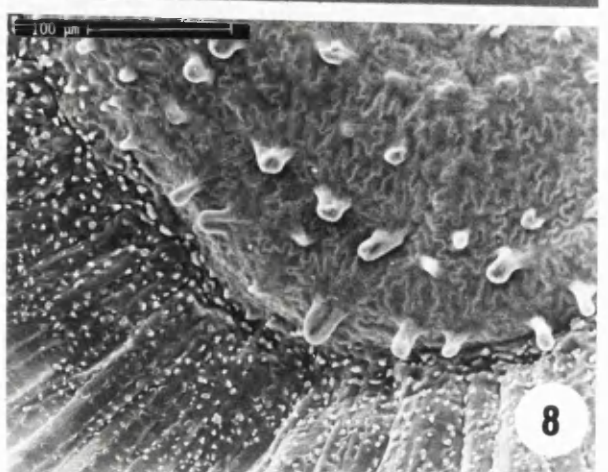
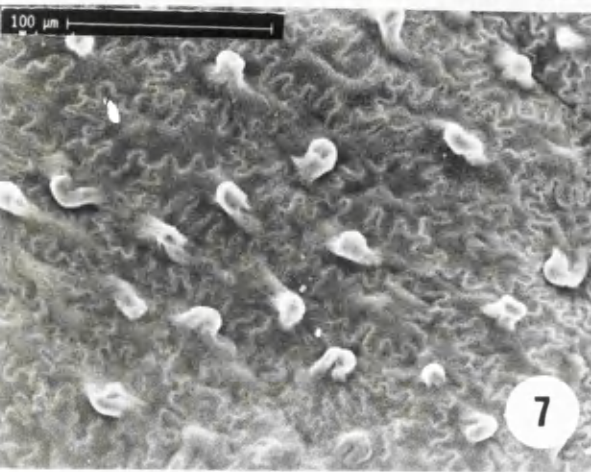
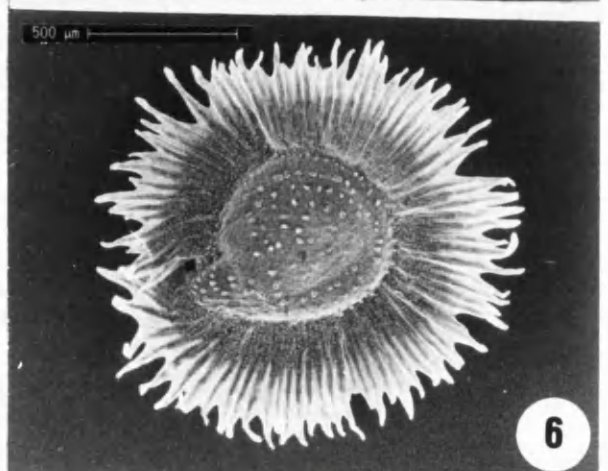
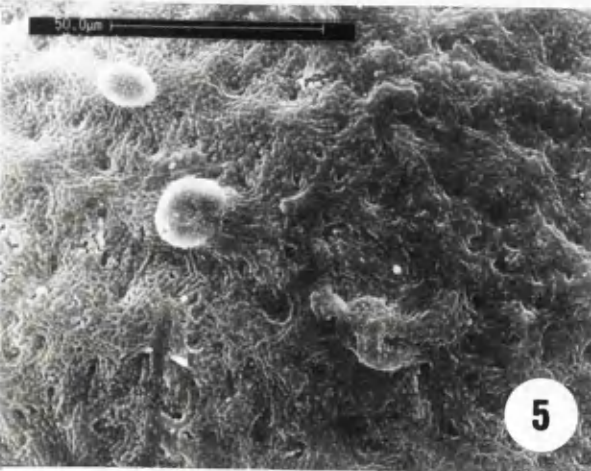
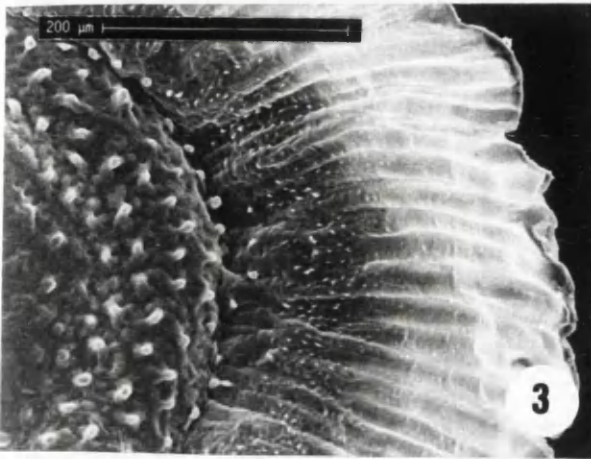
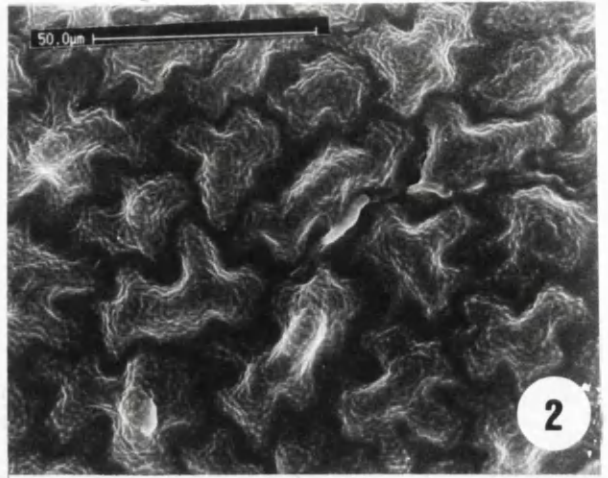
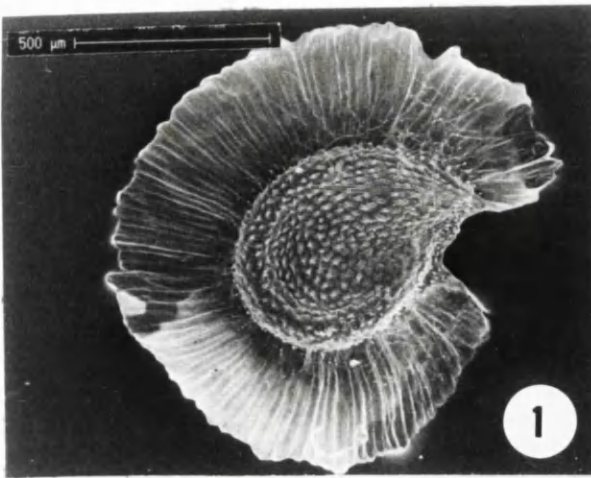

PLATE 3.

1. *Spergularia salina* (without wing) whole seed .
2. „ „ lateral face (midzone).
3. *Polycarpaea carnosae* whole seed, ventral face.
4. „ „ near the hilum and the radicle.
5. „ „ whole seed, dorsal face.
6. „ „ lateral face (midzone).
7. *Polycarpaea divaricata* whole seed.
8. „ „ lateral face (midzone).

PLATE 3.

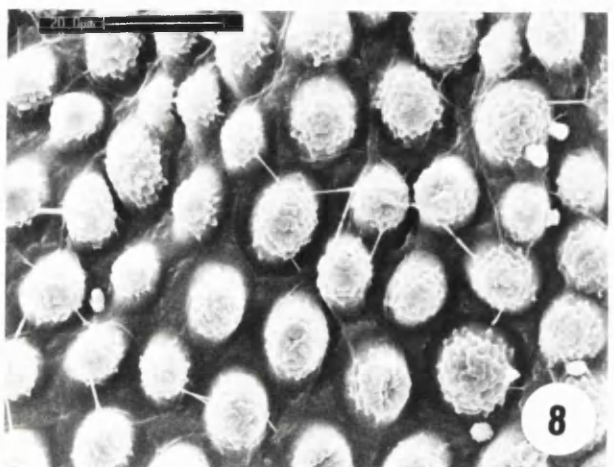
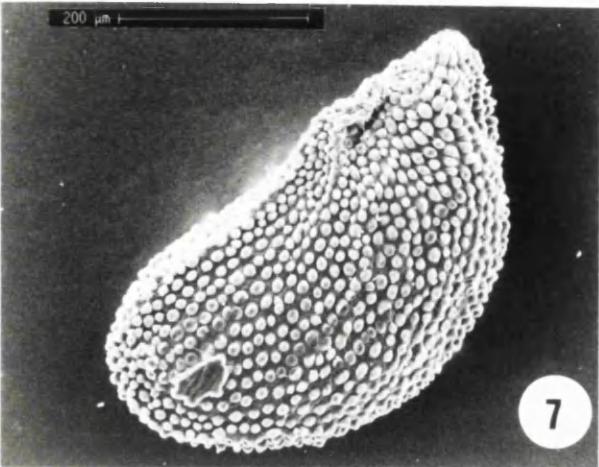
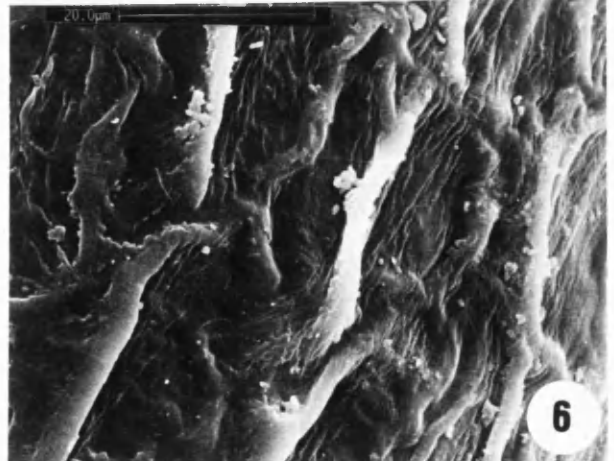
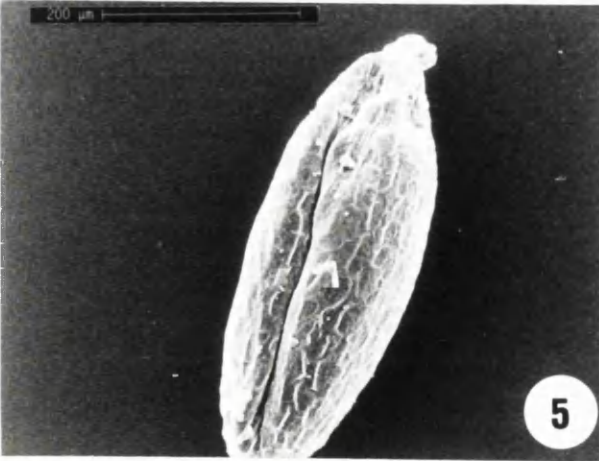
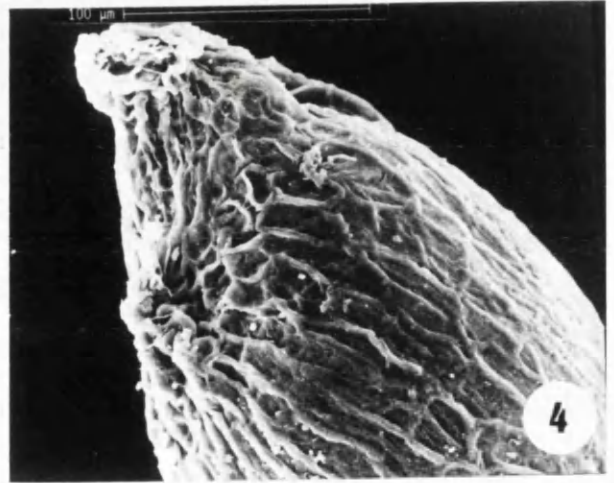
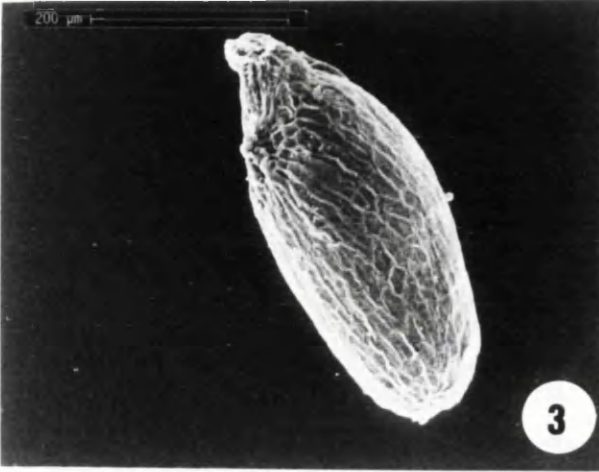
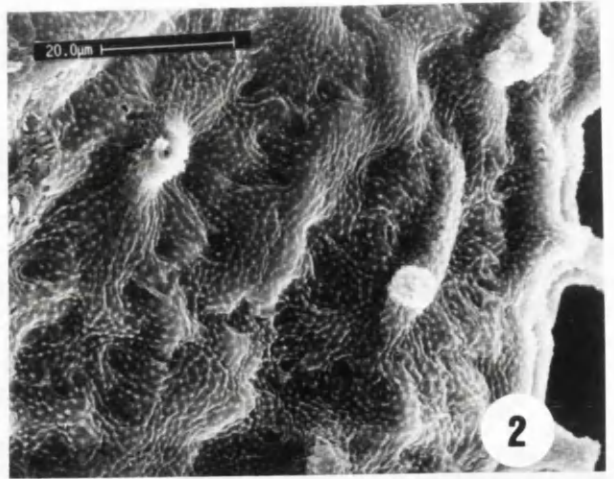
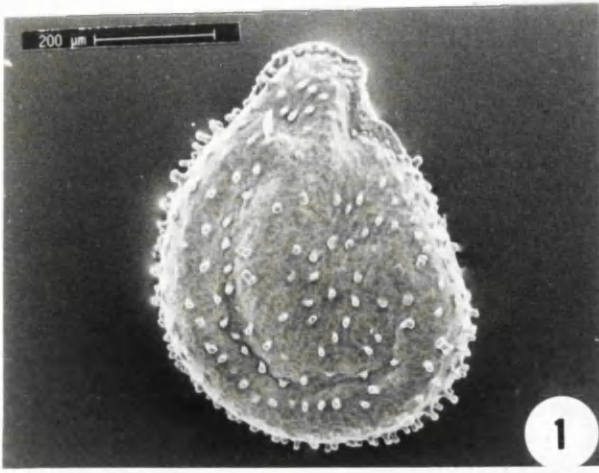

PLATE 4.

1. *Polycarpaea divaricata* papillae.
2. *Polycarpaea repens* whole seed.
3. „ „ lateral face (midzone).
4. „ „ whole seed.
5. „ „ lateral face (midzone).
6. „ „ ventral face.
7. *Polycarpaea robbairea* whole seed, ventral face.
8. „ „ lateral face (midzone).

PLATE 4.

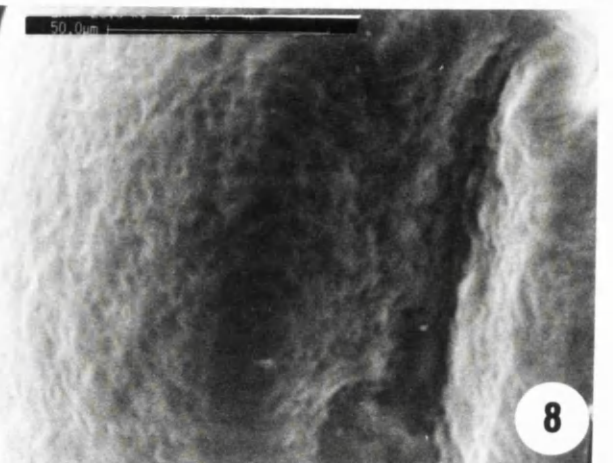
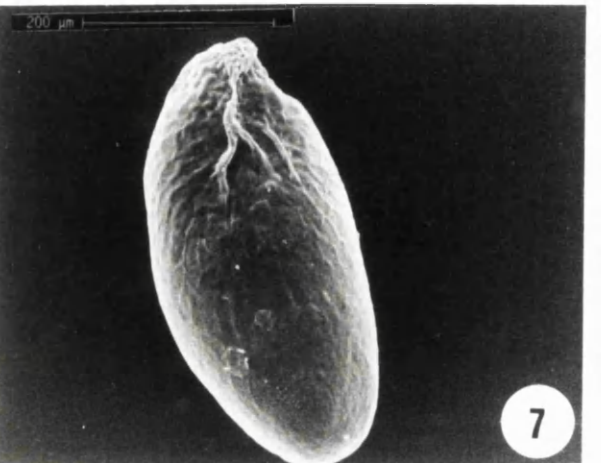
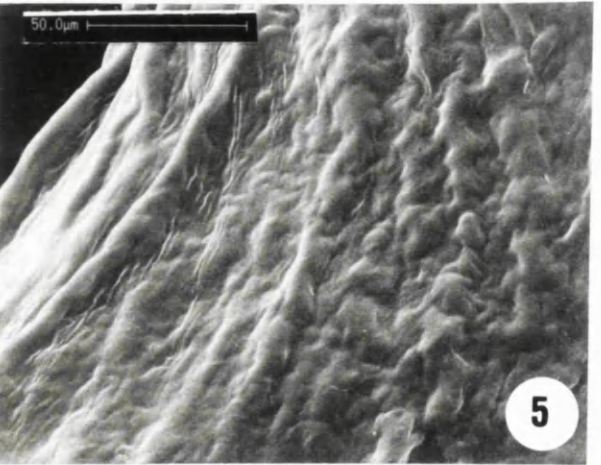
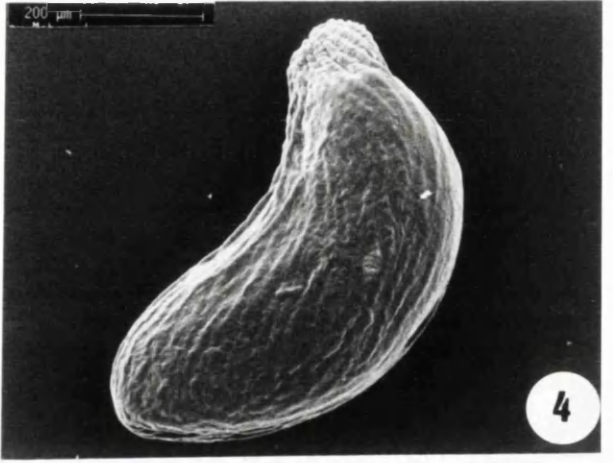
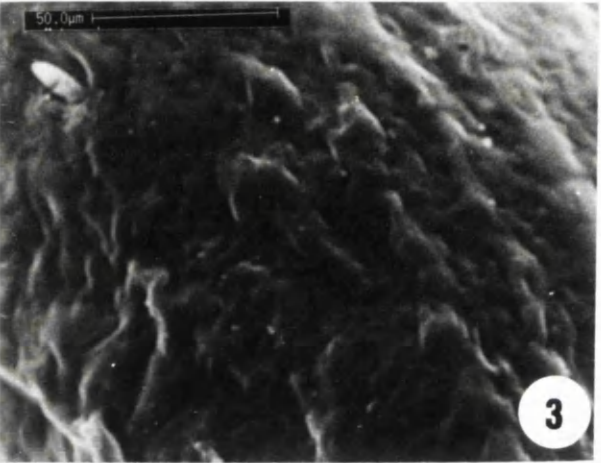
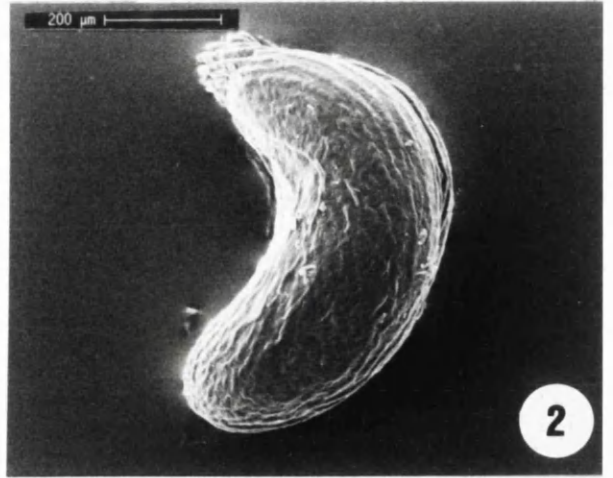

PLATE 5.

1. *Polycarpaea simithii* whole seed.
2. „ „ near the hilum and the radicle.
3. „ „ lateral face (midzone).
4. „ „ papillae.
5. *Polycarpaea tenius* whole seed.
6. „ „ near the radicle.
7. „ „ lateral face (midzone).
8. „ „ papillae

PLATE 5.

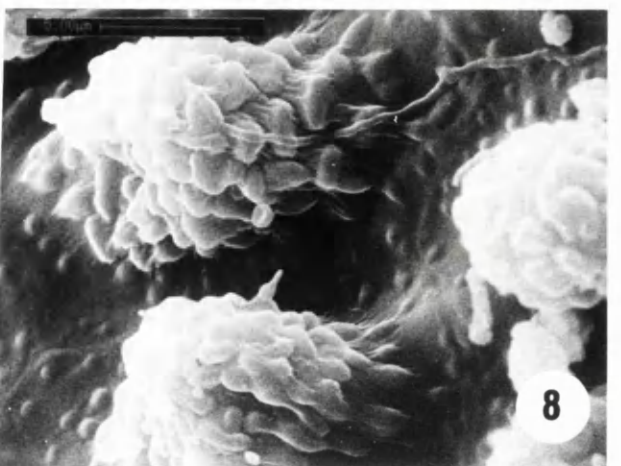
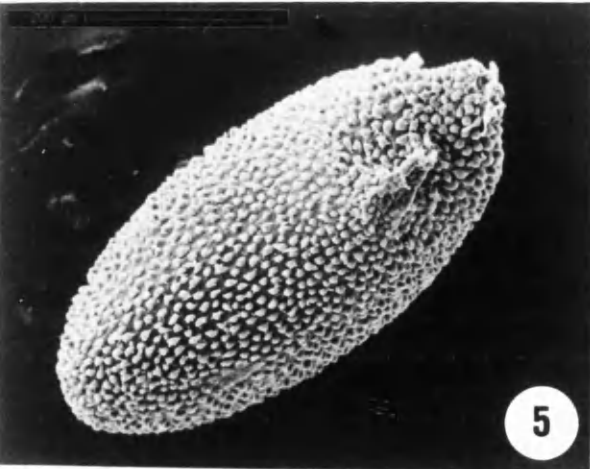
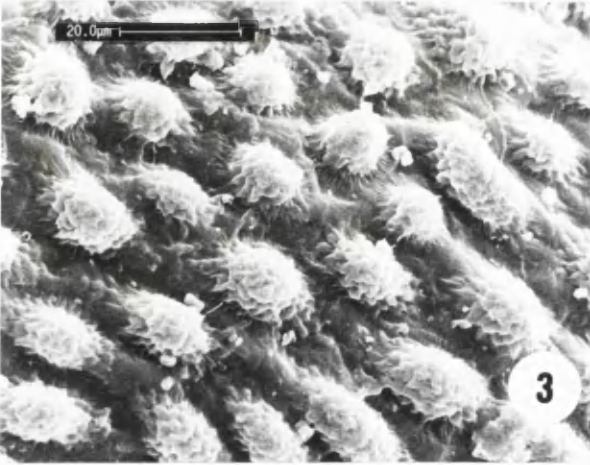
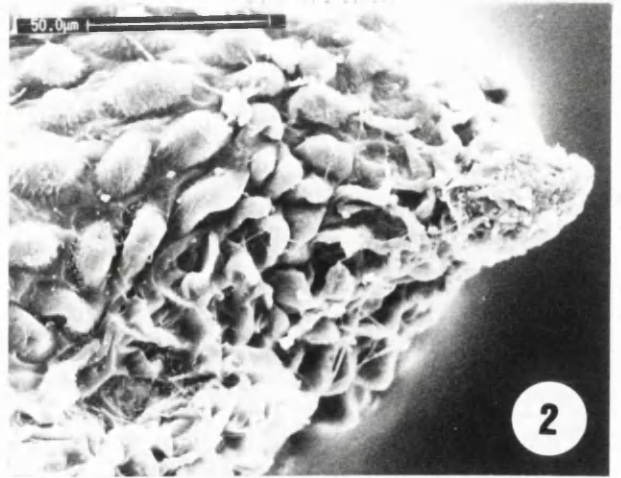
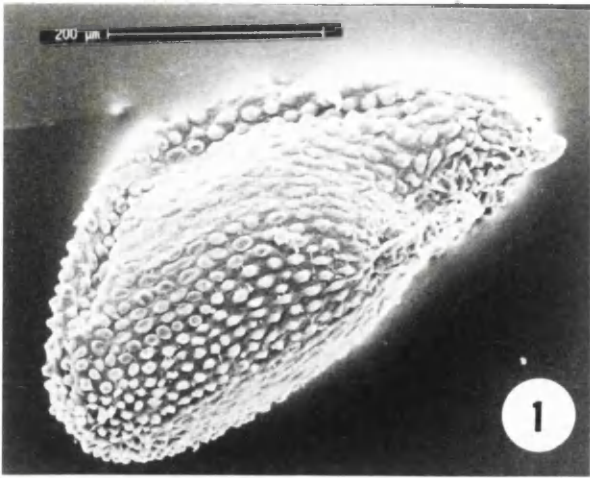

PLATE 6.

1. *Polycarpon prostratum* whole seed.
2. „ „ lateral face (midzone).
3. *Polycarpon tetraphyllum* whole seed.
4. „ „ lateral face (midzone).
5. *Loeflingia hispanica* whole seed.
6. „ „ lateral face (midzone).
7. „ „ ventral face.
8. „ „ near the radicle.

PLATE 6.

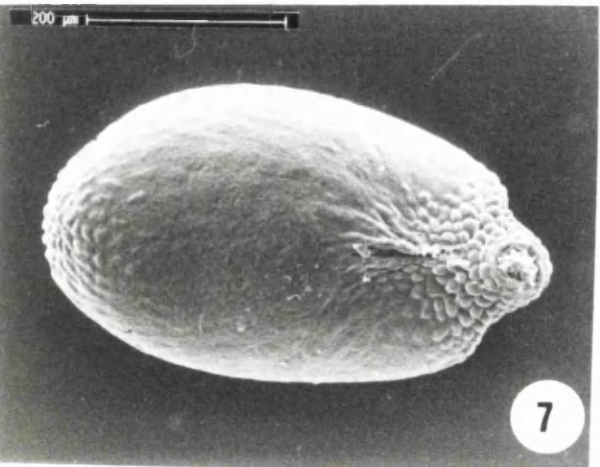
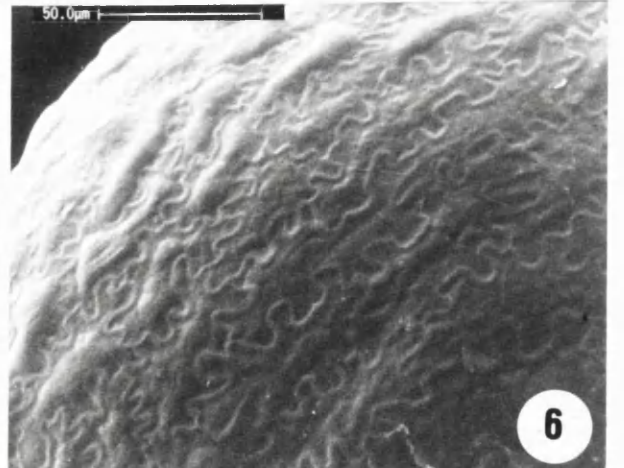
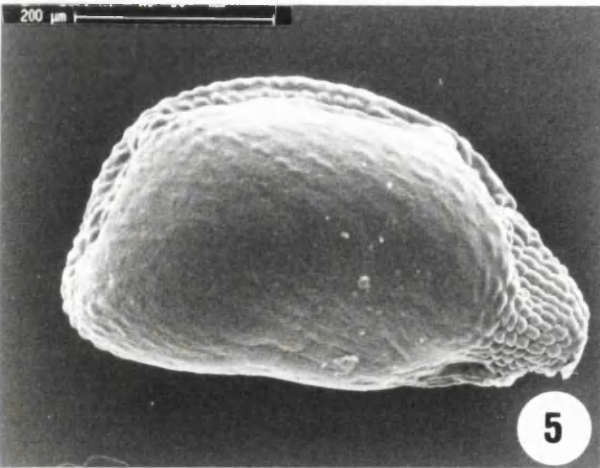
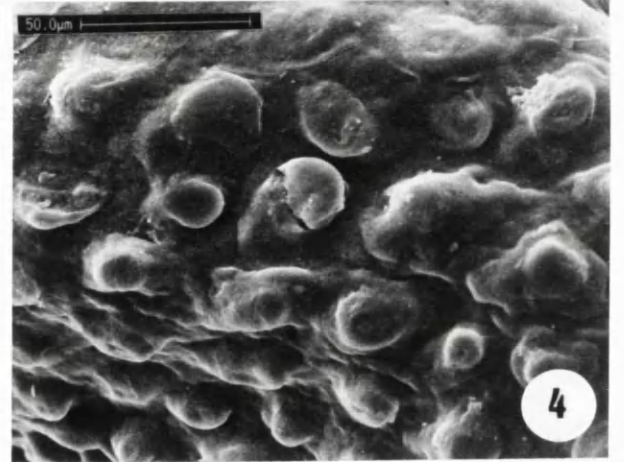
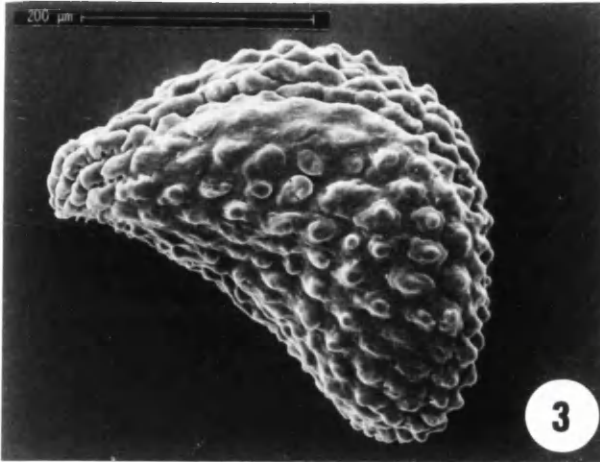
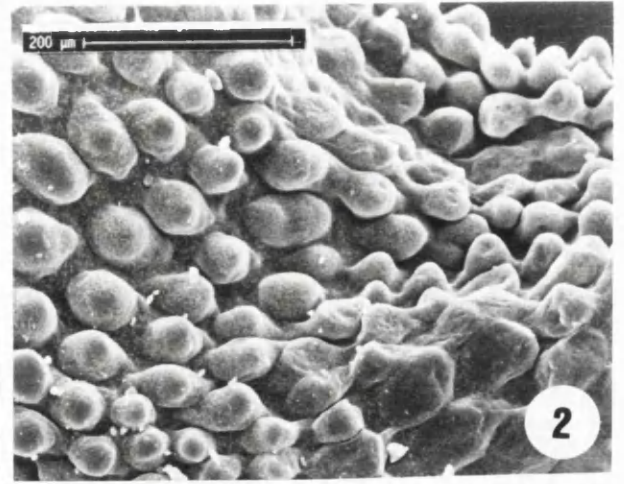
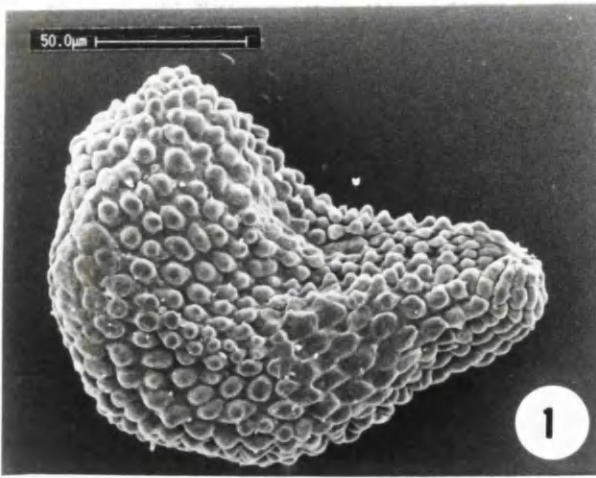

PLATE 7.

1. *Pteranthus dichotomus* whole seed.
2. „ „ lateral face (midzone).
3. *Sclerocephalus arabicus* whole seed.
4. „ „ lateral face (midzone).
5. „ „ near the hilum and the radicle.
6. *Gymnocarpos decander* whole seed.
7. „ „ lateral face (midzone).
8. „ „ near the hilum and the radicle. .

PLATE 7.

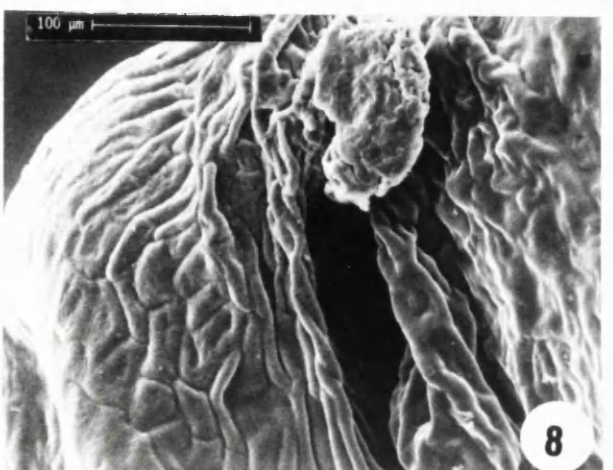
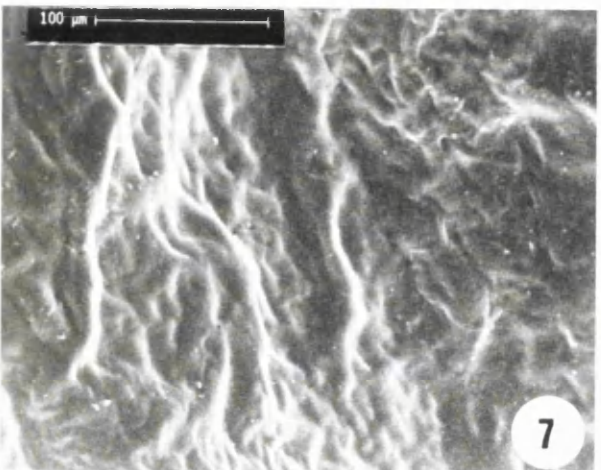
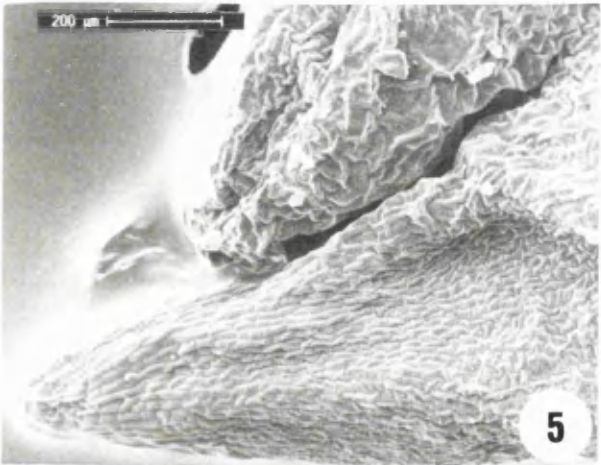
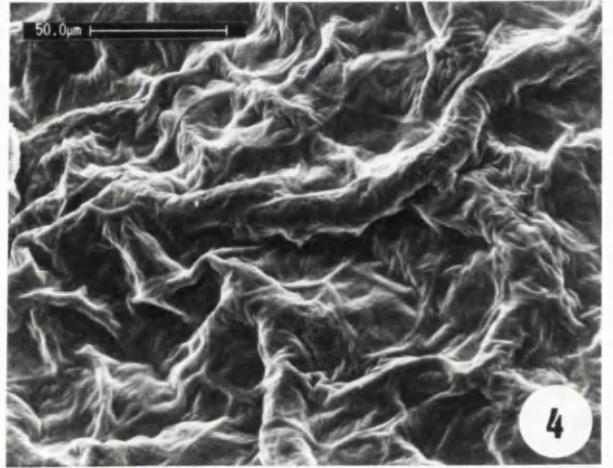
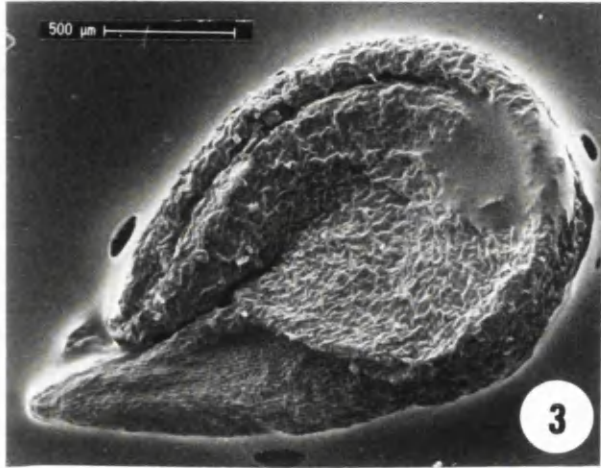
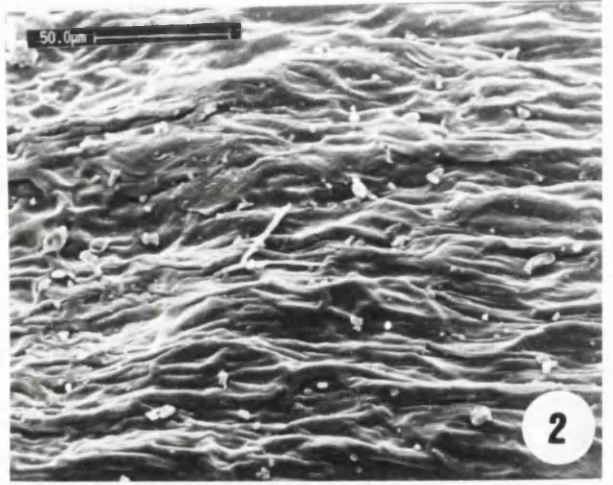
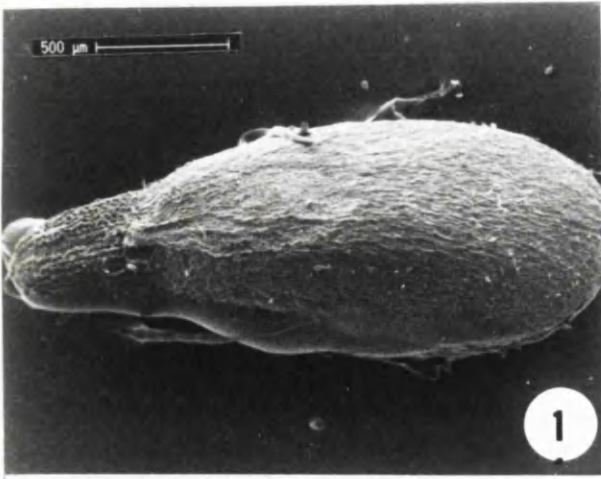

PLATE 8.

1. *Paronychia arabica* whole seed.
2. „ „ lateral face (midzone).
3. „ „ near the hilum and the radicle.
4. *Paronychia argentea* whole seed.
5. „ „ lateral face (midzone).
6. „ „ near the hilum and the radicle.
7. *Paronychia capitata* whole seed.
8. „ „ lateral face (midzone).

PLATE 8.

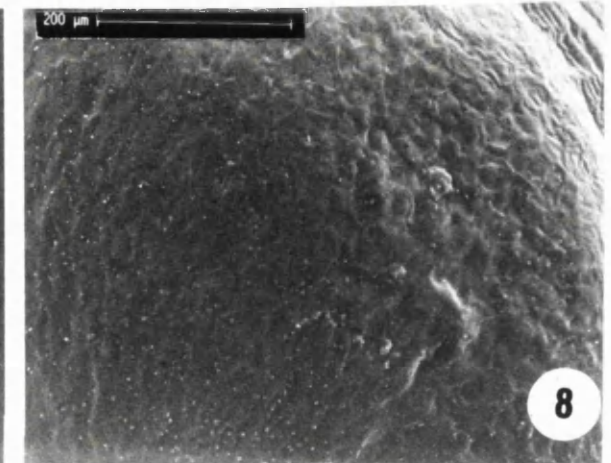
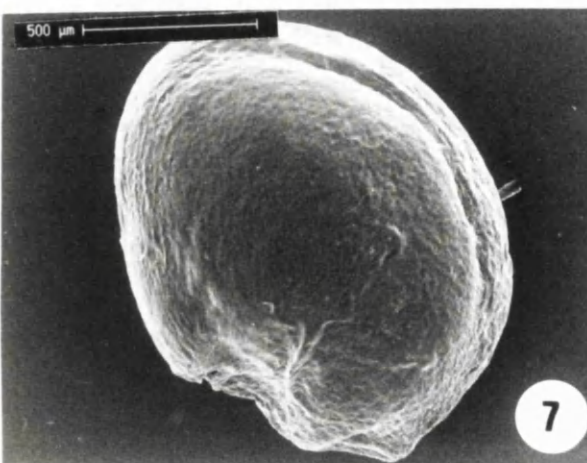
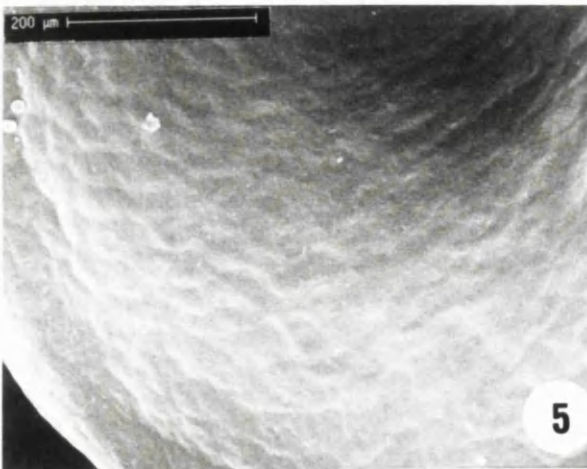
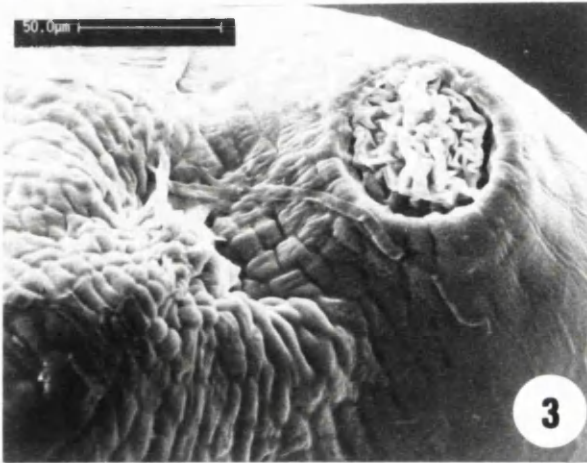
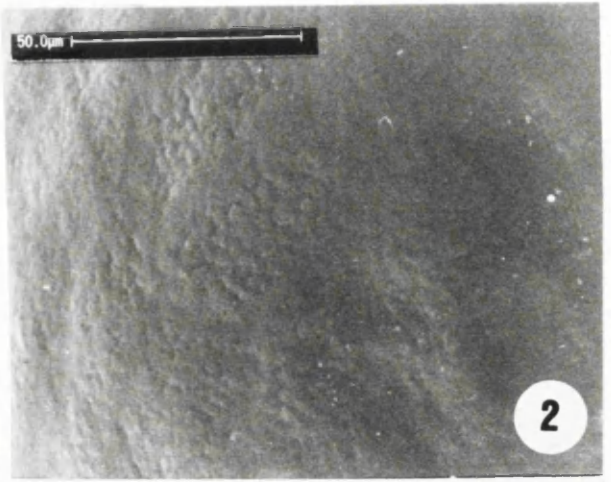
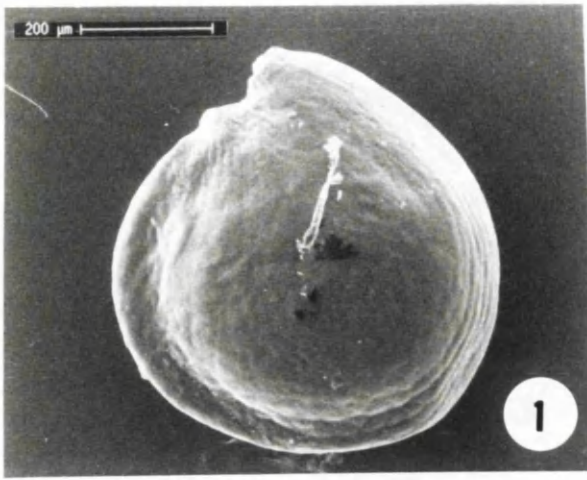

PLATE 9.

1. *Paronychia capitata* near the hilum and the radicle.

2. *Paronychia chlorothyrsa* whole seed.

3. „ „ lateral face (midzone).

4. „ „ near the hilum and the radicle.

5. „ „ near the margin.

6. *Paronychia kapela* whole seed.

7. „ „ lateral face (midzone).

8. „ „ near the hilum and the radicle.

PLATE 9.

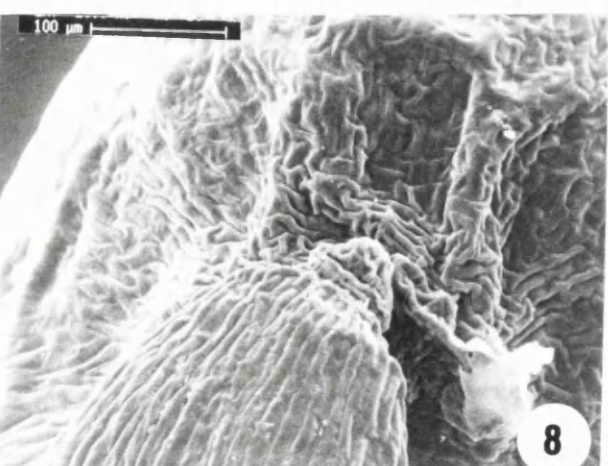
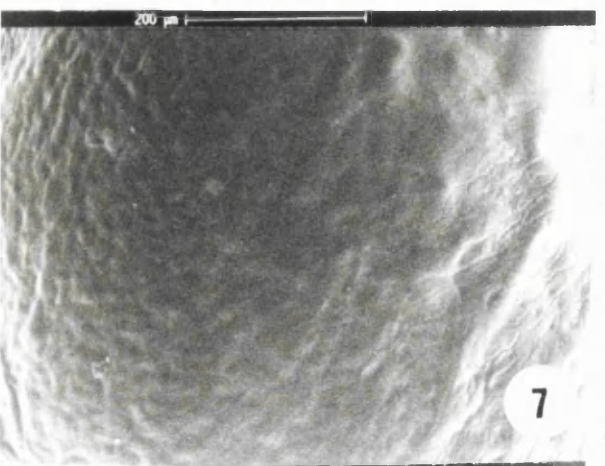
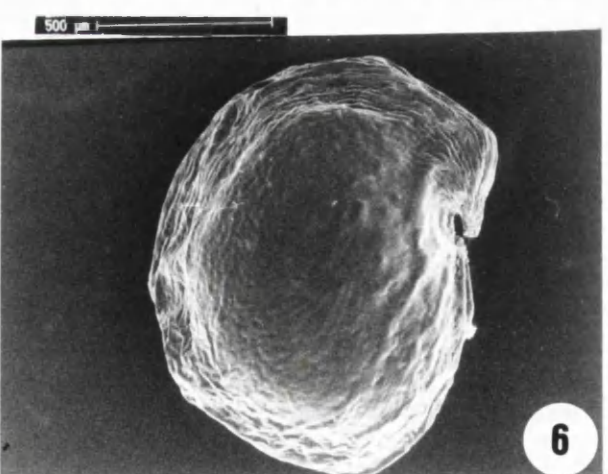
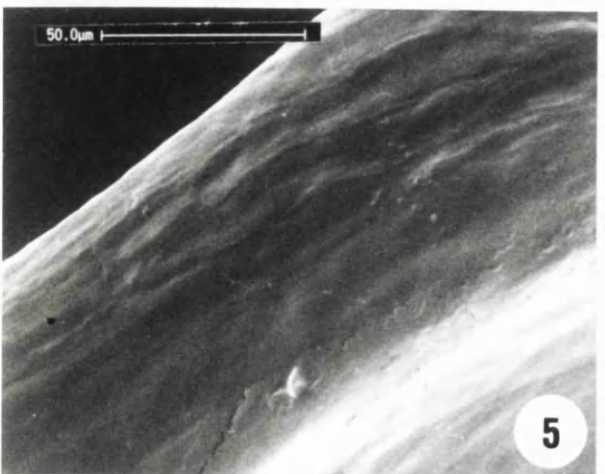
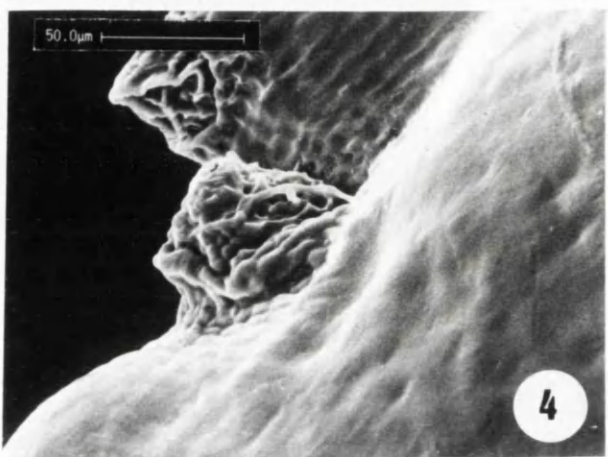
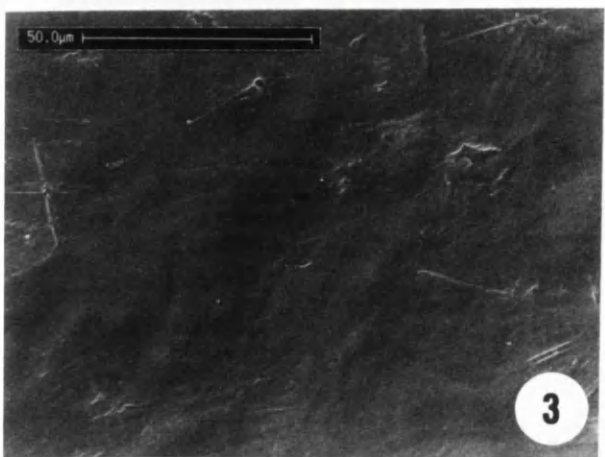
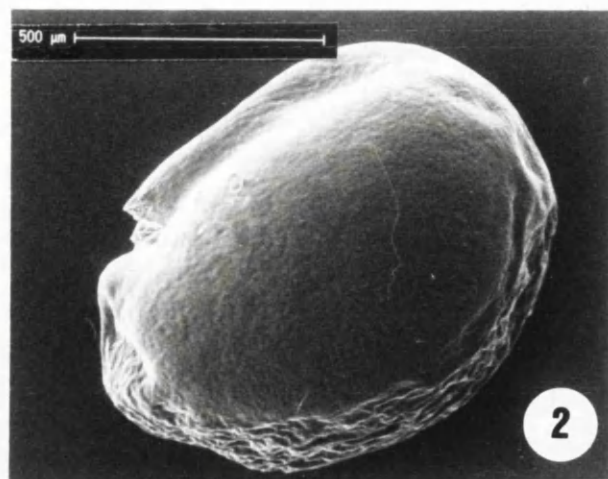
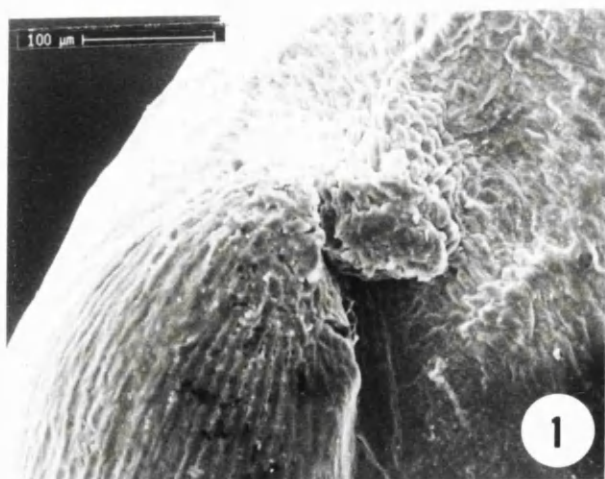

PLATE 10.

1. *Herinaria cinerea* whole seed.
2. „ „ near the hilum and the radicle.
3. *Herniaria cyrenaica* whole seed.
4. „ „ near the hilum and the radicle.
5. *Herniaria ericifolia* whole seed.
6. „ „ near the hilum and the radicle.
7. „ „ lateral face (midzone).
8. „ „ near the margin.

PLATE 10.

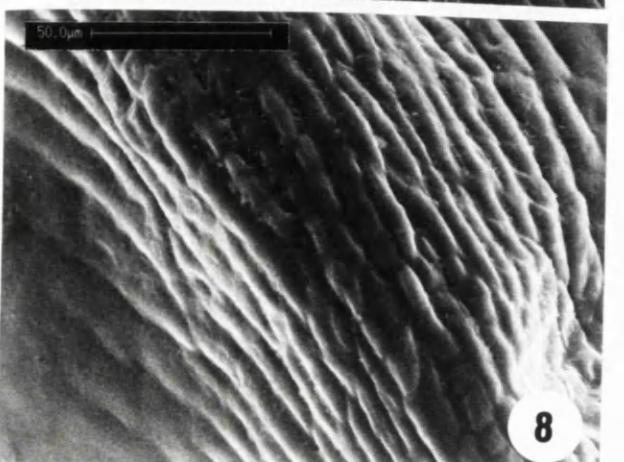
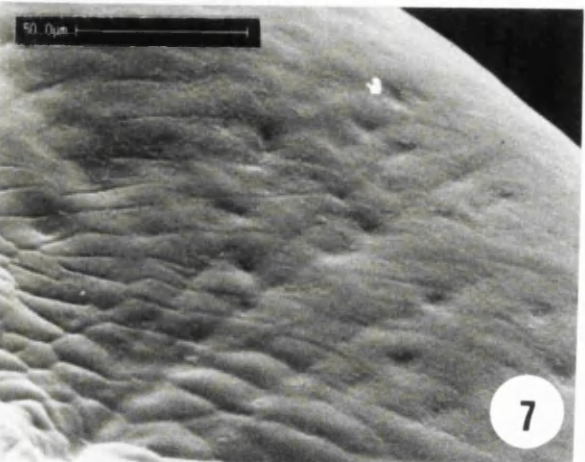
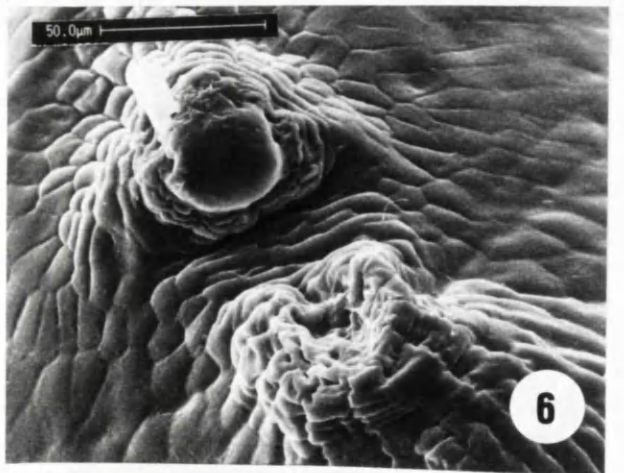
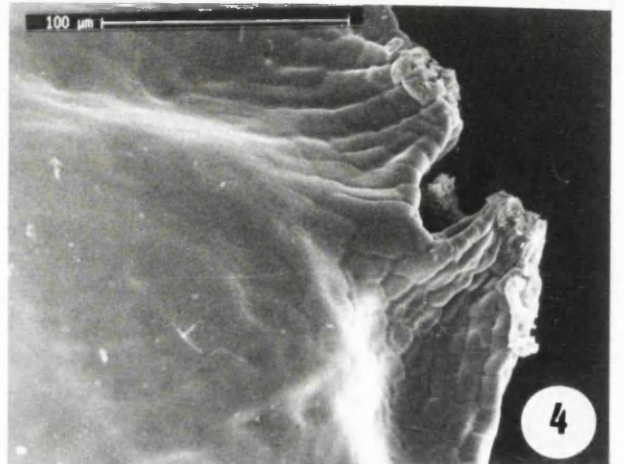
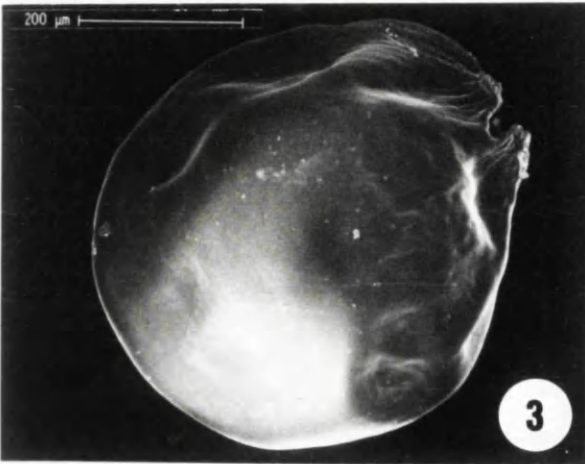
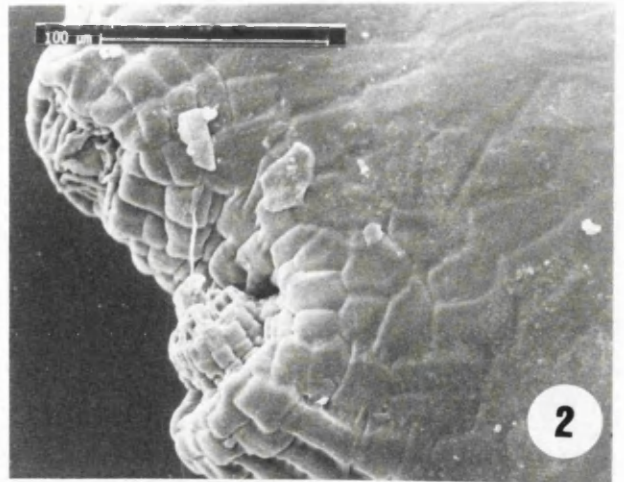
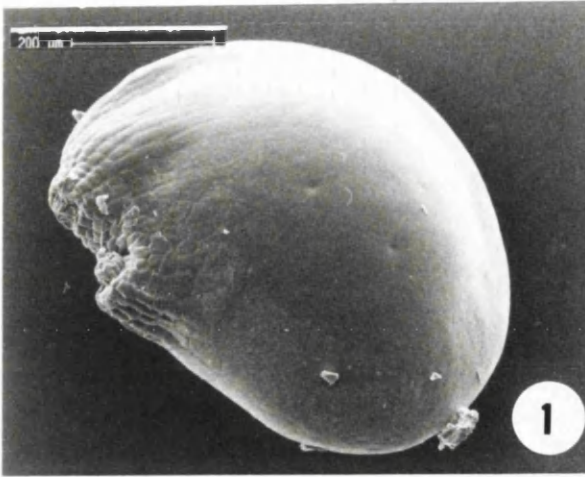

PLATE 11.

1. *Herniaria fontanesii* whole seed.
2. „ „ lateral face (midzone).
3. „ „ near the hilum and the radicle.
4. *Herinaria glabra* whole seed.
5. „ „ near the hilum and the radicle
6. „ „ near the hilum.
7. „ „ near the radicle
8. *Herinaria hemistemon* whole seed.

PLATE 11.

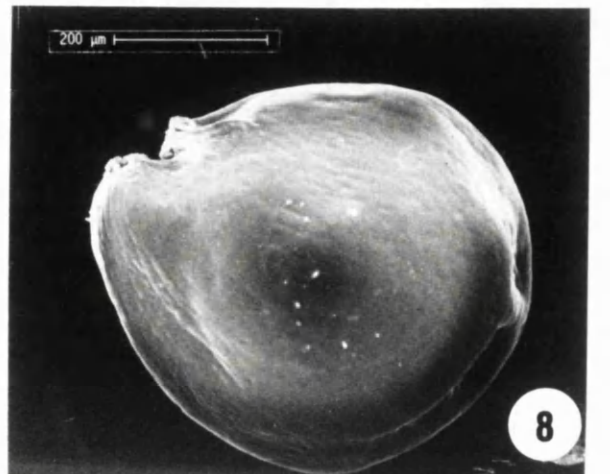
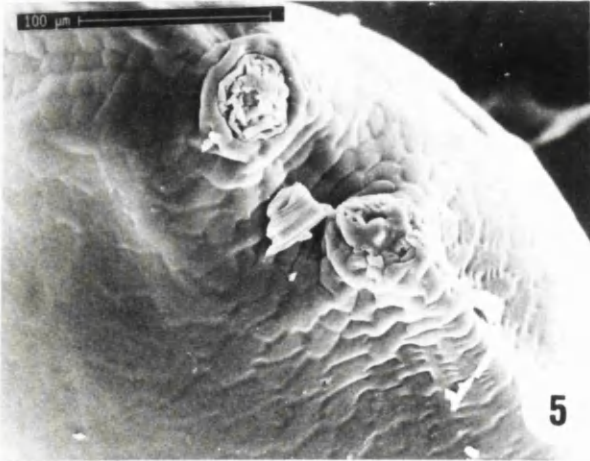
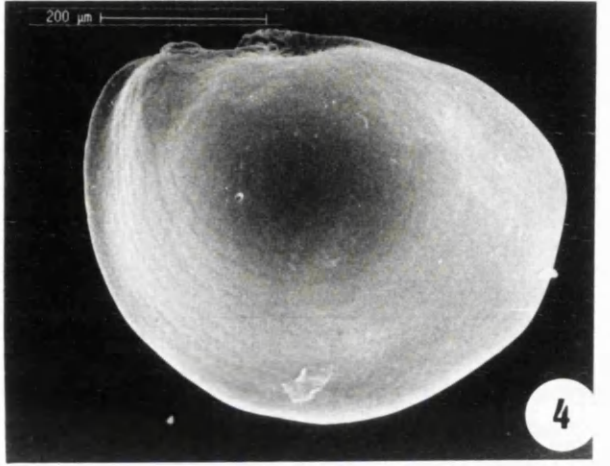
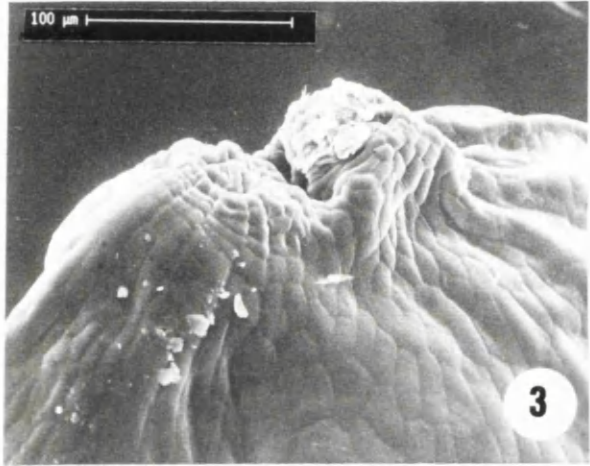
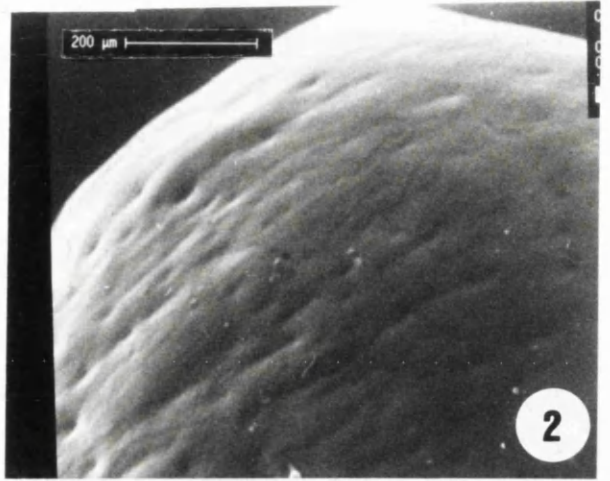
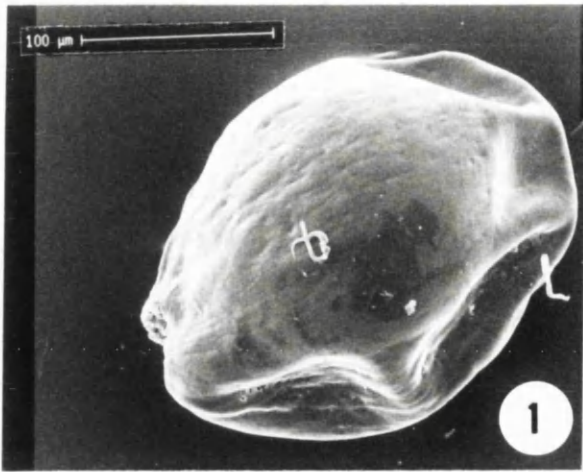

PLATE 12.

1. *Herniaria hemistemon* lateral face (midzone).
2. „ „ near the hilum and the radicle.
3. *Telephium sphaerospermum* whole seed x 300
4. „ „ lateral face (midzone) x 1200.
5. „ „ near the hilum x 600.
6. *Arenaria serpyllifolia* s. s. whole seed.
7. „ „ lateral face (midzone).
8. „ „ near the marginal face.

PLATE 12.

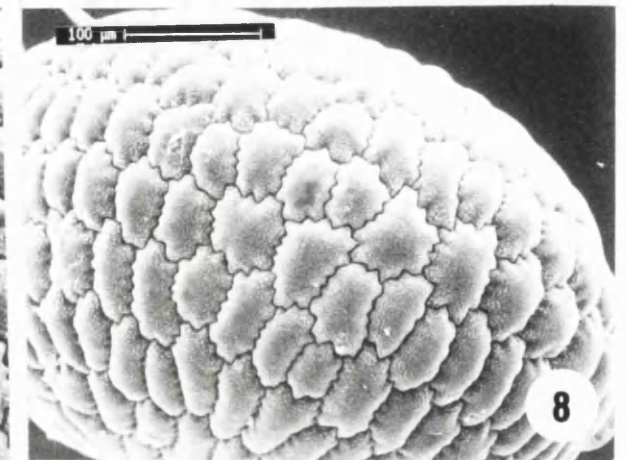
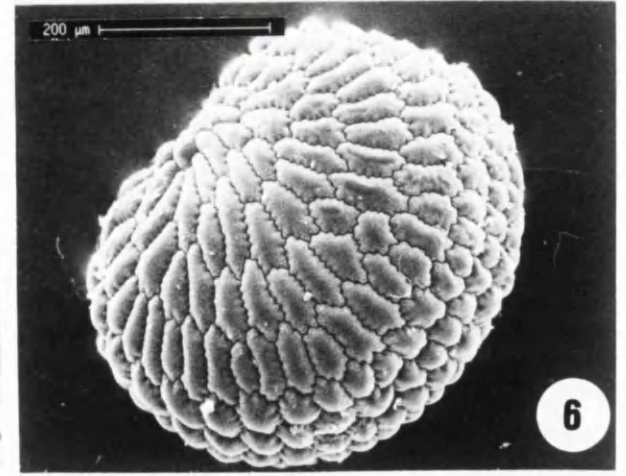
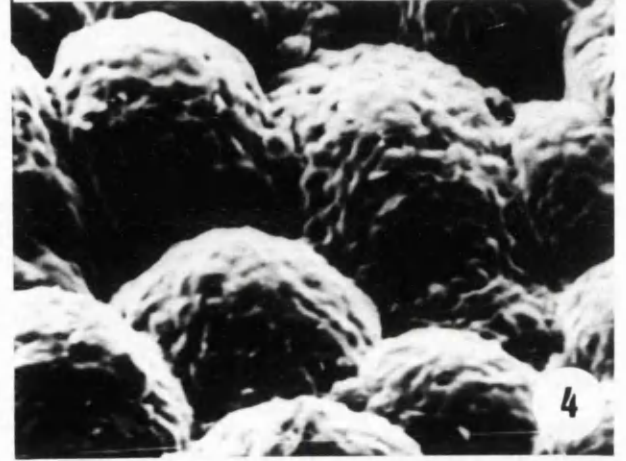
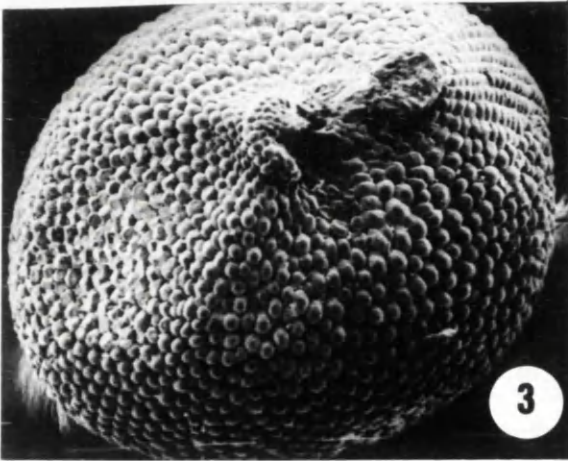
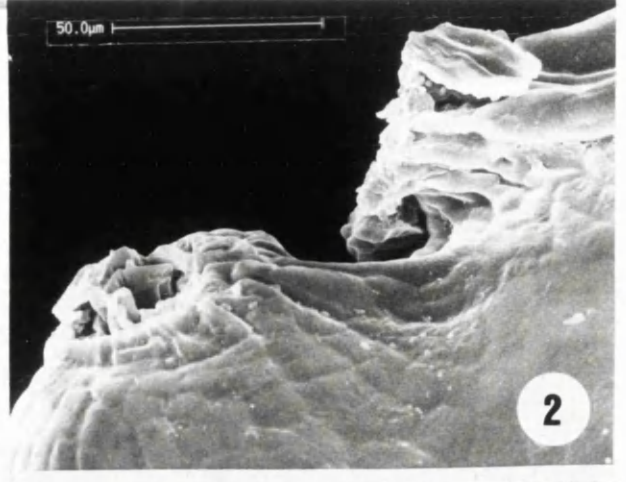
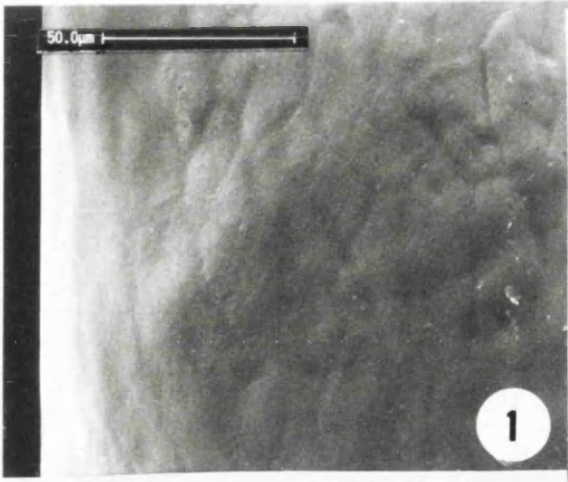

PLATE 13.

1. *Arenaria serpyllifolia* s.s. whole seed.
2. „ „ lateral face (midzone).
3. „ „ whole seed. x 300.
4. „ „ lateral face (midzone). x 1200.
5. *Arenaria leptoclados* whole seed.
6. „ „ lateral face (midzone).
7. *Arenaria serpyllifolia* (Davis 50344) whole seed.
8. „ „ lateral face (midzone).
9. „ „ near the hilum and the radicle.

PLATE 13.

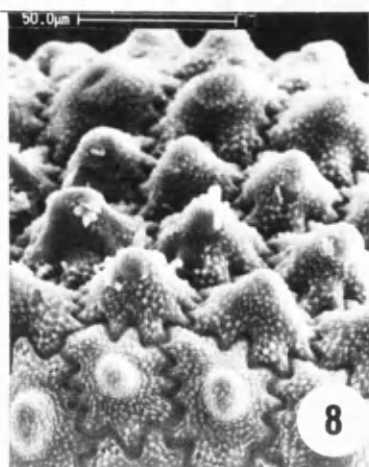
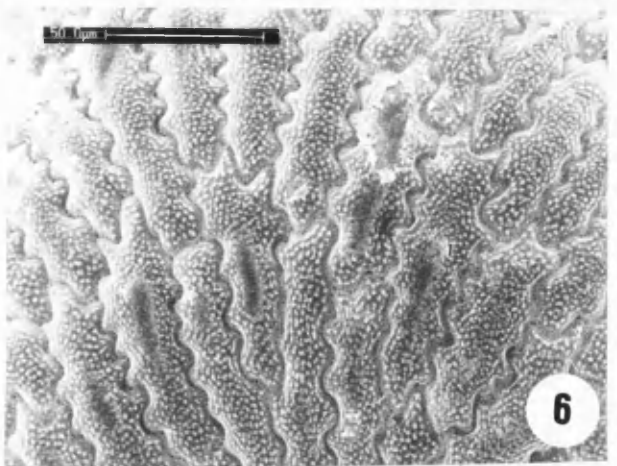
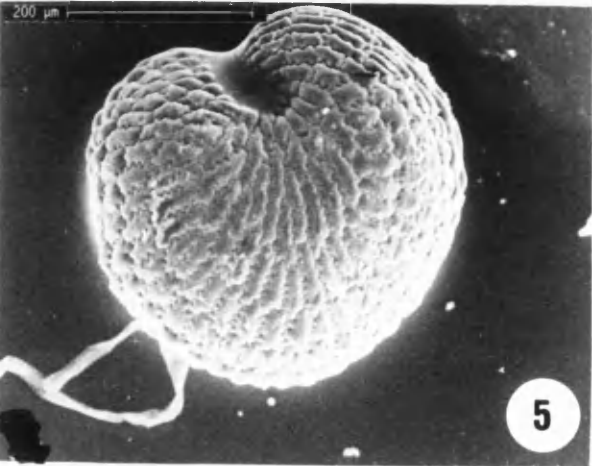
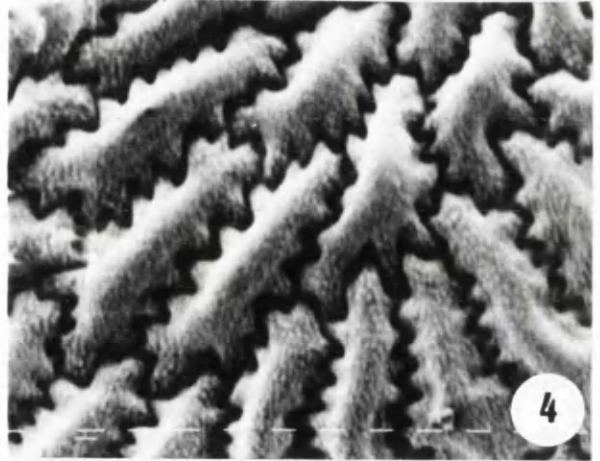
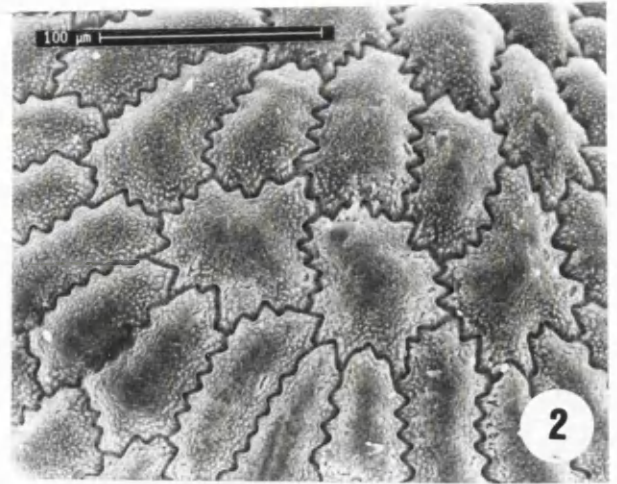
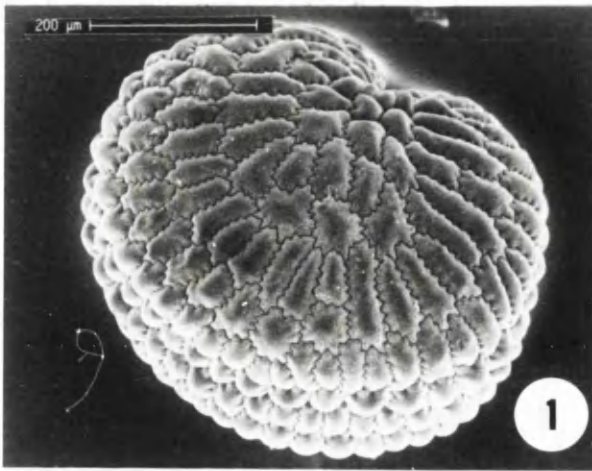

PLATE 14.

1. *Cerastium dichotomum* whole seed.
2. „ „ lateral face (midzone).
3. *Cerastium glomeratum* whole seed.
4. „ „ lateral face (midzone).
5. *Cerastium illyricum* whole seed.
6. „ „ lateral face (midzone).
7. *Cerastium ligusticum* whole seed.
8. „ „ lateral face (midzone).

PLATE 14.

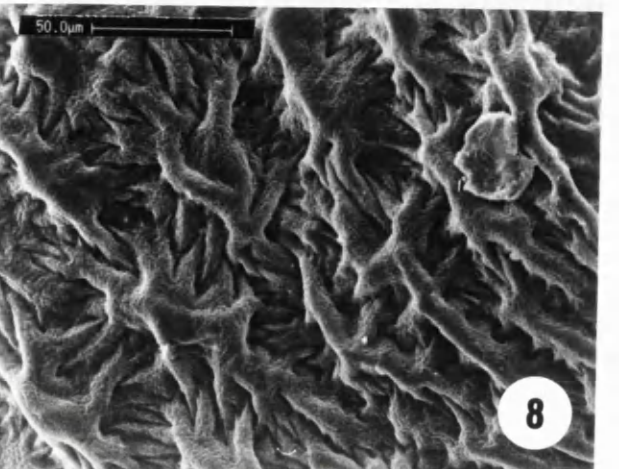
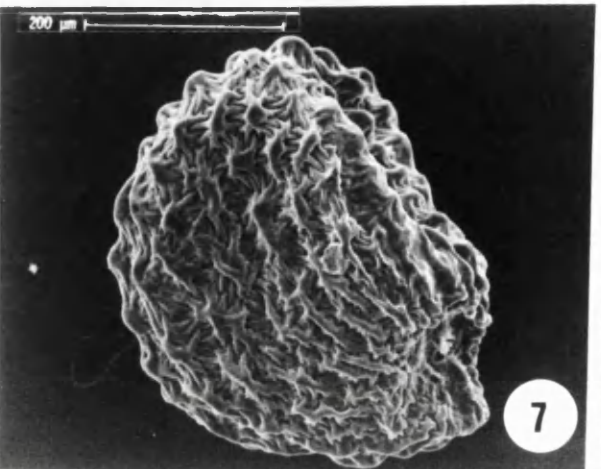
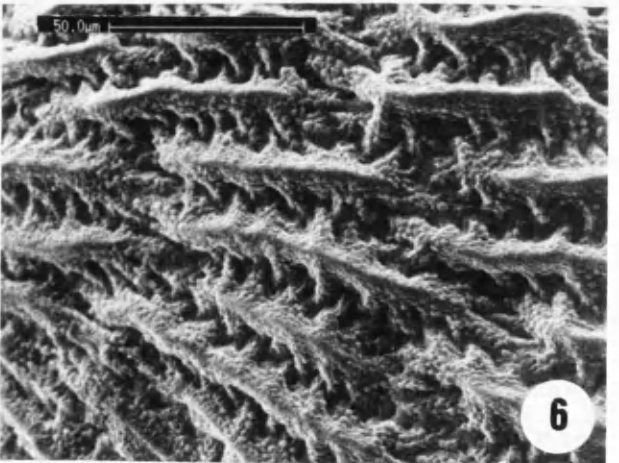
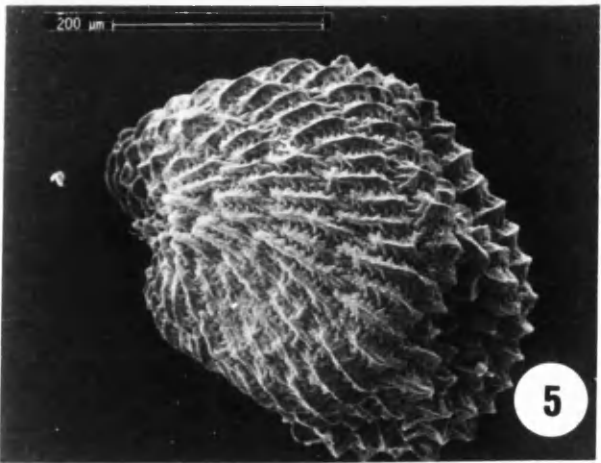
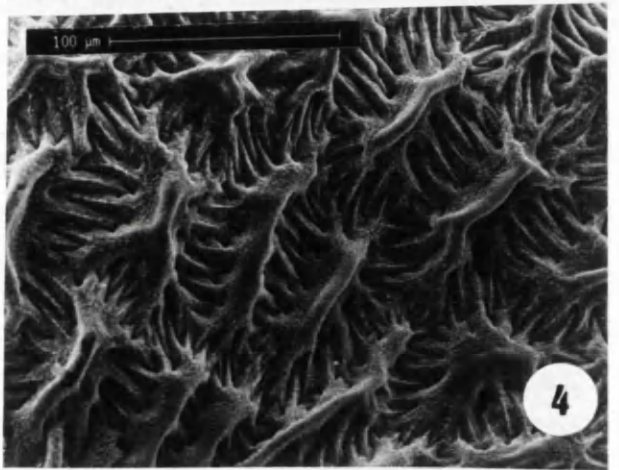
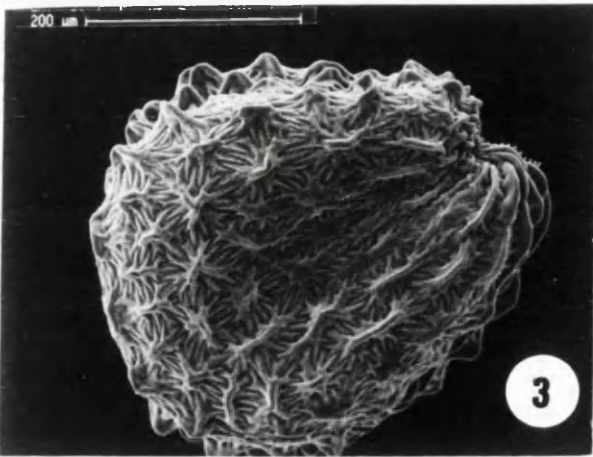
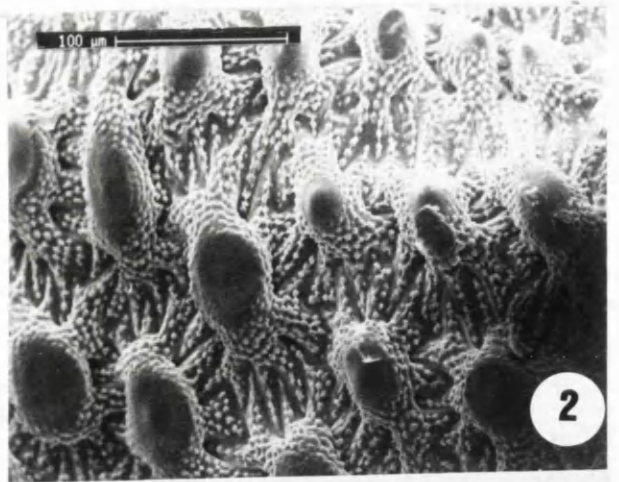
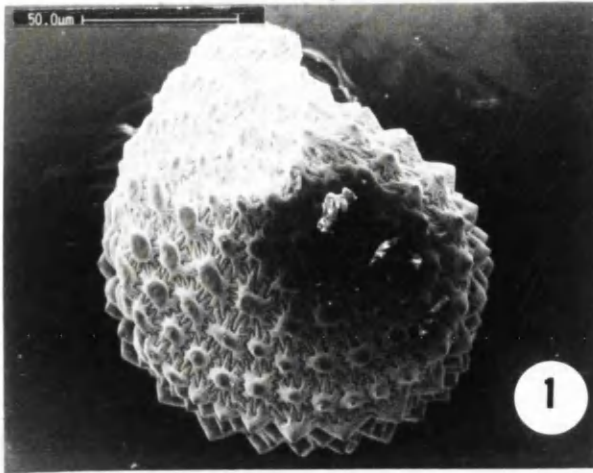

PLATE 15.

1. *Cerastium pumilum* whole seed.
2. „ „ lateral face (midzone).
3. *Cerastium semidecandrum* whole seed.
4. „ „ lateral face (midzone).
5. *Cerastium siculum* whole seed.
6. „ „ lateral face (midzone).
7. *Stellaria media* whole seed.
8. *Stellaria media* lateral face.
9. „ „ marginal face.

PLATE 15.

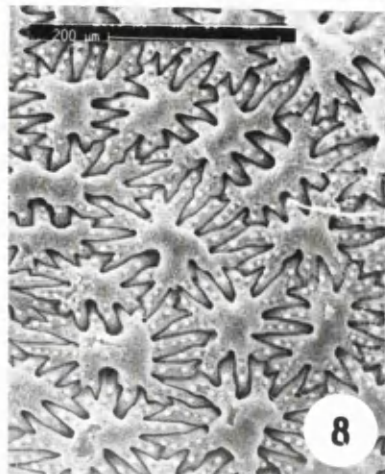
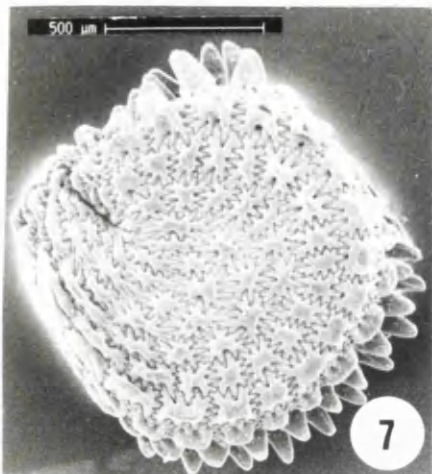
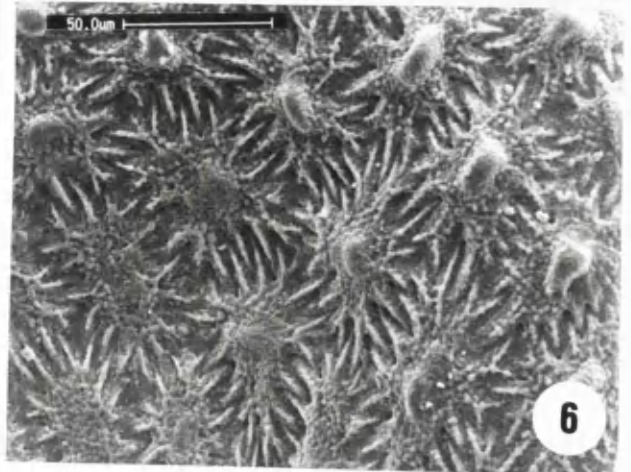
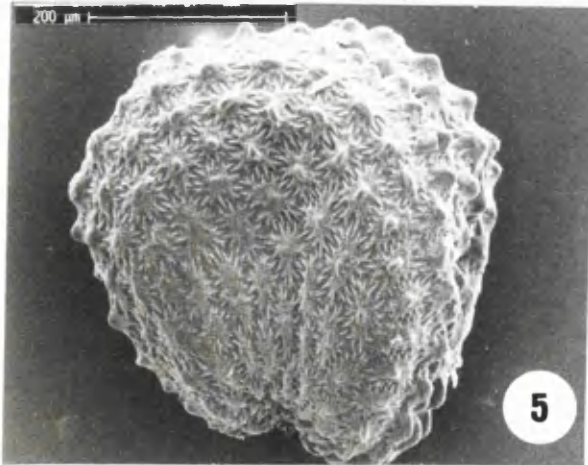
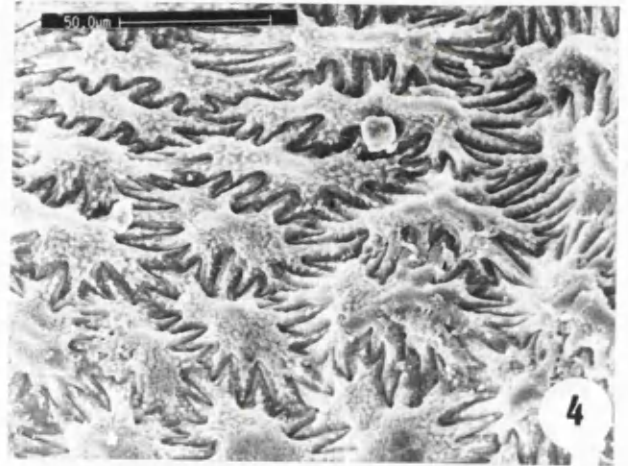
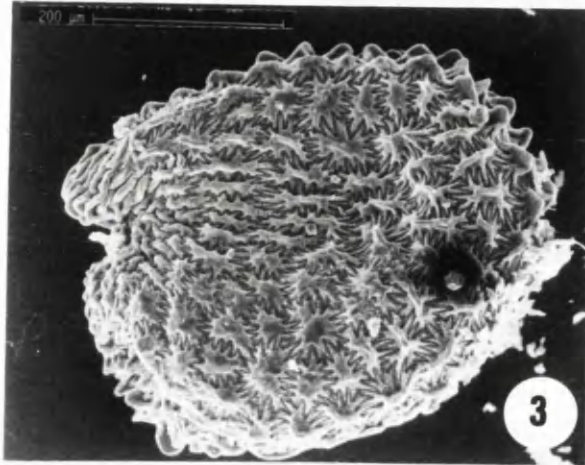
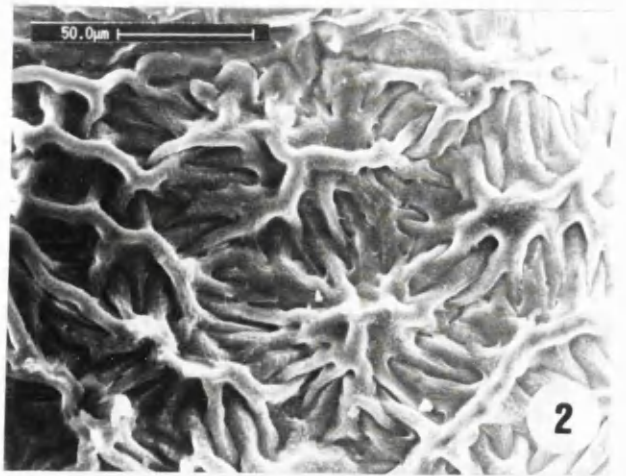
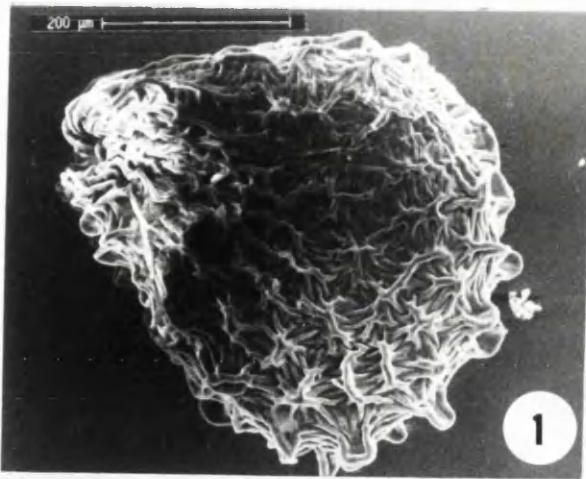

PLATE 16.

1. *Stellaria media* subsp. *cupanina*. whole seed. x 150.
2. „ „ lateral face (midzone). x 1200.
3. „ „ near the hilum and the radicle. x 1200.
4. „ „ marginal face. x 1200
5. *Stellaria media* whole seed. x 150.
6. „ „ lateral face (midzone). x 1200.
7. „ „ near the hilum and the radicle. x 600.
8. „ „ marginal face. x 1200.

PLATE 16.

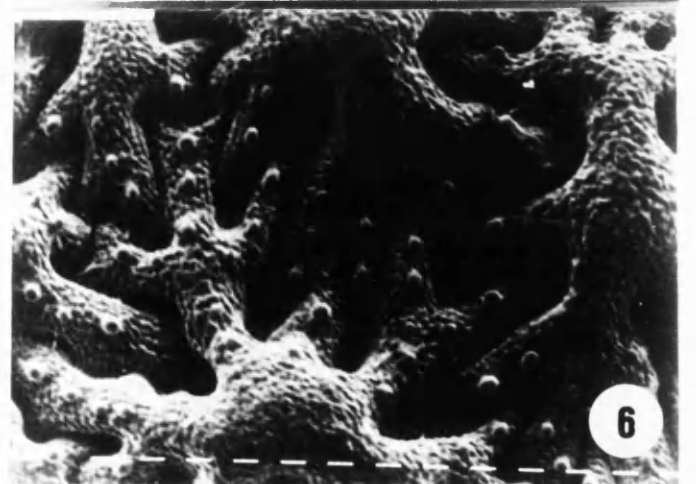
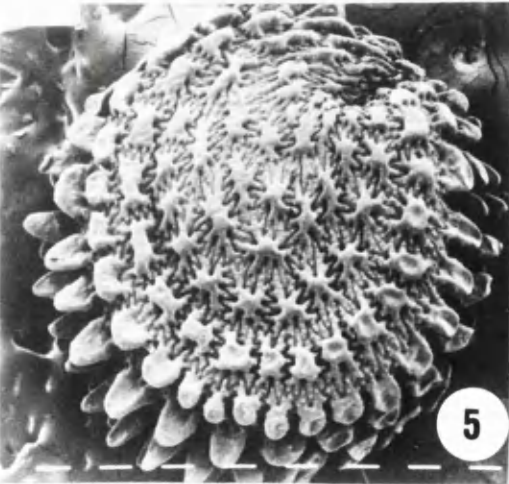
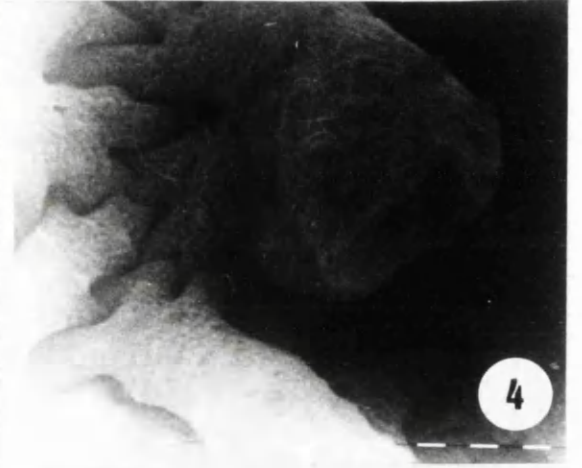
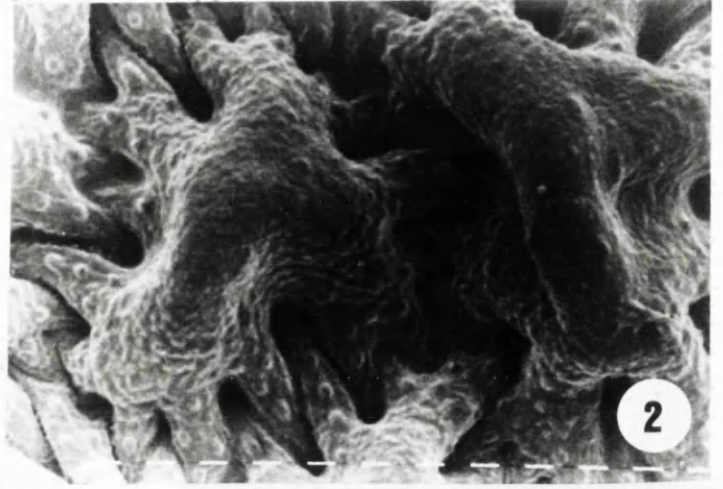

PLATE 17.

1. *Stellaria pallida* whole seed. x 150.
2. „ „ lateral face (midzone). x 1200.
3. „ „ near the hilum and the radicle. x 600.
4. „ „ marginal face. x 1200.
5. *Minuartia campestris* whole seed.
6. „ „ lateral face (midzone).
7. *Minuartia geniculata* whole seed. x 300.
8. „ „ lateral face (midzone). x 2400.

PLATE 17.

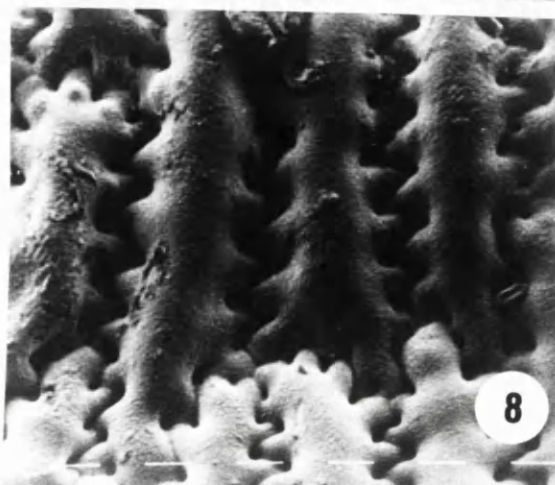
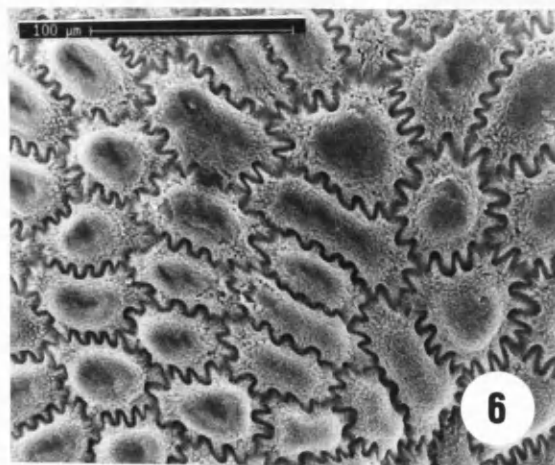
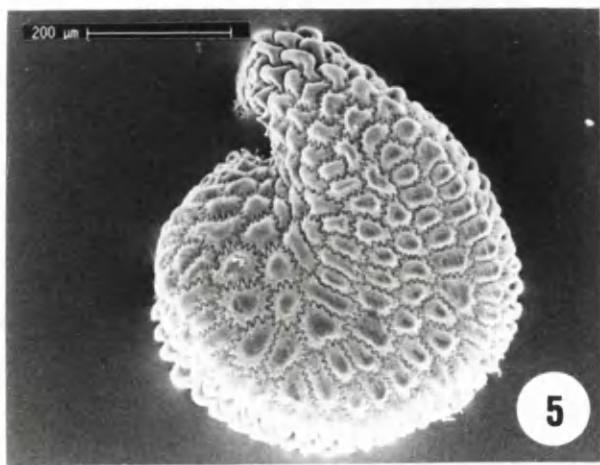
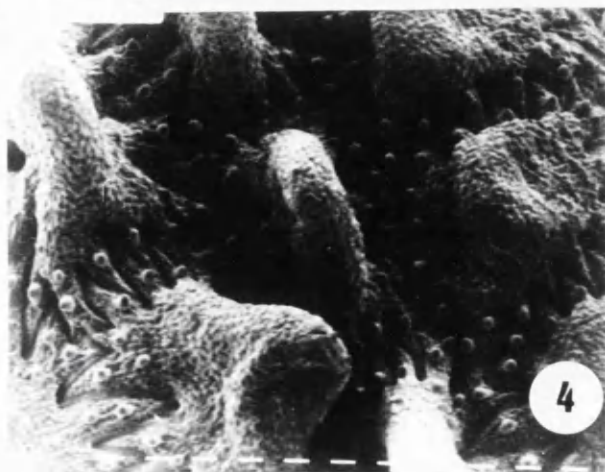
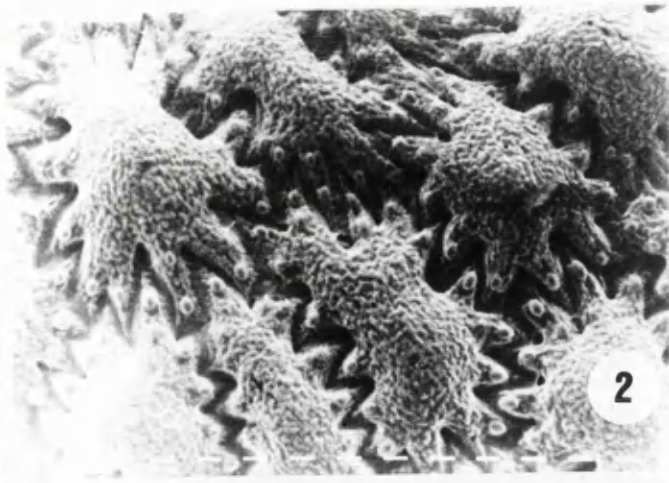
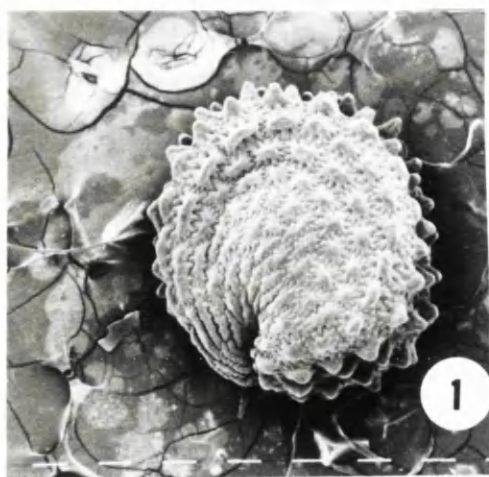

PLATE 18.

1. *Minuartia geniculata* whole seed.
2. „ „ lateral face (midzone).
3. „ „ whole seed.
4. „ „ lateral face (midzone).
5. „ „ near the hilum and the radicle.
6. *Minuartia geniculata* marginal face.
7. „ „ whole seed.
8. „ „ near the hilum and the radicle.

PLATE 18.

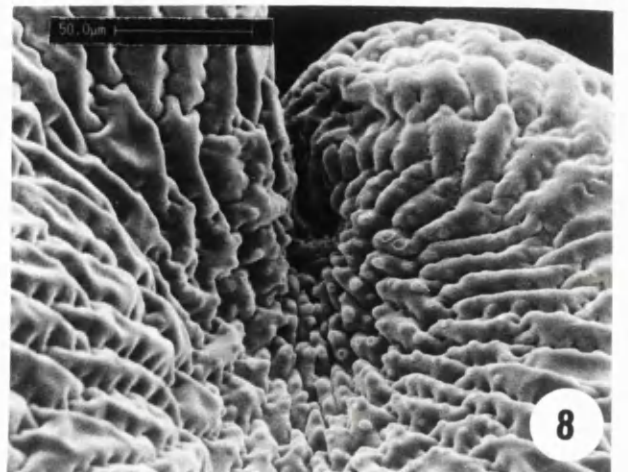
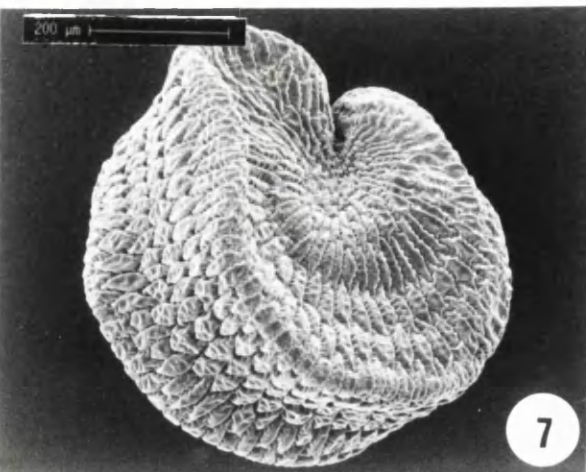
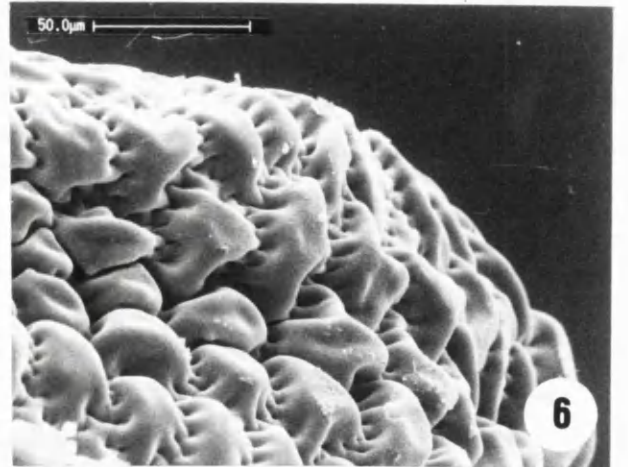
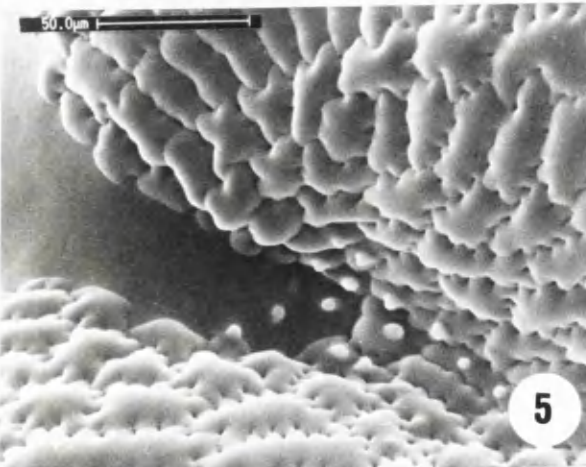
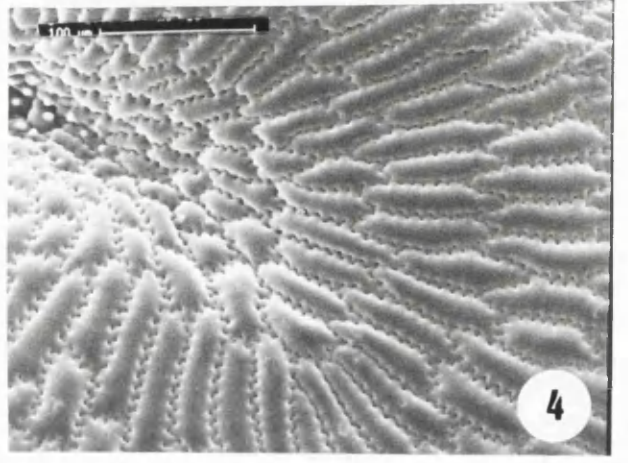
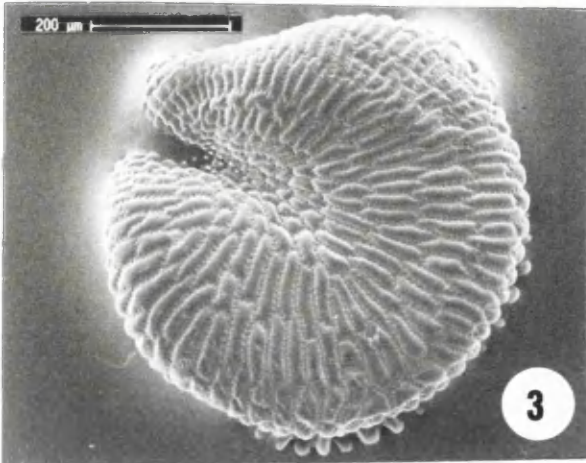
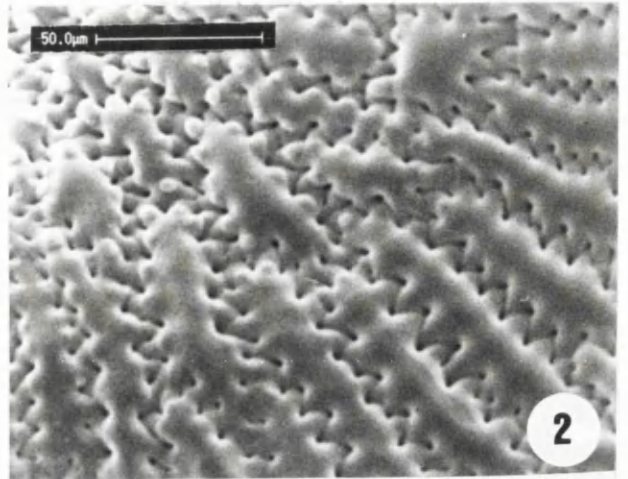
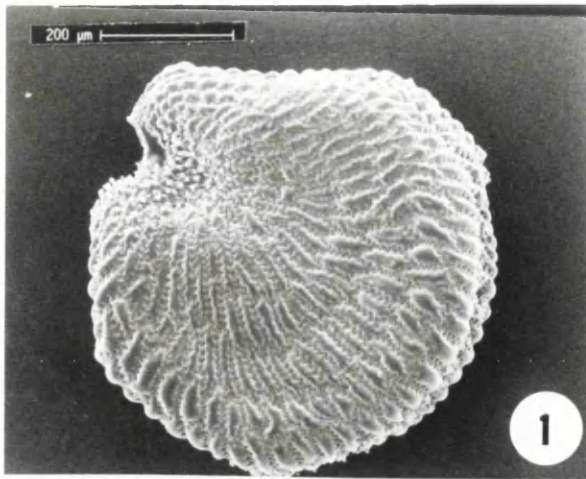

PLATE 19.

1. *Minuartia geniculata* lateral face (midzone).
2. „ „ marginal face.
3. *Minuartia hybrida* whole seed.
4. „ „ lateral face (midzone).
5. *Minuartia mediterranea* whole seed.
6. „ „ lateral face (midzone).
7. „ „ near the hilum and the radicle.
8. *Minuartia montana* whole seed.
9. „ „ marginal face.

PLATE 19.

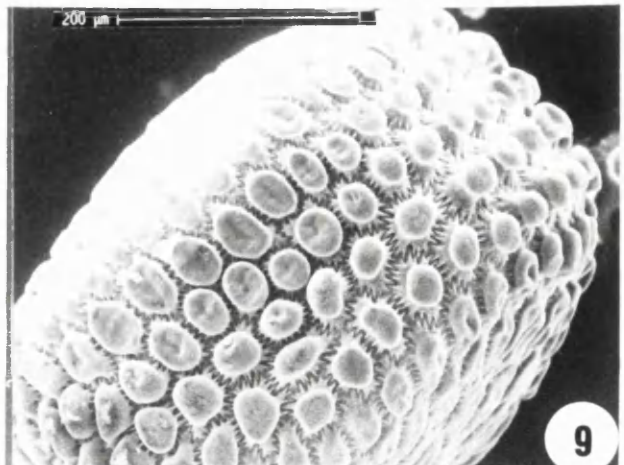
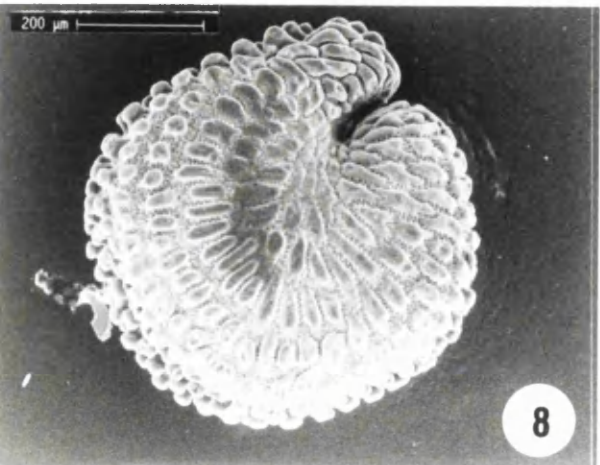
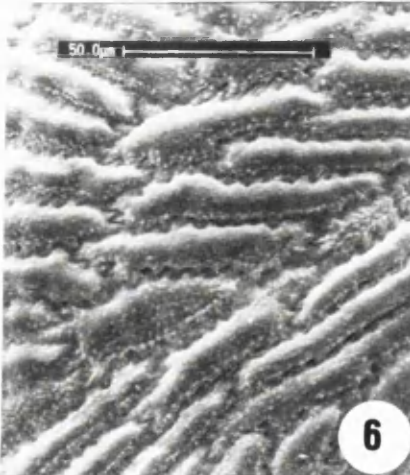
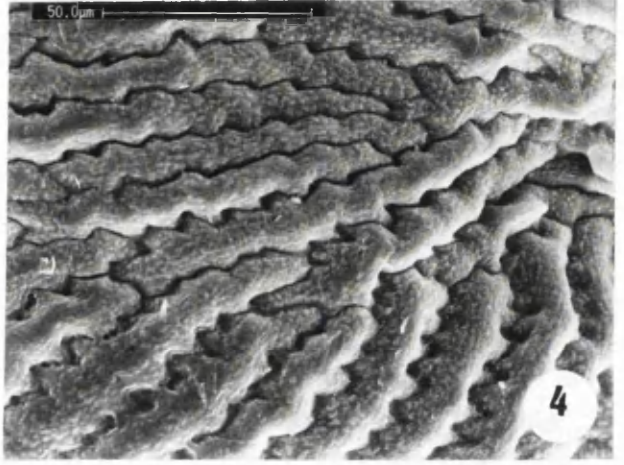
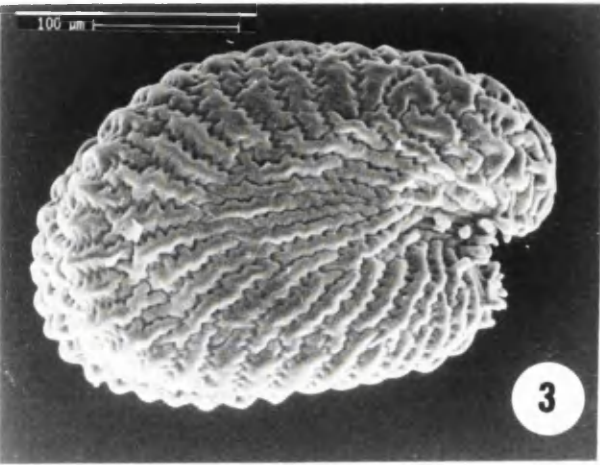
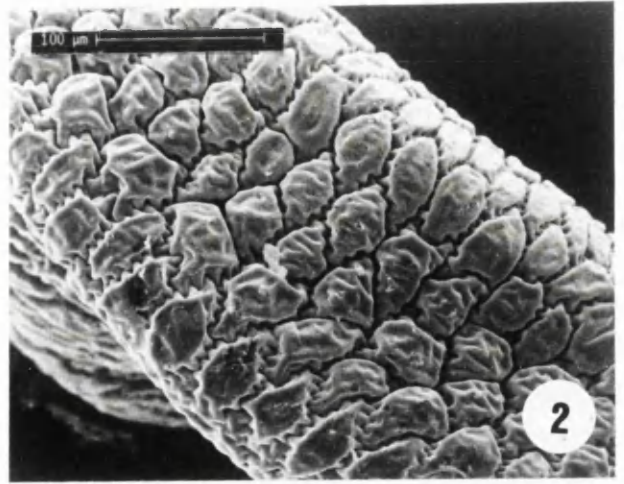
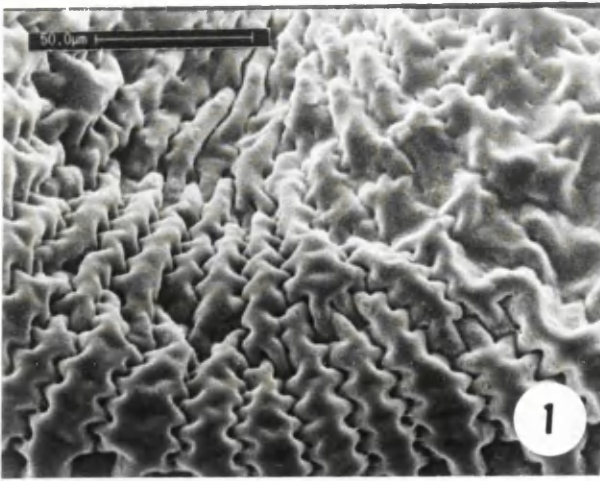

PLATE 20.

1. *Sagina apetala* (with papillae) whole seed. x 150
2. „ „ marginal face showing the tubercles. x 4800
3. *Sagina apetala* (without papillae) whole seed.
4. „ „ lateral face (midzone).
5. *Sagina martima* whole seed.
6. „ „ lateral face (midzone).
7. *Gypsophila elegans* whole seed.
8. „ „ lateral face (midzone).

PLATE 20.

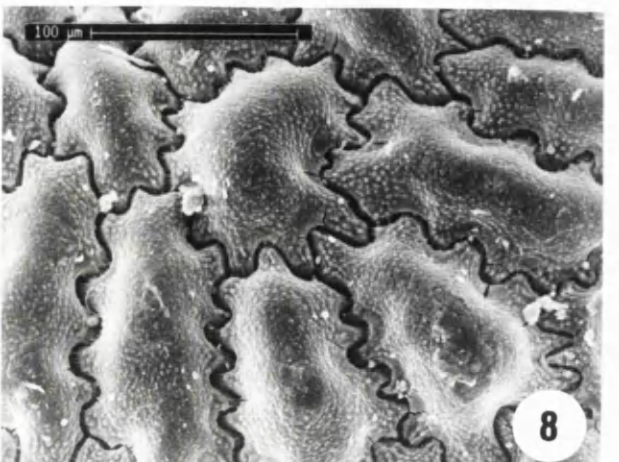
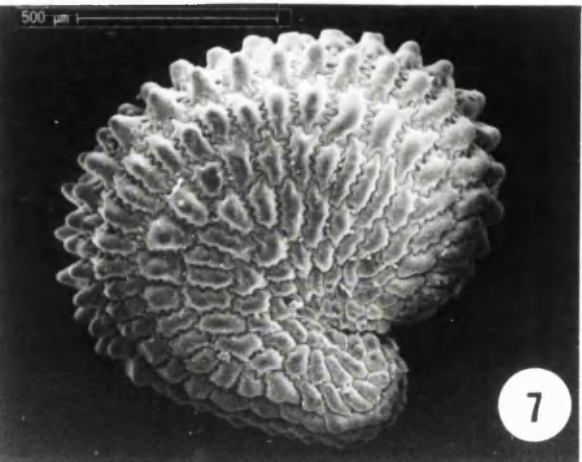
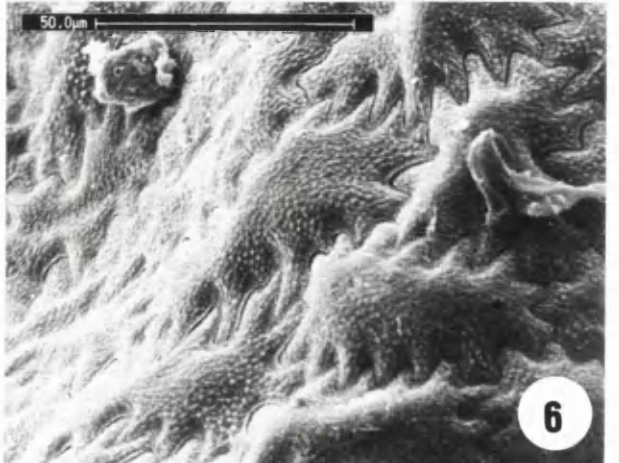
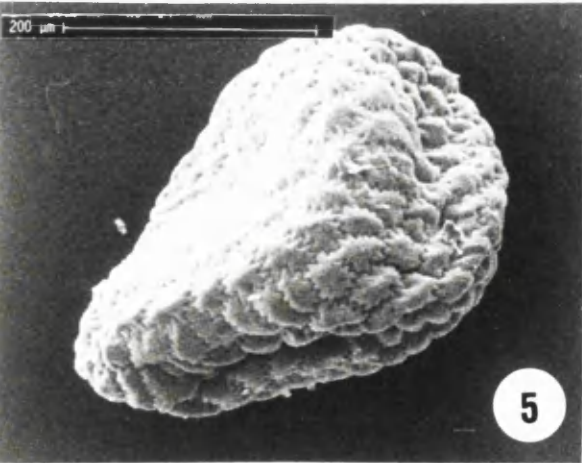
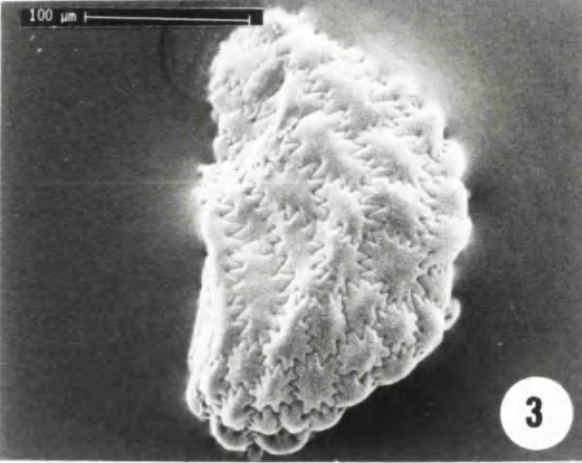
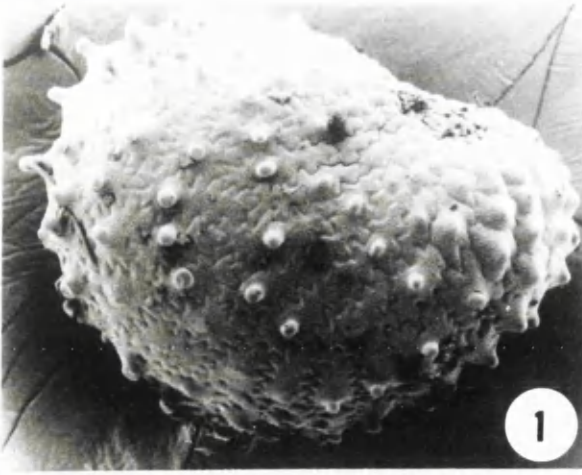

PLATE 21.

1. *Gypsophila pilosa* whole seed.
2. „ „ lateral face (midzone).
3. *Gypsophila pilosa* the radicle and marginal face cells.
4. „ „ marginal face.
5. „ „ near the hilum.
6. *Vaccaria pyramidata* near the hilum.
7. „ „ whole seed.
8. „ „ lateral face (midzone).

PLATE 21.

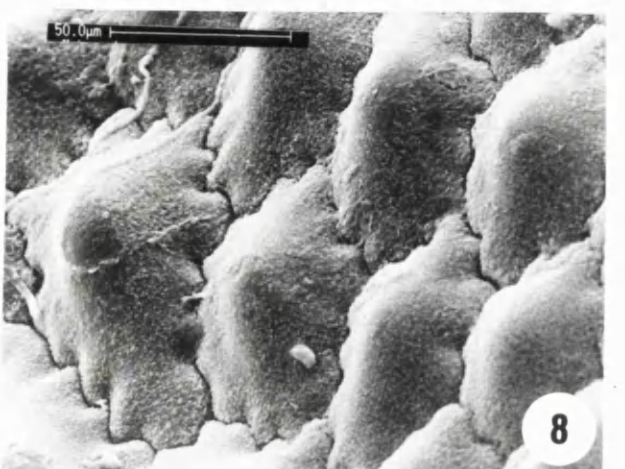
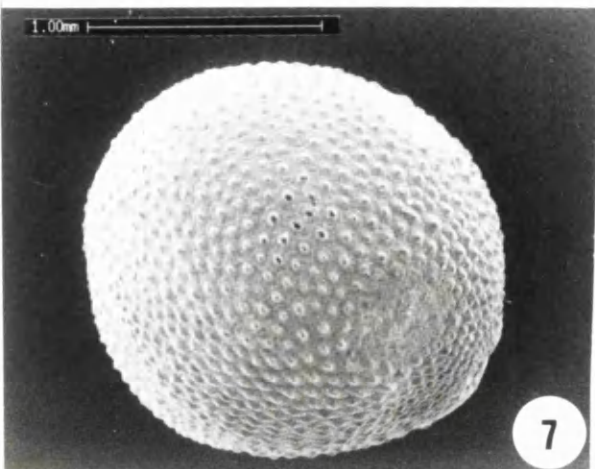
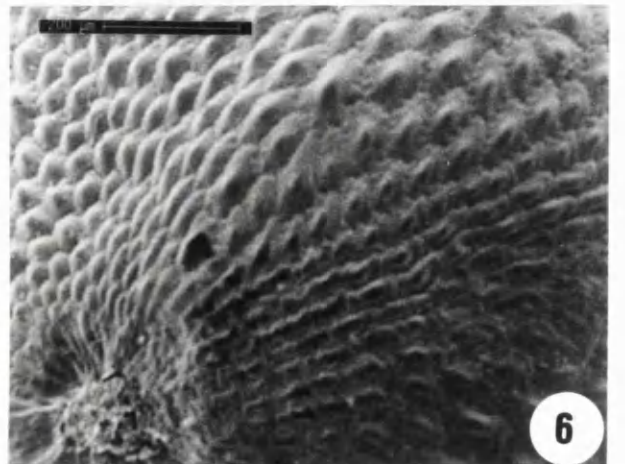
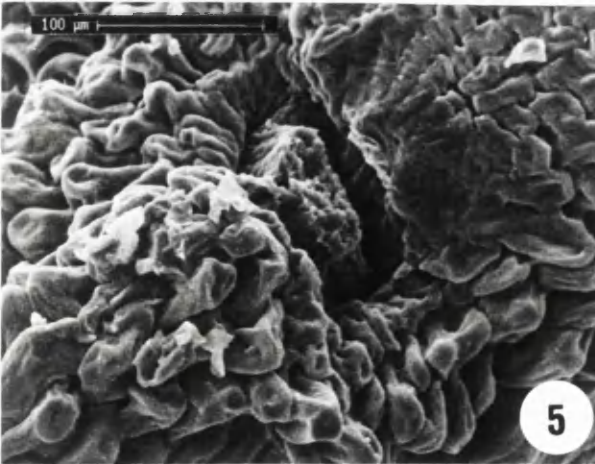
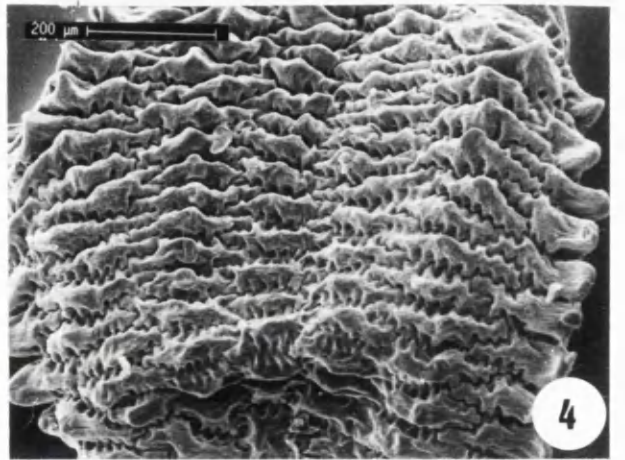
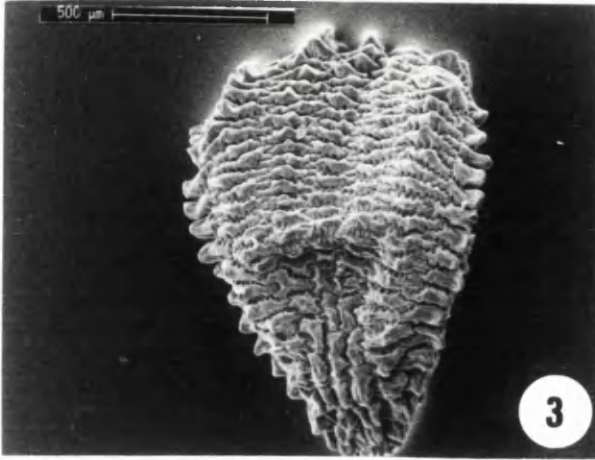
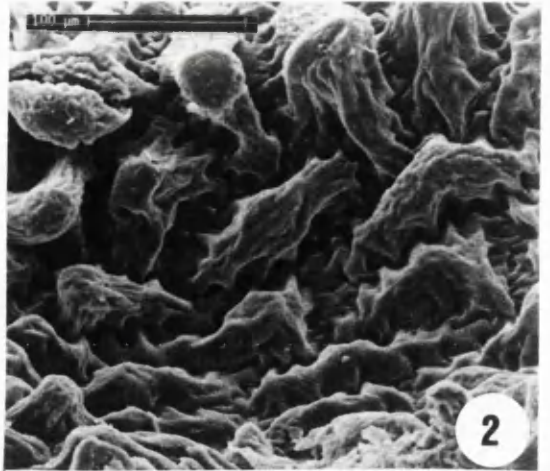
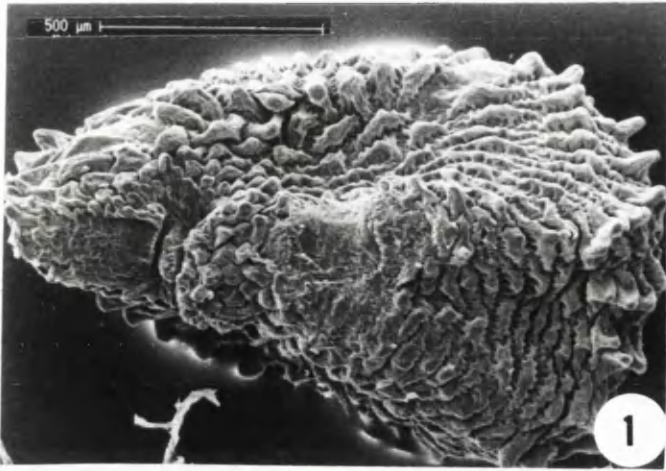

PLATE 22.

1. *Vaccaria pyramidata* whole seed. x 72.
2. „ „ „ lateral face (midzone). x 1200.
3. *Dianthus crinitus* (dorsal face) whole seed.
4. „ „ „ lateral face (midzone)
5. „ „ (ventral face) whole seed.
6. „ „ „ lateral face (midzone).
7. „ „ „ near the hilum.
8. „ „ „ dorsal face near the middle line.

PLATE 22.

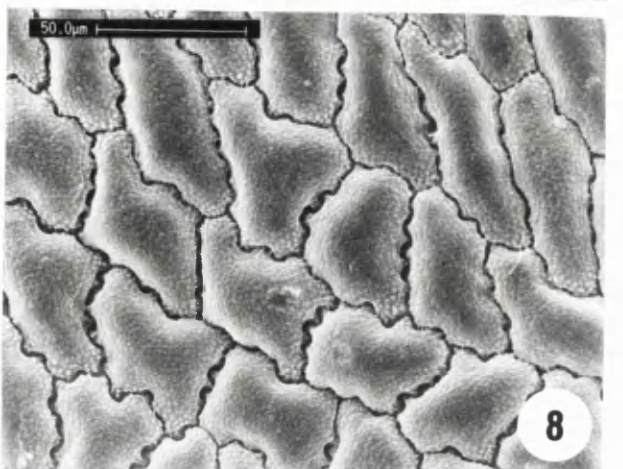
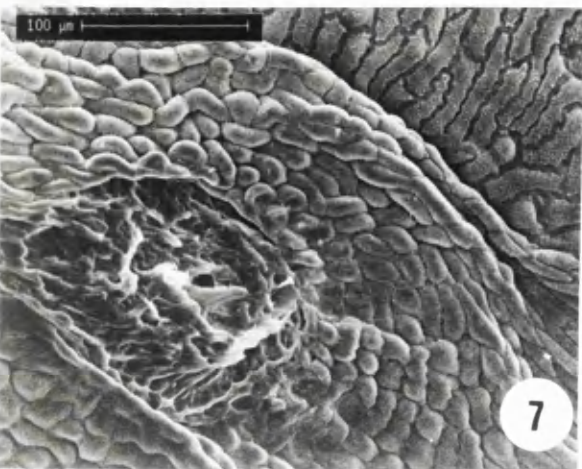
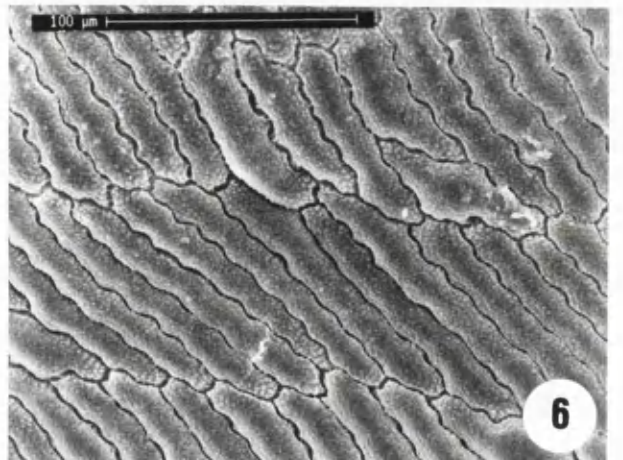
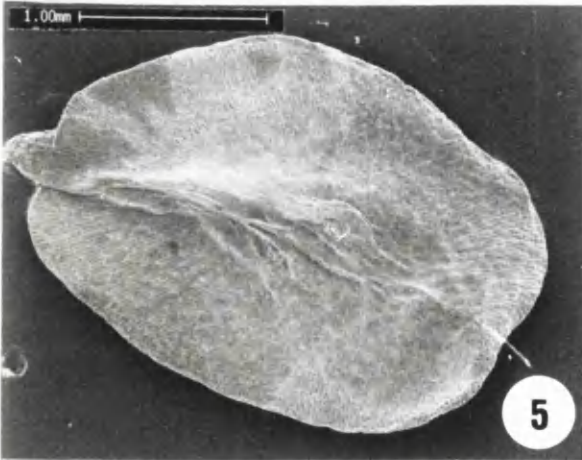
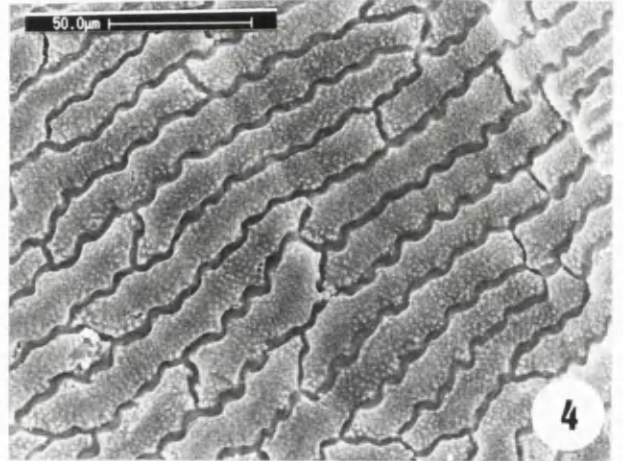
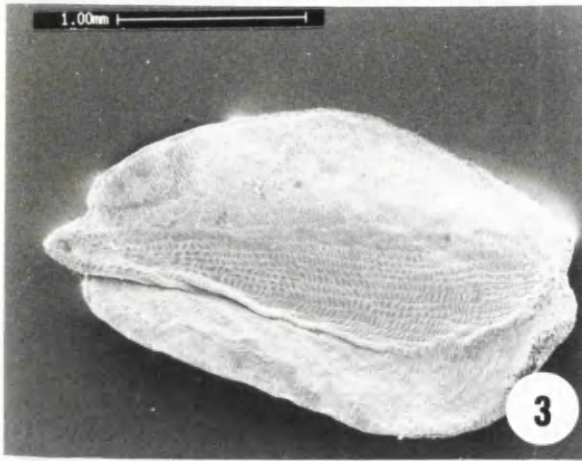
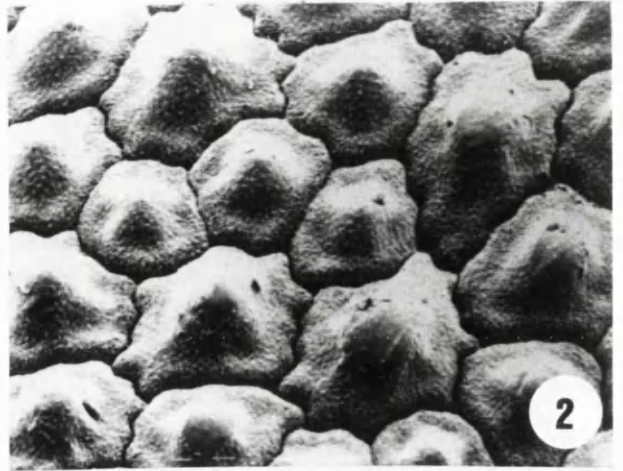
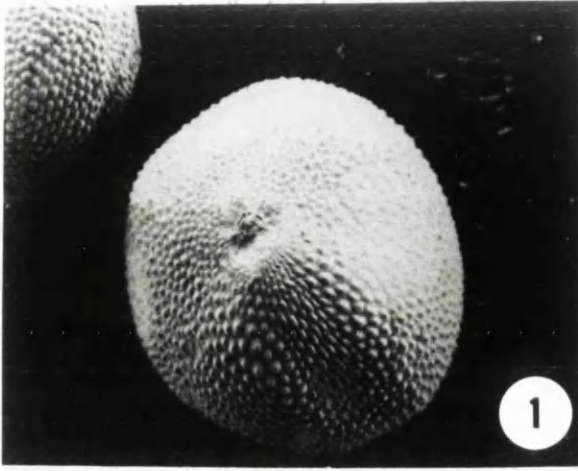

PLATE 23.

1. *Petrorhagia illyrica* whole seed.
2. „ „ „ lateral face (midzone).
3. *Petrorhagia velutina* (dorsal face) whole seed.
4. „ „ „ lateral face (midzone)
5. „ „ „ (ventral face) whole seed.
6. „ „ „ near the hilum.
7. *Silene apetala* morphotype A. whole seed.
8. „ „ „ lateral face (midzone).

PLATE 23.

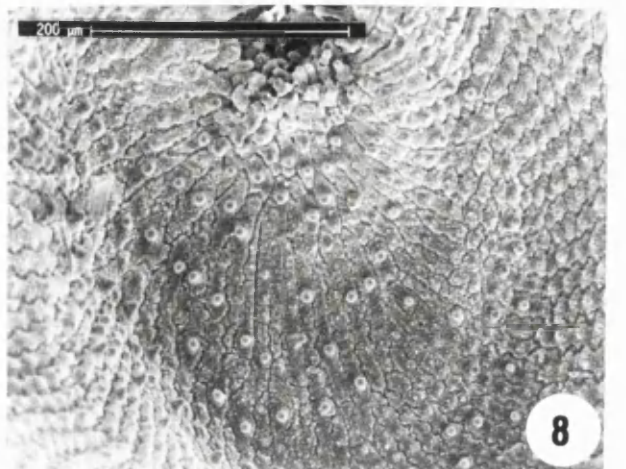
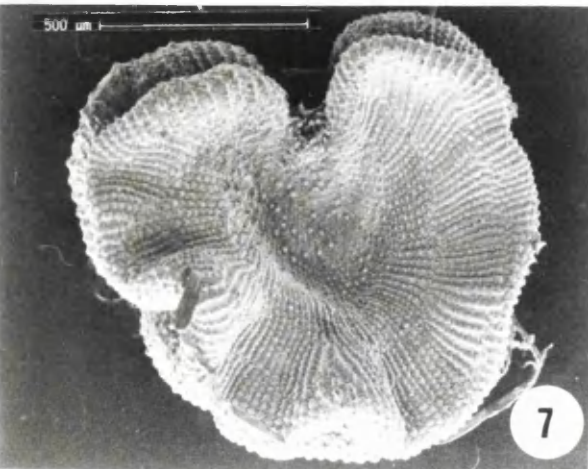
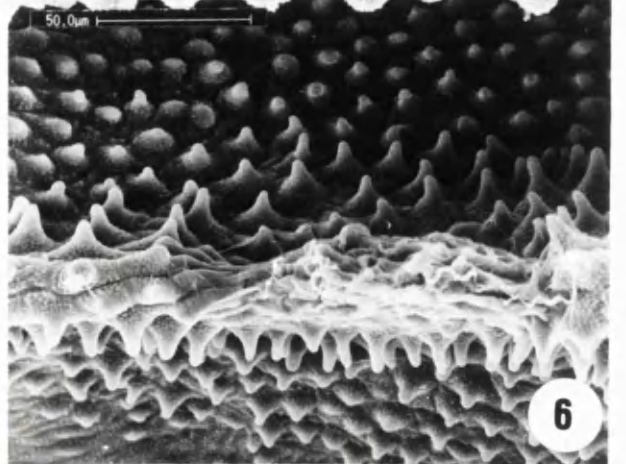
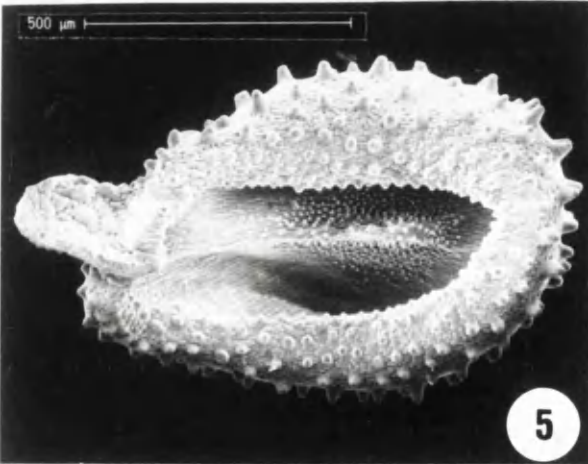
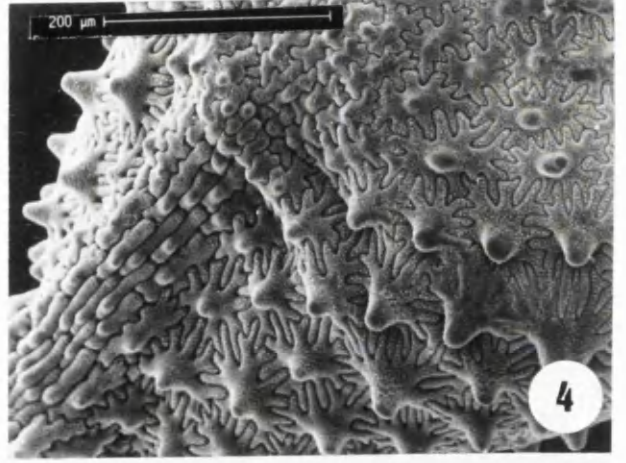
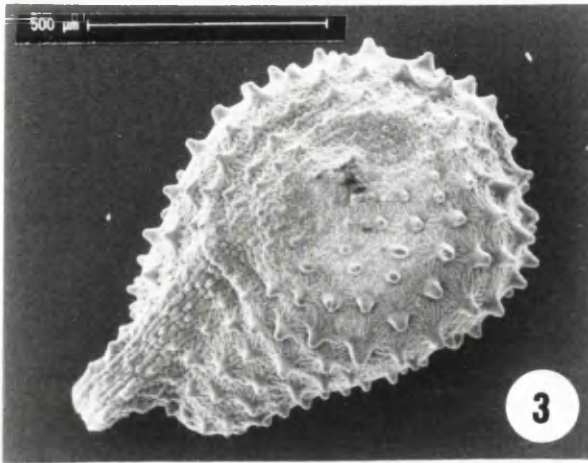
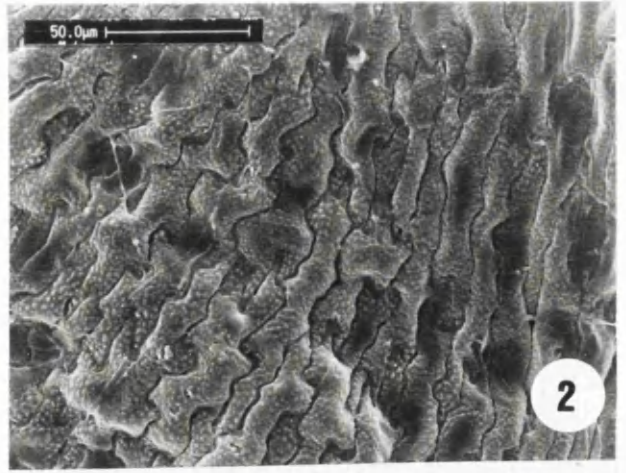
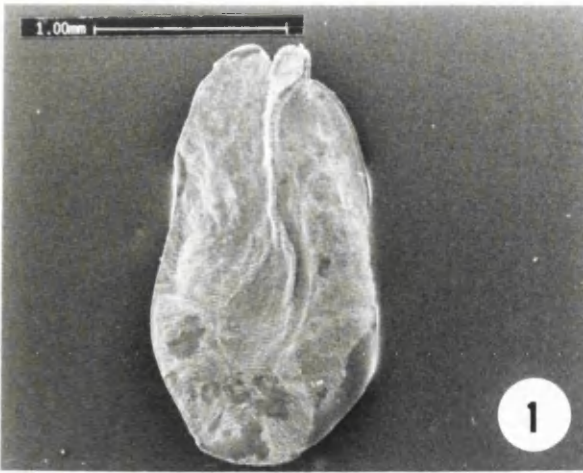

PLATE 24.

1. *Silene apetala* morphotype B. whole seed.
2. *Silene apetala* morphotype B. lateral face.
3. " " " " near the hilum.
4. *Silene apetala* morphotype C. whole seed.
5. " " " " lateral face (midzone).
6. " " " " near the hilum.
7. *Silene articulata* whole seed.
8. " " lateral face (midzone).

PLATE 24.

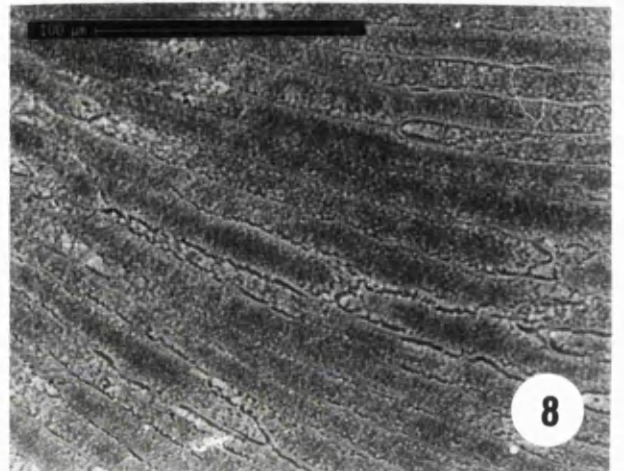
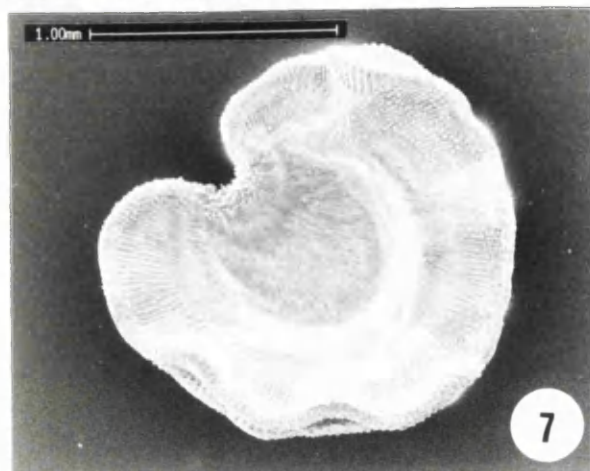
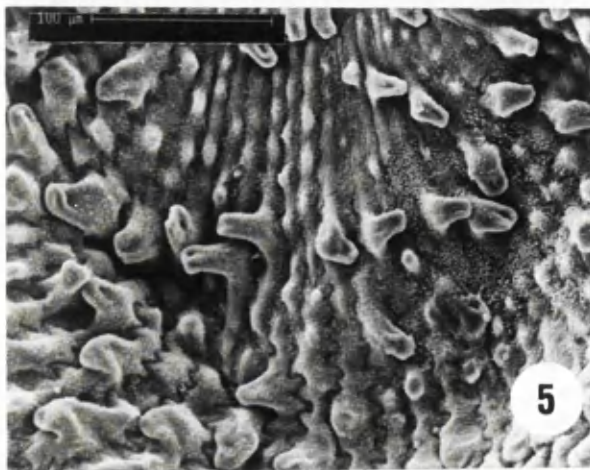
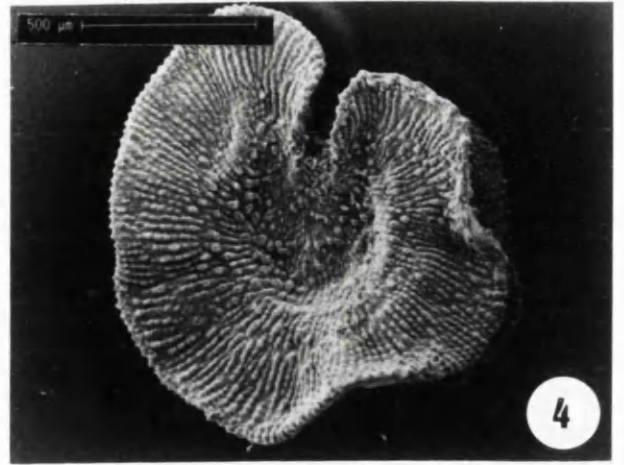
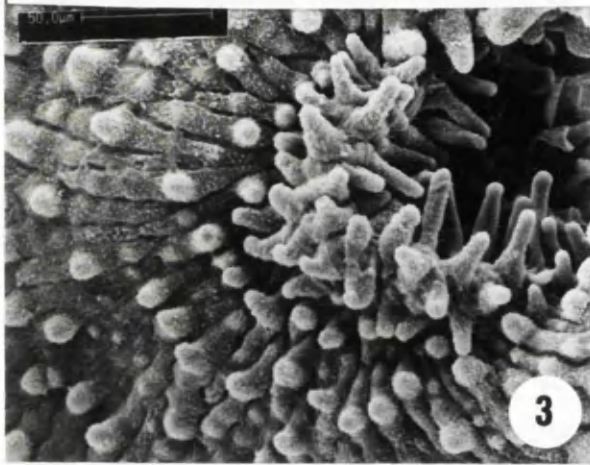
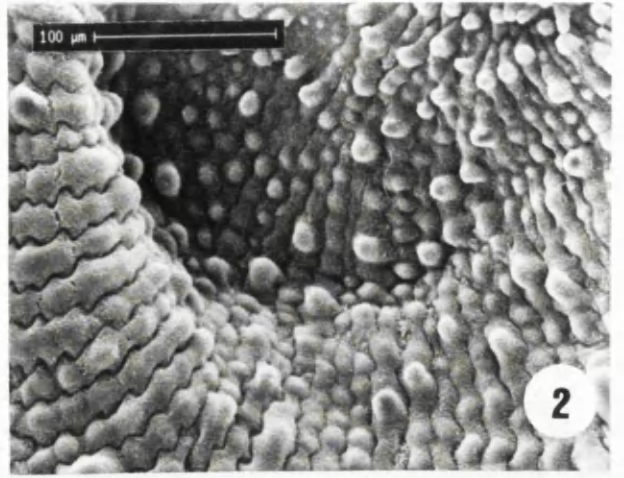
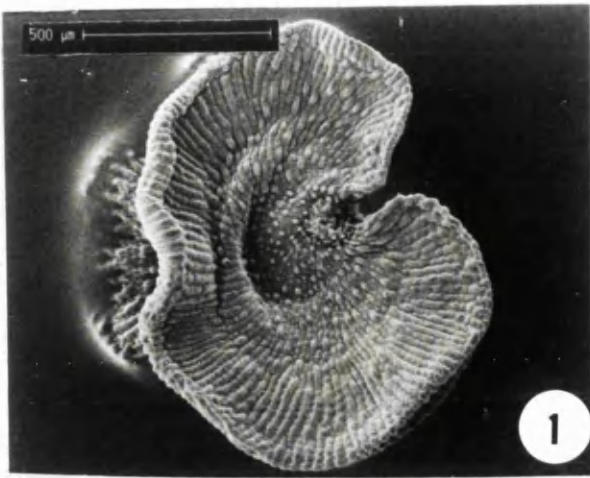

PLATE 25.

1. *Silene articulata* lateral face (midzone).
2. *Silene behen* whole seed.
3. „ „ lateral face (midzone).
4. *Silene cerastoides* whole seed.
5. „ „ lateral face (midzone).
6. *Silene colorata* subsp. *colorata* whole seed.
7. „ „ „ „ lateral face (midzone).
8. „ „ „ „ near the hilum.

PLATE 25.

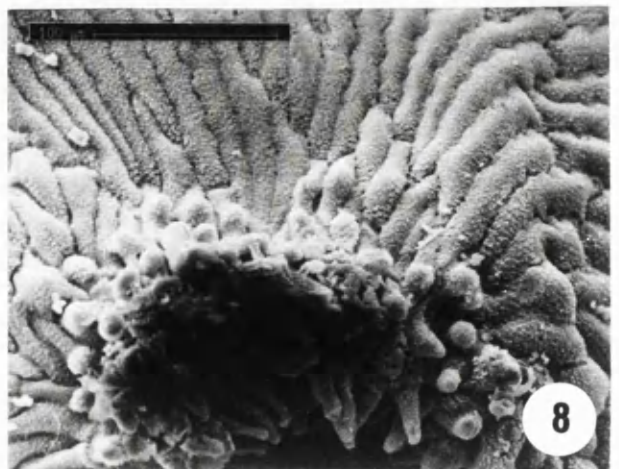
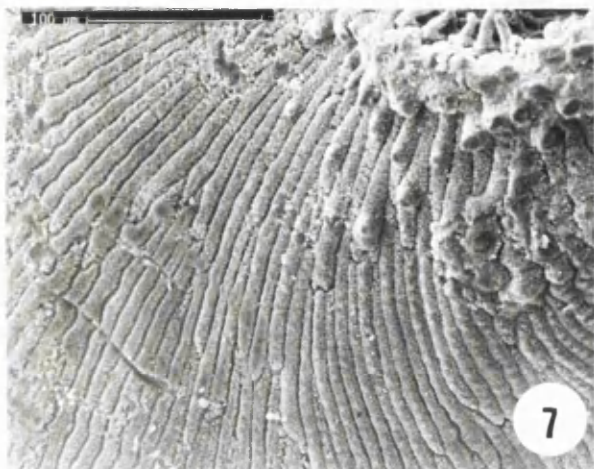
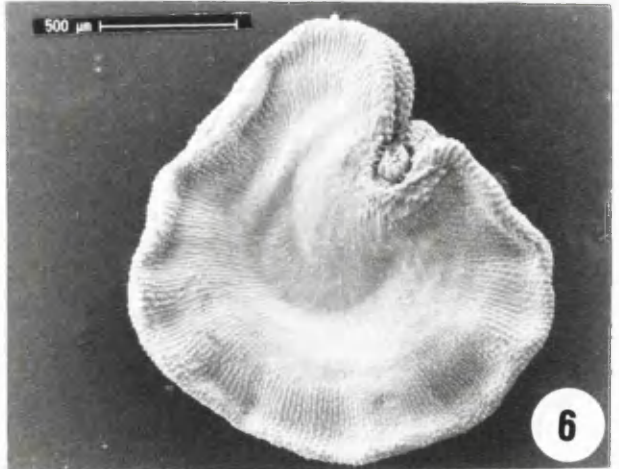
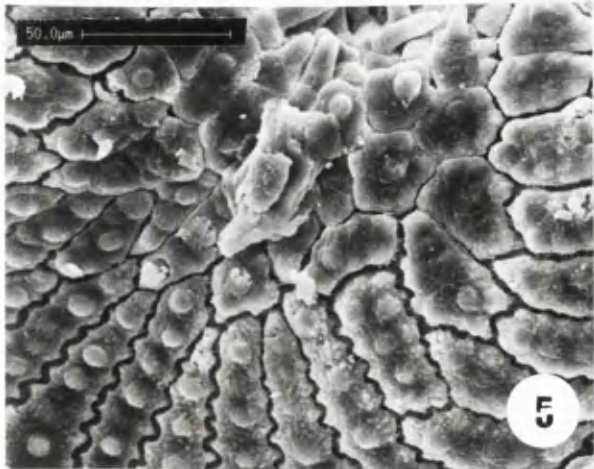
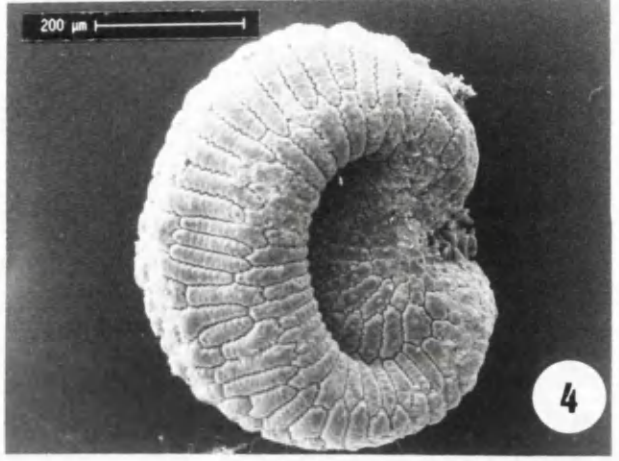
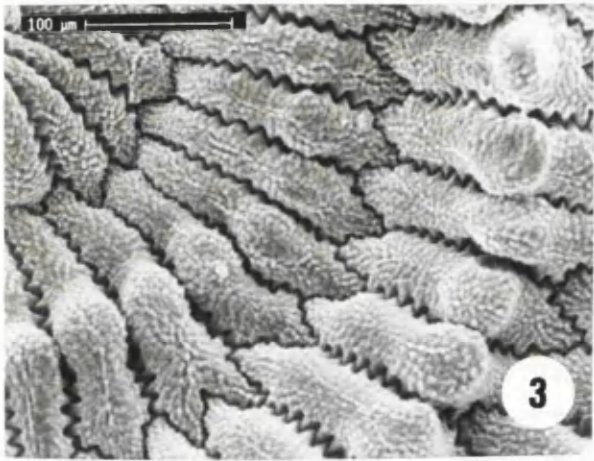
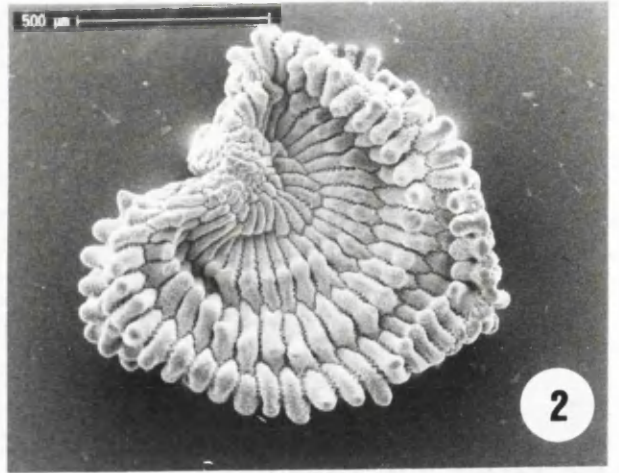
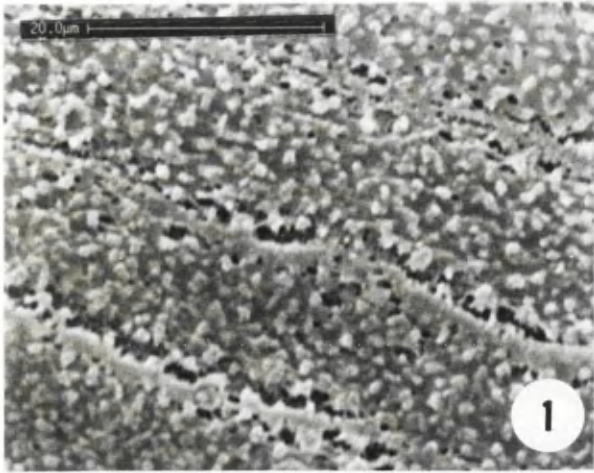

PLATE 26.

1. *Silene colorata* var. *lasiocalyx* whole seed.
2. „ „ „ „ lateral face (midzone).
3. *Silene conoidea* whole seed.
4. „ „ lateral face (midzone).
5. *Silene cyrenaica* whole seed.
6. „ „ lateral face (midzone).
7. „ „ near the hilum showing the callus.
8. *Silene fruticosa* marginal face.

PLATE 26.

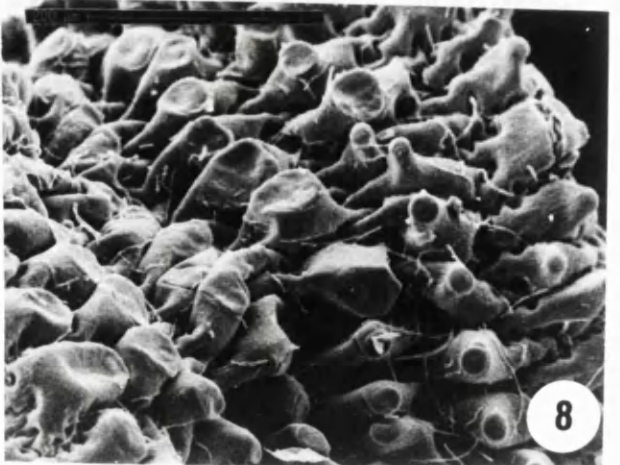
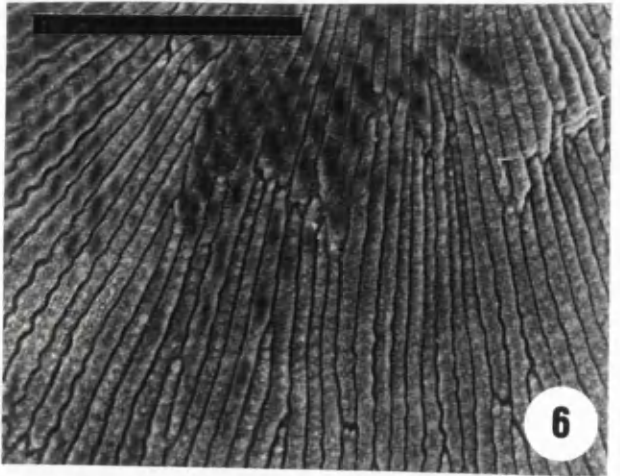
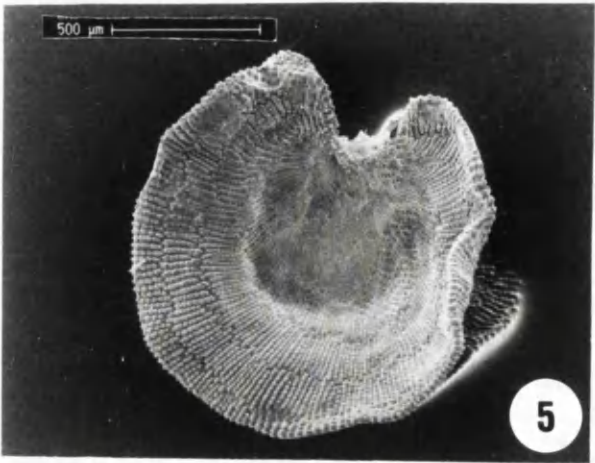
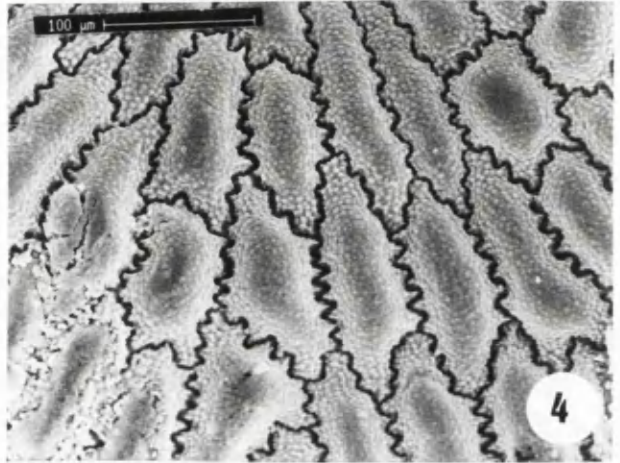
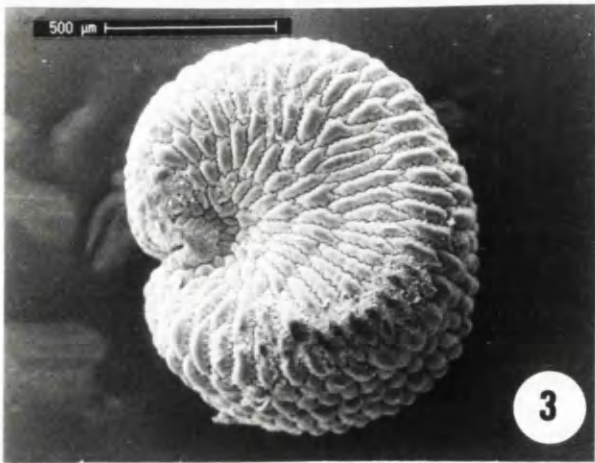
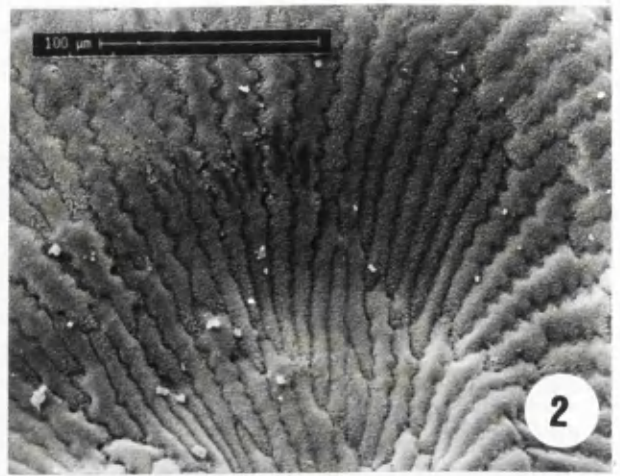

PLATE 27.

1. *Silene fruticosa* whole seed.
2. „ „ lateral face (midzone).
3. *Silene fuscata* whole seed.
4. „ „ lateral face.
5. *Silene gallica* whole seed.
6. „ „ lateral face (midzone).
7. *Silene italica* whole seed.
8. „ „ lateral face (midzone).

PLATE 27.

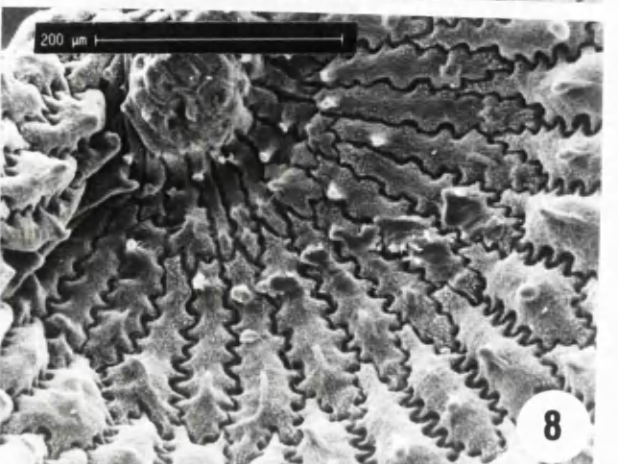
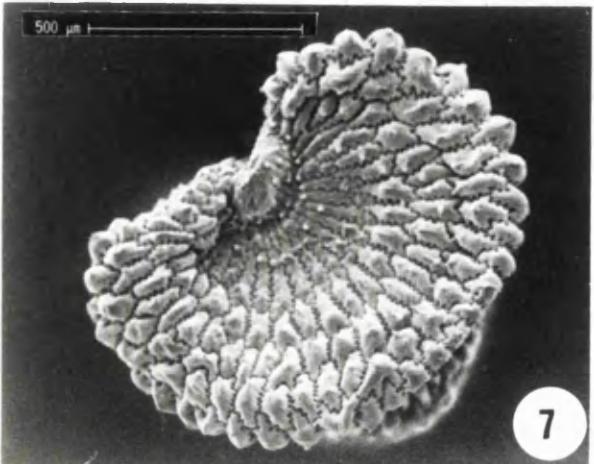
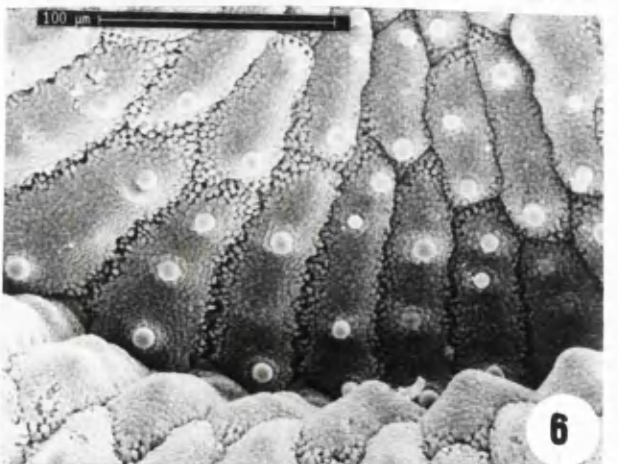
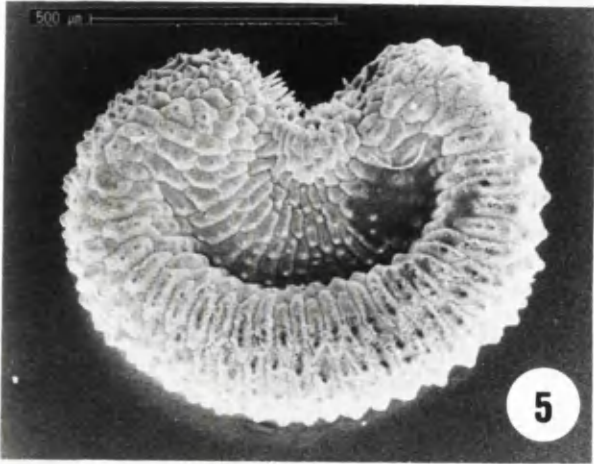
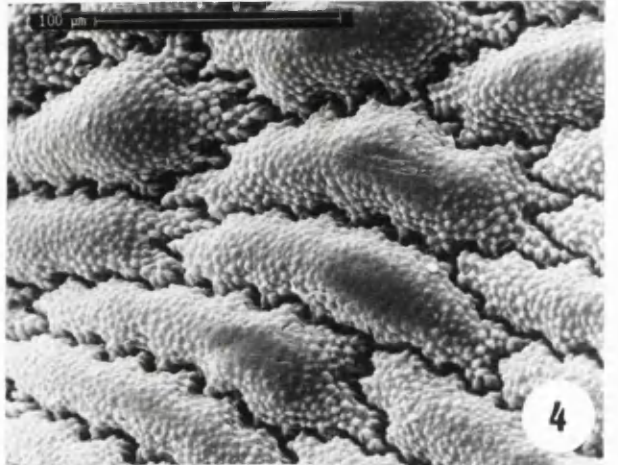
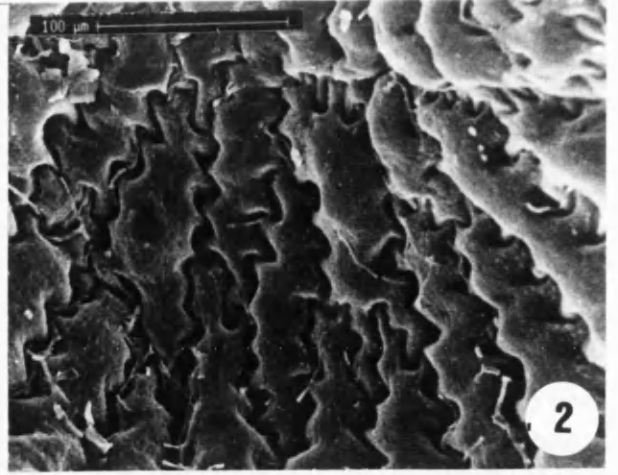
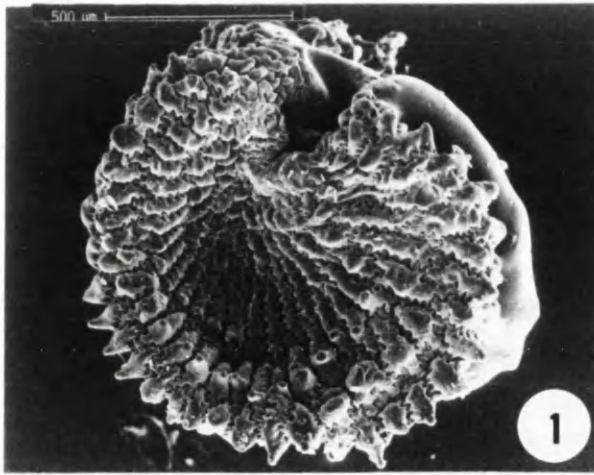

PLATE 28.

1. *Silene longipetala* whole seed.
2. „ „ lateral face (midzone).
3. „ „ near the hilum.
4. „ „ marginal face.
5. *Silene marmarica* whole seed.
6. „ „ lateral face.
7. „ „ near the hilar notch.
8. *Silene muscipula* whole seed.

PLATE 28.

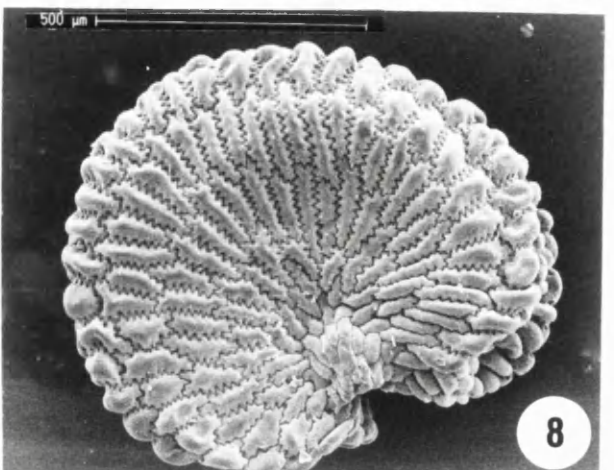
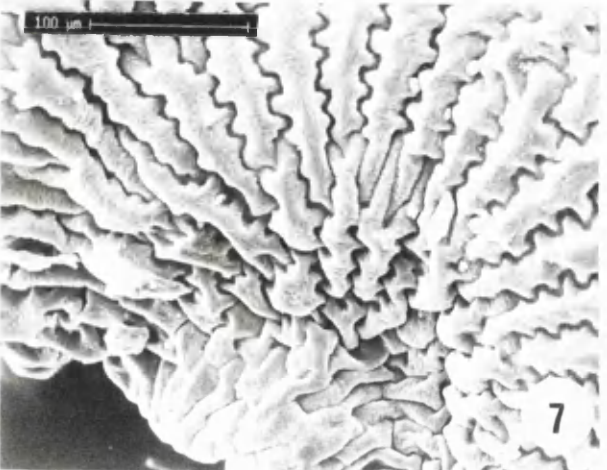
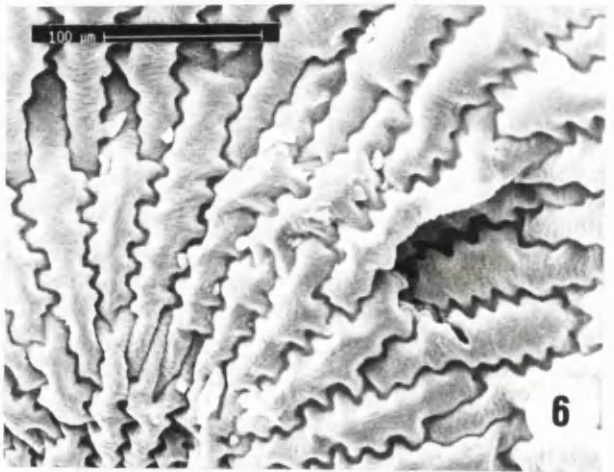
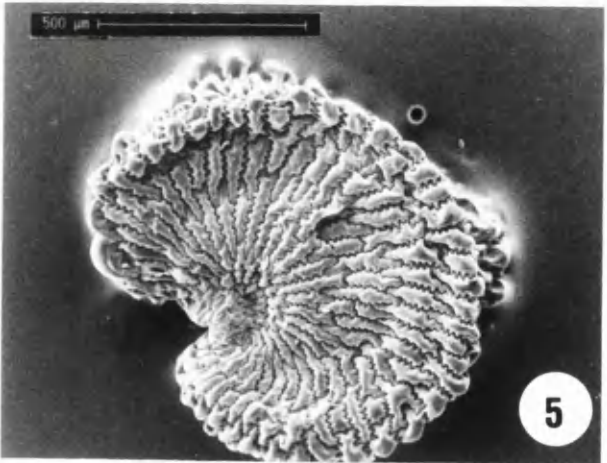
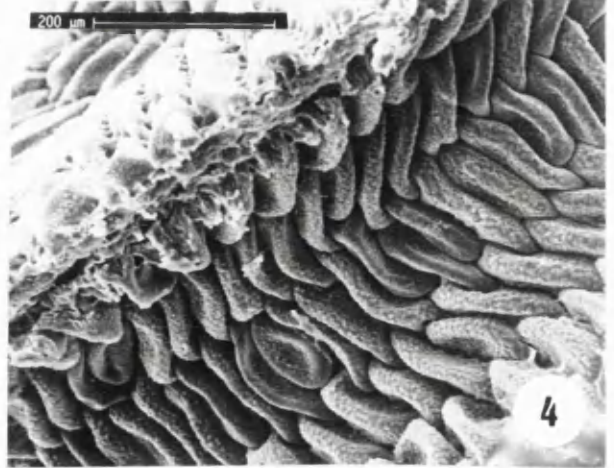
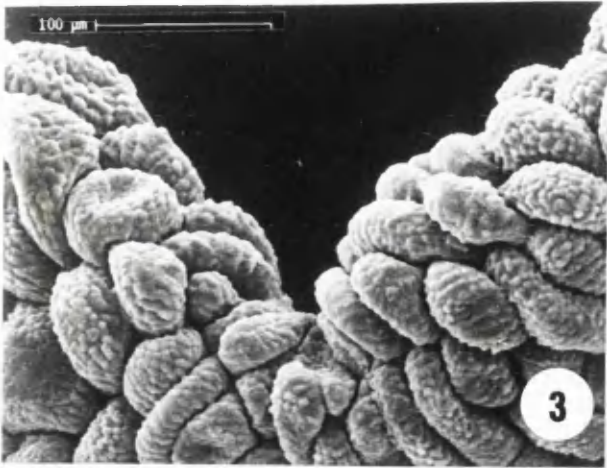
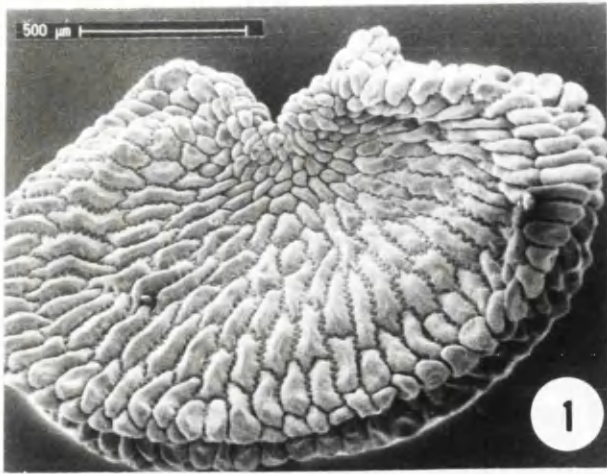

PLATE 29.

1. *Silene muscipula* lateral face.
2. *Silene nocturna* whole seed.
3. „ „ lateral face (midzone).
4. „ „ marginal face.
5. *Silene rubella* whole seed.
6. „ „ lateral face (midzone).
7. *Silene sedoides* whole seed.
8. *Silene sedoides* near the hilar notch.

PLATE 29.

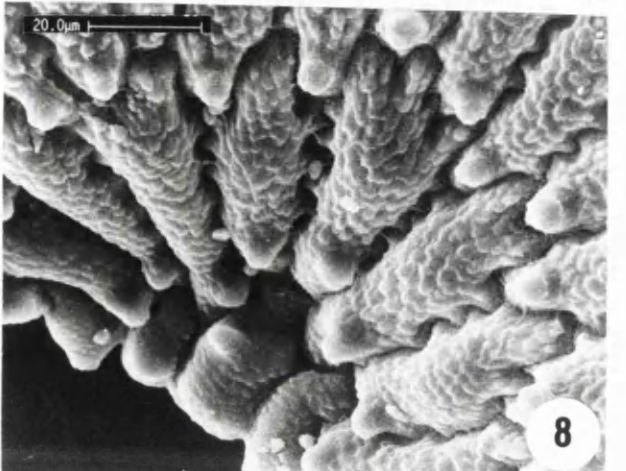
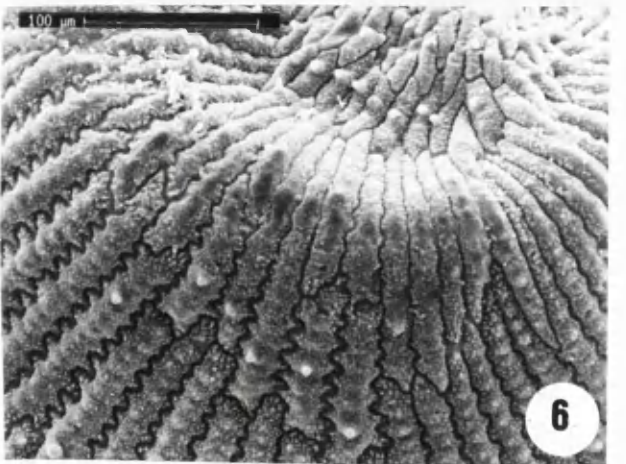
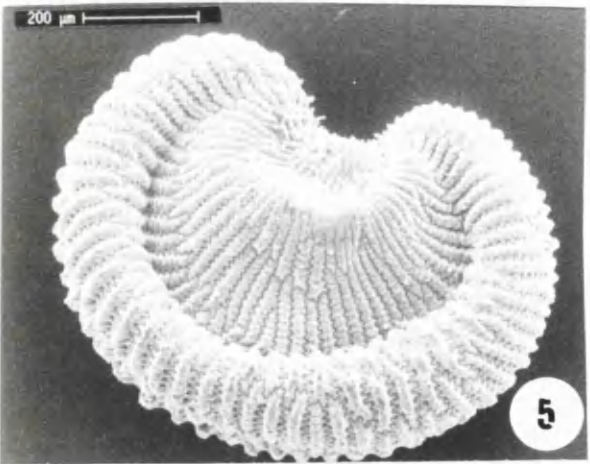
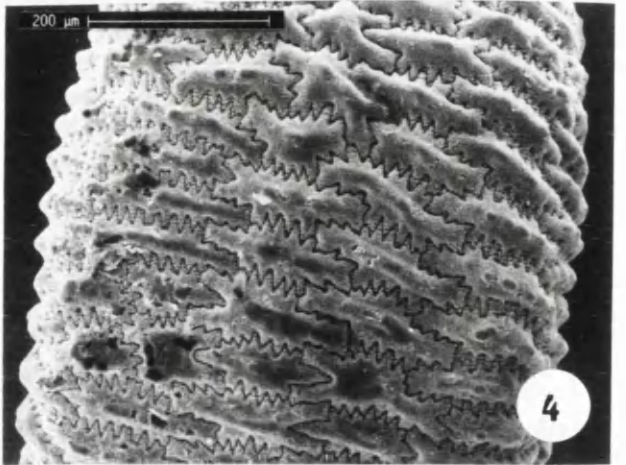
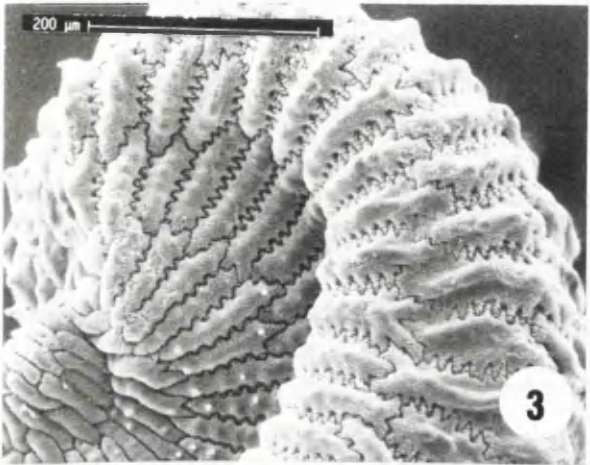

PLATE 30.

1. *Silene sedoides* lateral face (midzone).
2. „ „ marginal face.
3. „ „ near the hilum.
4. *Silene succulenta* whole seed.
5. „ „ lateral face.
6. *Silene tridentata* whole seed.
7. „ „ lateral face.
8. *Silene villosa* lateral face.

PLATE 30.

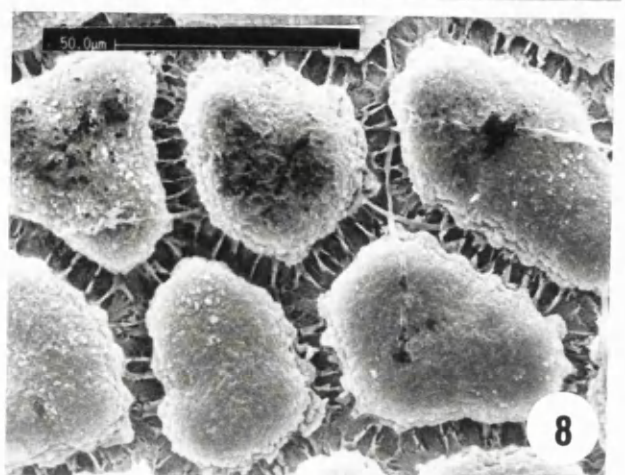
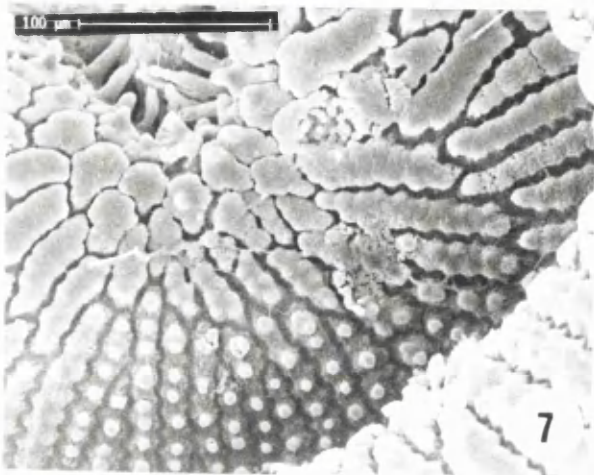
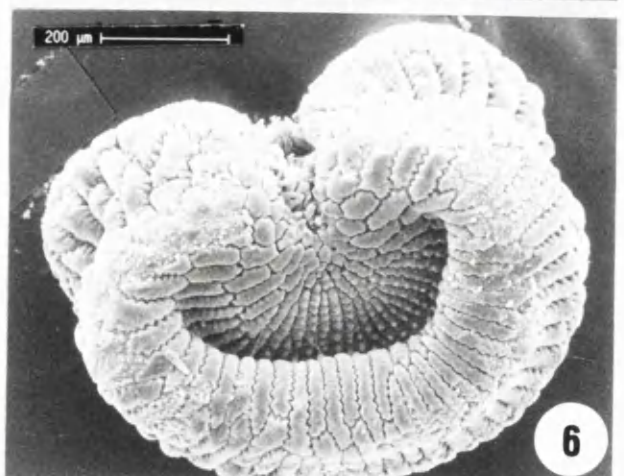
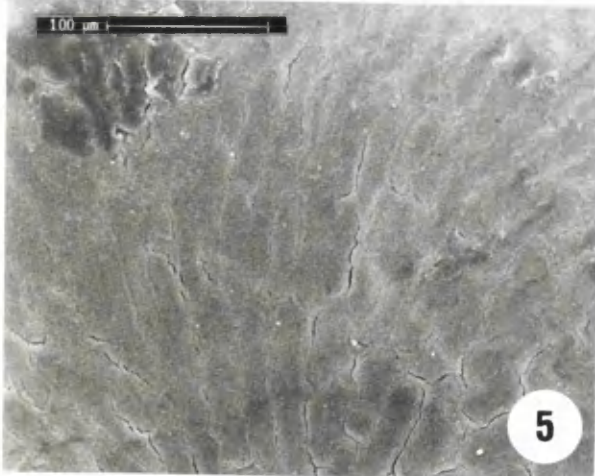
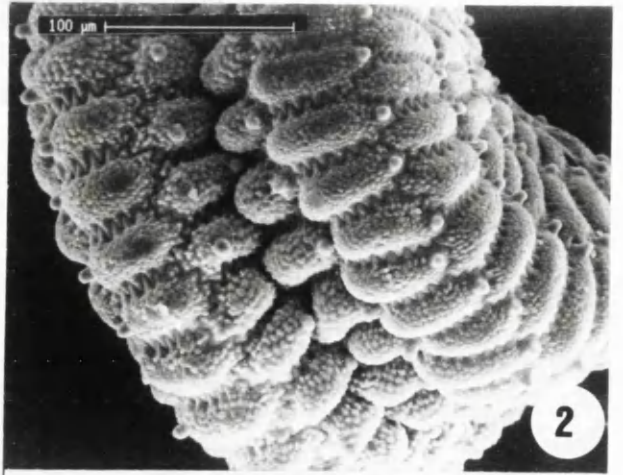
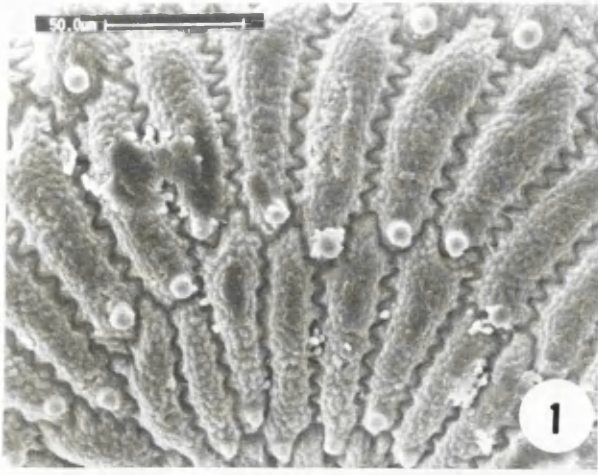
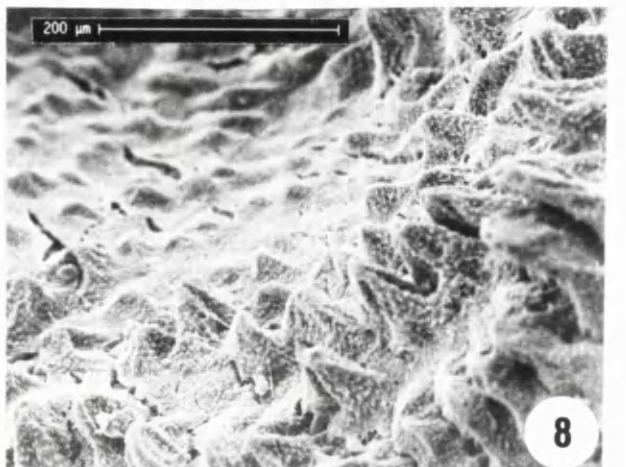
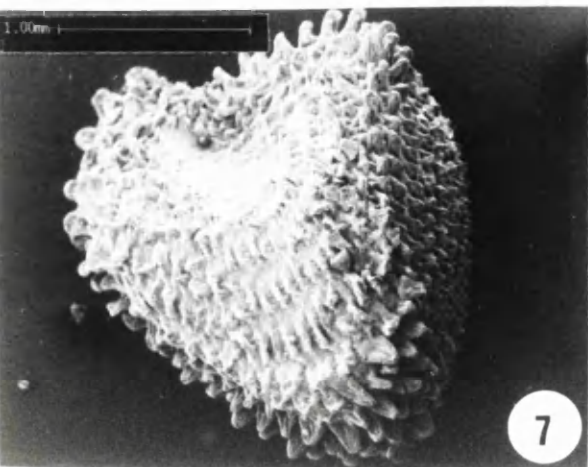
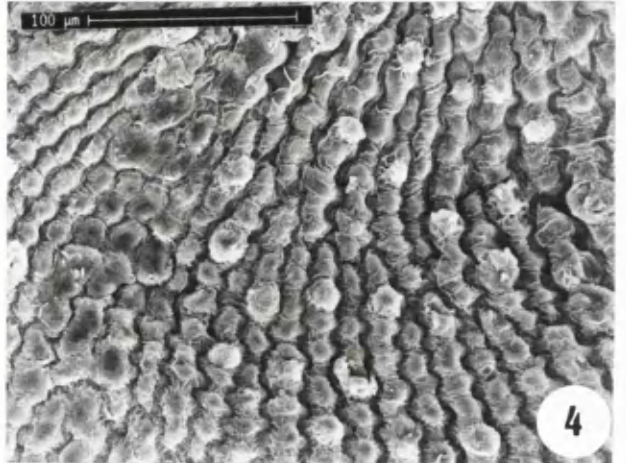
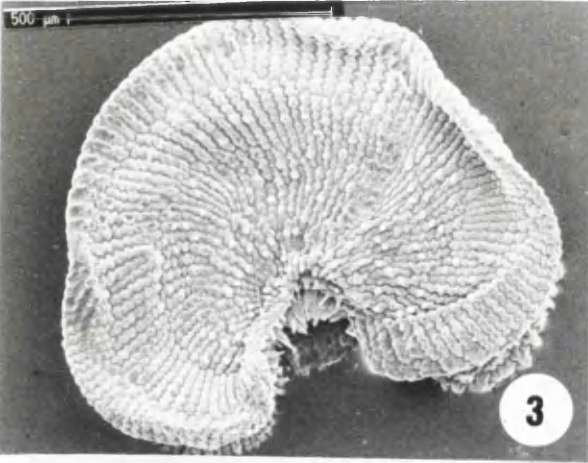
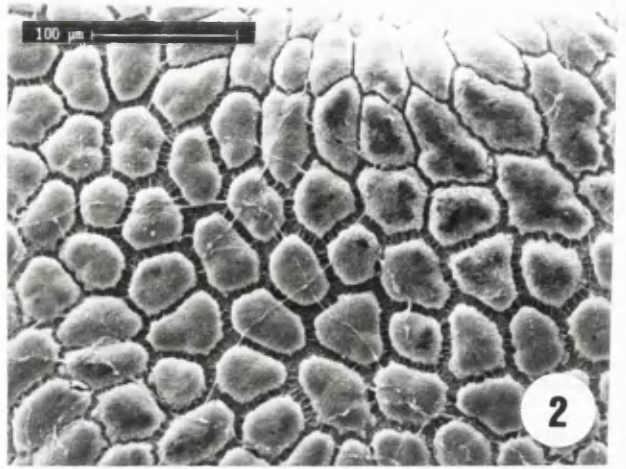
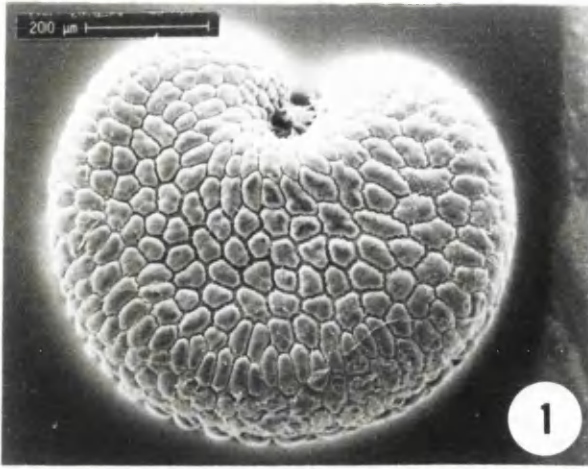

PLATE 31.

1. *Silene villosa* whole seed.
2. „ „ lateral face (midzone).
3. *Silene vivianii* whole seed.
4. „ „ lateral face (midzone).
5. *Silene vulgaris* whole seed.
6. „ „ lateral face.
7. *Agrostemma githago* whole seed.
8. „ „ lateral face (midzone).

PLATE 31.



Chapter 4.

Crystals

4.1 Introduction:

According to Arnott (1981, p.225) "The structure of the crystalline deposits of calcium oxalate in plants has been of interest to botanists since early in the 19th century. Although first discovered by Leeuwenhoek in 1675, an intensive study of plant crystals began as soon as light microscopy (LM) developed to an adequate stage". Al-Rais *et al.* (1971, P. 1217) stated " The crystals of different forms occurring in a wide variety of flowering plants growing under normal conditions can be confidently identified as consisting almost entirely of calcium oxalate". The formation of calcium oxalate crystals is very common in a great range of plant families across the world as made clear by McNair (1932). He listed 77% of tropical families and 78% of temperate ones as crystal producers.

These crystals occur mainly in five major forms: druses, crystal sand, prisms, raphides and styloids (Metcalf and Chalk, 1950; Eames and MacDaniels, 1947; Cutter, 1969; Esau, 1977; Franceschi and Horner, 1980; Fahn, 1982). The crystals can occur in tissues of the leaf laminae, petioles, flowers, stems, fruits and seeds; they can be associated with specific tissues, e.g. epidermis, cortex, xylem, phloem and pith (Bohn, 1925; Scott, 1941; Price, 1970; Laurance, 1976; Buttrose and Lott, 1978; Horner and Franceschi, 1978; Horner and Wagner, 1980; Arnott, 1981; Kausch and Horner, 1983).

In their important summarising paper Franceschi and Horner (1980) considered several reviews published in the previous two decades. They discussed the significance of calcium oxalate and oxalic acid in plants in a variety of ways, but did not consider taxonomy in detail. There are detailed

accounts of the importance of the shape, size and number of crystals within the idioblasts as well as the development and ultrastructure of idioblasts and of the function of oxalate crystals.

The occurrence and abundance of crystals in specific tissues of various plants is often so constant as to be useful as a taxonomic tool (Metcalf and Chalk, 1950). The observation that crystals of calcium oxalate are found associated with some bast fibres but not with others has been used as a guide to identification by Jarman and Kirby (1955) who were concerned with separating jute (*Corchorus capsularis*) from jute substitutes. Agreeing with Metcalfe and Chalk, Al-Rais *et al.* (1971, p.1213) stated "many flowering plant species produce relatively unreactive intracellular crystals, usually referred by anatomists to calcium oxalate. These can vary considerably in form from species to species and sometimes also from one region of the plant to another; but in general the crystal forms or combinations of forms are characteristic of species or higher taxonomic groupings, so that they constitute useful classificatory criteria...". SEM was used to study the shape and location of the crystals in the perennial woody stems of many families by Scurfield *et al.* (1973).

The detailed and direct application of crystals to taxonomic problems was made by Dormers (1961,1962). He (1961) recorded crystals of differing forms in the ovary wall of many Compositae, some of which were of very restricted taxonomic distribution. In a more extensive study of the genus *Centaurea*, Dormer (1962) studied 112 species, and on the basis of crystal forms, made suggestions for taxonomic changes at the subgeneric and sectional levels. Franceschi and Horner (1980) briefly consider a variety of other papers dealing with the taxonomic importance of crystals. Patterns of calcium oxalate were evaluated as a taxonomic tool for studying *Camellia sasanqua* X *sinensis* and *Agrimonia* by Umemoto

(1981) and Murata and Umemoto (1983). Koteswar and Ramayya (1984) showed the importance of crystal size, shape and distribution in 26 species of *Ficus*; their key for identification was based on the crystals and crystalliferous elements. Investigating the crystals of the corm tunics of *Crocus* bulbs, Wolter (1990) found that the prismatic shape was restricted to a few closely related taxa. He made taxonomic assessments at the infrageneric level.

In the Caryophyllaceae, Amar (1904) recognised three types of distribution of crystals within roots, stems and leaves and she discussed particularly *Tunica saxifraga*, *Dianthus carthusianorum* and *Saponaria officinalis*. Bohn (1925) pointed out the presence of calcium oxalate in the epidermal cells of *Lychnis flos-jovis*, *Silene dioica* and *Spergula arvensis*; in the leaves of these three species different forms, shapes and sizes of crystals were observed. Haberlandt (1914, p.531) stated that "genuine sphaerocrystals" had been reported from "*Silene cucubalus* and certain other Caryophyllaceae (according to Hegelmaier)". In the few previous studies of crystals in the Caryophyllaceae no taxonomic conclusions had been made (Amar, 1904; Bohn, 1925; Metcalfe and Chalk, 1950) for any genus, not even *Minuartia* which has now been investigated in detail. For the Caryophyllaceae Metcalfe and Chalk (1950, p. 150) stated. "Calcium oxalate commonly present in the form of large, conspicuous cluster crystals in many genera and species including *Arenaria*, *Corrigiola*, *Gymnocarpos*, *Minuartia* sp., *Pteranthus*, *Scleranthus*, *Silene*. The abundance of the crystals sometimes varies within a single species in specimens from different localities. Crystal-sand also recorded in *Dysphania*, *Gymnocarpos*, *Habrosia*, and other genera."

In the present investigation, the results of studies on type,

shape, size and distribution of crystals in mature leaves of *Arenaria* (86 spp), *Moehringia* (15 spp) and *Minuartia* (60 spp) are presented and their taxonomic significance evaluated. In the following assessment the results are compared with the taxonomic treatment of the generic and infra-generic groups of McNeill (1962-1963). Some nomenclatural changes made by Rabeler (1993) have been followed.

4.2 Morphology and Distribution of Foliar Crystals in the Genera *Arenaria*, *Moehringia* and *Minuartia*

Within the three genera the crystal were found to be druses, sand and elongate. No raphides or styloids were encountered, either singly or aggregated.

Druses: These are spheroidal aggregates of prismatic crystals found in all three genera, (c. 8-97 μm) diam. See Plates 32, 33 (1 to 6), 36 (1 and 2).

Crystal sand: Very small spheroidal or prismatic crystals in ellipsoidal or spheroidal masses, found in *Arenaria* and *Minuartia* but not in *Moehringia*, (c. 10-29 μm) long See Plates 33 (7 and 8), 34 (1,2 and 4), 35, 36 (3 to 8).

Elongate crystals: These resemble very rough-skinned cigars. They appear to be aggregates, large to very large, up to 230 μm in length. In overall shape and size these crystals are unlike anything reported in the literature cited above, (c. 39-233 μm) long. Though their formation is not understood they have taxonomic significance as discussed below. They are found in *Arenaria* and very strikingly in *Minuartia* but not in *Moehringia*. Plates 34 (5 to 8), 35 (1 to 3,5 to7), 37.

The patterns of crystal distribution discussed in the next section are illustrated in Figure 4.

4.2.1 *Arenaria* L.

I. Subgenus *Leiosperma* McNeill

Distribution: Is confined to the New World, and has its great centre of diversity in the Andes. Probably all the South and Central American species of *Arenaria* belong to one of two subgenera, *Leiosperma* or *Dicranilla*.

A. alsinoides: Druses, dense, scattered irregularly throughout the leaf, except the veins, mostly spheroidal with irregular margins and very sharp points; size mostly large c. 29-68 μm diam., Plate 32 (2,3), plate 36 (1).

A. decussata: Druses, dense, scattered irregularly throughout the leaf, except the veins, spheroidal with irregular margins, with sharp or blunt points; size mostly large 29-68 μm diam.

A. guatemalensis: Druses, dense, scattered irregularly throughout leaf, except the veins, spheroidal with irregular margins, with very sharp points; size mostly large 29-68 μm diam.

A. lanuginosa: Druses, dense, scattered irregularly throughout the leaf, except the veins, with mixed shapes and sizes, mostly spheroidal, ellipsoidal or polygonal, margins irregular with sharp or blunt blunt points; size 10-78 μm diam.

A. lycopodioides: Similar to *A. guatemalensis*; size c. 0.2-0.5 mm diam. .

A. paludicola: Druses, mostly few, scattered irregularly throughout the leaf, except in the veins, mostly spheroidal, with regular margins and blunt points, size mostly medium or large, 19-68 μm diam., Plate 33 (3,4,5).

A. reptans: Similar to *A. guatemalensis*.

II. Subgenus *Dicranilla* (Fenzl) William

Distribution: The distribution is similar to the previous subgenus *Leiosperma*.

A. boliviana : Druses, few, scattered irregularly throughout the leaf, along veins, mostly with irregular margins and blunt points; size mostly medium or large, 29-68 μm diam.

A. bryoides : Similar to *A. boliviana* .

A. pycnophylla : Druses, dense, scattered irregularly throughout the leaf except in the veins, margins irregular, with sharp points, mixed sizes, 10-68 μm diam.

III. Subgenus **Porphyrantha** (Fenzl) McNeill

Pyrenees and the Cantabrian Mountains

A. purpurascens : No material studied.

IV. Subgenus **Arenaria**

A. Sectio **Rariflorae** Williams

Distribution: Is widely distributed Arctic-Alpine group occurring throughout the northernmost parts of Europe and America and extending south into the mountains of C. Europe, Spain, the Balkans, Anatolia and Iran.

A. ciliata : Druses, dense, scattered irregularly throughout the leaf, except in the veins, spheroidal, margins irregular. with sharp points; size 19-78 μm diam.

A. humifusa : Druses, few, scattered irregularly throughout the leaf, except the veins, spheroidal, margins irregular with sharp points, size mostly large 19-58 μm diam.

A. huteri. Similar to *A. humifusa*.

A. pseudofrigida ,, ,, ,,

B. Section Grandiflorae McNeill

Distribution: Section Grandiflorae, which is closely related to section Rariflorae, comprises two species complexes, one in S. W. and C. Europe and one in Turkey .

A. grandiflora: Druses, dense, scattered irregularly, mostly concentrated along veins, spheroidal, margins mostly irregular with sharp points; size 10-49 μm diam., Plate 32 (5,6).

A. incrassata: Druses, dense, Scattered irregularly throughout the leaf except the veins, margins irregular with sharp points; size 19-58 μm diam.

C. Sectio Plinthine (Reichb.) McNeill

Distribution: It is a very distinctive group of plants endemic to the Iberian Peninsula and North Africa .

A. armerina : Druses, very dense, scattered throughout the leaf except on veins, spheroidal, margin regular with blunt points; size 10-29 μm diam.

A. lithops : Druses, dense, scattered irregularly throughout the leaf except the veins, spheroidal, margins regular with sharp points, mostly small size 10-49 μm diam.

A. tetraquetra: Similar to *A. lithops* size 10-29 μm diam. .

D. Sectio Rotundifoliae McNeill

Distribution: Greece, Turkey, Armenia and Georgia.

A. biflora : Druses, few in number, scattered throughout the leaf area except the veins, spheroidal, margins regular with blunt points; size 19-58 μm diam.

A. halacsyi : Similar to *A. biflora*; but margins irregular, with sharp points; size 29-116 μm diam.

E. Sectio Planosepalae McNeill

Distribution: A single species of the sections, is confined to the Iberian Peninsula and South-west France and appears to be taxonomically rather isolated .

A. montana: Druses, very dense, scattered throughout the leaf area except the veins, spheroidal, margins irregular, with sharp points; size 19-78 μm diam., Plate 32 (7,8).

F. Sectio Orientales McNeill

Distribution: The centre of distribution of the section is the Eastern Mediterranean .

F. (I). Series Anomalae McNeill

A. bertolonii : Druses, dense, scattered throughout the leaf except in the veins , spheroidal, margins irregular with sharp or blunt points; size 19-97 μm diam.

F. (II). Series Graecae McNeill

A. filicaulis : Druses, dense, distributed throughout the leaf area except in the veins, spheroidal, margins irregular, with sharp points; size 10-39 μm diam.

A. teddii: Similar to *A. filicaulis*.

F. (III). Series Deflexae McNeill

A. deflexa: Druses, very dense, scattered throughout the leaf except in the veins, spheroidal, margins irregular, with very sharp points; size mixed, 19-49 μm diam.

F. (IV). Series Hispidae McNeill : No material studied

F. (V). Series Orientales

A. retusa : Druses, slightly dense, scattered throughout the leaf except in the veins, spheroidal, margins irregular, with sharp points; size 10-49 μm

diam.

A. rhodia : Similar to *A. retusa* .

G. Sectio Pseudosabulina McNeill

Distribution: This single species of Section Pseudosabulina is confined to the semidesert region on the borders of Turkey, Syria and Iraq.

A. sabulina : Druses, very dense, scattered throughout the leaf except in the veins , spheroidal , margins irregular, with sharp points; size 19-58 μm diam.

H. Sectio Occidentales McNeill

Distribution: Occurs in west Mediterranean.

A. loscosii : Druses, mostly few, scattered through the leaf except in the veins, concentrated near the upper third of lamina, spheroidal, margins regular, with blunt points; size variable though mostly large, 19-145.5 μm diam.

A. ciliaris : Druses Similar to those of *A. loscosii*, except size 19-78 μm diam.

J. Sectio Africanae McNeill

Distribution: Comprises a small group of Spanish and North African plants which are very uniform in habit and general appearance .

J. (i). Series Africanae

A. cerastioides : Druses, dense, scattered throughout the leaf except in the veins, spheroidal, margins irregular with sharp points; size 10-78 μm diam.

J. (ii). Series Papillospermae McNeill

A. hispanica : Druses, dense, distributed irregularly throughout the leaf area except in the veins, margins irregular with sharp points; size 10-78 μm

diam.

K. Sectio **Arenaria**

Distribution: Section *Arenaria* is a fairly homogeneous group of annual plants, two of which (*A. serpyllifolia* & *A. leptoclados*) are very widespread throughout Eurasia. The remaining species are more localised, five occurring in the Eastern Mediterranean area, one in North America and one in Spain .

K. (i). Series **Arenaria**

A. conferta : Druses, dense, scattered throughout the leaf, except in the veins, spheroidal, margins irregular with a very sharp points , size 19-97 μm diam. .

A. leptoclados : Similar to *A. conferta* .

A. serpyllifolia : „ „ „

K. (ii). Series **Saponarioides** McNeill

A. saponarioides : Druses, dense, scattered throughout the leaf except in the veins, spheroidal, margins irregular with sharp points; size variable 10-97 μm diam.

K. (iii) Series **Cylindricae** McNeill

A. guicciardii . Druses, dense, scattered throughout the leaf except in the veins, spheroidal, margins irregular, with sharp points, size 10-78 μm diam.

L. Sectio **Compressae** McNeill

Distribution: An extremely distinctive monotypic section from the western Himalayas and Afghanistan.

A. compressa : No material studied.

V. Subgenus **Arenariastrum** Williams

Distribution: The subgenus is confined to small area in the South of France.

A. gouffeia : Druses, dense, scattering in whole leaf except on veins, margins irregular, with sharp points, size 19-78 μm diam. .

VI. Subgenus **Eremogoneastrum** Williams

Distribution: North America and Sino-Himalaya

A. franklinii : Druses, dense, scattered irregularly throughout the leaf except in veins, margins irregular with blunt points, size 10-39 μm diam.

A. hookeri : Druses, dense, scattered irregularly throughout the leaf except in veins, margins mostly regular with blunt points, size 10-29 μm diam. .

A. festucoides: Similar to *A. hookeri*.

A. kansuensis : Similar to *A. hookeri* .

VII. Subgenus **Eremogone** (Fenzl) Fenzl in Ledebour

Distribution: Its main centres of diversity are the mountains of Central and South-West Asia and Western North America .

A. Sectio **Capillares** McNeill

A. capillaris : Druses, scattered irregularly, mostly dense in the lower third near leaf base, or scattered in or along leaf veins, spheroidal, margins mostly regular with blunt points; size variable 10-29 μm diam.

A. fendleri : Druses or spheroidal masses of crystal sands, very dense, scattered irregularly or in regular short rows in or along veins, mostly spheroidal, margins regular with blunt points; size 10-39 μm diam.

A. formosa : Similar to *A. capillaris* , the upper half of the leaf with absent or very rare crystals.

A. lychnidea : Druses, very dense particularly near the leaf base scattered irregularly, or spheroidal masses of crystal sands, mostly few in the upper

part of the leaf, concentrated in or along veins, spheroidal, margins regular with blunt points; size variable mostly small 19-29 μm diam.

B. Sectio Monogone Maxim.

Distribution: A monotypic section endemic to the Tien Shan and Altai regions. The single species, *A. potaninii* has not been studied.

C. Sectio Eremogone

Distribution: From Central and Eastern Europe across to Central Asia and extends south into the Caucasus, Armenia and probably S. Turkey .

A. steveniana : Druses or spheroidal masses of crystal sand, dense, arranged in regular rows or scattered irregularly mostly in veins, with regular margins and blunt points; size variable, 10-49 μm diam., Plate 36 (3,4).

A. graminea : Druses or spheroidal masses of crystal sand, very dense arranged regularly in rows or irregularly in or along veins, round, regular with blunt points; size variable 10-49 μm diam.

A. macradenia : Druses or spheroidal masses of crystal sand, very dense over whole leaf though concentrated mainly in the leaf veins, scattered irregularly or in short rows, mostly spheroidal with blunt points; size variable 10-29 μm diam.

D. Sectio Glomeriflorae Fenzl ex Williams

Distribution: The Section is confined to the Caucasus, E. Turkey and Iran .

A. dianthoides : Spheroidal masses of crystal sand, somewhat dense, arranged in regular rows only in veins, no crystals in the intercostal area, mostly spheroidal or ellipsoidal or short elongate, with regular margins, spheroidal size mostly small 10-19 μm diam.

A. cucubaloides : Similar to *A. dianthoides*, but mostly spheroidal masses of crystal sand; size 19-49 μm diam., Plate 32 (4).

A. gypsophiloides : Spheroidal masses of crystal sand or ellipsoidal, regular in rows or slightly irregular in the veins, shape mixed mostly spheroidal or elongate with blunt points; size variable and mixture of spheroidal 19-78 μm diam., or elongate length c. 58 μm , width c. 19 μm , intercostal area filled with spheroidal druses of small size 10-19 μm diam.

E. Sectio Rigidae McNeill

Distribution: The main centre of distribution in E. Europe, S. Russia and the Caucasus.

E. (i). Series Rigidae

A. holostea : Spheroidal masses of crystal sand, dense, arranged in regular rows from leaf base to the top in the veins, with regular margins and blunt points; size mostly 19-49 μm diam.

A. szowitsii : Similar to *A. holostea*

E. (ii). Series Setaceae McNeill

A. angustisepala : Druses, mostly very dense near leaf base with sharp or blunt points; druses or spheroidal masses of crystal sand in the upper side arranged along or in the veins with round and blunt points, size 10-29 μm diam.

F. Sectio Scariosae McNeill

Distribution: In North Iran and Turkish Armenia, but absent from the Caucasus .

F. (i). Series Polycnemifoliae McNeill

A. polycnemifolia: Druses, dense near leaf base, mostly scattered, irregular; size small c. 10 μm diam; spheroidal masses of crystal sand with regular

margins and blunt points in the upper side arranged in short regular rows, they joined 3-5 crystals in each row in the veins with variable shapes but mostly spheroidal 19-58 μm diam. or ellipsoidal length c. 58 μm and width c. 39 μm , or elongate c.19 μm length .

A. pseudacantholimon : Druses very dense at the base scattered irregularly, spheroidal with regular margins and blunt points, size c. 19 μm diam.; few spheroidal masses of crystal sand and druses in general scattered in or along the veins, rare or no crystals in the upper third of the leaf; size c. 19 μm diam.

A. zargariana : Druses, very dense near leaf base scattered irregularly or in short rows, size c. 19 μm diam.; spheroidal masses of crystal sand and druses, scattered irregularly or in short rows in the upper side of the leaf in or along the veins, mostly spheroidal with blunt points, size c. 49 μm diam., or ellipsoidal, size c. 58 μm length, 29 μm width.

F. (ii). Series Scariosae

A. armeniaca : Druses, near leaf base mostly scattered irregularly, spheroidal with blunt or sharp points; spheroidal masses of crystal sand, ellipsoidal or elongate, arranged irregularly or arranged in regular short with small mostly c. 10 μm diam., crystals on the upper side of the leaf concentrated in main veins scattered irregularly, or arranged in short rows, spheroidal, 10-58 μm diam, or elongate to ellipsoidal, length c. 34 μm , length, width c. 19 μm with regular margins and blunt points.

A. scariosa : Druses concentrated at leaf base, mostly spheroidal with blunt margins; in the upper side of the leaf crystals scattered irregularly or arranged in short regular rows in or along veins, mostly spheroidal masses of crystal sand with regular margins and blunt points, size c. 49 μm diam., or elongate length c. 78 μm , width 49 μm

G. Sectio **Sclerophyllae** (Boiss.) McNeill

Distribution: Occurs in two disjunct areas, the steppes of Central and South-West Asia and the dry regions of the Western United States .

A. acerosa: Druses, very dense at the leaf base, with sharp points, small size c. 10 μm diam.; spheroidal masses of crystal sand or druses, mostly with blunt points scattered or arranged in short rows in or along the veins; size 10-39 μm diam. .

A. acutisepala : Druses, dense, scattered irregularly at the leaf base, mostly small with sharp points; spheroidal masses of crystal sand or druses on the upper side, in regular short rows mostly c. 4-8 crystals in each row arranged in or along the veins, with blunt points; size mostly large 10-39 μm diam. Plate 33 (1, 2).

A. davisii : Druses or spheroidal masses of crystal sand, very dense, scattered irregularly throughout the leaf in or along veins with the same density from base to the top, with regular margins and blunt points; size 10-49 μm diam.

A. drypidea : Druses, dense near the leaf base with sharp points, size 10-19 μm diam.; spheroidal crystal sand masses arranged in more longer regular and dense rows in veins; size 10-78 μm diam.

A. griffithii : Druses, very dense near leaf base with sharp points, size mostly small, c. 10 μm diam.; spheroidal masses of crystal sand and druses arranged in or along the vein with blunt points; size 10-78 μm diam.

A. insignis : Druses and spheroidal masses of crystal sand, dense scattered irregularly throughout the leaf mostly with the same density along veins rarely in the veins, spheroidal with regular margins and blunt points; size 10-29 μm diam. .

A. kingii : Similar to *A. insganica*; size 10-49 μm diam., (Plate 33,1,2).

A. ledebouriana : Similar to *A. acutisepala* ; size 19-58 μm diam.

A. aculeata: Similar to *A. kingii*.

A. macradenia : Spheroidal masses of crystal sand and druses, very dense scattered irregularly throughout the leaf mostly with the same density concentrated mostly in veins, with regular margins and blunt points; size 10-49 μm diam.

A. persica : Spheroidal masses of crystal sand and druses, dense scattered irregularly throughout the leaf with the same density from base to top, with regular margins and blunt points; sizes variable 19-58 μm diam. .

A. tetrasticha : Similar to *A. persica* ; size 10-49 μm diam.

H. Sectio **Pungentes** McNeill

Distribution: Spain and North Africa, is a very isolated group whose nearest affinities are not apparent .

A. pungens : Druses and spheroidal masses of crystal sand, very dense, scattered irregularly throughout the leaf, size very variable, spheroidal, margins regular with sharp or blunt points, mostly medium size 19-87 μm diam., Plate 33 (6).

VIII. Subgenus **Dolophragma** (Fenzl) McNeill

Distribution: The subgenus is probably made up of seven species. all in the sino-Himalya region .

A. denissima : No crystals observed in the leaves.

A. oreophila : Druses, very rare, occasionally found in small aggregated groups near leaf base with small size c. 10 μm diam. with irregular margins and sharp points, or in the upper side, with variable sizes 10-49 μm diam.

A. polytrichioides : Similar to *A. oreophila* .

IX. Subgenus **Solitaria** McNeill

Distribution: In the eastern Himalaya and the mountains of South-Western China .

A. ciliolata : Druses, very few in number c. 40-100, scattered irregularly throughout the leaf except the veins, spheroidal with regular margins slightly sharp or blunt point; size mostly large 10-78 μm diam. .

A. forrestii: Similar to *A. ciliolata*.

A. napuligera: Druses, dense, scattered irregularly throughout the leaf except in veins, spheroidal, margins irregular with very sharp points; size 19-87 μm diam.

A. trichophora: Similar to *A. napuligera* ; size variable; 10-97 μm diam.

A. yunnanensis : „ „ „ „ „ 19-68 μm diam.

4.2.2 **Moehringia** L.

A. Sectio **Pseudomoehringia** McNeil

Distribution: Spain and North Africa.

M. intricata : Druses, very dense, scattered irregularly throughout the leaf except in veins, spheroidal, with regular margins and blunt points; size 19-97 μm diam.

M. tejedensis : Druses, dense, scattered irregularly throughout the leaf except in the veins, spheroidal, mostly with blunt margin, size variable but mostly medium or big 19-49 μm diam.

B. Sectio **Latifoliae** Nyman ex Graebner

M. trinervia : Druses, dense, scattered irregularly throughout the leaf except in veins, spheroidal, with sharp points and regular margin; size variable, mostly medium or large 19-97 μm diam., Plate 36 (2).

M. lateriflora : Druses, dense, scattered irregularly throughout the leaf

except in the veins, spheroidal with regular margins and sharp points; size variable mostly medium or big 10-49 μm diam.

M. radiolata : Druses, dense, scattered throughout the leaf except in the veins, spheroidal, with irregular margins and sharp points; size mostly medium or large 10-49 μm diam.

M. stellarioides: Similar to *M. trinervia*, size mostly medium c. 58 μm diam.

Plate 32 (1).

C. Sectio *Diversifoliae* Nyman ex Graebner

M. diversifolia : Druses, dense, scattered irregularly throughout the leaf except in the veins, spheroidal, with irregular margin and sharp points, size mostly small, 10-19 μm diam. .

M. jankae : Druses, dense, scattered irregularly throughout the leaf except in the veins, spheroidal with irregular margins and sharp points; size mostly large or medium, 19-97 μm diam.

M. pendula : Similar to *M. diversifolia* .

D. Sectio *Moehringia* :

M. sedifolia: Druses, very dense, scattered irregularly concentrated particularly along veins, spheroidal, with irregular margins and blunt points, size medium or large 19-68 μm diam. .

M. ciliata : Druses, dense, scattered irregularly throughout the leaf particularly along main veins, spheroidal with irregular margins and sharp points; size mostly medium or large, 19-68 μm diam.

M. glaucovirens : Druses, very rare or without crystals, scattered irregularly throughout the leaf mostly concentrated along main vein, spheroidal, with irregular margins and sharp points; size mostly big 19-39 μm diam.

M. muscosa : Druses, dense, scattered irregularly throughout the leaf,

concentrated particularly along main vein, spheroidal, mostly with regular margins and blunt points; size mixed, 19-68 μm diam.

M. tommasinii : Druses, very dense, scattered irregularly throughout the main vein, spheroidal, with regular margins and blunt points; size 10-78 μm diam.

4.2.3 *Minuartia* L.

I. Subgenus **Rhodalsine**: (J. Gay) Graebner

Distribution: It is common throughout the more southerly Mediterranean coasts extending to Portugal and the Canary Islands and with a distinctive species in Somaliland .

M. geniculata : Druses, dense, scattered irregularly throughout the leaf, except in the veins, with different shapes but mostly round, margins irregular, with sharp or blunt points, size variable, 10-97 μm diam., Plate 34 (3).

II. Subgenus **Spergella**

Distribution: Very distinctive groups of two sympatric species in the Irano-Turanian Sharo-Sindian regions of the Levant, Southern Turkey and Iraq .

M. formosa : Druses not dense scattered irregularly or arranged, in regular rows along main veins, shape mostly round, with regular margins and blunt points; size 19-78 μm diam.

M. picta : Druses c. 97 μm diam. or spheroidal masses of crystal sand but mostly elongate length 49-194 μm , width 29-78 μm .

III. Subgenus **Hymemella** (Moc. & Sesse ex Ser.) McNeill

Distribution: is only known from Central Mexico .

M. moehringioides : Druses dense, scattered irregularly throughout the leaf

except in veins, round with regular margins and blunt points, size 10-49 μm diam.

IV. Subgenus **Minuartia**

A. Sectio **Spectabiles** (Fenzl) Hayek

Distribution: On the mountains of Eurasia and throughout the Arctic .

A. a. Subsectio **Spectabiles**

A. a. (i) Series **Laricinae**

Distribution: Widely distributed in Western North America and Arctic Asia, extending south to Japan .

M. colchica : Druses, very dense, scattered irregularly throughout the leaf except in the veins, mostly spheroidal, with irregular margins and sharp points, size 10-49 μm diam.

M. imbricata : Similar to *M. colchica*; size 10-29 μm diam.

M. inamoena : „ „ „ „

A. a. (ii). Series **Spectabiles** [new series **Biflorae** of Rabeler, 1993]

Distribution: A series of three species throughout Arctic Eurasia and extending southwards into the western United States and Central Asia (to the Himalayas).

M. arctica : Druses, dense, scattered irregularly throughout the leaf except, veins, spheroidal, with regular margin and blunt points; size 10-49 μm diam.

M. biflora : Druses, slightly dense, scattered irregularly throughout the leaf except in the veins, spheroidal, margins mostly regular with blunt points; size mostly small 10-29 μm diam.

M. obtusiloba : Druses, few, scattered irregular particularly along both sides of the veins, spheroidal, with regular margins and blunt points; size variable 10-39 μm diam.

A. b. Subsectio Cherleria (L.) McNeill

Distribution: A monotypic group restricted to the mountains of Central Europe and the scottish Highlands .

M. sedoides : Druses, not dense, scattered irregularly, mostly arranged along both sides of veins, mostly spheroidal, with regular margins and sharp points ; size 19-49 μm diam.

A. c. Subsectio Laricifoliae (Mattf.) McNeill**A.c. (i). Series Caucasicae Mattf. in Fedde Rep. Beih.**

Distribution: A series of two species in western Anatolia and the Caucasus .

M. aizoides : Druses, dense, scattered irregularly throughout the leaf except in the veins, mostly spheroidal, with irregular margins and blunt or sharp points; size mostly small, 10-29 μm diam. .

A. c. (ii). Series Laricifoliae

Distribution: On the mountains of Southern Europe, extending into N. W. Anatolia and in the Lebanon mountains .

M. baldaccii : Druses, and spheroidal masses of crystal sand, dense, scattered irregularly throughout the leaf including veins, round with regular margins, sharp or blunt points; size 10-49 μm diam.

M. capillacea : Similar to *M. baklaccii*

M. laricifolia : „ „ „ ; size 10-29 μm diam.

B. Sectio Plurinerviae McNeill

Distribution: On the mountain of Central and Southern Europe and S. W. Asia.

M. bulgarica : Spheroidal masses of crystal sand, arranged in 4-5 regular rows in each vein, no crystals in intercostal area, mostly spheroidal, with entire margin; size mostly uniform on veins, c. 19 μm diam., Plate 33 (8),

Plate 36 (6, 7, 8).

M. hirsuta : Similar to *M. bulgarica* .

M. recurva : Similar to *M. bulgarica*, but the intercostal area filled with various crystals, shape mostly elongate length c. 97 μm , or spheroidal, c. 39 μm diam. .

C. Sectio Lanceolatae (Fenzl) Graebner in Ascherson & Graebner

C. (i). Series Graminifoliae Mattf.

Distribution: A series of three species in South-Eastern Europe (centred in the Balans) extending into N.W. Anatolia .

M. graminifolia : Spheroidal masses of crystal sand and elongate, arranged in the veins each vein has c. 4-5 rows, spheroidal c. 49 μm diam., elongate length c.78 μm , width c. 49 μm , the intercostal area covered with mixed crystals have different shapes mostly elongate length c. 19 μm .

M. saxifraga : Spheroidal masses of crystal sand and druses, arranged in seven veins, several rows of regular crystals arranged along each vein, spheroidal or ellipsoidal, mostly small c. 19 μm diam. ; intercostal area filled with mixed crystals mostly small, spheroidal Plate 35 (4).

M. stellate : Smilar to *M. saxifraga* .

C. (ii). Series Dianthifolia

M. dianthifolia: Spheroidal masses of crystal sand, arranged in c. 7 veins in regular rows with regular margins, mostly spheroidal and small size c. 10 μm diam., intercostal area filled with small druses variable shapes and sizes, mostly regular with blunt or slightly sharp points.

M. acuminata: Spheroidal masses of crystal sand, arranged regularly in c.10 veins in regular rows, spheroidal, with regular margins and blunt points mostly the same size c. 10 μm ; intercostal area covered with of variable sizes, mostly druses with blunt points.

M. pestalozzae: Spheroidal masses of crystal sand, arranged in c. 10 veins in regular rows and regular shape mostly ellipsoidal, size 10-29 μm diam.; intercostal area filled with a very dense small crystals of variable shape and size, mostly spheroidal and ellipsoidal (Plate 35, 8).

C. (iii). Series Lanceolatae [new name series **Cerastifoliae**]

Distribution: Restricted distribution in Asia Minor, Nakhichevan & Northern Iran .

M. cerastiifolia : Spheroidal masses of crystal sand and elongate crystals, arranged in the three veins, c.7 regular rows in each vein, mostly elongate length c. 49 μm , width c. 29 μm , or ellipsoidal c. 29 μm length, intercostal area filled with small mostly spheroidal crystals 10-29 μm diam., Plate 36 (5).

M. rupestris : Similar to *M. cerastifolia* .

C. (iv). Series Grigneenses

Distribution: A monotypic series endemic to the Bergamo Alps in Northern Lombardy.

M. grigneensis: Material not studied.

D. Sectio Aretioideae (Fenzl) Mattf.

Distribution: A section of one species, endemic in the Alpas.

M. aretioides : Spheroidal masses of crystal sand, arranged in c. 4-5 rows in each vein, mostly spheroidal, small 10-110 μm diam. or ellipsoidal; no crystals in the intercostal area.

E. Sectio Sclerophylla Mattf.

Distribution: In eastern and western North America (Chiefly U.S.A.) .

M. croliniana : Druses, very rare, mostly concentrated near the lower half of the leaf, scattered irregularly in the intercostal area but not in veins,

spheroidal, with regular margins and blunt points; size c. 19 μm diam.

M. dawsonensis : Spheroidal masses of crystal sand, arranged regularly in the middle vein only, c. 4 rows, mostly spheroidal, c. 49 μm diam., or elongate with variable length, length 29-49 μm in , width c. 29 μm , rarely with crystals spheroidal found in the intercostal area, c. 49 μm diam.

F. Sectio Acutiflorae (Fenzl) Hayek

Distribution: Throughout Central Europe and Central and South-West Asia .

F. (i). Series Acutiflorae [new name series Flaccidae]

Distribution: Occuring on the mountains of Central Europe and Central Asia from the Pyrenees to Himalayas-extending southwards into the steppe lands of South-West Asia .

M. austriaca : Elongate and spheroidal masses of crystal sand, arranged in regular rows in three veins mostly elongate length c. 78 μm , width c. 29 μm ; no crystals in the intercostal area.

M. flaccida : Similar to *M. austriaca* , size length c. 49 μm , width c. 29 μm .

F. (ii). Series Pichleriae Mattf.

Distribution: Throughout Southern and Eastern Anatolia .

M. rimarum : Spheroidal masses of crystal sand, arranged in regular rows in veins , with regular margin, mostly ellipsoidal length c. 29 μm , c. 19 μm , width or spheroidal; no crystals in the intercostal area., Plate 33 (7).

F. (iii) Series Umbelluliferae McNeill

M. umbellulifera : Elongate and spheroidal masses of sand crystals, arranged in regular rows in three veins, of mixed shapes but mostly elongate, length c. 19-68 μm , width c. 29 μm ; crystals scattered in the intercostal area but not dense, mostly elongate .

G. Sectio Tryphane (Fenzl) Hayek

Distribution: Throughout Eurasia and North America and extending Southwards onto the mountains of the Mediterranean region .

M. rubella : Spheroidal masses of sand crystal, arranged in regular rows in three veins, mostly ellipsoidal, length c. 39 μm , width c. 29 μm .

M. verna : Similar to *M. rubella*, but there are elongate crystals near leaf base .

H. Sectio Alsinanthe (Fenzl) Graebener

Distribution: Occuring in the Alps and on the mountains of C. Asia.

M. rossii : Spheroidal masses of sand crystal, arranged in regular rows in the middle vein only, mostly spheroidal with regular margins, c. 29 μm diam.; crystals in the intercostal area variable in shape, mostly spheroidal, 10-49 μm diam.

M. stricta : Similar to *M. rossii*; but crystals in the intercostal area variable in shape and size particularly near leaf base, mostly spheroidal, 10-97 μm diam., or elongate length c. 19 μm , width c. 10 μm Plate 35 (5).

J. Sectio Uninerviae (Fenzl) Mattf.

Distribution: An eastern North American section, extending to Greenland .

M. brevifolia : Druses, scattered irregularly throughout the leaf except in veins, mostly spheroidal with regular margins and blunt points, c.19 μm diam.

M. glabra : Druses, very rare, small spheroidal, with regular margin and blunt points, scattered irregularly in the intercostal area except in the veins, size c. 19 μm diam.

M. groenlandica : Similar to *M. glabra* .

M. patula : Elongate and druses, scattered irregularly throughout the leaf,

but not in veins, with different shapes and sizes, but mostly elongate length 39-155 μm , width c. 19 μm .

K. Sectio Greniera (Gay) Mattf.

Distribution: A section comprising two annual species confined to western North America .

M. douglasii : Spheroidal masses of sand crystal and elongate, mostly few, concentrated in veins in short rows, mostly spheroidal near leaf base and more elongate in the upper half, length 78-232.8 μm , width c. 29 μm , crystals very rare in the intercostal area., Plate 35 (7).

M. howellii : Elongate and spheroidal masses of sand crystal, mostly few, arranged in veins in short rows, mostly elongate, length c. 0.5-2 mm, width c. 29 μm .

L. Sectio Minuartia

L. a. Subsectio Minuartia

L. a. (i) Series Montanae Mattf.

Distribution: Centred in the Eastern Mediterranean region but extending to northern India and occurring in Spain and western N. Africa .

M. montana : Elongate and spheroidal masses of crystal sand, arranged regularly in three veins c. 5 rows of crystals in each vein, mostly spheroidal or ellipsoidal, intercostal area mixed mostly elongate, length 39-339.5 μm , width 29-68 μm (cigar shape), or ellipsoidal, length c. 39 μm , width c. 29 μm Plate 35 (3), Plate 37 (5,6).

M. globulosa : Spheroidal masses of crystal sand, arranged in many regular veins, spheroidal c. 19 μm diam., or elongate, 97-175 μm length, c. 29 μm in width, mostly concentrated in the upper half of the leaf; intercostal area filled with crystals different shapes and sizes but mostly spheroidal,

10-49 μm diam. Plate 34 (4).

L. a. (ii). Series Minuartia

Distribution: All species of this series native in the Mediterranean region .

M. dichotoma : Spheroidal masses of crystal sand and elongate crystals, arranged regularly in the veins, mostly spheroidal, c. 19 μm diam., intercostal area covered with small granules sandy structure Plate 35 (6).

M. hamata : Elongate and spheroidal masses of crystal sand, arranged regularly in three veins, c. 5 rows of crystals in each vein, mostly spheroidal; intercostal area covered with crystals mixed shapes, mostly spheroidal or elongate (cigar shape), length 39-194 μm , width 19-29 μm , Plate 35 (2).

L. b. Subsectio Xeralsine (Fourr.) McNeill

L. b. (i). Series Leucocephalae Mattf.

M. leucocephala : No material studied.

L. b. (ii). Series Setaceae Mattf. in Fedde Rep.

Distribution: Occuring in C.Europe and the Mediterranean region (incl. Anatolia and the Caucasus).

M. anatolica : Spheroidal and elongate crystals, arranged regularly in three veins, c. 5 rows in each vein, mostly spheroidal, c. 39 μm diam., or ellipsoidal, intercostal area filled with mixed sizes and shapes mostly elongate, length c. 78 μm , width c. 19 μm .

M. confusa : Similar to *M. anatolica* .

M. mutabilis : Similar to *M. anatolica* .

M. restrata: " "

M. setacea: " "

L. b. (iii). Series Xeralsine [new name Series Fasciculata]

Distribution: Usually on the mountains of Southern Europe, extending into N. Africa .

M. fasciculata : Spheroidal masses of crystal sand, arranged in three veins, with c. 5 rows of crystals on each vein, mostly spheroidal, 10-29 μm diam., intercostal area filled with mixed crystals that are mostly spheroidal, or polygonal.

M. funkii : Similar to *M. fasciculata*

L. b. (iv). Series Campestres Mattf.

Distribution: A series of one annual species in Spain and North Africa .

M. campestris : Spheroidal masses of crystal sand and druses, arranged in three veins, with c. 3 rows of crystals on each vein, mostly round; intercostal area filled with mixed crystals that are mostly spheroidal or druses Plate 34 (1,2).

M. Sectio Sabulina (Reichb.) Graebn.

M. (i). Series Sabulina

Distribution: Centred in S. Europe and the Mediterranean area.

M. hybrida: Elongate and spheroidal masses of crystal sand arranged in three regular veins in the leaf base, crystals mostly elongate, length c. 39 μm , width c. 29 μm , these crystals in veins started joining gradually from the base to the top making a long (cigar shape) crystals in the upper half of the leaf, no crystals in the intercostal area, Plate 34 (5,6).

M. mediterranea : Similar to *M. hybrida*; crystals in the upper half of the leaf, length c. 268.6 μm , width c. 68 μm , Plate 34 (7,8), Plate 37 (1,3,4).

M. mesogitana : Elongate and spheroidal masses of crystal sand, arranged in three veins with variable sizes, mostly elongate, length 49-78 μm , width c. 29 μm , very rare crystals in the intercostal area mostly spheroidal with blunt points, c. 19 μm diam., Plate 35 (1).

M. tenella : Elongate, spheroidal masses of crystal sand and druses, arranged in regular rows, crystals mostly elongate from short near the lower

half to long in the upper half, length 116-223 μm , width c. 29 μm ; very few crystals in the intercostal area mostly round with sharp or blunt points, c. 49 μm diam.

M. viscosa: Similar to *A. mesogitana*

M. urumiensis : Spheroidal masses of crystal sand and elongate crystals, mainly arranged in three regular rows, with regular shape mostly spheroidal, c. 19 μm diam., intercostal area covered with few different shapes but mostly spheroidal, 19-78 μm diam., or elongate, length 49-116 μm , rarely elongate, 194 μm long

M. (ii). Series Californicae Mattf.

Distribution: In California and in Chile .

M. californica : Spheroidal masses of crystal sand, elongate and druses, crystals mostly arranged in short rows of c.4-6, mostly spheroidal, 19-39 μm diam, attached together, or scattering irregularly, mostly in or along the main veins .

4.3 DISCUSSION

4.3.1 ARENARIA L.

McNeill (1962, p.89) stated "In *Arenaria* itself very similar species such as *A. lychidea* and *A. capillaris* (treated as conspecific by Regal, 1862) have minute and prominent glands respectively, and Williams consequently places the one in subgenus *Euarenaria* and the other in subgenus *Pentadenaria*." In his classification McNeill listed these two species under one section *Capillares*. As found during this investigation, both species show great similarities in crystal shape, margin, size, density and distribution. This agrees

with the morphological characters to keep them both under one section. McNeill (1962,p.89) added "In the same way *A.cucubaloides* and *A. gypsophiloides*, which are satisfactorily distinguished only by flower size and the length of the leaf sheath, are widely separated from one another in his [Regel] classification." McNeill kept these two species under one section *Glomeriflorae*. Both these two species show differences in crystal size and distribution. In *A. cucubaloides* the crystals are arranged in regular rows in the veins with no crystals only in the intercostal areas, and the size is mostly small (c. 10-19 μm diam.) and the shape round. However in *A. gypsophiloides* the crystals are round and larger (c.19-78 μm diam.) or elongate length (c. 58-116 μm in, (width c. 19 μm) and the intercostal area contains dense small crystals (c. 10-19 μm). Therefore this crystal evidence supports Regalel's (1862) placement of these two species of different subgenera.

Arenaria sabulina is the sole species in section *Pseudosabulina*. McNeill (1962, p.115) said "The section shows a strong superficial resemblance to *Minuartia* Section *Sabulina* (particularly in the sepal structure) but its true affinities lie with *Arenaria* Section *Orientales* Series *Orientales* (particularlry

A. kurdica)." Davis (1967,p.28) in *Flora of Turkey* also mentioned the superficial resemblance of *A. sabulina* to *Minuartia* Sect. *Sabulina*, especially *M. mesogitana*. According to the crystal studies there is no resemblance between these two taxa. In all the species of Section *Sabulina* of *Minuartia* the crystals are arranged in regular rows in the veins (c. 49 μm in length, c. 78 μm in width); whereas in *M. mesogitana* the crystals are mainly arranged in the three veins and are variable in size, (mostly 49-78 μm in length, c. 29 μm in width). There are also crystals of round shape (c. 19 μm diam.) in the intercostal area. In *A. sabulina* however the crystals are scattered throughout the leaf except in the veins.

The shape and distribution of the crystals point to a very close relationship between *A. sabulina* and the species in Series *Orientalis* Section *Orientalis* as claimed on morphological ground in by McNeill with particular *A. kurdica*.

McNeill (1962, p.125) said" The Section [*Rigidae*] is closely related to section *Capillares* with which it was linked by Fenzl in Ledebour (1842) (both in his "Chromolemmae") and from which it has probably evolved by the sepals becoming more hardened, coriaceous, scarious, and acuminate. In the Series *Setaceae* it shows some affinity with Sections *Sclerophyllae* and *Scariosae*." According to the crystal study, Series *Rigidae* shows crystals in very regular rows arranged in the veins all the way from the base to the top (*A. szowitsii*, *A. holostea*). This is different from section *Capillares* with its dense irregularly scattered crystals in or along the veins, with greatest density near the lamina base. Section *Capillares* resembles Series *Setaceae* in Section *Rigidae* particularly the section *Scariosa* of section *Sclerophylla* with regard to crystal shape and distribution. McNeill (1962) explained that, in Section *Africanae* with its small group of Spanish and North African plants, Series *Africanae* has seeds of the type that is

normally found in Subgenus *Arenaria*. But *A. hispanica*, in Series *Papillospermae*, has a seed testa structure showing strong similarities with Subgenus *Leiosperma* of *Arenaria* and genus *Moehringia*. Because of its distinctive seeds *A. hispanica* stands in a very isolated position. The crystal shape, margins and distribution show marked similarities between the two series of Section *Africanae* and many species in Subgenus *Leiosperma* and in *Moehringia*. Using only the crystal evidence Series *Africanae* and *Papillospermae* would be amalgamated.

However, in *A. hispanica*, with its resemblance in vegetative and floral characters to Section *Africanae* suggests that it would be better to include *A. hispanica* as a separate Series within Section *Africanae*.

McNeill (1962, p.119) said "The subgenus [*Arenriastrum*] is confined to a small area in the South of France; it appears to be a bicarpillary derivative of Subgenus *Arenaria* and in habit and sepal structure closely resembles such species as *A. sabulinea* and *A. capillipes*. The crystals results show no difference in type, shape, margins and size between *A. gouffeia* (subgenus *Arenriastrum*), and *A. sabulinea* (Subgenus *Arenaria*).

According to McNeill (1962, p.123) " The geographically isolated Caucasian *A. lychnidea* [Section *Capillares*] is distinctive among Eurasian plants in its very weakly developed staminal glands and in its sepal structure shows an approach to Section *Glomeriflorae*". The Crystals show a big difference between *A. lychnidea* (with its very dense crystals concentrated irregularly in the lamina base and mostly without crystals in the upper half) and the species in the in Section *Glomeriflorae* in which the crystals are arranged regularly in rows in the veins only. Here the crystal evidence argues against the inclusion of *A. lychnidea* in Section *Glomeriflorae*.

McNeill (1962, p.123) added " In North America, in the Colorado-New Mexico region, there are two species (*A. eastwoodii* and *A. fendleri*) with very narrow pointed sepals; this characteristic is also found in a Tibetan species (*A. acicularis*), and makes these species readily distinguishable from the rest of the section. *A. acicularis* was not studied.

McNeill (1962, p.126) claimed that " the species [in Section *Sclerophyllae*] have been very confused taxonomically, and like Section *Capillares* but unlike most groups of subgenus *Eremogone*, its members seem to be in a state of active evolution and speciation". The crystals of 12 species of Section *Sclerophyllae* were studied. According to their shape, size and distribution two groups can be recognised; the first group *A. acerosa*, *A. acutisepala*, *A. drypidea*, *A. griffithii*, *A. kingii*, *A. ledebouriana*, and *A. tetrasticha*. has dense crystals concentrated and scattered irregularly near the leaf base, mostly small in size (c. 10 μm diam.) with sharp or blunt margins. It also has short regular crystals, round with blunt margins and variable sizes (10-97 μm diam.) arranged in veins throughout the leaf.

The second group *A. darisii*, *A. insignis*, *A. persica*, and *A. macradenia* . has dense or very dense crystals scattered irregularly throughout the leaf mostly concentrated along the veins, with round blunt margins and variable sizes (10-58 μm diam.) eg. McNeill(1962, p.127) added" the small and not very spiny-leaved *A. tetrasticha* and *A. davisii* (S. Iran and E. Turkey) perhaps form a third group to be separated from the main aggregation of rather spiny caespitose or suffruticose species. The results obtained from the crystals separate those two species. *A. tetrasticha* falls into group one and *A. davisii* into group two .

McNeill (1962, p.127) wrote " Section *Pungentes*, confined to Spain and North Africa, is a very isolated group whose nearest affinities are not apparent. The type species has usually been placed in *Eremogone* and

because of its semi-terete pungent leaves and superficial resemblance to *A. stenomeris* and *A. persica*, it is retained for the present in that subgenus; it differs however from the members of the other sections in that its cotyledons are incumbent and not accumbent. It is even more distant from Subgenus *Arenaria* (in which cotyledons are always incumbent) and with more evidence may come to be placed in a subgenus of its own". Many specimens from different localities in Morocco were checked. This revealed the crystals to be very dense and scattered irregularly throughout the leaf area, mostly round with blunt or sharp margins and sizes variable (19-87 μm diam.). The crystals in density, shape, size and distribution in *A. pungens* give a good support for McNeill's suggestion that *A. pungens* should be placed in a separate subgenus.

4.3.2 MOEHRINGIA L.

The species in *Moehringia* can be classified into different groups according to density of the crystals: very dense e.g. *M. bavarica*, dense e.g. *M. ciliata*, few or absent crystals e.g. *M. glaucovirens*.

They can also be grouped by size, small (10-19 μm diam.) e.g. *M. diversifoliae*, medium (10-49 μm diam.) e.g. *M. radiolata* and big (19-97 μm diam.) e.g. *M. trinervia*. They can also be grouped according to margins: with points sharp e.g. *M. trinervia* or blunt e.g. *M. muscosa*, and according to crystal distribution: throughout the leaf area except in veins *M. pentandra* or including veins e.g. *M. tommasimii*.

All members of *Moehringia* show great similarities with the genus *Arenaria* except the Subgenus *Eremogone* of *Arenaria*, and also display great similarities with *Minuartia* except Subgenus *Minuartia* but within that Subgenus the Sections *Spectabiles*, *Sclerophylla* and *Uninerviae* do resemble *Moehringia*.

4.3.3 *MINUARTIA* L.

McNeill (1962, p. 136) wrote "The distinctive facies of the single species of this subgenus [*Hymenella*] makes its retention within *Minuartia* open to question but in the absence of any more definite characters than the quadrangular stem and the spreading calyx and capsule, it has been thought wisest to follow Mattfeild's treatment, but raising it to subgeneric rank. *M. moehringioides* is only known from Central Mexico. The crystals in this monotypic subgenus with their round shape, blunt margins, scattered or arrangement in short rows along veins resemble those of other subgenera. Therefore the crystals lend no support to the separation of the subgenus from the genus *Minuartia*, McNeill (1962, p.143) stated "Fenzl named two "species prototyp" for his infrageneric group *Tryphane_Alsine recurva* and *A. verna*. When he divided the group into two Sections Mattfeld chose *recurva* as lectotype, ignoring the fact that Boissier, more than 50 years before, had by excluding that species (and placing it in the *Lanceolatae*) effectively typified *Tryphane* by *Alsine verna*. A new name is, therefore, required for this very homogeneous section which includes *M. recurva* and *M. hirsuta*; the name *Plurinerviae*, which has been given (above), refers to the 5-7 nerved sepals, the major distinguishing feature between this section and *Tryphane* s.s. (=Polymechana Mattf.)."

The crystals of three species from Section *Plurinerviae* were studied and it was found that the two species *M. bulgarica* and *M. hirsuta* have the same system of crystal shape and distribution; the crystals are arranged in 4-5 rows in each vein but there are no crystals in the intercostal area. However, in the third one *M. recurva*, the crystals are basically arranged in regular rows in the veins and the intercostal area is filled with variable shapes and sizes, mostly elongate (c. 97 μm in length) or round (c. 39 μm diam.). In Section *Tryphane*, two species were investigated (*M. verna*, *M. rubella*) it

was seen that their crystal shape and distribution were similar to those of *M. bulgarica* and *M. hirsuta*. In Section *Lanceolatae* (*M. graminifolia*, *M. saxifraga*, *M. stellata*, *M. cerastifolia*, and *M. ruperstris*) the crystals were studied. This revealed strong similarities with *M. recurva*. According to these results *M. recurva* should be retained in Section *Lanceolata* this supports the system of Boissier.

According to McNeill (p. 145) " A Section [*Sclerophylla*] of three to six species in eastern and western North America (chiefly U.S.A.). The three species known to Mattfeld were each placed by him in monotypic series. They are very distinct species and the section appears rather heterogenous." The crystal shape and distribution between the two species in this section are quite variable, in *M. caroliniana* the crystals are scattered irregularly along veins, are round with blunt margins and in size are mostly small (c. 19 μm diam.). However, in *M. dawsonensis*, they are arranged regularly in only the main vein, have variable shapes and sizes, and are mostly round (c. 49 μm diam.) or elongate (29-49 μm in length, 29 μm in width). Therefore, the evidence of the crystals emphasizes the heterogeneity and suggests that splitting may be a reasonable course.

McNeill (1962, p. 146) stated " Mattfeld based the Series *Pichleriae* on *M. pichleri*, a species endemic to the Peloponnese, but it is clear that *M. rimarum* which he placed in his Series *Flaccidae* should be included with it. *M. rimarum* which is widely distributed throughout Southern and Eastern Anatolia shows some resemblance to *M. umbellulifera* (Series *Umbelluliferae*) but differs in the more spreading equally three-nerved leaves". The arrangement type and size of crystals in series *Pichieriae*, *Umbellulifera* and *Acutiflorae* are closely similar but *M. rimarum* of series *Pichieriae* shows greater resemblance to series *Acutiflorae* than to Series *Umbellulifera*. In the last named there are intercostal crystals but in *M.*

rimarum and *Acutiflorae* there are none. The four examined species from Section *Uninerviae*, distributed in eastern North America, show strong similarities in their crystals to Series *Spectabiles* in Subsection *Spectabiles*, Section *Spectabiles*. They both have round crystals with blunt margins scattered irregularly through the leaf except in the veins and they have seeds mostly obscurely tuberculate. While in Series *Laricinae* in Subsection *Spectabiles*, Section *Spectabiles*, the crystals have the same distribution as in the previous group but with both round and sharp points, and the seeds have a fimbriate crest on the dorsal ridge. From these observations, it can be suggested that Section *Uninerviae* might well be united with Section *Spectabiles* as Subsection *Uninerviae*.

According to McNeill (1962, p. 148) "The type series [Series *Minuartia*] comprises the three highly specialised annual members of the genus, all native in the Mediterranean region. *M. hamata* with its recurved fruiting bracts has a very distinctive facies and is often maintained in a separate monotypic genus (*Queria hispanica*). In fact, as Mattfeld (1922 p. 69) has pointed out, it is merely a reduced derivative of *Minuartia* and is very close to *M. dichotoma* the type species of the genus." The crystals in *M. dichotoma* and *M. hamata* show big differences in distribution. They both have mostly round crystals arranged in regular rows in the veins. The difference concerns the intercostal areas which are filled with small sandy particles in *M. dichotoma* but filled with elongate crystals (39-194 μm in length, c. 19 μm in width) in *M. hamata*. These crystal shapes and distribution in *M. hamata* resemble those in the species in Series *Montanae* in the same Subsection *Minuartia*. Therefore, it might be best to place *M. hamata* in Series *Montanae* than retain it in Series *Minuartia*.

Fig 4. Different types of crystal forms and distributions in the genera
Arenaria, *Moehringia* and *Minuartia*.

- 1) *Arenaria deflexa* showing a more or less uniform high density of crystals in the intercostal areas but no crystals in the veins.
- 2) *Arenaria ledebouriana* showing a high density of druses in the leaf base and an irregularly spread crystal sand in the midrib and sparse crystal sand in the intercostal areas.
- 3) *Arenaria lanuginosa* showing irregularly scattered druses in the intercostal areas throughout the leaf.
- 4) *Minuartia hamata* showing dense, regularly spaced crystal sand throughout the veins and crystal sand, elongate crystals and druses in the intercostal areas.
- 5) *Minuartia hybrida* showing elongate crystals spread throughout the veins without any crystals in the intercostal areas.
- 6) *Moehringia pendula* showing druses widely scattered through the leaf but only in intercostal areas.

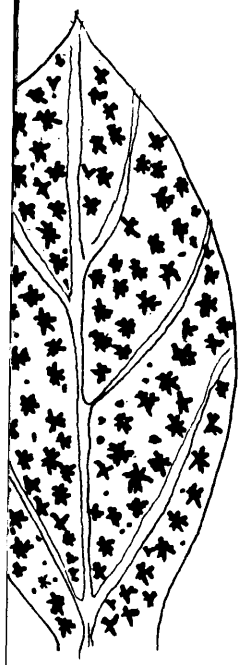

1

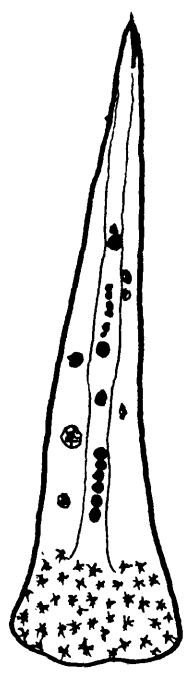

2

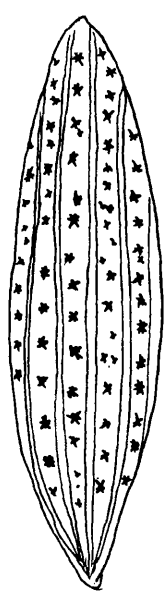

3

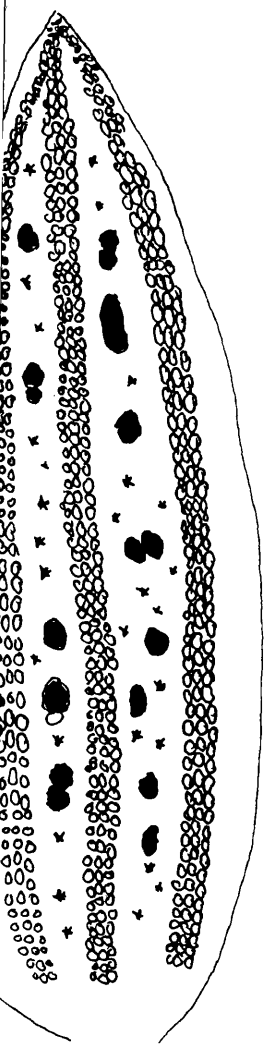

4

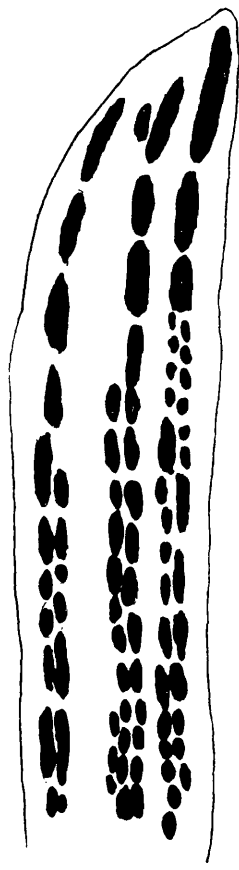

5

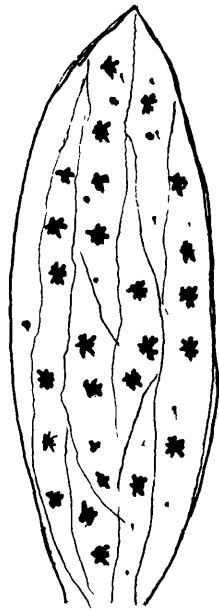

6

The plates from no 32 to 37 are photomicrographs and SEMs of crystals in tissues of mature leaves.

PLATE 32.

1. *Moehringia stellarioides* x 100
2. *Arenaria alsinoides* x 100
3. „ „ x 400
4. *A. cucabalooides* x 100
5. *A. grandiflora* x 100
6. „ „ x 400
7. *A. montana* x 100
8. *A. montana* x 400.

PLATE 32

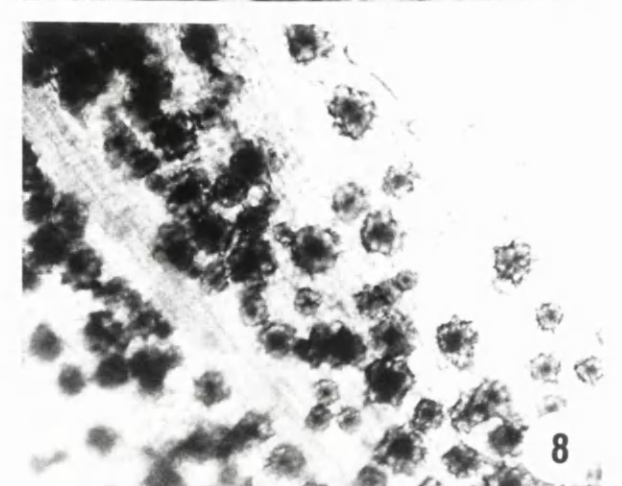
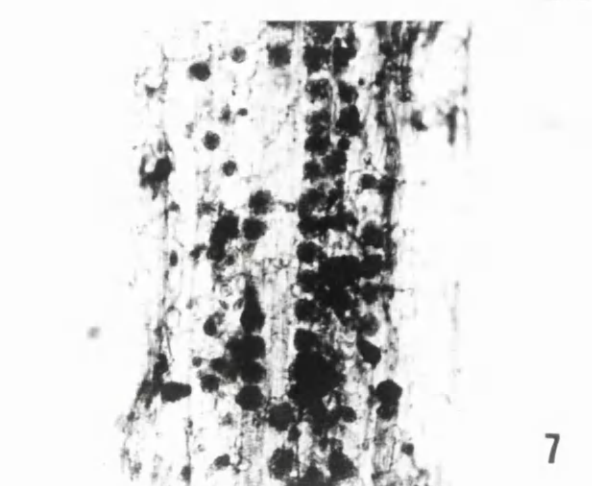
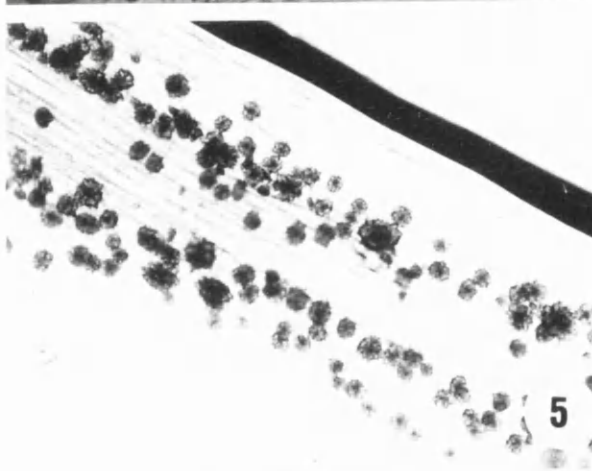
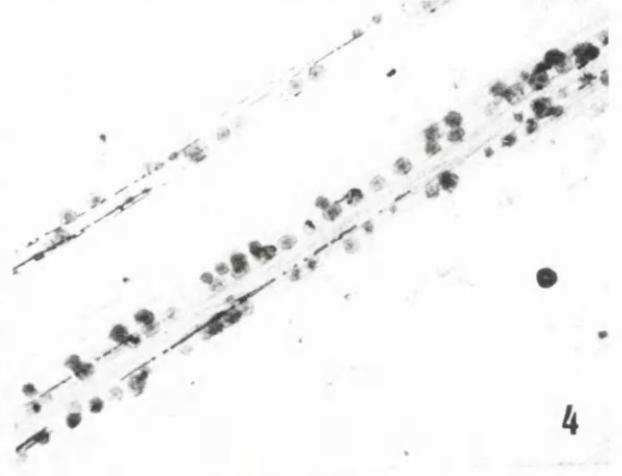
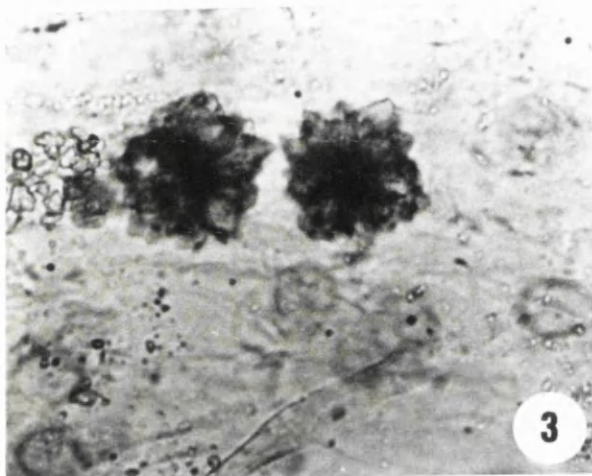
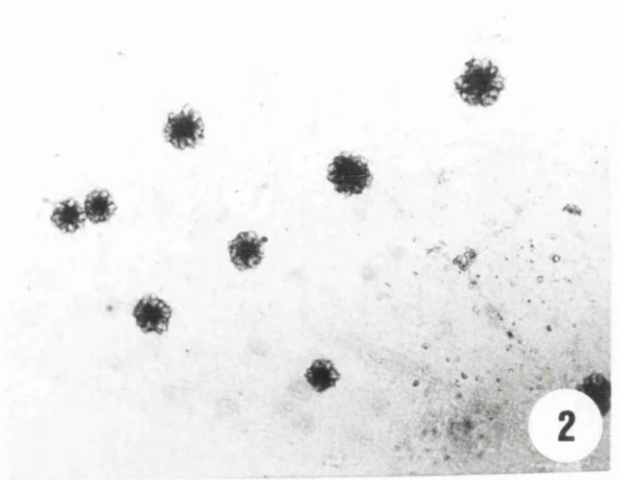
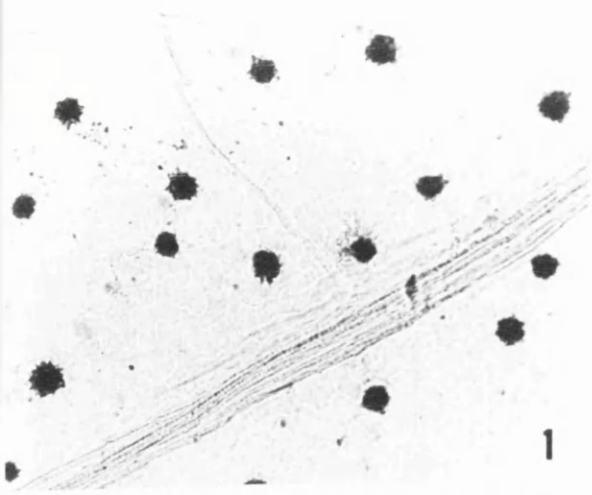

PALTE 33.

1. *Arenaria kingii* x 100. (near the base)
2. „ „ x 400. (in the middle)
3. *A. paludicola* x 100.
4. „ „ x 160.
5. „ „ x 400.
6. *A. pungens* x 100.
7. *Minuartia rimarum* x 100.
8. *M. bulgarica* x 160.

PLATE 33

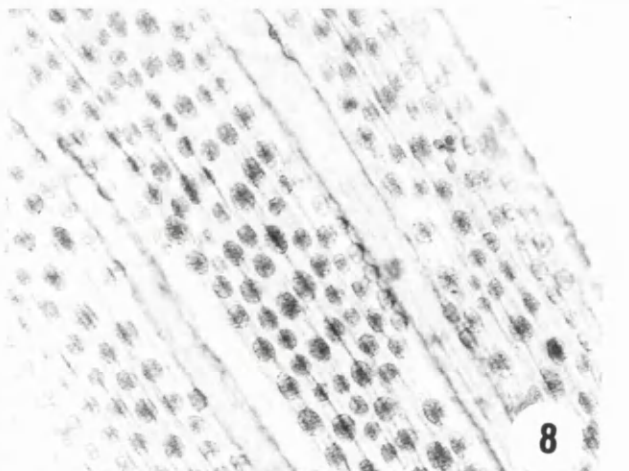
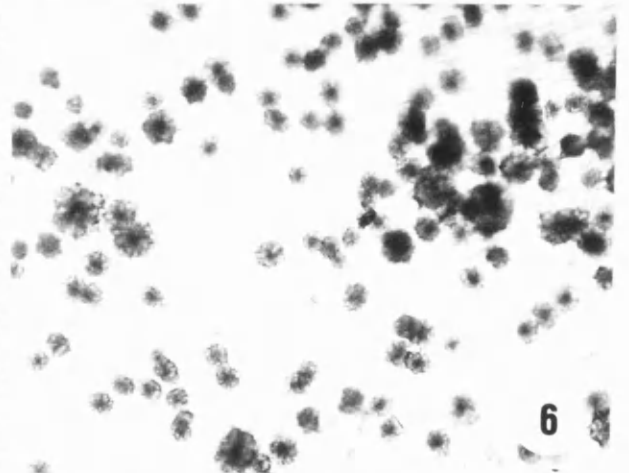
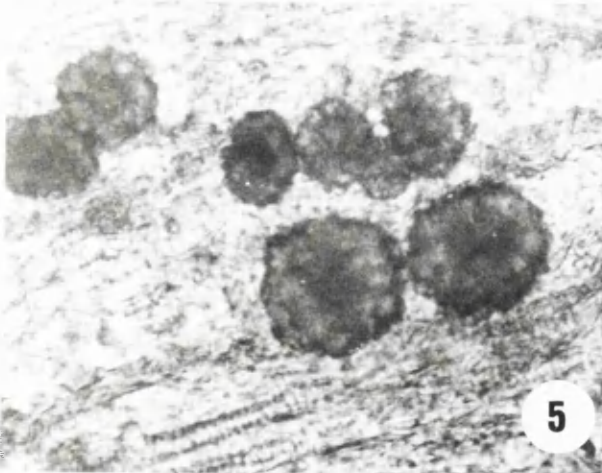
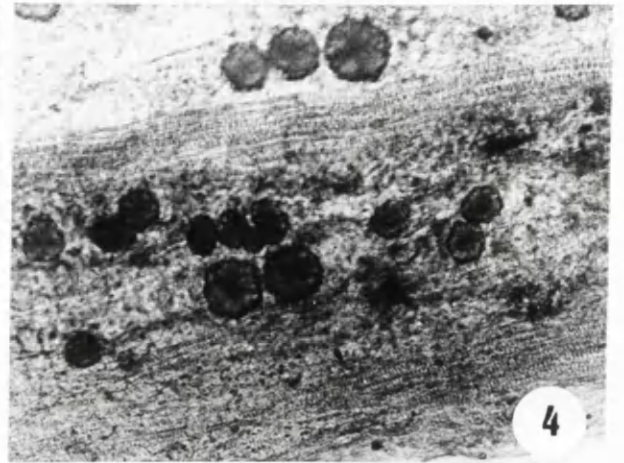
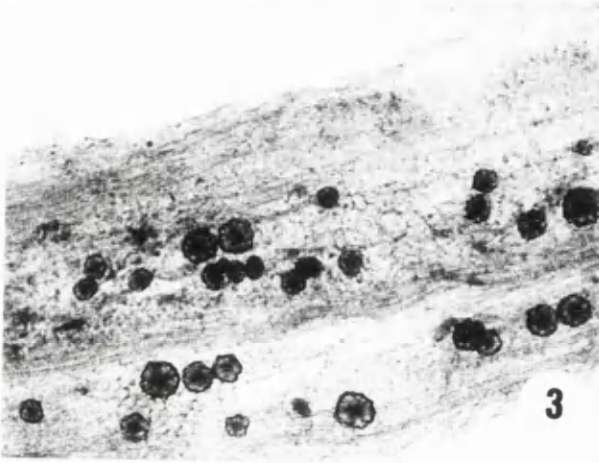
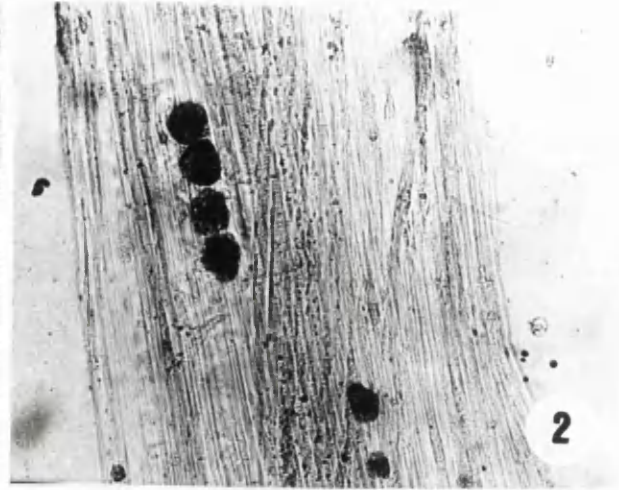
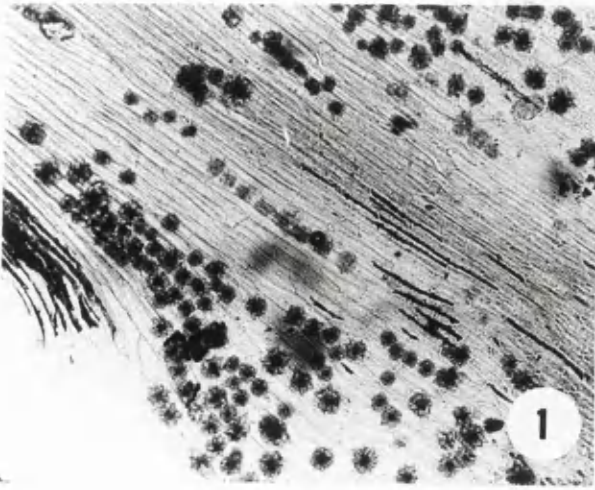

PLATE 34.

1. *Minuartia campestris* x 100.
2. „ „ x 100.
3. *M. geniculata* x 100.
4. *M.* „ x 100.
5. *M. hybrida* x 100 (near the base).
6. „ „ x 100 (in the upper half).
7. *M. mediterranea* x 100.
8. *M.* „ x 400.

PLATE 34

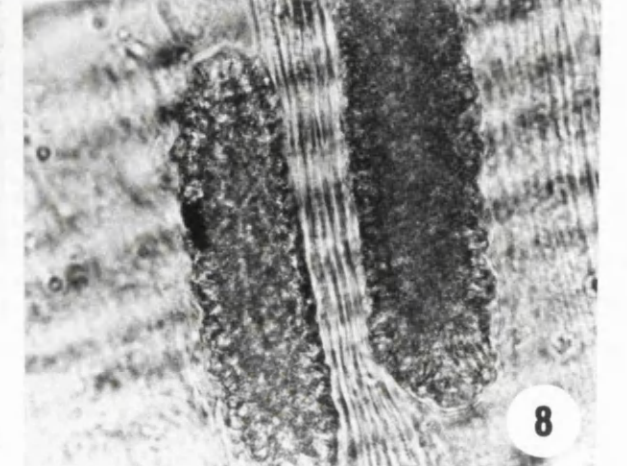
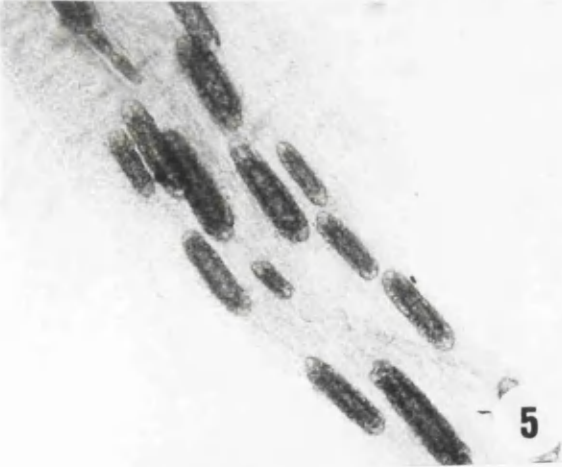
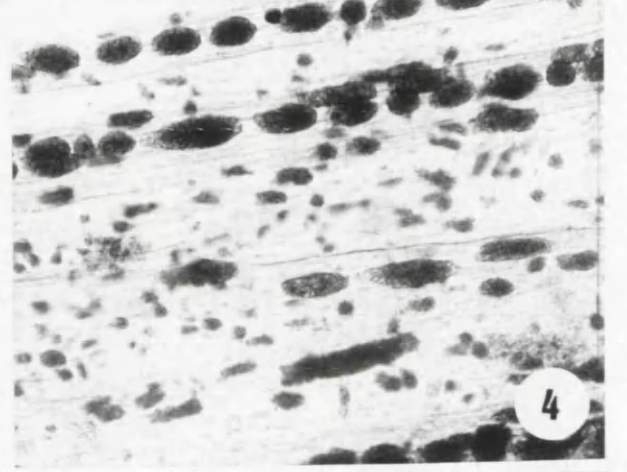
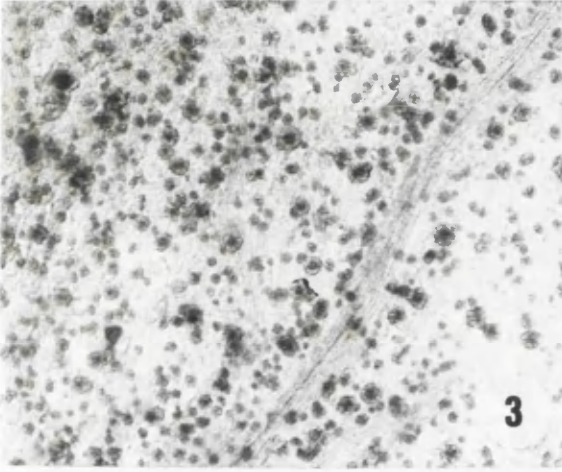
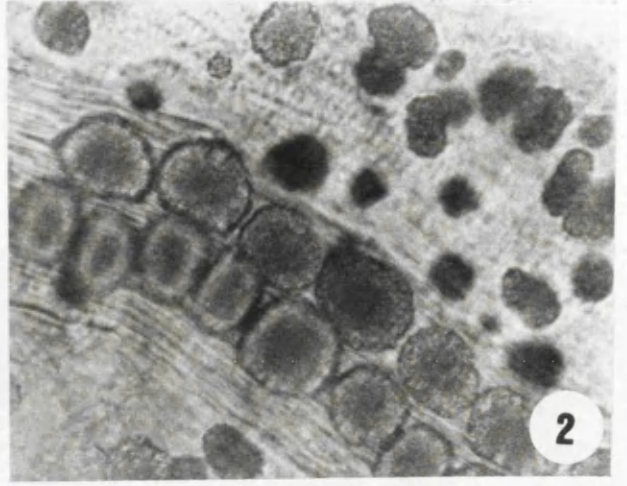
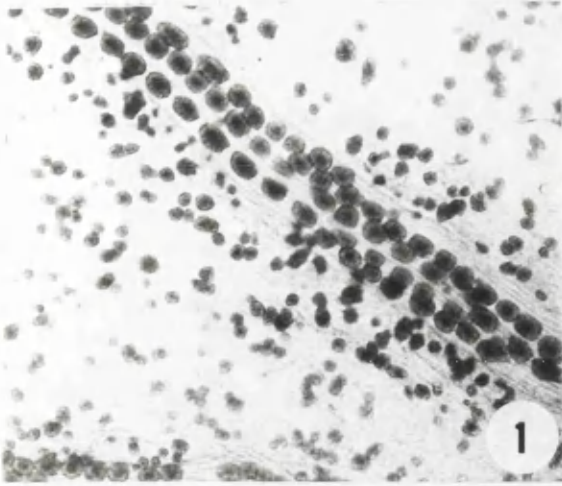

PLATE 35.

1. *Minuartia mesogitana* x 100.
2. *M. hamata* x 100.
3. *M. montana* x 100.
4. *M. saxifraga* x 100.
5. *M. stricta* x 100 (near the base).
6. *M. dichotoma* x 100.
7. *M. douglasii* x 100.
8. *M. pestalozzae* x 100.

PLATE 35

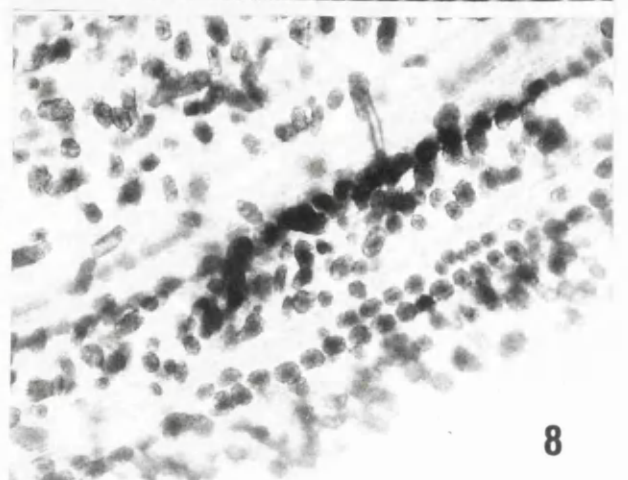
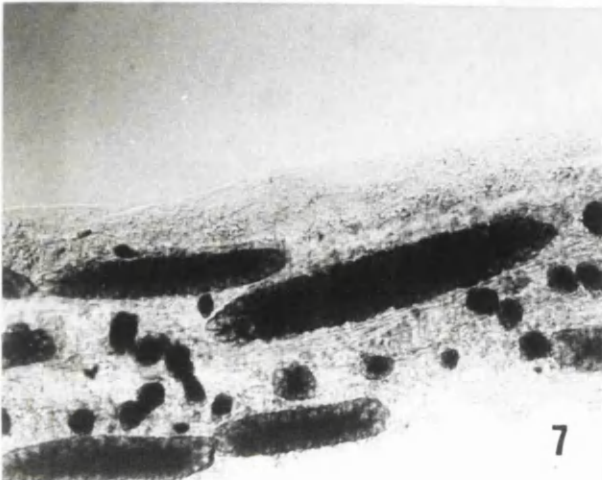
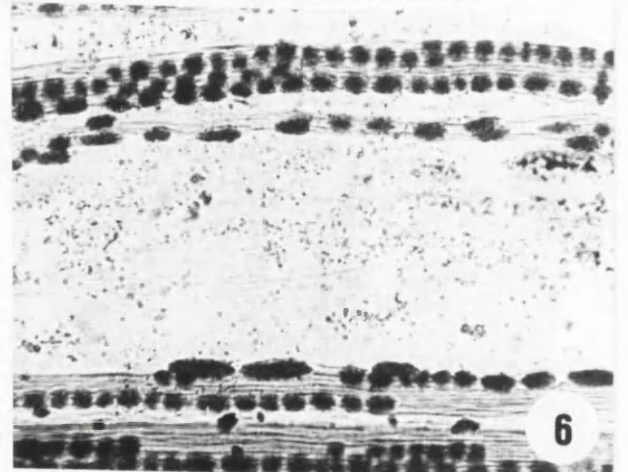
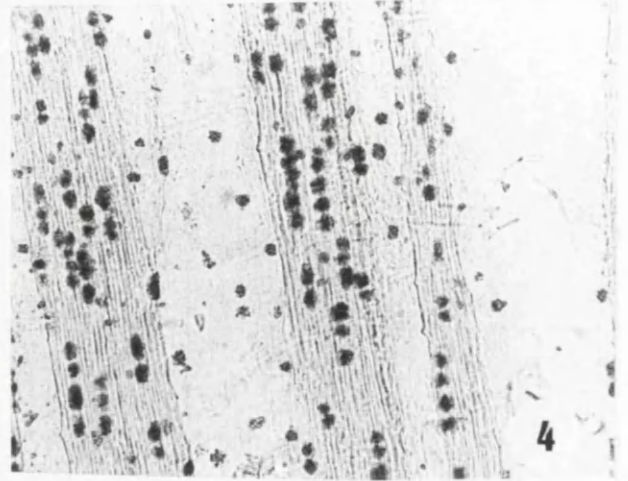
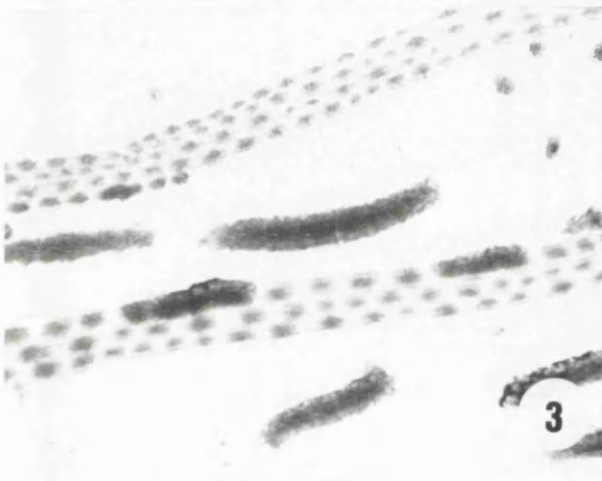
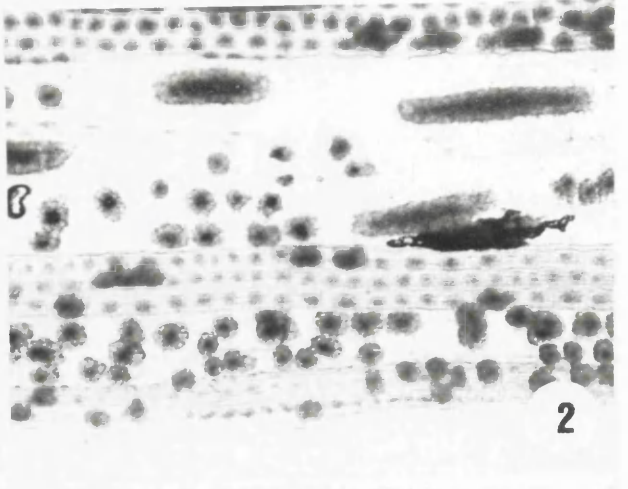
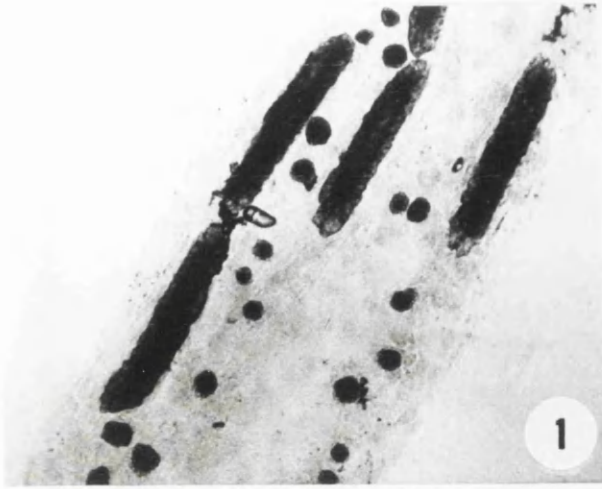

PLATE 36.

SEMs of the different types of calcium oxalate crystals in *Arenaria*, *Moehringia* and *Minuartia* as following.

1. *Arenaria alsinoides*.
2. *Moehringia trinervia*.
3. *Arenaria steveniana*.
4. „ „
5. *Minuartia cerastifolia*.
6. *M. bulgarica*.
7. „ „
8. „ „

PLATE 36

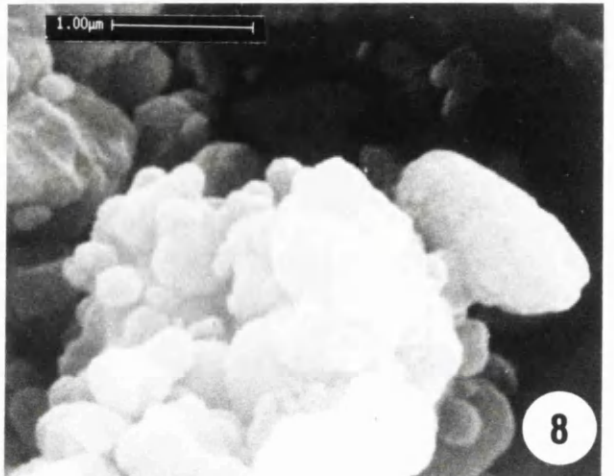
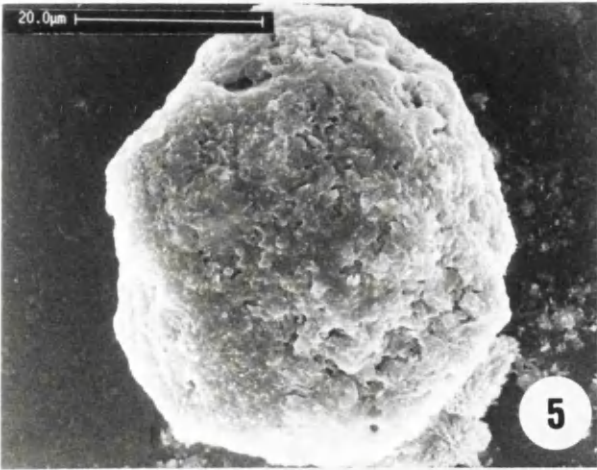
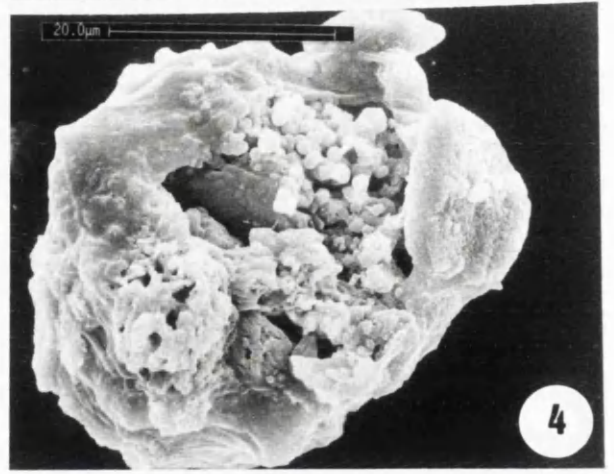
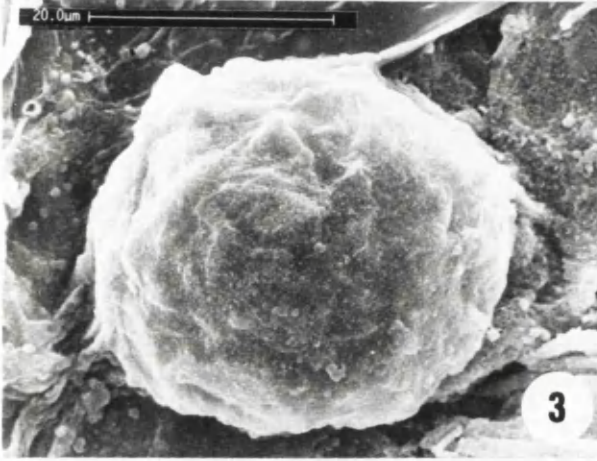
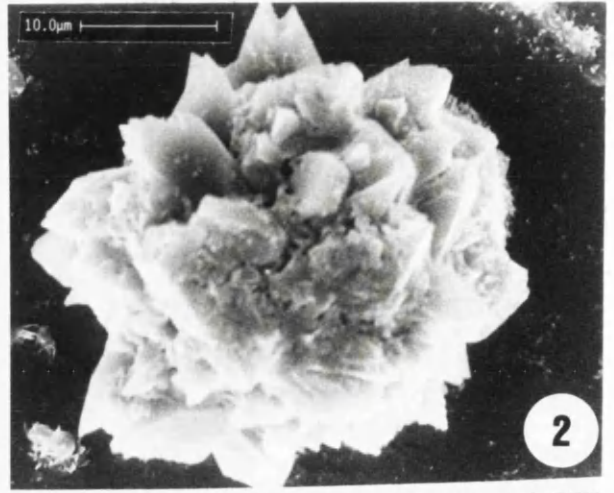
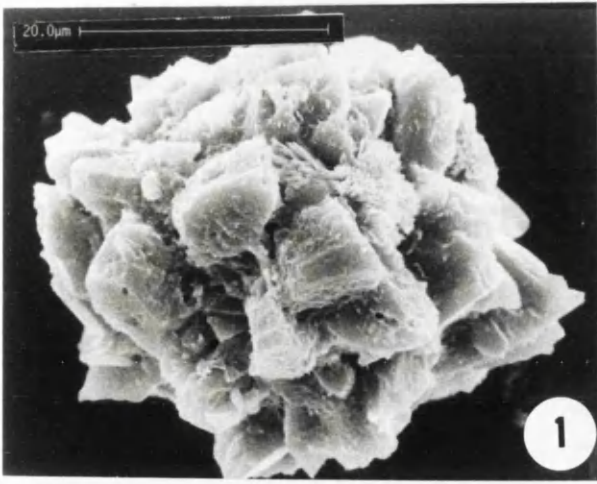

PLATE 37.

SEMs of the different types of crystals of calcium oxalate crystals in
Minuartia .

1. *Minuartia mediterranea*.

2. *M. tenella*

3. *M. mediterranea*.

4. „ „

5. *Minuartia montana*.

6. „ „

PLATE 37

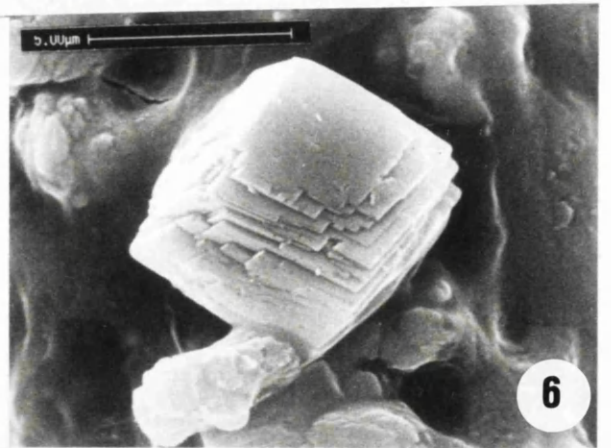
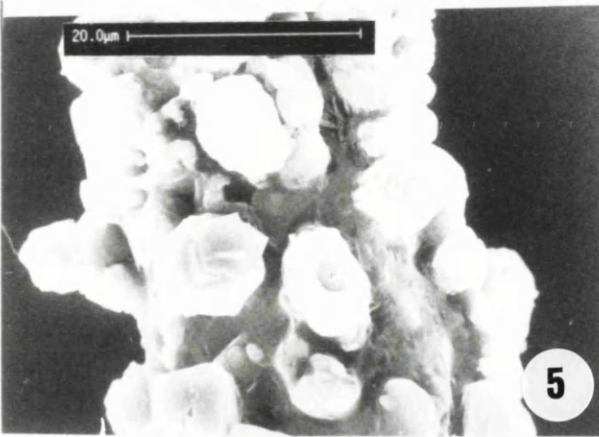
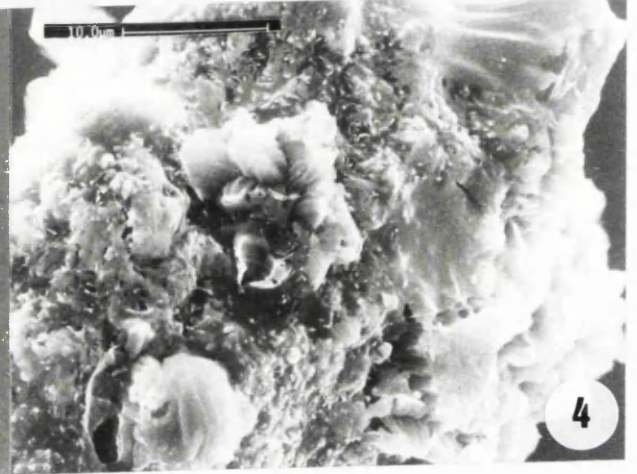
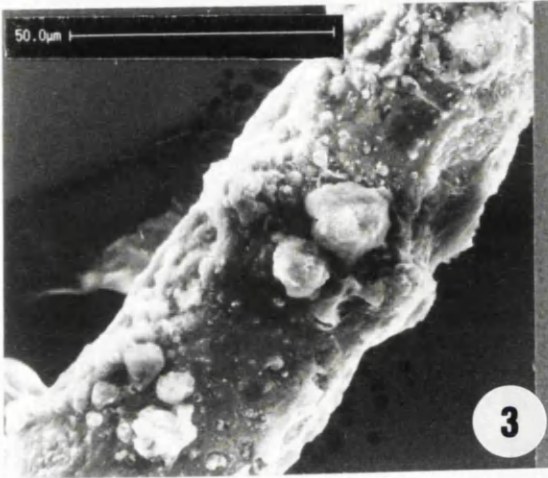
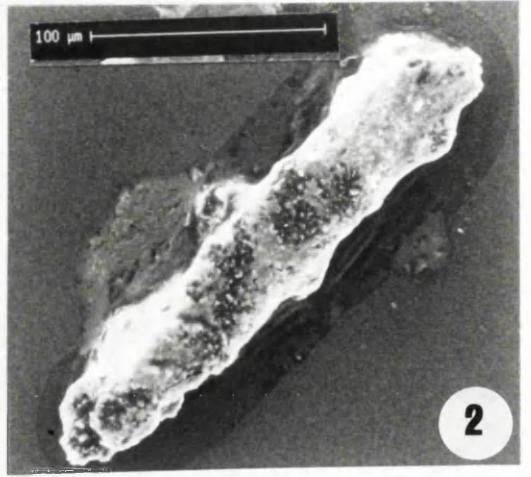
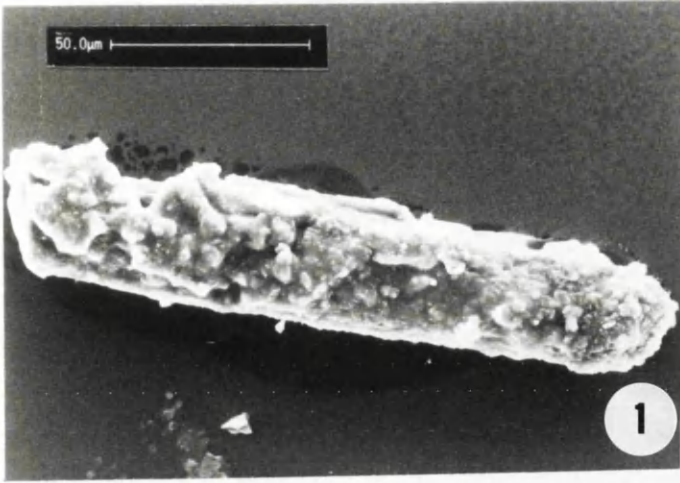

Chapter 5

Capsule and Nutlets

5.1 Introduction

The work presented here which concerns the epidermal morphology of capsules and of nutlets has taxonomic significance in each of the three subfamilies. The capsules of the *Arenaria serpyllifolia* group have already been discussed in section 3.3. *Arenaria leptocaldos* can be distinguished from *Arenaria serpyllifolia sensu stricto* on the basis of papillae on the capsular teeth, Plate 47 (1,2). However, there are no detailed treatments given of the other studies of *Silene*, *Spergula*, *Spergularia*, *Polycarphaea*, *Polycarpon*, *Herniaria*, *Paronychia* and *Minuartia*.

5.2 *Silene*

The results are to be considered provisional especially with regard to the very large genus *Silene* for which the superglue technique (Chapter two) was used. In many of the *Silene* species SEMs were also made and can be compared with the impressions, Plates 38 to 44. In all, 66 Mediterranean species of the genus were studied. According to Greuter *et al.* (1984) there are 60 species of the genus in North Africa.

These 66 species have been arranged into 13 groups according to the shape, size and ornamentation of the cells from the middle of the capsule, as shown in the Plates. The Plates reveal a very considerable diversity of these features. Some species have smooth cells while others have very elaborate ornamentation; see particularly *S. colirosa*, Plate 44 (1,4).

Group A. Epidermal cells, thin walled, mostly elongate with tapering ends, 50-250 μm long, about 20 μm wide, smooth. *S. acaulis* (Plate 38).

Group B. Epidermal cells, thin walled, assymmetrically polygonal-oval, 90-180 μm long and 40-100 μm wide, lacking papillae, arranged irregularly. *S. aegyptica*, *S. fruticosa*, *S. heterodonta*, *S. ibosii*, *S. otites*, *S. littorea*, *S. niceensis*, *S. marmarica*, *S. pseudontiocion*, *S. sedoides*, *S. succulenta*, *S. villosa*, *S. vulgaris* (Plate 38). *S. vulgaris* is very variable in features of the epidermal cells and same specimens can be placed in groups D, G and H.

Group C. Epidermal cells, thin walled, sharply distinct, mostly irregularly pentagonal and hexagonal, more or less isodiametric to about twice as long as wide, each cell raised into distinct papillae. *S. armeria*, *S. atlantica* (Plate 38).

Group D. Epidermal cells, appearing imbricated, mostly regularly ovate, with or without necks, faintly papillate at the swollen base. *S. alba*, *S. dioica*, *S. latifolia*, *S. vulgaris* (Plate 39)

Group E. Epidermal cells narrow, elongate with long necks, faintly papillate. *S. noctiflora*, *S. nutans* (Plate 39).

Group F. Epidermal cells, regular mostly narrowly elongate, of different sizes, one small faint papilla at one end of each cell. There are also irregularly scattered papillae of varied size and with rough surfaces (Plate 40). Encountered in specimens from Spain, Algeria, Libya and Saudi Arabia, these papillae are unique to *S. conoidea*.

Group G. Epidermal cells oval or rectangular, margins faint, each cell raised into a distinct, dome shaped papilla, papillae scattered irregularly. *S. apetala*, *S. articulata*, *S. colorata*, *S. corregata*, *S. cyrenaica*, *S. fuscata*,

S. nocturna, *S. ramosissima*, *S. rubella*, *S. secundiflora*, *S. sericea*, *S. vulgaris* (Plate 40).

Group H. Epidermal cells elongate, with distinct or very faint walls, papillae dome shaped, arranged in regular rows of a few to many (occasional single papillae), number of rows 10-24 per 1mm. *S. arenaroides*, *S. behen*, *S. divaricata*, *S. glabrescense*, *S. kremeri*, *S. imbricata*, *S. inaperta*, *S. longicaulis*, *S. mekinensis*, *S. micropetala*, *S. neglecta*, *S. scabriflora*, *S. stricta*, *S. vivianii*, *S. vulgaris* (Plate 41).

Group I. Similar to group G, but the epidermal cells in slightly curved and raised up into structures like a barriers which may be thin or thick, papillae arranged on the top of the barriers, number of rows 10-16 per 1 mm. *S. boryi*, *S. claryi*, *S. italica*, *S. longipetala*, *S. mollissima*, *S. pratensis* (Plate 41, 42).

Group J. Similar to group H, but the barriers are very thick with very faint cell walls, this group distinguished from group I by the density of irregularly arranged papillae on each barrier, number of rows 5-13 per 1 mm. *S. bellidifolia*, *S. cerastoides*, *S. disticha*, *S. gallica*, *S. ghiavensis*, *S. muscipula*, *S. obtusifolia*, *S. oropedrium*, *S. pomelii*, *S. tridentata*, , *S. tuberculata* (Plate 42, 43).

Group K. Epidermal cells lumped in regular groups of mostly about 10 or more cells, each group curved and making a regular barrier, walls between the cells are very distinct, each barrier cell joined with a small cell and with a very distinct papilla on the top, number of rows about 10 per 1 mm. *S. conica* (Plate 43).

Group L. Epidermal cells thin walled, pentagonal, most cells raised up into bunches with different sizes of smooth papillae. *S. colirosa* (Plate 44).

Group M. Epidermal cells characterized by a specific rod-like shape, of different sizes, with a papilla at on one end of each cell. *S. laeta*, *Lychnis flos-cuculi* (Plate 44).

The only species which falls into more than one group of the above groups is *Silene vulgaris* (in groups B, D and G). Perhaps there is no surprise in that because of the notorious variation of this species, as described in numerous publications such as Marsden-Jones and Turrill (1957) and the many papers by Aeschimann.

Appendix V is a dichotomous key to fruiting plants of Libyan species of *Silene*; only one species, *S. biappendiculata*, is lacking from the key.

5.3 Other Genera

Plates 45 shows the capsular walls of six species of *Polycarpon* and two of *Polycarpaea*, namely *P. repens* and *P. robbairea*. The great similarity of the latter two is further evidence for the lack of distinctiveness of the genus *Robbaria*. Plate 46 shows all five species of the genus *Spergula* and three of 11 studied species of the genus *Spergularia* which has 40 in all. Four of the *Spergula* species stand out in their cells with very marked arms but *S. viscosa* has only slightly wavy cells, many of which are short. The three species of *Spergularia* by contrast have long, narrow cells with no arms or with only very slightly wavy walls.

Spergula arvensis is a very widespread species. Its variability in habit, pubescence, size of seeds and testa pattern is mentioned in many Floras such as Tutin *et al.* (1993) and Davis (1965). The capsular epidermis is totally distinct from those of the other species in the transverse fibral-like thickenings. This feature was found in specimens from 14 different localities from Australia to Atlantic islands (Appendix II) and so appear to be a good specific character.

Spergula morisonii and *S. pentandra* are alike in habit and are separated on floral and seed characters. They can also be differentiated by the epidermal cells which have rounder, less tapered arms of more equal lengths in *S. morisonii* than in

S. pentandra, Plate 46 (3,4).

In *Minuartia* subgenus *Minuartia* it was noticed that the capsules have delicate but clear cuticular striations in the upper third of the valves. This feature appears to be confined to that subgenus and furthermore the striations are not found in those sections in which the crystals are only intercostal. Therefore this correlation is found in sections *Plurinerviae*, *Lanceolatae*, *Aretioideae*, *Sclerophylla*, *Tryphane*, *Alisanthe*, *Greniera* and *Minuartia*. The sole section in which it is not found is *Spectabiles*.

Plate 47 (3,8) shows five species of *Paronychia*. In all cases and also in those on the last Plate, 48 the SEMs are of the upper ends of nutlets. These are very striking patterns of ornamentation to be seen in both *Paronychia* and *Herniaria*. *H. cyrenica*, an endemic of Libya (and perhaps also of Egypt), has very elaborate features which are very like those of the very widespread *H. glabra*.

The plates from 38 to 44 are SEMs of capsule wall (midzone) and LMs of impressions of capsule wall of *Silene*.

PLATE 38.

1. SEM of *Silene acaulis*.
2. LM of „ „, x 400.
3. LM of *Silene fruticosa* x160.
4. LM of *S. niceensis* x160.
5. LM of *S. succulenta* x160.
6. LM of *S. villosa* x160.
7. LM of *S. armeria* x160.
8. LM of *S. atlantica* x160.

PLATE 38

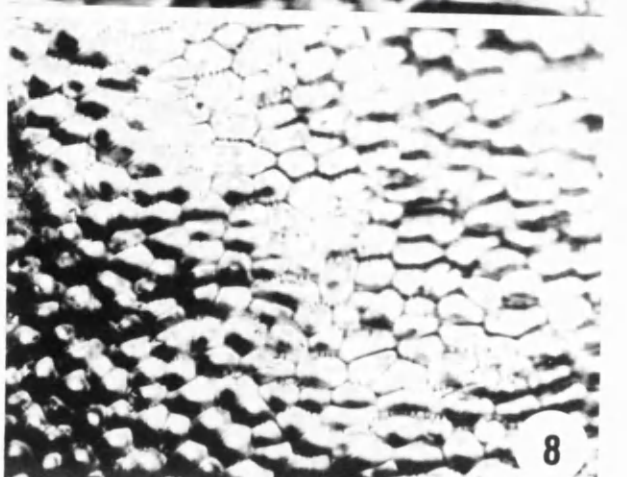
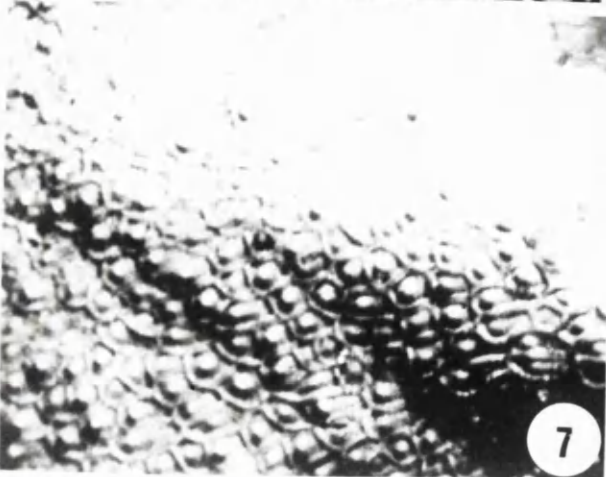
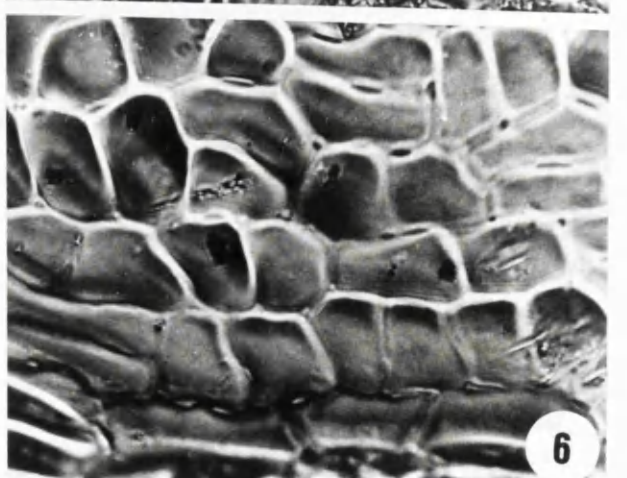
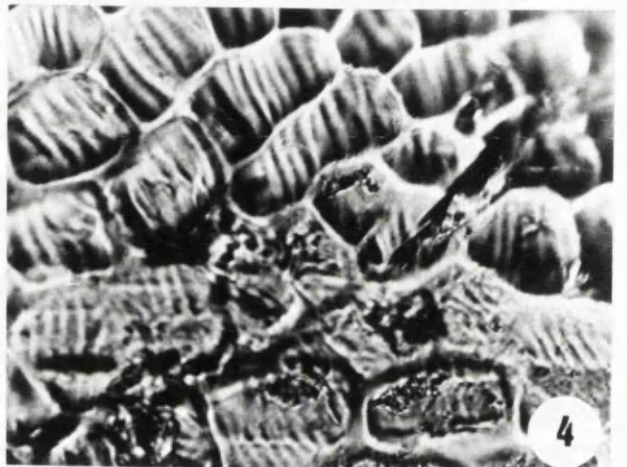
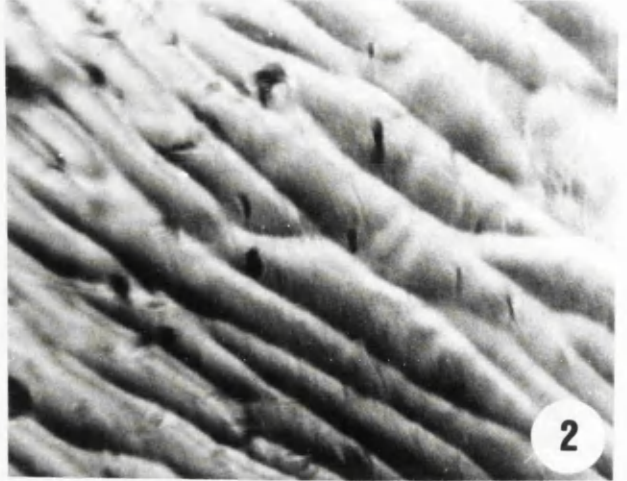
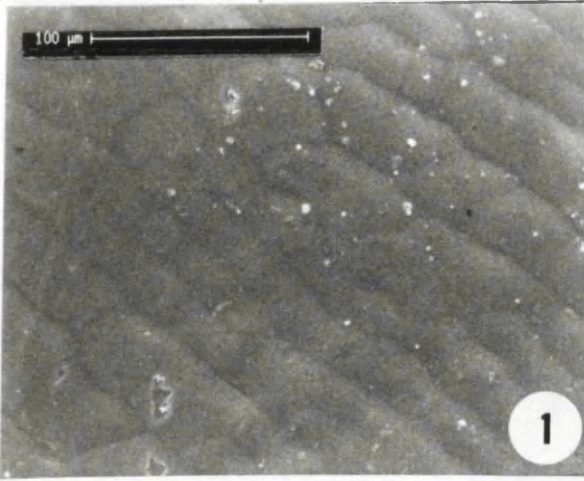

PLATE 39.

1. SEM of *Silene dioica*.
2. „ „ „ „
3. LM of *Silene latifolia* x160.
4. LM of *S. dioica* x160.
5. SEM of *Silene nutans*.
6. „ „ „ „
7. LM of *Silene noctiflora* x160.
8. LM of *S. nutans* x160.

PLATE 39

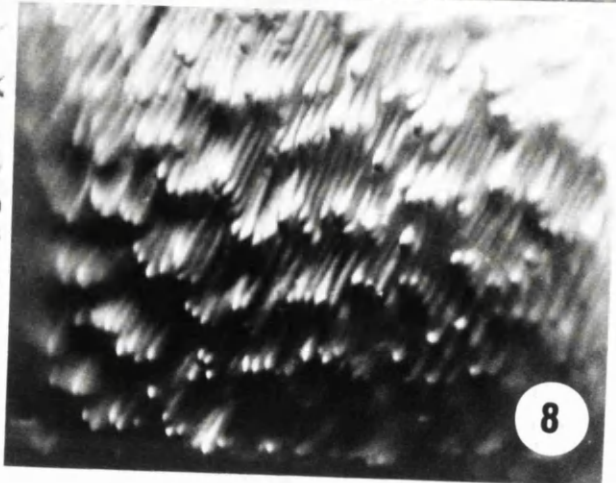
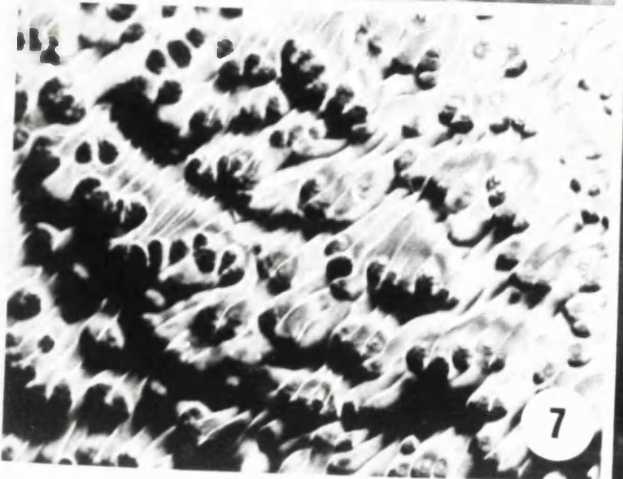
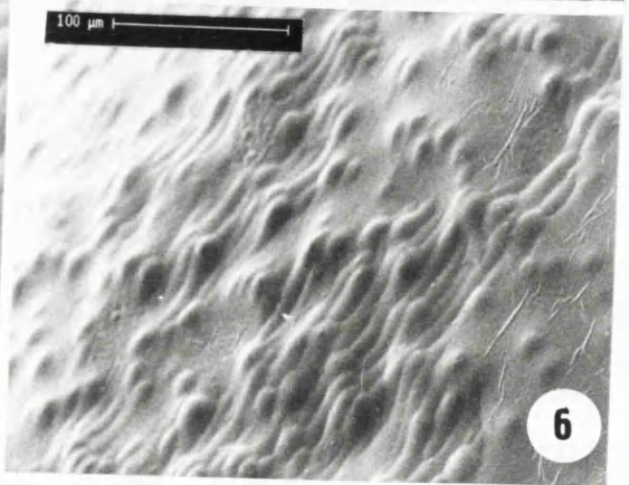
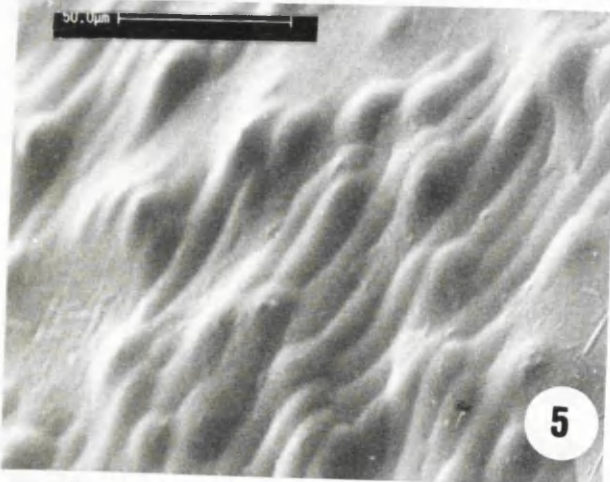
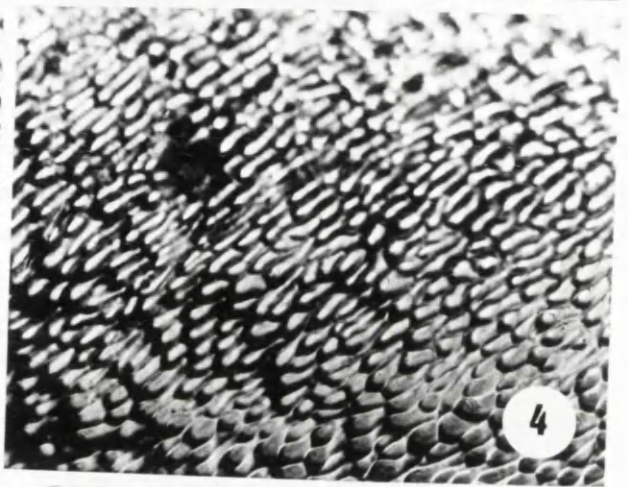
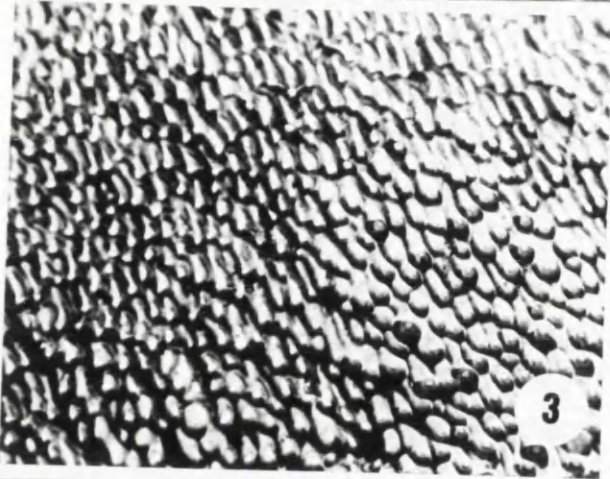
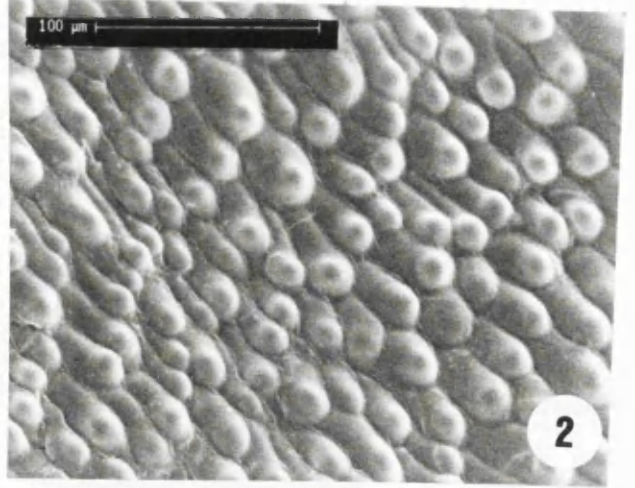
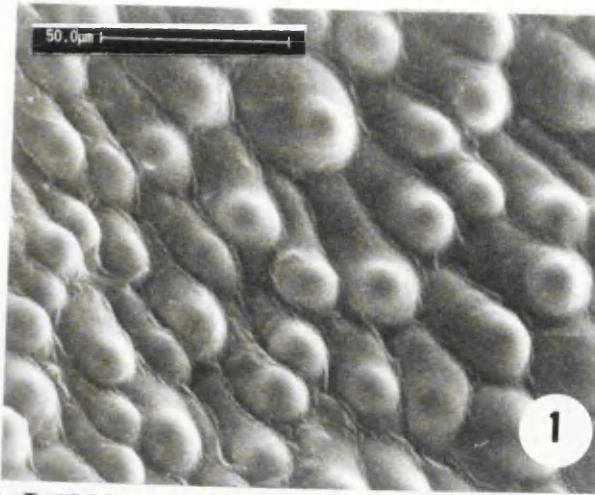

PLATE 40.

1. SEM of *Silene conoidea*.
2. „ „ „
3. SEM of *Silene colorata*.
4. „ „ „
5. LM of *Silene apetala* x160.
6. LM of *S. colorata* x160.
7. LM of *S. cyrenaica* x160.
8. LM of *S. rubella* x160.

PLATE 40

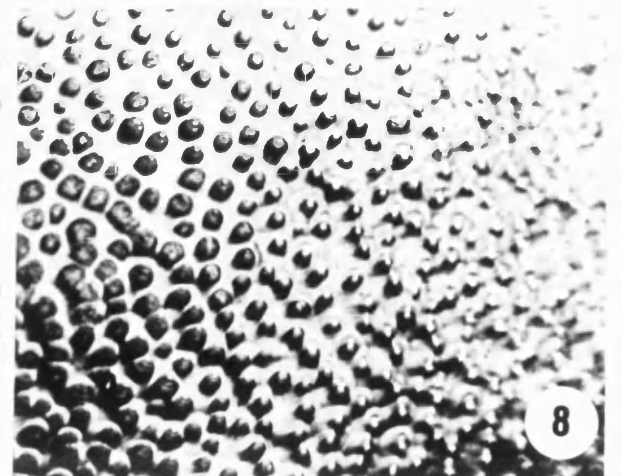
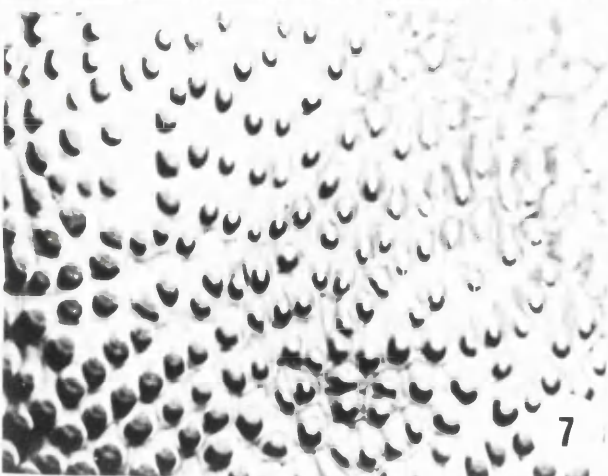
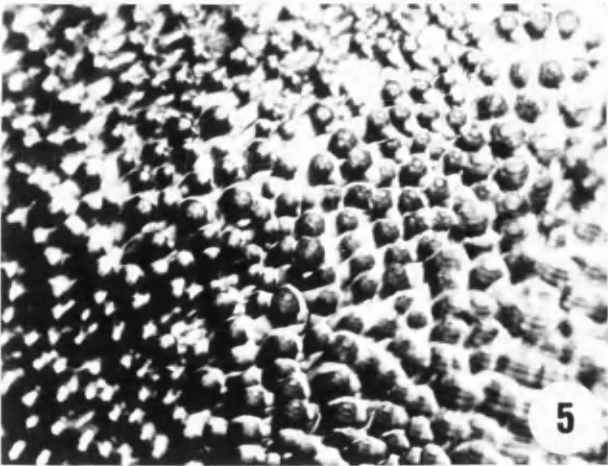
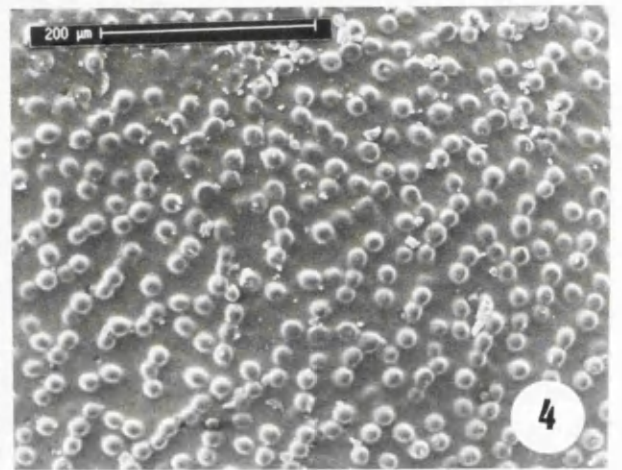
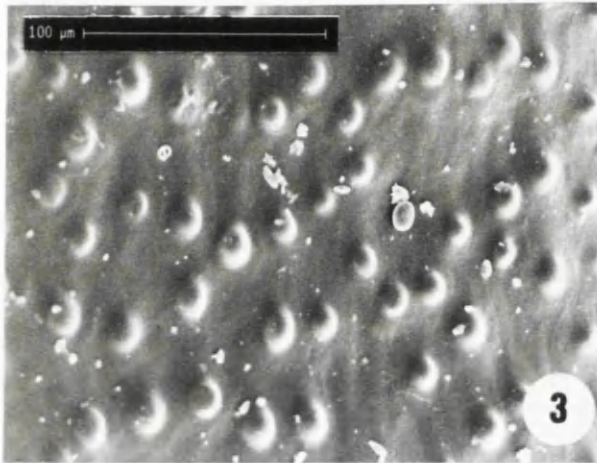
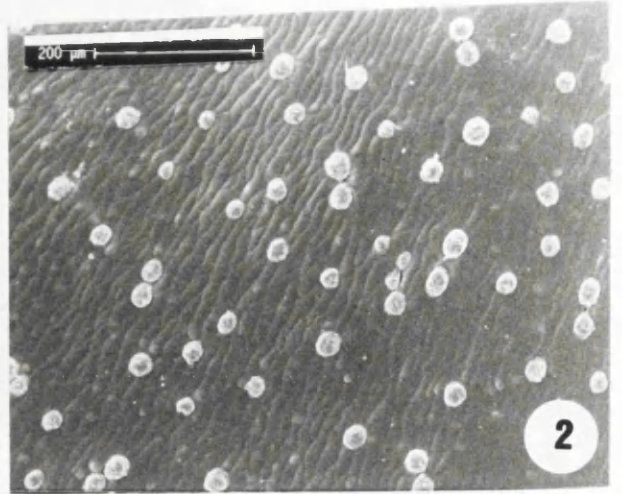
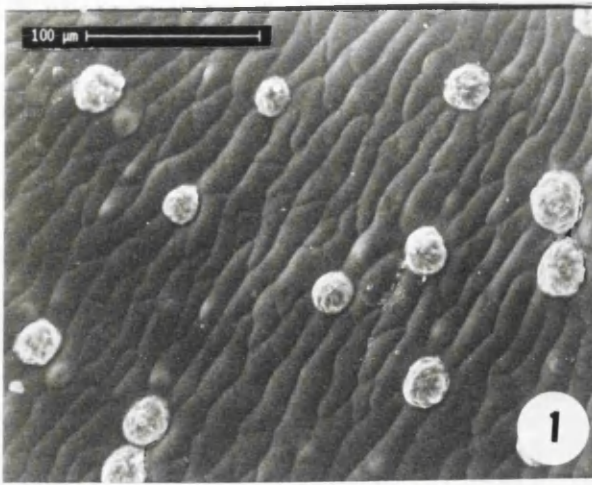

PLATE 41.

1. SEM of *Silene longicaulis*.
2. „ „ „
3. LM of „ „, x160.
4. LM of *S. neglecta* x160.
5. SEM of *Silene longipetala*.
6. „ „ „
7. LM of „ „, x160.
8. LM of *S. claryi* x160.

PLATE 41

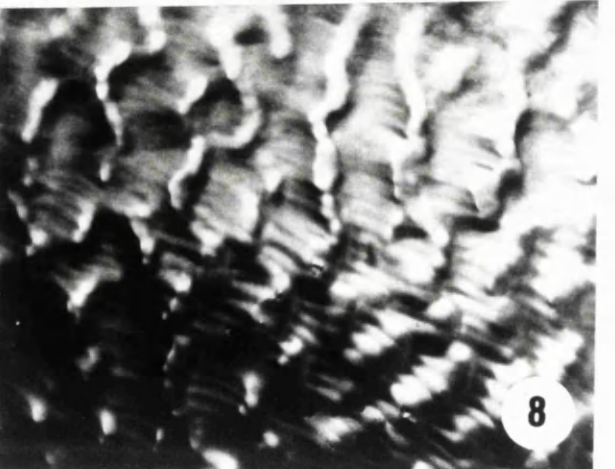
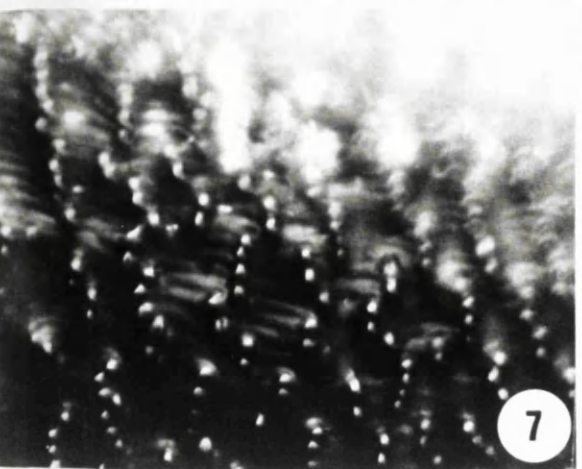
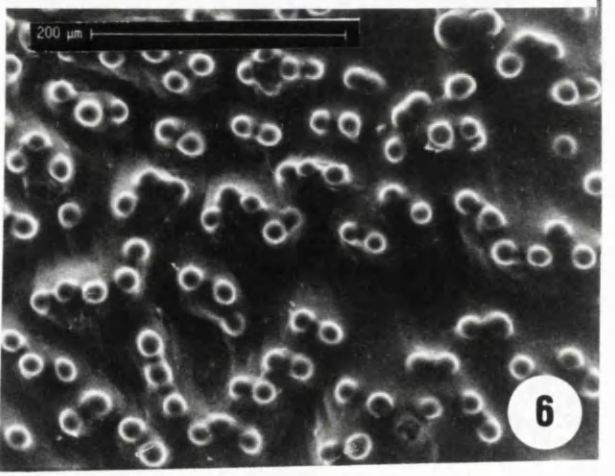
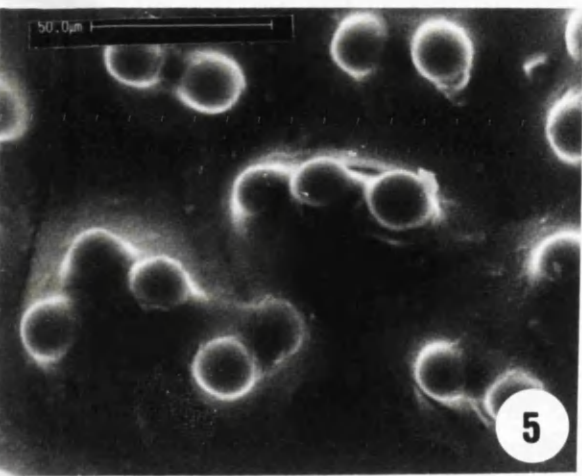
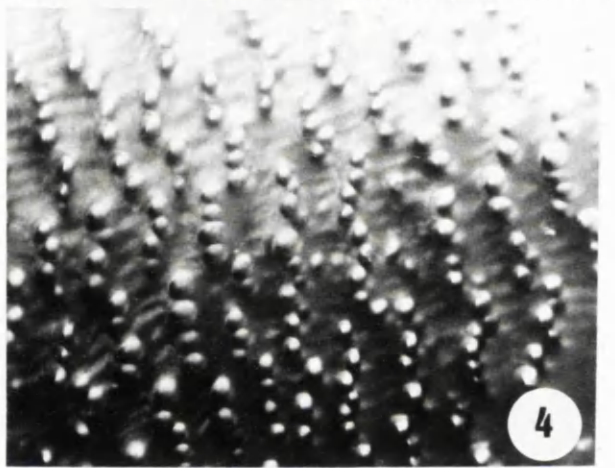
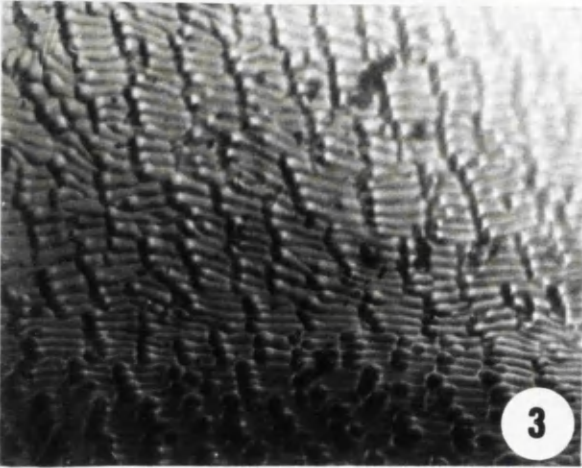
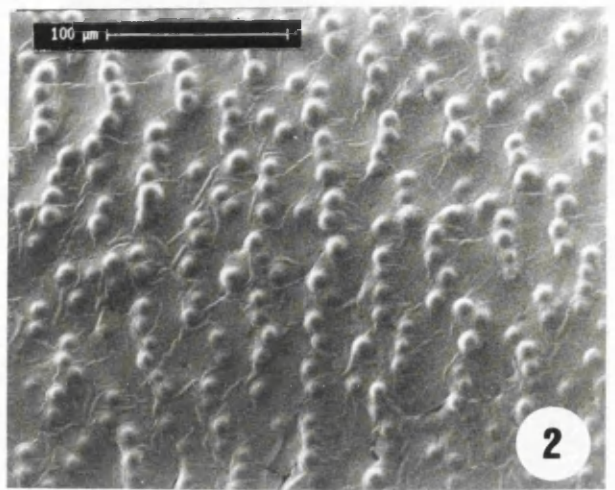
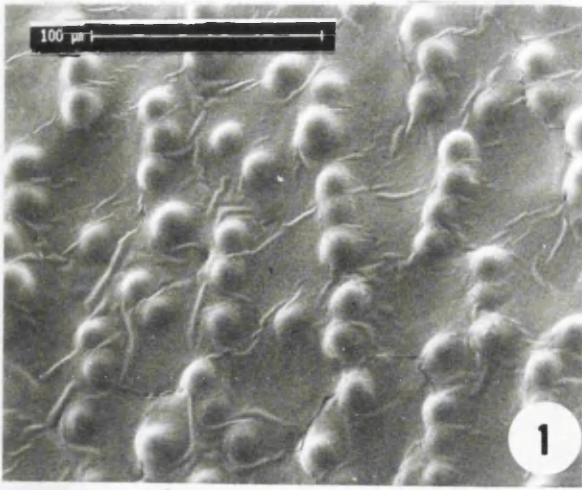

PLATE 42.

1. SEM of *Silene atlaica* .
2. „ „ „
3. LM of *S. boryi* x160.
4. LM of *S. italica* x160.
5. LM of *S. mollissima* x160.
6. LM of *S. protensis* x160.
7. SEM of *Silene pomelii*.
8. „ „ „

PLATE 42

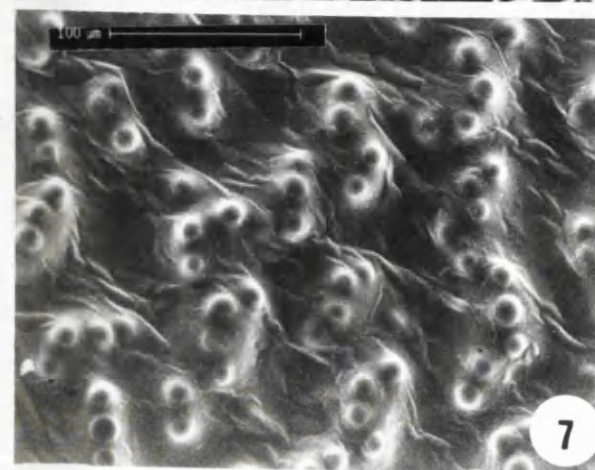
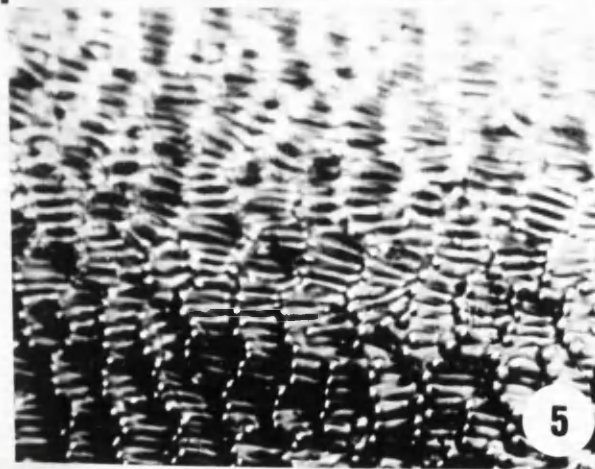
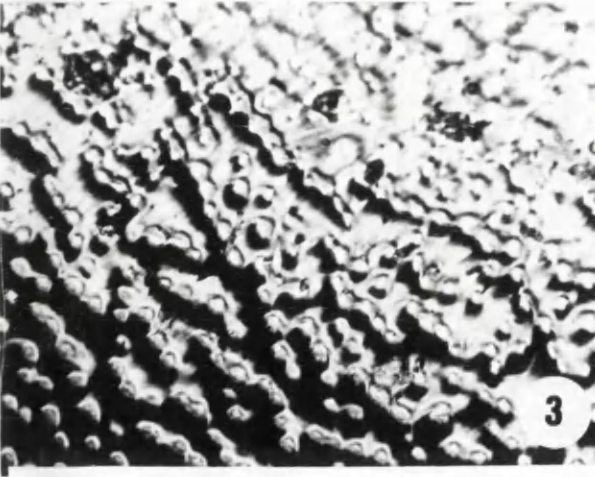
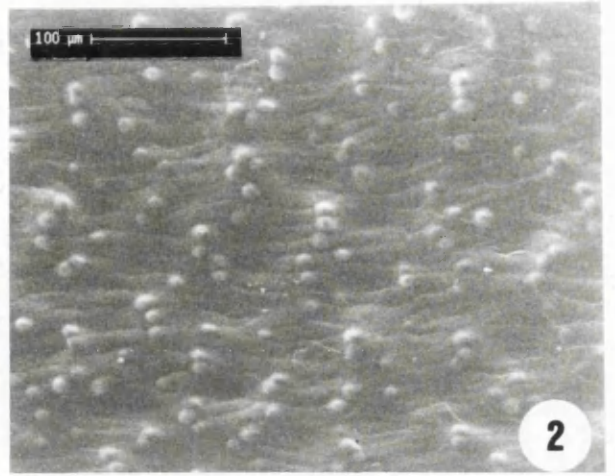
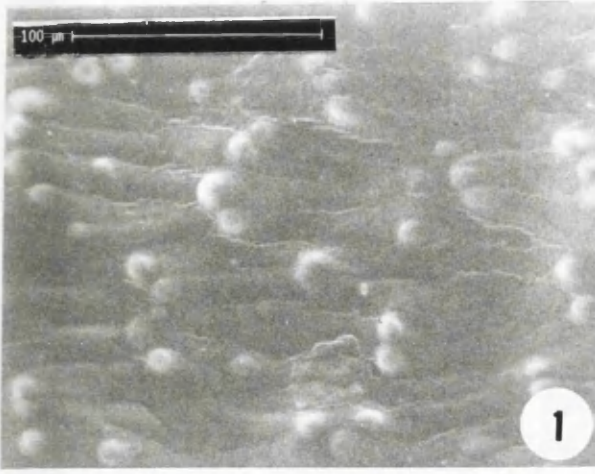

PLATE 43.

1. SEM of *Silene tridentata*.
2. „ „ „ „
3. LM of „ „ x160.
4. LM of *Silene gallicax*160.
5. SEM of *Silene cerastoides*.
6. LM of *Silene conica* x160.
7. SEM „ „
8. „ „ „

PLATE 43

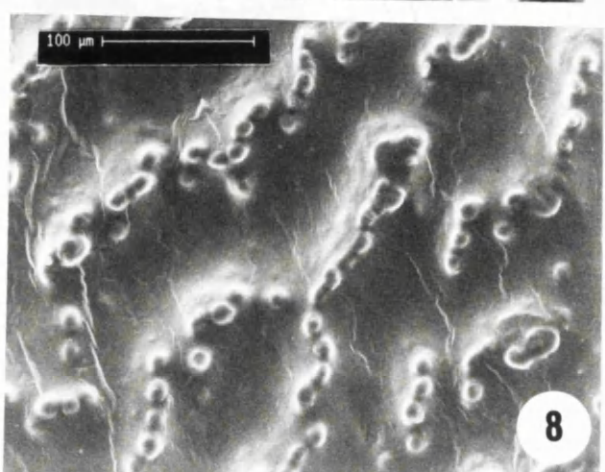
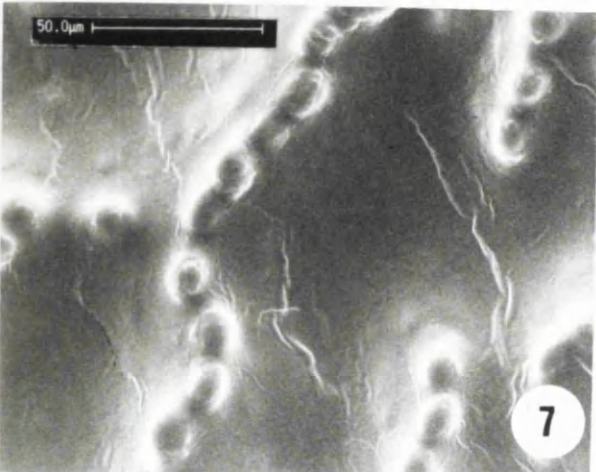
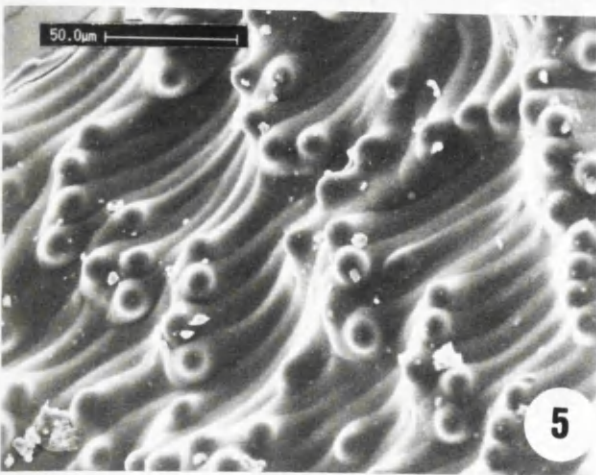
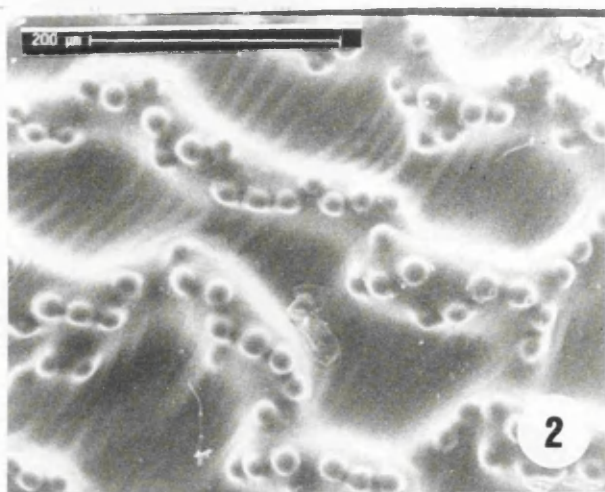
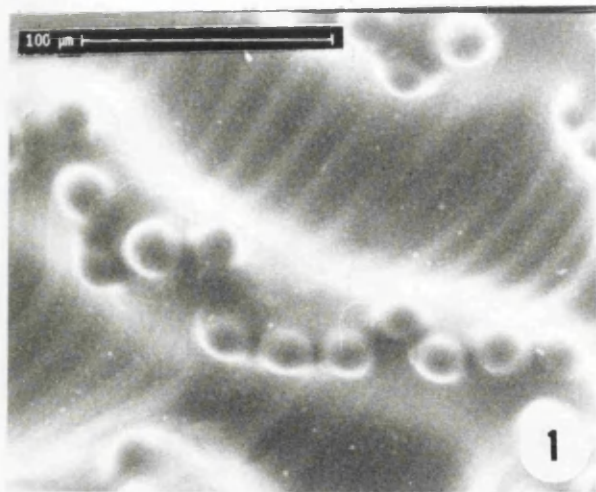
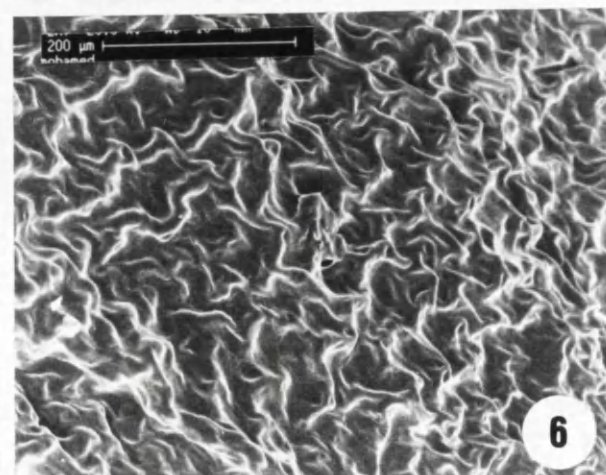
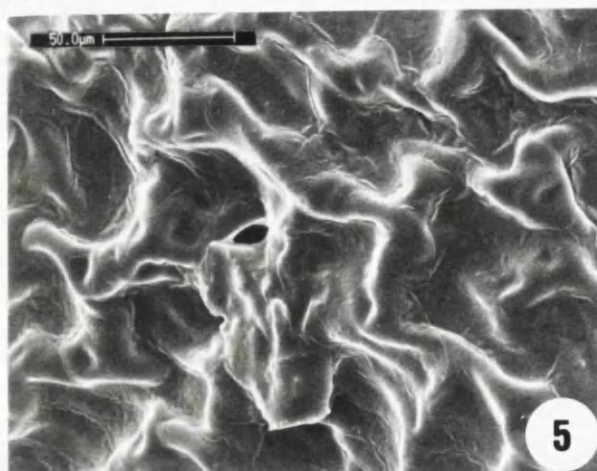
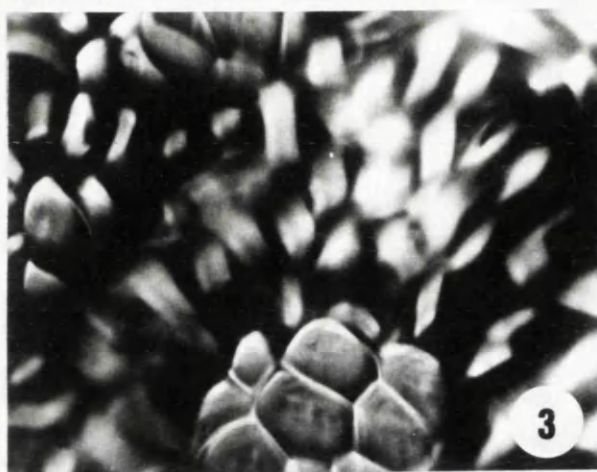
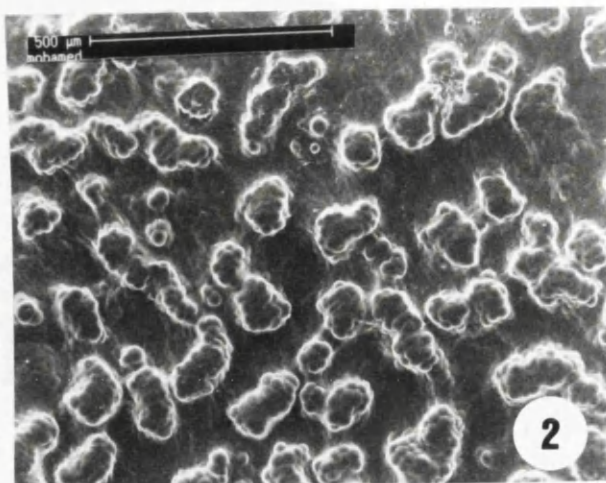
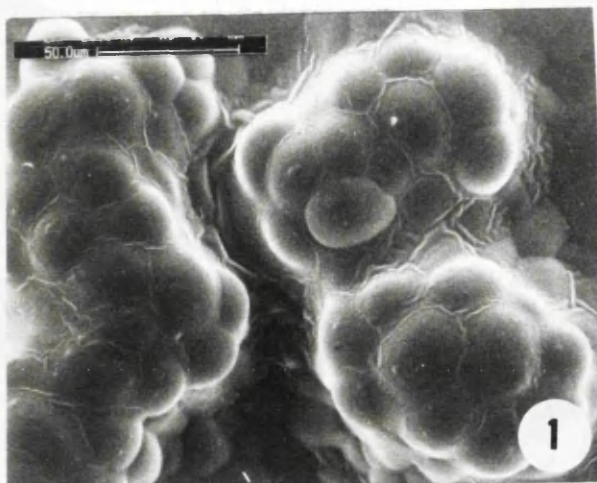

PLATE 44.

1. SEM of *Silene colirosa*.
2. „ „ „ „
3. L M of „ „, x400.
4. „ „ „ „, x160.
5. SEM of *Silene laeta*.
6. „ „ „ „
7. LM of „ „, x400.
8. LM of *Lychnis flos-cuculi* x400.

PLATE 44



The plates no 45 and 46 LMs of capsule walls showing cell shape and ornamentation in the midzone areas of *Polycarpon* and *Polycarpaea*

PLATE 45.

1. *P. arabicum* x160.
2. *P. bivonae* x160.
3. *P. depressum* x 160.
4. *P. peploides* x160.
5. *P. polycarpoides* x160.
6. *P. tetraphyllum* x160.
7. *Polycarpaea repens* x160.
8. *Polycarpaea robbairea* x160.

PLATE 45

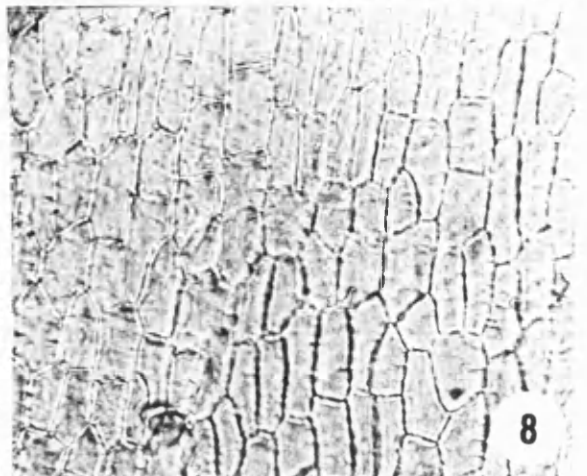
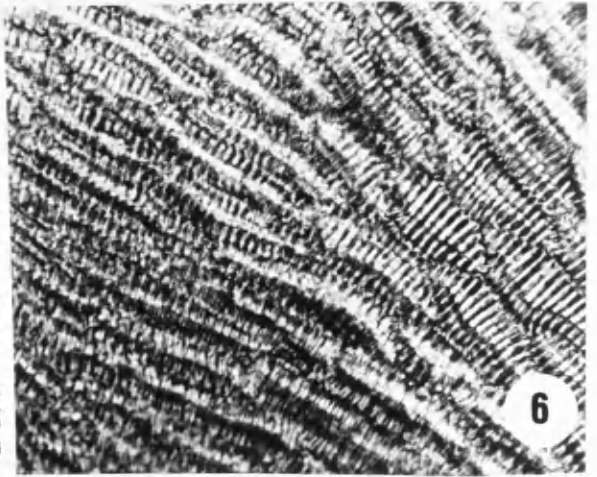
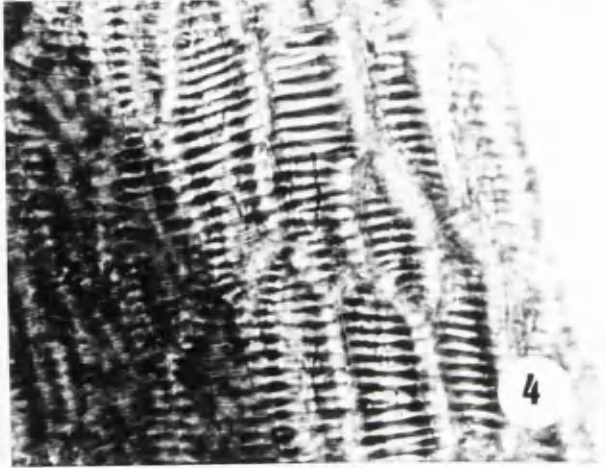
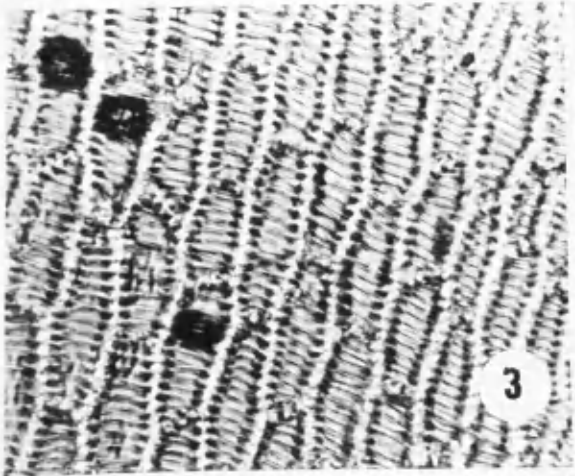
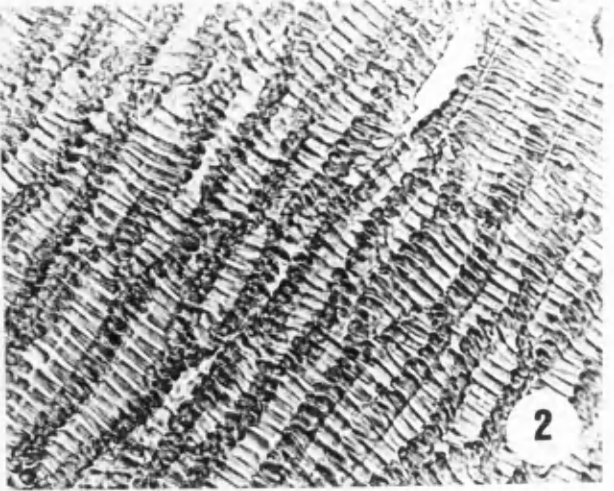
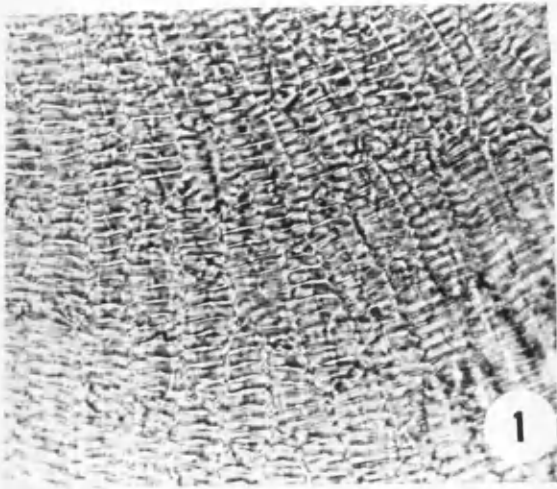
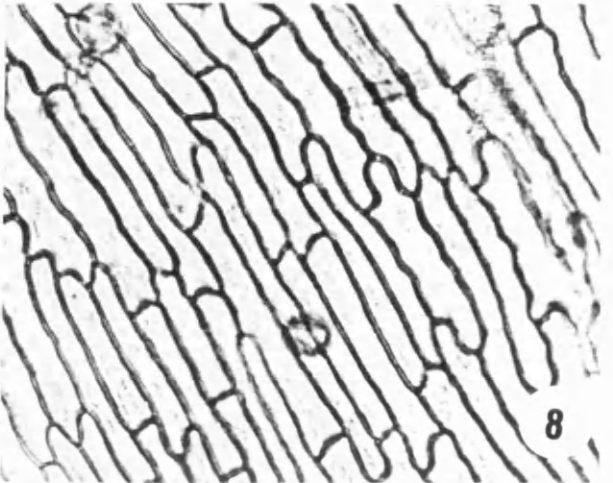
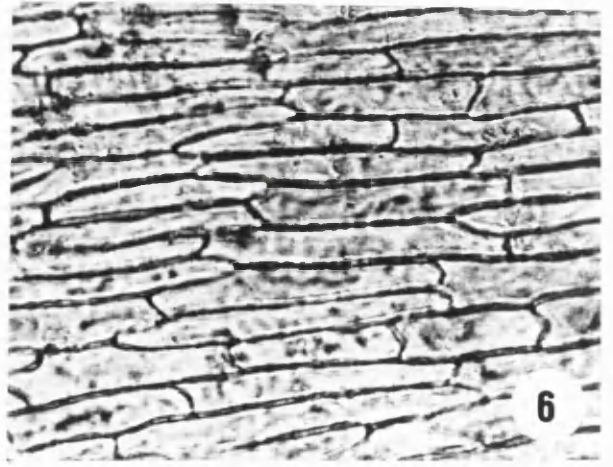
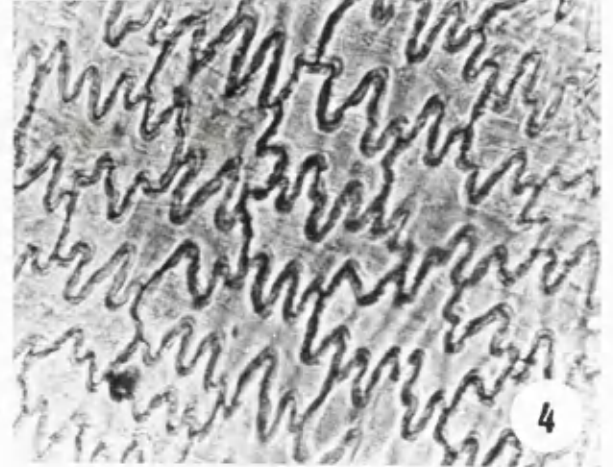
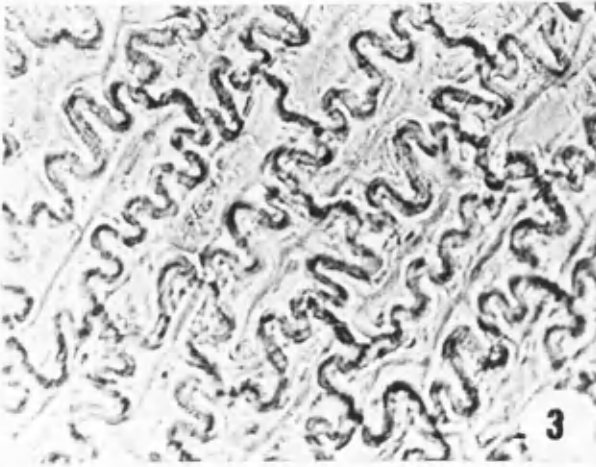
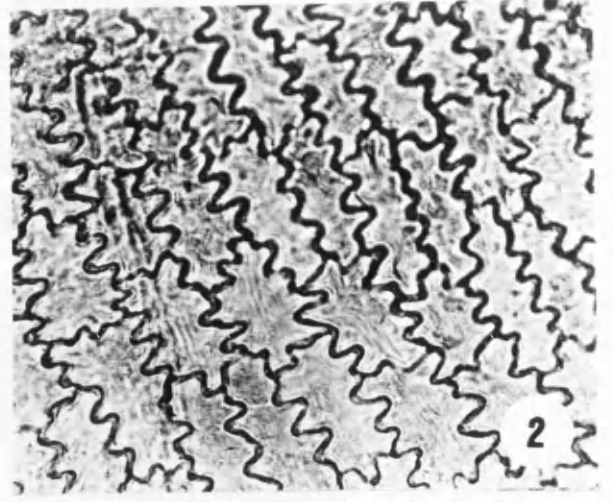
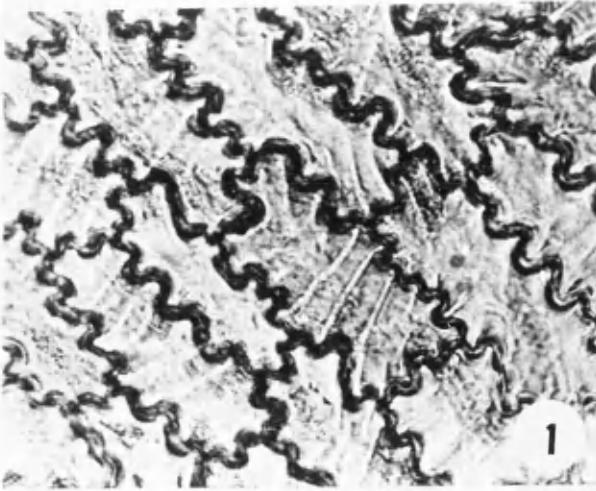

PLATE 46.

1. *Spergula arvensis* x160.
2. *S. fallax* x160.
3. *S. morisonii* x160.
4. *S. pentandra* x160.
5. *S. viscosa* x160.
6. *S. salina* x160.
7. *Spergularia maritima* x160.
8. *S. rubra* x160.



The plates no 47 and 48 are SEMs of capsule wall showing surface ornamentation of *Arenaria*, *Paronychia* and *Herniaria*

PLATE 47.

1. *Arenaria serpyllifolia*.
2. *A. leptoclados*.
3. *Paronychia arabica*.
4. *P. argentea*.
5. *P. capitata*.
6. *P. chlorothyrsa*.
7. *Paronychia kapela*.
8. " "

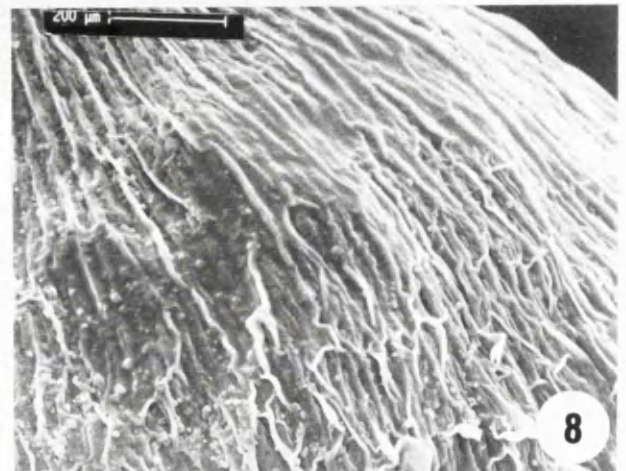
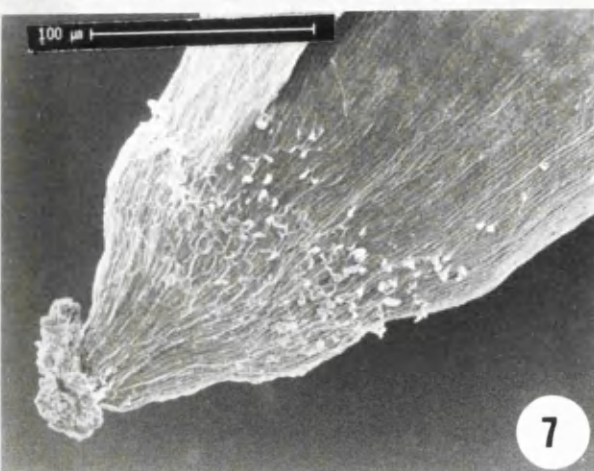
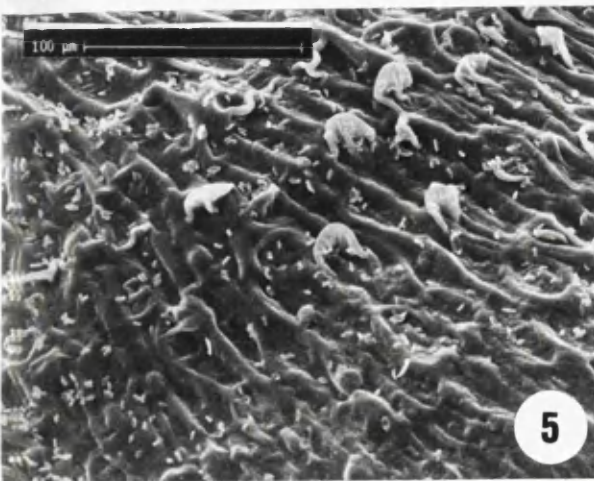
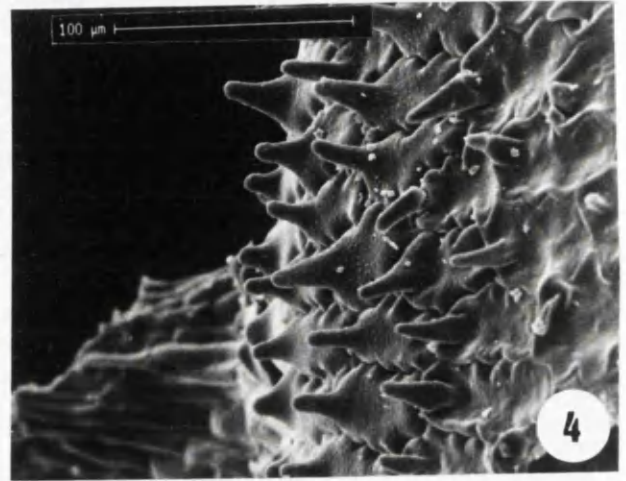
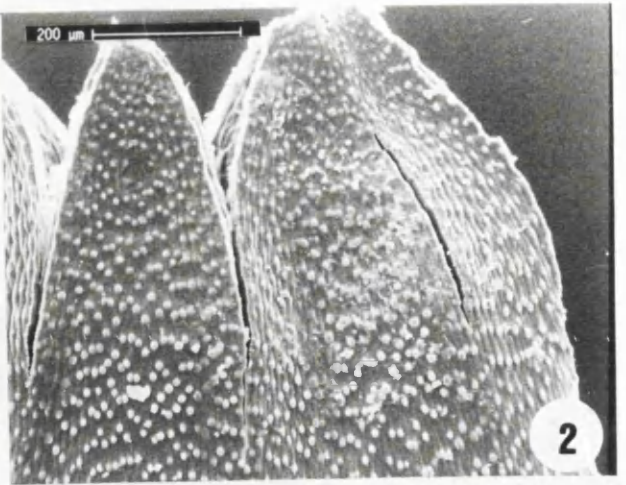
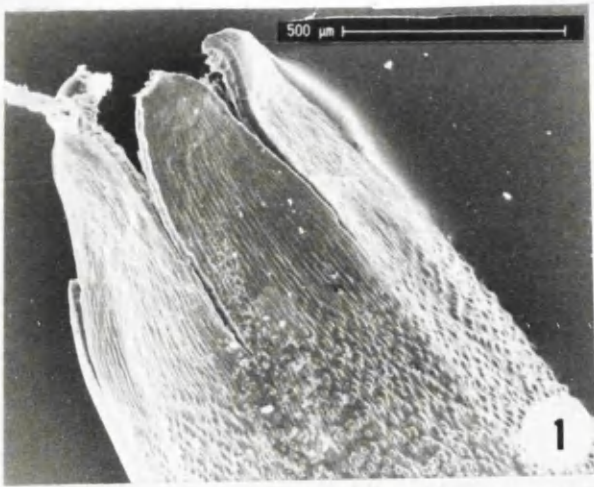

PLATE 48.

1. *Herniaria cinerea*.

2. *H. cyrenaica*.

3. *H. glabra*.

4. „ „

5. *Herniaria fontanesii*.

6. „ „

7. *Herniaria hemistemon*.

8. „ „

PLATE 48

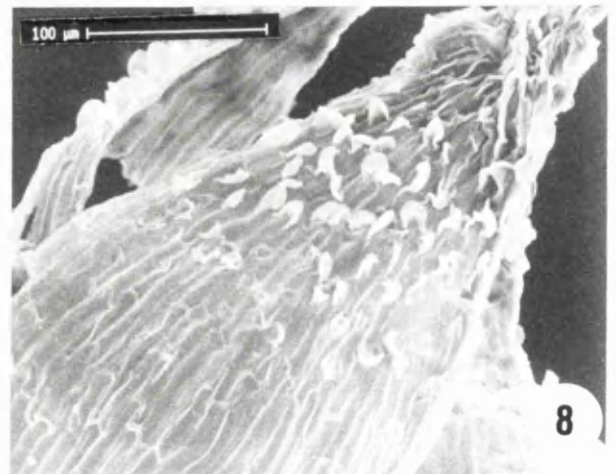
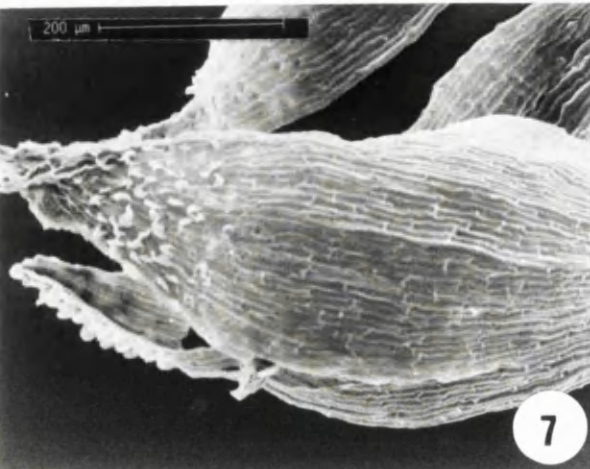
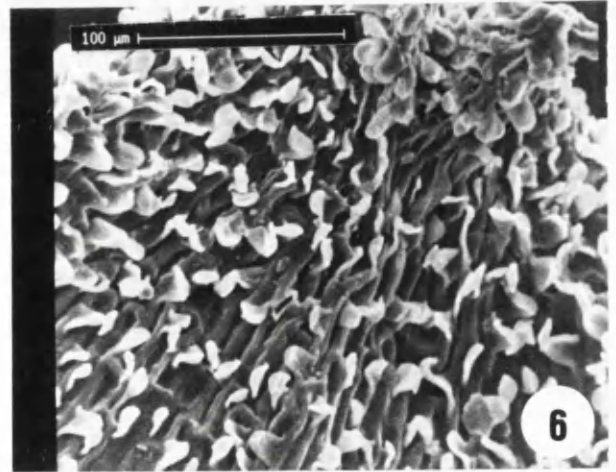
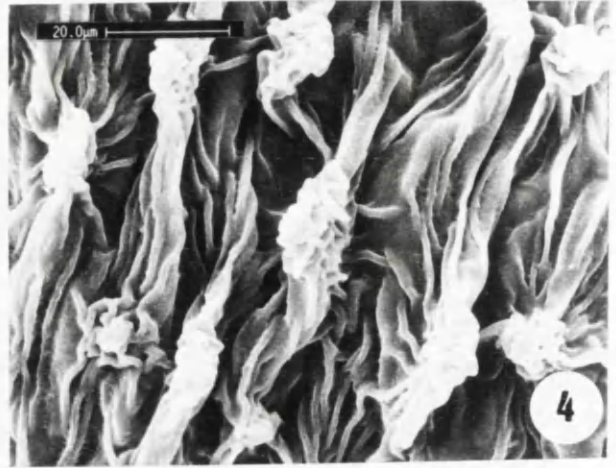
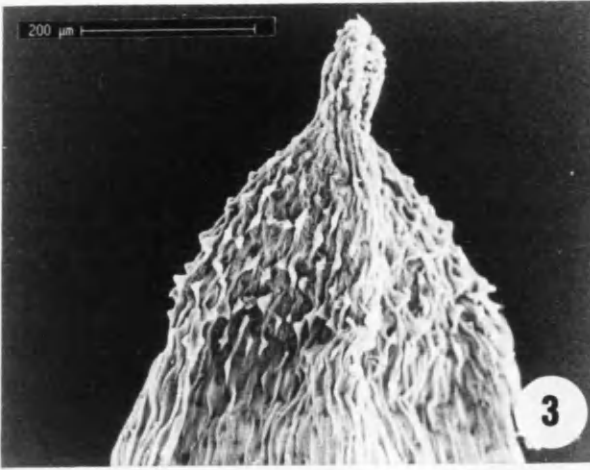
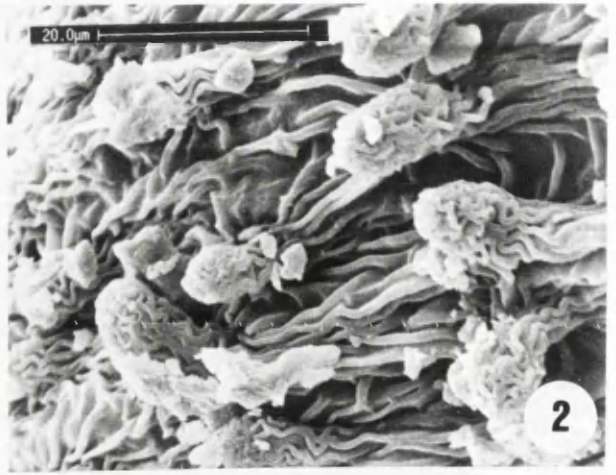
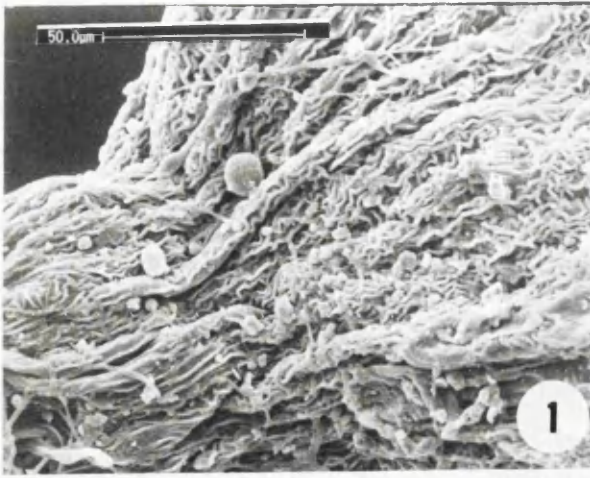

Chapter 6

General Discussion and Conclusions

6.1 Chapter 2 Methods

Light microscopy and standard SEM techniques were used to produce the results and data concerning seeds discussed in this thesis and such a statement largely suffices for the work on the foliar crystals. However, the slightly modified version of Bokhari's technique allowed the much speedier production of good preparations. In examining the capsular surfaces of *Silene* the superglue method proved to be swift, easy and inexpensive and gave very satisfactory impressions and photographs which can be compared with the SEM results.

6.2 Chapter 3

SEM techniques give excellent images of details of the testa surfaces, as has been known for the few decades since their first applications in late 1960s. The survey of seeds of the Libyan species and also of those few Canarian endemics (*Polycarpaea*) bears this statement out in striking fashion. Some particularly beautiful examples among the Paronychioideae are the Tenerife specimens of *Polycarpaea*, notably the details of the papillae (Plates 3,4 and 5), among the Alsinoideae the spurred cells of *Cerastium* (Plate 14 and 15) and among the

Caryophylloideae *Petrorhagia velutina* (Plate 23) and the four figures of *Silene longipetala* (Plate 28, 1 to 4). Chapter 3 includes very detailed descriptions of the seeds of almost all the Libyan species of Caryophyllaceae and there are discussions of particular examples of the use of seed characters to distinguish species, genera and tribes. The complex details of the seed characters are summarised in Tables 6 to 9 (pages 228-231) to facilitate the understanding of the sections 6.2 to 6.2.6 which are the concluding statements on taxonomy from the species to the subfamilies.

6.2.1 Testa Micromorphology: Species and Intraspecific Taxa

The Davis specimen 50344 of *Arenaria serpyllifolia* raises the whole question of the taxonomic value of papillosity (and verrucosity). It has papillate seeds and the many other British and North African specimens of the *Arenaria serpyllifolia* group that were examined do not. It would be useful to know if the type specimen of *A. minutiflora* has papillate seeds or not but this is not crucial to the argument here which is "Can the presence/absence and abundance of papillae/warts be to some degree under environmental control?" The work of New (1958, 1959, 1961) dealt with papillate and non-papillate seeds of British *Spergula arvensis* and she advanced strong arguments

that these features of the testa were correlated with latitude and altitude and also with germinability. These papillae are well illustrated by Kowal (drawings, 1966) and by Stace (SEMs, 1991). Mentioning Clapham *et al.* (1952), New attached no taxonomic significance to the differences in testa micromorphology. However, despite the evidence for some environmental control, Stace (1991) gives two varieties of this species based on the testa features. In the presence or absence of papillae and warts, *Sagina apetala*, *Silene apetala* and *Minuartia geniculata* are variable but in all cases further study is needed.

The Plates 3 to 5 reveal the great diversity of testa ornamentation within a small number of species of *Polycarpaea*, a genus with some 50 species according to Mabberley (1987). This is a genus well worth revision and any revision cannot ignore these striking seed characters.

6.2.2 Seed Shape and Testa Micromorphology Genera/

Subgenera

On gross morphological grounds the genera *Robbariea* and *Polycarpaea* are very similar. In both the overall shape seeds and the details of the micromorphology the seeds of *Robbariea* are so similar to those of *Polycarpaea* that there are no grounds for the generic separation made by some authors. Similarly the seeds of *Minuartia geniculata* are not distinct in

any marked way from those of other species of the genus and hence there is no support for a genus or even subgenus *Rhodalsine* though characters of pollen and other features may give good reason for such a separation. See also the final discussion of foliar crystals.

The very large genus *Silene* has species with reniform seeds with no wings or with double, undulate wings, reniform seeds with single thin wings [*S. uralensis* (Rupr.) Bocquet and *S. furcata* Rafn.] and even globular seeds (as already mentioned in 3.3 *Telephium*). The shape of the lateral faces varies from species to species in convexity and concavity. There are many shapes of testa cells as shown by Rechinger *et al.* (1988) and in this thesis. Any attempt to revise the sections or perhaps even to split the genus should take account of these seed attributes.

6.2.3 Seed Shape and Testa Micromorphology: *Telephium*

The case was made in 3.3 that *Telephium* has seeds very different from all other seeds in the family and the tentative argument made for removal of the genus from that family. In the Bittrich classification *Telephium* is joined with *Corrigiola* in tribe Corrigiolae Dumort. (1927). However, the seeds of *Corrigiola* greatly resemble those of *Scleranthus annuus* in subfamily Alsinoideae. A description of British material of seeds of the last named is as follows:

Seeds more or less subglobular, pale yellow, testa cells indistinct, with thin somewhat sinuous walls, lacking any ornamentation, marginal face with a broad, sharply delimited darker yellow brownish band all round the seed, radicle terminal, prominent and pointed, hilum a subterminal dark patch, seed surface smooth and the marginal band somewhat glossy.

Such a description almost suffices for the seeds of *Corrigiola littoralis* except that the radicle is obtuse not pointed. Clearly more work is needed on all the 11 species of *Corrigiola* and all 10 of *Scleranthus*. Though as stated in 3.3 it would be premature to suggest the removal of *Telephium* from the family, it is clear that the evidence from seed morphology is already strong enough for the placement of the genus in its own tribe.

6.2.4 Seed Shape: the Dorsiventral Genera

That the monotypic genus *Pteranthus* of the Paronychioideae is somewhat dorsiventrally flattened has perhaps received no previous comment and it is at least of interest in showing that such flattening is not confined to *Dianthus* and related genera of the Caryophylloideae. Nor is flattening lacking totally from the Alsinoideae. The small genus *Holosteum* has "seeds longitudinally keeled, peltate", according to Bittrich (1993, p. 227) but "asymmetrically reniform and laterally compressed", according

to *Flora Europaea* (p. 164). Berggren (1981,p. 79) described the seeds of *H. umbellatum* L. as "shield-formed, with a slight apical notch". Her illustration shows the seed well.

In *Dianthus*, *Petrorhagia*, *Kohlrauschia* (sometimes subsumed in *Petrorhagia*, as in *Flora Europaea*) and *Velezia* the flattening at the greatest can produce very thin, seeds of that very diagnostic shape often called scutate. Last century taxonomists attached importance to this shape as for instance in *Genera Plantarum* of Bentham and Hooker. These authors linked the genera *Velezia*, *Dianthus* and *Tunica* under the heading (p. 142) " Semina peltata, hilo faciali. Embryo erectus. Styli 2. (Diantheae)".

20th century taxonomists have ignored this distinction at the level above the genus with Bittrich (1993) the latest example. There is little if anything in the testa cell shape and ornamentation of *Dianthus* and related genera to separate them from other members of Caryophylloideae. Nevertheless, the dorsiventral flattening into the scutate and boat-like shapes deserves formal taxonomic recognition which would have to be at tribal rank.

6.2.5 Seed Characters: the Tribes

In the two previous sections dealing with *Telephium* and the dorsiventral genera the erection of tribes based on seed

characters has been considered and this matter can be taken further. In his tribal diagnoses Bittrich (1993) makes no mention of seeds other than the number of seeds per fruit.

The genera studied for this thesis are shown in italicised bold. Many of the unstudied genera are very small or even monotypic and Bittrich gives no seed characters.

Tribes and Genera according to Bittrich.

1. Subfam. Paronychioideae

1. Tribe Polycarpeae

Drymaria, ***Spergula***, ***Spergularia***, Sanctambrosia, ***Polycarpaea***, Polycarpon, Ortega, ***Loeflingia***, Haya, Xerotia, Krauseola, Polytepalum, Stipulicida, Cerdia, Microphytes, Pirinia

2. Tribe Paronychieae

Cometes, Dicheranthus, ***Pteranthus***, Sphaerocoma, ***Sclerocephalus***, Lochia, ***Paronychia*** (including ***Gymnocarpos***), ***Herniaria***, Philippiella, Chaetonychia, Achyronychia, Illecebrum, Cardionema, Scopulophila, Pollichia

3. Tribe Corrigioleae

Telephium, ***Corrigiola***,

II. Subfam. Alsinoideae

1. Tribe Alsineae

Arenaria, Thylacospermum, ***Moehringia***, Brachystemma, Thurya, Bufonia, Lepyrodiclis, ***Cerastium***, Moenchia, ***Stellaria***,

Pseudostellaria, *Holosteum*, Myosoton, *Minuartia*, Withelmsia,
 Honkenya, *Sagina*, Colobanthus, Alsinidendron, Schiedea,
 Reicheella, Plettkea, Pycnophyllopsis

2. Tribe Pycnophylleae

Pycnophyllum

3. Tribe Geocarpeae

Geocarpon

4. Tribe Habrosieae

Habrosia

5. Tribe Scleranthaeae

Scleranthus, Pentastemonodiscus

III. Subfam. Caryophylloideae

1. Tribe Caryophylleae

Acanthophyllum, Allochrusa, Scleranthopsis, Ochotonophila,
 Diaphanoptera, *Gypsophila*, *Vaccaria*, Pleioneura,
 Cyathophylla, Bolanthus, Ankyropetalum, Phrynella, *Dianthus*,
 Kohlrauschia, *Petrorhagia*, Velezia

2. Tribe Dryideae

Drypis

3. Tribe Sileneae

Silene, Lychnis, Petrocoptis, Cucubalus, *Agrostemma*,
 Uebelinia

If seed characters as discussed in this thesis are given great importance then these tribes would be rearranged into the following grouping, consisting only of these genera studied here.

Polycarpeae would be split in two:

Spergula with *Spergularia* : Seed shape including wings; well-marked spurs, ornamentation.

Polycarpeae with *Polycarpon* and *Loeflingia* : Seed shape; characteristic papillae.

Paronychieae into three:

Paronychia with *Herniaria* : Seed shape; indistinct, smooth cells

Pteranthus : dorsiventrality; dark spot.

Sclerocephalus : Seed shape; well-marked furrow; prominent radicle.

Corrigioleae into two:

Telephium : Seed shape; cell shape; caruncle

Corrigiola with *Scleranthus* (from the *Alsinoideae*): seed shape; cells indistinct; marginal band; dark spot.

Alsineae stays undivided.

Arenaria with *Minuartia*, *Moehringia*, *Cerastium*, *Stellaria*,
Sagina

Caryophylleae into

Dianthus with *Petrorhagia*, *Kohlrauschia*, *Velezia* : Particular dorsiventrality; prominent straight radicle.

Gypsophila with *Vaccaria* : reniform to globular shape

Silenoideae stays undivided

Silene with *Agrostemma* : reniform shape (a few spp globular)

These informal groupings are put forward with some confidence even though many genera were not examined during the course of this work. They do little violence to the Bittrich scheme except for the removal of *Scleranthus* from the Alsinoideae and its placement in the Paronychioideae with *Corrigiola*. The main key character in splitting Paronychioideae from the other two subfamilies is the presence/absence of stipules. Why should stipules be of such importance? Should not seeds be considered a more deep-seated attribute? In any case Davis (1967, p. 245) has "The leaves of *Scleranthus* do, however, have a scarious flange towards the base which may be stipular in nature, and here emphasis is placed rather on the nature of flower and fruit in recognising the Illecebraceae as a separate family."

6.2.6 Seed Shapes and Testa Micromorphology:

Subfamilies and Illecebraceae

The Alsinoideae and Caryophylloideae appear very similar in seed characters in their reniform shapes with symmetrically placed and often sunken hilums. Though it encompasses a diversity of shapes, by contrast the Paronychoideae never has such precisely reniform shapes as defined in this thesis. Similarly, testa cell shape and the types of ornamentation which are such strong features of the first two subfamilies are lacking from most if not all of the Paronychoideae. Therefore it may be claimed that on the totality of seed features there is a distinction between the Alsinoideae and Caryophylloideae on the one hand and the Paronychoideae on the other.

Spergula and *Spergularia*, here recognised as a distinct grouping on seed features, are genera interesting in that they breach the above generalisation in large measure. The delimitation of the testa cells can be very conspicuous and is never unclear. Some species have well marked ornamentations very strongly developed spurs as well as papillae and granules. Furthermore, in overall seed shapes the species of *Spergula* may be thought of as little different from reniform. In addition, in gross morphological attributes such as opposite and decussate leaves and conspicuous corollas, these two genera resemble Alsinoideae.

The concept of Illecebraceae of Bentham and Hooker is followed by Davis (1967) in *Flora of Turkey* where the following genera are included

- | | |
|---|------------------------------|
| 1. Leaves all alternate (spirally arranged) | 3. <i>Corrigiola</i> |
| 1. Leaves essentially opposite (sometimes appearing alternate when one of a pair fails to develop, but never spirally arranged) | |
| 2. Leaves without distinct stipules, though with a scarious margin towards the base | 4. <i>Scleranthus</i> |
| 2. Leaves with distinct scarious stipules | |
| 3. Bracts very conspicuous, exceeding and often concealing the flowers | 2. <i>Paronychia</i> |
| 3. Bracts not very conspicuous, not exceeding the flowers | |
| 4. Annual, erect; leaves reddish, aristate, with a membranous margin | 2. <i>Paronychia</i> |
| 4. Annual or perennial, procumbent to ascending; leaves green, not aristate, without a membranous margin | 3. <i>Herniaria</i> |

These four genera have all been discussed in this thesis as have been *Pteranthus*, *Sclerocephalus* and *Gymnocarpus*, all Libyan genera included in the family by Abdul Ghafoor. As well as the presence of stipules, the members of the Illecebraceae lack a

corolla and have perigynous flowers which develop into one-seeded indehiscent fruits. These seven genera share smooth testa cells and never have papillae or other cellular protuberances. However, they show a considerable diversity of seed shapes. Furthermore, *Illecebrum verticillatum* has elongate seeds distinctly pointed at one end and with a very high gloss see Berggren (1981, Plate 31). These seeds in some features resemble those of some *Polycarpaea* spp. *Herniaria* and *Paronychia* seeds have collar cells but the other five genera do not. Therefore the recognition of Illecebraceae is supported only by the testa features.

Table 6. Seed characteristics of the Subfamily Alsinoideae (genera found in Libya).

Subfamily	Shape	Size mm	Colour	Lateral face	Marginal face	Radicle	Hilum	Testa features					
								Cell shape	Spurs	Papillae	Tubercles	Warts	Surface
<i>Arenaria</i>	circular reniform	< 1	Light or dark brown	Flat or convex	Flat convex or grooved	Curved	Sunken	Oval, elongate or elliptic	Mostly regularly spaced	None	Blunt	With or without	Granular
<i>Cerastium</i>	Broadly cuneate	=	Orange or orange brown	Flat or convex	Convex, mostly grooved	Mostly curved	=	Elongate ovate or stelliform	Regular or irregular	Mostly elongate	Long or short	= = =	Minutely granular
<i>Minuartia</i>	Retortiform	=	Orange	Flat or convex	Convex or concave	Curved	=	Ovate or elongate	Regularly spaced	Varied	Blunt	= =	= =
<i>Sagina</i>	Cuneate reniform	=	Light brown	Convex, concave	Convex grooved	Slightly curved	Near surface	Elongate or circular	= =	= =	= =	None	= =
<i>Stellaria</i>	Circular reniform	=	Dark brown	Slightly convex	Convex	Curved	Sunken	Stelliform or elongate	=	None	Long	Dense	Finely granular

Table 7. Seed characteristics of the subfamily Paronychioideae (genera found in Libya).

Subfamily	Shape	size mm	Colour	Lateral face	Marginal face	Radicle	Hilum	Testa features								
								Cell shape	Spurs	Papillae	Tubercles	Warts	Surface			
Paronychioideae																
<i>Herniaria</i>	Mostly circular	< 1	Brown	Convex	Keeled	Slightly curved	Near surface	Indistinct	None	None	None	None	None	None	Smooth, glossy	
<i>Gymnocarpos</i>	Obovate	1-2	=	Flat	Convex	Curved	=	=	=	=	=	=	=	=	Smooth	
<i>Paronychia</i>	Circular elliptic	1-2	=	Convex	Mostly keeled	Curved	=	=	=	=	=	=	=	=	Smooth	
<i>Loeflingia</i>	Elongate	< 1	white gray	=	Convex	Slightly curved	=	Faint	irregular	=	=	=	=	=	Smooth	
<i>Polycarpaea</i>	Mostly elongate	< 1	Creamy	=	=	=	=	Indistinct	None	With or without	=	=	=	=	Smooth or granular	

Table 9. Seed characteristics of the subfamily Caryophylloideae (genera found in Libya).

Subfamily	Shape	Size	Colour	Lateral face	Marginal face	Radicle	Hilum	Testa features								
								Cell shape	Spurs	Papillae	Tubercles	Warts	Surface			
Caryo- phylloideae		mm														
<i>Agrostemma</i>	Reniform	1-2	Dark brown	Mostly flat	Broad, flat	Equaling cotyledons	Sunken	Mostly elongate	Regular spaced	High	Long	None	None	Granular		
<i>Dianthus</i>	Broadly Elliptic	> 2	Black	Flat	Strongly compressed	Straight	Near surface	Elongate or ovate	=	None	None	None	=			
<i>Gypsophila</i>	Circular reniform	1-2	Brown	Slightly concave	Mostly convex	Curved	Sunken	Elliptic or ovate	=	Blunt or pointed	Long	=	=			
<i>Petrorrhagia</i>	Broad elliptic	1-2	Black	Flat or convex	Strongly compressed	Straight	Near surface	Elongate or stelliform	=	Blunt or pointed	None	=	Minutely granular			
<i>Silene</i>	Mostly reniform	1-2	Brown or gray	Varied	Varied	Equaling cotyledons	Sunken	Varied	=	=	Blunt or pointed	With or without	Smooth or granular			
<i>Vaccaria</i>	Globular	1-2	Black	Convex	Convex	Indistinct	Near	Broad elliptic	Regular	Blunt	Blunt	None	Fine granular			

6.3 Chapter 4.

According to the results obtained in the present study some fundamental points concerning the infrageneric groupings in *Arenaria*, *Moehringia*, and *Minuartia* can be clarified. The different characteristic morphologies of the crystals of about 160 taxa within these three genera have been thoroughly described in Chapter 4, section 3. It was concluded that shape, size and distribution of the crystals were taxonomically significant at the subgeneric level. These can be summarised briefly, always with the proviso that not all species in these large genera were examined.

1. According to these studies of the crystals, the great majority of the groupings of McNeill can be supported.
2. Subgenera of *Arenaria* (*Dolophragma* and *Solitaria*) are distinct from all the other subgenera of that genus and also from all members of *Moehringia* and of *Minuartia* of whatever subgenera by the absence or great scarcity of crystals.
3. All members of *Moehringia* show great similarities with the genus *Arenaria*, except the subgenus *Eremogone* of *Arenaria*, and also display great similarities with *Minuartia*, except subgenus *Minuartia* but within that subgenus the section *Spectabiles* does resemble *Moehringia*. In *Moehringia* all the crystals are druses; no sand has been encountered.
4. The subgenus *Eremogone* of *Arenaria* has characteristic

distributions of crystals which makes it very distinct from every other subgenus of *Arenaria*. Its crystals are arranged mostly irregularly but sometimes regularly in short rows in both the intercostal areas and in the veins (in the 27 spp. examined) or in the veins only (in two spp). By contrast all other members of *Arenaria* of whatever subgenus (44 spp) have the crystals only in the intercostal areas and never in the veins. *Eremogone* is the sole subgenus to have crystal sand; the other subgenera have druses only.

5. The subgenus *Eremogone* of *Arenaria* greatly resembles subgenus *Minuartia* of *Minuartia* in the distribution of crystals in that the crystals are present in both the intercostal areas and in the veins. However in subgenus *Minuartia* the costal crystals are mostly continuous in the cells whereas in subgenus *Eremogone* the costal crystals are discontinuous.

6. Druses and sand both occur in *Minuartia* except subgenera *Rhodalsine* and *Hymenella* which only have druses. subgenus *Spergella* with only two species has druses only in one (*M. formosa*) but druses, sand and elongate crystals in the other (*M. picta*). All sections in subgenus *Minuartia* have sand and druses except section *Spectabiles* with only druses. Series *Laricifoliae* of section *Spectabiles*, has both druses and sand.

7. Giant crystals up to 233 μm long are found in most sections of subgenus *Minuartia* of *Minuartia* and in no other members of

Minuartia, *Arenaria* or *Moehringia*. In subgenus *Eremogone* of *Arenaria* there are large crystals but they never reach 100 μm long. These giant crystals appear not to have been reported elsewhere.

8. By the application of this easy, swift technique for crystal examination, these features of the crystal morphology and distribution can be used in assigning sterile plants of these genera to a genus. A specimen thought to belong to subgenus *Minuartia* of *Minuartia* could have its identity confirmed by the crystals except if it were of section *Spectabiles*. Similarly a specimen thought to be of subgenus *Eremogone* of *Arenaria* could have its identity confirmed although there is the possibility that the specimen might be of subgenus *Minuartia* happening to have some discontinuity of the crystals.

6.4 Chapter 5.

The results from light microscopy and SEM of the capsular micromorphology seem very promising for the large, complex genus *Silene* and should be taken much further by comparing with the sectional divisions of past authors. The results from the other genera seem also to be valuable but again there is a need for more detailed investigations.

6.5 Some General Concluding Points:

Within the Libyan Caryophyllaceae there are the endemic species of *Silene* (3 spp.), *Petrorhagia* (1 sp.), and *Herniaria* (1 sp.). The seeds of most of these taxa have been examined from admittedly a small sample of specimens in all cases but nevertheless the seed micromorphology bears on the validity of these special taxa. The number of examined specimens needs to be increased for greater thoroughness and the gathering of new material from the field would be desirable. Such fresh collecting would be best carried out in northernmost Cyrenaica. This would then allow a complete taxonomic reassessment not just from seed characters but from many morphological and other appropriate aspects.

The survey of Caryophyllaceous seeds from Libya and of some non-Libyan species deals only with a small proportion of the seeds of all the many species in the family. All the large genera of the family are represented in the survey and many of the smaller genera as well. Therefore the survey gives a very good idea of the scope of seed macro- and micromorphology.

The range of seed characters as discussed in this thesis and by many previous workers shows that such features can be helpful at the specific and infraspecific levels. At the tribal and subfamilial levels seed characters are also helpful and may be more helpful than has hitherto been fully realised. It, however appears that at the generic level seed characters are less useful,

though not totally without importance. Seeds are therefore, of little use in resolving the problems of generic delimitation, a well-known difficulty in the family as pointed out by Davis (1967) and by Bittrich (1993, p. 207) who stated "Many genera in the family are ill-defined and difficult to distinguish".

It would be a finite task to complete the survey of all the genera, many of which are of only one or of few species. After that the subfamilial and tribal divisions could be revised with complete confidence to take full advantage of the very considerable value of seed characters. Then formal proposals could be made. Similarly the extension of the studies of crystals and of the fruit epidermis to cover all the family may be considered as well worthwhile.

It is highly desirable that a phylogenetic analysis of the family with the application of the most up-to-date methods be carried out. Such an analysis should use the very detailed seed, fruit and crystal characters as described in this thesis.

REFERENCES

- Abdul Ghafoor** (1977). Illecebraceae. Volume 37 of *Flora of Libya*.
Jafri, S. M. H. and Elgadi, A. (editors). Alfaateh University Faculty of Science, Department of Botany. Tripoli. 35 pages.
- ____ (1978). Family Caryophyllaceae. Volume 59 of *Flora of Libya*. Jafri, S. M. H. and Elgadi, A. (editors). Alfaateh University Faculty of Science, Department of Botany, Tripoli. 122 pages.
- Aeschimann, D.** (1985). Etude biosystematique du *Silene* s. l. (Caryophyllaceae) dans le domaine alpin. Essai d'interpretation evolutif et propositions taxonomiques. *Candollea* 40: 67-98.
- Afdelningen, A.** (1897). *Angiospermae Dicotyledones. Caryophyllaceae*. Acta Universitatis Lundensis. 123 pages.
- Al-Rais, A. H., Myers, A. and Watson, L.** (1971). The isolation and properties of oxalate crystals from plants. *Annals of Botany*. 35: 1213-1218.
- Amar, M.** (1904). L'oxalate de calcium dans la nutrition des vegetaux. *Annales des sciences naturelles huitieme serie Botanique* XIX: 204-279.
- Arnott, H. J.** (1980). An SEM study of crystal idioblasts in pecan leaves. *Scanning Electron Microscopy* III: 563-569.
- ____ (1981). An SEM study of twinning in calcium oxalate crystals of plants. *Scanning Electron Microscopy* III: 225-234.
- Ball, P. W. and Heywood, V. H.** (1962). The taxonomic separation of the cytological races of *Kohlruschia prolifera* (L.) Kunth *sensu lato*. *Watsonia* 5: 113-116.
- Ball, P.W. and Heywood** (1964). A revision of the genus *Petrohragia*. *Bulletin of the British Museum (Natural History) Botany*. 3: 119 -173.

- Barthlot, W.** (1981). Epidermal and seed surface characters of plants: systematic applicability and some evolutionary aspects. *Nordic Journal of Botany*. 1:345-355.
- Beijerinck, W.** (1947). *Zadenatlas Der Nederlandsche Flora*. H. veen man & Zonen Wageningen. 316 pages.
- Behnke, H. D.** (1994). Sieve Element Plastids : Their Significance for the Evolution and Systematics of the Order. pages 87-121. In Behnke, H. D. and Mabry, T. J. *Caryophyllales Evolution and Systematics*. Springer-Verlag, Berlin. 334 pages.
- Bentham, G. and Hooker, J. D.** (1862-1867) *Genera Plantarum*. Volume Primum 141-15. London. 1040 pages.
- Berggren, G.** (1981) *Atlas of seeds and small fruits of Northwest-European plant species (Sweden, Norway, Denmark, East Fennoscandia and Iceland) with morphological descriptions Part 3 Caryophyllaceae*. Swedish Museum of Natural History, Stockholm. 261 pages.
- Bertsch, K.** (1941). *Handbuecher der praktischen vorgeschichtsforschung Fruchte und Samen*. Ferdinand Enke, Stuttgart. 247 pages.
- Bittrich, V.** (1993). Caryophyllaceae. pages 206-236 in Kubitzki, K., Rohwer, J. and Bittrich, V. (editors). *The Families and Genera of Vascular Plants*. Volume II. *Flowering Plants Dicotyledons*. Springer-Verlag, Berlin. 653 pages.
- Bock, C.** (1980). Contribution to the taxonomy of *Silene acaulis* (L.) Jacq. seeds and germination. *Candollea* 35: 541-564.
- Bohn, P. R. and Guignard, M.** (1925). Sur la presence de cristaux d'oxalate de calcium a la surface de certaines Carophyllyacees. *Comptes Rendus Hebdomadaires des Seances de L'academie des Sciences*. pages 135-137.

- Boisser, E.** (1867). *Flora Orientalis*, vol. 1. H. Georg , Basle.1017 pages.
- Bokhari, M.** (1970). Morphology and taxonomic significance of foliar sclereids in *Limonium*. *Notes from the Royal Botanic Garden Edinburgh* **30**: 43-53.
- Boulos, L.** (1979). A check-list of the Libyan flora 2. Salicaceae to Neuradaceae. *Candollea* **34**: 21-34.
- Buttrose, M. S. and Lott, J. N. A.** (1978). Calcium oxalate druse crystals and other inclusions in seed protein bodies: *Eucalyptus* and *jojoba*. *Canadian Journal of Botany* **17**: 2083-2091.
- Candolle, A. P.** (1828). *Prodromus Systematis Naturalis Regni Vegetabilis. Pars III.* Paris. 494 pages.
- Castroviejo, S. et al.** (1990). *Flora Iberica Plantas Vasculares de la Peninsula Iberica e Islas Baleares.* Real Jardin Botanico Madrid. 897 pages.
- Celebioglu, T., Favarger, C. and Huynh K. L.** (1983). Contribution a la micromorphologie de la testa des graines du genre *Minuartia* (Caryophyllaceae) I. Sect. *Minuartia*. *Bulletin Museum National d'Histoire Naturelle, Paris*, **5**: 415-435.
- ___ (1989). Two new species of Caryophyllaceae of Turkey. *Candollea* **44**:329-336.
- Celebioglu, T., Favarger, C. and Montserrat, J.** (1990). Systematic position and relationships of *Minuartia valentina* (Pau) Mater & Figuerola, endemic of Spain. *Collectanea Botanica (Barcelona)* **18**: 75-85.
- Chowdhuri, P. K.** (1957). Studies in the genus *Silene*. *Notes from the Royal Botanic Garden Edinburgh.* pages 221-278 .
- Chuang, T. and Hekard, L. R.** (1972). Seed coat morphology in *Cordylanthus* (Scrophulariaceae) and its taxonomic

- significance. *American Journal of Botany* **59**: 258-265
- Clapham, A. R., Tutin T. G. and Warburg E. F.** (1952). *Flora of the British Isles*. Cambridge, University Press. 1591 pages.
- Corti, R.** (1942). *Flora e vegetazione del Fezzano della regione di Gat.* Tipografia Mariano Ricci, Firenze. 250 pages.
- Cronquist A.** (1981) *An integrated system of classification of Flowering Plants*. Columbia University Press. 262 pages.
- Crow, E.** (1979). The systematic significance of seed morphology in *Sagina* (Caryophyllaceae) under Scanning Electron Microscopy. *Brittonia* **31**: 52-63.
- Cutter, E. G.** (1978). *Plant Anatomy*. London Edward Arnold. 300 pages.
- Davis, P.** (1967). *Flora of Turkey and the East Aegean Islands, Volume.2* Edinburgh University Press. 581 pages.
- Dormer, K. J.** (1961). The crystals in the ovaries of certain Compositae. *Annals of Botany*. **25**: 241-255.
- ____ (1962). The taxonomic significance of crystal forms in *Centaurea*. *New Phytologist*. **61**: 32-35.
- Durand, E. and Barratte, G.** (1910). *Flora Libiicae prodromus, ou catalogue raisonne des plants de Tripolitaine*. Geneve. 313 pages.
- Dvorakova, M.** (1985). *Minuartia glaucina*, a new species of the *Minuartia verna* group. *Preslia*, **57**: 1-8.
- ____ (1988). *Minuartia smejkalii*, a new species of the *Minuartia geradii* group (Caryophyllaceae). *Preslia* **60**: 1-9.
- ____ (1991). Some information on the taxonomy and chorology of *Minuartia orthophylla* (Caryophyllaceae). *Preslia* **63**: 1-7.
- Eames, A. J. and MacDaniels, L. H.** (1947). *An Introduction to Plant Anatomy*. McGraw Hill, New York. 427 pages.
- Echlin, P.** (1968) The use of the scanning reflection electron microscope

in the study of plant and microbial material. *Journal of the Royal Microscopical Society* **88**:407-418.

Endlicher, S.L. (1839). *Genera Plantarum*. Vienna, 1483 pages.

Engler A. (1964) *Syllabus Der Pflanzen familien* Volume.2, Gebruder Borntraeger, Berlin-Nikolassee. 666 pages.

Esau, K. (1977). *Anatomy of seed plants*. John Wiley, New York. 550 pages.

Fahn, A. (1972). *Plant anatomy*. Pergamon Press, Oxford. New York. 544 pages.

Favarger C. and Nieto Feliner, G. (1988). On the races of *Arenaria tetraquetra* L. (Caryophyllaceae) *Botanical Journal of the Linnean Society*, **97**: 1-8.

Franceschi, V. R. and Horner, Jr. H. T. (1980). Calcium oxalate crystals in plants. *Botanical Review* **46**: 361-427.

Gay, J. (1845). *Holostei Caryophyllearum Alsinarum generis*, monographia. *Annles des Sciences Naturelles* **4**: 23-44.

Genua, J. M. and Hillson, C. J. (1985). The occurrence, type and location of calcium oxalate crystals in the leaves of fourteen species of Araceae. *Annals of Botany* **56**: 351-361.

Gilbert, M. G. (1987). The taxonomic position of the genera *Telephium* and *Corrigiola*. *Taxon* **36**: 47-49.

Godeau, M. M. (1973). Etude au microscope electronique a balayage des teguments seminaux des *Arenaria armoricains* du groupe *serpyllifolia* L. *Compte rendu hebdomadaive des seances de l'Academie des Sciences*. **276D**: 537-540.

Greene, S. W. (1970) Studies in *Colobanthus quitensis* (Kunth) Bartl. and *Deschampsia antactica* Desv. *British Antarctic Survey Scientific Reports* **23**:42-52.

- Greuter W.** (1984). *Med-Checklist. A critical inventory of vascular plants of the Circum-mediterranean countries*. Secretariat Med-checklist Botanisches Museum Berlin-Dahlem. 330 pages.
- ____ (1995). *Silene* (Caryophyllaceae) in Greece: a subgeneric and sectional classification. *Taxon* **44**: 543-581.
- Guardia, C. D., Mota, J. F. and Valle, F.** (1991). A new taxon in the genus *Moehringia* (Caryophyllaceae). *Plant Systematics and Evolution* **177**: 27-38.
- Guinochet, M., Vilmorin, R. and Mangenot, G.** (1973). *Flore de France*. Doin, Editeurs 8, Place de l'Odeon Paris. 366 pages.
- Haberlandt, G.** (1914). *Physiological Plant Anatomy*. Macmillan and co., London. 777 pages.
- Heywood, V. H.** (1969) Scanning electron microscopy in the study of plant materials *Micron* **1**:1-13.
- ____ (1978) *Flowering plants of the World*. BT Batsford Ltd. Second edition, 335 pages.
- Hickman, J. C.** (1971). *Arenaria*, Section *Eremogone* (Caryophyllaceae) in the Pacific Northwest a key and discussion. *Madrono* **21**: 201-207.
- Hind, D. J. N.** (1988). *The biology and systematics of Moehringia L. (Caryophyllaceae)*. Ph. D. thesis, University of Reading. 409 pages.
- Hofmann, U.** (1994). Flower morphology and ontogeny. Pages 123-166 in Behnke, H. D, and Mabry, T. J. (1994). *Caryophyllales Evolution and Systematics*. Springer-Verlag, Berlin. 334 pages.
- Holmen, K.** (1957). The vascular plants of Peary Land, North Greenland. A list of the species found, between Victoria Fjord and Danmark. *Meddelelser om Grondland* **9**: 42-52.
- Hosny, A. I.** (1984). *Taxonomic revision of the species of*

Caryophyllaceae in Egypt. subfamilies Paronychioideae and Alsinoideae. Ph. D. thesis, University of Cairo. 182 pages

- Horner, H. T., Jr.** (1977). A comparative light- and electron-microscopic study of microsporogenesis in male-fertile and cytoplasmic male-sterile Sunflower (*Helianthus annuus*). *American Journal of Botany* **64**: 745-759.
- Horner, H. T., Jr. and Franceschi, V. R.** (1978). Calcium oxalate crystals formation in air spaces of the stem of *Myriophyllum*. *Scanning Electron Microscopy Symposium II*: 69-76.
- Horner, H. T., Jr. and Wagner, B. L.** (1980). The association of druse crystals with the developing stomium of *Capsicum annuum* (Solanaceae) anthers. *American Journal of Botany* **67**: 1347-1360.
- Jahandiez, E. and Maire, R.** (1932). *Catalogue des plantes du Maroc (Spermatophytes of Pteridophytes)*. 557 pages.
- _____ (1934). *Catalogue des Plantes du Maroc (Spermatophytes of Pteridophytes)*. 913 pages,
- Jalas and Suominen, J.** (1983). *Atlas Floras Europaeae distribution of vascular plants in Europe*. Committee for Mapping the Flora of Europe Helsinki. 176 pages.
- Jarman, C. G. and Kibby, R. H.** (1955). The differentiation of Jute and some Jute substitute fibres based in the type of crystals. *Colonial Plant and Animal Products* **1**: 281-287.
- Jussieu, A. L. de** (1789). *Genera plantarum secundum ordines naturales disposita juxta methodum in horto regio parisiensi exaratum*. Paris. 498 pages.
- Kausch, A. P. and Horner, H.** (1983). The development of mucilaginous raphide crystals idioblasts in young leaves of *Typha angustifolia* L. (Typhaceae). *American Journal of Botany* **70**:

691-705.

- Keith, H. G.** (1965) *Preliminary check list of Libyan Flora*, Caryophyllaceae Volume 2., Colonial Forest Service 1047 pages.
- Komarov, V. L.** (1936). *Flora of the U.S.S.R.* Volume VI Centrospermae. Botanical Institute of Academy of Sciences U. S. S. R. Translated 1970, Jerusalem. 731 pages.
- Koteshwar Rao, K. and Ramayya, N.** (1984). Structure and distribution of calcium oxalate crystals in the stem wood of *Ficus* L., in relation to taxonomy. *Indian Journal of Forestry* 7: 25-30.
- Kowal, T.** (1966). Systematic studies on the genera *Delia* Dum., *Spergula* L. and *Spergularia* Presl. *Monographiae Botanicae*. XXI: 245-
- Kowal, T. and Wojterska, H.** (1966). Systematic studies on the seeds of the genus *Dianthus* L. *Monographiae Botanicae* XXI: 271-297.
- Laing, R. and E. W. Blackwell** (1927). *Plants of New Zealand*; Christchurch, Wellington, and Dunedin, N. Z. ; Melbourne and London: Whitcombe and Tombs Limited. 468 pages.
- Laurence, T. E.** (1976). Morphology, fine structure and ontogeny of the stinging emergence of *Tragia ramosa* and *T. saxicola* (Euphorbiaceae). *American Journal of Botany* 63: 710-718.
- Leeuwenhoek, A. Von** (1675). *Microscopical observations*; in *Philosophical Transactions of the Royal Society of London*. 380-385 pages.
- Lindberg, H.** (1932). *Itinera mediterranea. Acta Societatis Scientiarum Fennicae* B, 1: 3-178
- Linnaeus, C.** (1737) *Genera plantarum*, Lugduni batavorum (Apud Conradum Wishoff).
- ____ (1753) *Species Plantarum*. A facsimile of the first edition, vol. 1 London, The Ray Society (1957). 560 pages.

- ____ (1767) *Genera Plantarum*, editio novissima. Wien.
- Loscós, D. F.** (1876). *Tratado de Plantas de Aragon*. Edición del Scemanario farmaceutico, Madrid. 628 pages.
- Luerssen, C.** (1882). *Handbuch der Systematischen Botanik* Part II. Verlag Von H. Haessel, Leipzig. 1229 pages.
- Mabberley, D. J.** (1987) *The plant-book a portable dictionary of the higher plants*. Cambridge University Press. 706 pages.
- Maguire, R.** (1951). Studies in the Caryophyllaceae. V. *Arenaria* in North *Arenaria* north of Mexico. A conspectus. *American Midland Naturalist* **46**: 493-511.
- Maire, R.** (1963). *Flore de L Afrique du Nord*, Vol. 9 Dicotyledonae. Centrospermales (Caryophyllaceae) Subfamily Alsinoideae. 300 pages.
- ____ (1963). *Flore de L Afrique du Nord*, Vol. 10 Dicotyledonae. Centrospermales (Caryophyllaceae) subfamily Silenoideae. Pierre Quezel, Paris. 336 pages.
- Marsden-Jones, E. M. and Turrill, W. B.** (1957). *The bladder champions (Silene maritima and S. vulgaris)*. London, The Ray Society. 374 pages.
- Mattfeld, J.** (1921). Enumeratio specierum generis *Minuartia* (L.) emend. Hiern. *Botanische Jahrbucher* **126**: 27-63.
- ____ (1922). Beitrag zur kenntnis der systematischen gliederung und geographischen verbreitung der gattung *Minuartia*. *Botanische Jahrbucher* **128**: 57-63.
- McNair, J. B.** (1932). The interrelation between substances in plants: essential oils and resins, cyanogen and oxalate. *American Journal of Botany* **19**: 255-271.
- McNeil, J.** (1962). Taxonomic Studies in the Alsinoideae: I. generic and

infra-generic groups Vol. 1, 2 *Notes from the Royal Botanic Garden Edinburgh* **24**: 79-155

- ____ (1963). Taxonomic studies in the Alsinoideae II. A revision of the species in the orient. *Notes from the Royal Botanic Garden Edinburgh* **24**: 241-426.
- McNeil, J. and Bassett, I. J.** (1974). Pollen morphology and the infrageneric classification of *Minuartia* (Caryophyllaceae). *Canadian Journal of Botany* **52**: 1225-1231.
- Meikle, R. D.** (1977). *Flora of Cyprus*. The Bentham-Moxon Trust, Royal Botanic Gardens, Kew. 832 pages.
- Melzheimer, V.** (1977). Biosystematische Revision einiger *Silene* Arten (Caryophyllaceae) der Balkanhalbinsel (Griechenland). *Botanische Jahrbucher* **98**: 1-92.
- ____ (1980). Revision einiger balkanischer Arten von *Silene* sect. *Inflatae* (Caryophyllaceae). *Botanische Jahrbuecher* **101**: 153-190.
- Metcalf, C. and Chalk L.** (1950). *Anatomy of the Dicotyledons*, Volume. 1, Oxford Clarendon Press. 724 pages.
- Monnier, P.** (1968) Synopsis du genre *Spergularia* (Pers.) Presl au Maroc. *Naturalia monspeliensia series Botanique* **19**: 86-113.
- ____ (1975). Systematique et biosystematique du genre *Spergularia* dans le bassin mediterraneen occidental (essai de taminomic synthetique) III.I. Serie du *Spergularia marginata* (DC.) kittel (=groupe Pterospermae). *Candollea* **30**: 121-155.
- Monserrat, P.** (1981). *Arenaria leptoclados* subsp. *minutiflora* (Loscos) *Anales Jardin Botanico Madrid*. **37**: 625.
- Morton, J. K.** (1972). On the occurence of *Stellaria pallida* in North America. *Bulletin of the Torrey Botanical Club* **99**:95-103.
- Murata, G. and Umemoto, K.** (1983). Critical notes on the Asiatic

- Agrimonia* with special reference to the distribution patterns of oxalate crystals. *Acta Phytotaxonomica et Geobotanica* **XXXIV**: 4-6
- New, J. K.** (1958). A Population Study of *Spergula arvensis*. I. Two clines and their Significance. *Annals of Botany* **22**: 257-477.
- ____ (1959). A Population Study of *Spergula arvensis*. II. Genetics and Breeding Behaviour. *Annals of Botany* **23**: 23-33.
- ____ (1961). Biological Flora of the British Isles, *Spergula arvensis* L. *Journal of Ecology* **49**: 205-215.
- Novosel, K. J.** (1982). *Floral morphology in relation to adaptation and taxonomy in the Caryophyllaceae*. Ph. D. thesis, University of Edinburgh. 329 pages.
- Oliver, D.** (1868). *Flora of Tropical Africa*. L. Reeve and co., 5, Henrietta street, Covent London. Volume I. 479 pages.
- Oxelman, B.** (1995). A revision of the *Silene sedoides*-group (Caryophyllaceae). *Willdenowia* **25**: 143-169.
- Ozenda, P.** (1977). *Flora du Sahara*. 2nd. Paris Centre National de la Recherche, Scientifique. 622 pages.
- Pampanini, R.** (1931). *Prodromo della flora Cirenaica, Caryophyllaceae* 191-201. Flori Tipografia Valbonesi. 665 pages.
- Patricia, K. and Keuken, W.** (1981). *Index Herbariorum. Part I The Herbaria of the world*. Seventh edition. 452 pages.
- Payne, W.** (1970). Helicocytic and Allelocytic stomata unrecognized pattern in the Dicotyledonae. *American journal of Botany* **57**: 140-147.
- Pax, F.** (1894). Caryophyllaceae. Pages 61-94 in *Die naturlichen Pflanzenfamilien* III. Teil Ib. Leipzig, Verlag von Wilhelm Englemann.
- Pax, F. and Hoffman** (1934). Caryophyllaceae. pages 275-364 in *Die naturlichen Pflanzenfamilien Band 16 c*. Leipzig, Verlag von

Wilelm Engelmann.

- Perring, F. H. and Sell, P. D.** (1967). Taxonomic and nomenclature notes on the British Flora (*Arenaria serpyllifolia*), *Watsonia* **6**: 294.
- Pignatti, S.** (1982). *Flora D'Italia*, Edagricole, Via Emilia Levante, 31-Bologna. Volume I. 789 pages.
- Post, G. E.** (1883). *Flora of Syria, Palaestine, from the Taurus to Ras Muhammed, and from the Mediterranean sea to the Syrian Desert*. Syrian Protestant College, Beirut, Syria. 919 pages.
- Pottier-Alapetite, G.** (1979). *Flore de la Tunisie Angiospermes-Dicotyledones Apetales-dialypetales*. Ministere de l'Enseignement Superieur Et Oe La Recherche Scientifique et le Ministere de L'Agriculture, Tunis. 230 pages.
- Price, J. L.** (1970). Ultrastructure of druse crystal idioblasts in leaves of *Ceridium floridum*.. *American Journal of Botany* **57 (8)**: 1004-1009.
- Quezel, P. and Santa, S.** (1962). *Nouvelle flore de l'Algerie et des regions desertiques meridionales*. 558 pages.
- Rabeler, R.** (1993). Infrageneric nomenclature: corrections and additions in the Caryophyllaceae. Contributions from the *University of Michigan Herbarium* **19**: 149-164.
- Rechinger, K. H., Melzheimer, V., Mosch, W. and Schimau-Czeika, H.** (1988) *Flora Iranica. Caryophyllaceae* II. Akademische Druck und Verlagsanstalt, Graz, Austria. 528 pages.
- Regel, E.** (1882). Aufzaehlung der von Radde in Baikalien, Dahurien und am Amur. . . gesammelten Pflanzen. 1 (2) Dicotyledoneae, Polypetale. *Bulletin de la Societe des naturalistes de Moscou*. **35**: 214-328.
- Rohrbach** (1868). Monographie der gattung *Silene*. Verlag Von wilheim

Ross-Craig, S. (1951). *Drawings of British Plants, Part V Caryophyllaceae*.
London: G. Bell & Sons.

Scott, F. M. (1941). Distribution of calcium oxalate crystals in *Ricinus communis* in relation to tissue differentiation and presence of ergastic substances. *Botanical Gazette* **103**: 225-246.

Scurfield, G. and Michell, A. J. (1973). Crystals in woody stems. *Botanical Journal of Linnean Society*. **66**:277-289.

Sourkova, M. (1973). Caryophyllaceae subfam. Dianthoideae-
Begrenzung, Charakteristik und Gliederung. *Preslia* **50** : 139-152.

Stace, C. (1989) *Plant Taxonomy and Biosystematics*. 2nd edition
London, Edward. 264 pages.

____ (1991) *New Flora of the British Isles*. Cambridge University Press.
1226 pages.

Stearn, W. T. (1983). *Botanical Latin*. Newton Abbot: Davis & Charles.
Third edition, 566 pages.

____ (1993). *Botanical Latin*. Davis & Charles. Fourth edition, 546 pages.

Steinbrinck, C. (1891). Über die anatomisch-Physikallische Ursache der
hygroskopischen Bewegungen Pflanzlicher organe. *Flora* **74**: 193-
219.

Sterk, A. A. and Dukhuizen, L. (1972). The relation between the
genetic determination and the ecological significance of the seed
wing in *Spergularia media* and *S. marina*. *Acta Botanica
Neerlandica* **21** (5): 481-490.

Tackholm, V. (1974). *Student's Flora of Egypt*. ed. Second edition. Cairo
University, Beirut. 473 pages.

Thomas, S. M. (1980). *Population studies and delimitation of species in
the genus Petrorhagia, (Section Kohlrauschia)*. Ph. D. thesis,

Westfield College, London. 279 pages.

Thorne, R. F. (1983) Proposed new realignments in the angiosperms.
Nordic Journal of Botany 3:85-117.

Thurston, E. L. (1976). Morphology, fine structure and ontogeny of the stinging emergence of *Tragia ramosa* and *T. saxicola* (Euphorbiaceae). *American Journal of Botany* 63:710-718.

Tutin, T. G., Heywood, V. H., Burges, N. A., Valentine, D. H., Walters, S. M. and Webb, D. A. (1964). *Flora Europaea*. Volume 1 Lycopodiaceae to Platanaceae, Cambridge University Press. 464 pages.

Tutin, T. G., Burges, N. A., Chater, A. O., Edmondson, J. R., Heywood, V. H., Moore, D. M., Valentine, D. H., Walters, S. M. and Webb, D. A. (1993) *Flora Europaea* . ed. 2, volume.1 Psilotaceae to Platanaceae Cambridge, University Press 581 pages.

Umemoto, K. (1981). The leaf form and the pattern of calcium oxalate crystals in *Camellia sasanqua x sinensis*. *Acta Phytotaxonomica et Geobotanica* XXXII: 133-137.

Voliotis, D. (1991). *Silene bupleuroides* L. ssp. *ganiatsasiana* (Caryophyllaceae), a new champion in the Greek flora. *Israel Journal of Botany* 40: 225-236.

Whitehead, F. H. and Sinha, R. P. (1967). Taxonomy and Taximetrics of *Stellaria media* (L.) Vill., *S. neglecta* Weihe and *S. pallida* (Dumort.) Pire. *New Phytologist* 66:769-784.

Williams, F. N. (1898). Note monographique sur le genre *Rhodalsine* Gay. *Bulletin de L'Herbier Boissier*. 6: 1-10.

____ (1906). The genus *Telephiun*. *Journal of Botany*. 44: 289-304.

- Willis, M.** (1904). *A Manual and Dictionary of the Flowering Plants and Ferns*. Second edition, Cambridge University Press. 670 pages.
- ____ (1966). *A Dictionary of the Flowering Plants and Ferns*. Seventh edition, Cambridge University Press. 1214 pages.
- ____ (1973). *A Dictionary of the Flowering Plants and Ferns*. Eighth edition, Cambridge University Press.
- Wofford, B. E.** (1981) External seed Morphology of *Arenaria* (Caryophyllaceae) of the Southeastern United states. *Systematic Botany* **6 (2)** : 126-135.
- Wojterska, H.** (1969). Systematic studies on morphology and anatomy of seeds and fruits of Polish species of the genus *Cerastium* L. *Poznanskie Towarzystwo Przyjaciol Nauk-Komisja Biologiczna. Prace* **32**: 1-32.
- Wolter, M.** (1990). Calcium oxalat-kristalle in den Knollen-Hullen von *Crocus* L.(Iridaceae) und ihre systematische Bedeutung. *Botanische Jahrbucher*. **112**: 99-114.
- Zohary, M.** (1966). *Flora Palaestina. Part One Text, Equisetaceae to Moringaceae*. The Israel Academy of Sciences and Humanities. 363 pages.

Appendix I. List of Taxa with Authorities.

Agrostemma L.

githago L.

Arenaria L.

acerosa Boiss.

acutisepala Williams

angustisepala McNeill

armerina Bory

biflora Griseb.

bryoides Schlecht.

cerastoides Poir.

ciliata L.

conferta Boiss.

davisii McNeill

deflexa Decaisne

dianthoides J. E. Smith

fendleri A. Gray

filicaulis Fenzl

forrestii Diels

gouffeia Chaub.

grandiflora L.

guatemalensis Standley & Steyerm.

gypsophiloides L.

hispanica Sreng.

hookeri Torr. & Gray

huteri Kern.

insignis Litiv.

kingii (S. Wats.) M. E. Jones

ledebouriana Fenzl

lithops Heywood

lychnidea Schlecht.

macradenia S. Wats.

napuligera Franch.

oresbia W. W. Sm.

aculeata S. Wats.

alsinoides Schlecht.

armeniaca Boiss.

bertolonii Fiori & Paol.

boliviana Williams

capillaris Poir.

ciliaris Loscos

ciliolata Edgew.

cucubaloides J. E. Smith

decussata Eilld. ex Schlecht.

densissima Edgew.

drypidea Boiss.

festucoides Benth.

formosa Ser.

frankinii Dougl. ex Hooker

graminea C. A. Mey.

griffithii Boiss.

guicciardii Heldr.

halacsyi Bald.

holostea M. Bieb.

humifusa (Swartz) Wahlb.

incrassata Lange

kansuensis Maxim.

lanuginosa (Michx.) Rohrb.

leptoclados Guss.

loscosii Texid.

lycopodioides Schlecht

montana L.

oreophila Hook.

paludicola Robinson

Arenaria L.

palustris Naud.
polycnemifolia Boiss.
pseudacantholimon Bornm.
punges Clem.
pseudacantholimon Bornm.
pycnophylla Rohrb.
retusa Boiss.
sabulina Fenzl
scariosa Boiss.
steveinana Boiss.
teddii Turrill
tetrasticha Boiss.
yunnanensis Franch.

Cerastium L.

comatum Desv.
glomeratum Thuill
pumilum Curtis
siculum Guss.

Corrigiola L.

littoralis L.

Dianthus L.

crinitus Sm.

Gymnocarpus Forsk.

decander Forsk.

Gypsophila L.

elegans Bieb.

Herniaria L.

cinera DC.

ericifolia Townsend

glabra L.

Loeflingia L.

hispanica L.

Lychnis L.

flos-cuculi L.

persica Boiss.
polytrichoides Edgew.
pulvinata Huter
purpurascens DC.
pseudofrigida Shischk.
reptans Hemsl.
rhodia Boiss.
saponarioides Boiss. & Bal.
serpyllifolia L.
szowitsii Boiss.
tetraquetra L.
trichophora Franch.
zargariana Pasa

dichotomum L.

ligusticum Viv.

semidecandrum L.

pilosa Hudson

cyrenaica F. Hermann

fontanesii Gay

hemistemon Gay

Minuartia L.

- acuminata* Turrrill
anatolica (Boiss.) Woronow
aretioides (Somerauer) Schinz & Thell.
baldaccii (Hal.) Mattf.
brevifolia (Nutt.) Mattf.
californica (Gray) Mattf.
capillacea (All.) Graebn.
cerastifolia (DC.) Graebn.
confusa (Boiss.) Maire & Petitm.
dianthifolia (Boiss.) Hand-Mzt.
douglasii (Fenzl) Mattf.
flaccida (L.) Reichb.
funkii (Jord.) Graebn.
glabra (Michx.) Mattf.
graminifolia (Arduino) Javorka
hamata (Hauskn.) Mattf.
howellii (Wats.) Mattf.
imbricata (M. Bieb.) Woronow
laricifolia (L.) Mattf.
mesogitana Mattf.
montana L.
obtusiloba (Rydb.) House
pestalozzae (Boiss.) Bornm.
recurva (All.) Schinz. & Thell
rossii (R.Br.) Graebn.
rubella (Wahlb.) Hiern.
saxifraga (Friv.) Graebn.
setacea (Thuill.) Hayek
stricta (Siv.) Hiern
umbellulifera (Boiss.) McNeill
viscosa (Schreber) Schinz & Thell.

Moehringia L.

- ciliata* (Scop.) Dalla Torre.
glaucovirens Bertol.

- aizoides* (Boiss.) Bornm.
arctica (Steven) Graebn.
austriaca (Jacq.) Hayek
biflora (L.) Schinz & Thell.
bulgarica (Velen.) Graebn.
campestris L.
caroliniana (Walt.) Mattf.
colchica Kharadze
dawsonensis (Britton) House
dichotoma L.
fasiculata (L.) Reichb.
formosa (Fenzl) Mattf.
geniculata (Poir) Thellung
globulosa (Labill.) Schinz & Thell.
groenlandica (Retz.) Ostenf.
hirsuta (M. Bieb.) Hand.-Mzt.
hybrida (Vill.) Schischk.
inamoena (C.A. Mey.) Woronow
mediterranea (Ledeb.) Maly
moehringioides (Ser.) Mattf.
mutabilis (Lapeyr.) Becherer
patula (Michx) Mattf.
picta (Sibth. & Sm.)
rimarum (Boiss. & Bal.) Mattf.
rostrata (Pres.) Reichb.
rupestris (Scop.) Schinze & Thell
sedoides (L.) Hiern.
stellata (Clarke) Maire & Petitm.
tenella Mattf.
verna (L.) Hiern.

- diversifolia* Dolliner
intricata Willk

Moehringia L.*jankae* Janka*muscosa* L.*radiolata* Pancic*stellarioides* Cosson*tommasinii* Marchesetti**Paronychia** Miller*arabica* (L.) DC.*capitata* (L.) Lam.*kapela* (Hacq.) A. Kenner**Petrorhagia** (Ser.) Link*illyrica* (Ard.) P. W. Ball & Heywood**Polycarpaea** Lam.*carnosa* Chr. Sm. ex Buch*repens* (Forsskal) Ascherson & Schweinf.*smithii* Link**Polycarpon** Loefl. ex L.*arabicum* Boiss*depressum* Rohrb.*loeflingiae* Benth. & Hook.*polycarpoides* (Biv.) Jahandiez & Maire*succulentum* (Delile) Gay**Pteranthus** Forsk.*dichotomus* Forsk.**Sagina** L.*apetala* Ard.**Scleranthus** L.*annuus* L.**Sclerocephalus***arabicus* Boiss.**Silene** L.*acaulis* L.*apetala* Willd.*armeria* L.*atlantica* Cosson & Durieu*laterifora* (L.) Fenzl*pendula* (W. & K.) Fenzl*sedifolia**tejedensis* Willk.*trinervia* (L.) Clairv.*argentea* Lam.*chlorothyrsa* Murb.*velutina* (Guss.) P. W. Ball & Heywood*divaricata* (Ait.) Poir*robbiarea* (O. Kunze) Greuter & Burdet*tenuis* Wibb ex Christ*bivonae* Gay*indica* Lam.*peplodes* DC.*prostratum* (Forsk.) Ascherson & Schweinf.*tetraphyllum* (L.) L.*maritima* G. Don.*aegyptiaca* (L.) L. fil.*arenaroides* Desf.*articulata* Viv.*behen* L.

Silene L.

- bellidifolia* Jacq.
cerastoides L.
coelirosa (L.) Godron
conica L.
corrugata Ball
dioica (L.) Clairv.
divaricata Lag.
fuscata Brot.
ghiavensis Batt.
heterodonta F. N. Williams
imbricata Desf.
italica (L.) Pers.
laeta (Aiton) Godron
littorea Brott.
longipetala Vent.
mekinensis Cosson
mollissima (L.) Pers.
neglecta Ten.
noctiflora L.
nutans L.
oropediorum Fenzl
pomeli Batt.
pseudoatiocion Desf.
reticulata Desf.
scabriflora Brot.
sedoides Poiret
stricta L.
tridentata Desf.
uniflora Roth
vivianii Steudel
Spergula L.
arvensis L.
morisonii Boreau
viscosa Lag.
boryi Boiss.
claryi Batt.
colorata Poiret.
conoidea L.
cyrenaica Maire & Weiller
disticha Willd.
fruticosa Otth
gallica L.
glabrescens Cosson
ibosii Emberger & Maire
inaperta L.
kremeri Soyer-Willemet & Godron
latifolia Poiret
longicaulis Lag.
marmarica Beguinot & Vacc.
micropetala Lag.
muscipula L.
nicaeensis All.
nocturna L.
obtusifolia Willd.
otites (L.) Wibel
pratensis L.
ramosissima Desf.
rubella L.
secundiflora Otth
sericea All.
succulenta Forsk.
tuberculata (Ball) Maire & Weiller
villosa Forsk.
vulgaris (Moench) Garcke
fallax (Lowe) E. H. L. Krause
pentandra L.

Spergularia (Pers.) J. & C. Persl.*bocconeii* (Scheele) Graebner*diandra* (Guss.) Boiss.*grandis* Cambess.*maritima* (All.) Chiov.*ramosa* Camess.*salina* J. Presl & C. Presl***Stellaria*** L.*cupaniana* (Jordan & Fourn.) Beguinot*pallida* (Dumort.) Pire`***Telephium*** L.*sphaerospermum* Boiss.***Vaccaria*** Medik.*pyramidata* Medik.*cerastoides* Fouc.*fimbriata* Boiss. & Reuter*levis* Cambess.*nicaeensis* Burnat*rubra* (L.) J. Presl & C. Presl*media* (L.) Vill.

Appendix II. Details of the Seed, Crystal and Fruit Capsule samples Studied; Herbaria abbreviations were taken from Patricia (1981). Material collected from Libya written in **bold**.

No	Taxon	Locality	Date	Collector	No.	Herbarium
01	<i>Agrostemma githago</i>	Syria	1906	Manoog	s. n.	(E)
02	<i>A. githago</i>	Turkey	1952	Davis	19320	(E)
03	<i>Arenaria acerosa</i>	s. l.	1845	J. Uelreide	s. n.	(BM)
04	<i>A. aculeata</i>	Canada	1959	W. Bird	5083	(BM)
05	<i>A. acutisepala</i>	Turkey	1957	Davis & Hedge	31477	(BM)
06	<i>A. alsinoides</i>	Mexico	1902	C. A. Purpus	2627	(E)
07	<i>A. alsinoides</i>	Mexico	1907	C. A. Purpus	s. n.	(E)
08	<i>A. alsinoides</i>	Mexico	1908	C. A. Purpus	s. n.	(E)
09	<i>A. angustisepala</i>	Turkey	1954	Davis <i>et al.</i>	22224	(E)
10	<i>A. angustisepala</i>	Turkey	1934	E. K. Balls	s. n.	(BM)
11	<i>A. armeriacea</i>	Turkey	1957	Davis & Hedge	51885	(BM)
12	<i>A. armerina</i>	Morocco	1973	E. Jahandiez	402	(E)
13	<i>A. armerina</i>	Morocco	1924	E. Jahandiez	626	(E)
14	<i>A. armerina</i>	Morocco	1936	E. K. Balls	3045	(E)
15	<i>A. armerina</i>	Morocco	1951	D. H. N. Spence	594	(E)
16	<i>A. armerina</i>	Morocco	1973	Davis	55011	(E)
17	<i>A. armerina</i>	Morocco	1973	Davis	55037	(E)
18	<i>A. armerina</i>	Algeria	1975	Davis	58951	(E)
19	<i>A. bertolonii</i>	Italy	1818	Adri Fiori	1032	(E)
20	<i>A. biflora</i>	Britain	1901	P. Ewing	15	(E)
21	<i>A. biflora</i>	Britain	1903	P. Ewing	95	(E)
22	<i>A. boliviana</i>	Bolivia	1860	G. Mandon	960	(BM)
23	<i>A. bryoides</i>	Mexico	1905	C. A. Purpus	1655	(BM)
24	<i>A. capillaris</i>	Canada	1956	J. A. Calder	17508	(BM)
25	<i>A. cerastoides</i>	Algeria	1830	W. Schimper	8	(E)
26	<i>A. cerastoides</i>	Algeria	1832	W. Schimper	128	(E)
27	<i>A. cerastoides</i>	Algeria	1850	P. Jamin	22	(E)
28	<i>A. cerastoides</i>	Algeria	1855	G. L. Durando	s. n.	(E)
29	<i>A. cerastoides</i>	Algeria	1891	John Ball	54	(E)
30	<i>A. cerastoides</i>	Algeria	1851	B. Balansa	96	(E)
31	<i>A. cerastoides</i>	Algeria	1852	B. Balansa	453	(E)
32	<i>A. cerastoides</i>	Algeria	1884	O. Debeaux	s. n.	(E)
33	<i>A. cerastoides</i>	Algeria	1891	Warion	200	(E)
34	<i>A. cerastoides</i>	Algeria	19 07	A. Faure	s.	(E)
35	<i>A. cerastoides</i>	Morocco	1912	C. J. Pitard	2702	(E)
36	<i>A. cerastoides</i>	Morocco	1927	E. Jahandiez	22	(E)
37	<i>A. cerastoides</i>	Algeria	1939	A. Faure	s.n.	(E)
38	<i>A. cerastoides</i>	Morocco	1972	F. K. Kupicha	278	(E)
39	<i>A. ciliaris</i>	Asia	1947	Sesse & Mociro	11186	(ULT)
40	<i>A. ciliata</i>	Switzerland	18 58	Balfour	s. n.	(E)
41	<i>A. ciliata</i>	France	1874	Jee` Jaas	26	(E)
42	<i>A. ciliata</i>	Spain	1889	E. Reverchon	s. n.	(E)
43	<i>A. ciliolata</i>	Tibet	1947	F. Idlow	15647	(BM)
44	<i>A. conferta</i>	Yugoslavia	s. d.	S. H. Lecnhouts	157	(L)
45	<i>A. conferta</i>	Greece	1966	J. C. Archibald	322	(L)
46	<i>A. cucubaloides</i>	Turkey	1934	E. K. Balls	1471	(BM)
47	<i>A. davisii</i>	Turkey	1961	Davis	694	(E)

No	Taxon	Locality	Date	Collector	No	Herbarium
48	<i>A. decussata</i>	Mexico	1894	C. G. Pringle	6479	(E)
49	<i>A. decussata</i>	Mexico	1948	F. G. Meyer	2967	(E)
50	<i>A. deflexa</i>	Syria	1863	B. T. Lowne	s. n.	(BM)
51	<i>A. densissima</i>	Tibet	1935	Ludlow <i>et al.</i>	3928	(BM)
52	<i>A. dianthoides</i>	Armenia	1957	s. c.	s. n.	(BM)
53	<i>A. dianthoides</i>	Turkey	1966	Davis	44024	(E)
54	<i>A. drypidea</i>	Turkey	1952	Dodds & Cetibe	20190	(BM)
55	<i>A. fendleri</i>	U. S. A.	1961	C. M. lit	19119	(BM)
56	<i>A. festucoides</i>	North India	1881	J. F. Dutilis	1391	(BM)
57	<i>A. filicaulis</i>	Finland	1887	S. Graeca	24	(E)
58	<i>A. formosa</i>	U. S. A.	1935	W. J. Eyerdam	s. n.	(BM)
59	<i>A. formosa</i>	Asia	1936	E. W. Tisdale	40367	(BM)
60	<i>A. forrestii</i>	China	s. d.	Y. Lichiang	15375	(C)
61	<i>A. frankinii</i>	U. S. A.	1873	C. C. Parry	35	(BM)
62	<i>A. gouffeia</i>	s. l.	1825	s. c.	388	(E)
63	<i>A. gouffeia</i>	France	1839	H.de Larambergue	442	(L)
64	<i>A. graminea</i>	U. S. S. R.	1836	R. F. Hohenackers	s. n.	(BM)
65	<i>A. grandiflora</i>	Spain	1970	P. Aichibold	3501	(E)
66	<i>A. griffithii</i>	Afghanistan	1956	W. Thesiger	1394	(BM)
67	<i>A. guatemalensis</i>	Guatemala	1967	A. Molina	21016	(BM)
68	<i>A. guicciardii</i>	Greece	1975	E. A. Meneg	s. n.	(E)
69	<i>A. gypsophiloides</i>	Turkey	1954	David & Polunin	23944	(BM)
70	<i>A. halacsyi</i>	Jugoslavia	1900	L. Vaccri	s. n.	(E)
71	<i>A. holostea</i>	Turkey	1957	Davis & Hedge	29365	(BM)
72	<i>A. holostea</i>	Iran	1960	P.Furse	95	(E)
73	<i>A. holostea</i>	Iran	1962	P.Furse	2290	(E)
74	<i>A. hispanica</i>	Spain	1900	E. Reverchon	s. n.	(E)
75	<i>A. hookeri</i>	Nebraska	1947	W. Kiener	22100	(BM)
76	<i>A. humifusa</i>	Newfound land	1958	T. T. Elkieton	130	(BM)
77	<i>A. huteri</i>	Italy	1900	Andri Fiori	s. n.	(E)
78	<i>A. incrassata</i>	Spain	1885	Parta et Figo	s. n.	(E)
79	<i>A. insignis</i>	Iran	1966	J. C. Archibald	2480	(E)
80	<i>A. kansuensis</i>	E. Tibet	1926	J. F. Rock	14222	(BM)
81	<i>A. kingii</i>	U. S. A.	1956	E. K. Balls	10899	(BM)
82	<i>A. lanuginosa</i>	Mexico	1928	E. Lyonnell	522	(M)
83	<i>A. lanuginosa</i>	Mexico	1935	H. Lesueure	465	(M)
84	<i>A. lanuginosa</i>	Guatemala	1947	A. Molina	419	(M)
85	<i>A. lanuginosa</i>	s. l.	1959	J. Duke	1672	(M)
86	<i>A. lanuginosa</i>	Guatemala	1974	A. Molina	30024	(M)
87	<i>A. lanuginosa</i>	Mexico	1976	D. E. Breedlore	42776	(M)
88	<i>A. lanuginosa</i>	Mexico	1977	W. Bennet <i>et al.</i>	10	(M)
89	<i>A. lanuginosa</i>	Nicaragua	1979	W. Douglas <i>et al.</i>	14954	(M)
90	<i>A. lanuginosa</i>	Nicaragua	1979	W. Douglas	15977	(M)
91	<i>A. lanuginosa</i>	Costarica	1979	W. D. Stevens	13406	(M)
92	<i>A. lanuginosa</i>	Nicaragua	1981	P. P. Moreno	10347	(M)
93	<i>A. lanuginosa</i>	Nicaragua	1981	P. P. Moreno	9692	(M)
94	<i>A. lanuginosa</i>	Mexico	1991	J. A. Soule	2918	(M)
95	<i>A. ledebourinana</i>	s. l.	1855	B. Balansa	s. n.	(BM)
96	<i>A. leptoclados</i>	Greece	1896	J. Dorflier	196	(E)
97	<i>A. leptoclados</i>	Serbia	1897	s. c.	15025	(E)
98	<i>A. leptoclados</i>	Crete	1940	Davis	1338	(E)
99	<i>A. leptoclados</i>	Morocco	1969	Davis	48969	(E)
100	<i>A. leptoclados</i>	Morocco	1969	Davis	48969	(E)

No	Taxon	Locality	Date	Collector	No	Herbarium
101	<i>A. leptoclados</i>	Libya	1970	Davis	50344	(E)
102	<i>A. leptoclados</i>	Algeria	1971	Davis	52652	(E)
103	<i>A. leptoclados</i>	Algeria	1975	Davis	58386	(E)
104	<i>A. leptoclados</i>	Tunisia	1975	Davis	57561	(E)
105	<i>A. leptoclados</i>	Britain	1889	J. Andrew	245	(GL)
106	<i>A. leptoclados</i>	Britain	1890	R. Withie	240	(GL)
107	<i>A. leptoclados</i>	Britain	1897	R. Kidston	234	(GL)
108	<i>A. leptoclados</i>	Britain	1908	D. Patton	155	(GL)
109	<i>A. leptoclados</i>	Britain	1932	T. Wise	s. n.	(GL)
110	<i>A. leptoclados</i>	Britain	1944	T. Megrouther	5137	(GL)
111	<i>A. leptoclados</i>	Britain	1949	E. R. Wise	1940	(GL)
112	<i>A. leptoclados</i>	Britain	1984	C. Rodriguaz	1984	(GL)
113	<i>A. lithops</i>	Spain	1970	E. Dominguez	s. n.	(E)
114	<i>A. loscosii</i>	Spain	1894	E. Reverchon	4027	(E)
115	<i>A. lychnidea</i>	s. l.	1933	E. R. Balls	557	(E)
116	<i>A. lychnidea</i>	Caucasus	1979	Z. Grinianidze	s. n.	(E)
117	<i>A. lycopodioides</i>	Mexico	1932	G. B. H.	2458	(BM)
118	<i>A. macrodenia</i>	U. S. A.	1943	A. Davidson	s. n.	(BM)
119	<i>A. montana</i>	Spain	1852	E. Bourgeau	1706	(E)
120	<i>A. montana</i>	Spain	1861	J. Ball	s. n.	(E)
121	<i>A. montana</i>	Spain	1889	E. Reverchon.	21	(E)
122	<i>A. napuligera</i>	China	1910	G. Forrest	6509	(BM)
123	<i>A. oreophila</i>	China	1932	J. Rock	24751	(BM)
124	<i>A. oresbia</i>	Jalisco	1952	R. Mcvaugh	13817	(BM)
125	<i>A. paludicola</i>	Mexico	1899	L. Robinson	233	(E)
126	<i>A. palustris</i>	South America	s. d.	H. F. Comber	1039	(E)
127	<i>A. persica</i>	s.l.	1842	R. F. Hohenacker	597	(BM)
128	<i>A. persica</i>	Iran	1934	Davis	796	(E)
129	<i>A. polycnemifolia</i>	Iran	1902	A. Bornmuller	6406	(BM)
130	<i>A. polytrichoides</i>	Tibet	1938	Ludlow <i>et al.</i>	5030	(BM)
131	<i>A. pseudacantholimon</i>	Turkey	1957	Davis & Hedge	31631	(BM)
132	<i>A. pseudacantholimon</i>	Turkey	1957	Davis & Hedge	31659	(E)
133	<i>A. pseudofrigida</i>	Greenland	1982	C. Bay <i>et al.</i>	1349	(BM)
134	<i>A. pulvinata</i>	Spain	1948	V. H. Heywood	1178	(E)
135	<i>A. pungens</i>	Morocco	1936	E. K. Balls	2738	(E)
136	<i>A. pungens</i>	Morocco	1962	J. C. Archibald	165	(E)
137	<i>A. pungens</i>	Morocco	1973	Davis	55231	(E)
138	<i>A. pungens</i>	Morocco	1973	Davis	55359	(E)
139	<i>A. pungens</i>	Morocco	1973	Davis	55484	(E)
140	<i>A. pungens</i>	Morocco	1985	C. Blanche <i>et al.</i>	31042	(E)
141	<i>A. pycnophylla</i>	Armenia	1937	s. c.	207	(BM)
142	<i>A. reptans</i>	Mexico	1905	C. A. Purpus	1665	(E)
143	<i>A. reptans</i>	Mexico	1907	C. A. Purpus	2769	(E)
144	<i>A. reptans</i>	Mexico	1965	D. E. Breedlove	8106	(M)
145	<i>A. reptans</i>	Mexico	1966	D. E. Beedlove	15304	(M)
146	<i>A. reptans</i>	Mexico	1971	D. E. Beedlove	22737	(M)
147	<i>A. retusa</i>	Spain	1973	E. Dominguez	1611	(E)
148	<i>A. rhodia</i>	Turkey	1958	Davis & Hedge	1958	(BM)
149	<i>A. sabulinea</i>	s. l.	1888	O. Stapf	825	(E)
150	<i>A. sabulinea</i>	Turkey	1957	Davis	28524	(E)
151	<i>A. saponarioides</i>	Cyprus	1880	s. c.	1816	(E)
152	<i>A. saponarioides</i>	Cyprus	1940	Davis	1858	(E)
153	<i>A. scariosa</i>	Turkey	1957	Davis & Hedge	s. n.	(E)

No	Taxon	Locality	Date	Collector	No	Herbarium
154	<i>A. serpyllifolia</i>	Morocco	1924	E. Jahandiez	615	(E)
155	<i>A. serpyllifolia</i>	Morocco	1932	A. Faure	1932	(E)
156	<i>A. serpyllifolia</i>	Morocco	1951	D.H. Spence	5239	(E)
157	<i>A. serpyllifolia</i>	Libya	1970	Davis	50344	(E)
158	<i>A. serpyllifolia</i>	Tripoli	1976	S. M. Jafri	6424	(ULT)
159	<i>A. serpyllifolia</i>	Algeria	1971	Davis	52537	(E)
160	<i>A. serpyllifolia</i>	Morocco	1973	Davis	55434	(E)
161	<i>A. serpyllifolia</i>	Algeria	1975	Davis	59389	(E)
162	<i>A. serpyllifolia</i>	Algeria	1971	Davis	53105	(E)
163	<i>A. serpyllifolia</i>	Algeria	1971	Davis	53105	(E)
164	<i>A. serpyllifolia</i>	Tunisia	1975	Davis & Lamond	57537	(E)
165	<i>A. serpyllifolia</i>	Algeria	1975	Davis	59262	(E)
166	<i>A. serpyllifolia</i>	Algeria	1975	Davis	59074	(E)
167	<i>A. serpyllifolia</i>	Algeria	1975	Davis	59466	(E)
168	<i>A. serpyllifolia</i>	Morocco	1981	Davis	67628	(E)
169	<i>A. serpyllifolia</i>	Britain	1889	J. Andrew	s. n.	(GL)
170	<i>A. serpyllifolia</i>	Britain	1882	W. Gourlie	s. n.	(GLI)
171	<i>A. serpyllifolia</i>	Britain	1883	J. Wglie	s. n.	(GL)
172	<i>A. serpyllifolia</i>	Britain	1892	Ahorollywod	234	(GL)
173	<i>A. serpyllifolia</i>	Britain	1902	s. c.	s. n.	(GL)
174	<i>A. serpyllifolia</i>	Britain	1905	Horwards	245	(GL)
175	<i>A. serpyllifolia</i>	Britain	s. d.	P. Ewing	243	(GL)
176	<i>A. serpyllifolia</i>	Britain	1912	P. Ewing	391	(GL)
177	<i>A. serpyllifolia</i>	Britain	1912	P. Ewing	392	(GL)
178	<i>A. serpyllifolia</i>	Britain	1948	K. W. Praid	1948	(GL)
179	<i>A. serpyllifolia</i>	Britain	1980	J. Dickson	42	(GL)
180	<i>A. serpyllifolia</i>	Britain	1985	J. Dickson	s. c.	(GL)
181	<i>A. serpyllifolia</i>	Britain	1985	H. J. Noltie	s. c.	(GL)
182	<i>A. serpyllifolia</i>	Britain	1987	s. n.	s. c.	(GL)
183	<i>A. steveiana</i>	Himilaya	1914	W. Foiber	28722	(BM)
184	<i>A. szowitsii</i>	Iran	1962	P. Furse	2237	(E)
185	<i>A. teddii</i>	Greece	1936	K. H. Rechinger	10317	(E)
186	<i>A. tetraquetra</i>	Europe	1825	J. Ganillo	885	(E)
187	<i>A. tetrasticha</i>	s. l	s. d.	Dalm Kow	4262	(BM)
188	<i>A. trichophoraq</i>	China	1987	D. Chamberlain <i>et al.</i>	1305	(BM)
189	<i>A. yunnanensis</i>	China	1890	A. E. Pratt	155	(BM)
190	<i>A. zargariana</i>	Iran	1966	J. C. Archibald	2540	(E)
191	<i>Cerastium. comatum</i>	Beida	1970	Davis	50519	(ULT)
192	<i>C. comatum</i>	Morocco	1912	G. Orphanides	188	(E)
193	<i>C. comatum</i>	Grecce	1883	P. Ascherson	143	(E)
194	<i>C. dichotomum</i>	Grecce	1884	s. c.	s. n.	(E)
195	<i>C. dichotomum</i>	Spain	1900	E. Reverchon	s. n.	(E)
196	<i>C. dichotomum</i>	Spain	1891	E. Reverchon	556	(E)
197	<i>C. dichotomum</i>	Britain	1892	P. Ewing	375	(E)
198	<i>C. glomeratum</i>	Tripoli	1970	s. c.	s. n.	(ULT)
199	<i>C. glomeratum</i>	Tripoli	1976	S. M. Jafri	6452	(ULT)
200	<i>C. glomeratum</i>	Tripoli	1977	A. Gafoor	298	(ULT)
201	<i>C. ligusticum</i>	Italy	1844	T. Caruel	8	(E)
202	<i>C. ligusticum</i>	Italy	1851	J. Ball.	s. n.	(E)
203	<i>C. ligusticum</i>	Italy	1907	Andri Fiori	s. n.	(E)
204	<i>C. pumilum</i>	Italy	1897	A. Kneuker	4710	(E)
205	<i>C. pumilum</i>	Spain	1962	R. K. Brummitt <i>et. al</i>	654	(E)
206	<i>C. pumilum</i>	Cechoslovaca	1962	F. Slavonovsky	1422	(E)

No	Taxon	Locality	Date	Collector	No	Herbarium
207	<i>C. pumilum</i>	Tripoli	1983	M. A. Siddiqi	s. n.	(ULT)
208	<i>C. semidecandrum</i>	Hungaria	1876	Braun.	3249	(E)
209	<i>C. semidecandrum</i>	France	1904	F. Sennen	32	(E)
210	<i>C. semidecandrum</i> s. n.	Italy	1961	K. H. Rechinger	21902	(E)
211	<i>C. semidecandrum</i> s. n.		1963	W. Greuter	1919	(ULT)
212	<i>C. siculum</i>	Italy	1908	S. Sommier	s. n.	(E)
213	<i>C. siculum</i>	Spain	1978	P. Harrold & R. J. McBeath	478	(E)
214	<i>Corrigiola littoralis</i>	Britain	1868	P. Ewing	2107	(E)
215	<i>C. littoralis</i>	Britain	s. d.	C. A. Johns	4379	(E)
216	<i>D. crinites</i>	Libya	1974	B. Faris	597	(ULT)
217	<i>D. crinites</i>	Afghanistan	1969	s. c.	9080	(E)
218	<i>Gymnocarpus decander</i>	Libya	1972	S. I. Ali	236	(E)
219	<i>G. decander</i>	Libya	1974	S. I. Ali	1821	(E)
220	<i>G. decander</i>	Tagma	1974	S. El. Jaley	199	(ULT)
221	<i>G. decander</i>	Libya	1975	S. I. Ali	2843	(E)
222	<i>Gypsophila elegans</i>	Tripoli	1967	s. c.	s. n.	(ULT)
223	<i>Gypsophila pilosa</i>	Gharian	1974	M. Godeh	269	(ULT)
224	<i>Herniaria cinera</i>	Tripoli	1973	S. I. Ali & Faruqi	1178	(ULT)
225	<i>H. cinera</i>	Garian	1974	S. I. Ali	2095	(ULT)
226	<i>H. cinerea</i>	Tripoli	1977	A. Gafoor	175	(ULT)
227	<i>H. cyrenaica</i>	Benghazi	1972	S. I. Ali	484	(ULT)
228	<i>H. ericifolia</i>	Libya	1970	Davis	49480	(E)
229	<i>H. ericifolia</i>	Libya	1970	Davis	49769	(E)
230	<i>H. ericifolia</i>	Tilel	1976	A. Ghafoor & S. lavi	46	(ULT)
231	<i>H. fontanesii</i>	Morocco	1933	A. Faure	s. n.	(E)
232	<i>H. fontanesii</i>	Kabao	1972	S. I. Ali	487	(ULT)
233	<i>H. fontanesii</i>	Zentan	1974	S. Elzualy	351	(ULT)
234	<i>H. fontanesii</i>	Nalut	1974	Bashir Faris	577	(ULT)
235	<i>H. fontanesii</i>	Mezda	1974	S. I. Ali	1927	(ULT)
236	<i>H. fontanesii</i>	Morocco	1985	Blanche <i>et al.</i>	20	(E)
237	<i>H. glabra</i>	Spain	1967	s. c.	1133	(ULT)
238	<i>H. glabra</i>	Libya	1970	Davis	50243	(E)
239	<i>H. glabra</i>	Libya	1970	Davis	50422	(E)
240	<i>H. hemistemon</i>	Al kararim	1968	L. Boulos	1898	(E)
241	<i>H. hemistemon</i>	Egypt	1967	Tackholm <i>et al.</i>	s. n.	(ULT)
242	<i>H. hemistemon</i>	Libya	1975	Z. Abou Raya	78	(ULT)
243	<i>H. hemistemon</i>	Shershara	1976	M. A. Haleem	s. n.	(ULT)
244	<i>H. hemistemon</i>	Qatar	1977	L. Boulos	10934	(E)
245	<i>Loeflingia hispanica</i>	Tripoli	1967	L. Boulos	1675	(ULT)
246	<i>L. hispanica</i>	Tripoli	1967	L. Bolous	1722	(ULT)
247	<i>L. hispanica</i>	Tripoli	1967	M. A. Siddiqi	99	(ULT)
248	<i>L. hispanica</i>	Tripoli	1970	Davis & Bolous	50584	(ULT)
249	<i>Lychnis flos-cuculi</i>	Britain	1913	J. Ramsay	4710	(GL)
250	<i>L. flos-cuculi</i>	Britain	1963	H. McAllister	20926	(GL)
251	<i>Minuartia acuminata</i> s. l.		1963	N. Jardine	667	(E)
252	<i>M. aizoides</i>	Turkey	1932	s. c.	s. n.	(E)
253	<i>M. anatolica</i>	Turkey	1957	Davis & Hedge	32718	(E)
254	<i>M. arctica</i>	U. S. A.	1891	Ben J. Hertage <i>et al.</i>	s. n.	(E)
255	<i>M. aretioides</i>	Italy	1905	L. Vaccri	528	(E)
256	<i>M. austriaca</i>	Austria	1879	T. Tichler	s. n.	(K)
257	<i>M. baldaccii</i>	Albania	1918	Dorfler	401	(E)
258	<i>M. biflora</i>	Greenland	1962	G. Argent	s. n.	(E)
259	<i>M. brevifolia</i>	U. S. A.	1893	John K Small	s. n.	(K)
260	<i>M. bulgarica</i>	Bulgaria	1975	A. Petrove	903	(K)

No	Taxon	Locality	Date	Collector	No	Herbarium
261	<i>M. californica</i>	U. S. A.	1866	H. N. Bolander	4684	(K)
262	<i>M. campestris</i>	Algeria	1852	Balansa	s. n.	(E)
263	<i>M. capillacea</i>	s. l.	1877	E. Reverchon	5	(E)
264	<i>M. caroliniana</i>	U. S. A.	1849	N. Ferscoh	s. n.	(K)
265	<i>M. caroliniana</i>	U. S. A.	1891	Ben J. Heritage <i>et al.</i>	19105	(E)
266	<i>M. cerastifolia</i>	Pyrenes	1880	Timba Lagrave <i>et al.</i>	s. n.	(E)
267	<i>M. colchica</i>	Caucasius	1977	Meorugze	s. n.	(K)
268	<i>M. confusa</i>	Italy	1945	s. c.	s. n.	(E)
269	<i>M. dawsonensis</i>	Canada	1957	Mrs Eva Beckett	152	(E)
270	<i>M. dawsonensis</i>	s. l.	1905	J. Murr.	4849	(E)
271	<i>M. dianthifolia</i>	Turkey	1947	Davis	694	(E)
272	<i>M. dichotoma</i>	Spain	1854	E. Bougeau	2273	(E)
273	<i>M. douglasii</i>	U. S. A.	1905	Louis Krautters	s. n.	(K)
274	<i>M. douglasii</i>	U. S. A.	1967	T. Voronova	6018	(L)
275	<i>M. fasciculata</i>	s. l.	1886	Louis Keller	s. n.	(E)
276	<i>M. fasciculata</i>	s. l.	1901	J. Murr.	4221	(E)
277	<i>M. fasciculata</i>	s. l.	1925	Br. Bl.	1145	(L)
278	<i>M. fasciculata</i>	Slovakia	1936	J. Weher	934	(L)
279	<i>M. fasciculata</i>	s. l.	1949	P. Vermeulen	5677	(L)
280	<i>M. fasciculata</i>	Italy	1961	S. J. Van Ooststroom	22908	(L)
281	<i>M. fasciculata</i>	s. l.	1962	P. Lizler	s. n.	(L)
282	<i>M. flaccida</i>	Italy	1926	F. Sennen	4372	(L)
283	<i>M. flaccida</i>	Italy	1961	S. J. Van Ooststroom	22984	(L)
284	<i>M. flaccida</i>	France	1976	G. M. Lokhorst <i>et al.</i>	68	(L)
285	<i>M. formosa</i>	Palaestine	1911	Fred S. Meyers	411	(E)
286	<i>M. formosa</i>	Palaestine	1911	S. Meyers <i>et al.</i>	820	(E)
287	<i>M. formosa</i>	Turkey	1969	Davis	1034	(E)
289	<i>M. funkii</i>	Spain	1892	E. Reverchon	s. n.	(E)
290	<i>M. funkii</i>	Morocco	1923	E. Jahandiez	448	(BM)
291	<i>M. funkii</i>	Spain	1909	F. Sennen	855	(E)
292	<i>M. geniculata</i>	Switzerland	1837	s. c.	s. n.	(E)
293	<i>M. geniculata</i>	Spain	1879	s. c.	86	(E)
294	<i>M. geniculata</i>	Spain	1888	E. Reverchon	38	(E)
295	<i>M. geniculata</i>	Libya	1970	Davis	49772	(E)
296	<i>M. geniculata</i>	Libya	1970	Davis	50208	(E)
297	<i>M. geniculata</i>	Morocco	1971	Davis	51315	(E)
298	<i>M. geniculata</i>	Libya	1972	S. I. Ali	780	(ULT)
298	<i>M. geniculata</i>	Somalia	1973	J. J. Lavranos	10315	(E)
299	<i>M. geniculata</i>	Tunisia	1975	Davis & Lamond	56920	(E)
300	<i>M. geniculata</i>	Canary Island	s. d.	O. Burchard	288	(E)
301	<i>M. geniculata</i>	Tunisia	1984	Davis	60990	(E)
302	<i>M. glabra</i>	U. S. A.	1843	Torr & Gray	s. n.	(K)
303	<i>M. globulosa</i>	Greece	1857	G. Orphanides <i>et al.</i>	930	(E)
304	<i>M. graminifolia</i>	Italy	1842	G. Rigo	4028	(E)
305	<i>M. graminifolia</i>	Italy	1898	G. Rigo	s. n.	(E)
306	<i>M. groenlandica</i>	U. S. A.	1918	M. L. Fernald <i>et al.</i>	358	(K)
307	<i>M. hamata</i>	Greece	1855	s. c.	s. n.	(E)
308	<i>M. hamata</i>	Spain	1903	Province De Jaen	703	(E)
309	<i>M. hamata</i>	Green land	1992	W. Burri & F. Rendl	s. n.	(E)
310	<i>M. hirsuta</i>	Macedonia	1956	K. H. Rechinger	17350	(E)
311	<i>M. hirsuta</i>	Greece	1977	E. A. Menneg	140	(E)
312	<i>M. hirsuta</i>	Algeria	1975	Davis	58974	(E)
313	<i>M. howellii</i>	U. S. A.	1928	J. W. Thompson	4591	(K)
314	<i>M. hybrida</i>	s. l.	1959	Davis	33345	(E)

No	Taxon	Locality	Date	Collector	No	Herbarium
315	<i>M. hybrida</i>	Corsica	1971	M. Mc Callum	14350	(E)
316	<i>M. hybrida</i>	Sicily	1979	Davis	64002	(E)
317	<i>M. hybrida</i>	Britain	1806	s. c.	135	(GL)
318	<i>M. hybrida</i>	Britain	1869	s. c.	268	(GL)
319	<i>M. hybrida</i>	Britain	1880	H. Searle	243	(GL)
320	<i>M. hybrida</i>	Britain	1881	R. M. Hay	394	(GL)
321	<i>M. hybrida</i>	Britain	1883	L. Watt	243	(GL)
322	<i>M. hybrida</i>	Algeria	1937	A. Faure	s. n.	(E)
323	<i>M. hybrida</i>	Britain	1938	J. Ramsay	268	(GL)
324	<i>M. hybrida</i>	Britain	1949	T. Wise	269	(GL)
325	<i>M. hybrida</i>	Britain	1953	E. C. Wallace	268	(GL)
326	<i>M. imbricata</i>	Turkey	1963	Davis & Hedge	3231	(K)
327	<i>M. inamoena</i>	Caucasus	1975	Tarmngze	s. n.	(K)
328	<i>M. laricifolia</i>	s. l.	1835	Dole	s. n.	(E)
329	<i>M. laricifolia</i>	s. l.	1876	Karl Richter	s. n.	(K)
330	<i>M. laricifolia</i>	s. l.	1898	Otto Krebs	s. n.	(E)
331	<i>M. mediterranea</i>	s. l.	1882	L. Thalos	s. n.	(E)
332	<i>M. mesogitana</i>	Turkey	1967	Davis	42149	(E)
333	<i>M. mesogitana</i>	Turkey	1967	Davis	42684	(E)
334	<i>M. moehringioides</i>	Mexico	1890	Pringle	3142	(E)
335	<i>M. moehringioides</i>	Mexico	1908	C. A. Purpus	s. n.	(E)
336	<i>M. montana</i>	Algeria	1852	B. Balansa	124	(E)
337	<i>M. montana</i>	Spain	1835	Schimper	416	(GL)
338	<i>M. montana</i>	Spain	1888	E. Reverchon	s. n.	(E)
339	<i>M. montana</i>	Spain	1890	E. Reverchon	s. n.	(E)
340	<i>M. montana</i>	Algeria	1891	Warion	103	(E)
341	<i>M. montana</i>	Morocco	1927	E. Jahandiez	318	(E)
342	<i>M. montana</i>	Morocco	1929	E. Jahandiez	338	(E)
343	<i>M. mutabilis</i>	Italy	1904	A. Beguinot	s. n.	(E)
344	<i>M. mutabilis</i>	Algeria	s. d.	A. Faure	s. n.	(E)
345	<i>M. mutabilis</i>	Italy	s. d.	Adr. Fiori <i>et al.</i>	s. n.	(E)
346	<i>M. obtusiloba</i>	Alaska	1979	Marjorie Rees	1711	(BM)
347	<i>M. patula</i>	U. S. A.	1844	Torr & Gray	318	(K)
348	<i>M. patula</i>	U.S. A.	1967	T. Voronova	s. n.	(L)
349	<i>M. pestalozzae</i>	s. l.	1949	Davis	15282	(E)
350	<i>M. picta</i>	s. l.	1835	W. Schimper	220	(E)
351	<i>M. picta</i>	Palaestine	1911	Fred. S. Meyer <i>et al.</i>	4411	(E)
352	<i>M. picta</i>	Palaestine	1911	s. c.	s. n.	(E)
353	<i>M. picta</i>	Cyprus	1941	Davis	9680	(K)
354	<i>M. picta</i>	Syria	1943	Davis	6684	(E)
355	<i>M. picta</i>	Jordan	1945	Davis	9626	(E)
356	<i>M. recurva</i>	Switzerland	1873	Johen Ball	s. n.	(E)
357	<i>M. recurva</i>	s. l.	1983	M. A. Siddiqi	s. n.	(ULT)
358	<i>M. rimarum</i>	Turkey	1963	Davis & Hedge	31802	(E)
359	<i>M. rossii</i>	U S S R	1979	V. Petrovsky	16019	(L)
360	<i>M. rostrata</i>	Algeria	1938	A. Faure	s. n.	(E)
361	<i>M. rubella</i>	Britain	1888	L. Watt.	241	(GL)
362	<i>M. rubella</i>	Britian	1930	G. Ghreag	88	(GL)
363	<i>M. rupestris</i>	Alps	1860	J. Ball	s. n.	(E)
364	<i>M. saxifraga</i>	Greece	1978	W. Greuter	16817	(E)
365	<i>M. sedoides</i>	s. l.	1833	G. Stewart	s. n.	(E)
366	<i>M. sedoides</i>	s. l.	1881	A. Mermods	s. n.	(E)
367	<i>M. sedoides</i>	Switzerland	1889	Archibald Dickson	14510	(E)
368	<i>M. sedoides</i>	s. l.	1951	Davis	14510	(E)

No	Taxon	Locality	Date	Collector	Date	Herbarium
369	<i>M. setacea</i>	Turkey	1962	Davis <i>et al.</i>	3849	(E)
370	<i>M. stellata</i>	Greece	1937	E. K. Ball <i>et al.</i>	3331	(K)
371	<i>M. stricta</i>	Britain	1844	J. Backhouse	267	(GL)
372	<i>M. stricta</i>	Britain	1884	H. S. Menell	240	(GL)
373	<i>M. tenella</i>	Canada	1893	John Macoun	s. n.	(K)
374	<i>M. tenella</i>	U.S. A.	1862	s. c.	64	(K)
375	<i>M. thomesiana</i>	s. l.	1894	A. Locatelli	s. n.	(E)
376	<i>M. umbellulifera</i>	Turkey	1949	Davis	15977	(K)
377	<i>M. verna</i>	s. l.	1863	Fraser	5189	(GL)
378	<i>M. verna</i>	Britain	1869	D. Stuart	5169	(GL)
379	<i>M. verna</i>	s. l.	1896	Hauskno	7134	(E)
380	<i>M. verna</i>	Morocco	1975	Davis	55365	(E)
381	<i>M. verna</i>	Spain	1978	Davis	62196	(E)
382	<i>M. verna</i>	Sicity	1979	Davis & D. S. Sutton	63840	(E)
383	<i>M. viscosa</i>	Italy	1930	Erik Asplund	761	(K)
384	<i>M. viscosa</i>	France	1974	J. Vicherek	1615	(L)
385	<i>M. viscosa</i>	s. l.	1984	J. P. Theurillat	12117	(L)
386	<i>Moehringia ciliata</i>	Italy	1854	TH. Caruel	481	(E)
387	<i>M. diversifolia</i>	China	1966	A. K. Schind.	589	(E)
388	<i>M. glaucovirens</i>	Italy	1844	P. Porta	4023	(E)
389	<i>M. intricata</i>	Spain	1903	E. Reverchon	1335	(E)
390	<i>M. jankae</i>	Bulgaria	1872	s. c.	s. n.	(E)
391	<i>M. lateriflora</i>	U.S. A.	1956	E. K. Balls	10885	(BM)
392	<i>M. muscosa</i>	s. l.	1876	P. Chenevard	s. n.	(E)
393	<i>M. pendula</i>	Greece	1896	J. Dorfler	360	(E)
394	<i>M. radiolata</i>	Thailand	1887	J. F. Maxwell	305	(E)
395	<i>M. sedifolia</i>	France	1886	E. Reverchon	131	(E)
396	<i>M. stellarioides</i>	Algeria	1898	s. c.	332	(E)
397	<i>M. stellarioides</i>	Algeria	1971	Davis	52867	(E)
398	<i>M. tejedensis</i>	Spain	1903	Province De Jaen	789	(E)
399	<i>M. tommasinii</i>	Italy	1844	P. Porta	s. n.	(E)
400	<i>M. tommasinii</i>	Italy	1908	C. Marchesetti	1033	(E)
401	<i>M. trinervia</i>	Algeria	1971	Davis	52154	(E)
402	<i>M. trinervia</i>	Algeria	1975	Davis	59097	(E)
403	<i>Paronychia arabica</i>	Wadi Al-Kouf	1967	Bolous	1716	(ULT)
404	<i>P. arabica</i>	Algeria	1971	Davis	53356	(E)
405	<i>P. arabica</i>	Tarhuna	1974	K. Milad	s. n.	(ULT)
406	<i>P. arabica</i>	Tripoli	1976	S. M. Jafri	s. n.	(ULT)
407	<i>P. arabica</i>	Wadi Sultan	1978	C. Rween	s. n.	(ULT)
408	<i>P. arabica</i>	Wadi Ash Shati	1978	s. c.	s. n.	(ULT)
409	<i>P. arabica</i>	Bugreen	1988	A. El-Gadi	s. n.	(ULT)
410	<i>P. argentea</i>	Algeria	1909	A. Faure	s. n.	(E)
411	<i>P. argentea</i>	Algeria	1912	A. Faure	s. n.	(E)
412	<i>P. argentea</i>	Messa	1972	S. I. Ali	618	(ULT)
413	<i>P. argentea</i>	Tokra	1973	S. I. Ali <i>et al.</i>	s. n.	(ULT)
414	<i>P. capitata</i>	Tripoli	1967	Boulos <i>et al.</i>	160	(ULT)
415	<i>P. capitata</i>	Tripoli	1970	Davis	49483	(ULT)
416	<i>P. capitata</i>	Tripoli	1977	Abdul Gafoor	274	(ULT)
417	<i>P. chlorothyrsa</i>	Morocco	1936	E. K. Balls	2520	(E)
418	<i>P. chlorothyrsa</i>	Morocco	1969	Davis	48775	(ULT)
419	<i>P. chlorothyrsa</i>	Garian	1973.	S. I. Ali	1642	(ULT)
420	<i>P. chlorothyrsa</i>	Garian	1974	El Jaly	358	(ULT)
421	<i>P. kapela</i>	France	1887	E. R. everchon <i>et. al</i>	257	(E)
422	<i>P. kapela</i>	Algeria	1968	M. N. Chaudhri	s. n.	(E)

No	Taxon	Locality	Date	Collector	Date	Herbarium
423	<i>Petrorhagia illyrica</i>	Italy	1969	s. c.	s. n.	(E)
424	<i>P. illyrica</i>	Abughilan	1975	S. M. Jafri	6230	(ULT)
425	<i>P. illyrica</i>	Abughilan	s. d.	S. I. Ali	2951	(ULT)
426	<i>P. illyrica</i>	Bulgaria	s. d.	C. Baenitz	s. n.	(E)
427	<i>P. velutina</i>	Spain	1903	E. Reverchon	s. n.	(E)
428	<i>P. velutina</i>	Algeria	1938	A. Faure	s. n.	(E)
429	<i>Polycarphaeae carnosae</i>	Tenerife	1948	E. R. Sventenius	s. n.	(ORT)
430	<i>P. carnosae</i>	Tenerife	1948	E. R. Sventenius	15891	(ORT)
431	<i>P. carnosae</i>	Tenerife	s. d.	E. R. Sventenius	15893	(ORT)
432	<i>P. divaricata</i>	La Palma	1944	E. R. Sventenius	s. n.	(ORT)
433	<i>P. divaricata</i>	La Palma	1966	s. c.	4135	(ORT)
434	<i>P. repens</i>	Algeria	1982	s. c.	s. n.	(E)
435	<i>P. repens</i>	Morocco	1936	E. K. Balls	s. n.	(E)
436	<i>P. robbaireae</i>	Iraq	1957	K. H. Rechinger	9400	(E)
437	<i>P. robbaireae</i>	Gado	1970	Davis	49590	(ULT)
438	<i>P. robbaireae</i>	Sebha	1973	S. I. Ali	1428	(ULT)
439	<i>P. robbaireae</i>	Ghat	1977	M. A. Siddiqi	s. n.	(ULT)
440	<i>P. smithii</i>	La Palma	1966	E. R. Sventenius	s. n.	(ORT)
441	<i>P. tenuis</i>	Tenerife	1975	E. K. Sventenius	2	(ORT)
442	<i>Polycarpon arabicum</i>	Palestine	1897	J. Bornmuller	26	(E)
443	<i>P. arabicum</i>	Palestine	1910	s. c.	3117	(E)
444	<i>P. bironae</i>	Algeria	1854	s. c.	224	(E)
445	<i>P. bironae</i>	Algeria	1856	s. c.	s. n.	(E)
446	<i>P. bironae</i>	Morocco	1929	E. Jahandiez	259	(E)
447	<i>P. depressum</i>	U.S. A.	1906	G. B. Grant	1023	(E)
448	<i>P. indica</i>	Thailand	1887	J. F. Maxwell	233	(E)
449	<i>P. loeflingiae</i>	India	1874	J. Ball	21737	(E)
450	<i>P. loeflingiae</i>	Indo-China	1891	B. Balansa <i>et al.</i>	107	(E)
451	<i>P. peploides</i>	s. l.	1900	H. Ross	s. n.	(E)
452	<i>P. peploides</i>	s. l.	1903	C. Bucknall	s. n.	(E)
453	<i>P. polycarpoides</i>	Algeria	1933	A. Falure	s. n.	(E)
454	<i>P. prostratum</i>	India	s. d.	S. Stainton <i>et al.</i>	5204	(E)
455	<i>P. prostratum</i>	Nigeria	1962	J. T. Swarbrick	2614	(E)
456	<i>P. prostratum</i>	Leptus	1968	L. Bolous	1875	(ULT)
457	<i>P. prostratum</i>	Libya	1970	Davis	50232	(E)
458	<i>P. succulentum</i>	Palaestine	1846	Duchair	372	(E)
459	<i>P. succulentum</i>	Palaestine	1908	s. c.	s. n.	(E)
460	<i>P. succulentum</i>	Kuwait	1981	s. c.	151	(E)
461	<i>P. tetraphyllum</i>	Australia	1893	Alex Morrison	s. n.	(E)
462	<i>P. tetraphyllum</i>	U. S. A.	1906	Harriet Walker	458	(E)
463	<i>p. tetraphyllum</i>	Algeria	1936	Herbier	s. n.	(E)
464	<i>P. tetraphyllum</i>	West Indies	1942	L. R. Holdrige	1196	(E)
465	<i>P. tetraphyllum</i>	Tenerife	1969	D. Bramwell	967	(E)
466	<i>P. tetraphyllum</i>	Leptus	1970	Davis	s. n.	(ULT)
467	<i>P. tetraphyllum</i>	Shahat	1972	S. I. Ali	789	(ULT)
468	<i>Pteranthus dichotomus</i>	Mizda	1977	M. A. Siddiqi	42	(ULT)
469	<i>P. dichotomus</i>	Morocco	1969	Davis	48703	(ULT)
470	<i>Sagina apetala</i>	Australia	1890	s. c.	s. n.	(E)
471	<i>S. apetala</i>	Tripoli	1977	A. Ghafoor	313	(ULT)
472	<i>S. apetala</i>	Morocco	1929	s. c.	s. n.	(E)
473	<i>S. apetala</i>	Afganistan	1962	s. c.	s. n.	(E)
474	<i>S. apetala</i>	Tenerife	1981	C. Rodriguez	s. n.	(GL)
475	<i>S. apetala</i>	Tenerife	1982	J. Dickson	s. n.	(GL)
476	<i>S. maritima</i>	Libya	1970	Davis	50236	(L)

No	Taxon	Locality	Date	Collector	No	Herbarium
477	<i>S. maritima</i>	Greece	1973	s. c.	s. n.	(E)
478	<i>Scleranthus annuus</i>	Britain	1890	L. Watt	1386	(GL)
479	<i>Scleranthus annuus</i>	Britain	1908	G. B. Nielson	4359	(GL)
480	<i>Sclerocephalus arabicus</i>	Hun	1973	S. I. A.	1518	(ULT)
481	<i>Silene acaulis</i>	Britain	1869	D. Steuart	4589	(GL)
482	<i>S. acaulis</i>	Britain	1949	D. Patton	230	(GL)
483	<i>S. aegyptiaca</i>	Lebanon	1988	J. C. Archibald	s. n.	(BM)
484	<i>S. apetala</i>	Algeria	1936	Lieux	s. n.	(E)
485	<i>S. apetala</i>	Libya	1952	K. M. Guichard	1265	(K)
486	<i>S. apetala</i>	Tripoli	1933	s. c.	s. n.	(K)
487	<i>S. apetala</i>	Libya	1970	Davis	49943	(E)
488	<i>S. apetala</i>	Libya	1970	Davis & Boulos	50587	(E)
489	<i>S. apetala</i>	Morocco	1972	I. B. R. Richardson	454	(E)
490	<i>S. apetala</i>	Tripoli	1977	Abdul Gafoor	280	(ULT)
491	<i>S. arenaroides</i>	Tunisia	1977	Davis	61236	(BM)
492	<i>S. armeria</i>	Britain	1935	T. wise	203	(GL)
493	<i>S. armeria</i>	Britain	1931	W. Gourlie	225	(GL)
494	<i>S. articulata</i>	Cyrenaica	1939	s. c.	392662	(BM)
495	<i>S. articulata</i>	Libya	1981	M. Bhadri & A. Ghafoor	7113	(E)
496	<i>S. articulata</i>	Rasalhilal	1954	K. M. Guichard	s. n.	(BM)
497	<i>S. atlantica</i>	Algeria	1916	A. Faure	s. n.	(BM)
498	<i>S. behen</i>	Libya	1970	s. c.	s. n.	(E)
499	<i>S. bellidifolia</i>	s. l.	1819	s. c.	s. n.	(BM)
500	<i>S. boryi</i>	Spain	1851	Bourgeau	185	(BM)
501	<i>S. boryi</i>	Morocco	1973	Davis	55370	(BM)
502	<i>S. boryi</i>	Morocco	1974	s. c.	849	(BM)
503	<i>S. cerastoides</i>	Algeria	1910	A. Faure	121/92	(E)
504	<i>S. cerastoides</i>	Algeria	1937	A. Faure	s. n.	(E)
505	<i>S. cerastoides</i>	Sabrata	1976	S. A. Jafri	6711	(ULT)
506	<i>S. claryi</i>	Morocco	1975	Davis	58725	(BM)
507	<i>S. coelirosa</i>	Italy	1898	B. Coll.	111	(BM)
508	<i>S. coelirosa</i>	Morocco	1912	C. J. Pitard	2695	(E)
509	<i>S. colorata</i>	Libya	1939	N. Y. Sandwith	2518	(K)
510	<i>S. colorata</i>	Gargrese	1952	K. M. Guichard	s. n.	(BM)
511	<i>S. colorata</i>	Rass Hilal	1979	Fauzy Ouheda	s. n.	(ULT)
512	<i>S. colorata</i>	Arabia	1991	s. c.	s. n.	(E)
513	<i>S. conica</i>	Britain	1869	D. Steuart	4642	(GL)
514	<i>S. conica</i>	Britain	1869	G. A. Arnott	4643	(GL)
515	<i>S. conica</i>	Britain	1907	G. B.	4645	(GL)
516	<i>S. conoidea</i>	Spain	1909	F. Sennen	850	(E)
517	<i>S. conoidea</i>	Tripoli	1969	A. Ghafoor	s. n.	(ULT)
518	<i>S. conoidea</i>	Gossen	1974	G. Faris	373	(ULT)
519	<i>S. conoidea</i>	Algeria	1975	Davis	58726	(E)
520	<i>S. conoidea</i>	Saudi Arabia	1982	s. c.	s. n.	(E)
521	<i>S. corrugata</i>	Morocco	1972	Davis	54203	(BM)
522	<i>S. cyrenaica</i>	Libya	1970	Davis	50228	(BM)
523	<i>S. cyrenaica</i>	Wadi Mahbool	1973	S. I. Ali <i>et al.</i>	1076	(ULT)
524	<i>S. cyrenaica</i>	Derna	1939	N. D. Simpson	39299	(BM)
525	<i>S. dioica</i>	Britain	1939	J. Walton	4691	(GL)
526	<i>S. dioica</i>	Britain	1949	R. Wise	s. n.	(GL)
527	<i>S. dioica</i>	Britain	1985	J. H. Dickson	34865	(GL)
528	<i>S. disticha</i>	Morocco	1972	Davis	54311	(E)
529	<i>S. divaricata</i>	Morocco	1901	C. J. Pitard	s. n.	(BM)
530	<i>S. fruticosa</i>	Libya	1970	Davis	50473	(E)

No	Taxon	Locality	Date	Collector	No	Herbarium
531	<i>S. fuscata</i>	Morocco	1936	E. K. Balls	2460	(E)
532	<i>S. fuscata</i>	Algeria	1937	A. Faure	s. n.	(E)
533	<i>S. gallica</i>	Britain	1869	G. A. Arnott	4626	(GL)
534	<i>S. gallica</i>	Britain	1931	W. Gourlie	4627	(GL)
535	<i>S. gallica</i>	Britain	1949	R. Wise	4632	(GL)
536	<i>S. gallica</i>	Libya	1970	Davis	49791	(E)
537	<i>S. gallica</i>	Algeria	1971	s. c.	s. n.	(E)
538	<i>S. gallica</i>	Tripoli	1978	A. Gafoor	278	(ULT)
539	<i>S. gallica</i>	Saudi Arabia	1981	s. c.	s. n.	(E)
540	<i>S. ghiavensis</i>	Algeria	1939	A. Faure	s. n.	(BM)
541	<i>S. glabrescens</i>	Morocco	1972	Davis	53757	(BM)
542	<i>S. heterodonta</i>	Morocco	1973	Davis	55424	(BM)
543	<i>S. ibosii</i>	Morocco	1970	Davis	50695	(BM)
544	<i>S. imbricata</i>	Algeria	1975	Davis	59431	(BM)
545	<i>S. inaperta</i>	s. l.	1888	Abbe H. Coste	1625	(BM)
546	<i>S. italica</i>	Algeria	1975	Davis	59029	(BM)
547	<i>S. italica</i>	s. l.	1983	M. Diltice	s. n.	(E)
548	<i>S. italica</i>	Britain	1987	G. Steven	3569	(GL)
549	<i>S. italica</i>	Britain	s. d.	D. Kent	4489	(GL)
550	<i>S. kremeri</i>	Algeria	1880	E. Cosson	s. n.	(BM)
551	<i>S. laeta</i>	Spain	1970	B. M. Allen	6574	(BM)
452	<i>S. latifolia</i>	Britain	1860	s. c.	4654	(GL)
453	<i>S. latifolia</i>	Britain	1876	P. Ewing	355	(GL)
454	<i>S. latifolia</i>	Britain	1958	J. Walton	s. n.	(GL)
555	<i>S. littorea</i>	Spain	1978	Davis	61625	(BM)
556	<i>S. longicaulis</i>	Portugal	1853	Boureau	178	(BM)
557	<i>S. longicilia</i>	Morocco	1985	J. Molero	s. n.	(BM)
558	<i>S. longipetala</i>	Turkey	1957	s. c.	s. n.	(E)
559	<i>S. longipetala</i>	Greece	1896	J. Dorfler	250	(E)
560	<i>S. marmarica</i>	Libya	1913	K. Musei Florentini	s. n.	(E)
561	<i>S. marmarica</i>	Libya	1913	A. Vaccari	s. n.	(BM)
562	<i>S. mekinensis</i>	Morocco	1929	E. Jahandiez	342	(BM)
563	<i>S. micropetala</i>	Spain	1853	E. Reverchon	s. n.	(BM)
564	<i>S. micropetala</i>	Spain	1889	E. Reverchon	s. n.	(BM)
565	<i>S. mollissima</i>	Morocco	1973	Davis	54744	(BM)
566	<i>S. muscipula</i>	Spain	1890	Wilkoman	518	(BM)
567	<i>S. muscipula</i>	Morocco	1929	E. Jahandiez	185	(BM)
568	<i>S. muscipula</i>	Morocco	1988	s. c.	s. n.	(E)
569	<i>S. neglecta</i>	Algeria	s. d.	Davis	58392	(BM)
570	<i>S. neglecta</i>	Algeria	1910	A. Faure	s. n.	(E)
571	<i>S. niceensis</i>	Morocco	1970	Davis	50802	(BM)
572	<i>S. noctiflora</i>	Britain	1869	G. A. Arnott	85	(GL)
573	<i>S. noctiflora</i>	Britain	1891	R. Kidston	202	(GL)
574	<i>S. noctiflora</i>	Britain	1903	T. Wise	235	(GL)
575	<i>S. nocturna</i>	Algeria	1897	Elisee Re.	305	(BM)
576	<i>S. nocturna</i>	Algeria	1936	A. Faure	s. n.	(BM)
577	<i>S. nutans</i>	Britain	1839	T. G. Rylands	4495	(GL)
578	<i>S. nutans</i>	Britain	1880	L. watt.	209	(GL)
579	<i>S. nutans</i>	Britain	1894	S. Devon	4494	(GL)
580	<i>S. obtusifolia</i>	Morocco	1974	B. M. Exped.	1110	(BM)
581	<i>S. oropediorum</i>	Algeria	1938	A. Faure	s. n.	(BM)
582	<i>S. otites</i>	Britain	1878	R. Kidston	199	(GL)
583	<i>S. otites</i>	Britain	1952	B. W. Ribbons	4508	(GL)
584	<i>S. pomeli</i>	Algeria	1975	Davis	59030	(BM)

No	Taxon	Locality	Date	Collector	No	Herbarium
585	<i>S. pomeli</i>	Morocco	s. d.	Jamais	384	(BM)
586	<i>S. protensis</i>	Morocco	1974	B. M. Exped.	154	(BM)
587	<i>S. pseudoatiocion</i>	Algeria	1975	Davis	58327	(BM)
588	<i>S. ramosissima</i>	Algeria	1852	B. Balansa	360	(BM)
589	<i>S. reticulata</i>	Algeria	1975	Davis	59525	(BM)
590	<i>S. rubella</i>	Tunisia	1975	s. c.	s. n.	(E)
591	<i>S. rubella</i>	Morocco	1962	J. C. Archibald	220	(E)
592	<i>S. scabriflora</i>	Morocco	1929	E. Jahandiez	39	(BM)
593	<i>S. secundiflora</i>	Algeria	1975	Davis	58810	(BM)
594	<i>S. sedoides</i>	Italy	1840	s. c.	s. n.	(E)
595	<i>S. sedoides</i>	Greece	s. d.	Th. Kaiis	9993	(BM)
596	<i>S. sericea</i>	Italy	s. d.	s. c.	291	(BM)
597	<i>S. sericea</i>	Europe	1904	J. W. White	291	(BM)
598	<i>S. stricta</i>	Algeria	1910	A. Fame	s. n.	(BM)
599	<i>S. succulenta</i>	Dariana	1972	S. I. Ali	445	(ULT)
600	<i>S. succulenta</i>	Lulida	1975	A. Fuzi	s. n.	(ULT)
601	<i>S. succulenta</i>	Aulad Mohamed	1977	M. A. Siddiqi	229	(ULT)
602	<i>S. tridentata</i>	Tunisia	1975	Davis	57192	(E)
603	<i>S. tridentata</i>	Morocco	1952	D. H. Spence	s. n.	(E)
604	<i>S. tuberculata</i>	Morocco	1927	s. c.	411	(BM)
605	<i>S. uniflora</i>	Britain	1875	R. Kidston	184	(GL)
606	<i>S. villosa</i>	Algeria	1938	A. Faure	s. n.	(BM)
607	<i>S. villosa</i>	Morocco	1969	Davis	49087	(BM)
608	<i>S. villosa</i>	Sebha	1973	S. I. Ali <i>et al.</i>	1451	(ULT)
609	<i>S. villosa</i>	Saudi Arabia	1991	s. c.	s. n.	(E)
610	<i>S. vivianii</i>	Morocco	1936	E. K. Balls	2538	(BM)
611	<i>S. vivianii</i>	Egypt	1945	s. c.	s. n.	(BM)
612	<i>S. vulgaris</i>	Britain	1869	D. Steuart	4535	(GL)
613	<i>S. vulgaris</i>	Britain	1896	J. B. Nielson	202	(GL)
614	<i>S. vulgaris</i>	Britain	1954	J. Walton	223	(GL)
615	<i>S. vulgaris</i>	Italy	1970	J. Damblon	s. n.	(E)
616	<i>S. vulgaris</i>	Britain	1983	J. Dickson	34849	(GL)
617	<i>S. vulgairs</i>	Britain	1985	J. Smith <i>et al.</i>	s. n.	(GL).
618	<i>Spergula arvensis</i>	Atlantic Islands	1891	J. F. Hamilton	s. n.	(E)
619	<i>S. arvensis</i>	China	1965	A. K. Schind.	s. n.	(E)
620	<i>S. arvensis</i>	Australia	1939	Milos Deyl	s. n.	(E)
621	<i>S. arvensis</i>	Japan	1957	Markino	s. n.	(E)
622	<i>S. arvensis</i>	North Asia	1965	M. Mizushima	s. n.	(E)
623	<i>S. arvensis</i>	s. l.	1967	Sumike Kobayashi	1300	(E)
624	<i>S. arvensis</i>	Portugal	1971	Davis	50902	(E)
625	<i>S. arvensis</i>	s. l.	s. d.	Chris Parker	7099	(E)
626	<i>S. arvensis</i>	South Africa	1973	O. M. Hilliard	7504	(E)
627	<i>S. arvensis</i>	Tanzania	1989	C. M. Taylor <i>et al.</i>	8391	(E)
628	<i>S. fallax</i>	Palestine	1935	Amdursky <i>et al.</i>	s. n.	(E)
629	<i>S. fallax</i>	Sharshara	1966	s. c.	s. n.	(ULT)
630	<i>S. fallax</i>	Libya	1970	Davis	50271	(E)
631	<i>S. morisonii</i>	s. l.	1891	John Ball	s. n.	(E)
632	<i>S. morisonii</i>	Berlin	1900	s. c.	s. n.	(E)
633	<i>S. pentandra</i>	Morocco	1923	s. c.	s. n.	(E)
634	<i>S. pentandra</i>	Kashmir	1956	O. Polunin	56/368	(E)
635	<i>S. pentandra</i>	Asia	1877	J. Ball	s. n.	(E)
636	<i>S. viscosa</i>	Spain	1978	s. c.	198	(E)
637	<i>Spergularia bocconei</i>	Chile	1924	E. Werdermann	385	(E)
638	<i>S. bocconei</i>	Libya	1970	Davis	49820	(E)

No	Taxon	Locality	Date	Collector	No	Herbarium
639	<i>S. bocconeii</i>	Chile	1992	M. E. Gardner <i>et al.</i>	5105	(E)
640	<i>S. bocconeii</i>	Algeria	1989	s. c.	s. n.	(E)
641	<i>S. cerastoides</i>	Chile	1905	Otto Buchtien	s. n.	(E)
642	<i>S. diandra</i>	Asia	1928	Popor <i>et Vredensky</i>	464	(E)
643	<i>S. diandra</i>	Egypt	1967	Tackholm <i>et al.</i>	s. n.	(ULT)
644	<i>S. diandra</i>	Azizia	1970	s. c.	s. n.	(ULT)
645	<i>S. fimbriata</i>	s. l.	1845	s. c.	96	(E)
646	<i>S. grandis</i>	Brazil	s. d.	s. c.	2224	(E)
647	<i>S. levis</i>	Australia	1964	E. M. Barron	15694	()
648	<i>S. maritima</i>	Algeria	1934	Sebkhas	s. n.	(E)
649	<i>S. maritima</i>	Tarhona	1976	A. Gafoor <i>et al.</i>	30	(ULT)
650	<i>S. maritima</i>	Wadi Alshati	1978	s. c.	s. n.	(ULT)
651	<i>S. nicaeensis</i>	Iran	1974	Davis & Bokhari	56513	(E)
652	<i>S. ramosa</i>	s. l.	1831	Charles Darwin	s. n.	(E)
653	<i>S. rubra</i>	Ras al Hilal	1972	S. I. Ali	695	(ULT)
654	<i>S. rubra</i>	Talil	1976	S. M. Jafri	6684	(ULT)
655	<i>S. salina</i>	Asia	1924	Kultiassov	466	(E)
656	<i>S. salina</i>	Askadda	1973	S. I. Ali	1410	(ULT)
657	<i>S. salina</i>	Tripoli	1977	Abdul Gafoor	281	(ULT)
658	<i>S. salina</i>	Tripoli	1991	s. c.	s. n.	(ULT)
659	<i>Stellaria cupaniana</i>	Corfu	1993	J. Dickson	s. n.	(GL)
660	<i>S. media</i>	Tenerife	1981	C. Rodriguez	s. n.	(GL)
661	<i>S. media</i>	Tripoli	1993	M. Magrabi	s. n.	(ULT)
662	<i>S. media</i>	Britain	1950	J. Riddell	s. n.	(GL)
663	<i>S. media</i>	Tripoli	1992	W. Fashloom	17	(ULT)
664	<i>S. pallida</i>	Tripoli	1992	M. Magrabi	s. n.	(ULT)
665	<i>S. pallida</i>	Tripoli	1992	S. Fashloom	10	(ULT)
666	<i>S. pallida</i>	Ganzoor	1992	W. Fashloom	16	(ULT)
667	<i>Telephium sphaerospermum</i>	Derna	1967	L. Boulos	1275	(ULT)
668	<i>Vaccaria pyramidata</i>	Jefren	1974	S. El. Jaly	184	(ULT)
669	<i>V. pyramidata</i>	Gabel Akhder	1978	A. Gafoor	390	(ULT)
670	<i>V. pyramidata</i>	Gusbat	1979	El-Gadi	s. n.	(ULT)

Appendix III.

An artificial key to the wild Libyan species of Caryophyllaceae based only on seed characters. Only three species of Caryophyllaceae (including Illecebraceae) are omitted. No ripe seeds of *Dianthus serrulatus*, *Petrorhagia illyrica* and *Silene biappendiculata* were readily available.

- 1A. Lateral faces of seeds smooth, cells faint or indistinct, seeds without wings.
- 2A. Seeds round-reniform*Silene succulenta*.
- 2B. Not so.
- 3A. Seeds curved-oblong or cuneate.
- 4A. Oblong-curved (crescent shaped), surface wrinkled.....
.....*Polycarpaea repens*.
- 4B. Cuneate, surface smooth.
- 5A. Dense papillae surrounding the radicle base and dorsal side.....
.....*Loeflingia hispanica*.
- 5B. Few papillae surrounding the radicle only.....*Polycarpaea robbairea*.
- 3B. Seeds obovate, circular-obovate or broadly elliptic.
- 6A. Micropyle pointed or compressed laterally.
- 7A. Keel strongly compressed laterally, hilum surrounded by faint cells.....
.....*Paronychia kapela*.
- 7B. Keel slightly compressed, hilum surrounded by distinct cells.....
.....*Paronychia capitata*.
- 8A. Space between radicle and hilum shallow.....*Paronychia chlorothyrsa*.
- 8B. Space between radicle and hilum deep *Herniaria cyrenaica*.
- 6B. Micropyle blunt circular.
- 9A. Hilum very close to radicle.....*Paronychia argentea*.

- 9B. Hilum distinctly separated from radicle.
- 10A. Deep cavity between hilum and radicle.
- 11A. Micropyle filled with indistinct thread like structure, collar cells faint.....
.....*Paronychia arabica*.
- 11B. Micropyle filled with distinct cells mostly curved elongate (star
shaped), collar cells faint.*Herniaria fontanesii*.
- 10B. Shallow depression between hilum and radicle.
- 12A. Radicle discoid but the hilum strongly compressed laterally.....
.....*Herniaria hemistemon*.
- 12B. Radicle and hilum with discoid shape.
- 13A. Hilum surrounded by double collar of special rectangular cells.....
.....*Herniaria cinera*.
- 13B. Hilum ended by smooth dome shape.
- 14A Cells surrounding the micropyle small rectangular with distinct walls
..... *Herniaria ericifolia*.
- 14B. Cells surrounding the micropyle large with faint or indistinct
walls.....*Herniaria glabra*.
- 1B. Lateral faces seeds rough (or if smooth cells distinct), cells faint or
distinctly protruding, seeds with or without wings.
- 15A. Seeds globular or subglobular.
- 16A. Lateral face cells mostly spherical, each cell covered with dense
granules.....*Telephium sphaerospermum*.
- 16B. Lateral face cells polygonal with blunt sinuate margins,
papillate.....*Vaccaria pyramidata*.
- 15B. Seed shapes various often reniform but not globular.
- 17A. Radicle \pm straight.
- 18A. Seed light brown or faint yellow.
- 19A. Seeds light brown, obovate-reniform, lateral faces flat, slightly slanted

- radicle gradually tapering to acute apex... *Sclerocephalus arabicus*.
- 19B. Seeds faint yellow, elongate-obovate, dorsally convex, radicle
flatten, broadened round at apex.....*Pteranthus dichotomus*.
- 18B. Seed black.
- 20A. Seed obovate, boat shaped.....*Petrorhagia velutina*.
- 20B. Seed obovate, plane.
- 21A. Dorsal face cells narrow, elongate, arranged in regular rows, spurs
regular undulate with blunt apices.....*Dianthus crinitus*.
- 21B. Dorsal face cells narrow elongate, arranged irregularly, spurs with
irregular shapes and sizes.....*Petrorhagia illyrica*.
- 17B. Radicle slightly or strongly curved.
- 22 A. Seeds with membranous wings.
- 23A. Wings membranous, mostly entire, spurs regularly spaced, ending in
pore-like epression.....*Spergula fallax*.
- 23B. Not so.
- 24A. Seeds winged, wings margins slightly sinuate, lateral face cells with
irregular jagsaw shape.....*Spergularia maritima*.
- 24B. Seeds winged or not, wings erose to lancinate, lateral face cells
elongate or ovate*Spergularia salina*.
- 22B. Seed without membranous wings.
- 25A. Seeds obovate, with shallow or deep groove separating the lateral
and marginal faces.
- 26A. Radicle long, strongly curved and compressed at apex, lateral faces,
slightly concave.....*Gymnocarpos decander*.
- 26B. Radicle short, slightly curved, longer than cotyledons, lateral faces
slightly convex.
- 27A. Shallow groove between lateral and marginal faces, cells distinct, with
jagsaw shape, raised into blunt papillae, spurs few.

-*Spergularia diandra*.
- 27B. Deep groove between lateral and maginal faces, cells mostly indistinct, elongate, raised into discoid papillae, spurs many.
- 28A. Radicle thick, broad, round, c. 70 μm wide near apex.....
.....*Spergularia rubra*.
- 28B. Radicle compressed laterally, slightly tapering, c. 30 μm wide near apex.....*Spergularia bocconii*.
- 25B. Seeds not obovate, lacking grooves between lateral and marginal faces.
- 29A. Seeds mostly retortiform, radicle \pm strongly curved, like a hook.
- 30A. Mid-zone cells mostly long, narrowly elongate.
- 31A. Seed retortiform-elliptic.....*Minuartia hybrida*.
- 31B. Seed reniform to retortiform.....*Minuartia mediterranea*.
- 30B. Mid-zone cells mixed short or elongate, elliptic or ovate.
- 32A. Hilar notch area covered mostly with dense small warts.....
.....*Minuartia geniculata*.
- 32B. Hilar notch area covered mostly with few distinct papillae.
- 33A. Seed retortiform, radicle cells 13-54 μm long.....
.....*Minuartia campestris*.
- 33B. Seed round -reniform, radicle cells 33-65 μm long.....
.....*Minuartia montana*.
- 29B. Seed mostly cuneate or reniform, radicle \pm slightly incurved or equalling cotyledons.
- 34A. Seed cuneate.
- 35A. Lateral face cells without spurs.
- 36A. Papillae mostly of regular size and dense, not on clearly defined raised bases.....*Polycarpon prostratum*.

- 36B. Papillae mostly of irregular size and less dense, many with raised bases.....*Polycarpon tetraphyllum*.
- 35B. Lateral face cells with distinct spurs.
- 37A. Lateral face cells mostly round or mixed stelliform, elliptic or elongate.
- 38A. Lateral face flat slightly concave.....*Cerastium siculum*.
- 38B. Lateral face slightly or strongly convex
- 39A. Lateral face cells mostly round, raised into sharp or blunt, smooth papillae.....*Cerastium dichotomum*.
- 39B. Lateral face cells mostly elongate or elliptic, raised into blunt, granular papillae*Cerastium semidecandrum*.
- 37B. Lateral face cells mostly narrow-elongate.
- 40A. Lateral faces cells straight, in regular rows, raised into sharp ridges, cell length 8-10 times that of the spurs.....*Cerastium illyricum*.
- 40B. Lateral face cells straight or curved, regular or irregular, raised into blunt or conical papillae, cell length 4-5 times that of the spurs.
- 41A. Lateral face cells arranged in c. 4 regular rows, cells straight or curved, spurs arranged \pm pinnately.....*Cerastium glomeratum*.
- 41B. Lateral face cells irregular, slightly curved, spurs not appearing pinnate.
- 42A. Lateral face raised into narrow or broad cells that broader than spur, marginal face with short conical tubercles \pm 16 μ m length.....*Cerastium ligusticum*.
- 42B. Lateral face raised into narrow cells \pm equal spurs in thickness, marginal face with long conical tubercles \pm 35 μ m length*Cerastium pumilum*.
- 34B. Seeds reniform.
- 43A. Radical \pm equaling cotyledons.

- 44A. Lateral faces deeply concave.
- 45A. Mid-zone spurs undulate or indistinct.
- 46A. Lateral face cells broad, elliptic, raised into 2-3 warts, pads large and globular*Silene gallica*.
- 46B. Lateral face cells narrow; elongate or elliptic, raised up to 8 warts; pads flat.*Silene tridentata*.
- 45B. Mid-zone spurs distinct, markedly tapering.
- 47A. Mid-zone cells covered with many round warts, pads scarcely distinct.....*Silene cerastoides*.
- 47B. Mid-zone cells covered with many inconspicuous and a few conspicuous warts; pads distinct with elongate or elliptic cells.
- 48A. Seed broad-reniform ± 0.9 mm long, ± 0.5 mm wide, lateral faces cavity ± 0.57 mm long, ± 0.43 mm wide, mid-zone cells 40-185 μm long, pads cells rising up into conical papillae.....*Silene rubella*.
- 48B. Seed round-reniform ± 0.8 mm long, ± 0.4 mm wide, lateral face cavity ± 0.44 mm long, ± 0.25 mm wide, mid-zone cells 41-119 μm long, pads cells smooth without papillae.....*Silene nocturna*.
- 44B. Lateral faces plane or slightly concave.
- 49A. Seeds with large undulate wings.
- 50A. Mid-zone cells with 1 to several warts on each.
- 51A. Mid-zone area cells nearest the hilar notch with only one wart each.....*Silene apetala*. Morphotype A.
- 51B. Mid-zone cells with more than one papilla or wart on each.
- 52A. Mid-zone cells with an elongate papillae and small warts, which can be acute, conical or blunt.....*Silene apetala* Morphotype C.
- 52B. Mid-zone cells with irregular round or blunt warts*Silene apetala* Morphotype B.
- 52C. Mid-zone cells with warts mostly arranged in rows*Silene vivianii*.

- 50B. Mid-zone cells smooth or rarely with blunt warts.
- 53A. All mid-zone cells with distinct margins and blunt or sharp spurs.....*Silene colorata* var.*lasicalyx*.
- 53B. Mid-zone cell margins straight or slightly undulate.
- 54A. Cells of wings distinct and clearly in 3 regular rows.....
.....*Silene cyrenaica*.
- 54B. Cells of wings less distinct and not clearly in rows.
- 55A. Mid-zone cells narrow, c. 14 μm wide.....*Silene articulata*.
- 55B. Mid-zone cells narrow, c. 8 μm wide.....
.....*Silene colorata* subsp.*colorata*.
- 49B. Seeds without wings.
- 56A. Seeds triangular-reniform.
- 57A. Seeds > 2 mm long, lateral and marginal face cells raised into long papillae and tubercles, spurs indistinct....*Agrostemma githago*.
- 57B. Seeds < 1 mm long, lateral and marginal face cells raised into blunt papillae and tubercles, spurs regular spaced or cogwheel like sharp apex.....*Sagina maritima*.
- 56B. Seeds elongate-reniform or round.
- 58A. Seeds elongate-reniform, lateral face cells few ± 30
.....*Sagina apetala*.
- 58B. Seeds round-reniform, lateral face cells many.
- 59A. Lateral faces \pm plane, marginal face \pm concave.
- 60A. Lateral face cells rising up into distinct globular or elongate papillae.
- 61A. Lateral face cells raised into uniform, globular papillae, arranged in concentric rows*Silene behen*.
- 61B. Lateral face cells raised into irregularly shaped, even elongate papillae, one or two papillae per cell not clearly concentric
.....*Silene italica*.

- 60B. Lateral faces plane, with cells lacking papillae (or only a few inconspicuous papillae) .
- 62A. Lateral face cells smooth or slightly wrinkled (lacking distinct granules).....*Silene marmarica*.
- 62B. Lateral face cells distinctly granular.
- 63A. Seeds < 1 mm, spurs granular.....*Silene muscipula*.
- 63B. Seeds > 1mm, spurs smooth.....*Silene longipetala*.
- 59B. Lateral faces mostly convex, marginal faces not or slightly concave.
- 64A. Lateral face cells raised into regularly arranged papillae or warts.
- 65A. One wart, always situated at one apex, only three pad cells, flat.....
.....*Silene sedoides*.
- 65B. One papilla, large and globular, arranged in the middle of each cell, pads large and with many cells*Silene vulgaris*.
- 64B. Lateral face cells lacking clearly defined papillae..
- 66A. Lateral face cells mixed ovate, elliptic or round, spurs lacking, pad cells similar to mid-zone cells.....*Silene villosa*.
- 66B. Lateral face cells elliptic, elongate or rarely ovate, spurs normal with sharp apices, pad cells plane or globular different from the other mid-zone cells.
- 67A. Pads globular, mid-zone cells broad-elliptic or ovate.....
.....*Silene conoidea*.
- 67B. Pads plane, mid-zone cells narrow elliptic or elongate...*Silene fuscata*.
- 43B. Radicle longer than cotyledons slightly or strongly curved.
- 68A. Marginal face raised into long conical tubercles.
- 69A. Lateral face cells stelliform, with long spurs each bearing 1-4 warts.....*Stellaria media*.
- 69B. Not so.
- 70A. Lateral face concave.....*Gypsophila pilosa*.

70B. Lateral face plane or slightly convex .

71A. Seed size > 1mm.*Gypsophila elegans*.

71B. Seed size < 1mm.....*Arenaria leptoclados* (Davis 50344).

68B. Marginal faces raised into short blunt tubercles.

71A. Several lateral face, particularly midzone, cells broad, some almost
isodiametric.....*Arenaria serpyllifolia*.

71B. Lateral face, including mid-zone, cells all \pm elongate, 3 or more as
long as wide.....*Arenaria leptoclados*.

Appendix IV. An artificial key to Libyan species of *Silene* using fruiting plants. Only one species, *Silene biappendiculata*, was omitted; there was no ripe capsule.

- 1A. Calyx 10 veined.
- 2A. Capsule epidermal cells not papillate.
- 3A. Calyx (6-7) mm long; carpophore \pm 1mm long.....*S. sedoides*
- 3B. Calyx (15-27) mm long; carpophore (5-10) mm long.
- 4A. Calyx (15-20) mm long.
- 5A. Testa cells faint.....*S. succulenta*
- 5B. Testa cells with distinctive papillae.
- 6A. Seed size \pm .8 mm long..... *S. villosa*
- 6B. Seed size \pm 1.4 mm long.....*S. fruticosa*
- 4B. Calyx (23-27) mm long.....*S. marmarica*
- 2B. Capsule epidermal cells papillate.
- 7A. Capsule epidermal cells papillae mostly scattered
irregularly.
- 8A. Seeds not winged.
- 9A. Seeds slightly slanted near midzone; carpophore (5-7)
mm long.....*S. fuscata*
- 9B. Seeds deeply grooved near midzone; carpophore (2-3.5)
mm long.....*S. rubella*
- 8B. Seeds winged.
- 10A. Testa cells covered with papillae near midzone;

- carpophore \pm 1.5 mm long.....*S. apetala*
- 10B. Testa cells lacking papillae near midzone;
carpophore \pm (3-9) mm long
- 11A. Carpophore 3mm or less long.....*S. articulata*
- 11B. Carpophore more than 4 mm long.
- 12A. Calyx appressed hairy throughout; seeds \pm 1.2 mm long.....
.....*S. cyrenaica*
- 12B. Calyx appressed hairy on nerves alone; seeds \pm 1.5 mm long..
.....*S. colorata*
- 7B. Capsule epidermal cells mostly arranged in rows.
- 13A. Capsule epidermal cells walls distinctive or faint, papillae
closely spaced or fused in lines.
- 14A. Seeds slightly slanted, 3-4 regular rows of acute conical
papillae.....*S. behen*
- 14B. Seeds plane or slightly slanted, papillae mostly irregular.
- 15A. Seed epidermal cells narrow elongate, raising into many
small warts, spurs blunt.....*S. viviani*
- 15B. Seed epidermal cells elongate or elliptic, raising into few
papillae or warts, spurs acute.
- 16A. Seed size 1-1.5 mm long.....*S. italica*
- 16B. Seed size 1.8-2.2 mm long*S. longipetala*
- 13B. Capsule epidermal cells walls distinctive, papillae arranged
on thick ridge.
- 17A. Calyx contracted with capsule in fruit.

- 18A. Calyx apically contracted teeth acuminate or linear 4-5
mm long; carpophore 1-2 mm long.....*S. tridentata*
- 18B. Calyx contracted both above and below capsule, teeth
linear-lanceolate acute teeth, 3-3.5 mm long, carpophore
2-4 mm long.....*S. cerastioides*
- 17B. Calyx not contracted with capsule in fruit.
- 19A. Seed lateral faces plane or slightly slanted.....*S. muscipula*
- 19B. Seed lateral faces deeply grooved.
- 20A. Seeds brown, lateral face cells with many blunt or distinct
warts, marginal face grooved.....*S. nocturna*
- 20B. Seeds dark brown to black, lateral face cells raised into 2-
3 distinct warts, marginal face plane or slightly shallow
.....*S. gallica*
- 1B. Calyx 15-30 veined.
- 21A. Calyx \pm 15-20 veined, glabrous; capsule with wide neck,
capsule epidermal cells very variable in shape.....
.....*S. vulgaris*
- 21B. Calyx \pm 30 veined, glandular hairy; capsule with long narrow
neck, capsule epidermal cells constant in shape.....
.....*S. conoidea*

Appendix IV. An artificial key for the identification of the subgenera, sections and series of the genera *Arenaria*, *Moehringia* and *Minuartia* has been constructed using the crystal shape and distribution.

1A. Leaves without crystals, or very rare in small groups, scattered irregularly throughout the leaves.

Arenaria

VIII. Subgenus **Dolophragma** (*A. denissima*, *A. oreophila*,
A. polytrichioides)

IX. Subgenus **Solitaria** (*A. ciliolata*, *A. forrestii*)

1B. Leaves with crystals few, dense or very dense, scattered irregularly or regularly in rows throughout intercostal and veins or just on veins.

2A. Crystals scattered irregularly throughout the leaf except veins.

3A. Druses with sharp points. [see 3B and 3C]

Genus ***Arenaria***.

I. Subgenus **Leiosperma** (*A. alsinoides*, *A. guatemalensis*,
A. lanuginosa, *A. reptans*).

II. Subgenus **Dicranilla** (*A. pycnophylla*).

IV. Subgenus ***Arenaria***

A. Sectio **Rariflorae** (*A. ciliata*, *A. humifusa*, *A. pseudofrigida*).

B. Sectio **Grandiflorae** (*A. grandiflora*, *A. incrassata*).

C. Sectio **Plinthine** (*A. lithops*, *A. tetraquetra*).

D. Sectio **Rotudifoliae** (*A. halacsyi*).

E. Sectio **Planosepalae** (*A. montana*).

F. Sectio **Orientales**

F. (ii) Series **Graecae** (*A. filicaulis*, *A. teddi*)

F. (iii). Series **Deflexae** (*A. deflexa*).

F. (iv). Series **Hispidae** (*A. retusa*, *A. rhodia*)

G. Sectio **Pseudosabulina** (*A. sabulina*).

J. Sectio **Africanae**

J. (i). Series **Africanae**

J. (ii). Series **Papillospermae** (*A. hispanica*).

K. Sectio **Arenaria**

K. (i). Series **Arenaria** (*A. conferta*, *A. leptoclados*, *A. serpyllifolia*).

K. (ii). Series **Saponarioides** (*A. saponarioides*).

K. (iii). Series **Cylindricae** (*A. guicciardi*).

V. Subgenus **Arenariastrum** (*A. gouffeia*).

X. Subgenus **Odontostemma** (*A. trichophora*, *A. napuligera*,
A. yunnanensis).

Moehringia

B. Sectio **Latifolae** (*M. trinervia*, *M. lateriflora*, *M. radiolata*).

C. Sectio **Diversifolia** (*M. diversifolia*, *M. jankae*, *M. pendula*).

D. Sectio **Moehringia** (*M. glaucovirens*).

Minuartia

IV. Subgenus **Minuartia**

A. Sectio **Spectabiles**

A. a. Subsectio **Spectabilies**

A. a. (i). Series **Laricinae** (*M. colochia*, *M. imbricata*,
M. inamoena).

A. b. Subsectio **Cherleria** (*M. sedoides*).

3B. Druses with blunt points.

Arenaria

I. Subgenus **Leiosperma** (*A. paludicola*).

II. Subgenus **Dicranilla** (*A. boliviana*).

IV. Subgenus *Arenaria***C. Sectio *Plinthine*** (*A. armerina*)**D. Sectio *Rotundifoliae*** (*A. biflora*).**H. Sectio *Occidentales*** (*A. conbricensis*, *A. ciliaris*).**VI. Subgenus *Eremogoneastrum*** (*A. franklinii*, *A. hookeri*,
A. festucoides)***Moehringia*****A. Sectio. *Pseudomoehringia*** (*M. intricata*, *M. tejedensis*).**D. Sectio. *Moehringia*** (*M. muscosa*, *M. sedifolia*, *M. tommasinii*).***Minuartia*****II. Subgenus *Spergella*** (*M. formosa*, *M. picta*) in *M. picta* are
druses or elongate**III. Subgenus *Hymemella*** (*M. moehringioides*).**IV. Subgenus *Minuartia*****A. Sectio *Spectabiles*****A.a. (ii) Series *Spectabiles*** [New name Series ***Biflorae***](*M. arctica*, *M. biflora*, *M. obtusiloba*).**E. Sectio *Sclerophylla*** (*M. caroliniana*).**J. Sectio *Uninerviae*** (*M. brevifolia*, *M. glabra*, *M. groenlandica*,
M. patula).**3C. Druses with sharp and blunt points.*****Arenaria*****I. Subgenus *Leiosperma*** (*A. decussata*, *A. lanuginosa*).**IX. Subgenus *Solitaria*** (*A. ciliolata*).***Minuartia*****I. Subgenus *Rhodalsine*** (*M. geniculata*).**IV. Subgenus *Minuartia***

A. Sectio Spectabiles**A. C. Subsectio Laricifoliae****A. C. (i). Series Caucasicae (*M. aizoides*).**

2B. Crystals scattered throughout leaves including veins or just on veins.

4A. Crystals throughout leaves including veins.

5A. Druses, crystal sands but not elongate.

6A. Druses with sharp and blunt points.

Arenaria**VII. Subgenus Eremogone****H. Secto Pungentes (*A. pungens*).*****Minuartia*****IV. Subgenus Minuartia****A. Sectio Spectabiles****A. c. Subsectio Laricifoliae****A. c. (i). Series Caucasicae (*M. baldaccii*, *M. capillacea*,
M. laricifolia).**

6B. Druses with blunt points.

7A. Dense crystals near leaf base.

Arenaria**VII. Subgenus Eremogone****A. Sectio Capillares (*A. capillares*, *A. fendleri*, *A. lychnidea*).****F. Sectio Scariosae****F. (i). Series Polycnemifoliae (*A. polycnemifolia*, *A.*
pseudacantholimon, *A. zargariana*).****F. (ii). Series Scariosa (*A. armeniaca*, *A. scariosa*).****G. Sectio Sclerophyllae (*A. acerosa*, *A. aculeata*, *A. acutisepala*,
A. davisii, *A. drypidea*, *A. griffithii*, *A. insignis*, *A. kingii*,
A. ledebouriana)**

7B. No crystals near leaf base.

Arenaria

VII. Subgenus **Eremogone**

C. Sectio **Eremogone** (*A. steveniana*, *A. graminea*, *A. koriniana*, *A. macradenia*).

G. Sectio **Sclerophyllae** (*A. macradenia*, *A. persica*, *A. tetrasticha*)

5B. Druses, crystal sands and elongate.

Arenaria

VII. Subgenus **Eremogone**

D. Secto **Glomeriflorae** (*A. gypsophiloides*).

Minuartia

IV. Subgenus **Minuartia**

B. Sectio **Plurinerviae** (*M. recurva*).

C. Sectio **Lanceolatae**

C. (i). Series **Gramminifoliae** (*M. gramminifolia*, *M. saxifraga*, *M. stellate*).

C. (ii). Series **Dianthifolia** (*M. dianthifolia*, *M. acuminata*, *M. pestalozzae*).

C. (iii). Series **Lanceolatae** (*M. cerasitifolia*, *M. rupestris*).

E. Sectio **Sclerophylla** (*M. dawsonensis*).

F. Sectio **Acutiflorae**

F. (iii) Series **Umbelluliferae** (*M. umbellulifera*).

H. Sectio **Alsinathe** (*M. rossii*, *M. stricta*)

K. Sectio **Greniera** (*M. douglasii*, *M. howellii*).

L. Sectio **Minuartia**

L. a. (i). Series **Montanae** (*M. montana*, *M. globulosa*).

L. a. (ii). Series **Minuaria** (*M. dichotoma*, *M. hamata*).

L. b. Subsectio **Xeralsine**

L. b. (ii). Series **Setaceae** (*M. anatolica*, *M. confusa*, *M. mutabilis*)

L. b. (iii). Series **Xeralsine** (*M. fasciculata*, *M. funkii*).

L. b. (IV). Series **Campestres** (*M. campestris*).

M. Sectio Sabulina

M. (i). Series **Sabulina** (*M. mesogitana*, *M. tenella*, *M. urumiensis*).

M. (ii) Series **Californicae** (*M. californica*).

4B. Crystals in veins only.

8A. Crystals mostly round ovate with blunt points but not elongate.

VII. Subgenus **Eremogone**

E. Sectio **Rigidae**

E. (i). Series **Rigidae** (*A. holostea*, *A. szowitsii*).

Minuartia

IV. Subgenus **Minuartia**

D. Sectio **Aretioideae** (*M. aretioides*).

B. Sectio **Plurinerviae** (*M. bulgarica*, *M. hirsuta*).

F. Sectio **Acutiflorae**

F. (ii). Series **Pichleriae** (*M. rimarium*).

G. Sectio **Tryphane** (*M. rubella*).

8B. Crystals mixed, mostly elongate.

Arenaria

VII. Subgenus **Eremogone**.

D. Sectio **Glomeriflorae** (*A. dianthoides*, *A. cucubaloides*,
A. gypsophiloides).

Minuartia

F. Sectio **Acutiflorae**

F. (i). Series **Acutiflorae** [New name Series **Flaccidea**].

(*M. austriaca*, *M. flaccida*).

G. Sectio **Tryphane** (*M. verna*).

IV. Subgenus Minuartia.**M. Secto Sabulina****M. (i). Series Sabulina (*M. hybrida*, *M. mediterranea*).**