

AN ILLUSTRATED DIAGNOSTIC KEY TO SPECIES IN THE VENEZUELAN CLADE OF *ESPELETIA* (ASTERACEAE)

JESÚS MAVÁREZ^{1,2}

Abstract. An illustrated key is presented to species in the Venezuelan clade of *Espeletia* (Asteraceae), based on herbarium specimens, virtual herbaria, and fresh samples from field collections. The 54 *Espeletia* species in this clade are documented: (i) 48 entirely endemic to the Venezuelan Andes, (ii) 2 found as well in the Venezuelan Cordillera de la Costa, the eastern section of the Colombian Cordillera Oriental, and the Sierra Nevada de Santa Marta, and (iii) 4 endemic to the northern section of Colombian Cordillera Oriental and Sierra de Perijá. Schematic representations of leaves of all species are provided, including important diagnostic characters such as length-to-width ratios, and the shape, density, or angles of secondary nerves. Additional diagnostic characters are also described or illustrated for some species, such as the type of indumentum on leaves, the structure of the inflorescence, the size of the capitulum, and the color of ray ligules. The key has been shown to allow identification of species using both herbarium samples and fresh material, and given the predominant use of vegetative characters it is also useful on some monocarpic rosette species that are frequently found in the vegetative stage.

Keywords: Andes, Asteraceae, Cordillera de Mérida, *Espeletia*, frailejón, páramo, Venezuela

The plants in the genus *Espeletia* Mutis ex Bonpl. (Asteraceae; Humboldt and Bonpland, 1809) represent the best example of taxonomic, morphological, and ecological diversification in the tropical high-elevation grassland ecosystem of the Northern Andes known as páramo (Diazgranados, 2012; Cuatrecasas, 2013; Diazgranados and Barber, 2017; Pouchon et al., 2018; Mavárez, 2019). The genus evolved from a single ancestor quite recently, about 2.5 MYA (Pouchon et al., 2018), after the final uplift of the Northern Andes that facilitated environmental conditions for the páramo habitat (Hooghiemstra et al., 2006; Torres et al., 2013). The approximately 140 *Espeletia* species are distributed phylogenetically in two major groups (Diazgranados and Barber, 2017; Pouchon et al., 2018; Mavárez, 2019): (i) a northeastern clade of 54 species, known as the “Venezuelan,” almost entirely restricted to the Venezuelan Cordillera de Mérida, with some species found in the Venezuelan Cordillera de la Costa, the northern section of the Colombian Cordillera Oriental, the Sierra de Perijá, and the Sierra Nevada de Santa Marta, and (ii) a southwestern clade of about 80 species, known as the “Colombian,” distributed across the Colombian Andes, the Sierra de Perijá, and northern Ecuador. The Venezuelan clade is morphologically more diverse, since it includes shrubs and unbranched, dichotomous, or profusely branched trees, and also monocarpic and polycarpic rosettes that can be sessile, short-branched, or unbranched. The Colombian clade is composed exclusively of polycarpic rosettes, almost all of them unbranched, with the exception of one species that always is profusely branched (Mavárez and Becerra, 2019) and two that can occasionally be sparsely branched (Cuatrecasas, 1996).

The identification of *Espeletia* species can sometimes be

a real challenge, most particularly when attempted directly in the field. An important number of taxa are indeed very similar morphologically, differing mainly on quantitative traits associated with the shape and size of leaves, inflorescences, and capitula. On the other hand, sympatry is also particularly common among members of this genus, and it is not unusual to find several species living near each other in some locations, as for instance in Sierra de la Culata, Venezuela, where up to 11 rosette species can be found in close sympatry (Mavárez, pers. obs.). Furthermore, interspecific hybridization can be relatively frequent between certain species pairs, contributing thereby to the morphological variation observed within some taxa (Berry et al., 1988; Pouchon et al., 2018; Mavárez, 2019). Researchers studying *Espeletia* are therefore often confronted with situations in which groups of morphologically similar and closely related species in this genus coexist in sympatry and, in some cases, hybridize. This identification challenge can be especially difficult in Venezuela, where about half of the rosette species are monocarpic, spending many years in a vegetative state before flowering for a few days or weeks, after which they die. The identification of these taxa must often rely on vegetative traits of the rosettes, yet available identification keys for these plants usually depend strongly on reproductive traits (Cuatrecasas, 1996, 2013).

In this work I present an illustrated diagnostic key for the 54 species in the Venezuelan clade of *Espeletia* (Mavárez, 2019), leaving the analysis of the species in the Colombian clade for another work to be presented in the near future. The key is mainly aimed at the identification of live plants directly in the field, but several of the diagnostic traits used can also be retrieved from dry samples, so that the key may be used to identify herbarium specimens as well.

I am very grateful to Angel Fernández, director of the Herbarium of the Instituto Venezolano de Investigaciones Científicas, and Serge Aubert (1966–2015), director of Station Alpine Joseph Fourier (France), who provided invaluable assistance in the field during the numerous trips we made to the páramos of Venezuela. They participated actively in most of the tests of key performance on living plants. Unfortunately, Serge passed away too soon to see this work finished. I am also grateful for the help provided during fieldwork by Benito Briceño, Gilberto Morillo, John Parra, Luis “Kicke” Gámez, Reina Gonto, Sébastien Lavergne, Susana González, and Thibaud Syre. Logistic support was provided by the Centro de Investigaciones de Astronomía (CIDA), Dirección Regional Inparques Mérida, and Teleférico Mukumbarí. I am also grateful to the staff of IVIC for the support provided for this work and for the tests of key performance of dry samples. Université Grenoble Alpes and the CNRS provided funding (PEPS and OSUG grants).

¹Laboratoire d'Écologie Alpine, UMR UGA-USMB-CNRS 5553 Université Grenoble Alpes, 38000 Grenoble, France.

²Address for correspondence: LECA, BP 53, 2233 rue de la Piscine, 38041 Grenoble Cedex 9, France; jesus.mavarez@univ-grenoble-alpes.fr

MATERIALS AND METHODS

Samples

The key is based on the analysis of 2,264 samples reliably identified to the species level: 1,450 samples deposited in herbaria B, BC, BR, COL, F, G, GH, HAL, IVIC, K, LD, MER, MERF, MO, MY, NY, P, S, U, US, and W (Thiers, continuously updated), and 814 plants identified during fieldwork by the author and some colleagues (250 of which are now deposited at herbarium IVIC). These samples include all 54 species currently known to belong to the Venezuelan clade of *Espeletia* and 13 interspecific hybrid taxa that have received binomials in the past (Mavárez, 2019). However, hybrid taxa will not be treated in this key.

Morphological Characters

The key uses interspecific variation observed in several diagnostic macroscopic morphological attributes of the plants' stems, leaves, inflorescences, and capitula, all of which can be easily measured on both living plants and herbarium samples without need for complex equipment:

Growth form. Habitus (tree or rosette), type of stem branching (branched or unbranched, monopodial or sympodial), stem size and aspect (naked or covered by marcescent leaves).

Leaf. Sheath type (open or closed) and shape, pubescence on sheaths (present or absent). Lamina type (sessile or pseudopetiolate), shape (linear, lanceolate, oblong, etc.), length, width, length-to-width ratio, type of adaxial pubescence (absent, sericeous, lanuginous, etc.). Pseudopetiole length. Angle and density of secondary nerves.

Inflorescence. Position (lateral or terminal), structure (simple or compound), organization of main branches (monochasial or dichasial), axis length, number and distribution of bracts in the vegetative section.

Capitulum. Diameters of capitulum, ligular circle, and disc, number or proportion of ray and disc flowers, length and color of ray corollas, shape and texture of sterile phyllaries.

Almost all living plants were correctly identified with this key. The few failures corresponded to some juvenile or sterile individuals with no remnants of past reproduction events, which did not allow the determination of diagnostic traits such as the position and structure of the inflorescence or the size of the capitula. This occasional difficulty did not prevent the correct identification of any species, since in all populations evaluated there were always individuals with inflorescences and capitula from on-going or past reproduction events. However, fertile individuals can be relatively rare in certain monocarpic species, for example, fewer than 1% in *Espeletia jabonensis* or *E. paltonioides*

Key Testing

The key was tested blindly, that is, without the user's knowing the identity of the individual beforehand, on living plants of the *Espeletia* species shown in Fig. 1. Whenever possible, the key was tested on adult individuals that were in reproduction at the moment of the test or that held remnants of past reproduction events (dry inflorescences with attached capitula). However, tests of key performance were also tried in juvenile/sterile individuals when fertile ones were exceedingly rare in the population assayed.

The key was also tested on herbarium samples of the following species: *Espeletia albarregensis* (Cuatrec.) Mavárez, *E. angustifolia* Cuatrec., *E. arborea* Aristeg., *E. aristeguietana* Cuatrec., *E. atropurpurea* A.C. Sm., *E. badilloi* Cuatrec., *E. banksiifolia* Sch. Bip. & Etingsh. ex Wedd., *E. batata* Cuatrec., *E. bracteosa* Standl., *E. bromelioides* Cuatrec., *E. chardonii* A.C. Sm., *E. cuatrecasii* Ruiz-Terán & López-Fig., *E. elongata* A.C. Sm., *E. figueirasii* Cuatrec., *E. floccosa* Standl., *E. griffinii* Ruiz-Terán & López-Fig., *E. grisea* Standl., *E. hanburyana* Cuatrec., *E. jabonensis* Cuatrec., *E. jahnii* Standl., *E. leucactina* Cuatrec., *E. lindenii* Sch. Bip. ex Wedd., *E. liscanoana* Cuatrec., *E. lopezpalacii* Ruiz-Terán & López-Fig., *E. lucida* Aristeg., *E. marcescens* S.F. Blake, *E. margarita* Cuatrec., *E. marthae* Cuatrec., *E. moritziana* Sch. Bip. ex Wedd., *E. nana* Cuatrec., *E. neriifolia* (Bonpl. ex Humb.) Sch. Bip. ex Wedd., *E. occulta* S.F. Blake, *E. paltonioides* Standl., *E. palustris* (Diazgr. & Morillo) Mavárez, *E. pannosa* Standl., *E. parvula* (Cuatrec.) Mavárez, *E. ruizii* Cuatrec., *E. schultzii* Wedd., *E. semiglobulata* Cuatrec., *E. spectabilis* Cuatrec., *E. spicata* Sch. Bip. ex Wedd., *E. tamana* Cuatrec., *E. tenorae* Aristeg., *E. thyriformis* A.C. Sm., *E. timotensis* Cuatrec., *E. trujillensis* Cuatrec., *E. ulotricha* Cuatrec., *E. vergarae* (Cuatrec. & López-Fig.) Mavárez, *E. viridis* Aristeg., and *E. weddellii* Sch. Bip. ex Wedd. Specimens of these species were collected by the author and colleagues and are now deposited at IVIC, where the identification tests were performed blindly by a group of staff members.

RESULTS

(Mavárez, pers. obs), probably as a consequence of a high degree of reproductive synchronization. The identification of individuals in this type of species was attempted using vegetative traits alone, with complete success.

The rate of correct identification for herbarium samples was also relatively high, about 90%. The failures occurred in some herbarium sheets in which diagnostic information, such as the description of the pubescence of sheaths, the position of the inflorescence, or the length and color of ray corollas, could not be retrieved from the specimens or their labels.

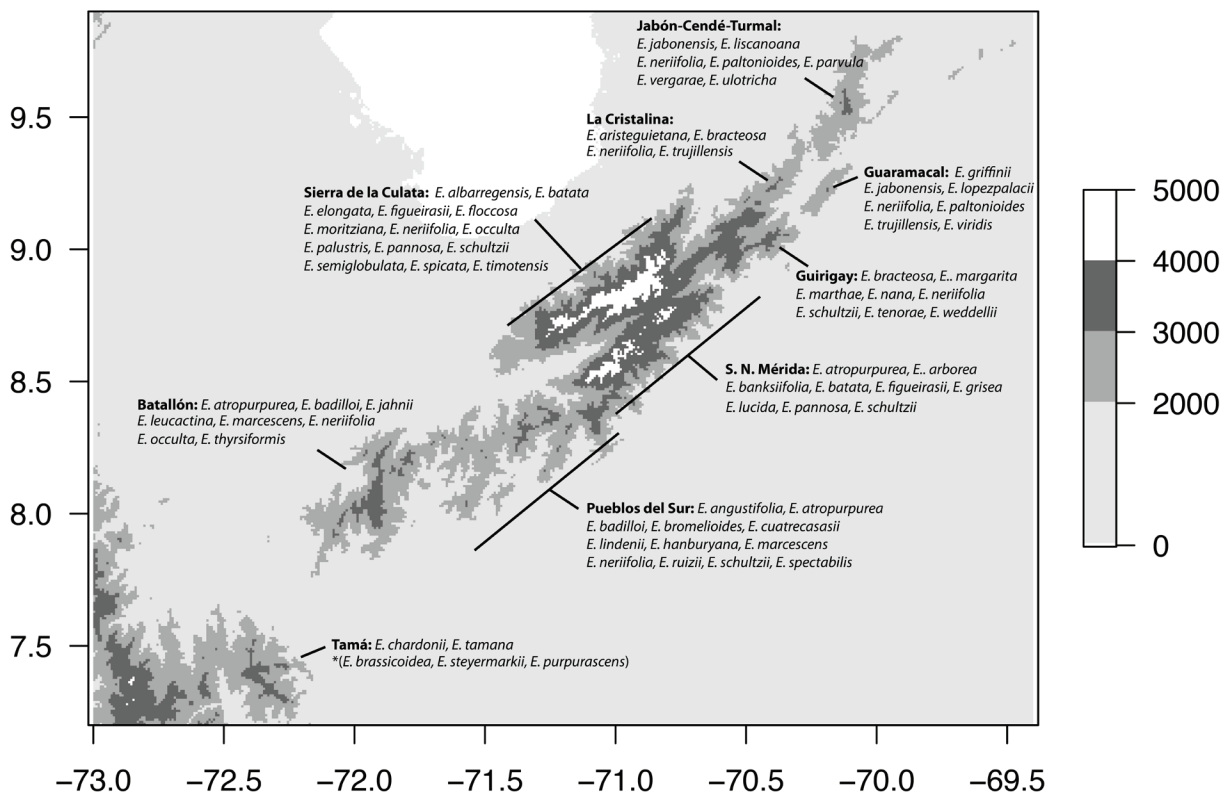

FIGURE 1. *Espeletia* species used for tests of key performance in living plants and their geographic locations (páramo names given in boldface). The three *Espeletia* species marked with (*) are found in Páramo de Tamá but do not belong to the Venezuelan *Espeletia* clade.

LITERATURE CITED

- BERRY, P., S. BEAUJON, AND R. N. CALVO. 1988. La hibridización en la evolución de los frailejones (*Espeletia*, Asteraceae). *Ecotropicos* 1: 11–24.
- CUATRECASAS, J. 1996. Clave provisional de las especies del género *Espeletia* Cuatrec. (Espeletiinae, Compositae). *Anal. Jard. Bot. Mad.* 54: 370–377.
- . 2013. A systematic study of the subtribe Espeletiinae (Heliantheae, Asteraceae). *Mem. New York Bot. Gard.* 107.
- DIAZGRANADOS, M. 2012. A nomenclator for the frailejones (Espeletiinae Cuatrec., Asteraceae). *PhytoKeys* 16: 1–52. doi: 10.3897/phytokeys.16.3186.
- DIAZGRANADOS, M., AND J. C. BARBER. 2017. Geography shapes the phylogeny of frailejones (Espeletiinae Cuatrec., Asteraceae): A remarkable example of recent rapid radiation in sky islands. *PeerJ* 5: e2968. doi:10.7717/peerj.2968.
- HOOGHIEMSTRA, H., V. M. WIJNINGA, AND A. M. CLEEF. 2006. The paleobotanical record of Colombia: Implications for biogeography and biodiversity. *Ann. Missour. Bot. Gard.* 93: 297–324.
- HUMBOLDT, A., AND A. BONPLAND. 1809[1808]. *Plantae Aequinoctiales* 2(9): 10. F. Schoell, Paris.
- MAVÁREZ, J. 2019. A taxonomic revision of *Espeletia* (Asteraceae). The Venezuelan radiation. *Harv. Pap. Bot.* 24(2): 131–244.
- MAVÁREZ, J., AND M. T. BECERRA. 2019. Taxonomic novelties in páramo plants. *Espeletia ramosa* (Asteraceae), a new species from Colombia. *Phytologia* 101(4): 222–230.
- POUCHON, C., A. FERNÁNDEZ, J. M. NASSAR, F. BOYER, S. AUBERT, S. LAVERGNE, AND J. MAVÁREZ. 2018. Diversification of the giant rosettes of the *Espeletia* complex (Asteraceae). A phylogenomic analysis of an explosive adaptive radiation in the Andes. *Syst. Biol.* 67: 1041–1060. doi: 10.1101/gr.074492.107.
- THIERS, B. (continuously updated). *Index Herbariorum*. A global directory of public herbaria and associated staff. New York Botanical Garden's Virtual Herbarium (accessed May 1, 2019). <http://sweetgum.nybg.org/science/ih/>.
- TORRES, V., H. HOOGHIEMSTRA, AND L. LOURENS. 2013. Astronomical tuning of long pollen records reveals the dynamic history of montane biomes and lake levels in the tropical high Andes during the Quaternary. *Quat. Sci. Rev.* 63: 59–72. doi: 10.1016/j.quascirev.2012.11.004.

AN ILLUSTRATED DIAGNOSTIC KEY TO SPECIES IN THE VENEZUELAN CLADE OF *ESPELETIA* (ASTERACEAE)

PLATES 1–7. Schematic representations of leaf outlines, inflorescences, and phyllaries of species in the Venezuelan *Espeletia* clade. Leaf sheaths not shown unless otherwise stated. Abbreviations: **r**, leaf length-to-width ratio; **Ø**, capitulum diameter; **LC**, ligular circle diameter; **disc**, disc diameter; **%RF**, proportion of ray flowers. All leaf and inflorescence drawings by J. Mavárez (LECA). Plant drawings of *E. atropurpurea* A.C. Sm., *E. chardonii* A.C. Sm., and *E. jahnii* Standl. by C. Perrier (SAJF).

- 1a. Trees 2
 1b. Rosettes 14
 2a. Inflorescence structure primarily dichasial and in lateral position with regard to branch axis 3 (plate 1A)
 2b. Inflorescence structure primarily monochasial and in terminal position with regard to branch axis 4
 3a. Leaves pseudo-petiolate. Vegetative part of the inflorescence ebracteate. *E. badilloi*
 3b. Leaves sessile. Vegetative part of the inflorescence with 1–2 pairs of opposite bracts *E. trujillensis*
 4a. Leaves sessile 5 (plate 1B)
 4b. Leaves pseudopetiolate 7 (plate 2)
 5a. Secondary nerves > 4 mm apart *E. liscanoana*
 5b. Secondary nerves < 4 mm apart 6
 6a. Leaf length > 15 cm *E. occulta*
 6b. Leaf length < 15 cm *E. parvula*
 7a. Stems sparsely branched, sympodial (pseudodichotomous). Sheaths open, semiamplectant. Ray corollas bright yellow *E. chardonii*
 7b. Stems profusely branched, monopodial. Sheaths either closed or open but entirely amplectant. Ray corollas eligulate or white, cream, pale-yellow 8
 8a. Secondary nerves > 4 mm apart *E. neriifolia*
 8b. Secondary nerves < 4 mm apart 9
 9a. Ray corollas eligulate *E. lucida*
 9b. Ray corollas ligulate 10
 10a. Small shrubs and trees, usually < 4 m high. Leaf length < 15 cm *E. griffinii*
 10b. Large trees, usually > 4 m high. Leaf length > 15 cm. 11
 11a. Sheaths adaxially barbate 12
 11b. Sheaths adaxially glabrous 13
 12a. Leaves with oblong outline (ratio 2–5:1) and dentate margins *E. banksiifolia*
 12b. Leaves with lanceolate outline (ratio 6–9:1) and entire margins *E. tamana*
 13a. Capitulum diam. > 12 mm. *E. arborea*
 13b. Capitulum diam. < 12 mm. *E. divisiorensis*
 14a. Terminal inflorescences (monocarpic rosettes) 15
 14b. Lateral inflorescences (polycarpic rosettes) 38
 15a. Leaves adaxially glabrous 16
 15b. Leaves adaxially pubescent 28
 16a. Sessile rosettes or with short-branched stems 17 (plate 3A)
 16b. Caulescent rosettes with unbranched stems 22 (plate 3B)
 17a. Leaves with oblong outline, pseudopetiolate or strongly attenuated near the base. 18
 17b. Leaves with linear or cuneiform outline 20
 18a. Leaves strongly attenuated toward the base but not distinctly pseudopetiolate. Ray corollas white *E. usubillagae*
 18b. Leaves distinctly pseudopetiolate. Ray corollas eligulate or yellow. 19
 19a. Rosettes occasionally branched with monopodial architecture. Ray corollas eligulate *E. atropurpurea*
 19b. Rosettes occasionally branched with sympodial architecture (usually < 4 rosettes per individual). Ray corollas yellow *E. bracteosa*
 20a. Rosettes almost invariably branched with sympodial architecture, usually profusely so (up to 10 rosettes per individual). Leaves with strictly linear outline (ratio > 50:1) and strongly revolute margins. Secondary nerves obsolete. Ray flowers eligulate *E. jahnii*
 20b. Rosettes occasionally branched. Leaves with linear-lanceolate or cuneiform outline (ratio < 50:1) and flat margins. 21

1A. Trees with dichasial inflorescences

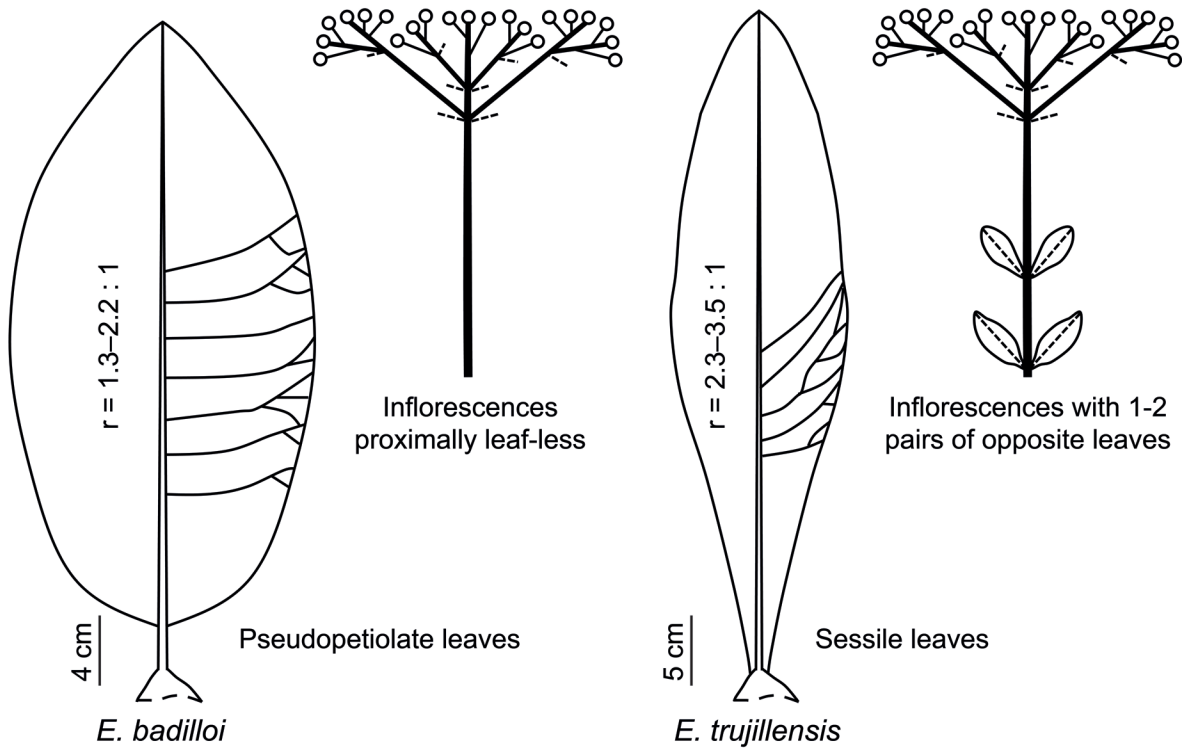

1B. Trees with monochasial inflorescences, sessile leaves

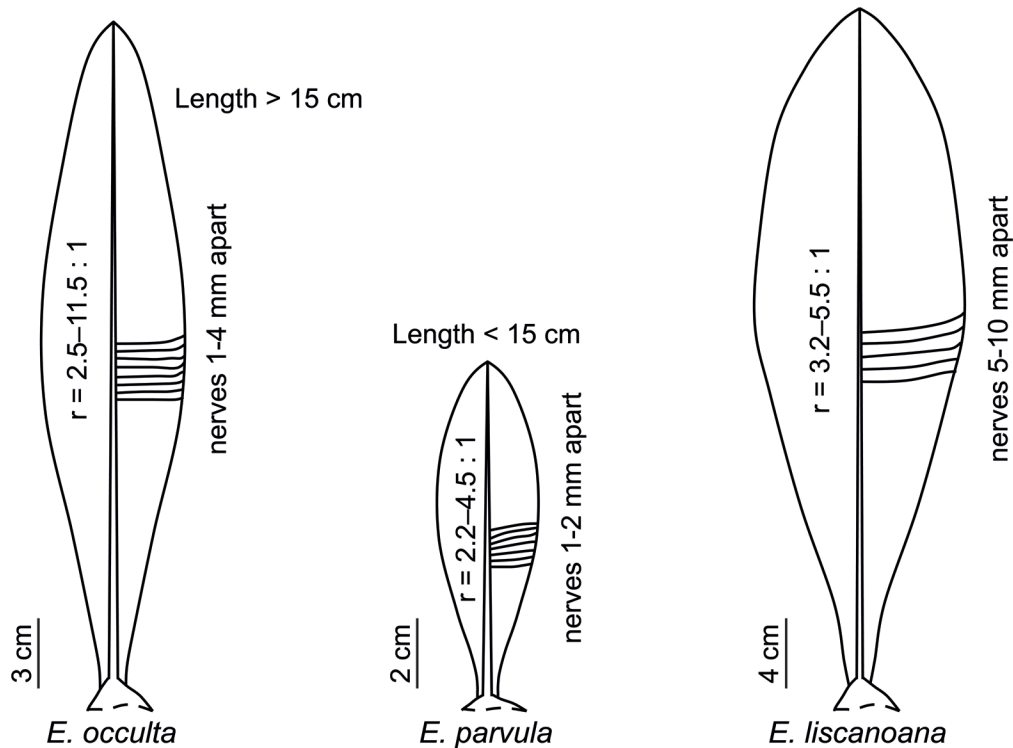

2. Trees with monochasial inflorescences, pseudopetiolate leaves

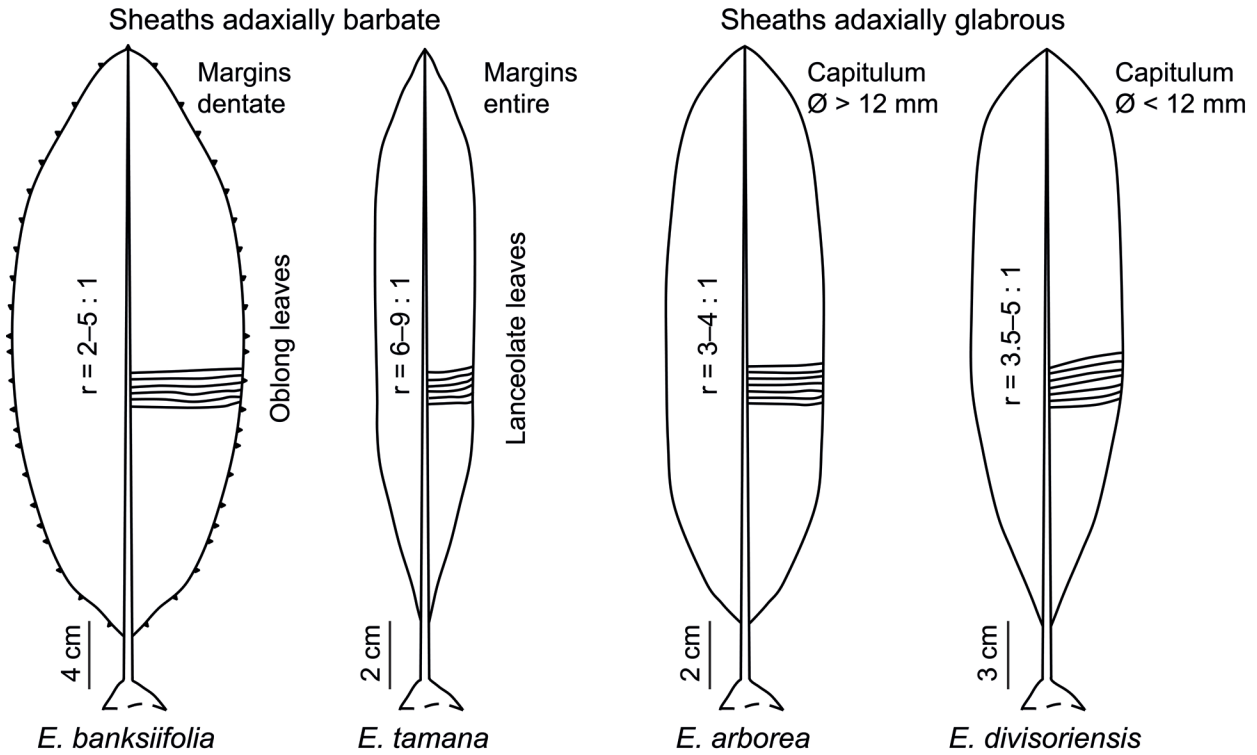
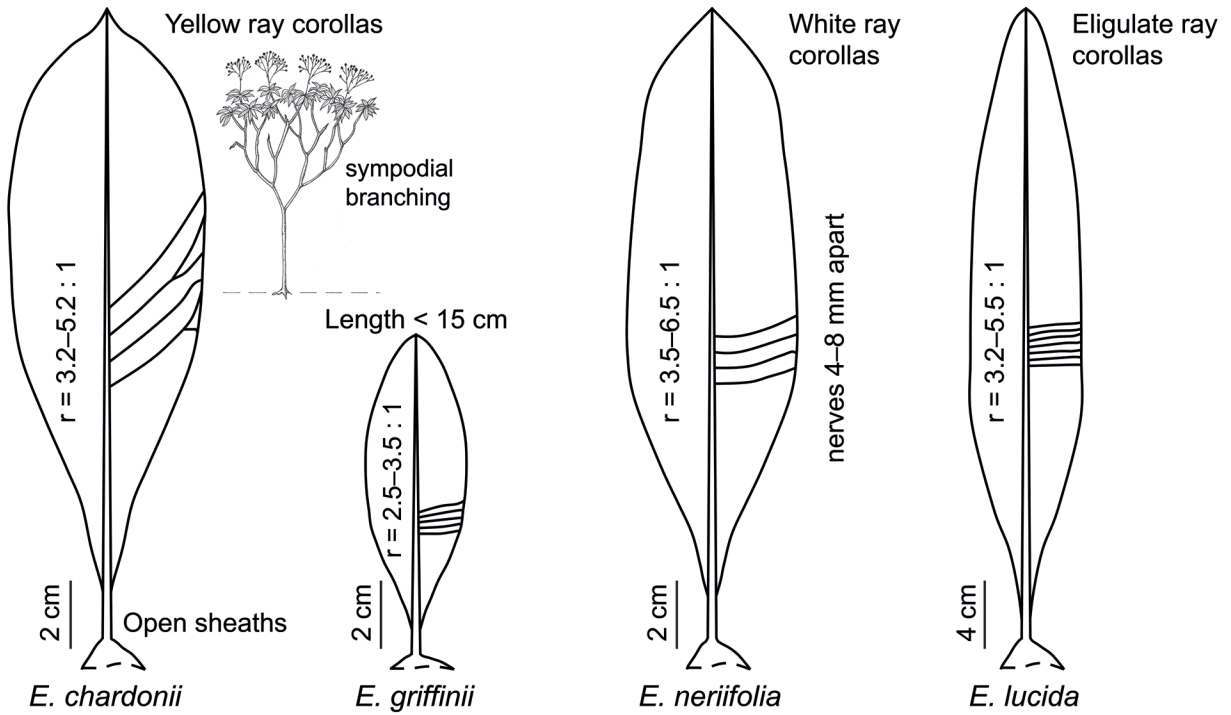

3A. Monocarpic rosettes, sessile or short-branched, adaxially glabrous leaves

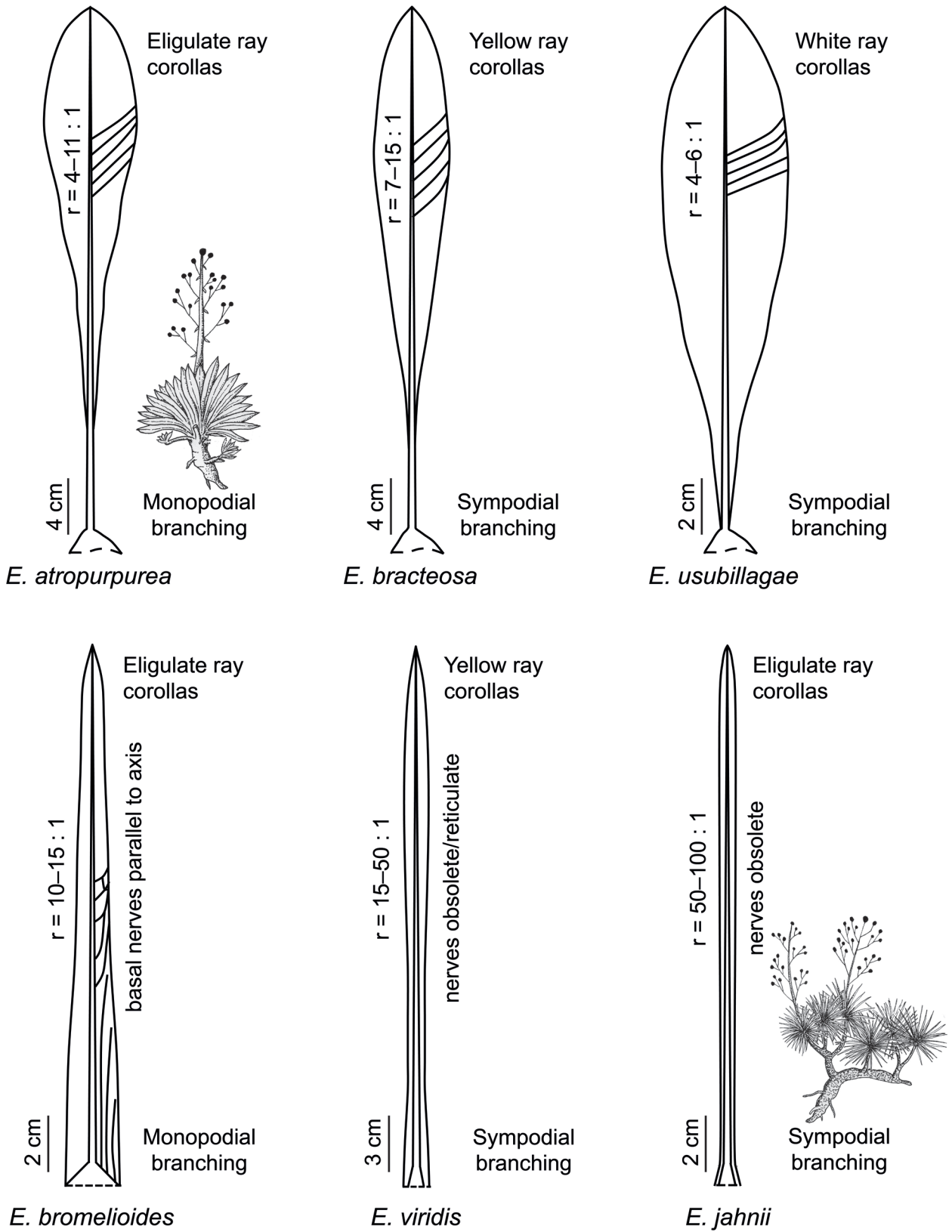

3B. Monocarpic unbranched caulescent rosettes, adaxially glabrous leaves

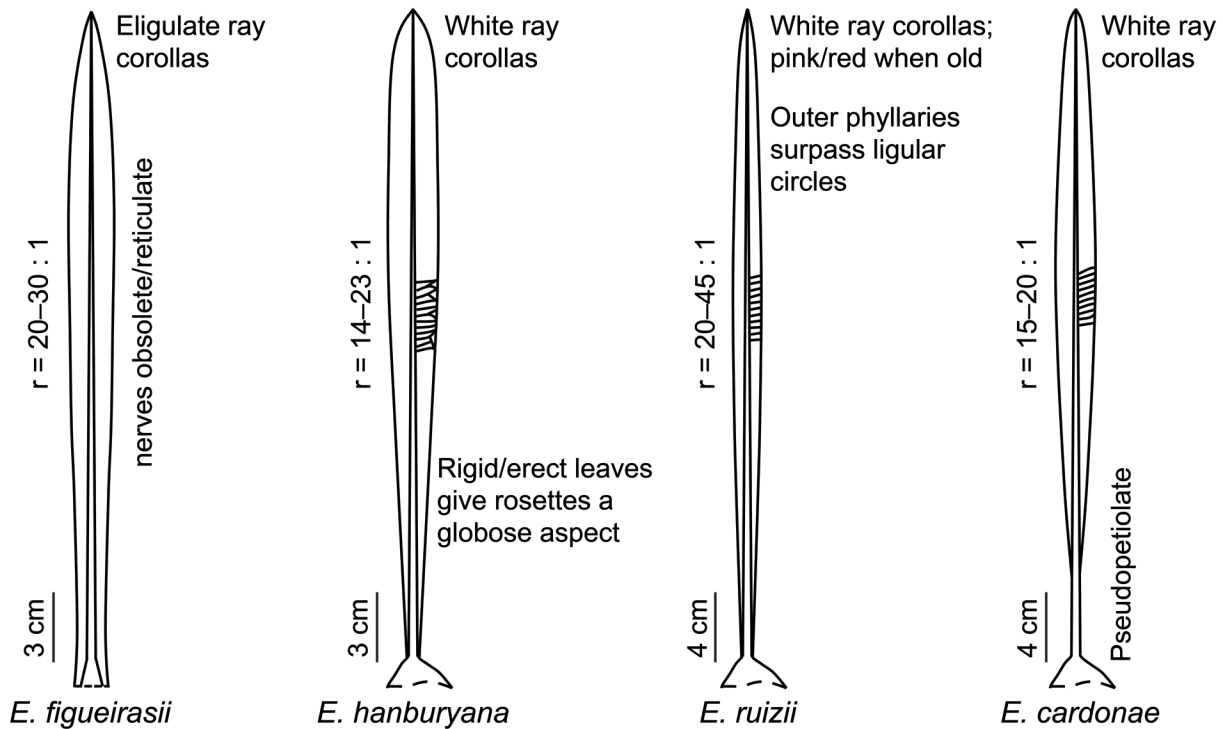
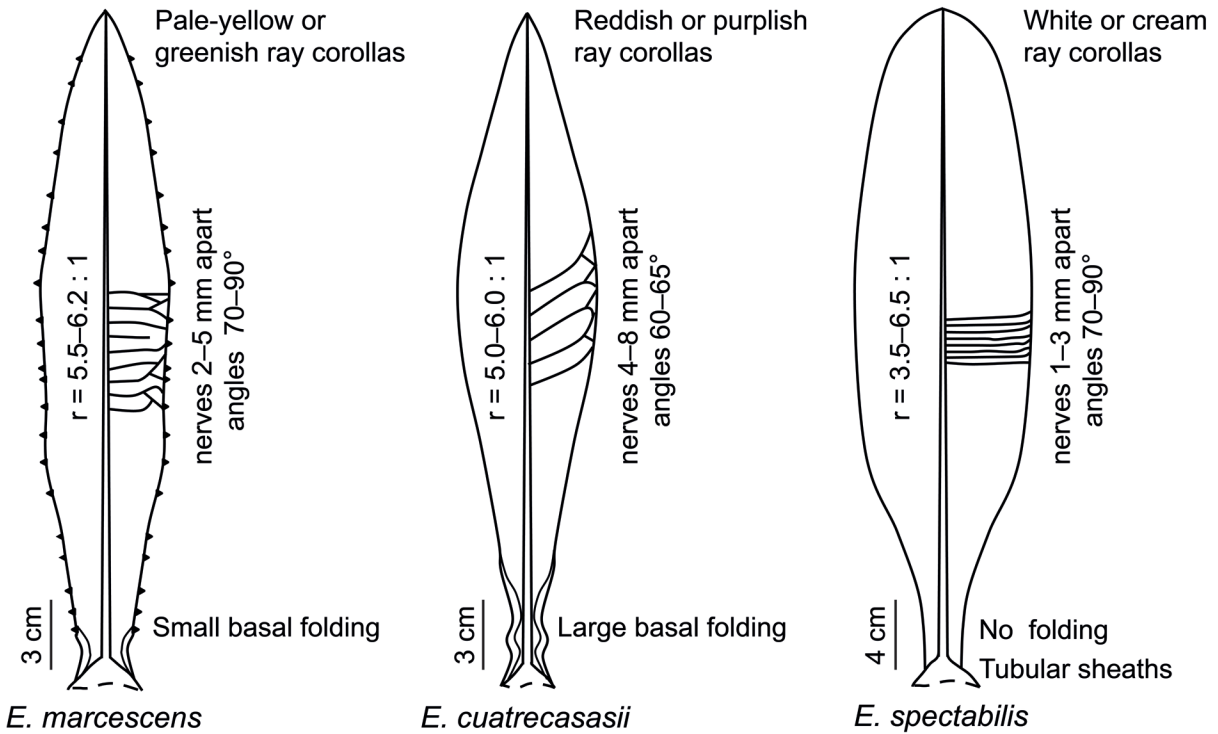

- 21a. Rosettes occasionally branched with sympodial architecture (usually < 3 rosettes per individual). Leaves with linear-lanceolate outline (ratio 15–50:1). Nerves reticulate or obsolete. Ray corollas yellow *E. viridis*
- 21b. Rosettes occasionally branched with monopodial architecture. Leaves with cuneiform outline (ratio < 10–15:1). Basal nerves parallel to axis. Ray corollas eligulate *E. bromelioides*
- 22a. Leaves with broadly oblong outline (ratio < 6.5:1) 23
- 22b. Leaves with linear or linear-lanceolate outline (ratio > 14:1) 25
- 23a. Tubular sheaths. Leaves with unfolded margins and obtuse apex, secondary nerves 1–3 mm apart, deviation angles 70–90° . . . *E. spectabilis*
- 23b. Open sheaths. Leaves with folded margins near the base and acute apex 24
- 24a. Leaves usually with small margin folding near the base, secondary nerves 2–5 mm apart, deviation angles 70–90°, capitulum diam. > 20 mm. Ray ligules pale-yellow or greenish *E. marcescens*
- 24b. Leaves usually with large margin folding near the base, secondary nerves 4–8 mm apart, deviation angles 60–65°, capitulum diam. < 18 mm. Ray corollas pinkish-reddish. *E. cuatrecasarii*
- 25a. Leaves rather flexible. Secondary nerves very thin, reticulate or obsolete. Ray corollas eligulate *E. figueirassii*
- 25b. Leaves rather rigid. Secondary nerves visible. Ray corollas ligulate, white or pinkish 26
- 26a. Leaves pseudopetiolate. Ray corollas white *E. cardonae*
- 26b. Leaves sessile 27
- 27a. Leaves with linear outline (ratio 20–45:1). Ray corollas white when young, turning pink-reddish when old. Tips of external phyllaries surpass the ligular circle *E. ruizii*
- 27b. Leaves with linear-lanceolate outline (ratio 14–23:1). Ray corollas white. Tips of external phyllaries do not surpass the ligular circle. *E. hanburyana*
- 28a. Sessile rosettes or with short stems 29 (plate 4A)
- 28b. Caulescent rosettes with unbranched stems 34 (plate 4B)
- 29a. Ray corollas white, cream, or pale-yellow 30
- 29b. Ray corollas yellow 32
- 30a. Leaves with oblong-oblong outline (ratio 7–9:1). Outer phyllaries broad, green, foliaceous, and reticulate *E. lindenii*
- 30b. Leaves with linear-lanceolate outline (ratio > 15:1). Outer phyllaries linear-triangular, pubescent. Ray corollas white. 31
- 31a. Leaves with linear outline (ratio 20–40:1), secondary nerves obsolete or scarce, deviation angles 20–30°. Length of ray corollas > 13 mm. *E. margarita*
- 31b. Leaves with linear-lanceolate outline (ratio 15–30:1), secondary nerves 1–3 mm apart, deviation angles 60–80°. Length of ray corollas < 10 mm. *E. leucactina*
- 32a. Sheaths rectangular and slightly broader than lamina. Leaves with linear outline (ratio 30–40:1), secondary nerves obsolete, silvery-sericeous indumentum. *E. jabonensis*
- 32b. Sheaths oblong and clearly broader than lamina. Leaves with linear-lanceolate outline (ratio < 20:1) 33
- 33a. Leaves with silvery-sericeous indumentum, secondary nerves obsolete or thin, 2–4 mm apart, deviation angles 25–50°. Ligular circles > 40 mm. *E. floccosa*
- 33b. Leaves with appressed-sericeous indumentum, secondary nerves 10–15 mm apart, deviation angles 15–30°. Ligular circles < 35 mm. *E. vergarae*
- 34a. Length of ray corollas > 8 mm 35
- 34b. Length of ray corollas < 8 mm 36
- 35a. Leaves pseudopetiolate, secondary nerves 5–8 mm apart, deviation angles 45–75°. Ray corollas yellow *E. emmanuelis*
- 35b. Leaves sessile, secondary nerves 2–4 mm apart, deviation angles 70–85°. Ray corollas white or pale-yellow, outer phyllaries broad, green, foliaceous, and reticulate *E. lindenii*
- 36a. Secondary nerves 1–3 mm apart, deviation angles 50–70°. Capitulum diam. > 12 mm, ligular circle > 15 mm *E. grisea*
- 36b. Secondary nerves > 4 mm apart, deviation angles < 40°. Capitulum diam. < 12 mm, ligular circle < 15 mm 37
- 37a. Stems covered with old leaves/sheaths, up to 1 m high. Capitulum radiate, ray corollas 4.5–6.5 mm long, ligules white *E. lopezpalacii*
- 37b. Stems mostly leafless, up to 10 m high. Capitulum short-radiate, ray corollas 2.0–3.5 mm long, ligules pale yellow *E. paltonioides*
- 38a. Inflorescences mono- or oligocephalous (< 5 capitula) 39 (plate 5)
- 38b. Inflorescences polycephalous (> 5 capitula) 46
- 39a. Large rosettes (leaf length > 25 cm) 40
- 39b. Small rosettes (leaf length < 15[–25] cm) 41

4A. Monocarpic rosettes, sessile or short-branched, adaxially pubescent leaves

White, cream or pale-yellow ray ligules

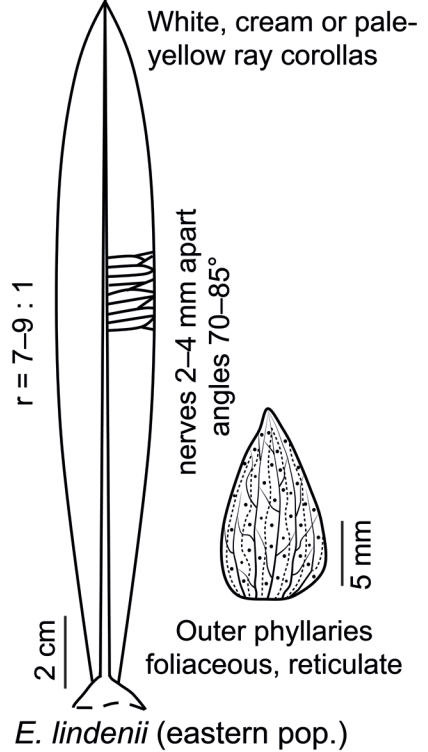
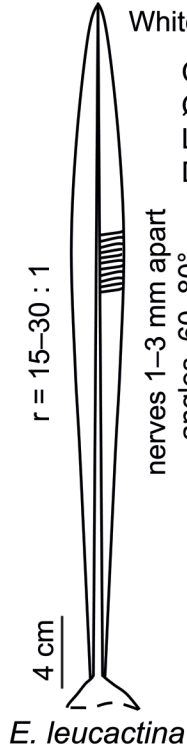
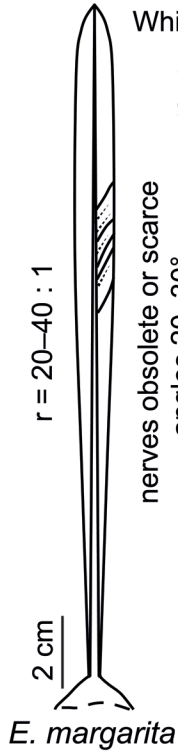

Yellow ray ligules

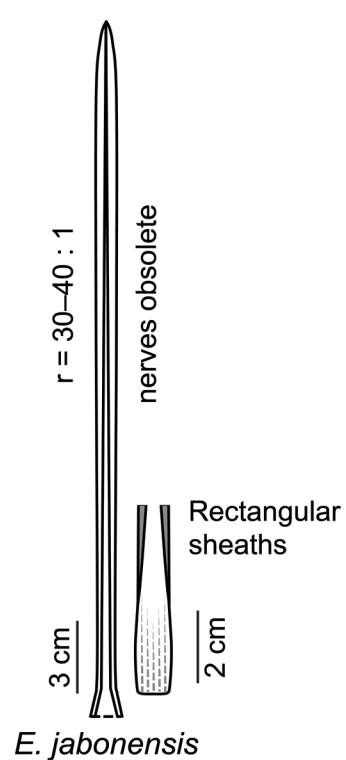
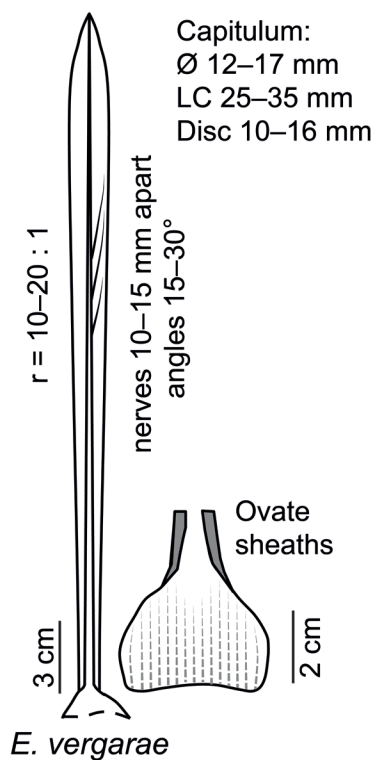
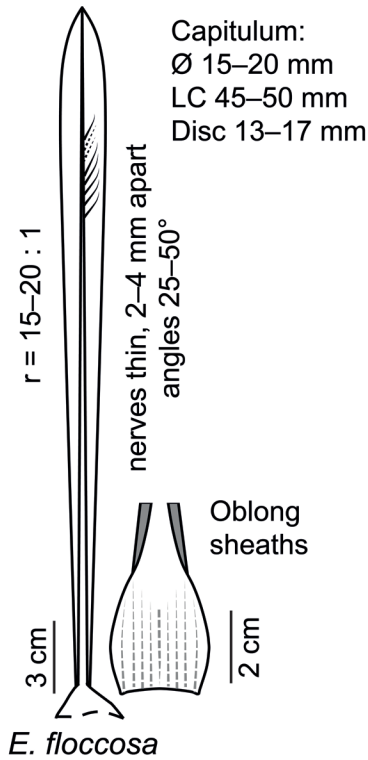

4B. Monocarpic unbranched caulescent rosettes, adaxially pubescent leaves

Ray corollas > 8 mm

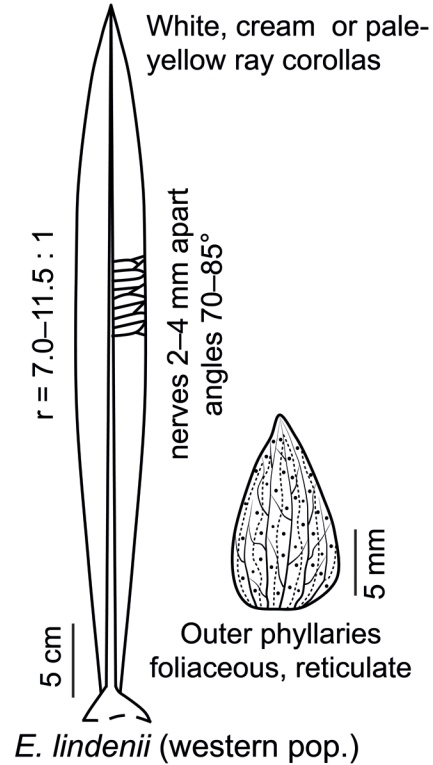
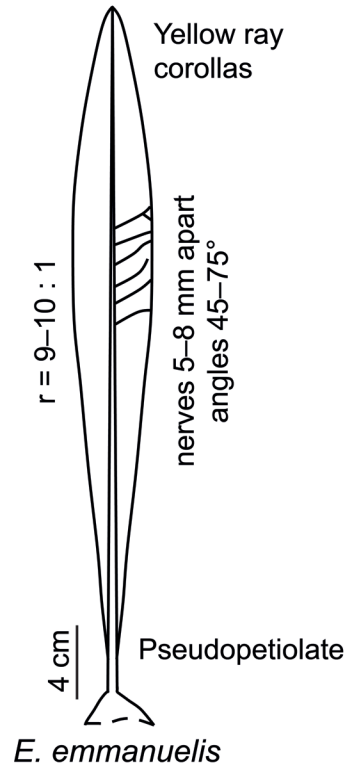

Ray corollas < 7 mm

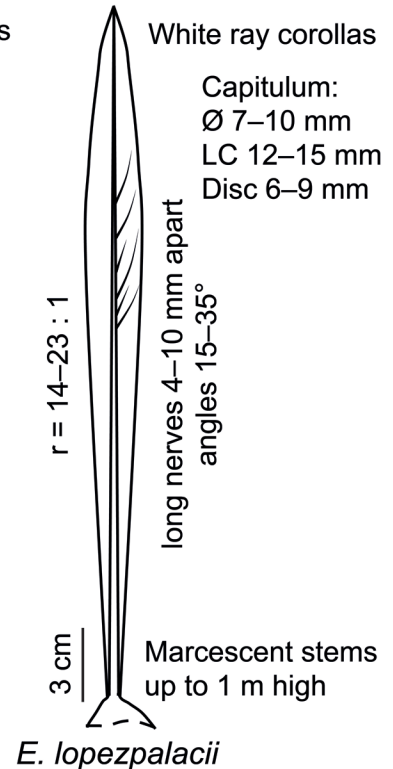
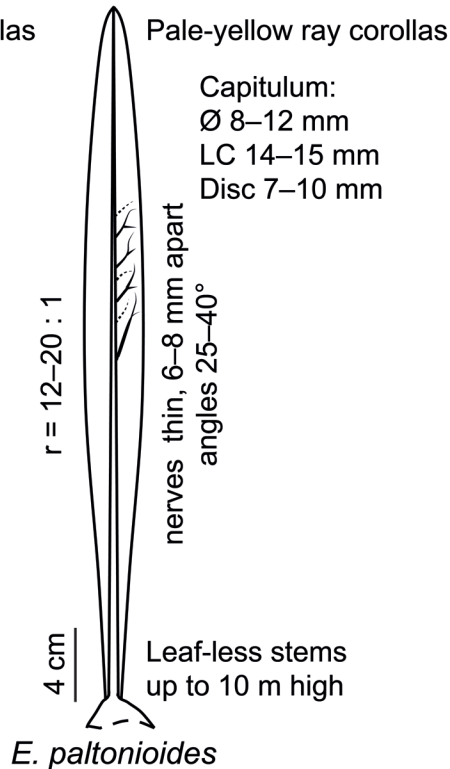
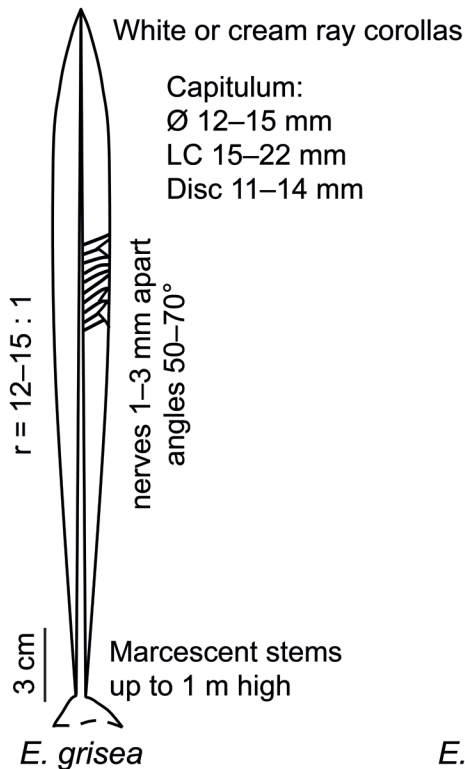

5. Polycarpic rosettes, mono- or oligocephalous inflorescences

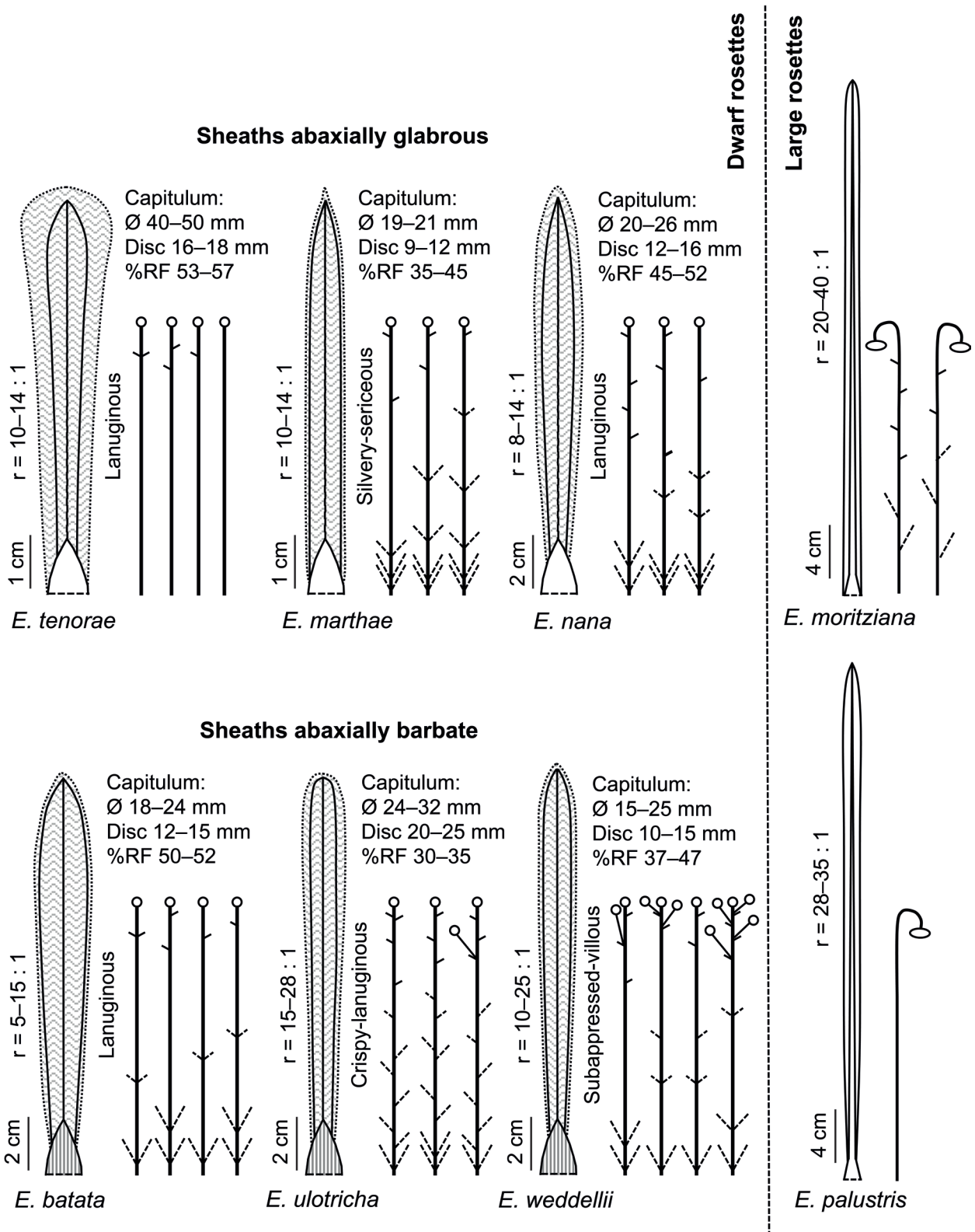

- 40a. Sheath length 5.0–7.0 cm, sheath width 0.9–2.2 cm. Leaves with yellowish–greenish indumentum. Inflorescences bracteate. Capitulum with 600–860 disc flowers and 400–740 ray flowers *E. moritziana*
- 40b. Sheath length 7.0–10.0 cm, sheath width 2.2–2.5 cm. Leaves with white indumentum. Inflorescences aphyllous. Capitulum with 215–280 disc flowers and 95–200 ray flowers *E. palustris*
- 41a. Sheaths abaxially glabrous 42
- 41b. Sheaths abaxially barbate... 44
- 42a. Leaves usually with cub-shaped outline and with lanuginous indumentum. Inflorescences frequently aphyllous, sometimes with 1–2 alternate or opposite bracts in the upper half. Capitulum densely pubescent, diam. 40–50 mm, ligular circle smaller than the involucre (diam. 20–30 mm), disc diam. 16–18 mm. Capitulum with 53–57% ray flowers *E. tenorae*
- 42b. Leaves with lanceolate or oblong-lanceolate outline and with silvery-sericeous or lanuginous indumentum. Inflorescences with 2 or more pairs of opposite bracts. Capitulum diam. < 30 mm, ligular circle larger than the involucre and with < 53% ray flowers 43
- 43a. Leaves with lanceolate outline and with silvery-sericeous indumentum. Inflorescences with 3–5 pairs of opposite bracts. Capitulum diam. 19–21 mm, ligular circle diam. 30–35 mm, disc diam. 16–18 mm. Capitulum with 35–45% ray flowers *E. marthae*
- 43b. Leaves with oblong-lanceolate outline and with lanuginous indumentum. Inflorescences with 2 pairs of opposite bracts. Capitulum diam. 20–26 mm, ligular circle diam. 24–35 mm, disc diam. 12–16 mm. Capitulum with 45–52% ray flowers *E. nana*
- 44a. Leaves with revolute margins, cylindrical outline, and crispy-lanuginous indumentum. Inflorescences frequently monocephalous, rarely with 2–3 capitula, also with 1–2 pairs of opposite bracts. Capitulum diam. 24–32 mm, ligular circle diam. 40–45 mm, disc diam. 20–25 mm. Capitulum with 30–35% ray flowers *E. ulotricha*
- 44b. Leaves with lanceolate or oblong-lanceolate outline and with lanuginous or villous indumentum. Capitulum diam. < 25 mm, ligular circle diam. < 40 mm, disc diam. < 15 mm. Capitulum with > 35% ray flowers 45
- 45a. Leaves with oblong-lanceolate outline and with lanuginous indumentum. Inflorescences with 2–3 pairs of opposite bracts. Capitulum diam. 18–24 mm, ligular circle diam. 30–40 mm, disc diam. 12–15 mm. Capitulum with 50–52% ray flowers *E. batata*
- 45b. Leaves with lanceolate outline and with subappressed villous indumentum. Inflorescences frequently with 2–5 capitula, rarely 1, also with 2 pairs of opposite bracts (rarely 1 or 3). Capitulum diam. 15–25 mm, ligular circle diam. 20–30 mm, disc diam. 10–15 mm. Capitulum with 37–47% ray flowers *E. weddellii*
- 46a. Capitula erect, ligular circles much larger than the involucre 47 (plate 6)
- 46b. Capitula dropping or nodding. Ligular circles usually smaller than the involucre, occasionally equal or slightly larger 50 (plate 7)
- 47a. Inflorescences monochasial, corymboid-paniculate. Ray corollas white 48
- 47b. Inflorescences dichasial, thyrsoïd. Ray corollas yellow 49
- 48a. Leaves with linear outline (ratio 30–40:1) and silvery-sericeous indumentum *E. pannosa*
- 48b. Leaves with linear-lanceolate outline (ratio 20–25:1) and lanuginous indumentum *E. angustifolia*
- 49a. Leaves with oblong outline (ratio 4.0–5.7:1) and green tomentose-velvety indumentum. Capitulum diam. 10–14 mm, ligular circle diam. 24–28 mm, disc diam. 10–11 mm *E. aristeguietana*
- 49b. Leaves with oblong outline (ratio 4.7–12.0:1) and whitish-grayish lanuginose indumentum. Capitulum diam. 20–30 mm, ligular circle diam. 30–50 mm, disc diam. 12–18 mm *E. schultzei*
- 50a. Inflorescences simple, monochasial (strict botryoid) 51
- 50b. Inflorescences compound (at least basal peduncles polycephalous), monochasial or dichasial 53
- 51a. Leaves with linear-lanceolate outline (ratio 20–35:1). Inflorescences with 14–38 monocephalous peduncles. Capitulum diam. 15–25 mm *E. spicata*
- 51b. Leaves with lanceolate outline (ratio < 20:1). Inflorescences with < 15 monocephalous peduncles. Capitulum diam. > 25 52
- 52a. Leaves with lanceolate outline (ratio 10–18:1). Inflorescences with 8–15 monocephalous peduncles. Capitulum diam. 35–55 mm *E. timotensis*
- 52b. Leaves with lanceolate outline (ratio 9–10:1). Inflorescences with 9–11 monocephalous peduncles. Capitulum diam. 35–55 mm *E. albarregensis*
- 53a. Leaves with oblong outline (ratio 4–10:1), sessile, with secondary nerves 5–10 mm apart. Inflorescences monochasial, with 17–35 peduncles, basal ones usually polycephalous (rarely monocephalous) *E. thyrsoïformis*
- 53b. Leaves with lanceolate outline (ratio 9–20:1), distinctly pseudopetiolate 54
- 54a. Secondary nerves 5–7 mm apart. Inflorescences monochasial, with 30–60 peduncles, basal one polycephalous *E. elongata*
- 54b. Secondary nerves 2–4 mm apart. Inflorescences dichasial, thyrsoïd *E. semiglobulata*

6. Polycarpic rosettes, polycephalous, ligular circles larger than involucre

Monochasial inflorescences, white ray corollas

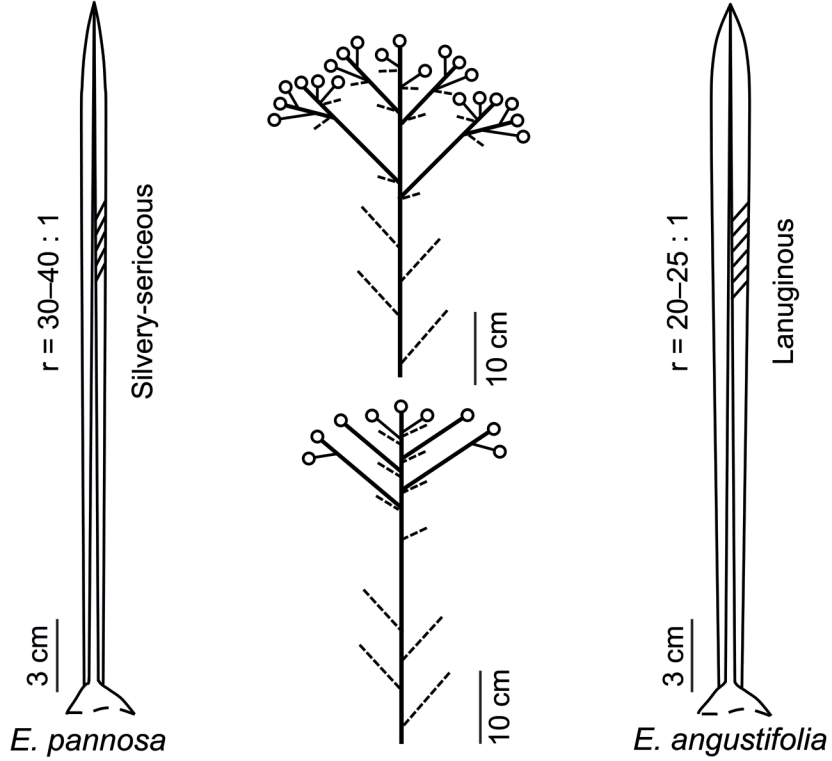

Dichasial inflorescences, yellow ray corollas

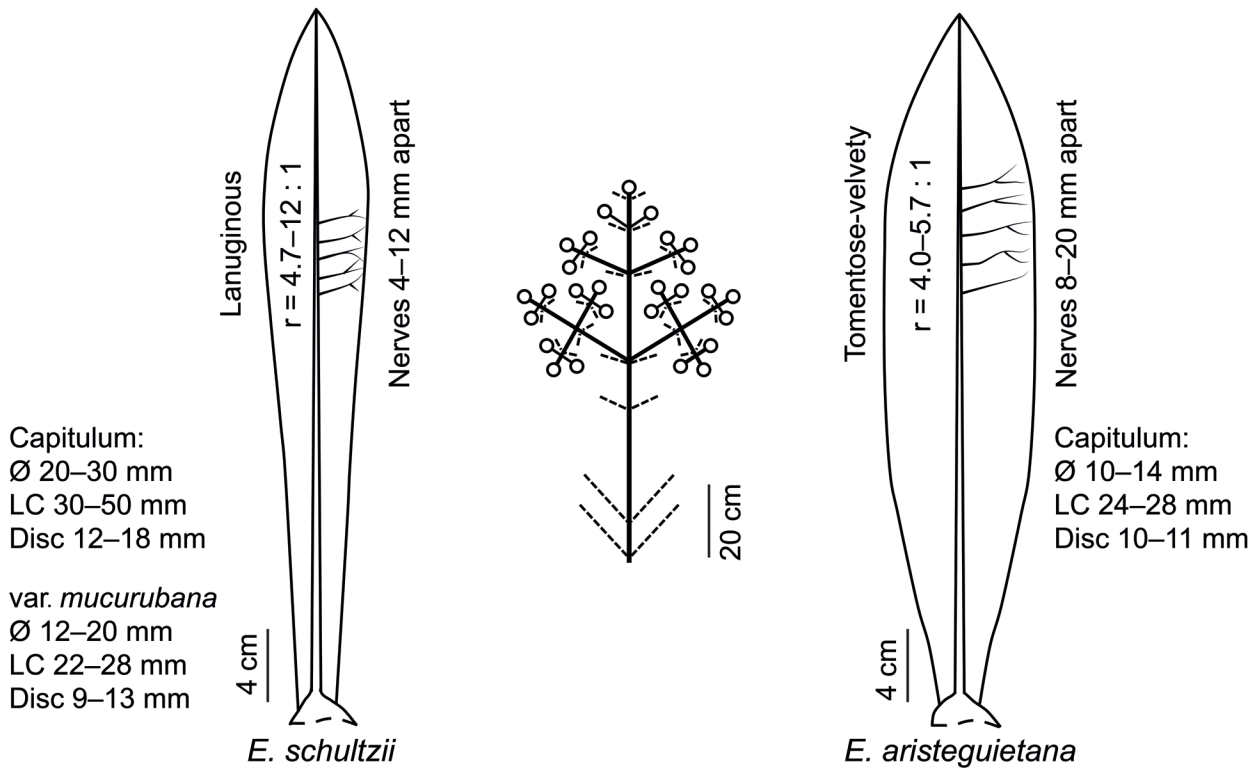

7. Polycarpic rosettes, polycephalous, ligular circles smaller than involucre

Simple inflorescences (strict botryoid)

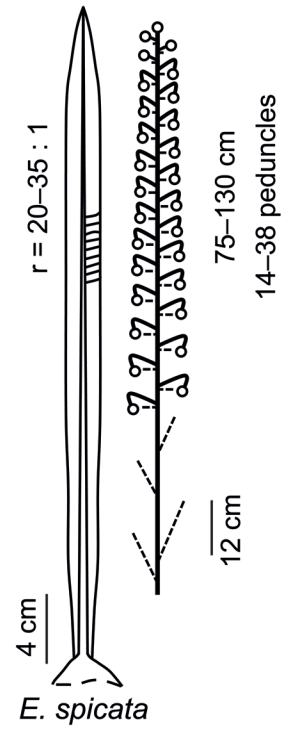
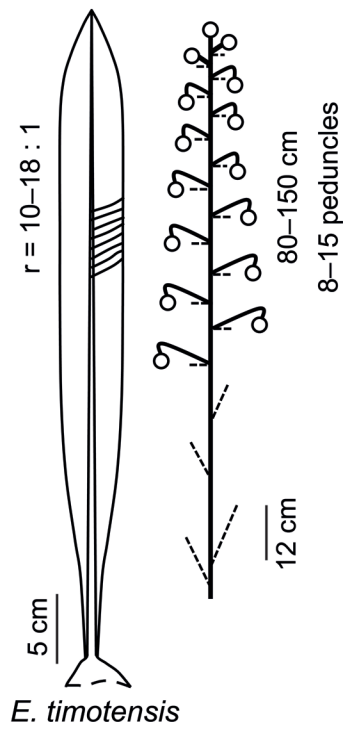
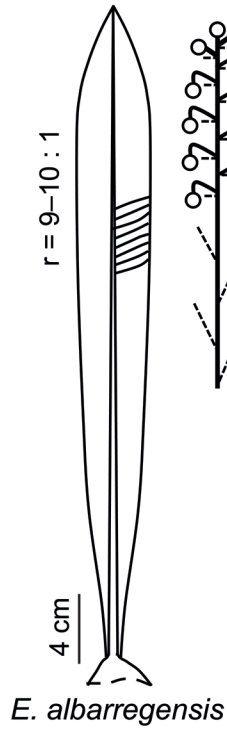

Compound inflorescences

