



Title	Pollen Morphology and Its Systematic Significance in the Ericaceae
Author(s)	Sawara, A.K.M. Golam
Citation	北海道大学. 博士(農学) 甲第8187号
Issue Date	2007-03-23
DOI	10.14943/doctoral.k8187
Doc URL	http://hdl.handle.net/2115/46925
Type	theses (doctoral)
File Information	sarwar.pdf



[Instructions for use](#)

Pollen Morphology and Its Systematic Significance in the Ericaceae

(ツツジ科植物の花粉形態とその体系学的意義)

A dissertation submitted in partial fulfillment of the requirements for
the degree of Doctor of Philosophy

By

Sarwar, A.K.M. Golam

Division of Bioresources and Product Science
Graduate School of Agriculture
Hokkaido University
Sapporo, Japan

March, 2007

Contents

Abstract	iv
Chapter 1: GENERAL INTRODUCTION	1
Chapter 2: MATERIALS AND METHODS	10
Chapter 3: POLLEN MORPHOLOGY AND ITS SYSTEMATIC SIGNIFICANCE	20
GENERAL POLLEN MORPHOLOGY OF THE ERICACEAE	20
3-1 SUBFAMILY ENKIANTHOIDEAE	24
Introduction	24
Results	25
Discussion	30
3-2 SUBFAMILY ARBUTOIDEAE	44
Introduction	44
Results	45
Discussion	51
3-3 SUBFAMILY ERICOIDEAE	60
Introduction	60
Results	61
Discussion	81
3-4 SUBFAMILY CASSIOPOIDEAE	106
Introduction	106
Results	107
Discussion	110

3-5 SUBFAMILY HARRIMANELLOIDEAE	112
Introduction	112
Results	113
Discussion	113
3-6 SUBFAMILY VACCINIOIDEAE	118
Introduction	118
Results	119
Discussion	160
Chapter 4: GENERAL DISCUSSION	203
Acknowledgements	252
Summary	254
References	259
Appendix I: Different classification systems of Ericaceae	281
Appendix II: Specimens examined	287

Abstract

A detailed description of the range of pollen morphological variation within the family Ericaceae *sensu* Kron et al. (2002a) has been presented. For this palynological investigation, 275 taxa of 270 species representing 57 genera and 6 subfamilies were studied with light (LM) and scanning electron microscopy (SEM), and 31 species with transmission electron microscopy (TEM). The systematic significance and evolutionary trends of palynological characters have been discussed in the light of the recent phylogenetic classification of the Ericaceae.

Pollen grains are dispersed as monads, tetrads or polyads, commonly of medium (30 – 50 µm) size and 3-colpor(oid)ate. Viscin threads are present only in a few genera of the subfamily Ericoideae (*Bejaria* and other eight genera). With SEM, exine sculpture varies from finely verrucate to psilate, and twelve major exine sculptural types have been recognized. Two dichotomous keys to the pollen of Ericaceae were prepared with the characters observed under LM, and exine sculpture with SEM. With TEM, the exine structure of ericaceous pollen is basically the same, and composed of sexine; tectum and columellae and nexine; foot layer and endexine. Two unique exine structures, granular columellae and canalized tectum, were observed in the monad pollen of two *Erica* species, *E. barbiger*a and *E. recurvifolia*, and the tectum with (a few) canals also observed in *Rhododendron japonicum* and *Oxydendrum arboreum*. The TEM observations were also found useful to confirm some critical palynological observations with LM and/or SEM: heterodynamosporus tetrads, different types of exine sculpture, tetrads without septa, presence of pollenkitt and pollenkitt ropes, cause of pollen shrinkage, and identification and realignment of taxa.

The family Ericaceae is eurypalynous enough to clarify the differentiation of species and genera, but has limited potential for clarification of the demarcation and relationships of higher taxa (e.g., tribes). Generally, the recent classifications and relationships among the

genera of Ericaceae were supported by results of the present study. Qualitative palynological characters (e.g., exine sculpture) were found to be taxonomically more important than quantitative characters (e.g., tetrad diameter), and various palynological characters important for different taxonomic levels. Palynological features were also found to be significant in some infrageneric classifications (e.g., *Arctostaphylos*), and to identify the monophyly of taxa (e.g., *Dimorphanthera*).

Moreover, some taxonomic problems were presented, and realignments of some taxa have been suggested from the palynological view point, e.g. tribal limits of the tribe Bejarieae. Individual generic status of the following three taxa has been proposed: *Erica recurvifolia* E.G.H. Oliv. as *Eremia recurvata* Klotzsch; *Rhododendron tsusiophyllum* Sugim. as *Tsusiophyllum tanakae* Maxim.; and *Vaccinium japonicum* Miq. as *Hugeria japonica* (Miq.) Nakai. At least one misplaced species was also identified; *Enkianthus sikokianus* (Palibin) Ohwi should be recognized as a separate species, but it has been incorporated into *E. campanulatus* (Miq.) Nicholson.

The present study revealed a number of evolutionary trends in different palynological features viz., pollen dispersal units, compactness of tetrads, pollen size and shape, aperture number and exine sculpture, within the family Ericaceae as well as within a genus (e.g., *Enkianthus*), and suggestions were made concerning the selective value of some of these trends. There is no clear correlation between pollen features of the family Ericaceae and either pollinators or geographical distributions, but present in lower taxa (e.g., *Rhododendron*, *Erica*).

In the course of the pollen survey the following interesting discoveries were made: the first unique palynological feature – pollen tetrads without septa for the Ericaceae (e.g., *Ceratostema*) as well as other angiosperm families; the parallel evolution of pseudomonad pollen tetrad development in the subfamily Styphelioideae and Vaccinioideae; pollenkitt ropes were found on the dried herbarium specimens (e.g., *Notopora*); and pollen tetrads with four aperturate grains were discovered in a number of taxa (e.g., *Vaccinium*).

Chapter 1

General Introduction

The Heath family Ericaceae is the 8th largest family of angiosperms, it comprises eight subfamilies, approximately 125 genera and 4100 species (Kron and Luteyn 2005). It is widespread in temperate, cool, and subtropical regions and in tropical regions in the mountains (Fig. 1-1). The Ericaceae has many fruit and timber yielding genera, many are valuable as showy ornamentals and sources of essential oils. Members of this family are highly diverse in life forms, leaf morphology, inflorescence characteristics and palynological features. Pollen grains of this family are dispersed as monads (e.g., Enkianthoideae) vs. tetrads – commonly isodinosporous (all four grains of the same size, Erdtman 1952) or heterodinosporous (all four grains not of the same size, Erdtman 1952) (e.g., Styphelioideae); or as polyads of indefinite number of tetrads (e.g., *Chimaphila*). The variety of pollen types, which are unparalleled by any other angiosperm family, makes the Ericaceae unique (Venkata Rao 1961). Pollen tetrads of this family sometime possess very rare and unique characters viz., 4-aperturate grains, pollenkit ropes in dried herbarium specimen (e.g., *Notopora*), and completely absence of septal (partition) wall between the two neighboring grains (e.g., *Ceratostema*), among the angiosperms.

The last classifications of the Ericaceae on a world basis were those of Hooker (1876) and Drude (1889). These have been accepted by the most subsequent workers as a satisfactory basis for discussion, proposing only minor modifications. However, subdivisions within Ericaceae and recognition of segregate families, Monotropaceae and Pyrolaceae varied with different authors (Table 1-1, detail in Appendix 1). Affinities of the Ericaceae with other families have also been variously discussed (e.g., Drude 1889, Takhtajan 1997).

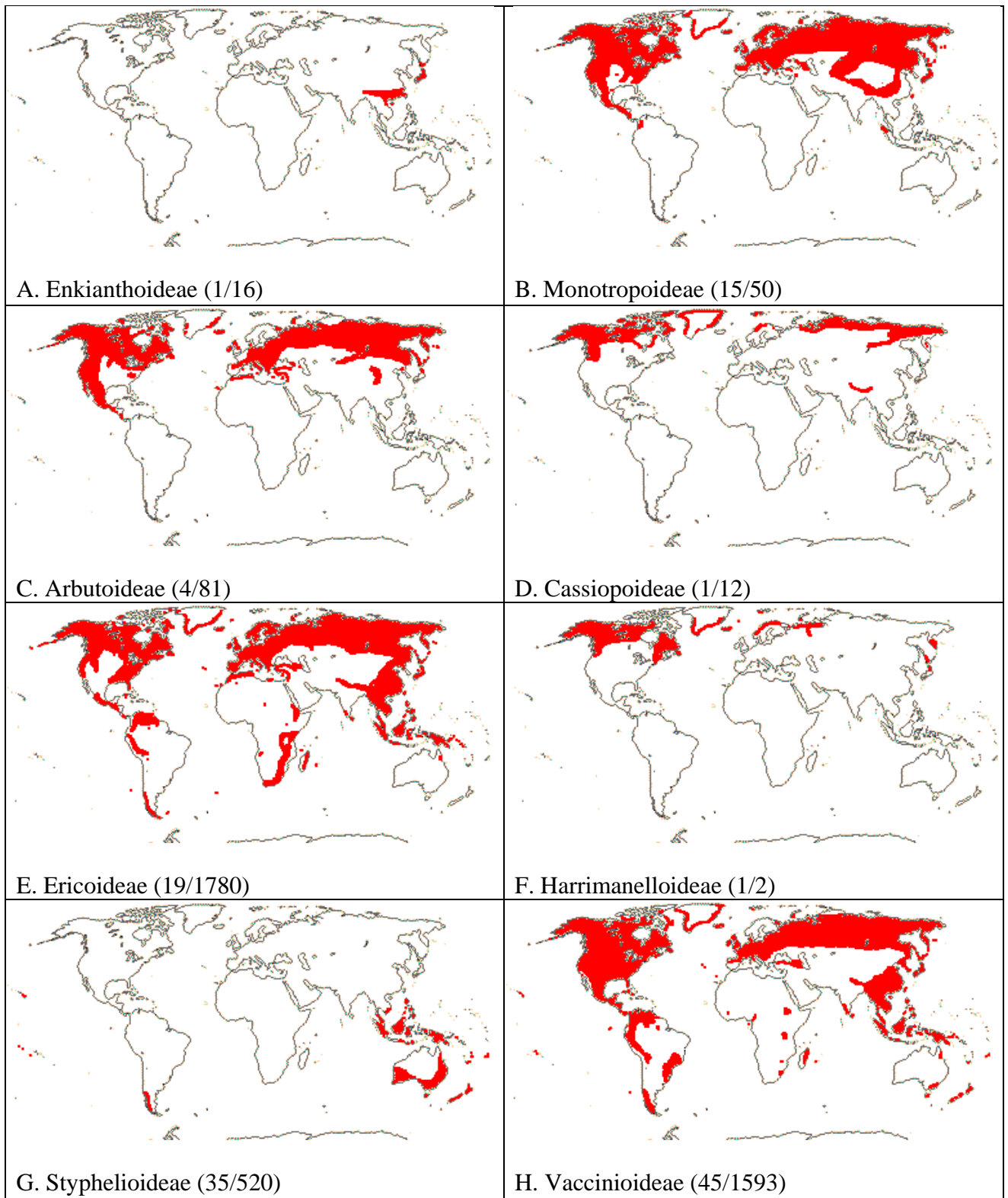

Fig. 1-1. World-wide distribution maps for the eight subfamilies of the Ericaceae. A. Enkianthoideae; B. Monotropeoideae; C. Arbutoideae; D. Cassiopoideae; E. Ericoideae; F. Harrimanelloideae; G. Styphelioideae; H. Vaccinioideae. In parenthesis no. of genera/ no. of species. Adapted from Kron and Luteyn (2005).

Table 1-1: Comparison among the outline of the major classifications of Ericaceae

Engler & Prantl (1889, 1891)	Stevens (1971, only Ericaceae)	Hutchinson (1973)	Cronquist (1981)	Kron et al. (2002a)
Order Ericales	Order Ericales	Order Ericales	Order Ericales	Order Ericales
Family Pyrolaceae	Family Ericaceae	Family Pyrolaceae	Family Empetraceae	Family Ericaceae s.l.
Pyroloideae	Rhododendroideae	Family Ericaceae	Family Epacridaceae	Enkianthoideae
Monotropoideae	Ericoideae	Family Prionotaceae	Family Ericaceae	Monotropoideae
Family Ericaceae	Vaccinioideae	Family Epacridaceae	Family Pyrolaceae	Arbutoideae
Rhododendroideae	(including Arbutoideae)	Family Monotropaceae	Family Monotropaceae	Ericoideae (incl. Empetraceae)
Arbutoideae	Pyroloideae	Family Vacciniaceae		Cassiopoideae
Vaccinioideae	Monotropoideae	Order Celastrales		Harrimanelloideae
Ericoideae	Wettstenioideae	Family Empetraceae		Styphelioideae (incl. Epacridaceae)
Family Epacridaceae				Vaccinioideae
Order Sapindales				
Family Empetraceae				

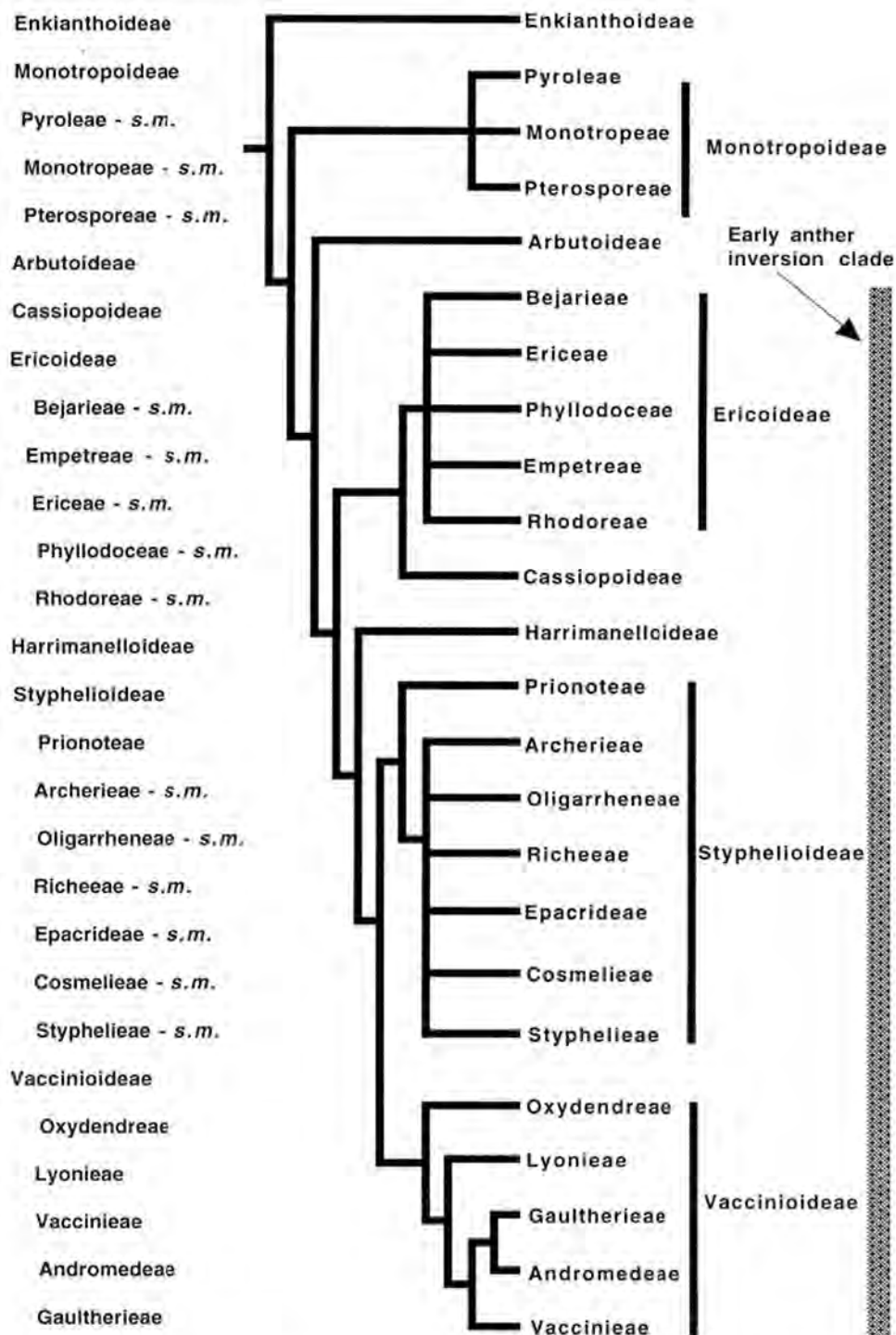

Fig. 1-2. Recent classification of Ericaceae. Adapted from Kron et al. (2002a).

With the improvement of large data analysis techniques and advancement of molecular systematics, interest on the systematics of this family has significantly increased in the past two decades. Recently a revised phylogenetic classification of the Ericaceae has been proposed (Kron et al. 2002a, Fig. 1-2), which recognizes 8 subfamilies and 20 tribes, and *Cyrilla* (Cyrillaceae) as the sister to the Ericaceae. However, tribal and generic circumscriptions remain ambiguous until today (e.g., Stevens 2003, 2006, Vander Kloet et al. 2004, Goetsch et al. 2005). Maguire et al. (1978) concluded that a systematic study of pollen of the family Ericaceae would prove rewarding and could be of some aid in clarifying the currently confused generic limits.

The pollen of Ericaceae has attracted the attention of scientific community from early times. Palynological characters observed under light microscope (LM) e.g., pollen dispersal unit, were known and also used in different classification schemes from a long time before (e.g., Drude 1889). A short history of palynological research in relation to plant taxonomy has been described by Wodehouse (1935). Later Erdtman (1952, reprinted in 1986) reviewed and described the basic pollen morphological features of different families in relation to plant taxonomy. With the advances in microscopic techniques, both in transmission (TEM) and scanning (SEM) electron microscopies, new dimensions have been added to palynological research. These have contributed valuable information to systematics in general and have, in many instances, been instrumental in solving taxonomic problems (Cole and Behnke 1975). Palynological features observed under electron microscopes provide useful characters relevant to phylogeny of angiosperms (Cole and Behnke 1975, Walker and Doyle 1975). The significance of palynological characters in the classification schemes of different families (e.g., Annonaceae, Walker 1971; Winteraceae, Pragłowski 1979; Droseraceae, Takahashi and Sohma 1982; Onagraceae, Pragłowski et al. 1983; Rubiaceae, Dessein et al. 2005; Smilacaceae, Chen et al. 2006); or in the plant kingdom itself (e.g., Judd et al. 2002, Simpson 2005); as well as understanding the origin, early diversification and evolution of angiosperms

(e.g., Crane et al. 1986, 1995, Kenrick 1999), has already been pointed out. The recent increasing popularity of molecular dating for explaining the origin and biogeographical history, fossil pollen records are probably the most reliable calibration point for angiosperms to make a fairly precise date (Milne 2006).

Pollen morphology of the Ericaceae (including Empetraceae and Epacridaceae) has been described in many reports and reviews (Erdtman 1952 and older references therein, Yang 1952, Ikuse 1954, Sladkov 1954, Paquereau 1959, Beug 1961, Venkata Rao 1961, Ueno 1962, 1980, Frank and Watson 1963, Matthews 1966, Nowicke 1966, Ridgway 1970, Visset 1971, 1977, Barth and Barbosa 1972, Lutz and Sjolund 1973, Mass 1977, Nilsson et al. 1977, McGlone 1978a & b, Hesse 1979, Takahashi 1979, 1986a & b, 1987a & b, 1988, Takahashi and Sohma 1980, Haber 1984, Waha 1984, Praglowski and Grafström 1985, Blackmore and Ferguson 1986, Díez and Cornesa 1987, Kim et al. 1988, Díez and Fernandez 1989, Faegri and Iversen 1989, Bouda 1989, Moore et al. 1991, Haber and Takahashi 1993, Davis 1997, Zhang and Anderberg 2002). Pollen morphology of several genera of the family Ericaceae has also been mentioned fragmentally in the regional pollen floras (Alaska: Moriya 1976; Canada (including Quebec): Comtois and Larouche 1981, Warner and Chinnappa 1986; Chile: Heusser 1971; China: Fuhsiung et al. 1995, Wei 2003; Guayana Highland: Maguire et al. 1978; France: Genier 1966; India (including Western Himalaya): Nair 1965, Vasanthy and Pocock 1987; Ireland: Foss and Doyle 1988; Japan: Ikuse 1956, 2001, Shimakura 1973, Nakamura 1980, Kurosawa 1991; Neotropics: Luteyn 1995a; North America: Lewis et al. 1983; Peru: Luteyn 1978; Portugal: Mateus 1989; Romania: Tarnavschi and Radulescu 1960; Scandinavia: Erdtman et al. 1961; Taiwan: Huang 1972; USA: Lieux and Godfrey 1982; Western Europe: Oldfield 1959).

In the majority of these studies, light microscopy (LM) was used extensively to investigate mature pollen grains (e.g., Overbeck 1934, Ueno 1950), but the SEM and/or TEM has been employed relatively in few studies (e.g., Ridgway 1970, Visset 1971). Another

noteworthy observation is that the species examined represent only the local and/or restricted regional distribution, not the wide geographic distribution of the Ericaceae as a whole. Although studies on the pollen of Ericaceae have been carried out for a long time, number of species reported in these works is still limited. Some of the taxa have been even described repeatedly (e.g., *Arbutus unedo* in Oldfield 1959, Paquereau 1959, Visset 1971, Díez and Conesa 1987, Foss and Doyle 1988, Díez and Fernandez 1989, Moor et al. 1991, Davis 1997). Furthermore, most of the previous studies have not been systematic in nature, but were done mainly for the identification purposes in Palaeobotany only (e.g., Faegri and Iversen 1989, Moore et al. 1991). Only one or two palynological characters viz., dispersal units and presence or absence of viscin threads, were used for classification of the Ericaceae (e.g., Stevens 1971, Kron et al. 2002a).

Therefore, the present research was carried out with following objectives based on numerous herbarium specimens covering both the wide geographical distribution and taxonomic diversity of the Ericaceae (*sensu* Kron et al. 2002a) –

- i) To describe pollen morphology of the family Ericaceae in comprehensive detail by LM and SEM, and also to a limited extent of TEM.
- ii) To discuss the systematic significance of pollen morphology within Ericaceae.
- iii) To evaluate the evolutionary trends in palynological features in the light of the recent phylogenetic classification of Ericaceae.

The main emphasis has been on SEM studies of apocolpial exine sculpture which has proved an important information source for taxonomic relationship among and/or within the families (e.g., Takahashi 1986a & b, Lens et al. 2005) as well as identification purpose of Ericaceous pollen (e.g., Foss and Doyle 1988). In order to address all these objectives, this thesis is organized into 4 chapters including new observations in the results (Chapter 3). This

chapter (Chapter 1) is a general introduction regarding the present research area and provides a background and an overview of relevant literature. Chapter two describes the materials and methods commonly used in this research. Chapter three describes and discusses the research results on palynological features and their systematic significance in different subfamilies of Ericaceae. Present delimitation of the family Ericaceae (Kron et al. 2002a), especially the tribal and generic delimit is also discussed in Chapter 3 as thoroughly as possible from the palynological point of view. Chapter four comprises general discussion in order to discuss and describe the evolutionary trends in palynological characters, and to correlate the palynological characters with other features viz., pollination biology and geographic distribution of Ericaceae. All chapters are furnished with tables and provided with figures. Almost all of these (data in the tables and photographs) are original, but where this is not the case the reference books and journals are cited.

Finally, there are two appendices. First one describes the previous classifications of the Ericaceae in a comprehensive detail. Second one is a list of the species studied; representative specimens examined for each species are cited.

Pollen morphology of the subfamily Monotropeoideae (*sensu* Kron et al. 2002a) has been studied in detail (Takahashi 1979, 1986a & b, 1987a & b, Takahashi and Sohma 1980). Hence, specimens from the members of this subfamily have not been included in this study; nonetheless relevant results are discussed in the general discussion. The major shortcoming of the present research is the absence of specimens from a large clade of the subfamily Styphelioideae (*sensu* Kron et al. 2002a), mostly of Australian origin. The exclusion is mainly due to the lack of specimens of this subfamily in Japanese herbaria. Although we have received some Styphelioideae specimens from the herbarium of the Royal Botanical Gardens Sydney (NSW), it happened very recently, and they could not be included in this study because of time shortage. Pollen morphology of Styphelioideae is known to some extent by

LM study (e.g., Erdtman 1952 and older references therein), but electron microscopic studies are still limited (e.g., McGlone 1978a & b, Martin 1993).

However, it is hoped that this research will improve our understanding of Ericaceae by providing new insights on the palynological features, their systematic significance and evolutionary trends within Ericaceae.

Chapter 2

Materials and Methods

A list of taxa investigated, the provenance of the material and the herbarium where the voucher specimen is deposited, is given in Appendix 2. Pollen materials used in this investigation were obtained from the following herbaria:

- C : Herbarium, Botanical Museum, University of Copenhagen, Copenhagen
- E : Herbarium, Royal Botanic Garden, Edinburgh
- GB : Herbarium, Botanical Museum, Göteborg
- KYO : Herbarium, Botany Department, Kyoto University, Kyoto
- S : Herbarium, Botany Departments, Swedish Museum of Natural History, Stockholm
- SAPS : Herbarium, the Hokkaido University Museum, Sapporo
- SAPT : Herbarium, the Botanic Garden, Hokkaido University, Sapporo
- TI : Herbarium, Botanical Gardens, University of Tokyo, Tokyo
- TUS : Herbarium, Biological Institute, Faculty of Science, Tohoku University, Sendai

Abbreviation of the herbarium names except for SAPT are according to the Index Herbariorum (Holmgren et al. 1990). For this palynological investigation, 313 specimens of 275 taxa, 270 species representing 57 genera and 6 subfamilies of Ericaceae were studied. The specimens examined are arranged alphabetically by tribes, genus, section, series and species (where applicable) and classification of the Ericaceae follows Kron et al. (2002a).

Pollen grains were examined by both light microscopy (LM) and scanning electron microscopy (SEM) for almost all specimens, but to a limited extent by transmission electron

microscopy (TEM). The selection of the specimen for TEM observations has been done with the following objectives in mind; i. to cover all the subfamilies, tribes and large genera within our experimental materials, and ii. to examine and confirm some extremely interesting palynological features revealed by LM and/or SEM e.g., shrinkage of tetrad, different types of exine sculpture, absence of septum, presence of pollenkitt ropes, etc.

Acetolysis

The pollen samples for LM and SEM were acetolysed following the technique developed by Erdtman (1960) modified by Takahashi (1987a). The anthers were soaked overnight in acetic acid for softening in 2 ml polyethylene centrifuge tube and were crushed prior to acetolysis. The utmost care was taken to remove the debris and/or unwanted material e.g., fractions of floral parts or anther, filament, etc. The acetic acid was then decanted and acetolysis mixture (9 ml acetic anhydride: 1 ml conc. sulphuric acid) was added to the centrifuge tube. The acetolysis took place at 100⁰ C for 3 – 5 min. A glass rod was inserted into each tube to stir the pollen sample within acetolysis mixture for the completion acetolysis process evenly. After acetolysis grains became yellow-brown to brown in color.

Preparation of specimens for microscopic observation

LM

For LM, the acetolysed materials were washed with distilled water, dehydrated in ethanol series (70%, 80%, 90%, 95%, 99.5% and 100%) and transferred in the benzene. A drop of silicon oil (viscosity 3000 cs.) was mixed with the material left in the benzene. The tube containing the material was left stand overnight at 75⁰ C until the benzene had evaporated completely. The slides sealed with paraffin wax. At least two slides per specimens were made. All slides were investigated and photographed with a Nikon Eclipse E200

microscope. Pollen slides are deposited in SAPS and the slide number is also listed in Appendix 2.

SEM

For SEM, acetolysed pollen samples were washed with distilled water, dehydrated in an ethanol series and mounted and air dried on aluminum stubs from 70% ethanol, and sputter coated with Platinum-Palladium or Gold by a HITACHI E102 ion sputter. Subsequently these were examined and photographed with a JEOL JSM-5310 LV scanning electron microscope operated at 15 KV.

The SEM stubs of all collection are also deposited in SAPS and the stub number is also listed in Appendix 2.

TEM

The unacetolysed anthers from herbarium specimens were used for ultrathin sections and TEM observation. A standard procedure was followed for TEM preparation (Hayat 1986). The herbarium materials were rehydrated in 3% Aerosol-OT (Di-iso-octyl Sodium Sulfosuccinate, Wako Chem. Co., Japan) solution for more than one week and washed by 50mM phosphate buffer (pH 7.4), and then fixed overnight in 1% osmium tetroxide in the same buffer. Fixed materials were dehydrated through an ethanol series (20%, 50%, 70%, 90%, 99.5% and 100%) and transferred in propylene oxide (OKEN Co., Tokyo) or QY – 1 (OKEN Co., Tokyo). The materials were embedded in Epon 812 epoxy resin (electron microscopy grade, TAAB Laboratories Equipment Limited, UK). Sections were cut on a Reichert-Jung Ultracut N ultratome with a diamond knife (Sumitomo Electric Industries, SK1045, Tokyo) and then transferred to 150-mesh grids. The sections were post-stained with saturated uranyl acetate for 20 min and lead acetate solution for 3 min, and observed and photographed on Hitachi H-800 transmission electron microscope operated at 75 KV.

Measurements

Most of the measurements were done on the LM at magnification of 400X. Nine primary palynological characters viz., tetrad diameter (D), polar length (P) and equatorial diameter (d in tetrad or E in monad) of pollen, length (2f in tetrad or L in monad) and width (W) of ectoaperture, length and width of endoaperture, apocolpial and septal exine thickness, were measured (Oldfield 1959). The parameters measured are indicated in the Figure 2-1 and described along with other common palynological terminologies used in this manuscript (Table 2-1, Fig. 2-2). Six secondary palynological characters viz., D/d, P/E, L/W, 2f/W, L/P and 2f/D ratio, were calculated from the mean values of respected parameters. The palynological features are divided into smaller groups or classes for better presentation/understanding of the variability and discussion of results (Table 2-2). The mean value, the standard deviation, and the range of each (primary) parameter are recorded in the tables (Chapter 3). The measurements given in tables are based on at least 10 grains from each specimen. The size (based on the length of longest grain axis) and shape classes (based on the P/E ratio of individual grain) were classified according to Erdtman (1986). Descriptive terminology follows Oldfield (1959), Punt et al. (1994), and Zhang and Anderberg (2002).

Photographs

For SEM micrographs, a special emphasis on the exine sculptures was given because the taxonomic value of this palynological feature has been proven in other families. The exine sculpture changed corresponding to the place upon pollen surface. In this study, the apocolpial exine sculpture was described for comparison among the species having pollen tetrads, and the mesocolpial exine sculpture for monads. Generally, only one SEM micrograph of exine sculpture from each specimen is included in the figures. This would, therefore, do not represent all the variations found on exine sculpture of a particular specimen. But, the variation for each specimen is described in tables.

Monad

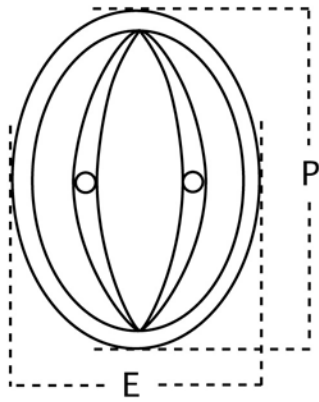

Prolate

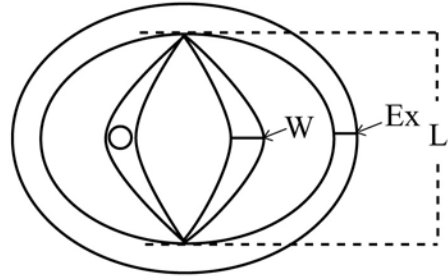

Oblate

Tetrad

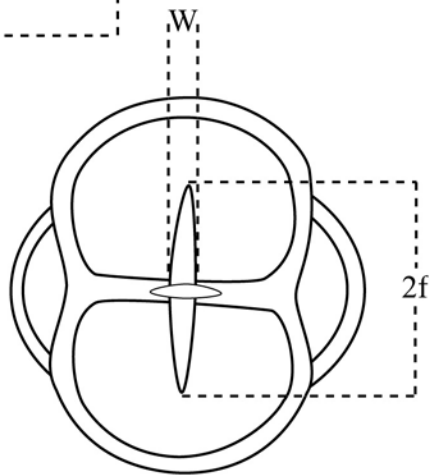
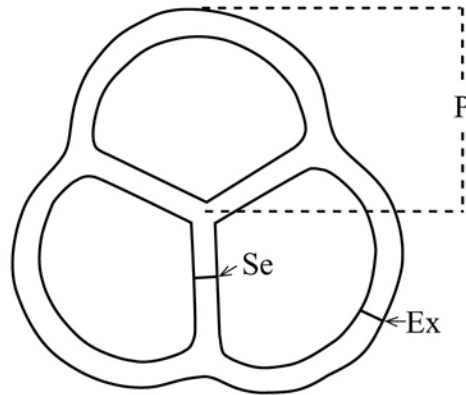
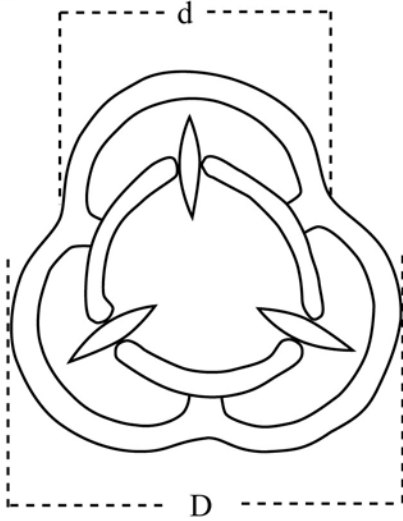

D Tetrad diameter
 P Polar axis
 E or d Equatorial diameter

L or 2f Aperture length
 W Aperture width
 Ex Exine thickness
 Se Septum thickness

Fig. 2-1. Some of the palynological parameters measured with LM. (Redrawn according to Oldfield 1959, Davis 1997).

Table 2-1: Some common pollen terminology. Terms are generally based on Punt et al. (1994).

Apocolpium:	A region at the pole of a zonocolpate pollen grain delimited by lines connecting the apices of the colpi (Fig. 2-2 A).
Colpor(oid)ate:	A compound aperture characterized by an ectoaperture, a distinct and/or indistinct endoaperture.
Colporoidate:	A compound aperture characterized by an ectoaperture, an indistinct endoaperture.
Colpororate:	A compound aperture characterized by an ectoaperture, a shorter lalongate (equatorially elongate) or lolongate (vertically elongate) endoaperture (Fig. 2-1).
Colpus (L or 2f):	An elongated aperture with a length/breadth ratio greater than 2 (Fig. 2-1).
Colpus membrane:	The aperture membrane of a colpus (Fig. 2-2 B).
Costa (pl. costae):	A thickening of the nexine/endexine bordering an endoaperture, or following the outline of an ectoaperture (Fig. 2-2 C).
Decussate tetrad:	A multiplanar tetrad of pollen grains arranged in two pairs lying across one another, the pairs (dyads) more or less at right angles to each other.
Ectexine:	The outer part of the exine, which stains positively with basic fuchsin in optical microscopy and has lower electron density TEM sections (Fig. 2-2 D).
Endexine:	The inner part of the exine which remains relatively unstained with basic fuchsin in optical microscopy and has a higher electron density TEM sections (Fig. 2-2 D).
Endocrack:	An irregular groove occurring in the inner surface of the nexine/endexine and readily apparent in acetolysed pollen (Fig. 2-2 E).
Equatorial diameter (E or d):	A line, lying in the equatorial plane, perpendicular to the polar axis and passing through it (Fig. 2-1).
Exine:	The outer layer of the wall of pollen, which is highly resistant to strong acids and bases, and is composed primarily of sporopollenin (Fig. 2-1).
Heterodynamosporus tetrad (pseudomonad):	All four pollen grains of the tetrad not of same size (Fig. 2-2 F).
Intine:	The innermost of the major layers of the pollen grain wall underlying the exine and bordering the surface of the cytoplasm.
Isodynamosporus tetrad:	All four pollen grains of the tetrad of same size (Fig. 2-2 G).
Mesocolpium:	The area of a pollen grain surface delimited by lines between the apices of adjacent colpi or the margins of adjacent pores (Fig. 2-2 H).

Table 2-2. Continued.

Monad: A pollen grain dispersed as an individual unit, rather than in association with others (Fig. 2-1).

Polar axis (P): The straight line between the distal and proximal poles of a pollen grain (Fig. 2-1).

Psilate: Describing pollen with a smooth surface.

Reticulate: A network-like pattern consisting of lumina or other spaces wider than 1 μ m bordered by elements narrower than the lumina (Fig. 2-2 I).

Rugulate: Describing a type of ornamentation consisting of elongated sexine elements more than 1 μ m long, arranged in an irregular pattern that is intermediate between striate and reticulate (Fig. 2-2 J).

Striate: A general descriptive term to elongated, generally parallel elements separated by grooves (Fig. 2-2 K).

Tetrad: A general term for a group of four united pollen grains, either as a dispersal unit or as a developmental stage (Fig. 2-1).

Tetragonal tetrad: A uniplanar tetrad in which all four members are in contact at the centre of the tetrad so that, in the correct orientation, the adjacent walls form a cross.

Tetrahedral tetrad: A multiplanar tetrad in which each member is in contact with three others, so that the centers of the grains define a tetrahedron (Fig. 2-1).

Verrucate: A wart-like sexine element, more than 1 μ m wide, that is broader than it is high and is not constricted at the base (Fig. 2-2 L).

Viscin thread: An acetolysis resistant, sporopollenin thread arising from the exine of a pollen grain, usually from the distal surface in Ericaceae.

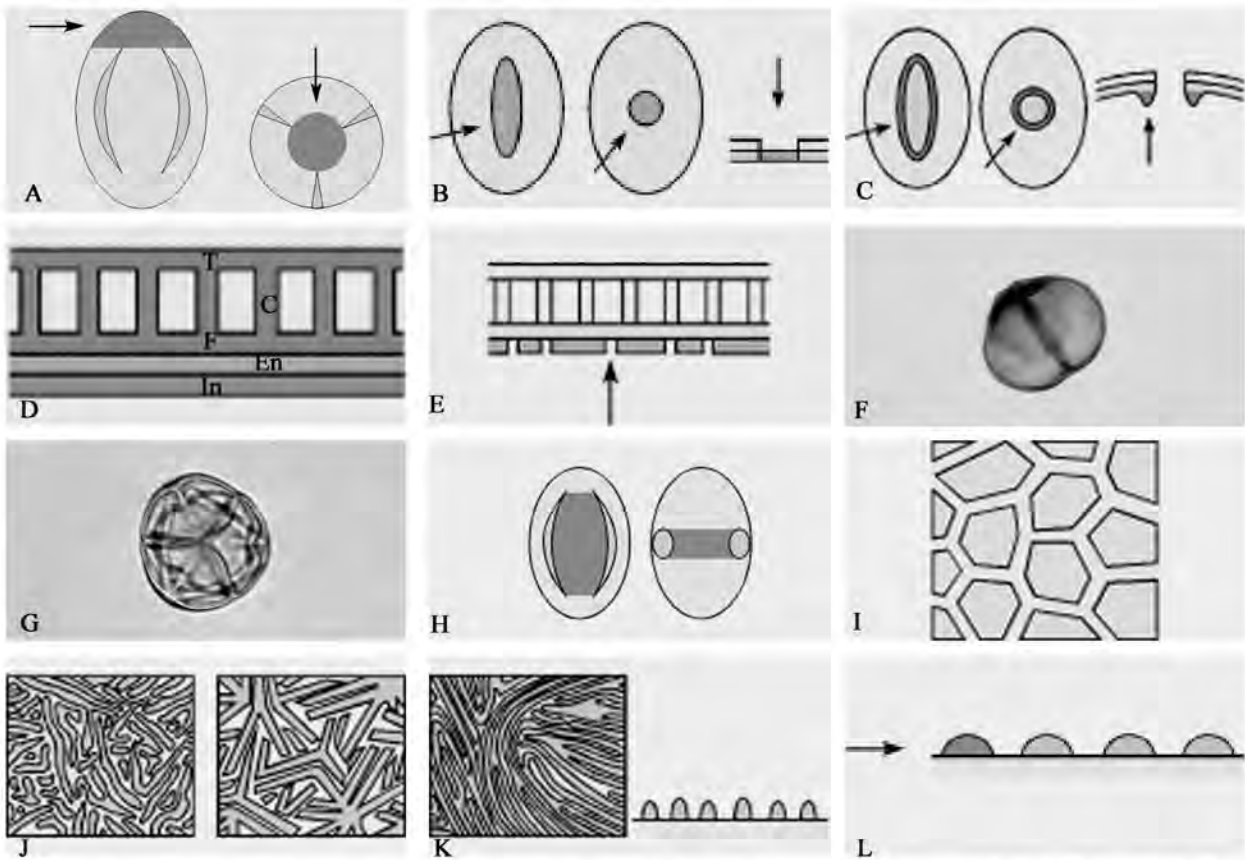

Fig. 2-2. Schematic illustration of different palynological features. A. Apocolpial region; B. Colpus membrane; C. Costae; D. Pollen wall structure (T: tectum, C: columellae, F: foot layer, En: endexine, In: intine); E. Endocracks; F. Heterodynamosporus tetrad; G. Isodynamosporus tetrad; H. Mesocolpial region; I - L. Exine sculpture(s); reticulate (I), rugulate (J), striate (K), verrucate (L). Adapted from Punt et al. (1994) with some modifications except F and G.

Table 2-2. Pollen morphological classes based on light microscopic measurement.

Name of class	D (μm)	P(μm)	D/d	P/E	2f or L	2f/W or L/W	2f/D or L/P	Apo. Exine Thick. (μm)	Septum Thick. (μm)
I	20.1 – 30.0	– 15.0	– 1.19	– 0.65	10.1 – 20.0	– 10.0	– 0.30	– 1.0	– 1.0
II	30.1 – 40.0	15.1 – 20.0	1.20 – 1.29	0.66 – 0.75	20.1 – 30.0	10.1 – 20.0	0.31 – 0.40	1.1 – 1.5	1.1 – 1.5
III	40.1 – 50.0	20.1 – 25.0	1.30 – 1.39	0.76 – 0.85	30.1 – 40.0	20.1 – 30.0	0.41 – 0.50	1.6 – 2.0	1.6 – 2.0
IV	50.1 – 60.0	25.1 – 30.0	1.40 – 1.49	0.86 – 0.95	40.1 – 50.0	30.1 – 40.0	0.51 – 0.60	2.1 – 2.5	2.1 – 2.5
V	60.1 –	30.1 – 35.0	1.50 – 1.59	0.96 – 1.05		40.1 – 50.0	0.61 – 0.70	2.6 – 3.0	2.6 –
VI		35.1 –	1.60 –	1.06 – 1.15		50.1 – 60.0	0.71 – 0.80	3.1 –	
VII				1.16 – 1.25		60.1 –	0.81 –		
VIII				1.26 –					

D: tetrad diameter, P: polar length, E (d): equatorial diameter, 2f (L): ectoaperture length, W: ectoaperture width, Apo.: apocolpial, Thick.: thickness.

The LM photographs were taken with digital camera (Nikon Coolpix 950 or 990) and SEM micrographs by the digital camera attached with SEM. The TEM photographs were developed and scanned into digital form. Final plates were prepared using Adobe Photoshop 7.0. The Adobe Illustrator CS2 version was used to make diagrams and line drawings.

Statistical analysis

The average of quantitative data of different palynological characters (Table 4-2) was used for statistical calculations – Agglomerative Hierarchical Clustering (AHC) and Principal Component Analysis (PCA), using XLSTAT-Pro version 7.5 computer package.

Chapter 3

Pollen morphology and its systematic significance

General pollen morphology of the Ericaceae

In LM, pollen grains are monads or united in tetrads, rarely in polyad in *Chimaphila* (Takahashi 1986a). Tetrads are commonly isodynamosporous, and in tetrahedral– normal, compact and lobed, arrangement, but sometimes in other configurations e.g., decussate, tetragonal and so on. Heterodynamosporous tetrads are found in members of the tribe Vaccinieae of subfamily Vaccinioideae and also in tribes Oligarrheneae and Styphelieae of subfamily Styphelioideae (Kron et al. 2002a). Viscin threads are commonly absent, but present in members of tribe Bejarieae, Phyllodoceae and Rhodoreae of the subfamily Ericoideae. In range of average values of the specimen, tetrad diameter (D) 24.4 – 72.4 μm , polar length (P) 12.5 – 39.3 μm , equatorial diameter (E or d) 15.1 – 50.8 μm , D/d 1.12 – 1.67. Pollen shape commonly oblate, but varies from oblate to prolate (P/E 0.59 – 1.48). Three aperturate, spatial position of the apertures according to “Fischer’s law”, except in *Calluna* where apertures sometimes arranged according to “Garside’s Law”, rarely 4- or 5- aperturate, colp(oid)ate, colpi distinct, rarely slit-like, length (L or 2f) 11.5 – 42.4 μm , width (W) 0.4 – 5.1 μm , length-width ratio (L/W or 2f/W) 3.60 – 70.25, L/P 0.56 – 0.84, 2f/D 0.26 – 0.78, significantly wider at middle, aperture margin distinct, tip generally acute, sometimes slightly tapering towards ends or bifurcated. Costae are usually present and distinct, but indistinct some species. Endocracks are commonly absent or indistinct, but distinct in the subfamily Ericoideae. Endoaperture is distinct, sometimes indistinct, commonly lalongate, rarely circular, 0.4 – 5.9 μm long, 3.7 – 17.2 μm wide. Exine is tectate, apocolpial exine 0.9 – 3.8 μm thick, mesocolpial (in monads) exine 1.1 – 2.8 μm thick; septum present, but absent

in *Ceratostema*, septal exine 0.5 – 3.2 μm thick, sometimes perforated, apocolpial exine varies from fine verrucate through coarsely rugulate to psilate.

In SEM, pollen surface varies from rugged to flat, primary exine sculpture from indistinct through coarsely rugulate to psilate, secondary exine sculpture on primary sculpture from minute granulate to striate; aperture (colpus) membrane granulate through granuloid to smooth.

Based on SEM observations, twelve major sculptural types can be recognized in the species examined in the present study (Fig. 3) as follows:

Type 1 RG: Primary sculpture moderate to coarsely (muri width $> 0.5 \mu\text{m}$) rugulate-psilate, primary sculpture unit covered with secondary sculpture, secondary sculpture unit minute (diam. $< 0.2 \mu\text{m}$) granules (Fig. 3 A).

Type 2 RS: Primary sculpture moderate to coarsely (muri width $> 0.5 \mu\text{m}$) rugulate-psilate, primary sculpture unit covered with secondary sculpture, secondary sculpture unit minute (diam. $< 0.2 \mu\text{m}$) striate (Fig. 3 B).

Type 3 RGS: Primary sculpture moderate to coarsely (muri width $> 0.5 \mu\text{m}$) rugulate-psilate, primary sculpture unit covered with secondary sculpture, secondary sculpture unit moderate (diam. $> 0.2 \mu\text{m}$) granulate to short striate (Fig. 3 C).

Type 4 R: Primary sculpture moderate to coarsely (muri width $> 0.5 \mu\text{m}$) rugulate, primary sculpture unit without any secondary sculpture (Fig. 3 D).

Type 5 P: Primary sculpture psilate, primary sculpture unit without any secondary sculpture (Fig. 3 E).

Type 6 PS: Primary sculpture psilate, primary sculpture unit covered with secondary sculpture, secondary sculpture unit striate (Fig. 3 F).

Type 7 S: Primary sculpture striate (Fig. 3 G).

Type 8 FV: Primary sculpture indistinct, secondary sculpture fine (diam. $< 0.5 \mu\text{m}$) verrucate (Fig. 3 H).

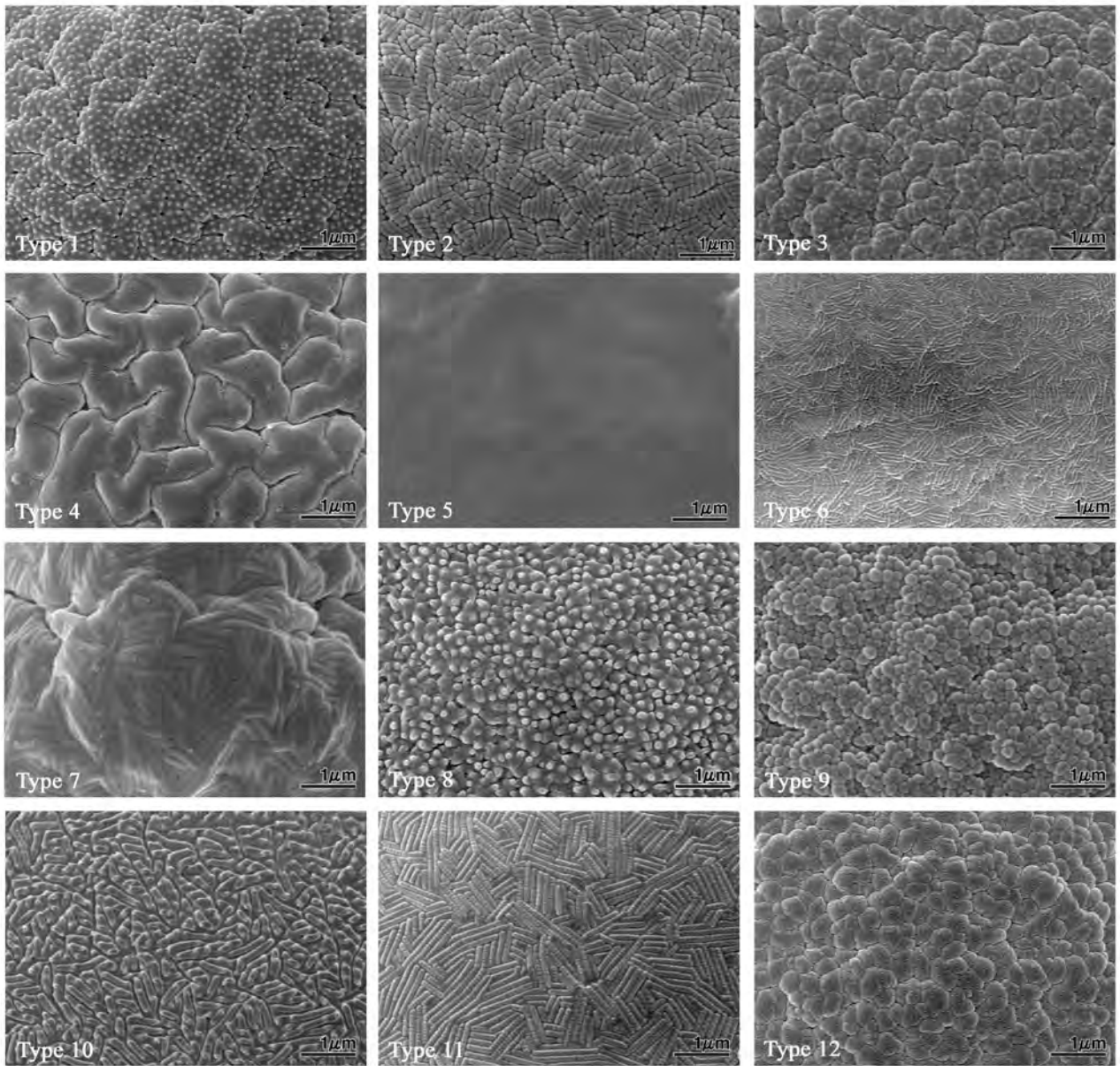

Fig. 3. SEM micrographs of Ericaceae pollen. Different exine sculptural type(s).

Type 9 FG: Primary sculpture indistinct, secondary sculpture fine (diam. < 0.5 μm) gemmate-pilate (Fig. 3 I).

Type 10 FS: Primary sculpture indistinct, secondary sculpture fine, short striate with verrucate (Fig. 3 J).

Type 11 NS: Primary sculpture indistinct, secondary sculpture fine, narrow straight-edged striate (Fig. 3 K).

Type 12 MG: Primary sculpture indistinct, secondary sculpture unit moderate (diam. > 0.5 μm) gemmate-pilate (Fig. 3 L).

Moreover, many intermediate types are also observed within the major exine sculptural types, and the different types of exine sculpture have observed among (e.g., RS & R in *Andromeda polifolia*) or within (e.g., FG & RG/FV in *Enkianthus sikokianus*) the specimen of same taxa.

In TEM, the exine structure of Ericaceous pollen is basically the same, is composed of sexine; tectum and columellae and nexine; foot layer and endexine. Sexine is ca. 0.4 – 1.3 μm thick, a total exine ca. 0.9 – 2.2 μm thick, septum (in tetrads) ca. 0.3 – 1.9 μm , and sexine-nexine ratio varies from 0.6 – 1.8. The TEM observations have also found to be useful to confirm some critical observations which are observed under LM and/or SEM, e.g., different exine sculptures, absence of septum in *Ceratostema*, pollenkitt rope in *Notopora*, etc.

3-1 Subfamily Enkianthoideae

Introduction

The subfamily Enkianthoideae Kron, Judd and Anderb. is composed of a single genus, *Enkianthus*, with about 16 species occurring in Eastern Himalayas, China, Japan, Taiwan, and Indochina (Kron and Luteyn 2005, a detailed distribution map in Fig. 1-1). Recent morphological and molecular cladistic analyses indicate that *Enkianthus* is sister to the Ericaceae *s.l.* including Empetraceae and Epacridaceae (Anderberg 1993, 1994, Judd and Kron 1993, Kron and Chase 1993, Kron 1996, 1997, Kron et al. 2002a, Fig. 1-2). Previously, Cox (1948) also noted that the primitive species of *Enkianthus* are the most primitive in the Ericaceae. However, the taxonomic position of *Enkianthus* was not stable. *Enkianthus* was included in the Andromedeae (Hooker 1876, Drude 1889, Watson et al. 1967) or Cassiopeae (Cox 1948) but was placed in its own tribe Enkiantheae, of the Vaccinioideae, by Stevens (1971). Along with tribal position, the infrageneric classification of *Enkianthus* also varied in a great extent (e.g., Palibin 1899, Ueno 1950, Hsu 1982, Anderberg 1994). The combined analysis of morphological and molecular data (Kron et al. 2002a) showed that in the evolution of Ericaceae two evolutionary lineages emerged. One of these evolved into the Enkianthoideae, of which *Enkianthus* is only known representative today. The other evolved into the ancestral group that has diversified into the rest of the family. Plants are shrubs or small trees and different species of this genus are used as ornamental plants in the garden or as a mixed border plant. *Enkianthus* differ from other Ericaceae in having anthers with fibrous endothecium, pollen grains in monads without viscin threads, and seeds with vascular bundles in the raphe (Anderberg 1994). But these features may represent symplesiomorphies and perulate buds emerges as a potential synapomorphy of *Enkianthus* (Kron et al. 2002a).

Mainly light microscope (LM) observations of pollen grains of *Enkianthus* have been carried out previously (Ueno 1950, Ikuse 1956, 2001, Nakamura 1980, Fuhsiung et al. 1995).

Scanning electron microscopic (SEM) observations of pollen grains in two species, *E. campanulatus* and *E. perulatus*, were published previously (Plate 83 in Kurosawa 1991, Fig. 8 in Zhang and Anderberg 2002). In order to provide new information and to discuss the new pollen morphological data in light of recent phylogenetic classification of Ericaceae as well as infrageneric classification of *Enkianthus* (Anderberg 1994), the present study presents a detailed examination of pollen morphology of the genus using both LM and SEM for most of the species, and TEM for *E. campanulatus* and *E. perulatus*.

Results

Pollen morphology of subfamily Enkianthoideae (monogeneric: *Enkianthus*; 16 spp. / 10 spp. examined: *E. campanulatus*, *E. campanulatus* var. *longilobus*, *E. campanulatus* var. *palibinii*, *E. cernuus*, *E. cernuus* f. *rubens*, *E. chinensis*, *E. deflexus*, *E. nudipes*, *E. perulatus*, *E. quinqueflorus*, *E. serotinus*, *E. sikokianus* and *E. subsessilis*)

In LM, pollen grains are in monads, grains often shrink in *E. deflexus* (Hara et al. 21810) and *E. cernuus*, few grains in *E. campanulatus* (Sukawa s.n.); viscin threads absent; commonly medium, sometimes minute. In range of average values of specimen, polar length (P) 17.1 – 29.9 μm , equatorial diameter (E) 15.1 – 30.6 μm , P/E 0.95 – 1.48, oblate spheroidal to prolate; 3- to 5-colpor(oid)ate, commonly 3-colpor(oid)ate in members of the sects. *Enkiantella* and *Meisteria*, 4-colporate in the sect. *Andromedina*, and 4 – 5-colpor(oid)ate in the sect. *Enkianthus*, colpi distinct, 13.1 – 24.3 μm long (L), 0.7 – 2.3 μm wide (W), L/W 7.74 – 34.71, L/P 0.56 – 0.84, significantly wider at the middle; ora commonly distinct, but indistinct in *E. deflexus* (Yamazaki 2537), *E. campanulatus* var. *longilobus*, *E. cernuus* f. *rubens*, *E. perulatus* and *E. serotinus* (Tables 3-1-1 – 3-1-2). Colpi are acute towards the end in members of the sects. *Enkiantella* and *Meisteria*, and

slightly tapering to obtuse in members of the sects. *Andromedina* and *Enkianthus*. Sometimes colpi are constricted at the middle, colpus margin distinct. Costae are distinct except in *E. cernuus* where they are indistinct. Ora are commonly lalongate, but circular in *E. deflexus* (Yamazaki 2537), *E. campanulatus* (Tatewaki et al. s.n.), *E. cernuus* f. *rubens* and *E. sikokianus* or not clear in *E. perulatus* and *E. serotinus*, 0.5 – 2.8 μm long, 5.2 – 9.0 μm wide. Exine is tectate, apocolpial exine 1.0 – 2.6 μm thick and mesocolpial exine 1.1 – 2.2 μm thick. Usually the apocolpial exine is thicker than the mesocolpial exine, but thinner apocolpial exine has been observed in *E. chinensis*, one specimen of *E. deflexus* (Yamazaki 2537), *E. campanulatus* var. *palibinii*, *E. sikokianus*, and *E. subsessilis* or equal in thickness in one specimen of *E. deflexus* (Hara et al. 21810), *E. cernuus*, one specimen of *E. cernuus* f. *rubens* (Matsuda s.n.), and *E. nudipes* (Table 3-1-2). Exine sculpture is finely verrucate to finely rugulate or verrucate to rugulate in most of the species except in *E. cernuus*, and *E. nudipes*, psilate to fine ornamentation.

In SEM, pollen surface is commonly flat, primary exine sculpture indistinct, 1) secondary exine sculpture finely (diam. < 0.5 μm) verrucate (Type FV; Figs. 3-1 K – O, 3-2 B); or 2) secondary sculpture finely (diam. < 0.5 μm) gemmate-pilate (Type FG; Figs. 3-2 C – F, H); or 3) surface uneven and rugged, primary exine sculpture coarsely rugulate-psilate, the rugulae with minute (diam. < 0.2 μm) granulate secondary sculpture (Type RG; Figs. 3-2 I, K – L, N – O); or 4) surface somewhat flat, primary exine sculpture coarsely rugulate, the rugulae without distinct secondary sculpture (Type R; Fig. 3-2 J); or 4) intermediate types (RG/FV; Figs. 3-2 A, G or R/RG; Figs. 3-2 M). Exine sculpture along the colpi is similar to mesocolpial exine. Colpi membrane is granulate, but smooth colpus membrane is also found in *E. deflexus* and *E. campanulatus*.

Table 3-1-1. Pollen morphological data of subfamily Enkianthoideae based on light microscopic investigation.

Taxon	No. of Apertures	P ¹	P/E ²	L ³	L/W ⁴	L/P ⁵	Apo. Exine Thickness ⁶	Meso. Exine Thickness ⁷	Ornamentation ⁸	Colpus Membrane	Remark ⁹
Section <i>Enkiantella</i>											
<i>E. chinensis</i>	(2) – 3	III	VI	I	II	VI	II	III	FV	Granulate	
<i>E. deflexus</i>	(Yamazaki 2537) 3	III	VI	I	I	VI	III	III	FV	Granulate	1, 2
	(Unknown 0814) 3 – (4)	IV	VI	I	I	VI	IV	IV	-	Granulate	
	(Hara et al. 21810) 3 – (4)	III	VI	I	II	V	III	III	-	Smooth	
Section <i>Meisteria</i>											
<i>E. campanulatus</i>	(Takahashi 511) 3	IV	VIII	II	IV	VII	III	III	FV	Granulate	
	(Tatewaki et al. s.n.) 3	IV	VII	II	I	VI	V	IV	FV	Smooth	2
	(Sukawa s.n.) 3	IV	VIII	II	I	VI	III	II	FV	Granulate	
<i>E. campanulatus</i> var. <i>longilobus</i>	3 – (4)	III	VI	I	II	VI	III	II	RG/ FV	Granulate	1
<i>E. campanulatus</i> var. <i>palibinii</i>	3	IV	VI	II	II	VI	II	III	FV	Granulate	
<i>E. cernuus</i>	3	II	VI	I	II	VII	II	II	FG	Granulate	3
<i>E. cernuus</i> f. <i>rubens</i>	(Tohyama s.n.) 3	IV	VII	I	I	VI	III	II	FG	Granulate	1, 2
	(Matsuda s.n.) 3	III	VI	I	I	VI	III	III	FG	Smooth	1, 2
<i>E. sikokianus</i>	3	III	VI	I	I	VI	I	II	FG or RG/ FV	Granulate	2
Section <i>Andromedina</i>											
<i>E. nudipes</i>	4 – (5)	IV	VI	I	II	V	III	III	RG or R	Granulate	
<i>E. subsessilis</i>	4	III	V	I	II	IV	III	IV	RG	Granulate	
Section <i>Enkianthus</i>											
<i>E. perulatus</i>	4 – 5	IV	V	I	II	V	III	III	R/RG	Granulate	1
<i>E. quinqueflorus</i>	4 – 5	IV	IV	I	I	IV	III	III	RG	Granulate	
<i>E. serotinus</i>	4 – 5	IV	V	I	I	IV	III	III	RG	Granulate	1

P: polar length, E: equatorial diameter, L: ectoaperture length, W: ectoaperture width, Apo.: apocolpial, Meso.: mesocolpial.

¹ II: 15.1 – 20.0 µm, III: 20.1 – 25.0 µm, IV 25.1 – 30.0 µm

⁶ I: – 1.0 µm, II: 1.1 – 1.5 µm, III 1.6 – 2.0 µm, IV: 2.1 – 2.5 µm, V: 2.6 – 3.0 µm

² IV: 0.86 – 0.96, V: 0.96 – 1.05, VI: 1.06 – 1.15, VII: 1.16 – 1.25, VIII: 1.26 –

⁷ I: 0.5 – 0.9 µm, II: 1.0 – 1.4 µm, III: 1.5 – 1.9 µm, IV: 2.0 – 2.4 µm

³ I: 10.1 – 20.0 µm, II: 20.1 – 30.0 µm

⁸ Types of exine ornamentation by SEM corresponding to Fig. 3.

⁴ I: - 10.0, II: 10.1 – 20.0, III: 20.1 – 30.0, IV 30.1 – 40.0

⁹ 1: Ora indistinct, 2: Ora circular, 3: Costae indistinct

⁵ IV: 0.51 – 0.60, V: 0.61 – 0.70, VI: 0.71 – 0.80; VII: 0.81 -

Table 3-1-2. Variation in pollen characters of subfamily Enkianthoideae showing mean value in μm and standard deviation.

Taxon	P	E	P/E	Ectoaperture			L/P	Endoaperture		Apo. Exine Thickness	Meso. Exine Thickness
				Length (L)	Width (W)	L/W		Length	Width		
Section <i>Enkiantella</i>											
<i>E. chinensis</i>	23.8±0.7 (23.0 – 25.4)	21.9±1.1 (19.7 – 23.3)	1.09	17.8±1.3 (16.3 – 19.7)	1.7±0.3 (1.2 – 1.9)	10.47	0.75	n.d.	n.d.	1.4±0.5 (0.7 – 2.2)	1.5±0.3 (1.2 – 2.2)
<i>E. deflexus</i>	(Yamazaki 2537) 24.5±1.2 (23.3 – 26.6)	23.0±1.0 (21.8 – 24.5)	1.07	18.6±1.1 (16.8 – 20.0)	2.3±0.5 (1.9 – 3.6)	8.09	0.76	n.d.	n.d.	1.6±0.5 (1.0 – 2.4)	1.7±0.4 (1.2 – 2.2)
	(Unknown 0814) 25.4±1.3 (23.5 – 27.8)	23.4±2.1 (20.6 – 26.4)	1.08	19.9±0.7 (19.2 – 21.1)	2.1±0.2 (1.9 – 2.4)	9.48	0.78	n.d.	n.d.	2.1±0.3 (1.7 – 2.4)	2.0±0.2 (1.9 – 2.4)
	(Hara et al. 21810) 24.4±2.8 (20.4 – 30.0)	21.4±4.4 (17.0 – 32.2)	1.14	16.9±2.0 (13.9 – 19.2)	1.6±0.5 (1.2 – 2.4)	10.56	0.69	n.d.	n.d.	1.9±0.4 (1.4 – 2.6)	1.9±0.4 (1.2 – 2.4)
Section <i>Meisteria</i>											
<i>E. campanulatus</i>	(Takahashi 511) 29.9±0.5 (29.4 – 30.7)	23.0±1.2 (21.5 – 25.1)	1.30	24.3±1.0 (23.1 – 26.4)	0.7±0.4 (0.3 – 1.7)	34.71	0.81	2.8±1.4	5.2±0.4	1.9±0.2 (1.7 – 2.0)	1.5±0.2 (1.3 – 1.8)
	(Tatewaki et al. s.n.) 29.2±1.3 (27.6 – 31.2)	24.4±0.8 (23.5 – 26.4)	1.20	21.7±2.1 (19.2 – 26.4)	2.3±0.8 (0.7 – 3.4)	9.43	0.74	n.d.	n.d.	2.6±1.0 (1.4 – 4.8)	2.2±0.7 (1.2 – 3.6)
	(Sukawa s.n.) 29.1±1.0 (27.6 – 30.2)	19.6±3.2 (16.3 – 24.5)	1.48	21.9±1.3 (19.7 – 23.0)	2.2±0.3 (1.9 – 2.4)	9.95	0.75	n.d.	n.d.	1.6±0.6 (0.7 – 1.9)	1.4±0.3 (1.0 – 1.7)
<i>E. campanulatus</i> var. <i>longilobus</i>	23.6±1.1 (21.8 – 25.0)	22.2±2.0 (19.7 – 26.5)	1.06	18.8±1.9 (14.9 – 21.1)	1.8±0.3 (1.4 – 2.4)	10.44	0.80	n.d.	n.d.	1.7±0.3 (1.4 – 2.2)	1.4±0.3 (1.0 – 1.7)
<i>E. campanulatus</i> var. <i>palibinii</i>	26.8±0.8 (25.2 – 27.6)	24.4±1.5 (22.8 – 26.9)	1.10	20.4±0.9 (19.2 – 21.6)	2.0±0.3 (1.4 – 2.4)	10.20	0.76	n.d.	n.d.	1.5±0.3 (1.2 – 1.9)	1.7±0.3 (1.2 – 2.2)
<i>E. cernuus</i>	17.1±0.4 (16.5 – 17.7)	15.1±1.0 (14.0 – 16.7)	1.13	14.4±1.1 (13.2 – 14.9)	0.9±0.6 (0.5 – 1.3)	16.00	0.84	0.5	5.8±1.2	1.1±0.2 (0.8 – 1.3)	1.1±0.3 (0.5 – 1.3)
<i>E. cernuus</i> f. <i>rubens</i>	(Tohyama s.n.) 25.4±1.8 (22.8 – 28.8)	20.8±0.9 (19.7 – 2.2)	1.22	19.3±0.9 (18.0 – 21.6)	2.1±0.5 (1.2 – 2.4)	9.19	0.76	n.d.	n.d.	1.7±0.2 (1.4 – 2.0)	1.4±0.2 (1.2 – 1.9)
	(Matsuda s.n.) 23.6±3.3 (18.0 – 28.8)	21.9±2.9 (16.8 – 25.2)	1.07	17.3±2.3 (13.2 – 20.4)	1.9±0.3 (1.4 – 2.4)	9.11	0.73	n.d.	n.d.	1.6±0.6 (0.5 – 2.4)	1.6±0.7 (0.5 – 2.4)
<i>E. sikokianus</i>	23.7±1.5 (21.6 – 26.4)	20.8±0.9 (19.2 – 22.1)	1.14	18.7±1.6 (15.6 – 20.6)	2.0±0.3 (1.7 – 2.9)	9.35	0.79	n.d.	n.d.	1.0±0.2 (0.7 – 1.2)	1.3±0.3 (1.0 – 1.9)

Table 3-1-2. Continued.

Taxon	P	E	P/E	Ecto-aperture			L/P	Endo-aperture		Apo. Exine Thickness	Meso. Exine Thickness
				Length (L)	Width (W)	L/W		Length	Width		
Section <i>Andromedina</i>											
<i>E. nudipes</i>	29.0±2.1 (25.2 – 32.2)	27.1±2.0 (24.0 – 30.0)	1.07	18.3±1.4 (16.3 – 20.4)	1.5±0.5 (1.2 – 2.4)	12.27	0.63	n.d.	n.d.	1.9±0.3 (1.4 – 2.4)	1.9±0.5 (1.4 – 2.6)
<i>E. subsessilis</i>	23.5±0.8 (22.8 – 24.8)	24.3±0.9 (23.3 – 25.9)	0.97	13.1±0.6 (11.6 – 14.0)	1.3±0.4 (0.7 – 1.9)	10.08	0.56	1.5±0.2	9.0±1.2	1.9±0.2 (1.7 – 2.1)	2.0±0.1 (1.8 – 2.1)
Section <i>Enkianthus</i>											
<i>E. perulatus</i>	27.1±0.8 (25.6 – 28.1)	27.9±1.1 (26.1 – 29.4)	0.97	16.8±0.7 (15.7 – 18.2)	1.3±0.6 (0.5 – 2.6)	12.92	0.62	1.3±0.6	6.0±1.7	1.8±0.1 (1.7 – 2.0)	1.7±0.2 (1.5 – 2.0)
<i>E. quinqueflorus</i>	28.5±0.7 (27.6 – 29.0)	29.9±1.3 (28.8 – 32.0)	0.95	16.1±1.9 (14.9 – 19.4)	1.8±0.4 (1.4 – 2.4)	8.94	0.56	n.d.	n.d.	2.0±0.3 (1.4 – 2.4)	1.5±0.3 (1.2 – 1.9)
<i>E. serotinus</i>	29.6±1.9 (26.4 – 33.6)	30.6±1.3 (28.8 – 33.1)	0.97	17.8±2.2 (14.9 – 22.8)	2.3±0.6 (1.7 – 3.8)	7.74	0.60	n.d.	n.d.	2.0±0.4 (1.2 – 2.4)	1.7±0.2 (1.4 – 1.9)

P: polar length, E: equatorial diameter, Apo.: apocolpial, Meso.: mesocolpial, n.d.: not discerned, minimum–maximum values in µm in parenthesis.

Two species of *Enkianthus*; *E. campanulatus* and *E. perulatus*, are studied with TEM. The apocolpial exine is composed of ektexine; tectum, columellae (rod-like elements distinct) and foot layer, and endexine with higher electron density (Fig. 3-3). Endexine is very thin or almost absent in *E. perulatus* (Figs. 3-3 D – F). Sexine (tectum + columellae) is ca. 0.5 μm thick and total exine is ca. 0.8 – 0.9 μm thick. A thin layer of pollenkitt is observed on the pollen surface of *E. perulatus* (Figs. 3-3 D – F). Intine is almost evenly thick around the pollen tetrad (Fig. 3-3), showing lower electron density than the endexine.

Discussion

Variation and distribution of palynological characters in *Enkianthus*

Pollen aperture in *Enkianthus* vary from 3-colpor(oid)ate to 5-colpor(oid)ate. However, 3-aperturate pollen is most common. Ueno (1950) observed that aperture number in *Enkianthus* pollen varied from three to four, while 3- to 5-aperturate pollen was observed by Ikuse (1956, 2001), Kurosawa (1991), Anderberg (1994), and Zhang and Anderberg (2002). Tricolpate pollen is the main and basic type found in most eudicots while other aperture types such as 5-colpate, 6-colpate, porate, colporate and pororate are regarded as derived among the eudicots (Walker and Doyle 1975). Three aperturate pollen in the sects. *Enkiantella* and *Meisteria* was shown by Anderberg (1994) to be a plesiomorphic character and four to five apertures in the sects. *Andromedina* and *Enkianthus* are more derived.

The aperture of the *Enkianthus* pollen is mainly colporate or colporoidate, but both types can be found in pollen of the same species; e.g., *E. deflexus* (Table 3-1-1). Sometimes colpi are constricted at the middle and/or rarely pollen is syncolpate as in *E. campanulatus*, where all 3 colpi are fused at one pole (Fig. 3-1 J). Granular colpus membrane in the outgroup and in most

species of *Enkianthus* indicate that this character is symplesiomorphic while the smooth colpus membrane of *E. campanulatus* and *E. deflexus* is thought to have evolved in parallel in these two species.

The ratio of colpus length to colpus width (L/W) does not vary greatly within the closely related species or in infraspecific taxa, except one specimen of *E. campanulatus* (Takahashi 511). It was very interesting that the colpus width of this specimen was significantly narrower than that of other two specimen of *E. campanulatus* (Unknown 0814, Hara et al. 21810) (Tables 3-1-1 – 3-1-2). This might be due to prevailing weather condition especially the amount of precipitation in that particular locality and year. But, I have no idea about the specific cause of this type of infraspecific variations on colpus width.

The ratio of colpus length to polar length (L/P) shows a distinct difference among the species (Table 3-1-2). The L/P value is relatively higher, ranging from 0.69 to 0.84 in the sects. *Enkiantella* and *Meisteria*, and relatively lower, ranging from 0.56 to 0.63 in the sects. *Andromedina* and *Enkianthus*. The higher L/P value of the *Enkiantella* + *Meisteria* might be symplesiomorphic for the genus prevailing also in Clethraceae, and the lower L/P value of *Andromedina* + *Enkianthus* might be a synapomorphic character state like other characters of these sections (Anderberg 1994).

Two distinct groups of pollen shape were found in *Enkianthus* (Table 3-1-1). Species of sects. *Enkiantella* and *Meisteria* have prolate spheroidal to prolate pollen (P/E 1.06 – 1.48) generally with relatively thinner exine. Species of sects. *Andromedina* and *Enkianthus* typically have oblate spheroidal (P/E 0.95 – 0.97) pollen with relatively thicker exine, with the exception of *E. nudipes* (Table 3-1-2), which has prolate spheroidal pollen (P/E 1.07). Prolate spheroidal pollen shape might be the plesiomorphic state while more derived states might have evolved independently; subprolate in *E. campanulatus* of sect. *Meisteria*; and oblate spheroidal in *E. subsessilis* of sect. *Andromedina*, and in sect. *Enkianthus* (Table 3-1-3; Fig. 3-4). Another

possibility is that the oblate spheroidal shape is synapomorphic for sects. *Andromedina* and *Enkianthus*, but revert to a plesiomorphic shape in *E. nudipes* of sect. *Andromedina*. It is possible that the oblate spheroidal pollen of the outgroup taxon *Clethra alnifolia* may have changed to the prolate spheroidal state in the ancestor of *Enkianthus* and evolved again to apomorphic state oblate spheroidal. This supposition is supported by evolutionary trend of other characters (Anderberg 1994).

All taxa examined in this study have pollen of almost similar size (24 – 30 μm) except *E. cernuus*, which has the smallest grains (17 μm) with thinner exine (Table 3-1-2). Minute pollen might possibly represent a symplesiomorphic state and medium grains a synapomorphic state for section *Enkianthus*. However, like pollen shape, the medium pollen size could have evolved independently in *E. campanulatus* of sect. *Meisteria* and in *E. nudipes* of sect. *Andromedina* (Table 3-1-3; Fig. 3-4) or be a synapomorphic state for in sects. *Meisteria*, *Andromedina* and *Enkianthus*, but reverts to a plesiomorphic state in *E. cernuus* of sect. *Meisteria* and *E. subsessilis* of sect. *Andromedina*.

Exine sculptures within the genus show a more or less continuous and serial variation from finely verrucate to coarsely rugulate and coarsely rugulate-psilate sculpture (Figs. 3-4, 3-5 C – J). Another trend in sculpture might be from finely verrucate (Fig. 3-5 C) to finely gemmate-psilate (Figs. 3-5 A, B). Since the variation in exine sculpture from psilate to finely verrucose has been observed in the genus *Clethra*, the synapomorphic state for the genus *Enkianthus* is not clear. But considering the evolutionary trend of other characters (Anderberg 1994), the coarsely rugulate-psilate sculpture might be the most specialized character state in the genus. Similarities and relationships between the different types of exine sculpturing are summarized in Figure(s) 3-4 and 3-5, and discussed in the latter part based on the infraspecific variation.

In *E. cernuus* and a Bhutanese specimen (Hara et al. 21810) of *E. deflexus*, the pollen grains were very often shrunken, and probably susceptible to acetolysis. Therefore, it was difficult

to study these pollen grains with LM and SEM. Shrinkage might be due to poorly developed exine caused by genetic abnormalities and/or obstruction during pollen development process.

Taxonomic significance of pollen characters

Section *Enkiantella* is the sister-group to all other species of *Enkianthus* (Anderberg 1994). Pollen of *Enkianthus chinensis* and *E. deflexus* of this section are commonly 3-aperturate, minute, prolate spheroidal in shape and exine sculpture finely verrucate (Type FV). This result supports the earlier findings of 3-colpor(oid)ate pollen for the two *Enkianthus* species in the LM study by Fuhsiung et al. (1995). Both *E. chinensis* and *E. deflexus* are very similar to each other in external morphology and sometimes *E. chinensis* has been treated as a variety of *E. deflexus* (*E. deflexus* var. *chinensis*, Hara 1966) and some plants with intermediate characters (e.g., leaf size, shape, indumentum etc.) have been observed (see specimens examined in Appendix II). Close similarity between the two species is also strongly supported by other pollen features (Table 3-1-3; Fig. 3-4), but the investigation of further specimens is needed to clarify the status of these two taxa. The two taxa share several symplesiomorphic characters with *E. campanulatus*, which differs by having villous anther filaments and by lacking the densely lamellate seed surface (Anderberg 1994). However, the two taxa share more ancestral palynological characters with *E. cernuus* than with *E. campanulatus* (Table 3-1-3; Fig. 3-4). Intraspecific palynological variations in *E. deflexus*; i.e., 3-colporoidate, minute, prolate spheroidal grains in cultivated Japanese specimen, 3 – (4)-colporate, minute, subprolate grains in the Bhutanese specimen and 3 – (4)-colporate, mediae, prolate spheroidal grains in the Chinese specimen, were found to correspond to geographical distribution (Table 3-1-1). Geographical variation in the aperture number of *Monotropa hypopitys* was reported by Takahashi (1987a). Intraspecific difference of the pollen aperture number might be caused by the following reasons: i) ploidy level and/or pollen size (Lewis 1964), ii) dimorphic

flower (Kaplan and Mulcahy 1971). Further study is necessary to clarify the infraspecific palynological variation in *E. deflexus*.

Section *Meisteria*, the sister-group of the sects. *Andromedina* and *Enkianthus* (Anderberg 1994), includes the three Japanese species, *E. campanulatus*, *E. cernuus* and *E. sikokianus*. All three species have campanulate flowers arranged in racemose type of inflorescence, hairy pedicel, erect capsule, winged seeds, and a common type of pollen with three apertures. A wide inter- and infra-specific variation, both in apomorphic and plesiomorphic palynological characters, were, however, observed (Table 3-1-1; Figs. 3-1 M – O, 3-2 A – H, 3-5). Exine sculpture varies from finely verrucate (Type FV) to finely gemmate-pilate (Type FG) within the section. Infraspecific variation in exine sculpture occur; e.g., exine sculpture of *E. campanulatus* and *E. campanulatus* var. *palibinii* is finely verrucate (Figs. 3-1 M – O, 3-2 B), but that of *E. campanulatus* var. *longilobus* is intermediate between rugulate granulate and finely verrucate (Fig. 3-2 A). Pollen characters of *E. campanulatus* (e.g., 3 – (4)-colpor(oid)ate grains, finely verrucate exine sculpture) are similar to those observed for *E. chinensis* and *E. deflexus* of the sect. *Enkiantella* (Table 3-1-1). Anderberg (1994) also reported similarities among these three species. Few abnormal grains with coarsely rugulate exine sculpture with transversely striate rugulae were found in *E. campanulatus* (Fig. 3-1 I). Anderberg (1994) considered *E. campanulatus* as a variable species; it includes a number of taxa earlier recognized as separate species, e.g., *E. longilobus* (Nakai) Ohwi, *E. rubicandus* Matsum. & Nakai, *E. sikokianus* (Nakai) Ohwi, *E. kikuchi-masaoi* Mochizuki. The results of this palynological study do not support this circumscription of *E. campanulatus*. *Enkianthus sikokianus*, in particular, is distinct from the other taxa in having minute grains with thinner exine, mesocolpial exine sculpture with more densely spaced granules (RG/FV or Type FG; Figs. 3-2 G – H). When considering the differences in length of inflorescence and pedicels, as well as in number of flowers between *E. sikokianus* and *E. campanulatus* (Yamazaki 1993a), *E. sikokianus* should be recognized as a separate species.

Similar infraspecific variation of exine sculpture was also found between *E. cernuus* (Fig. 3-2 C) and *E. cernuus* f. *rubens* (Figs. 3-2 D – F) and variation within the same taxa; *E. campanulatus* (Figs. 3-1 M – O), *E. cernuus* f. *rubens* (Figs. 3-2 D – F), *E. sikokianus* (Figs. 3-2 G – H) and *E. nudipes* (Figs. 3-2 I – J) respectively, was also observed. The palynological characteristics of *E. cernuus* f. *rubens* (e.g., indistinct ora, exine sculpture Type FG, but with minute granules-spinules) showed significant differences among the other members of this section (Table 3-1-1, Figs. 3-2 D – F).

Section *Andromedina* contains two species, *E. nudipes* and *E. subsessilis*, and is the sister-group of sect. *Enkianthus* (Anderberg 1994). Both species have racemose inflorescence, 4-aperturate pollen, amb relatively angular, exine sculpture coarsely rugulate-psilate with minute granules (Type RG), smooth anther, urceolate corolla, glabrous pedicel, and wingless seeds. The exine of the pollen in species of *Andromedina* is somewhat thicker than that of other subgenera (Ueno 1950). *Enkianthus subsessilis* and *E. nudipes* share many palynological characters with those of sect. *Enkianthus* (Table 3-1-3; Fig. 4). *Enkianthus nudipes* has 4 – (5)-aperturate pollen, medium size, exine sculpture coarsely rugulate-psilate and flowers with urceolate corolla, similar to those of *E. perulatus* (Table 3-1-1; Figs. 3-2 J, M), and *E. nudipes* and *E. perulatus* could form a taxonomical bridge/link between the sects. *Andromedina* and *Enkianthus*.

Section *Enkianthus*. Pollen morphology has been studied for three species, *E. perulatus*, *E. quinqueflorus* and *E. serotinus*, from the sect. *Enkianthus* (Anderberg 1994). All taxa have more or less coriaceous leaves, and umbellate inflorescence. This section possesses the most stable palynological character states compared to those of other sections in the genus (Table 3-1-3; Fig. 3-4). Pollen are medium sized, oblate spheroidal, 4 – 5-aperturate, amb relatively circular and exine sculpture moderately to coarsely rugulate-psilate with minute granules (Type RG), and these characters might be more derived within the genus. The Chinese species, *E. quinqueflorus* and *E. serotinus*, are closely similar to each other in regards to external morphology and differ

only in minor details (Hsu 1982, Anderberg 1994, Fang and Stevens 2005). This is also supported by the pollen data. *Enkianthus quinqueflorus* and *E. serotinus* have flowers with a tubular corolla probably derived from ancestors with urceolate corollas, i.e. the condition in the *E. perulatus*, and in the sect. *Andromedina*. Anderberg (1994) considered the sect. *Enkianthus* as a monophyletic specialized group within the genus, comprising all taxa with flowers in umbels, 4 – 5-aperturate pollen, and increasingly smooth anther.

Phylogenetic significance of pollen characters

Ueno (1950) observed 3-aperturate pollen for *E. campanulatus* and *E. cernuus* from the sect. *Meisteria*, and Anderberg (1994) reported 3-aperturate pollen in both the sects. *Enkiantella* and *Meisteria*. However, pollen with (2) – 3 – (4) apertures were found in the sect. *Enkiantella* and 3 – (4) apertures in the sect. *Meisteria* in this study (Table 3-1-1), though the frequency of 2- or 4-aperturate pollen grains was low. Anderberg (1994) found pollen with frequent presence of five apertures only for one species, *E. perulatus*, in the sect. *Enkianthus*, as *E. taiwanianus* seems to be synonymous with *E. perulatus* (Li et al. 1998, p.17) while Ueno (1950) did not observe any 5-aperturate grains. According to our observation, 5-aperturate pollen occurs commonly in sect. *Enkianthus* and few 5-aperturate pollen are also found in *E. nudipes* of the sect. *Andromedina*. Furthermore, Ikuse (2001) reported the occurrence of 5-colporate grains in *E. subsessilis* of the sect. *Andromedina*. So the position of character state change (character 18.2) in Anderberg (1994, Fig. 9, App. 3) should be modified. Four apertures generally characterize the sect. *Andromedina*, and 4 – 5 apertures characterize sect. *Enkianthus*.

No subdivision in pollen types corresponding to the sections could be identified. However, some morphological trends were noticed in pollen, in regards to aperture number, size, shape, and exine sculpture and based on pollen features two distinct groups are distinguished; “prolate 3-aperturate pollen” characterizing the sects. *Enkiantella* and *Meisteria* and the other, “oblate 4 – 5-

aperturate pollen” characterizes the sects. *Andromedina* and *Enkianthus*, (Table 3-1-1). Pollen in sects. *Enkiantella* and *Meisteria* is commonly 3-aperturate, prolate spheroidal to prolate (P/E 1.06 – 1.48), L/P 0.69 – 0.84, with relatively thinner exine and exine sculpturing with a tendency to granulate (Types FV and FG). Pollen in the sects. *Andromedina* and *Enkianthus* is 4 – 5-aperturate, commonly oblate spheroidal (P/E 0.95 – 0.97), L/P 0.56 – 0.63, with relatively thicker exine and exine sculpturing with a tendency to coarsely rugulate-psilate with granules (Type RG) (Table 3-1-2). However, it seems difficult to differentiate between sections of the same group on the basis of palynological characters only.

The species of sects. *Enkiantella* and *Meisteria* have plesiomorphic characters such as racemose inflorescence, campanulate and actinomorphic flower, and 3-aperturate pollen grains. Anderberg (1994) concluded that the ancestors of Ericaceae were similar to *Enkianthus chinensis* or *E. campanulatus* in many respects. Therefore, 3-aperturate, minute, and prolate spheroidal to prolate pollen grains with finely verrucate exine sculpture with minute granules (Type FV) may possibly be a plesiomorphic character in the genus. The species of the sect. *Enkianthus*, on the other hand, have umbellate inflorescence and 4 – 5-aperturate, medium, and oblate spheroidal pollen with exine sculpture coarsely rugulate with minute to mostly without granules (Types RG and R), and are regarded as advanced. Anderberg (1994) found a similar trend, whereby racemes evolved into umbels in the inflorescence of *Enkianthus*.

Evidence suggests that the major trend in exine sculpture is from finely verrucate through coarsely rugulate to coarsely rugulate-psilate with distinct to faint granules in the genus *Enkianthus* (Fig. 3-5 C – J). But since a wide infrageneric variation of exine sculpture is observed in the Ericaceae and its related groups; e.g., psilate to verrucose in (Zhang and Anderberg 2002), we have to consider the character states of exine sculpture very carefully.

Table 3-1-3. Matrix of palynological characters and taxa. Pollen observation of *Clethra alnifolia* referred to Zhang and Anderberg 2002.

Pollen Characters	A	B	C	D	E	F
<i>Clethra alnifolia</i>	0	0	0	2	0	4
<i>E. deflexus</i>	0	1	0	0	0	0
<i>E. chinensis</i>	0	0	0	0	0	0
<i>E. cernuus</i>	0	0	0	0	0	1
<i>E. campanulatus</i>	0	1	0	1	1	0
<i>E. subsessilis</i>	1	0	1	2	0	2
<i>E. nudipes</i>	1	0	1	0	1	2
<i>E. perulatus</i>	2	0	1	2	1	3
<i>E. quinqueflorus</i>	2	0	1	2	1	2
<i>E. serotinus</i>	2	0	1	2	1	2

Explanation of symbol:

A. Pollen with mainly 3 apertures (0); with mainly 4 apertures (1); with 4 to 5 apertures (2)

B. Colpus membrane granulate (0); smooth (1)

C. L/P 0.69 – 0.84 (0); 0.56 – 0.63 (1)

D. Pollen grains prolate spheroidal (0); subprolate (1); oblate spheroidal (2)

E. Pollen grains minute (0); medium (1)

F. Exine sculptures FV (0); FG (1); RG (2); R/RG (3); psilate (4)

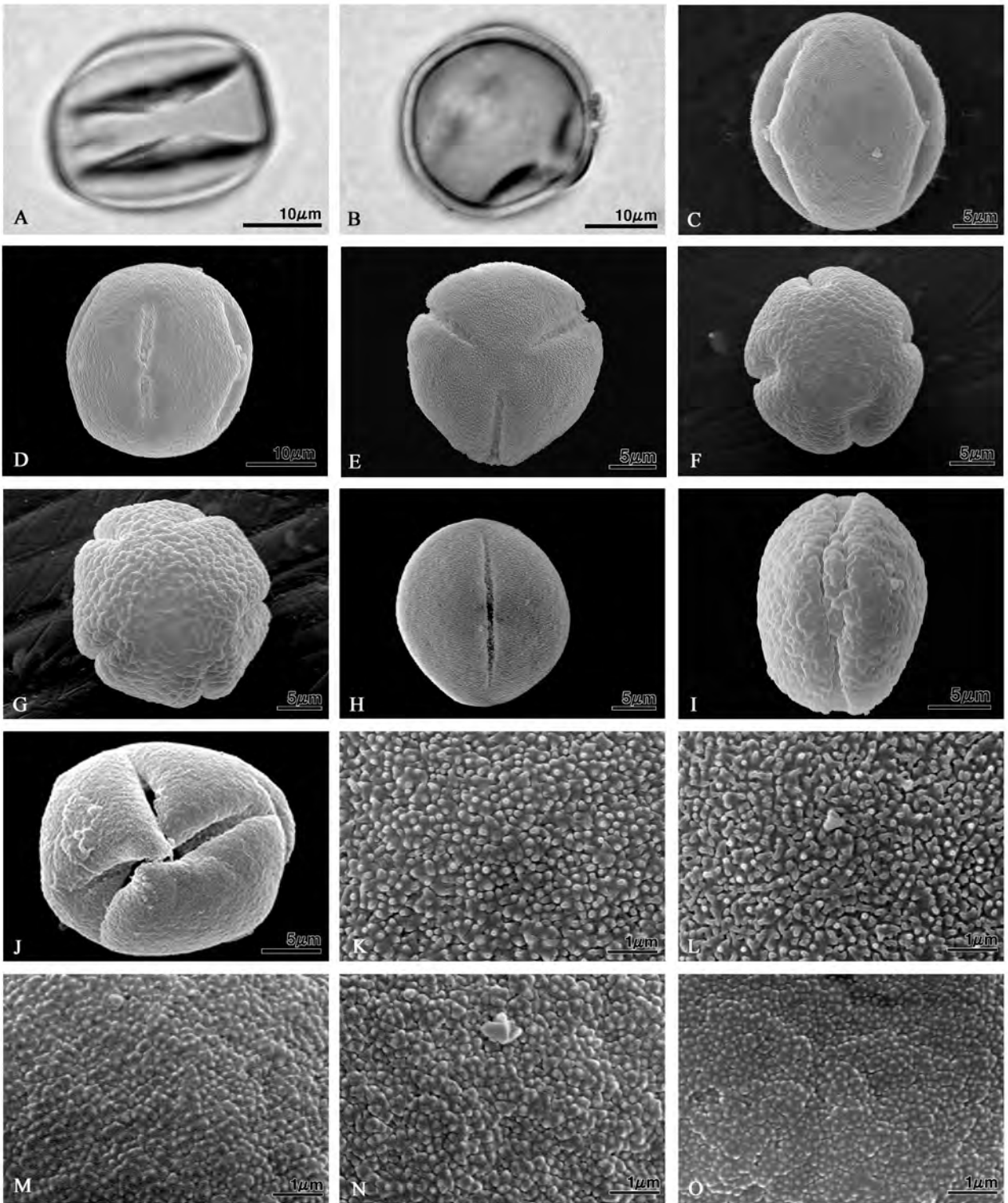

Fig. 3-1.

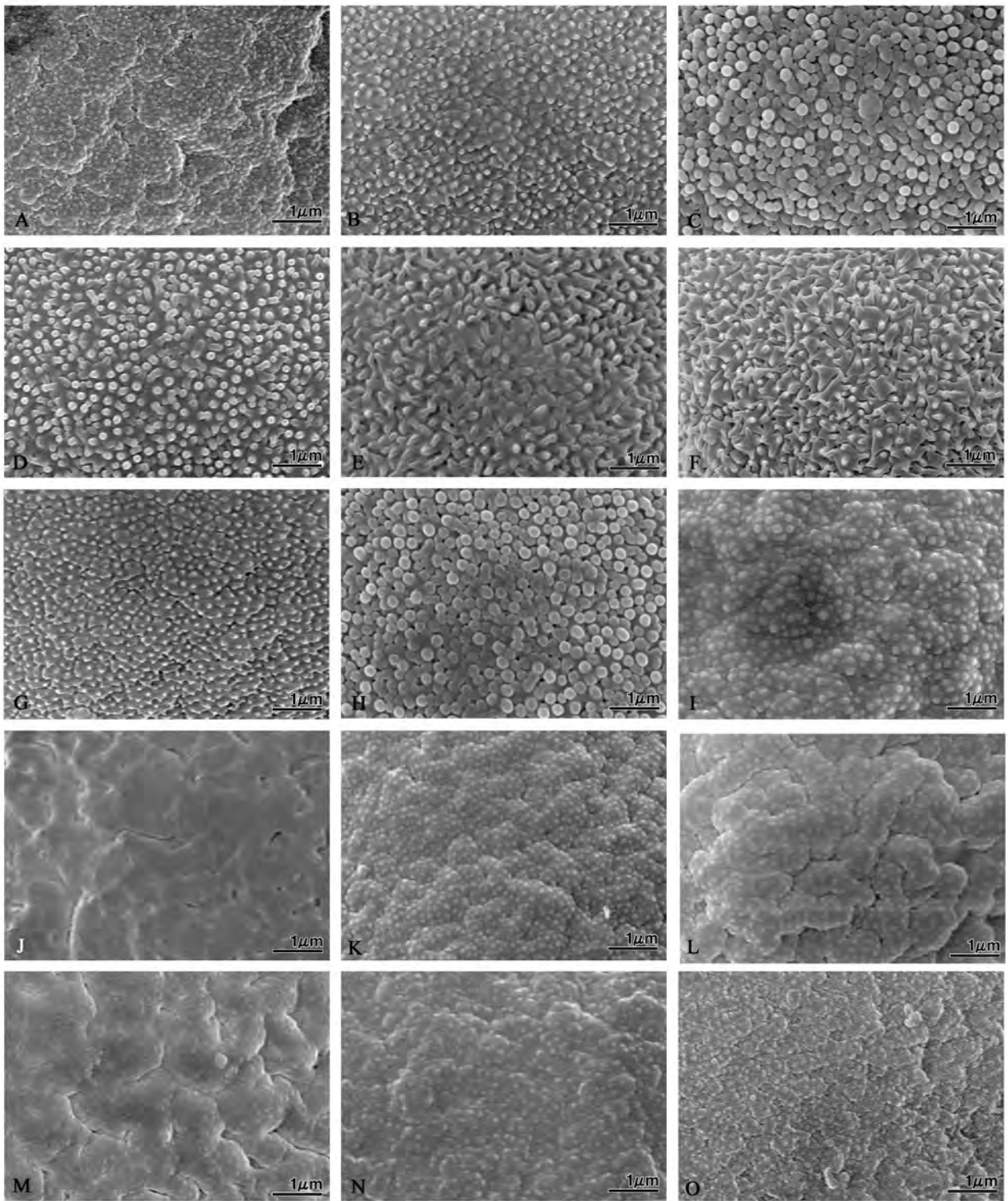

Fig. 3-2.

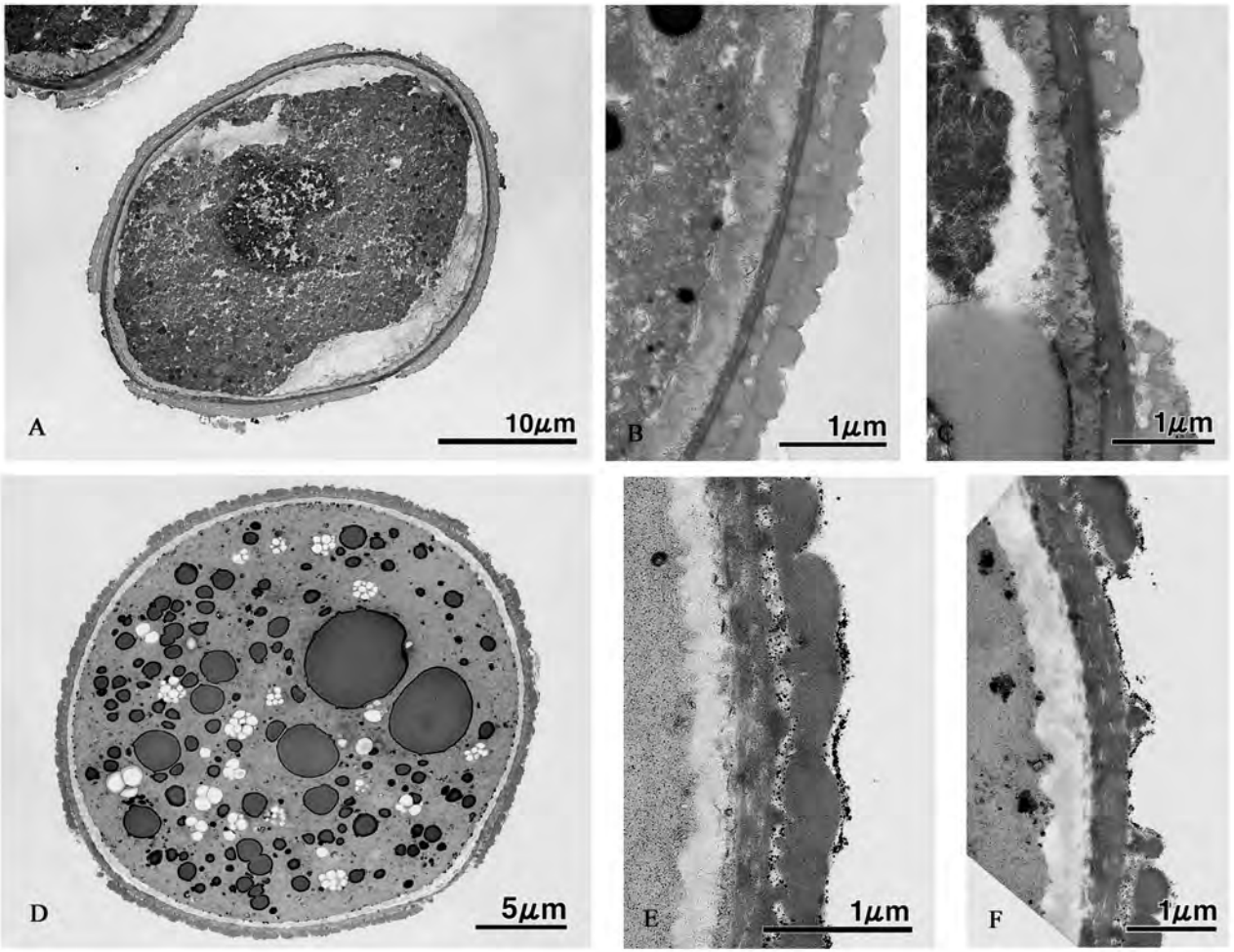

Fig. 3-3.

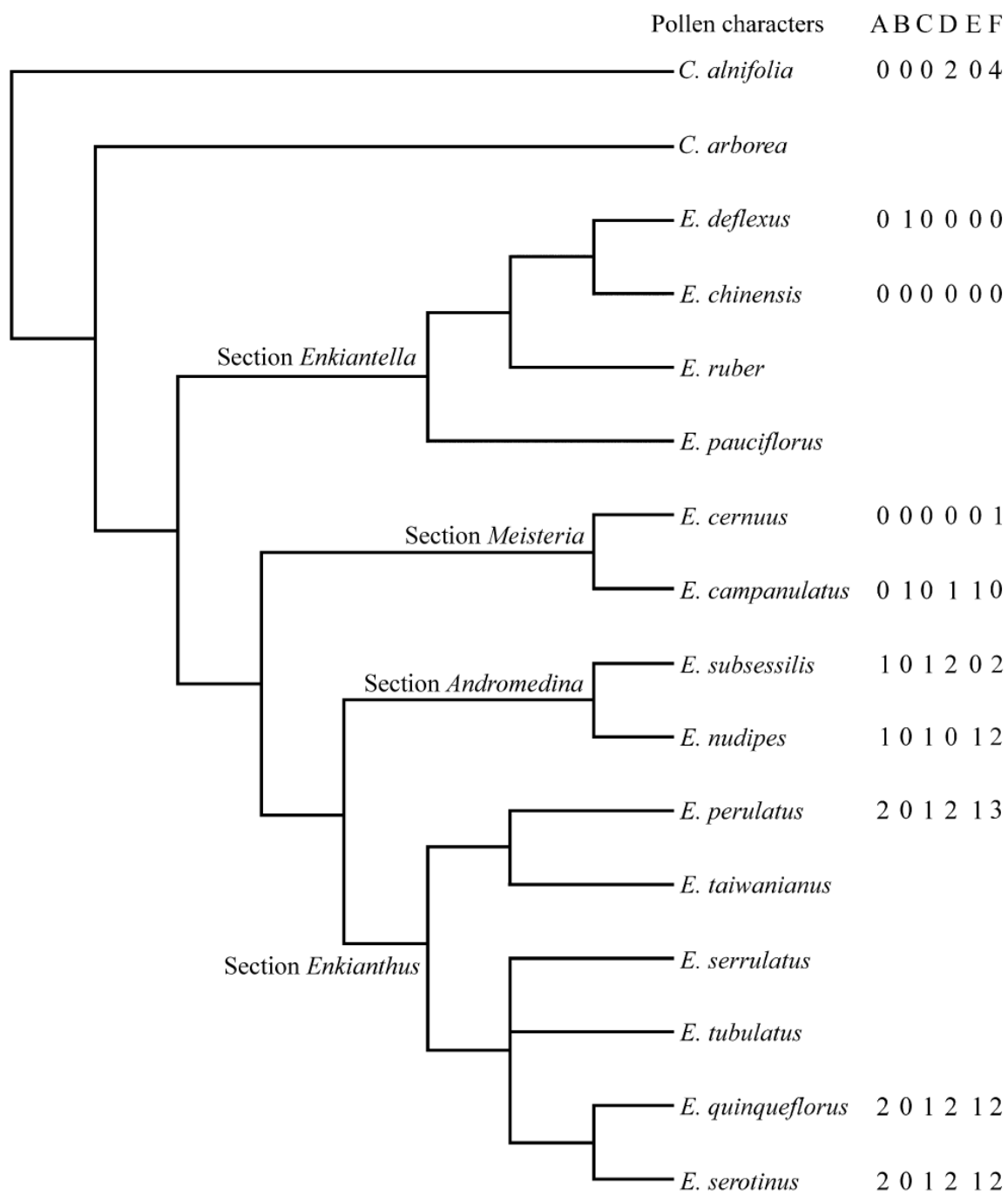

Fig. 3-4. Palynological data incorporated on the phylogenetic tree of *Enkianthus* by Anderberg (1994);

C. - *Clethra*; *E.* - *Enkianthus*. For character states see Table 3-1-3.

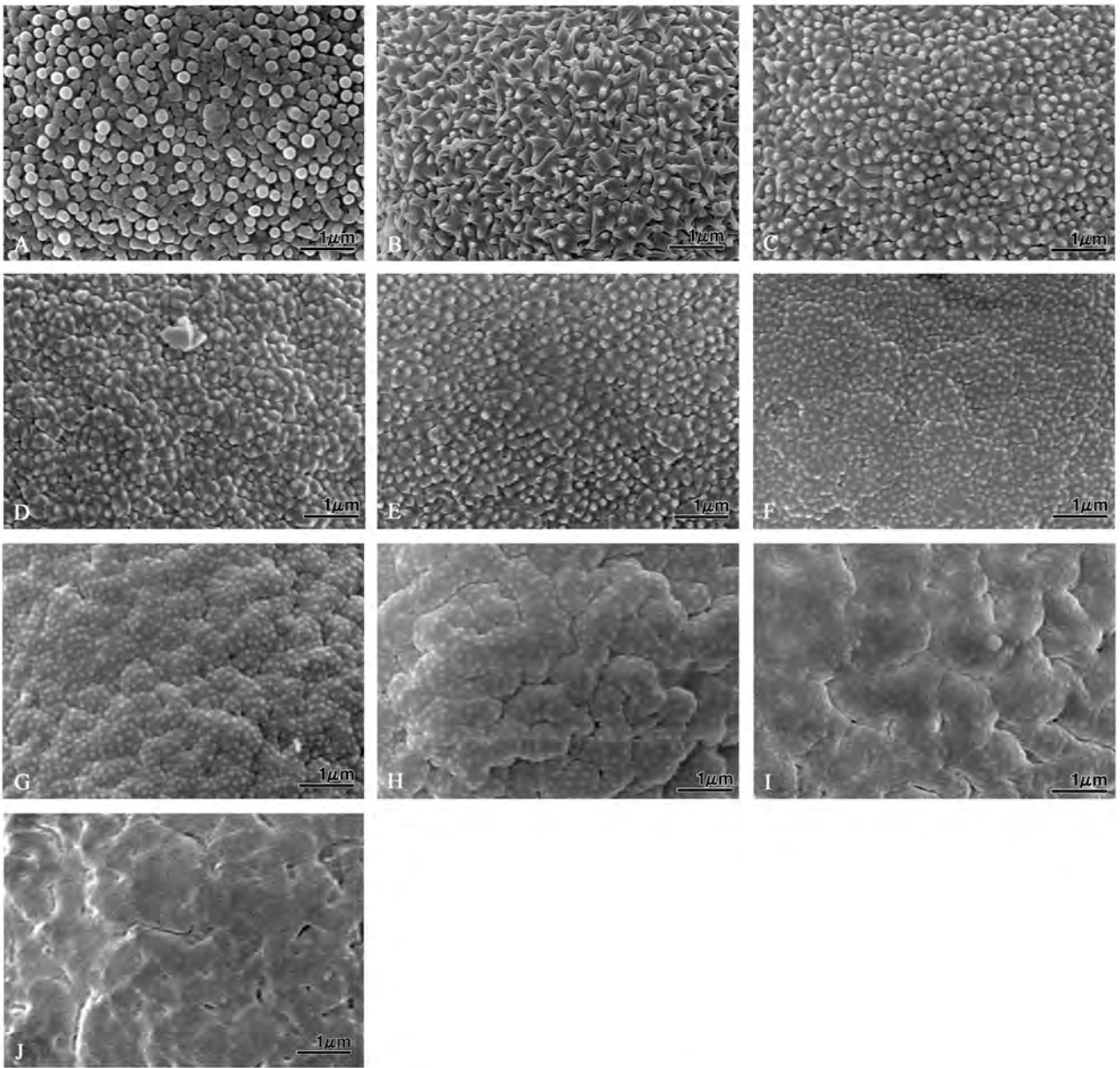

Fig. 3-5. Morphological variation of mesocolpial exine sculpture (with SEM).

3-2 Subfamily Arbutoideae

Introduction

The Arbutoideae Nied. is a small subfamily of Ericaceae. It comprises four genera: *Arbutus*, *Arctostaphylos* (including *Arctous* and *Xylococcus*), *Comarostaphylis* and monotypic *Ornithostaphylos*, and about 85 species (Kron and Luteyn 2005). Subfamily Arbutoideae was previously recognized as one of the five tribes, Arbuteae of the subfamily Vaccinioideae *sensu* Stevens (1971). Genera included in this subfamily form a distinct and natural group within the Ericaceae based on fruit and flower morphology, as well as anatomy, phytochemistry and molecular data (Cox 1948, Stevens 1971, Kron et al. 2002a). The Arbutoideae are dry adapted sclerophyllous taxa, commonly shrubs or small trees and most of the diversity in the group is in the regions of mediterranean climate in western North America (Hileman et al. 2001). They have also circumarctic *Arctostaphylos alpina*, and circumboreal *Arctostaphylos uva-ursi* distribution, and also occur in Mediterranean regions of Europe, North Africa, the Middle East, and the Canary Islands (detail distribution map in Fig. 1-1).

Pollen morphology of only two *Arbutus* species and three *Arctostaphylos* species of this subfamily has been reported in number of previous studies and mostly based on light microscopic observations (e.g., Rosatti 1988). However, species like *Arbutus unedo*, *Arctostaphylos alpina*, and *A. uva-ursi*, have been studied repeatedly and the data from pollen morphology not been used significantly for classification purpose of these two genera. The only study of *Comarostaphylis* pollen indicated few differences that would be useful in distinguishing taxa within this genus (Diggs 1995a). The aims of the present study were to investigate the pollen morphology of this subfamily in comprehensive detail with LM, SEM and TEM, and to discuss the new palynological observations in light of the recent classification of this subfamily (Kron et al. 2002a).

Results

Pollen morphology of subfamily Arbutoideae [4 genera / 3 genera examined: *Arbutus*, *Arctostaphylos* and *Comarostaphylis*]

Pollen grains are commonly united in both normal and compact tetrahedral tetrad; viscin threads absent. In range of average values of the specimen, D 38.8 – 54.4 μm , P 19.0 – 28.5 μm , E 31.1 – 44.1 μm , D/d 1.12 – 1.29, P/E 0.59 – 0.67, oblate, rarely circular. Three aperturate, apertures arranged according to “Fischer’s Law”, colpor(oid)ate, colpi distinct, 2f 22.1 – 34.3 μm , W 0.5 – 2.8 μm , 2f/W 7.89 – 64.80, 2f/D 0.44 – 0.68, significantly wider at middle, colpus tip generally acute, sometimes (slightly) tapering towards ends or bifurcated, colpus margin distinct. Costae usually present and distinct, but indistinct in some species, endocracks absent or indistinct, sometimes distinct in some species. Endoaperture distinct, but indistinct in *Arctostaphylos bakeri* and *A. crustacea*, lalongate, sometimes not clear, 0.7 – 2.9 μm long, 5.8 – 14.9 μm wide. Exine tectate, apocolpial exine 1.6 – 3.8 μm thick, septum 0.6 – 1.9 μm thick, perforated in *Arctostaphylos* and *Comarostaphylis*, apocolpial exine sculpture varied from verrucate to rugulate, sometimes psilate.

In SEM, pollen surface varies from uneven and rugged to somewhat flat, 1) primary apocolpial exine sculpture varies from moderate to coarsely rugulate-psilate, the rugulae with secondary sculpture unit minute striate (Type RS; Figs. 3-6 E, M – O, 3-7 D, 3-8 C, E); or 2) primary exine sculpture varies from moderate to coarsely rugulate, the rugulae without any distinct secondary (Type R; Figs. 3-7 B, H); or 3) exine sculpture coarsely rugulate-psilate with minute (diam. < 0.2 μm) granules (Type RG; Figs. 3-7 J – K); or 4) intermediate types (R/RG; Fig. 3-6 D, RG/RS; Figs. 3-6 G, I, R/RS; Fig. 3-7 F). Sometimes colpus is narrow and elongate, and apocolpial area smaller. Exine sculpture along the colpi is similar to that appearing at distal pole. The mesocolpial exine commonly has a tendency to decrease in lateral extension of the rugulae

with more distinct units (e.g., Fig. 3-6 F), but the rugulae are similar width at both apocolpial and mesocolpial position/region (e.g., Figs. 3-7 C – D). Colpus membrane is commonly granular, sometimes with large granules or a tendency towards granuloid (Table 3-2-1).

Two taxa of this subfamily; *Arctostaphylos andersonii* and *Comarostaphylis glaucescens*, has studied with TEM. The apocolpial exine is composed of ectexine; tectum, columellae (rod-like elements distinct) and foot layer, and endexine with higher electron density (e.g., Fig. 3-7 M). Sexine is ca. 0.8 – 0.9 μm thick and a total exine is ca. 1.6 – 1.9 μm thick (Figs. 3-7 M – N, 3-8 G – H). In the proximal exine (septum), tectum is lacking and two foot layers of adjacent grains are connected by columellae (Figs. 3-7 O, 3-8 I); septum is ca. 0.4 – 1.2 μm thick, and thicker towards peripheral regions. Intine is thick showing lower electron density than the endexine at both apocolpial and septal exine, and relatively thicker at aperture region. Like LM, the characteristic septum with perforations is also observed and confirmed by TEM observations (Figs. 3-7 O, 3-8 I).

Arbutus [10 spp. / 4 spp. examined: *A. andrachne*, *A. canariensis*, *A. menzeisii* and *A. texana*]

Pollen grains are in compact tetrahedral tetrad, rarely normal in *A. canariensis*, sometimes pollen grain broken along the colpi in *A. menzeisii*; viscin thread absent; D 45.0 – 52.5 μm , P 22.6 – 26.8 μm , E 36.4 – 41.4 μm , D/d 1.23 – 1.29, P/E 0.62 – 0.67, oblate; 3-colporate, 2f 23.3 – 34.3 μm , W 0.9 – 2.0 μm , 2f/W 11.65 – 36.78, 2f/D 0.44 – 0.68, significantly wider at middle, acute towards end, costae present and distinct, colpus margin distinct, thick and bifurcate in *A. andrachne*; endocracks absent or indistinct; endoaperture lalongate, 1.6 – 2.9 μm long, 7.5 – 14.9 μm wide; apocolpial exine 1.8 – 2.8 μm thick, septum 1.1 – 1.9 μm thick; tectate, exine sculpture finely verrucate to rugulate.

In SEM, 1) pollen surface is somewhat flat, apocolpial exine sculpture coarsely rugulate-psilate with minute (diam. < 0.2 μm) striate (Type RS), tectum faintly perforated (Figs. 3-6 E), or

2) surface varies from uneven and rugged to somewhat flat, sculpture coarsely rugulate-psilate and intermediate types (R/RG or RG/RS), tectum faintly to clearly perforated (Fig. 3-6 D, G, I); colpus membrane granulate, rarely granuloid (Table 3-2-1).

Arctostaphylos [60 spp. / 11 spp. examined: *A. andersonii*, *A. auriculata*, *A. bakeri*, *A. crustacea*, *A. densiflora*, *A. glauca*, *A. nevadensis*, *A. nummularia*, *A. patula*, *A. pungens* and *A. viscida*]

Pollen grains are in compact tetrahedral tetrad, many grains sometime shrunk in *A. nevadensis*, circular in shape in one specimen of *A. nummularia* (Rose s.n.); viscin thread absent; D 38.8 – 54.4 μm , P 19.0 – 28.5 μm , E 31.1 – 44.1 μm , D/d 1.17 – 1.23, P/E 0.59 – 0.64, oblate; 3-colpor(oid)ate, 2f 22.1 – 34.2 μm , W 0.5 – 2.8 μm , 2f/W 7.89 – 64.80, 2f/D 0.51 – 0.66, significantly wider at middle, acute towards end, narrow and elongate in *A. crustacea*, costae present and distinct, colpus margin distinct; endocracks commonly absent or indistinct, but distinct in *A. andersonii*, *A. bakeri* and *A. glauca*; endoaperture lalongate, 0.7 – 2.1 μm long, 5.8 – 10.9 μm wide; apocolpial exine 1.6 – 3.8 μm thick, septum 0.6 – 1.9 μm thick, perforated, micro-pit present at periphery of septum in *A. viscida*; tectate, exine sculpture verrucate to rugulate or psilate.

In SEM, 1) pollen surface is uneven and rugged, apocolpial exine sculpture coarsely rugulate-psilate with minute (diam. < 0.2 μm) striate (Type RS; Figs. 3-6 M – N, 3-7 C, E); or 2) exine sculpture coarsely rugulate (Type R; Figs. 3-7 B, H); or 3) exine sculpture coarsely rugulate-psilate with minute (diam. < 0.2 μm) granules (Type RG; Figs. 3-7 J – K); or 3) intermediate type (R/RS; Fig. 3-7 F); colpus membrane granulate (Table 3-2-1).

In TEM for *A. andersonii*, the apocolpial exine is composed of ektexine and endexine (Fig. 3-7 M – O). Sexine is ca. 0.8 μm thick and a total exine is ca. 1.6 μm thick. The proximal exine (septum) is ca. 0.4 – 0.7 μm thick (Fig. 3-7 O). The exine in LM appears about 2 times thicker than in TEM. Intine is almost evenly thick around the pollen tetrad.

Table 3-2-1. Pollen morphological data of subfamily Arbutioideae based on light microscopic investigation.

Name of Taxa	Config-uration ¹	D ²	P ³	D/d ⁴	P/E ⁵	2f ⁶	2f/W ⁷	2f/D ⁸	Apo. Exine thickness ⁹	Septum thickness ¹⁰	Orname-ntation ¹¹	Colpus Memb. ¹²	Remarks ¹³
<i>Arbutus andrachne</i>	CT	IV	IV	II	I	III	IV	V	IV	III	R/RG	G/Gr	3, 4
<i>A. canariensis</i>	T	IV	IV	II	I	II	II	III	III	II	RS	Gr/LG	
<i>A. menziesii</i>	CT	III	III	II	I	II	II	V	IV	II	RG/RS	G	2, 3
<i>A. texana</i>	CT	IV	IV	II	II	III	II	V	II	II	RG/RS	G	
<i>Arctostaphylos</i>													
Subgenus <i>Arctostaphylos</i>													
Section <i>Foliobracteata</i>													
<i>A. andersonii</i>	CT	III	III	I	I	II	II	IV	III	IP	RS	G	3, 6
<i>A. auriculata</i>	CT	III	III	I	I	II	II	V	II	IP	RS	?	3, 5
<i>A. crustacea</i>	CT	IV	IV	II	I	III	VII	V	III	IP	R/RS	G	7
<i>A. glauca</i>	CT	III	III	II	I	II	II	IV	III	IP	R	G	5, 6
<i>A. patula</i>	CT	II	II	I	I	II	II	IV	II	IP	-	?	5
Section <i>Arctostaphylos</i>													
<i>A. bakeri</i>	CT	III	III	II	I	II	V	V	IV	IP	RS	G	3, 6, 7
<i>A. densiflora</i>	CT	III	III	II	I	II	II	IV	II	IP	RS	LG	
<i>A. nevadensis</i>	CT	III	IV	II	I	II	II	IV	V	IP	R/RS	G	5, 8
<i>A. viscida</i>	CT	II	II	II	I	II	I	IV	II	III (P)	R	G	3
Subgenus <i>Micrococcus</i>													
Section <i>Micrococcus</i>													
<i>A. nummularia</i> Rose s.n.	CT	III	III	II	I	II	II	IV	III	III	RG	?	3
Rose 61009	CT	III	III	II	I	II	II	IV	III	IP	RG	G	5
<i>Comarostaphylis discolor</i>													
ssp. <i>discolor</i> Pringle 6815	CT	III	III	I	I	II	II	V	II	IP	RS	LG	1, 3
Steyermark 5059b	CT	II	II	I	I	II	III	IV	III	IP		G	
<i>C. glaucescens</i>	CT	III	III	I	I	III	II	V	III	IP	RS	LG	2, 6

D: tetrad diameter, P: polar length, d(E): equatorial diameter, 2f: ectoaperture length, W: ectoaperture width, Apo.: apocolpial, Memb.: membrane.

¹T: Tetrahedral tetrad, CT: Compact tetrahedral tetrad

²II: 30.1 – 40.0 µm, III: 40.1 – 50.0 µm, IV: 50.1 – 60.0 µm

³II: 15.1 – 20.0, III: 20.1 – 25.0, IV: 25.1 – 30.0

⁴I: – 1.19, II: 1.20 – 1.29

⁵I: – 0.65, II: 0.66 – 0.75

⁶I: 10.1 – 20.0 µm, II: 20.1 – 30.0 µm, III: 30.1 – 40.0 µm

⁷I: – 10.0, II: 10.1 – 20.0, III: 20.1 – 30.0, IV: 30.1 – 40.0, V: 40.1 – 50.0,

VI: 50.1 – 60.0, VII: 60.1 –

⁸III: 0.41 – 0.50, IV: 0.51 – 0.60, V: 0.61 – 0.70

⁹I: 1.1 – 1.5 µm, II: 1.6 – 2.0 µm, III: 2.1 – 2.5 µm, IV: 2.6 – 3.0 µm, V: 3.5 µm –

¹⁰I: – 1.0 µm, II: 1.1 – 1.5 µm, III: 1.6 – 2.0 µm, P Perforated

¹¹Exine ornamentation type by SEM corresponding to Fig. 3.

¹²G Granulate, LG Largely granulate, Gr Granuloid, S Smooth, ? Not known

¹³1: Tetrad circular, 2: Sometimes broken along colpi, 3: Apocolpial region small 4: Costae thick,

5: Costae indistinct, 6: Endocracks distinct, 7: Endoaperture indistinct, 8: many grains sometime

shrink

Table 3-2-2. Variation in pollen characters of subfamily Arbutoideae showing mean value in μm and standard deviation.

Name of Species	D	P	d	D/d	P/E	Ectoaperture			2f/D	Endoaperture		Apo. exine thickness	Septum thickness
						Length (2f)	Width (W)	2f/W		Length	Width		
<i>Arbutus andrachne</i>	51.1±2.4 (48.7-56.1)	26.8±2.1 (23.1-29.7)	41.4±1.9 (38.0-44.6)	1.23	0.65	33.1±2.3 (31.4-38.0)	0.9±0.3 (0.5-1.3)	36.78	0.65	2.9±0.8 (2.0-4.1)	7.5±1.8 (5.0-9.9)	2.8±0.2 (2.5-3.0)	1.9±0.2 (1.7-2.1)
<i>A. canariensis</i>	52.5±1.6 (50.2-56.0)	26.1±1.2 (24.1-27.7)	40.7±1.7 (38.8-44.6)	1.29	0.64	23.3±1.7 (19.8-24.8)	2.0±0.3 (1.3-2.5)	11.65	0.44	1.6±0.4 (0.7-2.0)	14.7±2.3 (11.6-18.2)	2.2±0.5 (1.7-3.1)	1.1±0.2 (0.7-1.3)
<i>A. menziesii</i>	45.0±1.6 (42.1-46.2)	22.6±1.5 (20.1-24.4)	36.4±1.7 (33.8-39.3)	1.24	0.62	28.5±1.8 (26.4-31.4)	1.7±0.4 (0.7-2.4)	16.76	0.67	2.0±0.7 (0.5-2.5)	11.6±1.9 (8.3-14.9)	2.7±0.4 (2.1-3.3)	1.5±0.3 (1.2-2.0)
<i>A. texana</i>	50.8±2.3 (47.9-54.1)	26.3±2 (25.1-29.7)	39.1±2 (36.3-42.9)	1.29	0.67	34.3±4.7 (28.1-42.3)	1.8±1.4 (0.3-3.1)	19.06	0.68	2.5±0.7 (1.3-3.3)	14.9±5.2 (8.3-24.8)	1.8±0.2 (1.7-2.3)	1.1±0.3 (0.5-1.5)
<i>Arctostaphylos</i>													
Subgenus <i>Arctostaphylos</i>													
Section <i>Foliobracteata</i>													
<i>A. andersonii</i>	43.3±1.3 (41.6-44.9)	22.3±1.5 (20.3-24.6)	36.2±0.9 (35.5-38.0)	1.19	0.61	25.7±1.5 (23.1-28.1)	1.3±0.7 (0.5-2.3)	19.77	0.59	1.4±0.7 (0.8-2.6)	7.4±2.1 (4.1-9.9)	2.3±0.4 (2.0-3.0)	0.9±0.4 (0.5-1.3)
<i>A. auriculata</i>	40.5±0.9 (39.6-41.7)	20.4±1.8 (18.6-22.8)	34.5±1.5 (33.0-36.6)	1.17	0.59	25.6±2.1 (21.5-28.9)	1.9±0.9 (0.5-3.0)	13.47	0.63	1.4±0.5 (0.5-2.0)	7.5±2.0 (5.0-11.6)	1.9±0.1 (1.7-2.0)	0.9±0.3 (0.5-1.3)
<i>A. crustacea</i>	54.4±4.0 (47.9-59.4)	28.5±3.1 (23.4-32.7)	44.1±3.0 (39.6-47.9)	1.23	0.64	34.2±1.6 (31.3-36.3)	0.5±0.2 (0.3-0.8)	64.80	0.63	0.7±0.4 (0.3-1.2)	7.2±2.3 (5.0-9.9)	2.5±0.5 (1.8-3.0)	0.6±0.3 (0.3-1.3)
<i>A. glauca</i>	47.4±2.9 (42.9-53.6)	24.8±1.5 (22.8-26.1)	38.9±1.3 (36.3-40.4)	1.21	0.64	27.5±1.7 (25.6-29.7)	1.7±0.5 (1.2-3.0)	16.18	0.58	1.7±0.7 (1.0-3.3)	9.2±1.2 (8.3-11.6)	2.5±0.4 (2.1-3.3)	0.7±0.2 (0.3-1.0)
<i>A. patula</i>	38.8±1.4 (37.1-41.3)	19.7±0.6 (18.8-20.8)	33.1±1.5 (30.2-36.3)	1.17	0.59	22.9±1.4 (20.6-24.8)	1.4±0.7 (0.7-2.8)	16.36	0.59	1.5±0.9 (0.3-3.3)	8.4±2.9 (5.0-13.2)	1.6±0.2 (1.5-2.0)	0.9±0.4 (0.5-1.5)
Section <i>Arctostaphylos</i>													
<i>A. bakeri</i>	42.9±1.4 (41.1-45.9)	22.0±1.1 (19.8-24.0)	35.6±1.6 (33.5-38.3)	1.20	0.61	28.3±1.0 (26.4-29.7)	0.7±0.2 (0.5-1.2)	40.43	0.66	1.9±1.0 (0.7-3.3)	5.8±1.8 (3.3-8.3)	2.6±0.5 (1.7-3.1)	0.8±0.4 (0.3-1.3)
<i>A. densiflora</i>	42.3±1.3 (39.6-44.1)	21.3±0.6 (19.8-21.8)	35.1±1.7 (33.0-38.0)	1.20	0.61	24.2±1.9 (19.8-26.4)	2.0±0.4 (1.7-3.0)	12.10	0.57	1.7±0.6 (0.7-2.6)	8.3±2.4 (4.1-13.2)	1.7±0.2 (1.5-2.0)	0.9±0.3 (0.7-1.2)
<i>A. nevadensis</i>	49.1±2.7 (44.6-52.8)	25.3±1.1 (23.6-26.4)	40.4±2.2 (36.3-43.7)	1.22	0.63	25.1±2.7 (21.5-28.1)	1.8±0.8 (1.2-3.3)	13.94	0.51	2.1±0.9 (0.8-3.3)	10.1±1.6 (8.3-13.2)	3.8±0.4 (3.3-4.6)	1.0±0.4 (0.5-1.7)
<i>A. viscida</i>	38.8±1.1 (37.5-39.6)	19.0±1.6 (17.3-22.8)	31.7±1.2 (29.7-33.8)	1.22	0.60	22.1±0.8 (20.6-23.1)	2.8±0.4 (2.1-3.3)	7.89	0.57	0.9±0.4 (0.7-1.7)	7.2±0.7 (6.6-8.3)	1.9±0.4 (1.3-2.8)	1.6±0.4 (1.3-2.0)

Table 3-2-2. Continued.

Name of Species	D	P	d	D/d	P/E	Ectoaperture			2f/D	Endoaperture		Apo. exine thickness	Septum thickness
						Length (2f)	Width (W)	2f/W		Length	Width		
Subgenus <i>Micrococcus</i>													
Section <i>Micrococcus</i>													
<i>A. nummularia</i>													
Rose s.n.	45.2±1.3	22.0±1.2	37.3±1.9	1.21	0.59	24.2±1.3	2.4±0.8	10.08	0.54	1.3±0.6	10.9±3.8	2.1±0.2	1.9±0.4
	(43.4-47.9)	(19.8-24.4)	(34.7-40.9)			(21.5-26.4)	(1.2-3.6)			(0.5-2.0)	(6.6-16.5)	(2.0-2.5)	(1.7-2.6)
Rose 61009	43.0±1.2	21.7±0.6	35.3±1.6	1.22	0.61	24.7±2.7	2.1±0.9	11.76	0.57	1.5±0.8	8.5±2.2	2.2±0.2	1.0±0.3
	(41.3-44.6)	(21.1-22.8)	(33.0-38.8)			(19.8-27.2)	(0.7-3.3)			(0.5-3.3)	(6.6-13.2)	(2.0-2.6)	(0.5-1.3)
<i>Comarostaphylis discolor</i> subsp. <i>discolor</i>	41.0±2.0	21.4±1.3	34.4±2.0	1.19	0.62	26.6±1.8	2.0±0.6	13.30	0.64	1.8±0.8	7.9±1.8	1.8±0.2	0.8±0.3
Pringle 6815	(36.6-44.6)	(19.5-23.1)	(31.4-36.3)			(24.8-29.7)	(0.8-3.3)			(0.8-3.3)	(5.8-9.9)	(1.3-2.0)	(0.3-1.3)
Steyermark 5059b	39.0±1.2	19.6±0.6	32.9±1.4	1.19	0.62	22.9±1.8	1.0±0.4	22.90	0.59	0.8±0.3	7.2±1.8	2.3±0.3	1.0±0.3
	(37.3-41.3)	(18.2-20.1)	(30.5-34.7)			(19.8-24.8)	(0.5-1.7)			(0.5-1.3)	(5.0-9.9)	(2.0-3.0)	(0.5-1.5)
<i>C. glaucescens</i>	46.5±2.2	23.3±1.8	37.7±2.3	1.12	0.61	30.8±2.9	2.3±0.9	13.39	0.66	1.7±0.7	13.4±2.7	2.1±0.4	0.9±0.3
	(44.6-50.5)	(20.1-26.1)	(33.8-41.3)			(28.1-36.3)	(0.7-3.6)			(0.7-3.0)	(9.9-16.5)	(1.7-2.8)	(0.3-1.3)

D: tetrad diameter, P: polar length, d(E): equatorial diameter, Apo.: apocolpial, minimum–maximum values in μm in parenthesis.

Comarostaphylis [10 spp. / 2 spp. examined: *C. discolor* ssp. *discolor* and *C. glaucescens*]

Pollen grains are in compact tetrahedral tetrad; viscin thread absent; D 39.0 – 46.5 μm , P 19.6 – 23.3 μm , E 32.9 – 37.7 μm , D/d 1.12 – 1.19, P/E 0.61 – 0.62, oblate; 3-colporate, 2f 22.9 – 30.8 μm , W 1.0 – 2.3 μm , 2f/W 13.30 – 22.90, 2f/D 0.59 – 0.66, significantly wider at middle, acute towards end, costae present and distinct, colpus margin distinct; endocracks absent or indistinct in *C. discolor* ssp. *discolor*, but distinct in *C. glaucescens*; endoaperture lalongate, 0.8 – 1.8 μm long, 7.2 – 13.4 μm wide; apocolpial exine 1.8 – 2.3 μm thick, septum 0.8 – 1.0 μm thick, perforated; tectate, exine sculpture verrucate to rugulate.

In SEM, pollen surface is somewhat flat, apocolpial exine sculpture coarsely rugulate-psilate with minute (diam. < 0.2 μm) striate (Type RS; Figs. 3-8 C, E); colpus membrane granulate or largely granulate.

In TEM for *C. glaucescens*, the apocolpial exine is composed of ektexine and endexine (Figs. 3-8 G – H). Sexine is ca. 0.9 μm thick and total exine is ca. 1.9 μm thick. The proximal exine (septum) is ca. 0.7 – 1.2 μm thick, with perforation (Figs. 3-8 G, I). Endexine is unevenly thick around the pollen tetrad, showing the endocracks (Fig. 3-8 G – H).

Discussion

Variation in palynological characters

The members of the subfamily Arbutoideae are stenopolynous, characterized by medium, oblate, and 3-colpor(oid)ate pollen united in compact tetrahedral tetrads. Another characteristic palynological feature of the Arbutoideae is consistently lower P/E ratio of Class I, except in *Arbutus texana* (Table 3-2-1). But a continuous and serial variation in most of the quantitative characters e.g., D, P, E, 2f etc. and exine sculpture, was revealed within and/or among the members of this subfamily (Table 3-2-2; Figs. 3-6 – 3-8).

The palynological features are summarized in Table 3-2-1 and all the palynological characters studied with LM are listed in Table 3-2-2. Accordingly among the taxa studied, pollen of *Arctostaphylos crustacea* showed the highest values of D, P, E and 2f/W (54.4 μm , 28.5 μm , 44.1 μm , and 64.80, respectively) and also the lowest values of ectoaperture width, endoaperture length and septum thickness (0.5 μm , 0.7 μm and 0.6 μm , respectively). On the other hand, pollen of *Arctostaphylos viscida* showed the lowest values of D, P, 2f and 2f/W (38.8 μm , 19.0 μm , 22.1 μm and 7.89, respectively) and the widest ectoaperture (2.8 μm). The highest values of D/d, P/E, 2f, 2f/D, length and width of endoaperture, apocolpial exine and septum thickness (1.29, 0.67, 34.3 μm , 0.64, 2.9 μm , 14.9 μm , 3.8 μm and 1.9 μm , respectively), and lowest values of E, D/d, P/E, 2f/D and width of endoaperture (31.1 μm , 1.12, 0.59, 0.51 and 1.60 μm , respectively) in different taxa (Table 3-2-2). The ratio ectoaperture length and tetrad diameter (2f/D) in pollen tetrads of the subfamily Arbutoideae is relatively larger (Class IV or V) resulting the smaller apocolpial region in most of the species (Table 3-2-1). But, parameters with same value were not uncommon in different taxa, viz., the D/d value 1.19 was found in *Arctostaphylos andersonii* and both specimen of *Comarostaphylis discolor* ssp. *discolor* (Table 3-2-2).

Generally *Arbutus* has relatively larger tetrad diameter followed by *Comarostaphylis* and the variability in morphological characters of *Arctostaphylos* is well supported (possesses both the largest and smallest tetrads among the taxa studied) in this palynological character also (Tables 3-2-1 – 3-2-2). The index of the relative globularity of the tetrad (D/d) and ratio of ectoaperture length to tetrad diameter (2f/D) showed a difference among the genera (Table 3-2-2). Pollen grains of *Arbutus* possess the largest value of D/d (1.23 – 1.29) followed by *Arctostaphylos* (1.17 – 1.23) and the lowest in *Comarostaphylis* (1.12 – 1.19). The genus *Arbutus* also possesses the largest value of 2f/D (0.65 – 0.68), with exception in *A. canariensis* which possesses the smallest value of 2f/D (0.44) among the studied species (Table 3-2-2). The genus *Arctostaphylos* possesses relatively lower values of 2f/D (0.51 –

0.63) with exception in *A. bakeri* (0.66) and the intermediate in *Comarostaphylis* (0.64 – 0.66). These indicate that the ratios D/d and $2f/D$ might be used as character of taxonomic importance among the genera within this subfamily. We did not observe any pollen tetrad with apertures (colpus) in syncolpate form, but syncolpate aperture has been reported in different taxa (Oldfield 1959, Rosatti 1988). The septal exine (septum) is relatively thicker in *Arbutus* compared to that in *Comarostaphylis*, and *Arctostaphylos*, with some exceptions (Tables 3-2-1 – 3-2-2). But, the septum with perforations is characteristic for both the genus *Comarostaphylis* and *Arctostaphylos*. The septum with perforations is also found in other families having pollen tetrads (e.g., Winteraceae, Pragłowski 1979; Periplocaceae, Nilsson et al. 1993). These perforations may form to complete intercommunications between the grains by joining the protoplasts of the individual pollen to act as single harmomegathic unit (Oldfield 1959, Pragłowski 1979); or as the site of crosswall cohesion (Takahashi and Sohma 1980), but Guinet (1965) considered them to ultimately function in tetrad separation. Although I am not sure about the reason of this type of special feature, it may have a taxonomic importance in the Arbutoideae as well as Ericaceae and may be an apomorphic pollen character state for this tribe as described for Sarcolaneaceae (Carlquist 1964).

In SEM, the apocolpial exine sculpture shows difference among the genera. The genus *Arbutus* shows exine sculpture from coarsely rugulate-psilate with minute granules to coarsely rugulate-psilate with minute striate, pollen surface either uneven or somewhat flat (Fig. 3-6). On the other hand *Comarostaphylis* shows exine sculpture coarsely rugulate-psilate, the rugulae transversely striate, pollen surface somewhat flat (Type RS; Fig. 3-8) and *Arctostaphylos* shows surface uneven and rugged, sculpture coarsely rugulate to coarsely rugulate-psilate, the rugulae with secondary sculpture; minute striate or granulate (Type RS or R or RG; Fig. 3-7). Moreover, the species of *Arctostaphylos* possess the smallest rugulae compared to the other species except in *A. nevadensis* (Figs. 3-6 – 3-8). The size of rugulae might also be used as character of taxonomic importance within this subfamily. Like other

genera of family Ericaceae (e.g., Takahashi 1986b, 1987a, Sarwar and Takahashi 2006a), a more or less continuous and serial variation in the apocolpial exine sculpture was found in species of *Arbutus*.

Only two species *A. andersonii* and *C. glaucescens* are studied with TEM representing the genera *Arctostaphylos* and *Comarostaphylis*, respectively. Though the basic pollen wall structures are same, they show significant differences in the thickness of different substratum, especially in septum and intine thickness (Figs. 3-7 M – O, 3-8 G – I) and might be useful for identification purpose. The apocolpial exine thickness is more or less similar in both the species. But the septum thickness is almost double in *C. glaucescens* than that of *A. andersonii*, and both the endexine and the intine are unevenly thick in *C. glaucescens*. The unevenly thick endexine of *C. glaucescens* might represent the endocracks as seen with LM.

Taxonomic significance of palynological characters

Although there is currently no disagreement over the limit of the Arbutoideae, the limit of the genera is more problematic mainly due to circumscription of the genus *Arctostaphylos* (Stevens 1995). Diggs (1995b) described *Arctostaphylos* as a variable but reasonably coherent group. The variability of morphological characters in this genus is well supported by our palynological observations (Tables 3-2-1 – 3-2-2). An interesting observation in pollen tetrads of North American population of *A. uva-ursi* has been reported by Rosatti (1988). The variation in tetrad size was very little, and did not correlate with either the chromosome number of the plant or the putative taxa (Rosatti 1988). On the basis of molecular data, Hileman et al. (2001) discussed the phylogeny and biogeography of subfamily Arbutoideae in detail. Their result confirmed the monophyly of *Arctostaphylos* and *Comarostaphylis*. However, the monophyly of *Arbutus* is not supported by their analysis. Rather, Mediterranean Basin species of *Arbutus* are more closely related to other North American genera than to species of western North American *Arbutus*. The paraphyletic

relationship of *Arbutus* species implies that characters formerly used to diagnose the genus may be plesiomorphic for the Arbutioideae, or the result of convergent evolution (Hileman et al. 2001). Although the quantitative palynological characters do not show significant difference between two clades of *Arbutus* species (Hileman et al. 2001), the difference in exine sculpture (Type RS vs. intermediate R/RG or RG/RS) may support the paraphyly of *Arbutus*. And one of the Mediterranean Basin species, *Arbutus andrachne* possesses a very distinct 2f/W ratio (36.78) compared to other species of *Arbutus* (Table 3-2-2). The septum with perforations found at both genera *Arctostaphylos* and *Comarostaphylis*, might be an indication to the close relationship between these two genera as observed by phylogenetic study (Hileman et al. 2001). A detail phylogenetic study using both morphological including palynological and molecular data might be useful to clarify the relationship within *Arbutus* species as well as subfamily Arbutioideae.

The synapomorphic state of exine sculpture for this subfamily is not clear as the exine sculpture very often evolved parallelly. The exine sculpture with secondary sculpture might be the most specialized character state situated at the end of a serial variation of exine sculpturing within the subfamily as well as in the subfamily Vaccinioideae (Chapter 3-6). The evolutionary trend in exine sculpture was postulated in Arbutioideae from coarsely rugulae with minute granules to coarsely rugulate with secondary sculptures; the rugulae finely to clearly striate, or vice versa. Since, the variation in exine sculpture from verrucate through rugulate to psilate has been observed in subfamily Enkianthoideae and Monotropoideae (Takahashi 1986a & b, 1987a & b), synapomorphic state for the subfamily Arbutioideae is not clear. However evidence suggested that the evolutionary trend in exine sculpture from coarsely rugulate with minute granules to coarsely rugulate with secondary sculpture, the rugulae finely to clearly striate (Hileman et al. 2001). The genus *Enkianthus* of monogeneric subfamily Enkianthoideae is regarded as the sister group of all other taxa of the Ericaceae (Kron et al. 2002a), has pollen grains with finely verrucate to coarsely rugulate-psilate, or flat

and rugulate exine sculpture. The exine sculpture coarsely rugulate with minute granules is suggested as one of the apomorphic palynological character state in *Enkianthus*. This evidence may also support the foregoing hypothesis on the evolutionary trend in exine sculpture of Arbutoideae.

Infrageneric classification of *Arctostaphylos*

The debate on the generic limit of *Arctostaphylos* has not been settled yet. In the most recent classification and biogeographical study of Ericaceae (Kron et al. 2002a, Kron and Luteyn 2005), the genus *Arctostaphylos* is delimited as including *Arctous* and *Xylococcus*. But, the broader sampling with the *ITS* gene yield a topology compatible with conventional delimitations of genera, in particular, *Arctous* is not sister to *Arctostaphylos* (Stevens 2006). Although the quantitative palynological characters of the two species of *Arctous*; *A. alpina* and *A. rubra*, are similar to those of *Arctostaphylos* species (e.g., Moriya 1976, Comtois and Larouche 1981), the exine sculpture of *A. alpina*; verrucose-rugulate with large irregularly-shaped warts (Fig. 9G in Zhang and Anderberg 2002), is distinctly different from that of other *Arctostaphylos* species (Tables 3-2-1 – 3-2-2; Figs. 3-6 M – O, 3-7). This difference in exine sculpture may also support the conventional delimitations of the genera *Arctous* and *Arctostaphylos*.

Wells (1992) has segregated the genus *Arctostaphylos s.s.* into two subgenera and six sections. The subgenus *Micrococcus* contains only 4 species, but 3 of these are so distinct that they are treated in 3 separate sections. The other subgenus *Arctostaphylos* contains rest of the species, is divided into three sections, but two of these are very richly substructured. Palynological features, especially the exine sculpture, of *Arctostaphylos* also support the infrageneric classification for this genus (Wells 1992) (Tables 3-2-1 – 3-2-2; Type RS or R vs. Type RG; Figs. 3-6 M – O, 3-7).

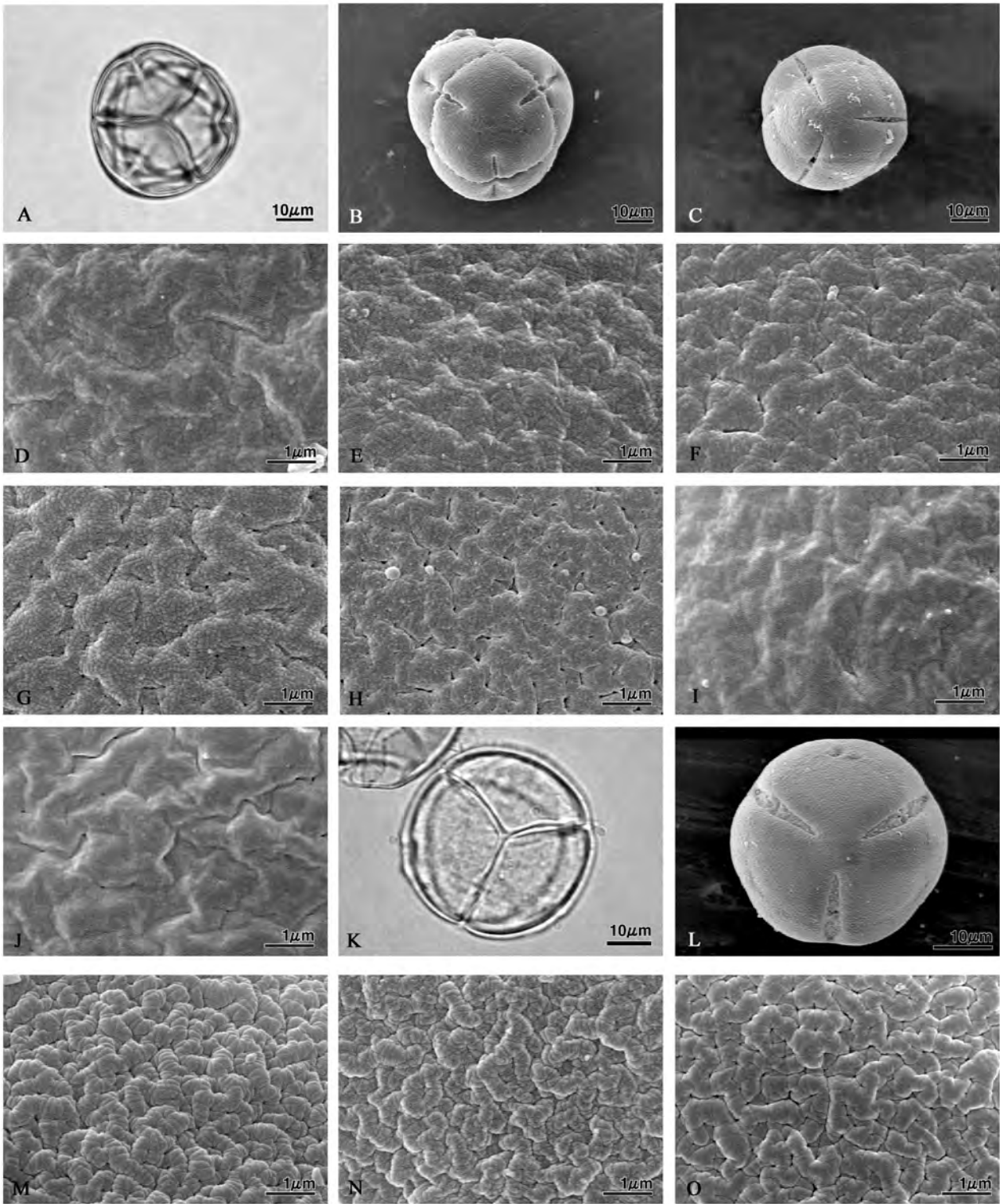

Fig. 3-6.

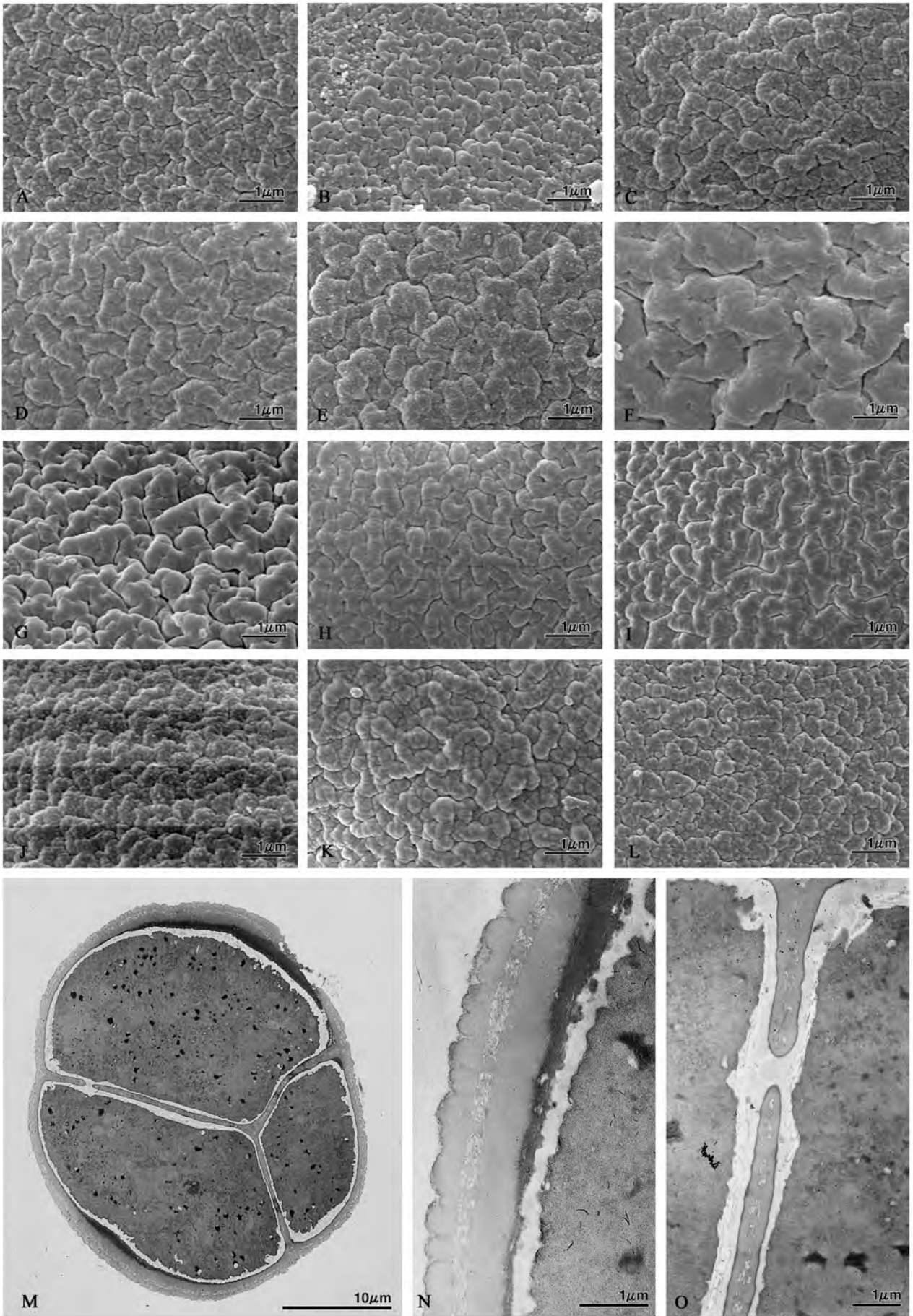

Fig. 3-7.

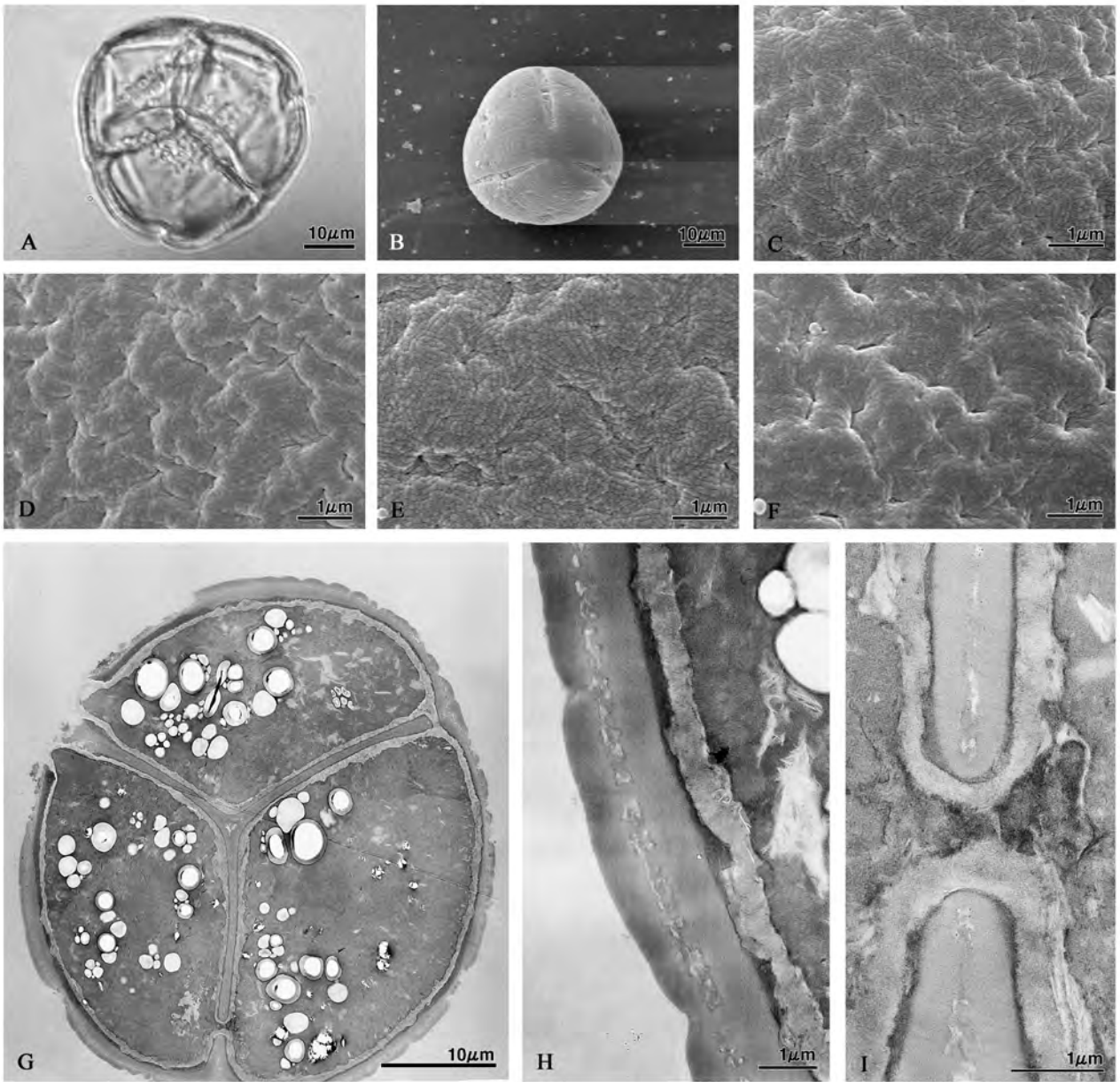

Fig. 3-8.

3-3 Subfamily Ericoideae

Introduction

The subfamily Ericoideae Link is the largest subfamily, ranked based on the species number, of the family Ericaceae, comprises 5 tribes: Bejarieae, Phyllodoceae, Ericeae, Empetreae, and Rhodoreae, with only 19 genera and about 1780 species (Kron and Luteyn 2005). Two of the largest genera of the family Ericaceae; *Erica* (860 spp.) and *Rhododendron* (850 spp.) are included in this subfamily. Although plants of the subfamily Ericoideae are diverse with regard to several aspects of flower morphology, leaf type, and pollination strategy, they can be identified with following morphological characters; the erect to more or less horizontal position of the flowers, loss of stamen appendages, and fruits septicidal capsules, but loculicidal capsules in *Erica* (Kron et al. 2002a). Viscin threads are restricted to this group and may represent synapomorphy for these plants. The genera included in this subfamily were previously the members of subfamilies Ericoideae and Rhododendroideae (*sensu* Stevens 1971) of the family Ericaceae, and the family Empetraceae. The plants of subfamily Ericoideae commonly shrubs or small tree, have a wide range of distribution both in Old and New World; South Africa, tropical Africa, Madagascar, East to Southeast Asia, New Guinea, Europe, the Northern Hemisphere, tropical and subtropical America (detail distribution map in Fig. 1-1). Although the monophyly of Ericoideae is well supported, the relationships among tribes within subfamily are not fully understood (Gillespie et al. 2006).

Comprehensive pollen morphology of the tribes Empetreae and Ericeae, has been studied by previous workers (Fabre and Paquereau 1956, Visset 1972, 1975, Hesse 1985, Díez 1987, Kim et al. 1988, Davis 1997, Rowley 2001). Pollen morphology of other tribes of this subfamily has also been studied numerously (e.g., Southall and Hardin 1974, Bohm et al. 1978, Hesse 1984, Keri and Zetter 1992, Luteyn 1995a, Zetter and Hesse 1996, Terzioğlu et al. 2001), and fragmentally mentioned in regional floras. However, the number of the species

reported in these works is still limited considering the total number of taxa in this subfamily, and as usual some taxa were described on repeated occasions. Therefore, the present research has been undertaken to study of pollen morphology of this subfamily in comprehensive details and to discuss its taxonomic significance in light of recent classification of this subfamily as well as to clarify the relationships among tribes within subfamily based on new palynological data.

Results

Pollen morphology of the subfamily Ericoideae

Pollen grains are united in tetrahedral tetrad; commonly normal, but sometimes compact, or monad; viscin threads present or absent. In range of average values of the specimen, D 24.4 – 67.1 μm , P 12.8 – 35.8 μm , E 16.8 – 47.5 μm , D/d 1.27 – 1.67, P/E 0.66 – 1.37, oblate to prolate. Three aperturate, apertures arranged according to “Fischer’s Law”, rarely 4-aperturate, colp(oid)ate, colpi distinct, 2f 11.5 – 30.4 μm , L 12.1 – 21.7 μm , W 0.4 – 4.3 μm , rarely faint and difficult to measure, 2f/W (L/W) 3.60 – 57.75, 2f/D 0.26 – 0.75, significantly wider at middle, generally acute but sometimes tapering towards ends, colpus margin distinct, colpus tip sometime bifurcated. Costae usually present, but indistinct in some species, endocracks present, but indistinct in some species. Endoaperture is distinct, but indistinct and/or not clear in some species, lalongate, rarely circular or H-shaped, sometimes not clear, 0.4 – 3.4 μm long, 3.7 – 13.4 μm wide. Exine tectate, apocolpial exine 1.4 – 3.6 μm thick, septum 0.7 – 3.6 μm thick, rarely with perforations, apocolpial exine sculpture varied from finely verrucate to rugulate, sometimes psilate (Tables 3-3-1 – 3-3-2).

In SEM, pollen surface varies from uneven and rugged to flat, 1) primary apocolpial exine sculpture indistinct, secondary sculpture finely gemmate-pilate (Type FG; Figs. 3-9 C –

I, 3-17 D – L, N – O, 3-18 A – E, G – O, 3-19 A – C, 3-20 G – I); or 2) exine sculpture psilate (Type P; Figs. 3-9 O, 3-11 L, 3-12 E, 3-15 G); or 3) primary exine sculpture coarsely rugulate-psilate, the rugulae with minute granules (Type RG; Figs. 3-10 D, 3-11 M – N, 3-12 A – C, F – H); or 4) primary exine sculpture indistinct, secondary sculpture unit moderately gemmate-pilate (Type MG; Figs. 3-10 E, N, 3-11 J, O, 3-12 D, 3-14 C); or 5) exine sculpture moderate to coarsely rugulate, with distinct grooves (Type R; Figs. 3-15 A – B, E – F, N – O, 3-16 A, J, 3-17 M, 3-18 F, 3-19 D – E); or 6) primary exine sculpture coarsely rugulate-psilate, the rugulae with moderately granulate (Type RGS; Fig. 3-15 C); or 7) primary exine sculpture coarsely rugulate-psilate, the rugulae loosely arranged and clearly striate (Type RS; Fig. 3-16 D); or 8) primary apocolpial exine sculpture indistinct, secondary sculpture unit narrow straight-edged striate (Type NS; Figs. 3-16 G, I); or intermediate types. Exine sculpture along the colpi is similar to that appearing at distal pole. The mesocolpial exine has commonly a tendency to decrease in lateral extension of the rugulae with more distinct units, but the rugulae width similar at both the apocolpial and mesocolpial region was also noticed (e.g., Fig. 3-16 G – H). Colpus membrane is commonly granular, sometimes with large granules or a tendency towards granuloid (Table 3-3-1).

In TEM, the apocolpial exine is composed of ektexine; tectum, columellae (rod-like elements distinct) and foot layer, and endexine with higher electron density (e.g., Figs. 3-9 J – K). Sexine is ca. 0.5 – 1.3 μm thick and a total exine is ca. 1.0 – 2.2 μm thick. In the proximal exine (septum), tectum is fragmentary and two foot layers of adjacent grains are connected by columellae in many places (e.g., Figs. 3-12 J, L); septum is ca. 0.7 – 2.2 μm thick, in some cases perforated. Intine is almost evenly thick around the pollen tetrad (e.g., Fig. 3-9 J), showing lower electron density than the endexine at both apocolpial and septal exine.

Table 3-3-1. Pollen morphological data of subfamily Ericoideae based on light microscopic investigation.

Name of Taxa	Config-uration ²	D ³	P ⁴	D/d ⁵	P/E ⁶	2f or L ⁷	2f/W or 2f/D or Apo. L/W ⁸	Exine L/P ⁹	thickness ¹⁰	Septum thickness ¹¹	Orname-ntation ¹²	Colpus Memb. ¹³	Remarks ¹⁴
Tribe Bejareae (2/3)¹													
<i>Bejaria</i>													
Section <i>Bejaria</i>													
<i>B. aestuans</i>	T	II	III	III	II	I	II	II	V	V	FG	LG	3, 4
<i>B. resinosa</i>	T	III	III	III	III	I	I	I	IV	II	FG	?	3, 4
<i>B. subsessalis</i>	T	III	III	III	II	I	I	I	V	III P	FG	?	2, 3, 4
Section <i>Racemosae</i>													
<i>B. racemosa</i>	T	III	III	III	II	I	II	II	IV	III	FG	LGGr	3, 4, 8
<i>Bryanthus gmelinii</i>	CT	II	II	VI	IV	II	VI	V	IV	I	P	?	5
Tribe Empetreae (3/3)													
<i>Ceratiola ericoides</i>	T	n.d.	n.d.	n.d.	n.d.	n.d.	n.d.	n.d.	n.d.	n.d.	RG	?	
<i>Corema conradii</i>	T	II	II	IV	III	I	II	IV	III	IV	MG	?	2, 5
<i>Empetrum nigrum</i>	T	II	III	III	II	I	?	II	IV	IV	MG	?	1, 2, 5
Tribe Ericaceae (3/3)													
<i>Calluna vulgaris</i>	I	II	III	V	III	I	II	II	III	I P	R/RG	?	1, 2, 5
<i>Daboecia cantabrica</i> Halliday 123/70	CT	II	III	IV	II	II	III	VI	II	I	R/P	Gr	2, 5
Nilson & Degelius s.n.	T	II	III	IV	III	II	III	VI	II	III P	MG	S	2, 5
<i>Erica arborea</i>	T	II	II	III	II	I	II	IV	III	II	R/MG	S/Gr	
<i>E. axillaris</i>	T	II	II	II	II	I	II	IV	VI	IV	MG	?	5
<i>E. cinerea</i>	T	III	IV	III	II	II	III	IV	IV	II	FV	Gr	7
<i>E. dumosa</i>	T	II	II	IV	II	II	II	V	VI	VI	P*	G	8
<i>E. glabella</i> ssp. <i>glabella</i>	T	II	II	III	II	II	II	VI	IV	III	-	-	
<i>E. multiflora</i>	T	I	II	III	II	I	IV	IV	III	II	RG	Gr	
<i>E. sicula</i>	T	III	III	II	II	II	II	IV	V	I	-	-	
<i>E. tetralix</i>	T	III	III	III	II	II	I	IV	II	II	RG	LG/LGr	5
<i>E. trimera</i> ssp. <i>keniensis</i>	T	II	II	III	II	I	IV	III	IV	IV	MG	?	1
<i>E. barbigera</i>	M	-	III	-	IV	I	II	VII	III	II	RG	LG	7
<i>E. bokkeveldia</i>	M	-	IV	-	VII	II	III	VI	V	V	MG	LG	2, 5
<i>E. curvistyla</i>	M	-	IV	-	VII	I	IV	VI	V	III	RG	G	5
<i>E. globiceps</i> ssp. <i>consors</i>	M	-	III	-	IV	I	II	VII	III	II	RG	?	7
<i>E. labialis</i>	M	-	n.d.	-	n.d.	n.d.	n.d.	n.d.	n.d.	n.d.	RG	G	
<i>E. plumosa</i>	M	-	III	-	IV	I	II	VI	II	II	MG	?	7
<i>E. puberuliflora</i>	M	-	III	-	IV	I	I	V	VI	IV	MG	S	6
<i>E. recurvifolia</i>	M	-	III	-	IV	I	IV	VII	VI	III	P*	LG	2, 5
<i>E. similis</i>	M	-	II	-	II	I	I	VII	V	IV	-	-	5, 7
<i>E. spiculifolia</i>	M	-	II	-	IV	I	II	IV	III	II	S/RG	S/Gr	Sometimes 2, 5, 6

Table 3-3-1. Continued.

Name of Taxa	Config-uration ²	D ³	P ⁴	D/d ⁵	P/E ⁶	2f or L ⁷	2f/W or L/W ⁸	2f/D or L/P ⁹	Apo. Exine thickness ¹⁰	Septum thickness ¹¹	Orname-ntation ¹²	Colpus Memb. ¹³	Remarks ¹⁴
<i>E. uberiflora</i>	M	-	II	-	IV	I	II	V	III	II	RG	?	7
<i>E. xeranthemifolia</i>	M	-	IV	-	V	II	IV	VII	IV	III	RG/RS	S/LG	7
Tribe Phyllodoceae (5/6)													
<i>Elliottia bracteata</i>	T	IV	IV	III	II	I	II	II	III	II	MG	G	3
<i>E. paniculata</i>	T	III	III	III	II	I	II	III	III	II	MG/R	G	3, 5
<i>E. pyroliflora</i>	T	IV	IV	III	II	II	I	II	IV	II	-	-	1
<i>Epigaea asiatica</i>	T	n.d.	n.d.	n.d.	n.d.	n.d.	n.d.	n.d.	n.d.	n.d.	RS/R	G	
<i>E. repens</i>	CT	II	II	III	II	II	II	IV	IV	II	R/P	G	3
<i>Kalmia angustifolia</i>	LT	II	II	IV	II	I	II	III	III	I	R	S/Gr	2, 3, 5
<i>K. buxifolia</i>	CT	I	I	IV	II	I	V	V	III	III	R	G	2, 5
<i>K. ericoides</i> var. <i>aggregata</i>	LT	II	II	IV	III	I	III	II	IV	I	RGS	?	3
<i>K. latifolia</i>	T	II	II	III	II	I	II	II	III	I	R	G	1, 3, 5, 6
<i>K. polifolia</i>	CT	II	II	III	II	I	II	IV	IV	III	R	S	5
<i>K. procumbens</i> Takahashi et al.2644	T	II	II	IV	III	I	IV	IV	III	I	P	G	2, 5
Takahashi 9907	T	II	II	IV	II	I	II	V	III	I	P	?	5
<i>Phyllodoce aleutica</i>	T	II	II	III	II				III	I	R/FG	S	3, 5
<i>P. caerulea</i>	T	I	II	III	II	I	II	IV	III	I	R	G	1
<i>P. nipponica</i> var. <i>oblong-ovata</i>	T	II	II	III	II	I	I	II	III	II (P)	R	LG	1, 2, 3, 5
<i>Rhodothamnus chamaecistus</i>	T	III	III	III	II	I	II	III	III	II	RS	Gr	3, 5, 6
Tribe Rhodoreae (3/4)													
<i>Menziesia cicalalyx</i>	T	n.d.	n.d.	n.d.	n.d.	n.d.	n.d.	n.d.	n.d.	n.d.	NS	Gr	
<i>M. goyozanensis</i>	T	n.d.	n.d.	n.d.	n.d.	n.d.	n.d.	n.d.	n.d.	n.d.	NS	Gr	
<i>M. multiflora</i>	T	II	II	III	II	I	I	III	III	I (P)	NS	Gr	
<i>M. pentandra</i>	CT	II	II	IV	II	I	II	IV	III	II (P)	R*	S	3, 5
<i>Rhododendron</i>													
Subgenus <i>Azaleastrum</i>													
Section <i>Tsutsutsi</i>													
<i>R. dilatatum</i>	T	IV	IV	IV	II	I	III	II	VI	III	FG	LGr/G	3
<i>R. hidakanum</i>	T	n.d.	n.d.	n.d.	n.d.	n.d.	n.d.	n.d.	n.d.	n.d.	FG	G/LG	3
<i>R. indicum</i>	T	n.d.	n.d.	n.d.	n.d.	n.d.	n.d.	n.d.	n.d.	n.d.	FG	LG	3
<i>R. japonicum</i>	CT	V	V	III	II	I	I	II	V	II	FG*	LGr/G	3
<i>R. kaempferi</i>	CT	IV	IV	IV	II	I	II	II	V	III	FG	G	3, 6
<i>R. macrosepalum</i>	T	IV	IV	III	II	I	III	II	VI	III	FG	LG	3, 6
<i>R. nudipes</i> ssp. <i>niphophyllum</i>	T	IV	IV	IV	III	II	II	III	VI	VI	FG	G/Gr	3, 5
<i>R. semibarbatum</i>	CT	n.d.	n.d.	n.d.	n.d.	n.d.	n.d.	n.d.	n.d.	n.d.	FG	LG	3
<i>R. trinerve</i>	T	n.d.	n.d.	n.d.	n.d.	n.d.	n.d.	n.d.	n.d.	n.d.	FG	Gr	3

Table 3-3-1. Continued.

Name of Taxa	Config-uration ²	D ³	P ⁴	D/d ⁵	P/E ⁶	2f or L ⁷	2f/W or L/W ⁸	2f/D or L/P ⁹	Apo. Exine thickness ¹⁰	Septum thickness ¹¹	Orname-ntation ¹²	Colpus Memb. ¹³	Remarks ¹⁴
<i>R. tsusiophyllum</i>	T	II	II	III	II	I	I	III	IV	III	R*	G	1, 3, 5
<i>R. wadanum</i>	T	IV	IV	IV	III	I	III	II	VII	II	FG	Gr	3
<i>R. weyrichii</i>	T	IV	IV	IV	II	I	II	II	VI	IV	FG	G	3
Section <i>Sciadorhodion</i>													
<i>R. albrechtii</i>	T	V	VI	IV	II	III	II	III	V	III	FG*	G/Gr	3
<i>R. quinquefolium</i>	T	n.d.	n.d.	n.d.	n.d.	n.d.	n.d.	n.d.	n.d.	n.d.	FG	G/LGr	3
<i>R. schlippenbachii</i>	T	IV	IV	III	II	I	I	II	V	III	FG	LG/Gr	3
Subgenus <i>Hymenanthes</i>													
Section <i>Ponticum</i>													
<i>R. aureum</i>	LT	IV	VI	V	III	II	III	II	IV	II	FG	Gr	3
<i>R. brachycarpum</i>	T	III	VI	III	II	II	III	III	V	II	FG*	G	3
<i>R. decorum</i>	LT	V	V	IV	III	II	IV	II	V	IV	R**	Gr/G	3, 7
<i>R. degronium</i>	T	n.d.	n.d.	n.d.	n.d.	n.d.	n.d.	n.d.	n.d.	n.d.	FG	S	3
<i>R. formosanum</i>	LT	V	VI	IV	III	II	II	III	V	V	FG*	LGr	3
<i>R. macrostemon</i>	T	n.d.	n.d.	n.d.	n.d.	n.d.	n.d.	n.d.	n.d.	n.d.	FG	G	3
<i>R. viscistylum</i> var. <i>amakusaense</i>	T	n.d.	n.d.	n.d.	n.d.	n.d.	n.d.	n.d.	n.d.	n.d.	FG	G	3
Section <i>Pentanthera</i>													
<i>R. arborescens</i>	T	n.d.	n.d.	n.d.	n.d.	n.d.	n.d.	n.d.	n.d.	n.d.	FG	G	3
Subgenus <i>Rhododendron</i>													
Section <i>Rhododendron</i>													
Subsection <i>Lapponica</i>													
<i>R. lapponicum</i>	T	III	III	IV	III	I	II	II	IV	I	FG	LGr	3, 4, 5
<i>R. parvifolium</i>	T	n.d.	n.d.	n.d.	n.d.	n.d.	n.d.	n.d.	n.d.	n.d.	FG/MG	G	3
Subsection <i>Rhodorastra</i>													
<i>R. dauricum</i>	T	n.d.	n.d.	n.d.	n.d.	n.d.	n.d.	n.d.	n.d.	n.d.	FG*	LG/Gr	3
<i>R. mucronulatum</i> var. <i>ciliatum</i>	LT	n.d.	n.d.	n.d.	n.d.	n.d.	n.d.	n.d.	n.d.	n.d.	FG	G	3
Subsection <i>Triflora</i>													
<i>R. davidsonianum</i>	T	IV	V	III	II	I	II	II	VI	II	FG	G/Gr	3, 5
<i>R. kieskei</i>	T	n.d.	n.d.	n.d.	n.d.	n.d.	n.d.	n.d.	n.d.	n.d.	FG	G	3
Subsection <i>Ledum</i>													
<i>R. diversipilosum</i>	LT	II	II	IV	II	I	II	IV	III	II	R	Gr/S	3
<i>R. subarcticum</i>	CT	II	II	III	II	I	III	IV	III	I	R	G	3, 4, 5
<i>Therorhodion camtschaticum</i>	LT	III	IV	IV	III	I	I	I	IV	II	FG	S/Gr	3, 4, 5
<i>T. redowskinum</i>	T	n.d.	n.d.	n.d.	n.d.	n.d.	n.d.	n.d.	n.d.	n.d.	FG	?	3

D: tetrad diameter, P: polar length, d(E): equatorial diameter, 2f(L): ectoaperture length, W: ectoaperture width, Apo.: apocolpial, Mem.: membrane, n.d.: not discerned.

¹ Genera examined/total no. of genera

² T: Tetrahedral tetrad, CT: Compact tetrahedral tetrad, LT: Lobed tetrahedral tetrad, ⁹ I: -0.30, II: 0.31-0.40, III: 0.41-0.50, IV: 0.51-0.60, V: 0.61-0.70

M: Monad, I: Irregular

¹⁰ II: 1.1-1.5µm, III: 1.6-2.0µm, IV: 2.1-2.5µm, V: 2.6-3.0µm, VI: 3.1-

³ I: 20.1-30.0µm, II: 30.1-40.0µm, III: 40.1-50.0µm, IV: 50.1-60.0µm, V: 60.0µm - ¹¹ I: -1.0µm, II: 1.1-1.5µm, III: 1.6-2.0µm, IV: 2.1-2.5µm, V: 2.6 µm - , P Perforated

⁴ I: -15.0µm, II: 15.1-20.0µm, III: 20.1-25.0µm, IV: 25.1-30.0µm, V: 30.1-35.0µm, ¹² Exine ornamentation type by SEM corresponding to Fig. 3.

VI: 35.1µm -

¹³ G: Granulate, Gr: Granuloid, LG: Largely granulate, LGr: Largely granuloid, S: Smooth

⁵ I: -1.19, II: 1.20-1.29, III: 1.30-1.39, IV: 1.40-1.49, V: 1.50-1.59, VI: 1.60-

¹⁴ 1: Noticed in other configuration, 2: Endoaperture indistinct, 3: Viscin threads present,

⁶ II: 0.66-0.75, III: 0.76-0.85, I: 0.86- 0.95

4: Costae indistinct, 5: Endocracks absent/indistinct, 6: Rarely 4-aperturate, 7: Number

⁷ I: 10.1 - 20.0µm, II: 20.1 - 30.0µm, III: 30.1 - 40.0µm

of endoaperture more than one, 8: Apocolpial region small

⁸ I: -10.0, II: 10.1-20.0, III: 20.1-30.0, IV: 30.1-40.0, V: 40.1-50.0, VI: 50.1-60.0,

VII: 60.1 -

Table 3-3-2. Variation in palynological characters of subfamily Ericoideae showing mean value in μm and standard deviation.

Name of Species	D	P	d	D/d	P/E	Ectoaperture			2f/D	Endoaperture		Apo. exine thickness	Septum thickness
						Length (2f)	Width (W)	2f/W		Length	Width		
Tribe Bejareae													
<i>Bejaria</i>													
Section <i>Bejaria</i>													
<i>Bejaria aestuans</i>	39.7±2.3 (36.6-43.2)	21.2±1.5 (19.5-23.1)	29.0±1.7 (26.4-31.4)	1.37	0.73	15.4±1.6 (13.2-18.2)	1.4±0.8 (0.5-2.5)	11.00	0.39	1.4±1.0 (0.5-2.5)	13.2±3.3 (11.6-18.2)	3.0±0.3 (2.5-3.3)	2.8±0.8 (2.0-4.0)
<i>B. resinosa</i>	45.3±2.1 (41.6-49.5)	25.0±1.3 (23.1-27.2)	32.7±1.2 (31.4-34.7)	1.39	0.76	11.8±1.3 (9.9-13.2)	1.7±1.0 (0.3-3.1)	6.94	0.26	1.0±0.4 (0.7-1.7)	12.9±3.2 (9.9-18.2)	2.4±0.5 (1.8-3.0)	1.1±0.5 (0.3-1.8)
<i>B. subsessalis</i>	48.4±2.4 (44.6-51.5)	25.0±0.7 (24.3-26.4)	35.7±1.7 (33.3-38.0)	1.36	0.70	13.4±1.2 (11.6-14.9)	1.5±0.4 (0.8-2.1)	8.93	0.28	1.3±0.7 (0.7-2.7)	13.4±3.5 (9.9-18.2)	2.6±0.5 (2.0-3.3)	1.7±0.6 (0.8-2.8)
Section <i>Racemosae</i>													
<i>B. racemosa</i>	40.4±2.1 (39.3-44.2)	20.9±1.5 (19.0-23.4)	30.8±1.2 (28.1-32.0)	1.31	0.68	15.0±1.6 (13.2-16.8)	1.3±0.6 (0.5-2.2)	11.54	0.37	1.2±1.0 (0.3-3.0)	12.8±4.4 (8.3-19.8)	2.3±0.3 (2.0-3.0)	1.6±0.3 (1.3-1.8)
<i>Bryanthus gmelinii</i>	33.3±1.1 (31.4-34.7)	17.4±0.6 (16.5-18.2)	19.9±6.1 (21.1-23.1)	1.67	0.87	23.1±1.5 (21.5-24.8)	0.4±0.1 (0.3-0.5)	57.75	0.69	1.8±0.6 (0.8-2.5)	6.3±1.7 (3.3-8.3)	2.1±0.2 (1.8-2.5)	0.9±0.4 (0.5-1.7)
Tribe Empetreae													
<i>Corema conradii</i>	32.5±1.0 (30.7-33.6)	17.8±1.0 (15.4-19.2)	22.9±1.1 (21.6-24.5)	1.42	0.78	17.6±1.6 (14.9-20.2)	0.9±0.4 (0.2-1.2)	19.56	0.54	0.6±0.2 (0.5-1.0)	5.2±1.8 (4.3-8.2)	2.0±0.4 (1.4-2.4)	2.5±0.5 (1.9-3.6)
<i>Empetrum nigrum</i>	37.5±3.0 (33.1-42.7)	20.2±1.4 (18.2-23.0)	27.3±2.1 (24.5-30.2)	1.37	0.74	13.6±2.5 (9.6-15.4)	n.d.	n.d.	0.36	n.d.	n.d.	2.1±0.3 (1.9-2.6)	2.5±0.3 (1.9-2.9)
Tribe Ericaceae													
<i>Calluna vulgaris</i>	39.8±2.4 (34.7-42.9)	20.4±1.9 (17.8-23.1)	25.7±1.7 (23.1-28.1)	1.55	0.79	12.7±1.7 (11.6-16.5)	0.8±0.6 (0.5-2.3)	15.88	0.32	0.5	6.4±2.7 (3.3-9.9)	1.9±0.2 (1.7-2.1)	0.7±0.2 (0.5-1.5)
<i>Daboecia cantabrica</i> Halliday 123/70	34.3±0.8 (33.2-34.7)	18.0±0.8 (16.8-19.1)	24.2±1.1 (22.8-26.2)	1.41	0.73	24.8±1.0 (23.1-27.2)	1.1±0.3 (0.7-1.5)	n.d.	0.72	1.5±0.5 (0.8-2.5)	6.3±2.3 (3.3-9.9)	1.5±0.1 (1.5-1.7)	0.9±0.3 (0.5-1.3)
Nilson & Degelius s.n.	30.7±1.6 (28.2-33.0)	16.3±0.7 (15.3-17.7)	21.4±1.1 (19.8-23.1)	1.43	0.76	22.8±1.4 (21.5-24.8)	0.8±0.3 (0.5-1.3)	17.56	0.74	0.6±0.1 (0.5-0.8)	4.8±1.7 (3.3-8.3)	1.4±0.2 (1.2-1.7)	1.8±0.6 (1.3-2.6)
<i>Erica arborea</i>	30.1±1.8 (27.4-32.2)	15.5±1.2 (13.2-17.7)	22.0±1.1 (20.1-23.1)	1.37	0.70	15.5±2.4 (13.2-19.8)	1.2±0.7 (0.5-2.6)	12.92	0.51	1.0±0.6 (0.3-1.7)	9.0±2.8 (5.0-13.2)	1.9±0.3 (1.5-2.5)	1.1±0.4 (0.5-1.7)
<i>E. axillaris</i>	33.9±2.2 (31.0-36.3)	18.3±1.6 (15.2-20.5)	26.6±2.1 (24.0-29.7)	1.27	0.69	17.8±1.9 (14.9-19.8)	0.9±0.3 (0.3-1.3)	19.78	0.53	1.0±0.6 (0.3-1.7)	9.6±1.4 (8.3-11.6)	3.1±0.3 (2.8-3.6)	2.3±0.6 (1.7-3.3)
<i>E. cinerea</i>	48.4±2.4 (46.2-53.1)	25.1±1.0 (23.4-26.1)	35.7±2.0 (33.0-39.3)	1.36	0.70	29.5±8.4 (22.3-51.2)	1.4±0.6 (0.8-2.3)	21.07	0.60	1.5±0.4 (0.8-2.1)	10.5±2.2 (9.9-16.5)	2.1±0.3 (2.0-2.6)	1.2±0.5 (0.7-1.8)
<i>E. dumosa</i>	35.6±1.2 (34.2-36.4)	17.5±1.1 (15.2-18.5)	24.9±1.1 (23.1-26.4)	1.43	0.70	24.0±1.4 (21.5-26.4)	1.3±0.5 (0.5-2.1)	18.46	0.67	0.8±0.2 (0.5-1.2)	7.9±0.6 (6.6-8.3)	3.1±0.2 (3.0-3.3)	3.2±0.2 (3.0-3.3)
<i>E. glabella</i> ssp. <i>glabella</i>	33.6±1.0 (32.2-34.8)	17.8±0.7 (16.8-19.2)	24.4±0.9 (23.1-25.9)	1.38	0.73	25.2±1.6 (23.1-28.1)	1.4±0.8 (0.5-3.0)	18.00	0.75	1.1±0.5 (0.5-2.0)	8.7±0.7 (8.3-9.9)	2.4±0.4 (1.7-2.8)	1.8±0.6 (1.3-3.3)

Table 3-3-2. Continued.

Name of Species	D	P	d	D/d	P/E	Ectoaperture			2f/D	Endoaperture		Apo. exine thickness	Septum thickness
						Length (2f)	Width (W)	2f/W		Length	Width		
<i>E. multiflora</i>	29.8±2.3 (25.1-33.0)	15.6±0.8 (14.9-16.7)	22.6±1.1 (21.5-25.1)	1.32	0.69	16.5±1.4 (13.2-18.2)	0.5±0.1 (0.3-0.7)	33.00	0.55	0.8±0.4 (0.3-1.7)	8.4±1.5 (6.6-9.9)	2.0±0.2 (1.8-2.5)	1.1±0.4 (0.5-1.5)
<i>E. sicula</i>	47.1±1.5 (44.6-49.8)	24.3±1.5 (21.8-26.4)	36.8±1.5 (34.7-39.3)	1.28	0.66	24.8±3.5 (20.6-31.4)	2.2±0.7 (1.3-3.0)	11.27	0.53	1.7±1.0 (0.5-3.3)	11.2±1.0 (9.9-13.2)	2.8±0.2 (2.4-3.0)	0.9±0.3 (0.3-1.3)
<i>E. tetralix</i>	42.4±2.5 (39.6-47.5)	20.7±0.8 (19.8-22.1)	30.8±1.4 (28.1-33.2)	1.38	0.67	23.1±2.2 (19.8-26.4)	3.1±0.7 (1.3-3.8)	7.45	0.54	2.4±1.0 (0.5-3.3)	8.9±2.0 (6.6-11.6)	1.5±0.2 (1.3-1.8)	1.3±0.3 (0.5-1.7)
<i>E. trimera</i> ssp. <i>keniensis</i>	30.6±1.3 (28.9-32.2)	15.7±0.7 (14.7-16.8)	22.1±0.7 (21.1-23.1)	1.38	0.71	14.1±2.3 (9.9-18.2)	0.4±0.1 (0.3-0.5)	35.25	0.46	0.4±0.1 (0.3-0.5)	8.3±1.6 (6.6-11.6)	2.3±0.4 (1.7-3.0)	2.5±1.1 (1.3-4.1)
<i>E. barbiger</i>	-	22.7±0.6 (21.5-23.4)	26.3±1.0 (24.8-28.1)	-	0.86	19.1±1.3 (17.3-21.5)	1.3±0.6 (0.5-2.0)	14.69	-	2.0±0.7 (1.3-3.0)	7.2±0.9 (5.8-8.3)	1.7±0.3 (1.2-2.0)	1.5±0.2 (1.3-1.8)
<i>E. bokkeveldia</i>	-	26.4±2.9 (21.5-29.7)	19.7±2.9 (16.8-26.1)	-	1.34	20.1±1.9 (18.2-24.8)	0.8±0.4 (0.5-1.7)	25.13	-	2.5±1.2 (3.3-5.0)	3.9±0.8 (2.5-3.3)	2.8±0.3 (2.5-3.3)	2.8±0.4 (2.5-3.3)
<i>E. curvistyla</i>	-	25.2±0.9 (23.1-26.4)	19.9±0.6 (18.8-21.0)	-	1.27	18.6±1.2 (16.5-19.8)	0.5±0.1 (0.3-0.7)	37.20	-	3.4±0.7 (2.5-5.0)	3.7±0.8 (2.5-5.0)	2.6±0.5 (1.8-3.1)	1.8±0.1 (1.7-2.0)
<i>E. globiceps</i> ssp. <i>consors</i>	-	20.2±1.3 (17.0-21.5)	22.2±1.0 (20.8-24.4)	-	0.91	16.4±1.2 (14.0-18.2)	1.5±0.2 (1.3-2.0)	10.93	-	0.7±0.1 (0.5-0.8)	7.4±0.9 (6.6-8.7)	1.9±0.6 (1.0-2.6)	1.2±0.4 (0.5-1.8)
<i>E. plumosa</i>	-	21.4±1.1 (20.1-23.3)	24.4±0.9 (23.3-24.9)	-	0.88	15.3±1.0 (14.0-17.3)	1.4±0.2 (1.2-1.7)	10.93	-	1.2±0.2 (0.8-1.2)	7.6±0.8 (6.6-8.3)	1.4±0.5 (0.5-2.0)	1.5±0.3 (1.2-2.0)
<i>E. puberuliflora</i>	-	20.9±1.1 (19.5-22.8)	24.2±0.8 (22.8-25.1)	-	0.86	14.5±1.9 (11.6-16.5)	1.5±0.6 (0.7-2.4)	9.67	-	1.3±0.6 (0.7-2.1)	7.3±1.1 (5.0-8.3)	3.1±0.9 (1.3-4.1)	2.4±0.7 (1.3-3.0)
<i>E. recurvifolia</i>	-	23.0±1.7 (20.0-24.8)	16.8±1.0 (15.2-18.3)	-	1.37	18.6±1.6 (16.5-21.5)	0.6±0.2 (0.5-1.0)	31.00	-	1.0±0.7 (0.5-2.3)	4.5±0.6 (3.6-5.0)	2.3±0.5 (2.0-3.0)	2.0±0.2 (1.8-2.1)
<i>E. similis</i>	-	18.4±0.8 (17.0-19.5)	25.3±0.7 (24.4-26.7)	-	0.73	15.5±0.7 (14.9-16.5)	4.3±0.5 (3.6-5.0)	3.60	-	1.0±0.6 (0.5-2.0)	5.9±0.8 (5.0-6.6)	2.8±0.6 (2.0-3.6)	2.1±0.3 (1.7-2.5)
<i>E. spiculifolia</i>	-	18.6±1.9 (15.2-21.5)	20.5±1.5 (18.2-23.1)	-	0.91	13.6±1.5 (11.6-16.5)	0.8±0.5 (0.3-1.7)	17.00	-	1.1±0.7 (0.3-2.0)	4.3±0.8 (3.3-5.8)	1.7±0.3 (1.3-2.0)	1.5±0.2 (1.2-2.0)
<i>E. uberiflora</i>	-	17.7±1.2 (16.2-19.5)	18.7±1.0 (17.8-20.8)	-	0.95	12.1±2.0 (8.3-14.9)	0.8±0.3 (0.5-1.2)	15.13	-	0.8±0.3 (0.3-1.3)	5.1±1.6 (3.3-8.3)	1.9±0.4 (1.7-3.0)	1.5±0.1 (1.3-1.7)
<i>E. xeranthemifolia</i>	-	25.9±1.0 (23.1-26.7)	26.9±1.4 (25.2-29.4)	-	0.96	21.7±1.6 (19.8-24.8)	0.7±0.3 (0.5-1.3)	31.00	-	1.6±0.4 (1.3-2.5)	5.5±1.1 (3.6-7.4)	2.1±0.5 (1.7-3.0)	1.8±0.3 (1.3-2.3)

Table 3-3-2. Continued.

Name of Species	D	P	d	D/d	P/E	Ectoaperture			2f/D	Endoaperture		Apo. exine thickness	Septum thickness
						Length (2f)	Width (W)	2f/W		Length	Width		
Tribe Phyllodoceae													
<i>Elliottia bracteata</i>	52.1±3.1 (47.9-57.8)	26.9±1.8 (24.4-29.7)	37.5±2.1 (34.7-42.1)	1.39	0.72	20.0±3.4 (14.9-23.1)	1.0±0.4 (0.5-1.3)	20.00	0.38	2.0±1.1 (0.7-3.3)	11.6±2.0 (9.9-14.9)	1.8±0.2 (1.5-2.0)	1.2±0.4 (0.3-1.7)
<i>E. paniculata</i>	45.7±1.4 (42.9-48.2)	24.4±1.6 (22.8-28.1)	33.7±1.4 (32.0-36.1)	1.36	0.72	19.2±3.1 (14.9-24.8)	1.7±0.2 (1.5-2.1)	11.29	0.42	1.6±0.5 (1.2-2.5)	8.6±1.0 (6.6-9.9)	1.8±0.2 (1.5-2.4)	1.2±0.4 (0.5-1.7)
<i>E. pyroliflora</i>	53.3±1.6 (50.8-56.1)	26.7±2.1 (23.1-29.7)	38.7±1.8 (36.3-41.3)	1.38	0.69	20.7±2.8 (16.5-24.8)	2.3±0.8 (1.3-3.8)	9.00	0.39	1.7±1.1 (0.7-3.3)	10.8±1.6 (8.3-13.2)	2.1±0.2 (1.8-2.7)	1.5±0.3 (1.2-1.8)
<i>Epigaea repens</i>	38.5±1.5 (35.6-40.1)	19.8±1.2 (18.0-21.5)	29.0±1.0 (28.1-30.5)	1.33	0.68	21.5±1.9 (18.2-24.8)	2.1±0.3 (1.3-2.7)	10.24	0.56	0.8±0.4 (0.3-1.3)	8.1±2.3 (5.0-11.6)	2.5±0.4 (1.8-3.0)	1.4±0.1 (1.3-1.5)
<i>Kalmia angustifolia</i>	32.2±1.4 (29.9-34.3)	16.2±0.8 (14.9-17.2)	23.0±0.9 (21.9-24.8)	1.40	0.70	14.7±2.0 (9.9-16.7)	0.8±0.3 (0.5-1.3)	18.38	0.43	0.4±0.3 (0.2-1.2)	7.9±1.0 (6.6-9.9)	1.9±0.1 (1.8-2.1)	0.9±0.3 (0.5-1.3)
<i>K. buxifolia</i>	24.4±0.8 (23.1-25.9)	12.8±0.9 (11.4-14.9)	17.3±0.5 (16.5-18.2)	1.41	0.74	16.4±1.4 (13.2-18.2)	0.4±0.1 (0.3-0.7)	41.00	0.67	0.4±0.1 (0.3-0.5)	5.8±1.0 (5.0-6.6)	1.6±0.3 (1.3-2.0)	1.9±0.1 (1.7-2.0)
<i>K. ericoides</i> var. <i>aggregata</i>	32.6±1.3 (29.5-33.7)	16.7±1.0 (15.2-18.3)	21.9±0.9 (20.6-23.4)	1.49	0.76	12.1±1.7 (9.9-14.9)	0.6±0.1 (0.5-0.7)	20.17	0.37	0.6±0.2 (0.5-1.2)	8.8±1.7 (6.6-11.6)	2.1±0.3 (1.8-3.0)	0.8±0.4 (0.3-1.5)
<i>K. latifolia</i>	36.6±1.6 (34.7-39.1)	18.8±1.1 (16.6-20.1)	26.3±1.1 (24.8-28.1)	1.39	0.71	11.6±2.0 (8.3-14.9)	0.6±0.3 (0.3-1.3)	19.33	0.32	1.0±0.5 (0.3-1.7)	9.1±3.5 (5.0-14.9)	1.8±0.1 (1.7-2.0)	0.7±0.3 (0.5-1.3)
<i>K. polifolia</i>	30.2±2.2 (27.6-33.6)	16.8±2.4 (12.5-19.7)	23.0±1.2 (21.8-25.2)	1.31	0.73	16.3±2.9 (13.9-21.1)	1.2±0.2 (1.0-1.9)	13.58	0.54	1.6±0.7 (0.5-1.9)	7.4±0.6 (6.7-8.2)	2.1±0.4 (1.4-2.6)	1.6±0.3 (1.2-1.9)
<i>K. procumbens</i> Takahashi et al. 2644	30.7±2.3 (28.4-34.0)	16.6±1.1 (14.0-18.0)	21.9±1.8 (19.8-25.1)	1.40	0.76	19.6±1.7 (17.3-23.1)	0.5±0.1 (0.3-0.7)	39.20	0.51	0.9±0.6 (0.3-1.7)	9.9±2.0 (6.6-13.2)	1.8±0.2 (1.7-2.0)	0.9±0.4 (0.3-1.3)
Takahashi 9907	31.5±1.1 (30.0-33.3)	16.4±1.2 (14.7-18.2)	22.4±1.4 (20.6-24.8)	1.41	0.73	15.7±0.8 (14.9-16.5)	0.8±0.3 (0.5-1.2)	19.63	0.62	1.1±0.9 (0.5-2.1)	11.6±1.7 (9.9-13.2)	1.8±0.1 (1.5-2.0)	0.7±0.3 (0.3-1.3)
<i>Phyllodoce aleutica</i>	33.0±1.7 (31.4-34.7)	15.8±2.0 (14.2-18.0)	24.1±1.1 (22.8-24.8)	1.37	0.66	n.d.	n.d.	n.d.	n.d.	n.d.	n.d.	1.7±0.1 (1.7-1.8)	1.0±0.3 (0.7-1.3)
<i>P. caerulea</i>	30.0±1.7 (27.2-33.0)	16.1±1.2 (13.9-17.2)	22.0±1.3 (19.8-24.4)	1.36	0.73	15.8±1.2 (13.2-17.3)	0.9±0.3 (0.5-1.5)	17.56	0.53	1.3±0.6 (0.5-2.0)	7.6±2.9 (5.0-11.6)	1.9±0.3 (1.5-2.7)	0.9±0.3 (0.5-1.3)
<i>P. nipponica</i> var. <i>oblong-ovata</i>	33.7±2.7 (29.7-38.1)	17.2±1.6 (15.0-19.5)	25.2±1.0 (23.9-26.7)	1.34	0.68	11.5±1.4 (9.9-13.2)	2.3±0.7 (1.3-3.5)	5.00	0.34	0.9±0.5 (0.5-1.7)	7.4±1.7 (5.0-8.3)	1.7±0.1 (1.7-1.8)	1.1±0.3 (0.3-1.3)
<i>Rhodothamnus chamaecistus</i>	42.4±1.8 (39.6-44.6)	22.3±1.1 (21.3-25.1)	31.5±1.3 (29.7-33.0)	1.35	0.70	17.7±1.6 (14.9-19.8)	1.6±0.4 (0.7-2.0)	11.06	0.42	1.4±0.8 (0.5-2.5)	10.4±1.2 (8.3-11.6)	1.8±0.3 (1.3-2.1)	1.5±0.6 (0.5-2.0)

Table 3-3-2. Continued.

Name of Species	D	P	d	D/d	P/E	Ectoaperture			2f/D	Endoaperture		Apo. exine thickness	Septum thickness
						Length (2f)	Width (W)	2f/W		Length	Width		
Tribe Rhodoreae													
<i>Menziesia multiflora</i>	36.7±2.5 (32.8-39.8)	18.7±1.6 (17.2-21.6)	27.5±1.3 (25.6-29.7)	1.33	0.68	15.4±1.5 (13.2-17.3)	1.7±0.4 (1.3-2.5)	9.06	0.42	1.8±0.6 (1.3-3.3)	8.7±1.4 (6.6-11.6)	1.7±0.2 (1.3-2.0)	1.0±0.4 (0.3-1.3)
<i>M. pentandra</i>	34.3±1.5 (31.7-36.6)	17.4±0.7 (16.7-18.6)	24.0±1.2 (21.6-25.1)	1.43	0.73	17.6±1.0 (16.5-19.8)	1.1±0.4 (0.5-1.5)	16.00	0.51	1.0±0.4 (0.5-1.7)	6.2±1.3 (5.0-8.3)	1.7±0.1 (1.5-2.0)	1.2±0.1 (1.0-1.5)
<i>Rhododendron</i>													
Subgenus <i>Azaleastrum</i>													
Section <i>Tsutsutsi</i>													
<i>R. dilatatum</i>	56.4±1.8 (54.1-59.4)	29.7±2.1 (26.4-32.7)	39.6±1.8 (38.0-42.9)	1.42	0.75	17.8±2.4 (14.9-23.1)	0.7±0.3 (0.5-1.3)	25.43	0.32	0.6±0.2 (0.3-1.0)	9.9±1.9 (6.6-13.2)	3.4±0.4 (3.0-4.3)	1.7±0.3 (1.3-2.1)
<i>R. japonicum</i>	63.2±2.2 (59.7-66.3)	31.8±1.1 (30.5-33.3)	48.3±1.6 (45.4-49.5)	1.31	0.66	19.6±1.4 (18.2-21.5)	2.1±0.7 (1.2-3.0)	9.33	0.31	1.1±0.4 (0.5-1.7)	11.4±1.5 (8.3-13.2)	3.0±0.2 (2.8-3.3)	1.5±0.2 (1.3-1.7)
<i>R. kaempferi</i>	53.0±3.4 (48.7-58.6)	27.9±2.8 (23.1-33.3)	37.4±3.0 (33.0-44.6)	1.42	0.75	18.4±2.5 (14.9-22.3)	1.2±0.5 (0.5-2.1)	15.33	0.35	0.8±0.5 (0.5-1.7)	7.6±1.6 (3.3-8.3)	2.6±0.4 (2.2-3.5)	1.6±0.3 (1.2-2.0)
<i>R. macrosepalum</i>	56.7±2.7 (54.8-60.3)	29.9±2.6 (26.4-32.2)	40.9±1.6 (39.6-42.9)	1.39	0.73	18.6±4.1 (15.7-21.4)	0.9±0.6 (0.5-1.3)	20.67	0.33	1.3 (0.5-1.7)	9.9 (6.6-13.2)	3.2±0.2 (3.0-3.3)	1.7±0.5 (1.3-2.0)
<i>R. nudipes</i> ssp. <i>niphophyllum</i>	54.6±2.5 (51.2-59.6)	28.1±1.7 (25.6-30.9)	36.7±1.7 (34.7-39.6)	1.49	0.77	22.6±3.2 (19.8-28.1)	1.7±1.0 (0.8-3.3)	13.29	0.41	1.5±1.1 (0.7-3.3)	9.9±1.7 (8.3-11.6)	3.4±0.3 (3.0-4.0)	3.2±1.0 (2.2-5.0)
<i>R. tsusiohyllum</i>	35.0±1.3 (33.0-37.0)	18.1±1.3 (15.2-20.1)	26.0±1.6 (23.1-28.1)	1.35	0.70	14.5±2.1 (12.4-19.0)	2.2±0.8 (1.3-3.6)	6.59	0.41	0.6±0.3 (0.3-1.3)	6.8±1.4 (5.0-9.9)	2.1±0.2 (2.0-2.5)	1.8±0.6 (1.3-3.0)
<i>R. wadanum</i>	54.1±2.5 (50.8-59.4)	28.8±1.6 (26.4-31.4)	37.2±1.5 (34.7-39.6)	1.45	0.77	18.6±2.0 (14.9-20.6)	0.8±0.3 (0.5-1.2)	23.25	0.34	1.1±0.5 (0.5-2.0)	10.7±1.6 (8.3-13.2)	3.6±0.3 (3.1-4.3)	1.5±0.3 (0.8-2.0)
<i>R. weyrichii</i>	55.7±1.8 (52.8-57.8)	29.3±2.1 (27.2-33.7)	39.4±2.6 (36.3-43.2)	1.41	0.74	18.6±3.1 (13.2-23.1)	1.1±0.4 (0.7-1.7)	16.91	0.33	0.8±0.3 (0.5-1.3)	9.4±2.0 (8.3-13.2)	3.3±0.1 (3.1-3.5)	2.2±0.7 (1.5-3.3)
Section <i>Sciadorhodion</i>													
<i>R. albrechtii</i>	67.1±3.3 (61.1-72.6)	35.3±3.1 (30.7-41.3)	47.5±4.3 (41.3-54.0)	1.41	0.74	30.4±4.8 (24.8-38.8)	2.2±0.6 (1.3-3.0)	13.82	0.45	1.8±1.0 (0.5-3.6)	11.6±2.7 (8.3-16.5)	2.7±0.5 (1.7-3.1)	1.6±0.4 (1.2-2.5)
<i>R. schlippenbachii</i>	52.4±2.8 (48.0-57.6)	28.7±1.9 (25.2-30.7)	38.8±1.9 (35.0-41.3)	1.35	0.74	18.7±1.9 (16.3-21.1)	2.1±0.4 (1.4-2.6)	8.90	0.36	2.6±0.3 (2.4-2.9)	10.0±1.8 (8.4-12.0)	2.6±0.2 (2.4-2.9)	1.9±0.3 (1.4-2.4)
Subgenus <i>Hymenanthes</i>													
Section <i>Ponticum</i>													
<i>R. aureum</i>	57.0±2.5 (51.2-59.4)	29.1±1.4 (26.7-31.0)	37.7±1.8 (35.5-40.9)	1.51	0.77	20.9±2.4 (18.2-24.8)	1.0±0.4 (0.5-1.5)	20.90	0.37	1.1±0.5 (0.5-1.7)	9.5±11.9 (6.6-11.6)	2.4±0.4 (1.8-3.0)	1.4±0.3 (0.7-1.8)
<i>R. brachycarpum</i>	48.5±2.9 (44.2-52.8)	25.5±2.1 (22.3-28.1)	35.6±1.7 (34.3-38.0)	1.36	0.72	20.2±2.0 (17.3-23.1)	0.7±0.2 (0.5-1.2)	28.86	0.42	0.8±0.4 (0.5-1.7)	11.9±3.8 (8.3-19.8)	3.0±0.5 (1.8-3.3)	1.1±0.4 (0.5-1.7)

Table 3-3-2. Continued.

Name of Species	D	P	d	D/d	P/E	Ectoaperture			2f/D	Endoaperture		Apo. exine thickness	Septum thickness
						Length (2f)	Width (W)	2f/W		Length	Width		
<i>R. decorum</i>	65.0±2.3 (62.0-69.3)	34.9±1.9 (31.0-38.0)	44.6±0.9 (42.9-45.9)	1.46	0.78	24.8±3.5 (18.2-31.4)	0.7±0.3 (0.5-1.2)	35.43	0.38	0.7±0.3 (0.5-1.3)	10.9±1.6 (8.3-13.2)	2.6±0.4 (2.0-3.0)	2.4±1.0 (1.3-4.1)
<i>R. formosanum</i>	65.2±1.9 (62.9-68.4)	35.8±1.5 (33.1-38.9)	44.3±1.1 (42.7-46.6)	1.47	0.81	27.3±3.1 (22.8-31.9)	2.2±0.3 (1.9-2.9)	12.36	0.42	1.4±0.6 (0.7-2.4)	15.2±1.1 (13.2-16.3)	2.7±0.3 (2.4-3.1)	3.6±0.6 (2.4-4.3)
Subgenus <i>Rhododendron</i>													
Section <i>Rhododendron</i>													
Subsection <i>Lapponica</i>													
<i>R. lapponicum</i>	45.7±0.7 (44.9-46.2)	24.9±0.4 (24.4-25.2)	32.3±0.9 (31.4-33.0)	1.41	0.77	17.7±0.6 (17.3-18.2)	1.5	11.80	0.39	1.7±1.2 (0.8-2.5)	9.9	2.1±0.3 (1.8-2.5)	0.6±0.3 (0.3-0.8)
Subsection <i>Triflora</i>													
<i>R. davidsonianum</i>	51.2±2.6 (46.7-54.5)	26.5±1.2 (24.8-28.1)	37.4±1.2 (35.5-39.6)	1.37	0.71	18.6±2.8 (14.9-23.1)	1.0±0.4 (0.5-1.5)	18.60	0.36	1.1±0.6 (0.5-2.0)	8.0±1.9 (6.7-11.6)	3.1±0.3 (2.5-3.5)	1.2±0.1 (1.0-1.3)
Subsection <i>Ledum</i>													
<i>R. diversipilosum</i>	30.9±1.5 (29.4-33.5)	16.3±0.9 (14.9-18.2)	21.8±0.9 (20.6-23.1)	1.42	0.75	16.7±1.7 (13.2-19.0)	1.4±0.6 (0.3-2.5)	11.93	0.54	1.5±0.5 (0.7-2.0)	7.5±2.1 (4.1-11.6)	1.9±0.2 (1.7-2.1)	1.2±0.3 (0.7-1.8)
<i>R. subarcticum</i>	31.8±1.1 (30.0-33.2)	17.3±0.9 (15.8-18.5)	23.2±0.5 (22.3-23.9)	1.37	0.75	16.6±1.2 (14.0-19.0)	0.8±0.3 (0.5-1.2)	20.75	0.52	0.7±0.3 (0.3-1.3)	8.4±1.2 (6.6-9.9)	1.7±0.2 (1.3-2.0)	0.6±0.3 (0.3-1.2)
<i>Therorhodion camtschaticum</i>	50.0±4.2 (43.9-57.8)	26.5±1.9 (23.3-29.5)	35.0±3.6 (29.4-41.3)	1.43	0.76	14.8±2.0 (12.4-17.3)	2.9±0.6 (2.1-4.0)	5.10	0.30	1.7±0.3 (1.3-2.4)	9.7±1.1 (8.3-11.6)	2.2±0.4 (1.8-3.0)	1.4±0.1 (1.2-1.5)

D: tetrad diameter, P: polar length, d(E): equatorial diameter, Apo.: apocolpium, n.d.: not discerned, minimum–maximum value in μm in parenthesis.

Pollen morphology of tribe Bejariae [3 genera / 2 genera examined: *Bejaria* and *Bryanthus*]

Bejaria [15 spp. / 4 spp. examined: *B. aestuans*, *B. racemosa*, *B. resinosa* and *B. subsessilis*]

Pollen grains are in tetrahedral tetrad, sometime broken along colpi; viscin threads present, viscin threads sometime swelling at base in *B. aestuans*; D 39.7 – 48.4 μm , P 20.9 – 25.0 μm , E 29.0 – 35.7 μm , D/d 1.31 – 1.39, P/E 0.68 – 0.76, oblate or suboblate; 3-colpor(oid)ate, 2f 11.8 – 15.4 μm , W 1.3 – 1.7 μm , 2f/W 6.94 – 11.54, 2f/D 0.26 – 0.39, costae usually present and indistinct, colpus margin distinct; endocracks present; endoaperture distinct, but indistinct in *B. subsessilis*, lalongate, 1.0 – 1.4 μm long, 12.8 – 13.4 μm wide; apocolpial exine 2.3 – 3.0 μm thick, septum 1.1 – 2.8 μm thick, perforations observed in *B. subsessilis*; tectate, apocolpial exine sculpture from verrucate to coarsely rugulate.

In SEM, pollen surface is somewhat flat, primary apocolpial exine sculpture indistinct, secondary sculpture finely (diam. < 0.5 μm) gemmate-pilate (Type FG; Fig. 3-9 C – I); colpus membrane largely granulate or granuloid.

In TEM for *B. subsessilis*, the apocolpial exine is composed of ectexine and endexine with electron density (Figs. 3-9 J – K). Sexine is ca. 1.2 μm thick and a total exine is ca. 2.2 μm thick (Fig. 3-9 K). The septum is ca. 1.4 – 2.2 μm thick, finely perforated. Intine is almost evenly thick around the pollen tetrad.

Bryanthus [1 sp. / 1 sp. examined: *B. gmelinii*]

Pollen grains are in compact tetrahedral tetrad; viscin threads absent; D 33.3 μm , P 17.4 μm , E 19.9 μm , D/d 1.67, P/E 0.87, suboblate; 3-colporate, angular aperture, 2f 23.1 μm , W 0.4 μm , 2f/W 57.75, 2f/D 0.69, costae present and distinct, colpus margin distinct; endocracks absent or indistinct; endoaperture lalongate, 1.8 μm long, 6.3 μm wide;

apocolpial exine 2.1 μm thick, septum 0.9 μm thick; tectate, apocolpial exine sculpture from finely verrucate to psilate.

In SEM, pollen surface is flat, apocolpial exine sculpture psilate (Type P; Fig. 3-9 O), narrow and elongate colpi; colpus membrane indistinct.

Pollen morphology of tribe Empetreae [3 genera / 3 genera examined: *Ceratiola*, *Corema* and *Empetrum*]

Ceratiola [1 sp. / 1 sp. examined: *C. ericoides*]

All most all pollen grains are either broken or severely shrunk. So, we can not study detail both under LM and SEM,

In SEM, primary apocolpial exine sculpture is coarsely rugulate-psilate, the rugulae with minute (diam. < 0.2 μm) granules (Type RG; Fig. 3-10 D).

Corema [2 spp. / 1 sp. examined: *C. conradii*]

Pollen grains are in tetrahedral tetrad; viscin threads absent; D 32.5 μm , P 17.8 μm , E 22.9 μm , D/d 1.42, P/E 0.78, suboblate; 3-colpor(oid)ate, 2f 17.6 μm , W 0.9 μm , 2f/W 19.56, 2f/D 0.54, costae present and distinct, colpus margin distinct; endocracks absent or indistinct; endoaperture indistinct or lalongate, 0.6 μm long, 5.2 μm wide; apocolpial exine 2.0 μm thick, septum 2.5 μm thick; tectate, apocolpial exine sculpture from finely verrucate to finely rugulate.

In SEM, pollen surface is uneven and rugged, primary apocolpial exine sculpture indistinct, secondary sculpture unit moderately (diam. > 0.5 μm) gemmate-pilate (Type MG; Fig. 3-10 E); colpus narrow and elongate, slit-like, membrane indistinct.

Empetrum [2 spp. / 1 sp. examined: *E. nigrum*]

Pollen grains are in tetrahedral tetrad; viscin threads absent; D 37.5 μm , P 20.2 μm , E

27.3 μm , D/d 1.37, P/E 0.74, oblate; 3-colpor(oid)ate, 2f 13.6 μm , very narrow, 2f/D 0.36, costae present and distinct, colpus margin distinct; endocracks absent or indistinct; endoaperture indistinct; apocolpial exine 2.1 μm thick, septum 2.5 μm thick; tectate, apocolpial exine sculpture from finely verrucate to finely rugulate.

Few pollen grains on SEM stub and all grains are somewhat broken, but pollen surface and apocolpial exine sculpture similar to *Corema conradii* (Type MG); colpus narrow and elongate, slit-like, membrane indistinct.

Pollen morphology of tribe Ericaceae [3 genera / 3 genera examined: *Calluna*, *Daboecia* and *Erica*]

Calluna [1 sp. / 1 sp. examined: *C. vulgaris*]

Pollen grains are in irregular tetrad or in various configurations other than tetrahedron; viscin threads absent; D 39.8 μm , P 20.4 μm , E 25.7 μm , D/d 1.55, P/E 0.79, suboblate; 3-colpor(oid)ate, sometimes apertures arranged according to “Garside’s Law”, 2f 12.7 μm , W 0.8 μm , 2f/W 15.88, 2f/D 0.32, costae usually present and indistinct, colpus margin distinct; endocracks present; endoaperture indistinct or lalongate, 0.5 μm long, 6.4 μm wide; apocolpial exine 1.9 μm thick, septum 0.7 μm thick, perforated; tectate, apocolpial exine sculpture from coarsely verrucate to rugulate.

In SEM, pollen surface is uneven and rugged, apocolpial exine sculpture coarsely rugulate with distinct perforations, the rugulae with very minute granules (diam. < 0.10 μm) (R/RG; Figs. 3-10 H); colpus membrane indistinct.

Daboecia [1 sp. / 1 sp. examined: *D. cantabrica*]

Pollen grains are in tetrahedral tetrad; viscin threads absent; D 30.7 – 34.3 μm , P 16.3 – 18.0 μm , E 21.4 – 24.2 μm , D/d 1.41 – 1.43, P/E 0.73 – 0.76, oblate or suboblate; 3-colpor(oid)ate, 2f 22.8 – 24.8 μm , W 0.8 – 1.1 μm , 2f/W 22.55 – 28.5, 2f/D 0.72 – 0.74,

costae present, distinct or indistinct, colpus margin distinct; endocracks present, indistinct to distinct; endoaperture lalongate, 0.6 – 1.5 μm long, 4.8 – 6.3 μm wide; apocolpial exine 1.4 – 1.5 μm thick, septum 0.9 – 1.8 μm thick, sometimes perforated in one specimen (Nilsson & Degelius s.n.); tectate, apocolpial exine sculpture from finely verrucate to finely rugulate.

In SEM, pollen surface is somewhat flat, apocolpial exine sculpture finely rugulate to psilate (R/P; Fig. 3-10 L), or primary sculpture indistinct, secondary sculpture unit moderately (diam. > 0.5 μm) gemmate-pilate (Type MG; Fig. 3-10 N); colpus sometimes bifurcated, narrow and elongate, membrane granuloid to smooth.

Erica [860 spp. / 23 spp. examined: *Erica arborea*, *E. axillaris*, *E. barbiger*, *E. bokkeveldia*, *E. cinerea*, *E. curvistyla*, *E. dumosa*, *E. glabella* ssp. *glabella*, *E. globiceps* ssp. *consors*, *E. labilis*, *E. mucosa*, *E. multiflora*, *E. nabea*, *E. plumosa*, *E. puberuliflora*, *E. recurvifolia*, *E. sicula*, *E. similis*, *E. spiculifolia*, *E. tetralix*, *E. trimera* ssp. *keniensis*, *E. uberiflora* and *E. xeranthemifolia*]

Pollen grains are commonly in tetrahedral tetrad, monad in some species; viscin threads absent; D 29.8 – 48.4 μm , P 15.5 – 26.4 μm , E 16.8 – 36.8 μm , D/d 1.27 – 1.43, P/E 0.66 – 1.37, oblate to prolate; 3-colpor(oid)ate, rarely 4-colpor(oid)ate, 2f 14.1 – 29.5 μm , L 12.1 – 21.7 μm , W 0.4 – 4.3 μm , 2f/W (L/W) 3.6 – 37.2, 2f/D 0.46 – 0.75, sometimes bifurcated at tip, costae present and distinct, rarely indistinct, colpus margin distinct; endocracks present, distinct or indistinct; endoaperture distinct, rarely indistinct, sometimes 1 or 2 additional endoaperture present, lalongate, H-shaped in some species, rarely circular, 0.4 – 3.4 μm long, 3.7 – 11.2 μm wide; apocolpial exine 1.4 – 3.1 μm thick, septum 0.9 – 3.2 μm thick; tectate, apocolpial exine sculpture from verrucate to psilate.

In SEM, 1) pollen surface is uneven and rugged, primary apocolpial exine sculpture indistinct, secondary sculpture unit moderately (diam. > 0.5 μm) gemmate-pilate (Type MG; Figs. 3-11 J, O, 3-14 D); or 2) surface somewhat flat, primary exine sculpture indistinct,

secondary sculpture unit finely (diam. < 0.5 μm) verrucate (Type FG; Fig. 3-11 K); or 3) surface flat, exine sculpture psilate with very minute (diam. < 0.10 μm) granules or striate (Type P; Fig. 3-11 L, 3-12 E); 4) surface somewhat flat, primary exine sculpture moderate to coarsely rugulate-psilate, the rugulae with minute (diam. < 0.2 μm) granules (Type RG; Fig. 3-11 M – N, 3-12 A – C, F – H); or 5) pollen surface uneven and rugged, primary apocolpial exine sculpture coarsely rugulate to coarsely rugulate-psilate, intermediate types (R/MG or RG/S; Figs. 3-11 I, 3-12 D); colpus membrane largely granulate or granuloid.

Four species of *Erica*, two from each of species having pollen tetrads; *E. multiflora* and *E. trimera* ssp. *keniensis*, and monad; *E. barbiger*a and *E. recurvifolia*, were studied with TEM. The apocolpial exine is composed of ectexine and endexine (e.g., Fig. 3-12 J). Sexine is ca. 0.6 – 0.9 μm thick and a total exine is ca. 1.2 – 1.7 μm thick. The septum is ca. 0.7 – 1.5 μm thick. In *E. barbiger*a and *E. recurvifolia*, two interesting palynological characters; canalized tectum and granular columellae, are observed (Figs. 3-13 D – F). Intine is thin and almost evenly distributed around the pollen tetrad (Fig. 3-13).

Pollen morphology of tribe Phyllodoceae [6 genera / 5 genera examined: *Elliottia*, *Epigaea*, *Kalmia* (including *Leiophyllum* and *Loiseleuria*), *Phyllodoce* and *Rhodothamnus*]

Elliottia [4 spp. / 3 spp. examined: *E. bracteata*, *E. paniculata* and *E. pyroliflora*]

Pollen grains are commonly in tetrahedral tetrad, sometime with other configurations; viscin threads present, but absent in *E. pyroliflora*; D 45.7 – 53.3 μm , P 24.4 – 26.9 μm , E 33.7 – 38.7 μm , D/d 1.36 – 1.39, P/E 0.69 – 0.72, oblate; 3-colporate, 2f 19.2 – 20.7 μm , W 1.0 – 2.3 μm , 2f/W 9.0 – 20.0, 2f/D 0.38 – 0.42, costae present and distinct, colpus margin distinct; endocracks present; endoaperture lalongate, 1.6 – 2.0 μm long, 8.6 – 11.6 μm wide; apocolpial exine 1.8 – 2.1 μm thick, septum 1.2 – 1.5 μm thick; tectate, apocolpial exine sculpture from verrucate to rugulate.

In SEM, pollen surface is uneven to somewhat flat, primary apocolpial exine sculpture indistinct, secondary sculpture unit moderately (diam. > 0.5 µm) gemmate-pilate (Type MG; Fig. 3-14 C), or intermediate type (MG/R; Fig. 3-14 D); colpus sometimes narrow and elongate, membrane granulate.

Epigaea [3 spp. / 2 spp. examined: *E. asiatica* and *E. repens*]

Pollen of *E. asiatica* was studied only with SEM. Pollen grains are in compact tetrahedral tetrad; viscin threads present; D 38.5 µm, P 19.8 µm, E 29.0 µm, D/d 1.33, P/E 0.68, oblate; 3-colporate, 2f 21.5 µm, W 2.1 µm, 2f/W 10.24, 2f/D 0.56, costae present and distinct, colpus margin distinct; endocracks present; endoaperture lalongate, sometimes H-shaped, 0.8 µm long, 8.1 µm wide; apocolpial exine 2.5 µm thick, septum 1.4 µm thick; tectate, apocolpial exine sculpture from verrucate to rugulate.

In SEM, pollen surface is somewhat flat, apocolpial exine sculpture coarsely rugulate, the rugulae transversely striate and intermediate type (RS/R; Fig. 3-14 H), or coarsely rugulate-psilate and intermediate type (R/P; Fig. 3-14 I); colpus membrane granulate.

Kalmia [11 spp. / 7 spp. examined: *K. angustifolia*, *K. buxifolia*, *K. ericoides* var. *aggregata*, *K. latifolia*, *K. microphylla*, *K. polifolia* and *K. procumbens*]

Pollen grains are in tetrahedral tetrad, lobed or compact; viscin threads present or absent; D 24.4 – 36.6 µm, P 12.8 – 18.8 µm, E 17.3 – 26.3 µm, D/d 1.31 – 1.49, P/E 0.70 – 0.76, oblate or suboblate; 3-colpor(oid)ate, rarely 4-colpor(oid)ate, 2f 11.6 – 19.6 µm, W 0.4 – 1.2 µm, 2f/W 13.58 – 41.0, 2f/D 0.32 – 0.67, costae present and distinct, colpus margin distinct, but faintly demarcated in *K. buxifolia*; endocracks present; endoaperture distinct and lalongate, or indistinct, 0.4 – 1.6 µm long, 5.8 – 11.6 µm wide; apocolpial exine 1.6 – 2.1 µm thick, septum 0.7 – 1.9 µm thick; tectate, apocolpial exine sculpture from fine verrucate to rugulate.

In SEM, pollen surface is somewhat flat, 1) apocolpial exine sculpture moderate to coarsely rugulate, with distinct grooves (Type R; Figs. 3-15 A – B, E – F); or 2) primary exine sculpture coarsely rugulate-psilate, the rugulae with moderately (diam. > 0.2 μm) granulate (Type RGS; Fig. 3-15 C); or 3) psilate (Type P; Fig. 3-15 G); colpus membrane variable, from granulate to smooth, sometime indistinct.

In TEM for *K. latifolia*, the apocolpial exine is composed of ectexine and endexine (Fig. 3-15 J). Sexine is ca. 0.5 μm thick and a total exine is ca. 1.0 μm thick (Fig. 3-15 K). The septum is ca. 0.7 – 0.8 μm thick. Intine is thin and almost evenly distributed around the pollen tetrad.

Phyllodoce [7 spp. / 3 spp. examined: *P. aleutica*, *P. caerulea* and *P. nipponica* var. *oblong-ovata*]

Pollen grains are commonly in tetrahedral tetrad, sometime with other configurations; viscin threads commonly present, but absent in *P. caerulea*; D 30.0 – 33.7 μm , P 15.8 – 17.2 μm , E 22.0 – 25.2 μm , D/d 1.34 – 1.37, P/E 0.66 – 0.73, oblate; 3-colpor(oid)ate, 2f 11.5 – 15.8 μm , W 0.9 – 2.3 μm , 2f/W 5.0 – 17.56, 2f/D 0.34 – 0.53, costae present, distinct or indistinct, colpus margin distinct; endocracks present; endoaperture distinct or indistinct, lalongate, 0.9 – 1.3 μm long, 7.4 – 7.6 μm wide; apocolpial exine 1.7 – 1.9 μm thick, septum 0.9 – 1.1 μm thick, faintly perforated in *P. nipponica* var. *oblong-ovata*; tectate, apocolpial exine sculpture from psilate to rugulate.

In SEM, 1) pollen surface is uneven and rugged, apocolpial exine sculpture intermediate type (R/FG; Fig. 3-15 M); or 2) surface somewhat flat, exine sculpture moderately to coarsely rugulate (Type R; Figs. 3-15 N – O); colpus membrane granulate or smooth.

Rhodothamnus [2 spp. / 1 sp. examined: *R. chamaecistus*]

Pollen grains are in tetrahedral tetrad; viscin threads present; D 42.4 μm , P 22.3 μm , E 31.5 μm , D/d 1.35, P/E 0.70, oblate; 3-colporate, rarely 4-colporate, 2f 17.7 μm , W 1.6 μm , 2f/W 11.06, 2f/D 0.42, costae present and distinct, colpus margin distinct; endocracks present; endoaperture lalongate, 1.4 μm long, 10.4 μm wide; apocolpial exine 1.8 μm thick, septum 1.5 μm thick; tectate, apocolpial exine sculpture from finely verrucate to finely rugulate.

In SEM, pollen surface is somewhat flat, apocolpial exine sculpture coarsely rugulate-psilate, the rugulae loosely arranged and clearly striate (Type RS; Fig. 3-16 D); colpus membrane granuloid.

Pollen morphology of tribe Rhodoreae [4 genera / 3 genera studied: *Menziesia*, *Rhododendron* and *Therorhodion*]

Menziesia [7 spp. / 4 spp. examined: *M. cilicalyx*, *M. goyozanensis*, *M. multiflora* and *M. pentandra*]

Pollen of *M. cilicalyx* and *M. goyozanensis* was studied only with SEM. Pollen grains are in tetrahedral tetrad, lobed or compact; commonly viscin threads absent but present in *M. pentandra*; D 34.3 – 36.7 μm , P 17.4 – 18.7 μm , E 24.0 – 27.5 μm , D/d 1.33 – 1.43, P/E 0.68 – 0.73, oblate; 3-colporate, 2f 15.4 – 17.6 μm , W 1.1 – 1.7 μm , 2f/W 9.06 – 16.0, 2f/D 0.42 – 0.51, costae present and distinct, colpus margin distinct; endocracks present; endoaperture lalongate, 1.0 – 1.8 μm long, 6.2 – 8.7 μm wide; apocolpial exine 1.7 μm thick, septum 1.0 – 1.2 μm thick, with faint perforations in *M. pentandra*; tectate, apocolpial exine sculpture finely verrucate.

In SEM, pollen surface is flat, 1) primary apocolpial exine sculpture indistinct, secondary sculpture unit narrow straight-edged striate (Type NS; Figs. 3-16 G, I); or 2) coarsely rugulate, lirae striate (Type R; Fig. 3-16 J); colpus membrane granuloid to smooth.

In TEM for *M. pentandra*, the apocolpial exine is composed of ektexine and endexine (Figs. 3-16 M – O). Sexine is ca. 1.0 μm thick, and a total exine is ca. 1.9 μm thick (Fig. 3-16 N). The septum is ca. 1.3 – 1.9 μm thick. Intine is almost evenly thick around the pollen tetrad, showing lower electron density than the endexine at both apocolpial and septal exine.

Rhododendron [850 spp. / 34 spp. examined: *R. albrechtii*, *R. arborescens*, *R. aureum*, *R. brachycarpum*, *R. dauricum*, *R. davidsonianum*, *R. decorum*, *R. degronianum*, *R. dilatatum*, *R. diversipilosum*, *R. formosanum*, *R. groenlandicum*, *R. hidakanum*, *R. indicum*, *R. japonicum*, *R. kaempferi*, *R. keiskei*, *R. lapponicum*, *R. macrosepalum*, *R. macrostemon*, *R. maddenii*, *R. mucronulatum* var. *ciliatum*, *R. nudipes* ssp. *niphophyllum*, *R. parvifolium*, *R. quinquefolium*, *R. schlippenbachii*, *R. semibarbatum*, *R. subarcticum*, *R. trinerva*, *R. tschonoskii*, *R. tsusiophyllum*, *R. viscistylum* var. *amakusaense*, *R. wadanum* and *R. weyrichii*]

Pollen grains are in tetrahedral tetrad, rarely compact or lobed, grain somewhat shrunk in some species, rarely with other configurations, sometimes in giant dyads in *R. tsusiophyllum*; viscin threads present, rarely absent; D 30.9 – 67.1 μm , P 16.3 – 35.8 μm , E 21.8 – 47.5 μm , D/d 1.31 – 1.51, P/E 0.66 – 0.81, oblate or suboblate; 3-colporate, rare 4-colporate in *R. kaempferi*, finely demarcated, 2f 14.5 – 30.4 μm , W 0.7 – 2.2 μm , 2f/W 6.59 – 35.43, 2f/D 0.31 – 0.54, costae present, distinct or indistinct, colpus margin distinct; endocracks present; endoaperture lalongate, 0.6 – 2.6 μm long, 6.8 – 15.2 μm wide; apocolpial exine 1.7 – 3.6 μm thick, septum 0.6 – 3.6 μm thick; tectate, apocolpial exine sculpture from verrucate to rugulate.

In SEM, 1) pollen surface varies from uneven and rugged to flat, primary apocolpial exine sculpture indistinct, secondary sculpture fine (diam. < 0.5 μm) gemmate-pilate (Type FG; Figs. 3-17 D – L, N – O, 3-18 A – E, G – O, 3-19 A – B); or 2) surface rugged to flat, apocolpial exine sculpture coarsely rugulate, grooves distinct (Type R; Figs. 3-17 M, 3-18 F, 3-19 D – E); colpus membrane granulate to granuloid or rarely smooth.

Three species of *Rhododendron*; *R. japonicum*, *R. schlippenbachii* and *R. tsusiophyllum*, were studied with TEM. The apocolpial exine is composed of ectexine and endexine (Figs. 3-19 G – L, 3-20 A – C). Sexine is ca. 1.1 – 1.3 μm thick, tectum canalized in *R. japonicum* (Fig. 3-19 H), and a total exine is ca. 1.8 – 2.1 μm thick. The septum is ca. 0.9 – 1.9 μm thick. Intine is almost evenly thick around the pollen tetrad, showing lower electron density than the endexine at both apocolpial and septal exine.

Therorhodium [2 spp. / 2 spp. examined: *T. camtschaticum* and *T. redowskianum*]

Pollen of *T. redowskianum* was studied only with SEM. Pollen grains are in lobed tetrahedral tetrad; viscin threads present; D 50.0 μm , P 26.5 μm , E 35.0 μm , D/d 1.43, P/E 0.76, suboblate; 3-colporate, short and narrow in *T. redowskianum*, 2f 14.8 μm , W 2.9 μm , 2f/W 5.1, 2f/D 0.3, costae present and distinct, colpus margin distinct; endocracks present; endoaperture lalongate, 1.7 μm long, 9.7 μm wide; apocolpial exine 2.2 μm thick, septum 1.4 μm thick; tectate, apocolpial exine sculpture from verrucate to rugulate.

In SEM, pollen surface is uneven and rugged, primary apocolpial exine sculpture indistinct, secondary sculpture fine (diam. < 0.5 μm) gemmate-pilate (Type FG; Figs. 3-20 G – H); colpus membrane granuloid or smooth.

Discussion

Variation in palynological features

Pollen grains of this subfamily are characterized by commonly medium, oblate tetrahedral tetrads except in *Calluna* tetrads configured as irregular tetrads. However, the tribe Ericaceae showed most of the variations in the palynological characters found in the family Ericaceae. Pollen varies from minute to medium, oblate to peroblate, and dispersed as

both tetrads and monads. Warner and Chinnappa (1986) considered the round compact tetrads of the Empetraceae and most members of subfamily Vaccinioideae of the Ericaceae as primitive within Ericaceae and loose tetrads relatively derived as the tetrads begin to dissociate and finally evolved into monad. Palynological observations of this study support this view (as discussed in Chapter 4). The pollen tetrads of Empetreae are not compact as stated by Warner and Chinnappa (1986), but normal in my observation (Table 3-3-1). Walker and Doyle (1975) also opined similarly that the monad pollens may be the most primitive and tetrads are derived, and pseudomonad (cryptotetrad) or monad derived from tetrads are more advanced rather than primitive one. The recent classification of Ericaceae (Kron et al. 2002a) showed that genus *Enkianthus* of monotypic subfamily Enkianthoideae is the sister of rest of Ericaceae and monad pollen grains are the plesiomorphic state of pollen dispersal unit, tetrads are relatively derived within Ericaceae. So, monad pollen grains of *Erica* are the most advanced pollen character state and derived from tetrads.

The rare occurrences (less than 5% of total observed grains) of unusual 4-aperturate pollen are observed in some taxa (Table 3-3-1). This might be due to abnormality in the microsporogenesis stage of pollen development, or related to ploidy level and/or pollen size (Lewis 1964, Takahashi 1987a). But, *Erica puberuliflora* has pollen grains of similar size in comparison to other 3-aperturate species, and *E. spiculifolia* and *Kalmia* spp. have even smaller (Table 3-3-1). Three aperturate pollen grains found at most of the taxa, are seems to be symplesiomorphic and 4-aperturate to be derived. Tricolpate pollen is the main and basic type found in most eudicots while other aperture types such as 5-colpate, 6-colpate, porate, colpate, pororate, are regarded as being derived among the eudicots (Walker and Doyle 1975). The shape of tetrahedral tetrads with 4-aperturate grains was little different from of tetrahedral tetrads with 3-aperturate grains (Fig. 3-16 C).

The palynological features are summarized in Table 3-3-1 and all the palynological characters studied with LM are listed in Table 3-3-2. Accordingly among the taxa studied,

pollen of *Rhododendron albrechtii* showed the highest values of D, E and 2f (67.1 μm , 47.5 μm and 30.4 μm , respectively). On the other hand, pollen of *Kalmia buxifolia* showed the lowest values of D, P and W (24.4 μm , 12.8 μm and 0.4 μm , respectively). The highest values of P, D/d, P/E, W, 2f/W (L/W), 2f/D, length and width of endoaperture, apocolpial exine and septum thickness (35.8 μm , 1.67, 1.37, 4.3 μm , 57.75, 0.75, 3.4 μm , 13.4 μm , 3.6 μm and 3.6 μm , respectively), and lowest values of E, D/d, P/E, 2f, 2f/W (L/W), 2f/D, length and width of endoaperture, apocolpial exine and septum thickness (16.8 μm , 1.27, 0.66, 11.5 μm , 3.60, 0.26, 0.4 μm , 3.7 μm , 1.4 μm and 0.7 μm , respectively) were found in different taxa (Table 3-3-2). But, parameters with same value were not uncommon in different taxa, viz., the D/d value 1.37 was found in *Bejaria aestuans*, *Empetrum nigrum*, *Erica arborea*, etc. (Table 3-3-2).

Usually, apocolpial exine is thicker than the septal or mesocolpial exine, but thinner apocolpial exine has been observed in *Corema conradii*, *Empetrum nigrum*, *Erica dumosa*, *Kalmia buxifolia*, and *Rhododendron formosanum* or equal in thickness in *Erica bokkeveldia* (Table 3-3-2). Similar relatively thinner apocolpial exine also has been observed in some taxa of the subfamily Enkianthoideae (Table 3-1-2) and they may have some taxonomic value in the infrageneric classification of the respected genera. In the lobed tetrads of *Rhododendron formosanum*, single pollen grains are might be loosely attached together and do not have reduced septum. Similar caused of comparatively thicker septum has been discussed for tetrads of the family Annonaceae (Le Thomas et al. 1986). However, no significant correlation was found between compactness of tetrad and septum thickness in the present study or published literatures (e.g., Kim et al. 1988).

Although, primary apocolpial exine sculpture with SEM varies from indistinct to psilate, secondary sculpture finely verrucate to moderate gemmate-pilate (Figs. 3-9 – 3-20), the exine sculpture is considerably similar within the genera, except that of *Epigaea*. The exine sculptures of two species of *Epigaea*; *E. asiatica* and *E. repens*, are distinctly different

(Table 3-3-1; Figs. 3-14 H – I). The other morphological features of *Epigaea asiatica* also differ considerably from those of *E. repens* (Stevens 1969), which might be due to disjunct geographic distribution. The taxonomic significance of exine sculpture within and among the tribes is discussed in details later in the discussion.

Taxonomic significance of palynological characters

Tribe Bejariae

Tribe Bejariae is characterized by medium, oblate and lobed tetrads with some exceptions (Table 3-3-1). Both Stevens (1971) and Kron et al. (2002a) characterized the tribe having pollen with viscin threads, though the tribe Bejariae *sensu* Stevens (1971) composed of only genus *Bejaria*. However, viscin threads are not found on the pollen tetrads of *Bryanthus* either in this study or Stevens (1971). Although all of the tribes in Ericoideae (Kron et al. 2002a) can be recognized by means of morphological synapomorphies, the placement *Bejaria* is not strongly supported. Palynological features of genera *Bejaria* and *Bryanthus* showed distinct differences in both qualitative and quantitative characters (Tables 3-3-1 – 3-3-2; Fig. 3-9), and in the principal component analysis (PCA) of the quantitative pollen measurements (Chapter 4; 4 and 5 in Fig. 4-7). Kron et al. (2002a) also reported some additional synapomorphies in *Ledothamnus* and *Bryanthus* which are absent in *Bejaria*. Although I did not study pollen of any *Ledothamnus* taxa, the previous studies of *Ledothamnus* pollen (Maguire et al. 1978, Luteyn 1995c) were reported as “Pollen grains in tetrahedral tetrads; tricolporate; small to medium in size, SEM 23 – 32 μm , LM 30 – 49 μm ; exine sculpturing microrugulate to microverrucate/scabrate becoming psilate along the aperture margin; viscin threads present”. All these variations may indicate that the generic composition of the tribe Bejariae needs to be reexamined by the combined analysis of morphological, palynological and molecular data from higher number of both species and specimens.

The consistently lower values of $2f/D$ in *Bejaria* species i.e. shorter colpi in relation to the overall tetrad diameter, might imply an evolutionary tendency to a reduced colpus (Warner and Chinnappa 1986), and may be an apomorphic pollen character state for this genus as well as the family Ericaceae.

Bryanthus gmelinii, the only species of *Bryanthus*, can be easily distinguished by characteristic minute and suboblate pollen grains united in compact tetrahedral tetrads with angular aperture, viscin threads absent, and exine sculpture of Type P (Tables 3-3-1 – 3-3-2; Figs. 3-9 M – O). On contrary, pollen of *Bejaria* species united in normal tetrahedral tetrads, possess larger values for all the characters except aperture length, and exine sculpture of Type FG (Tables 3-3-1 – 3-3-2; Figs. 3-9 A – L), which is very similar to the exine sculpture of other members of the subfamily Ericoideae especially Rhodoreae (Figs. 3-9 – 3-20).

The infrageneric classification of *Bejaria* (Mansfeld and Sleumer 1935 cf. Clements 1995) has a little or almost no support by the palynological data (Tables 3-3-1 – 3-3-2; Figs. 3-9 A – L). Previously, Clements (1995) concluded that pollen morphology is not taxonomically useful in *Bejaria*, as all species examined are qualitatively identical with only slight quantitative differences. However, the four *Bejaria* species studied have formed two distinct pollen morphological groups; *B. aestuans* + *B. racemosa* vs. *B. resinosa* + *B. subsessalis* (Table 3-3-2), and pollen of *Bejaria* also showed an exceptional character, costae indistinct in all species except *B. aestuans*. The shape of the corolla of *B. aestuans* + *B. racemosa* is characteristically similar; open corolla with spreading or reflexed petal (Clements 1995) which also support the close relation between these two species. These evidences indicate the necessity of a new infrageneric classification for the genus *Bejaria*. Moreover, a detailed phylogenetic study using morphological, anatomical, palynological and molecular data might be helpful to clarify the relationship within *Bejaria* species as well as within the subfamily Ericoideae.

The sister relationship between tribes Bejarieae and Phyllodoceae (Kron et al. 2002a) is not supported by pollen morphological data. Palynological features especially the exine sculpture of the tribe Bejarieae are more similar to the tribe Rhodoreae compared to those of the tribe Phyllodoceae (Tables 3-3-1 – 3-3-2; Figs. 3-9, 3-14 – 3-20). The sister relationship between *Bryanthus* of the tribe Bejarieae and *Empetrum* of the tribe Empetreae (Kron and King 1996) is also not supported by pollen morphological data (Tables 3-3-1 – 3-3-2; Figs. 3-9 – 3-10).

Tribe Empetreae

Samuelsson (1913, cf. Anderberg 1993) was the first to show that the Empetreae were closely related to the Ericaceae. Anderberg (1993) and subsequent workers demonstrated them to be nested within Ericaceae, and finally recognized as a tribe, Empetreae within the subfamily Ericoideae of the Ericaceae (Kron et al. 2002a). Empetreae are easily diagnosed because this clade has numerous distinctive apomorphic characters, most of which relate to a shift from insect to wind pollination, and exhibit a high degree of dioecy (Kron et al. 2002a). Although, the data strongly indicated that Empetreae are derived from within Ericoideae, the exact position of this tribe remained unresolved in relation to the tribes Bejarieae, Ericaceae, Rhodoreae, and Phyllodoceae (Kron et al. 2002a).

Li et al. (2002) studied the phylogenetic relationships of the Empetraceae and concluded that *Ceratiola* is more closely related to *Corema* than to *Empetrum*, and *Empetrum* is sister to the clade containing both *Ceratiola* and *Corema*. The pollen morphology of the Empetraceae *sensu* Stevens (1971) and its taxonomic significance has been studied and discussed in detail by Kim et al. (1988). Although, the Empetreae are stenopalynous, the SEM and TEM observations are very useful for identification of taxa. *Empetrum* is distinct from *Ceratiola* and *Corema* for its non-insular exine structure and thicker tectum (Kim et al. 1988), which may support the close relationship between *Ceratiola* and *Corema* than to

Empetrum. The results of the present study support the palynological observations of Kim et al. (1988), except the apocolpial exine sculpture. Apocolpial exine sculpture of both the taxa; *Ceratiola ericoides* and *Corema conradii* (Type RG or MG; Figs. 3-10 D – E) are relatively less spinuliferous as that of *Corema album* in Díez (1987). Pollen tetrads of this tribe are characterized by consistently thicker septal exine compared to the apocolpial exine. This character is exceptional among the members of the family Ericaceae having pollen tetrads.

The palynological observations of present study may give additional support to the sister relationship between the tribe Empetreae and Ericaceae (Tables 3-3-1 – 3-3-2; Figs. 3-10 – 3-13) as indicated by the analysis of morphological data set (Fig. 3 in Kron et al. 2002a).

Tribe Ericaceae

The tribe Ericaceae is composed of three genera; *Calluna*, *Daboecia* and *Erica*, and *Daboecia* is sister to the rest of the Ericaceae (Kron et al. 2002a). Pollen of this tribe is very variable in nature as indicated earlier and all three genera can be differentiated well by their distinct apocolpial exine sculptures e.g., *Daboecia* pollen has surface somewhat flat and exine sculpture of Type MG (Figs. 3-10 G – O – 3-13). In the palynological investigation of the subfamily Ericoideae *sensu* Stevens (1971), Davis (1997) observed a wide range of variation in the exine sculpture from smooth to verrucate to rugulate with numerous microgranules. And based on the exine sculpturing observations by SEM, eight basic groups were identified among the species studied. The results of present study partly support the observations of Davis (1997).

Recently, Oliver (2000) considered *Erica* as a variable genus; it includes all the genera of the subfamily Ericoideae *sensu* Stevens (1971) except *Calluna*. The exine sculpture of the *Erica* species differed variously (Type MG, FV, P and RG; Figs. 3-11 – 3-12), but commonly characterized by numerous minute granules. Moreover, the exine sculpture of *E. recurvifolia* is very distinct; the psilate primary sculpture possesses clearly striate secondary

sculpture (Type P; Fig. 3-12 E). *Erica recurvifolia* also possesses prolate pollen grains (P/E 1.37) with the smallest equatorial diameter (16.8 μm) within the *Erica* as well as Ericoideae (Table 3-3-2; Davis 1997). Davis (1997) included *E. recurvifolia* in the Group 1 of his tentative grouping of the Ericoideae, but kept somewhat apart from main group due to faint striate appearance on exine surface. Also considering the other morphological differences (Klotzsch 1838, Oliver 2000), it is better to recognize *E. recurvifolia* as a member of a separate monotypic genus *Eremia*; *E. recurvata* Klotzsch, and the psilate primary exine sculpture with the striate secondary sculpture may be the apomorphic palynological character state within the tribe Ericaceae.

Oliver (2000) also divided the species of *Erica* into different informal groups. Palynological data of this study did not clearly correlate with these groups, but some differences are found in the palynological observations; viz. pollen of *E. glabella* was described as monad (Oliver 2000), but it is tetrad in my observation. One of the probable causes on the pollen dispersal unit of *E. glabella*, this species might produce both monads and tetrads. Hitherto, no species has been found having monad and tetrad pollen grains in the *Erica* (Davis 1997) as well as other genera of this family. Another reason may be the pollen grains of *E. glabella* are loosely united together in tetrads which are separate easily to monads. So, palynological observation on larger number of specimen of *E. glabella* is obviously needed to settle the issue.

Generally tetraploids have larger values in all morphological traits compared to those of the diploids. Cockerham and Galletta (1976) found that the mean pollen diameter was 11% larger in the tetraploids compared to that in the diploids in certain *Vaccinium* species. This type of correlation between ploidy level and palynological features is not found in *Erica* (*sensu* Oliver 2000). *Erica spiculifolia* is the only known tetraploid member, is sister to all other *Erica* species (McGuire and Kron 2005), possesses monad pollen grains which are relatively smaller in size compared to those of diploid members of *Erica* (Table 3-3-2).

Similarly, no correlation between tetrad size and the chromosome number has also been reported for North American population of *Arctostaphylos uva-ursi* of subfamily Arbutoideae (Rosatti 1988). However, a variation in tetrad diameter due to geographical distribution is observed in *Erica* species studied. The European taxa sampled in this study have relatively larger tetrads compared to those of African taxa, except in *E. multiflora* which possesses the smallest tetrad among the *Erica* species (Table 3-3-2). McGuire and Kron (2005) discussed the phylogenetic relationships between European and African *Erica* based on molecular data, and concluded that the monophyletic group of African taxa derived from within the European taxa. The geographical variation in tetrad diameter may support the evolutionary trend in pollen size from medium (plesiomorphic state) to minute (apomorphic state) as discussed in Chapter 4.

The exine structure of *Erica* species studied showed some interesting variations and distinct differences. The apocolpial exine sculpture of Type MG in *E. trimera* ssp. *keniensis* is confirmed with TEM (Figs. 3-12 J – K). Moreover, the TEM observations of *Erica* species showed a distinct difference between tetrads and monads. Both the *Erica* species having monad pollen grains; *E. barbiger* and *E. recurvifolia*, showed very unique granular columellae, canalized tectum and the thickness of foot layer considerably varied (Figs. 3-13 D – I). The granular columellae might be a synapomorphic palynological character state found in these two species (detail in Chapter 4). However, this type of distinct difference in the pollen wall structure has not been observed by Davis (1997). Therefore, the ultrastructural study of *Erica* pollen deserves a keen attention, and may be useful for generic limit within *Erica* (*sensu* Oliver 2000).

Tribe Phyllodoceae

The Phyllodoceae (*sensu* Stevens 1971) is a morphologically heterogeneous group that apparently has no morphological synapomorphy (Kron 1997). Moreover, the inclusion of

Epigaea in the tribe Phyllodoceae might be increased the morphological heterogeneity of this group and the monophyly of this group is not well supported by morphology (Kron et al. 2002a). The molecular analyses indicated two strongly supported clades: *Kalmia s.l.* and a *Phyllodoce* clade (including *Epigaea*, *Kalmiopsis*, and *Rhodothamnus*), and *Elliottia* is sister to *Kalmia* + *Phyllodoce* clade (Kron et al. 2002a).

In Phyllodoceae, both medium or minute and oblate pollen grains are usually united in normal tetrahedral tetrads (Table 3-3-1). Although pollen of *K. buxifolia* (*Leiophyllum buxifolium*) and *K. procumbens* (*Loiseleuria procumbens*) showed some very characteristic features e.g., smallest pollen tetrads, septal exine thicker than apocolpial exine etc., the similarities in other palynological characters, viz. D/d, P/E, apocolpial exine thickness and sculpture (Table 3-3-2; Figs. 3-15 A – G) may support the inclusion of *Leiophyllum* and *Loiseleuria* in *Kalmia* (Kron and King 1996, Kron et al. 2002a). With the inclusion of these two monotypic genera; i) a new infrageneric classification for *Kalmia* is obviously needed, as both the new species possess some distinct morphological characters (Kron and King 1996) as well as some unique palynological characters among the species of the genus *Kalmia*, and ii) an evolutionary trend in apocolpial exine sculpture from coarsely rugulate to psilate has been identified.

The positive correlation between pollen tetrad size and ploidy level is also not found in *Kalmia* (Table 3-3-2). Though *K. polifolia* is tetraploid and the rest of the *Kalmia* species all are diploids (Jaynes 1969 cf. Kron and King 1996), the pollen tetrads of *K. polifolia* is relatively smaller than other diploid species. One of the probable cause of this type of exceptional behavior of *K. polifolia* may be the chromosome size. When compared to *K. latifolia*, the chromosomes of *K. polifolia* are about 50% smaller, but contain same amount of chromatin (Kron and King 1996). Kron and King (1996) also reported that the genera; *Epigaea*, *Rhodothamnus*, *Phyllodoce* and *Kalmiopsis*, are consistently made a clade in all molecular analyses, and *Phyllodoce* is paraphyletic. The similarities in palynological features

among these genera (Table 3-3-2) and two relatively distinct exine sculptures (R/FG; Fig. 3-15 M vs. Type R; Figs. 3-15 N – O, 3-16 A) of *Phyllodoce* may give additional support to the suppositions as indicated by the molecular data. In this molecular phylogenetic study (Kron and King 1996), the monophyly of *Elliottia* (including *Cladothamnus* and *Tripetaleia*) is not well supported, although there is no strong support for the breakup of broadly defined *Elliottia*. The palynological features of *Elliottia* may support its monophyly (Table 3-3-1 – 3-3-2; Figs. 3-14 C – D). Infrageneric variation in palynological features due to geographic distribution has been reported for some genera of Ericaceae (e.g., *Pyrola* Takahashi 1986b, *Enkianthus* in this study). Though *Elliottia* has a disjunct geographical distribution, pollen morphology of this genus do not show any significance difference except in P/E ratio (Table 3-3-2).

The exine sculpture of *Rhodothamnus chamaecistus*, with clearly striate secondary sculpture on the rugulae (Type RS; Fig. 3-16 D), is significantly different than that of other members of this tribe except *Epigaea asiatica* (RS/R; Figs. 3-14 H), and very much similar to exine sculpture of members of the tribe Vaccinieae of subfamily Vaccinioideae (Chapter 3-6). The apocolpial exine with striate secondary sculpture may be an apomorphic palynological character state for this tribe.

Tribe Rhodoreae

Generic delimitation of the tribe Rhodoreae is a subject of dispute until now. The tribe Rhodoreae (*sensu* Stevens 1971) comprised 5 genera; *Rhododendron*, *Therorhodion*, *Ledum*, *Tsusiophyllum*, and *Menziesia*. And *Therorhodion* was hypothesized as sister to *Menziesia* + *Tsusiophyllum* + *Rhododendron* (including *Ledum*) (Kron and Judd 1990). The most recent classification of the Ericaceae (Kron et al. 2002a) recognized four genera viz., *Diplarche*, *Menziesia*, *Rhododendron* (including *Ledum* and *Tsusiophyllum*) and *Therorhodion*, in this tribe and this opinion has also been supported by Kron and Luteyn (2005). The phylogenetic

analyses of *Rhododendron* based on molecular data did not support the individual generic status of *Menziesia* and *Therorhodion*, but suggested the inclusion within the genus *Rhododendron* (Kron 1997, Kurashige et al. 2001, Goetsch et al. 2005).

The results of this palynological study added some new disagreements within present generic alignment of this tribe. As expected the quantitative palynological features varies in a large extent in large genus like *Rhododendron*, and gives a little support for the individual generic status of *Menziesia*, *Rhododendron* and *Therorhodion* (Tables 3-3-1 – 3-3-2). But, the specialized exine sculpture of Type NS and perforated septum of *Menziesia*, clearly distinguish the genus from other two genera of this tribe, *Rhododendron* and *Therorhodion* (Tables 3-3-1 – 3-3-2; Fig. 3-16 – 3-20). And along with other morphological and molecular characters (Kron et al. 2002a), the exceptional exine sculpture may also give additional support to the individual generic status of *Menziesia*. Palynological features of the other two genera, *Rhododendron* and *Therorhodion* are very similar (Tables 3-3-1 – 3-3-2; Figs. 3-16 – 3-20), and they support the sister relationship between these two genera as identified by Kron et al (2002a). But the palynological characteristics e.g., tetrad size, exine sculpture, etc. of *R. tsusiophyllum* of sect. *Tsutsutsi* are different from those of other members of the same section as well as subg. *Azaleastrum* (Tables 3-3-1 – 3-3-2; Type FG; Figs. 3-17 D – L, N – O, 3-18 A – C vs. Type R; Fig. 3-17 M). Taking pollen morphology into account *R. tsusiophyllum* should be transferred from the subg. *Azaleastrum* (Goetsch et al. 2005) to subsect. *Ledum* of the subg. *Rhododendron* (Table 3-3-2; Type R; Figs. 3-18 D – E). In TEM, the pollen wall structure of *R. tsusiophyllum* especially sexine-nexine ratio also showed a distinct difference compared to two other taxa of *Rhododendron* (Table 4-2). When considering the differences in beak down of separating wall of pollen sac, opening of anther during maturity, and three-locular ovary, as well as other characters between *R. tsusiophyllum* and other *Rhododendron* species (Stevens 1969, Yamazaki 1991, 1993b), *R. tsusiophyllum* should be recognized as a separate monotypic genus *Tsusiophyllum*; *T. tanakae* Maxim., which is sister to whole

Rhododendron (including *Ledum*) as identified by Kron and Judd (1990). Based solely on molecular data, the classification and evolutionary relationship between plants is not always completely reliable (Stace 2005), especially in the genera like *Rhododendron* where polyploid species are a common phenomenon (Janaki Ammal et al. 1950). Hörandl (2006) also suggested that clades retrieved by phylogenetic analyses should not be used solely as a basis for classification, but should be regarded primarily as information for a better understanding of relationships. Palynological characters are also found useful in rejecting or supporting molecular phylogenies in the family Rubiaceae (Dessein et al. 2005). So, detailed phylogenetic analyses, using morphological, palynological and molecular data with larger number of specimen, are necessary to clarify the generic composition of the tribe Rhodoreae.

The genus *Rhododendron* is stenopolynous in having 3-colporate and medium pollen tetrads with viscin threads. A continuous and serial variation was revealed in all quantitative palynological characters within the genus (Table 3-3-2). The apocolpial exine sculpture can be divided into two distinct groups; i) pollen surface is uneven and rugged to somewhat flat, apocolpial exine sculpture of Type FG (Figs. 3-17 D – L, N – O, 3-18 A – O, 3-19 A – B), and ii) pollen surface flat or rugged, apocolpial exine sculpture of Type R (Figs. 3-18 F, 3-19 D – E). The latter type of exine sculpture characterized *Rhododendron* subsect. *Ledum*, and all other species have almost similar exine sculpture except *R. decorum* (Fig. 3-18 F). Thus, palynological characters show a little usefulness in the infrageneric classification of *Rhododendron* (Goetsch et al. 2005).

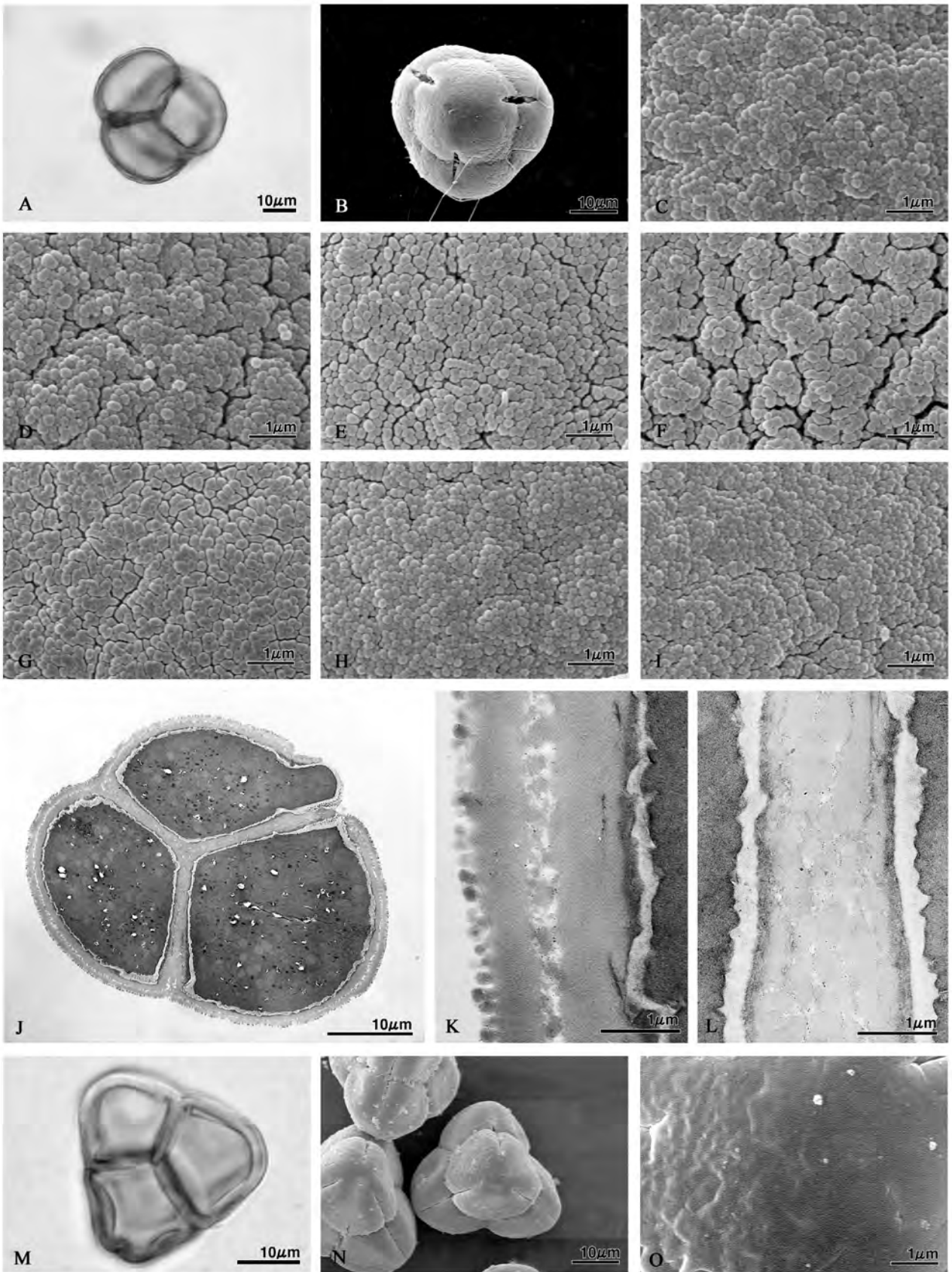

Fig. 3-9.

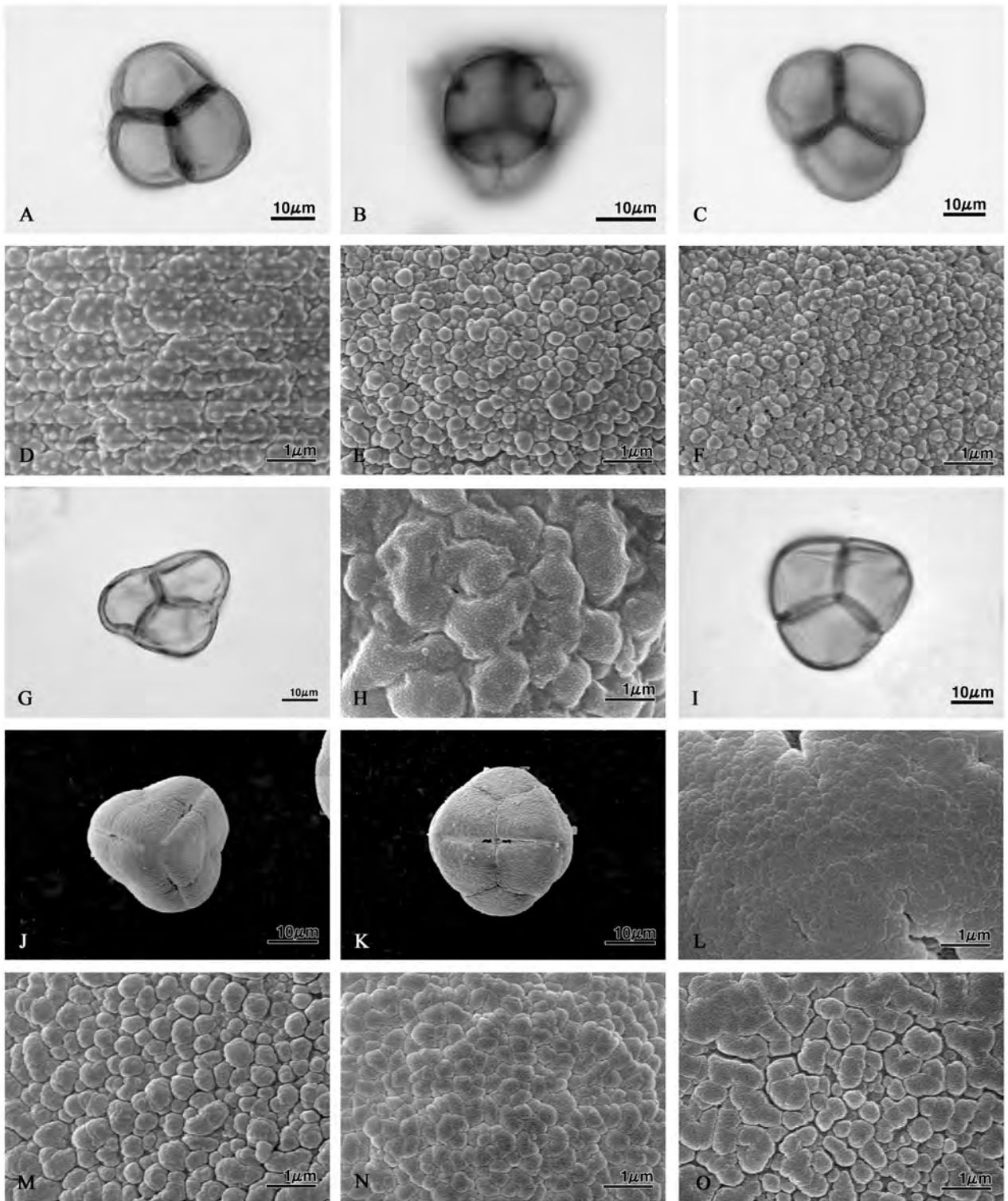

Fig. 3-10.

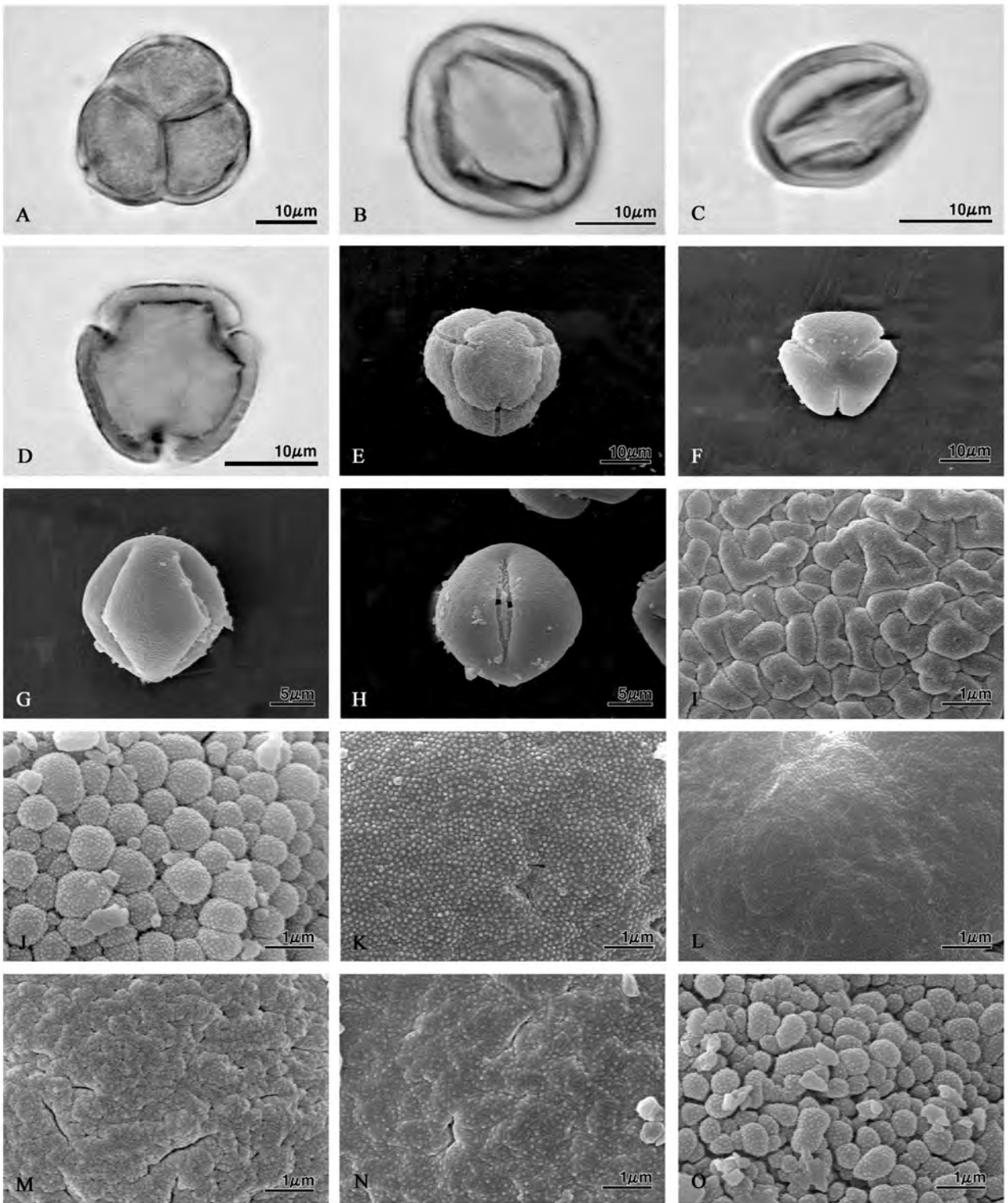

Fig. 3-11.

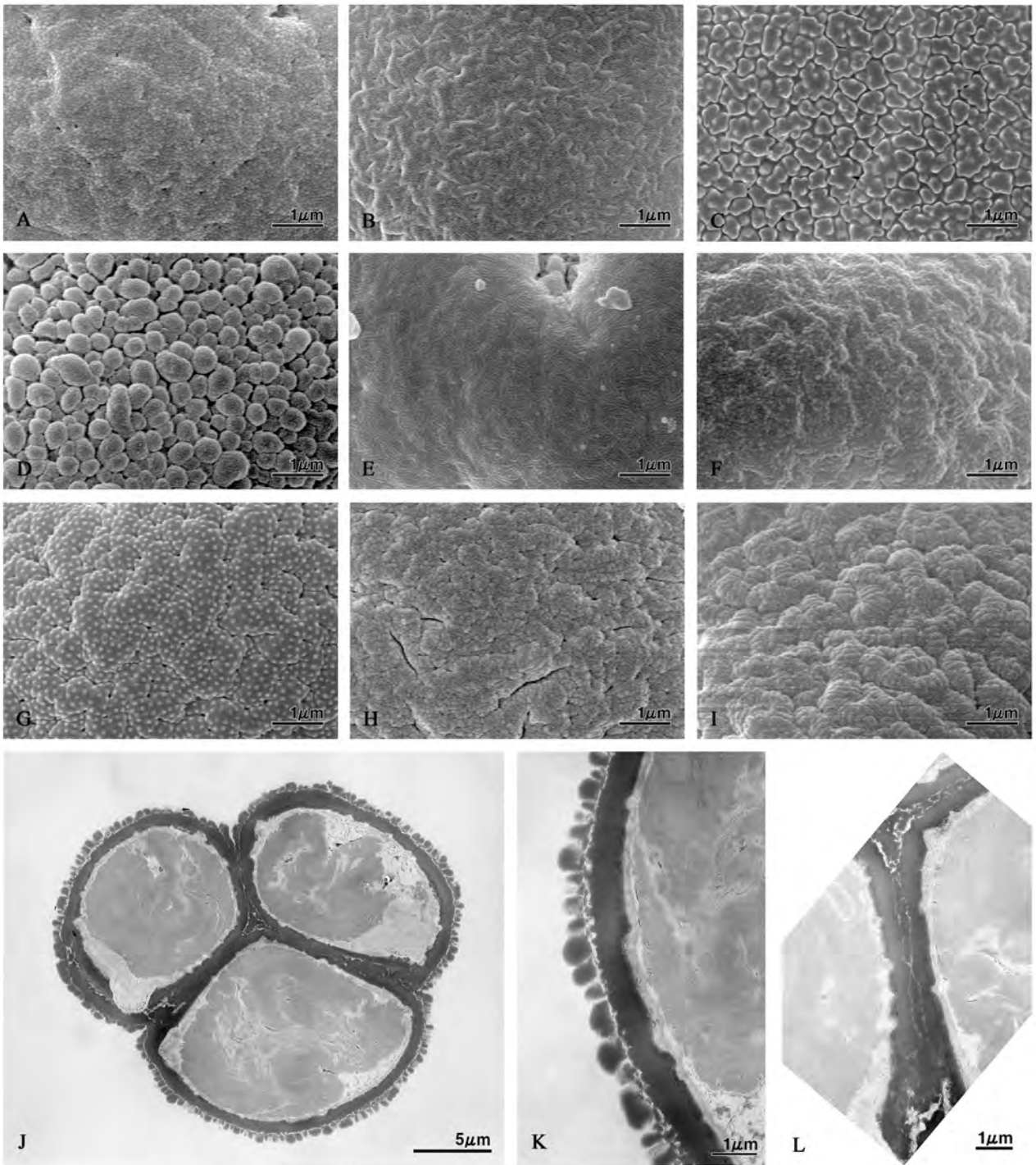

Fig. 3-12.

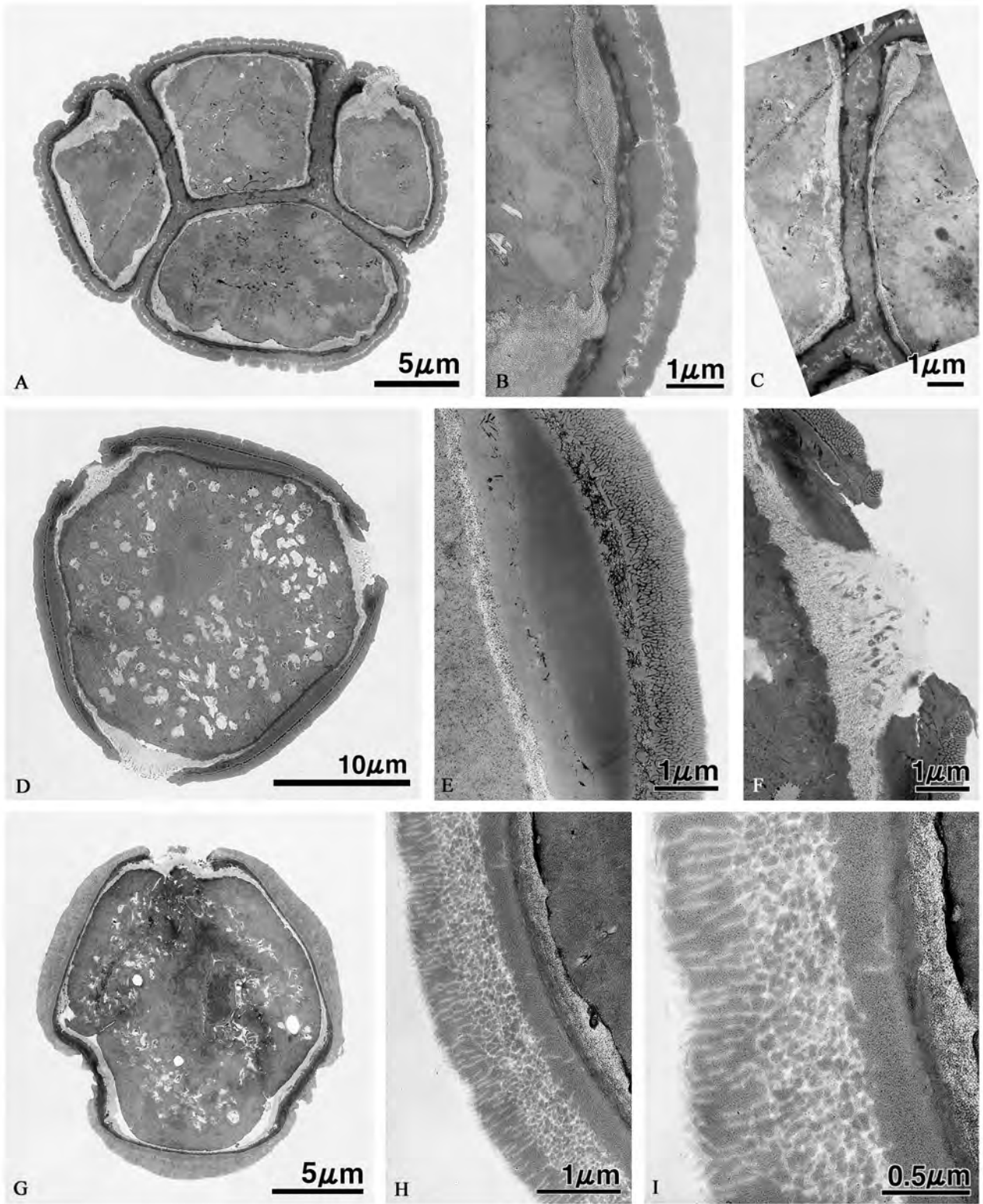

Fig. 3-13.

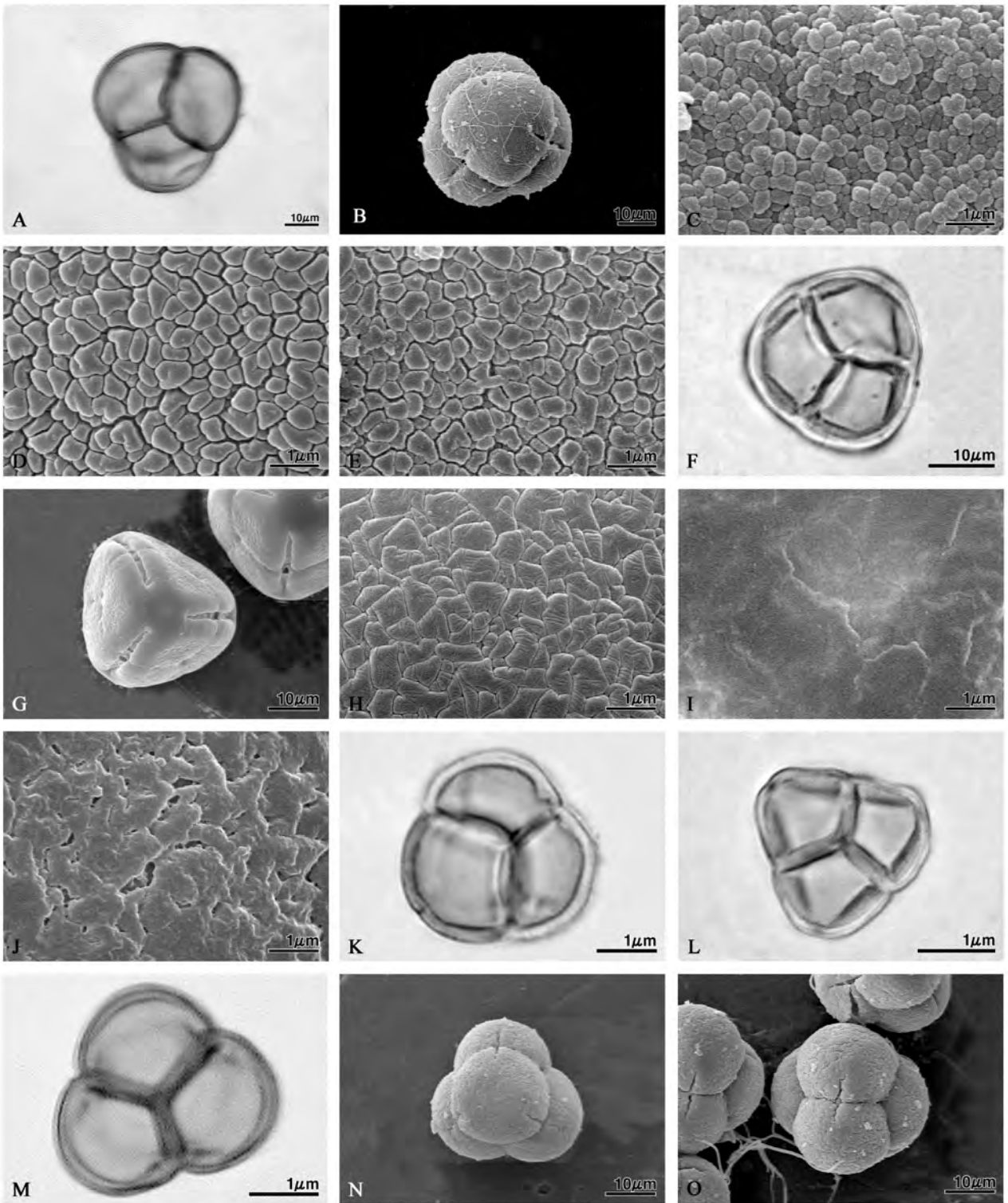

Fig. 3-14.

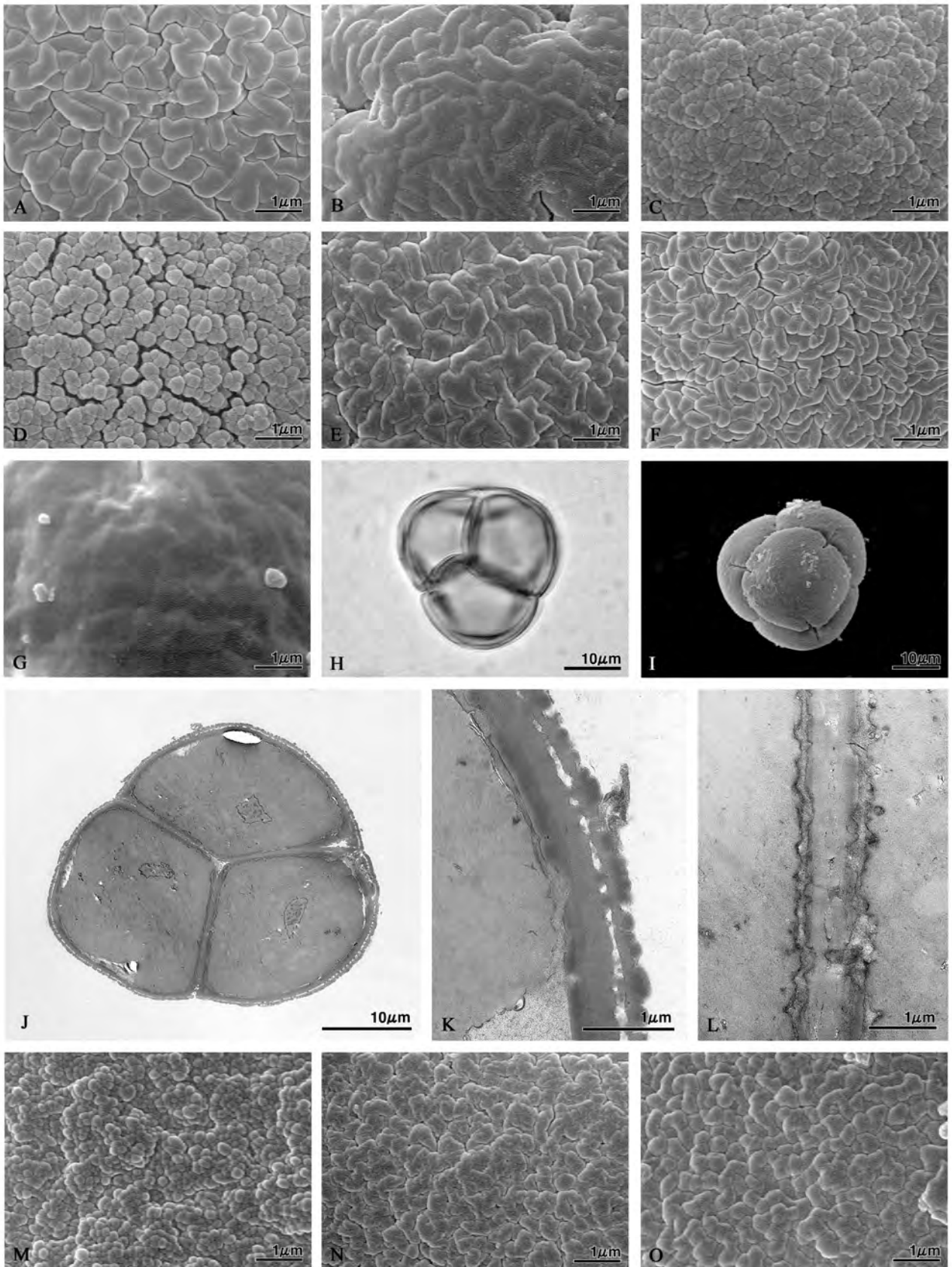

Fig. 3-15.

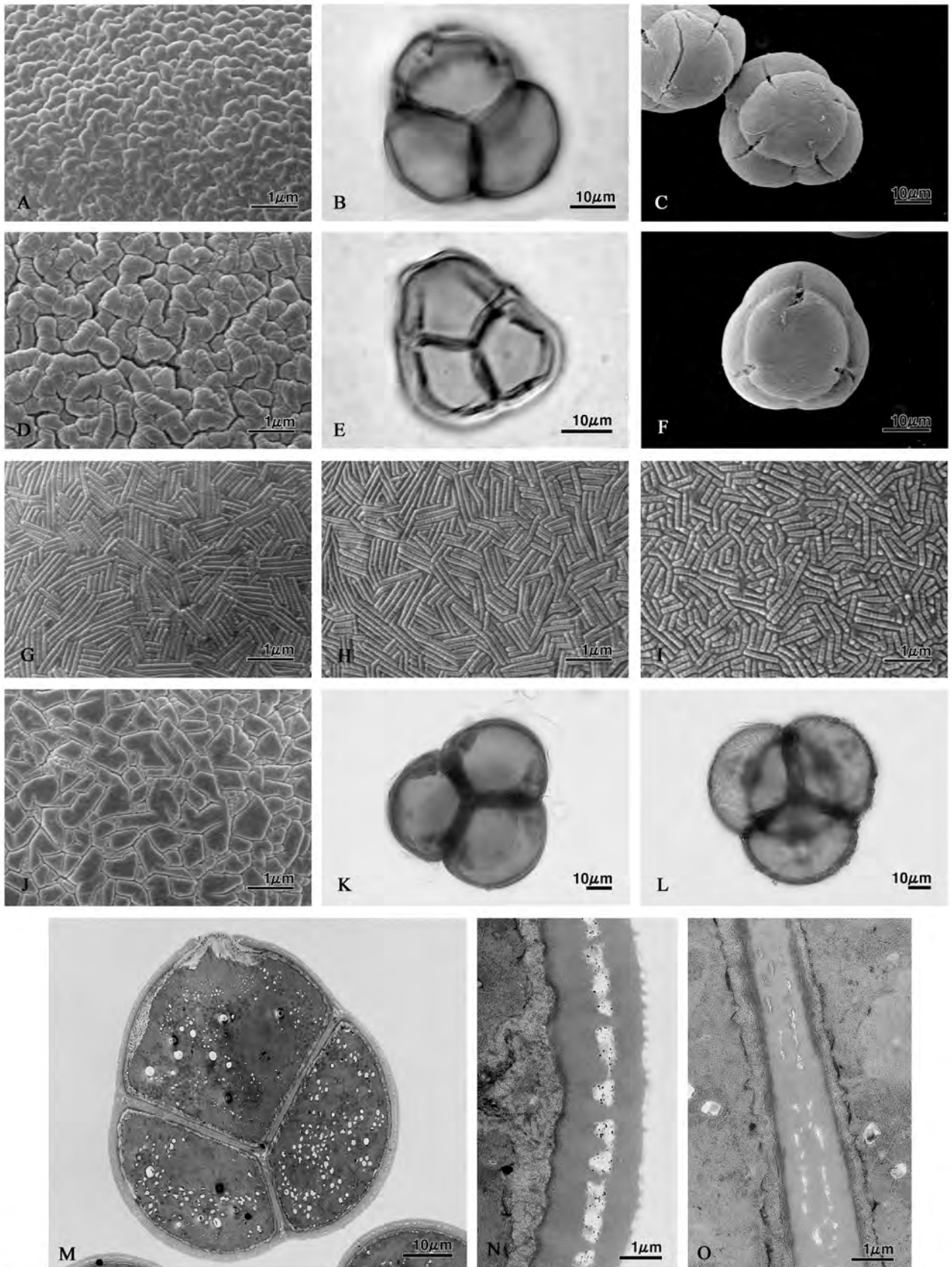

Fig. 3-16.

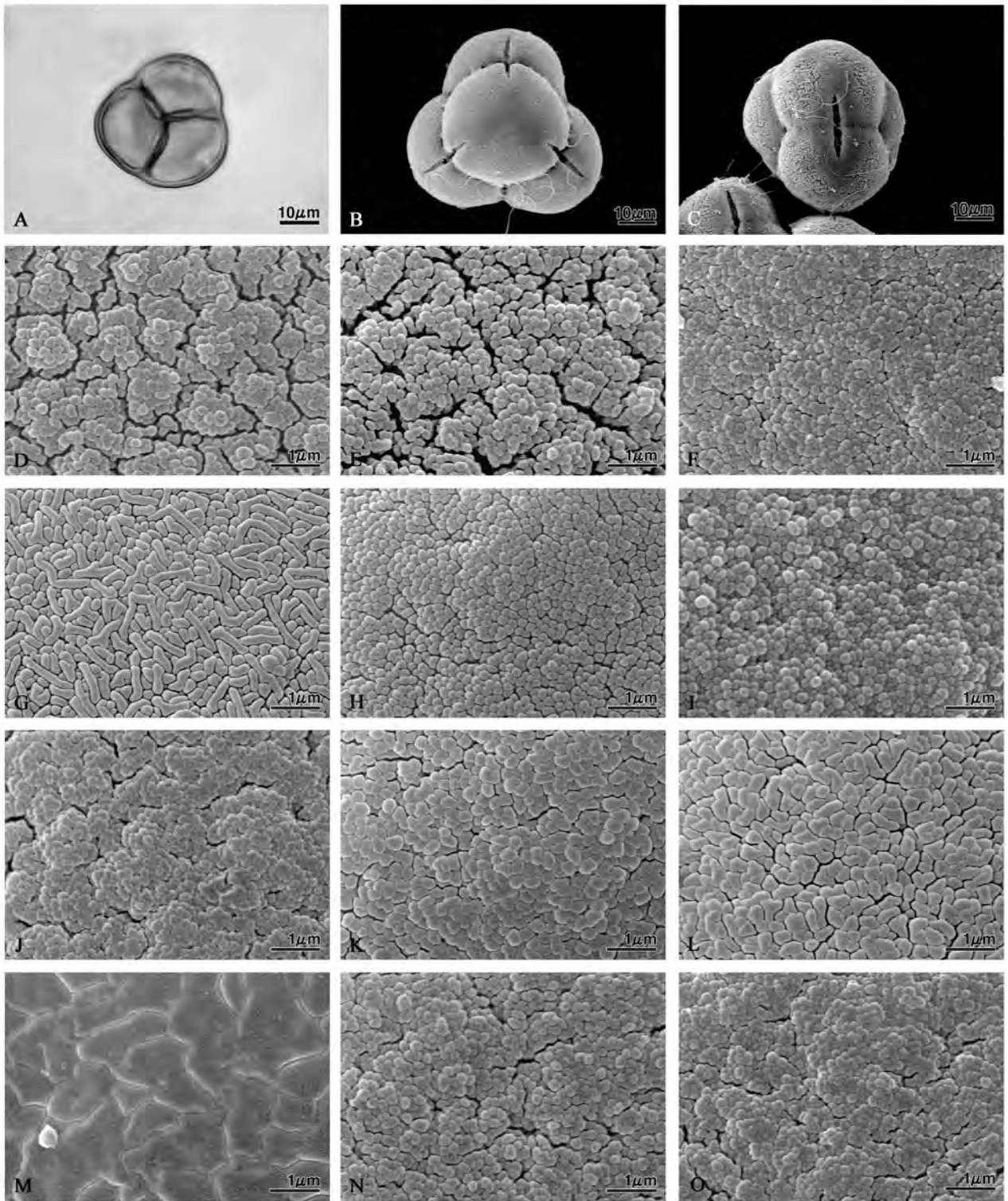

Fig. 3-17.

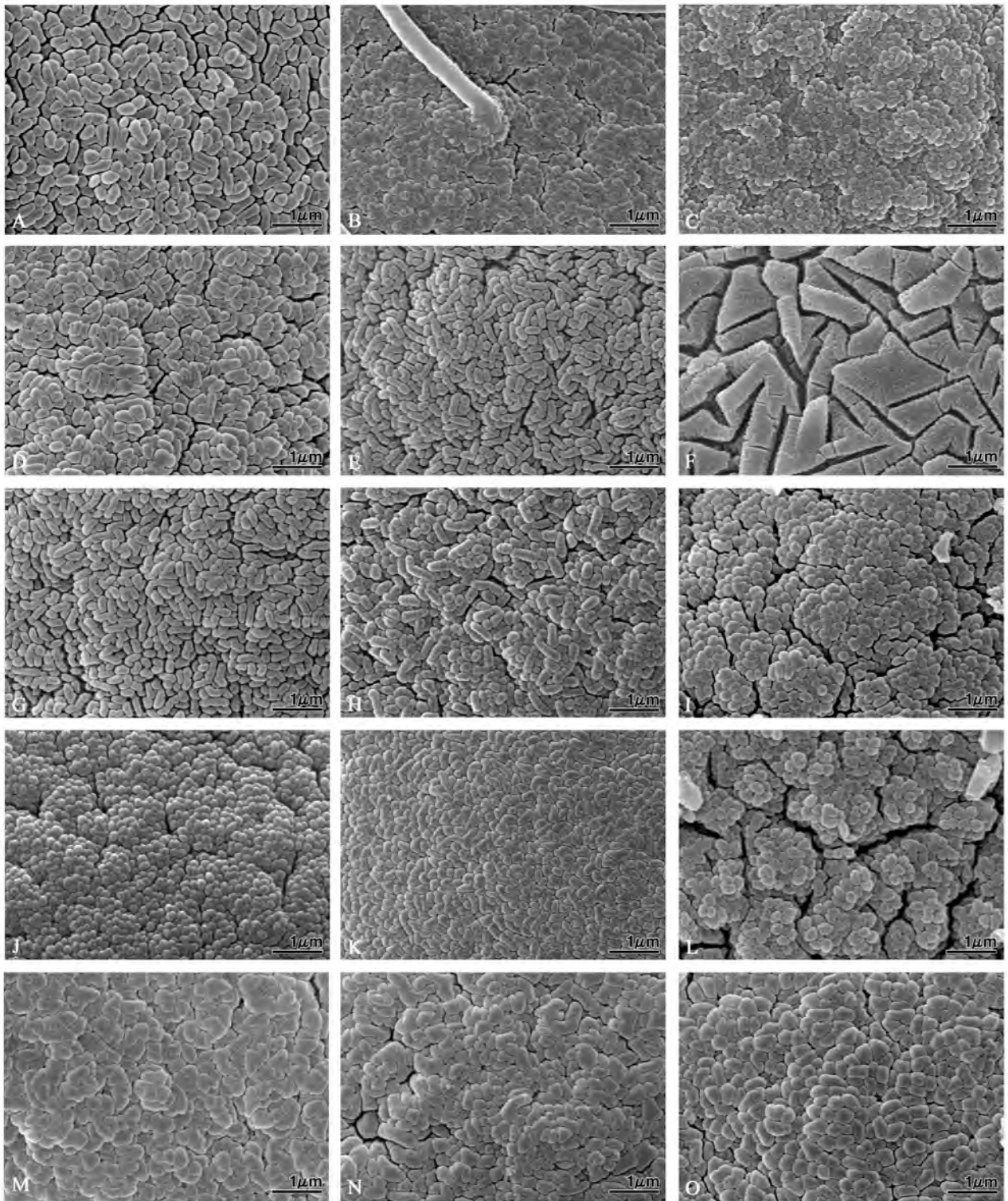

Fig. 3-18.

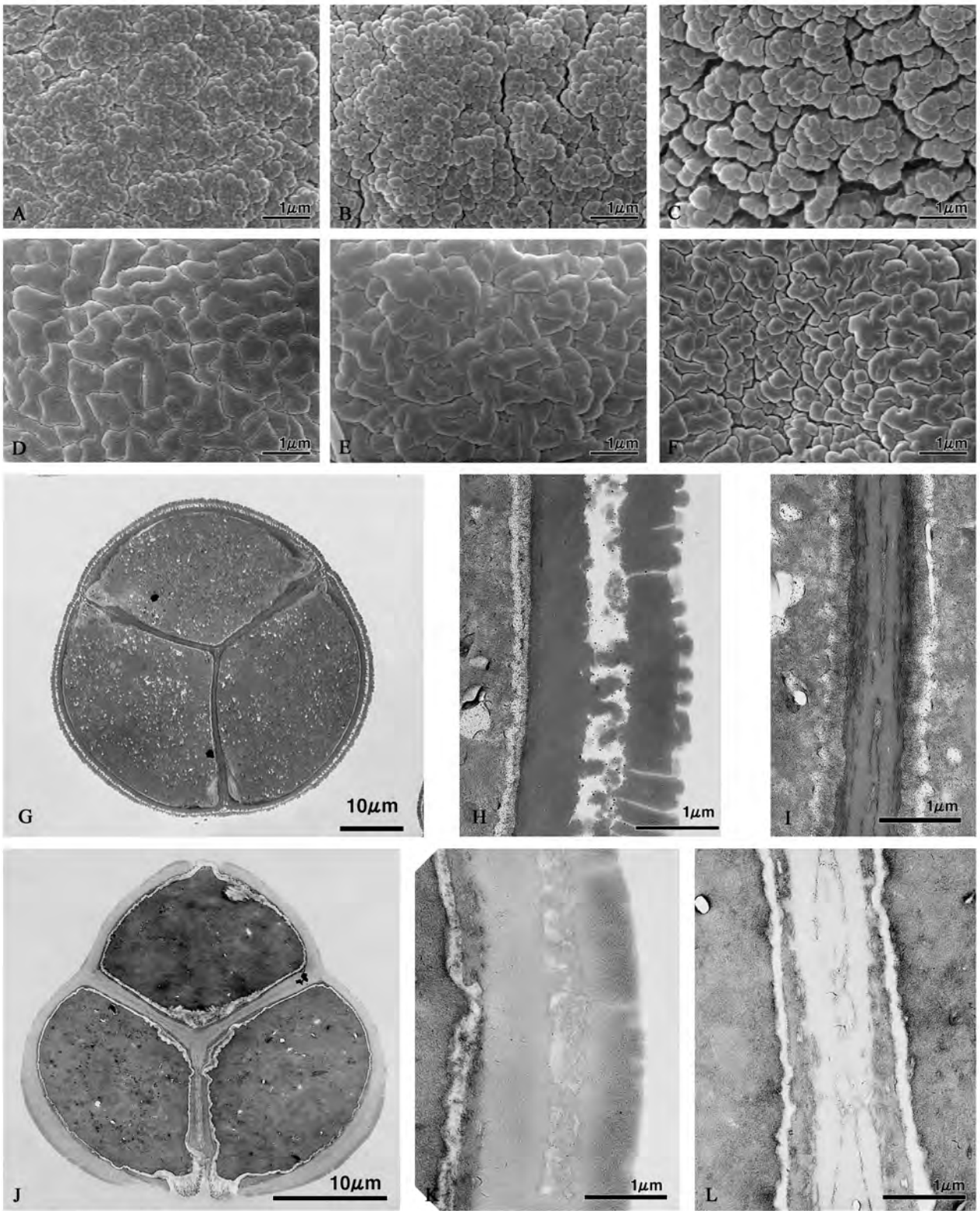

Fig. 3-19.

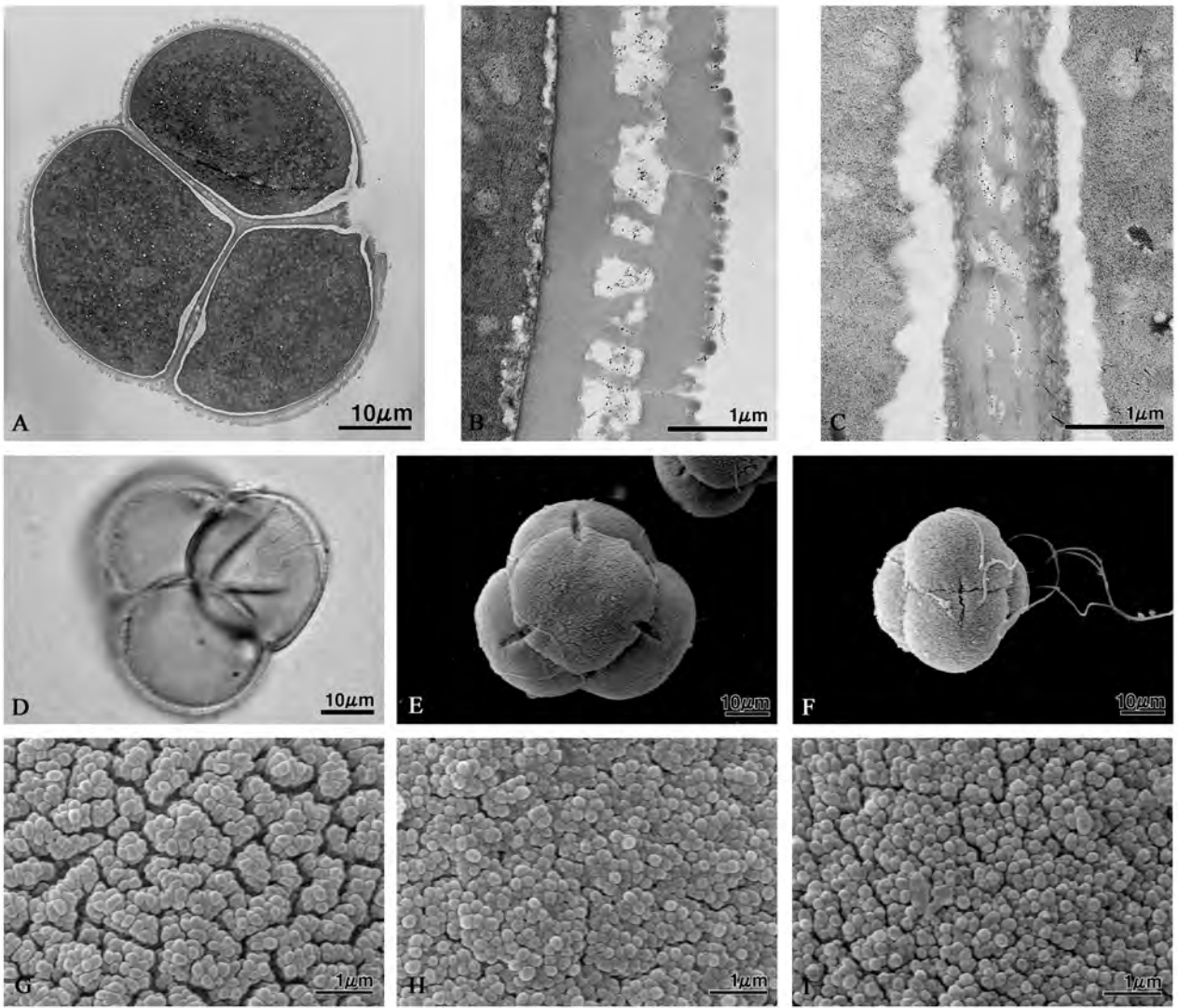

Fig. 3-20.

3-4 Subfamily Cassiopoideae

Introduction

Cassiope, the only genus of this subfamily Cassiopoideae, is sister group of subfamily Ericoideae (Kron et al. 2002a), and it comprises of about 12 species of circumboreal distribution, extending south into China, the Himalayan region, Japan, Russia, and Pacific North America (Kron and Luteyn 2005). This genus possesses some apomorphic characters e.g., *Calluna*-type pith, decussate leaves, indumentum of fasciculate branched and one flowered axillary inflorescence with 4 – 6 basal bracteoles (Stevens 1971, Kron et al. 2002a), and only member of the Ericaceae with bisporic embryo sac (Palser 1952). The systematic position of *Cassiope* was discussed variously. Cox (1948) first proposed a new tribe, the Cassiopeae, which included *Cassiope*, *Harrimanella*, *Epigaea*, *Enkianthus* and *Agauria* on the basis of similar wood anatomy. Later Stevens (1971) reassessed the generic limit of the tribe Cassiopeae with only *Cassiope* and *Harrimanella*, in the subfamily Vaccinioideae. However, the later cladistic studies showed that members of the tribe Cassiopeae (*sensu* Stevens 1971) form a sister clade with the Ericaceae-Rhododendroideae-Empetraceae clade, and hence the Cassiopeae is cladistically closer to Ericaceae and Callunaceae than to any part of the Vaccinioideae (e.g., Anderberg 1993).

All previous studies of pollen morphology of this genus were done by only LM (Sladkov 1954, Nair 1965, Moriya 1976, Comtois and Larouche 1981). The present research has been undertaken to study the pollen morphology of *Cassiope* by both LM and SEM, and to discuss its systematic significance in light of new classification of Ericaceae (Kron et al. 2002a).

Results

Pollen morphology of subfamily Cassiopoideae (monogeneric: *Cassiope*; 12 spp. / 3 spp. examined: *C. fastigiata*, *C. lycopodioides*, and *C. mertensiana*)

Pollen grains are united in compact tetrahedral tetrad; viscin thread absent; D 24.4 – 30.3 μm , P 12.8 – 15.4 μm , E 17.0 – 22.5 μm , D/d 1.34 – 1.49, P/E 0.68 – 0.78, oblate or suboblate. Three aperturate, apertures arranged according to “Fischer’s Law”, colpi(oid)ate, colpi distinct, but faint in *C. fastigiata*, 2f 17.2 – 22.4 μm , W 0.6 – 1.0 μm , 2f/W 22.4 – 30.83, 2f/D 0.64 – 0.76, wider at middle, acute towards end, tip often bifurcated in one specimen of *C. lycopodioides* (Calder 5850), costae present, indistinct in *C. fastigiata*, colpus margin distinct, endocracks absent or indistinct, but distinct in *C. lycopodioides*. Endoaperture is distinct, lalongate, 0.5 – 0.8 μm long, 6.9 – 9.4 μm wide. Exine tectate, apocolpial exine 0.9 – 1.7 μm thick, septum 0.7 – 1.1 μm thick, tectate, apocolpial exine sculpture varied from finely verrucate to finely rugulate or psilate.

In SEM, pollen surface is somewhat flat, apocolpial exine sculpture striate (Type S; Figs. 3-21 D – F), colpi narrow and elongate, apocolpial region small; colpus membrane smooth, but granulate in *C. mertensiana* (Table 3-4-1).

In TEM for *C. lycopodioides*, the apocolpial exine is composed of ectexine and endexine (Fig. 3-21 G – I). Sexine is ca. 0.4 μm thick, endexine thick, and a total exine is ca. 0.8 μm thick. The septum is ca. 0.5 – 0.8 μm thick. Intine is almost evenly thick around the pollen tetrad, showing lower electron density than the endexine at both apocolpial and septal exine.

Table 3-4-1. Pollen morphological data of subfamily Cassiopoideae based on light microscopic investigation.

Name of Taxa	Config-uration ¹	D ²	P ³	D/d ⁴	P/E ⁵	2f ⁶	2f/W ⁷	2f/D ⁸	Apo. Exine thickness ⁹	Septum thickness ¹⁰	Orname-ntation ¹¹	Colpus Memb.	Remarks ¹²
<i>Cassiopae fastigiata</i>	CT	I	I	IV	III	I	IV	V	III	II	S	Smooth	Colpi faint, Apo. region small
<i>C. lycopodioides</i> Takahashi et al. 7185	CT	I	I	IV	II	I	IV	VI	I	I	S	Smooth	Endocracks dist. Apo. region small
Calder 5850	CT	II	II	III	II	II	III	VI	II	I	S	Smooth	Ora indist., colpi often bifurc. Apo. region small
<i>C. mertensiana</i>	CT	I	I	III	II	I	III	V	III	I	S	Granulate	

D: tetrad diameter, P: polar length, d(E): equatorial diameter, 2f: ectoaperture length, W: ectoaperture width, Apo.: apocolpial, Memb.: membrane.

¹ CT Compact tetrahedral tetrad

² I: 20.1 – 30.0µm, II: 30.1 – 40.0 µm

³ I: – 15.0µm, II: 15.1 – 20.0µm

⁴ III: 1.30 – 1.39, IV: 1.40 – 1.49

⁵ I: – 0.65, II: 0.66 – 0.75, III: 0.76 – 0.85

⁶ I: 10.1 – 20.0µm, II: 20.1 – 30.0µm

⁷ III: 20.1 – 30.0, IV: 30.1 – 40.0

⁸ V: 0.61 – 0.70, VI: 0.71 – 0.80

⁹ I: – 1.0, II: 1.1 – 1.5 µm, III: 1.6 – 2.0 µm

¹⁰ I: – 1.0 µm, II: 1.1 – 1.5 µm

¹¹ Exine ornamentation type by SEM corresponding to Fig. 3.

¹² Apo. apocolpial, dist.: distinct, indist.: indistinct, bifurc.: bifurcated

Table 3-4-2. Variation in palynological characters of subfamily Cassiopoideae showing mean value in μm and standard deviation.

Name of Species	D	P	d	D/d	P/E	Ectoaperture			2f/D	Endoaperture		Apo. exine thickness	Septum thickness
						Length (2f)	Width (W)	2f/W		Length	Width		
<i>Cassiope fastigiata</i>	28.4±0.9 (26.5-29.9)	14.8±0.7 (13.2-15.7)	19.0±0.5 (18.5-19.8)	1.49	0.78	18.1±1.3 (16.5-19.8)	0.6±0.1 (0.5-0.8)	30.17	0.64	0.7±0.1 (0.5-0.8)	8.3±2.4 (4.1-11.6)	1.7±0.1 (1.5-1.8)	1.1±0.3 (0.7-1.7)
<i>C. lycopodiodes</i> Takahashi et al. 7185	24.4±0.7 (23.1-25.4)	12.8±0.7 (11.9-13.9)	17.0±1.0 (16.2-19.5)	1.44	0.75	18.5±1.3 (16.5-19.8)	0.6±0.2 (0.5-1.2)	30.83	0.76	0.6±0.3 (0.3-1.5)	6.9±1.5 (5.0-9.9)	0.9±0.4 (0.5-1.7)	0.7±0.2 (0.3-1.2)
Calder 5850	30.3±1.5 (28.1-32.7)	15.4±0.5 (14.9-16.2)	22.5±0.9 (21.1-23.9)	1.35	0.68	22.4±3.0 (18.2-26.4)	1.0±0.4 (0.5-1.7)	22.4	0.74	0.8±0.5 (0.3-1.7)	8.8±1.7 (6.6-11.6)	1.5±0.2 (1.2-1.7)	0.9±0.3 (0.5-1.3)
<i>C. mertensiana</i>	26.6±1.2 (25.1-28.2)	13.7±0.5 (13.2-18.9)	19.9±1.0 (18.2-21.5)	1.34	0.69	17.2±1.3 (15.7-19.8)	0.7±0.3 (0.5-1.2)	24.57	0.65	0.5±0.1 (0.3-0.7)	9.4±2.6 (6.6-13.2)	1.6±0.2 (1.2-1.8)	0.9±0.3 (0.5-1.3)

D: tetrad diameter, P: polar length, d(E): equatorial diameter, Apo.: apocolpium, minimum–maximum value in μm in parenthesis.

Discussion

All taxa of *Cassiope* examined in this study have minute and 3-colpor(oid)ate grains united in compact tetrahedral tetrads having similar exine sculpture of Type S, which suggest that the genus *Cassiope* is as a whole a close entity. Members of *Cassiope* showed some distinct palynological characteristics; e.g., consistently minute pollen grains, very exceptional apocolpial exine sculpture (Type S; Figs. 3-21 D – F) among the members of Ericaceae, strongly support its monophyly, and present placement in monogeneric subfamily Cassiopoideae. The exceptional nature of the exine sculpture of *Cassiope* is also observed with TEM (Fig. 3-21 G – H). Another characteristics palynological feature of *Cassiope* is the ratio ectoaperture length and tetrad diameter ($2f/D$) relatively larger (Class V or VI) compared to other Ericaceous taxa. The larger $2f/D$ results the smaller/narrower apocolpial region (Table 3-4-1). It is also noteworthy that the axillary inflorescence of *Cassiope* is very uncommon in Ericoideae + Cassiopoideae clade, occurring more commonly in the subfamily Vaccinioideae (Kron et al. 2002a).

Although the *Cassiope* species studied showed the characteristic similarity in some palynological features, some infra- and inter-specific variations have been observed (Tables 3-4-1 – 3-4-2). The Old World taxa possessed relatively smaller pollen tetrads (24.4 – 28.4 μm) and narrower ectoaperture (0.6 μm), but relatively larger D/d , P/E and $2f/W$ (1.44 – 1.49, 0.75 – 0.78 and 30.17 – 30.83, respectively) compared to those of New World taxa (Table 3-4-2). It was very interesting that the two specimens of *C. lycopodioides* showed variation in the all quantitative palynological characters except $2f/D$ and septum thickness (Table 3-4-2). These differences may be due to their geographic distribution. Therefore, further study, with larger number of specimen, is necessary to clarify and/or confirm whether these differences due to their geographic position or just random variation.

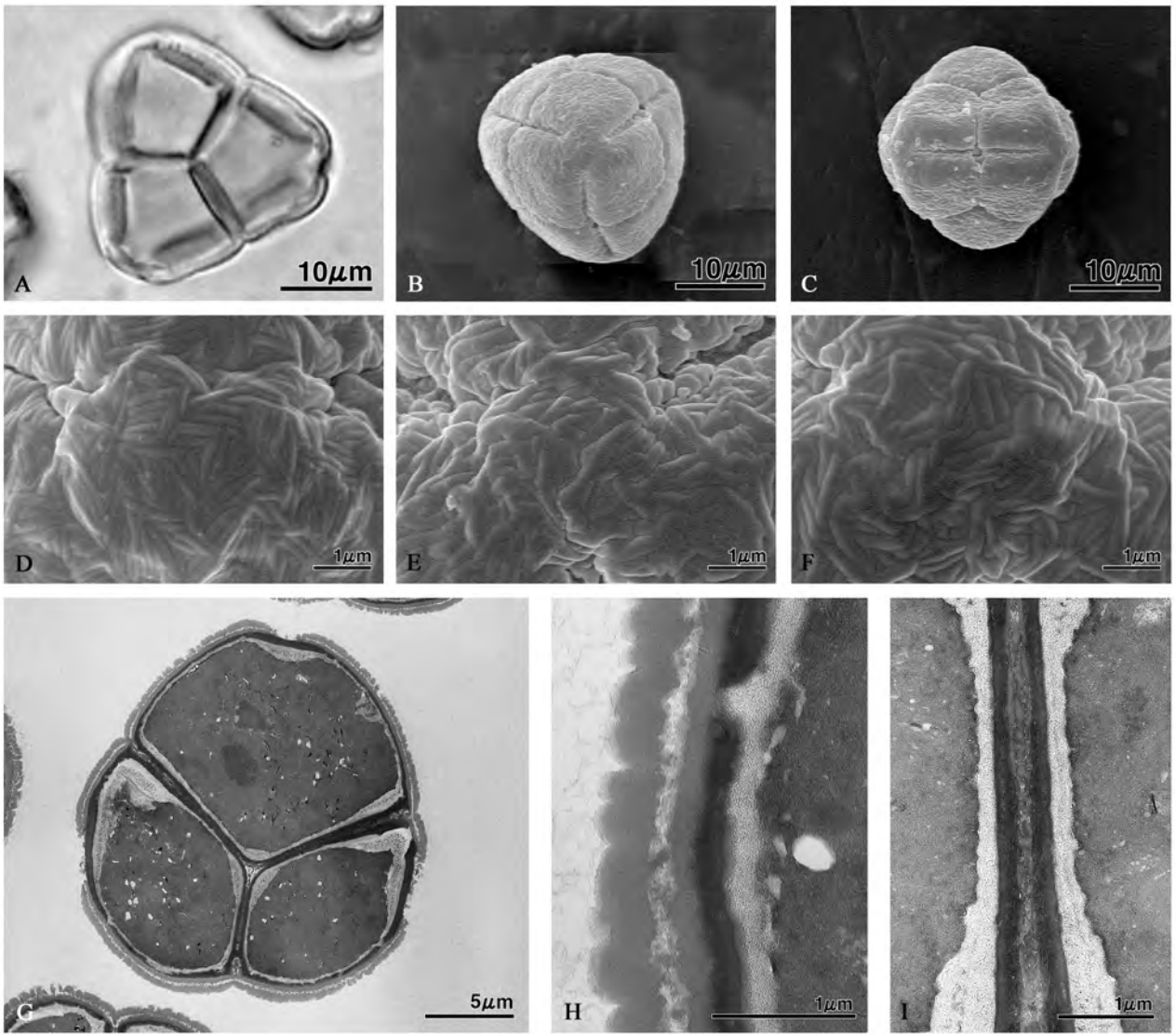

Fig. 3-21.

3-5 Subfamily **Harrimanelloideae**

Introduction

The only genus *Harrimanella* of the subfamily Harrimanelloideae comprises two species, with interruptly circumboreal distribution; from North America, Greenland, N Scandinavia to western Russia, Kamchatka, and northern Japan (Kron and Luteyn 2005), and is sister group of Styphelioideae + Vaccinioideae clade (Kron et al. 2002a). Previously, *Harrimanella* along with *Cassiope* of subfamily Cassiopoideae was included in the same tribe Cassiopeae of subfamily Vaccinioideae *sensu* Stevens (1971), though Stevens (1971) reported much dissimilarity between these two genera. The recent classification of Ericaceae (Kron et al. 2002a) identified them as the member of two monogeneric subfamilies Harrimanelloideae and Cassiopoideae. Subfamily Harrimanelloideae possesses some apomorphic characters e.g., indumentum of only unicellular hairs, inflorescence terminal, flowers solitary, bract and bracteoles lacking, and short and stout stigma (Kron et al. 2002a).

Pollen morphological studies of the Harrimanelloideae were scanty and based only on light microscopic (LM) observations (e.g., Yang 1952, Sladkov 1953, 1954, Ikuse 1956, 2001, Stevens 1971). Therefore, the present study aims to provide a detailed description on pollen morphology of this subfamily by LM, SEM and TEM, and the taxonomic significance of pollen morphology is discussed in light of recent classification of Ericaceae (Kron et al. 2002a).

Results

Pollen morphology of the subfamily Harrimanelloideae [monogeneric: *Harrimanella*; 2 spp. / 1 sp. examined: *H. stelleriana*]

Pollen grains are commonly united in tetrahedral tetrad, grains often shrink; viscin threads absent. In range of average value, D 28.3 μm , P 14.6 μm , E 20.1 μm , D/d 1.40, P/E 0.73, oblate. Three aperturate, apertures arranged according to “Fischer’s Law”, colporate, colpi slit-like, 2f 22.5 μm long, W 0.4 μm , 2f/W 55.5, 2f/D 0.78, colpus margin distinct, costae present. Endoaperture is distinct, lalongate, 0.6 μm long and 9.5 μm wide. Exine is tectate, apocolpial exine 1.9 μm thick, septum 0.7 μm thick, apocolpial region small, exine sculpture varies from psilate or finely rugulate.

In SEM, pollen surface is somewhat flat, apocolpial exine sculpture coarsely rugulate to psilate, but intermediate types (R/P; Fig. 3-22 D, R/RS; Fig. 3-22 E). Exine sculpture along the colpi is similar to that appearing at distal pole, but at the mesocolpial exine having a tendency to decrease in lateral extension of the rugulae with more distinct units. Colpus membrane is granulate.

In TEM, the apocolpial exine is composed of ektexine; tectum, columellae (rod-like elements distinct) and foot layer, and endexine with higher electron density (Fig. 3-22 G). Sexine is ca. 0.5 μm thick and a total exine is ca. 1.1 μm thick (Fig. 3-22 H). In the proximal exine (septum), tectum is lacking and two foot layers of adjacent grains are connected by columellae (Fig. 3-22 I); septum is ca. 0.6 – 1.1 μm thick, faintly perforated, and thicker towards peripheral regions. Intine is almost evenly thick around the pollen tetrad, showing lower electron density than the endexine at both apocolpial and septal exine.

Discussion

The pollen of *Harrimanella* is commonly minute in size. The measurements of present study agree with the results of previous studies (e.g., Ikuse 1956). Although the quantitative palynological characters are very similar in both the genera *Cassiope* and *Harrimanella*, the tetrad shape, apocolpial exine sculpture, endexine thickness and sexine-nexine ratio differed significantly between these two genera; compact, striate, thick (Type S; Fig. 3-21) and 1.0 (Table 4-3; Fig. 4-10) vs. normal, coarsely rugulate to psilate, thin (R/P or R/RS; Fig. 3-22) and 1.2 (Table 4-3; Fig. 4-10), respectively. The distinct difference in exine sculpture between these two genera may support their placement in two different monotypic subfamily Cassiopoideae and Harrimanelloideae (Kron et al. 2002a), and the rugulae with secondary sculpture; faintly striate in *Harrimanella* (Fig. 3-22 E) also support their close relationship with the members of subgenus Vaccinioideae. The secondary sculpture might be a synapomorphic palynological character state for Harrimanelloideae + Styphelioideae + Vaccinioideae clade of Kron et al. (2002a). Presently, I am not in a position to confirm this supposition or make any specific comment, as I do not see many scanning electron micrographs from the subfamily Styphelioideae.

Table 3-5-1. Pollen morphological data of subfamily Harrimanelloideae based on light microscopic investigation.

Name of Taxa	Config- ration ¹	D ²	P ³	D/d ⁴	P/E ⁵	2f ⁶	2f/W ⁷	2f/D ⁸	Apo. Exine thickness ⁹	Septum Thickness ¹⁰	Orname- ntation ¹¹	Colpus Memb.	Remark
<i>Harrimanella stelleriana</i>	T	I	I	IV	II	II	VI	VI	III	I	R/P or R/RS	Granulate	Grains often shrink, Apocolpial region small

D: tetrad diameter, P: polar length, d(E): equatorial diameter, 2f: ectoaperture length, W: ectoaperture width, Apo.: apocolpial, Mem.: membrane.

¹ T: Tetrahedral tetrad

² I: 20.1 – 30.0µm

³ I: – 15.0µm,

⁴ I: – 1.19, II: 1.20 -1.29 III: 1.30 – 1.39, IV: 1.40 – 1.49

⁵ I: - 0.65, II: 0.66 – 0.75

⁶ I: 10.1 – 20.0, II: 20.1 – 30.3

⁷ I: – 10.0, II: 10.1 – 20.0, III: 20.1 – 30.0, IV: 30.1 – 40.0, V: 40.1 – 50.0, VI 50.1 – 60.0

⁸ I: – 0.30, II: 0.31 – 0.40, III: 0.41 – 0.50, IV: 0.51 – 0.60, V: 0.61 – 0.70, VI: 0.71 – 0.80

⁹ I: 1.1 – 1.5µm, II: 1.6 – 2.0µm, III: 2.1 – 2.5µm

¹⁰ I: – 1.0µm

¹¹ Exine ornamentation type by SEM corresponding to Fig. 3.

Table 3-5-2. Variation in palynological character of subfamily Harrimanelloideae showing mean value in μm and standard deviation.

Name of Species	D	P	d	D/d	P/E	Ectoaperture			2f/D	Endoaperture		Apo. exine thickness	Septum thickness
						Length (2f)	Width (W)	2f/W		Length	Width		
<i>Harrimanello stelleriana</i>	28.3±2.1 (24.4-32.7)	14.6±1.4 (12.7-16.5)	20.1±1.4 (16.7-21.5)	1.40	0.73	22.2±1.2 (19.8-23.1)	0.4±0.1 (0.3-0.5)	55.5	0.78	0.6±0.2 (0.3-1.0)	9.5±1.7 (6.6-11.6)	1.9±0.2 (1.5-2.2)	0.7±0.2 (0.5-1.2)

D: tetrad diameter, P: polar length, d(E): equatorial diameter, Apo.: apocolpium, minimum–maximum value in μm in parenthesis.

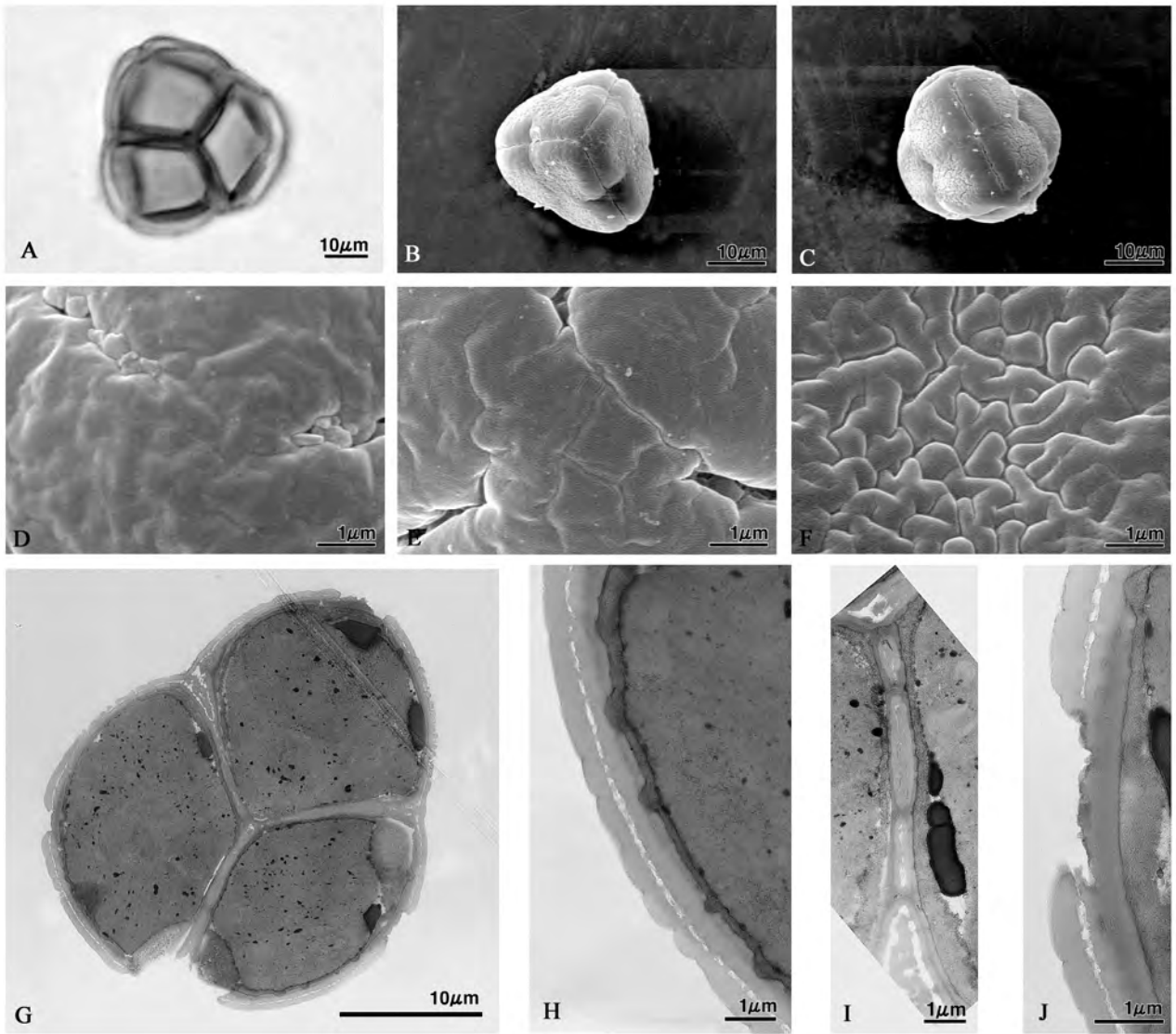

Fig. 3-22.

3-6 Subfamily Vaccinioideae

Introduction

The Vaccinioideae is a very heterogeneous subfamily, with the highest number of genera, and consists of five tribes, viz. Andromedeae *s.s.*, Gaultherieae, Lyonieae, Oxydendreae and Vaccinieae, comprising 45 genera and about 1600 species (Kron and Luteyn 2005). The genera included in this subfamily were previously the members of tribes Andromedeae and Vaccinieae of subfamily Vaccinioideae *sensu* Stevens (1971). Most representatives are evergreen shrubs, many occurring as epiphytes and occasionally as lianas, and comprise a large group of woody plants that are widely distributed except in most of Africa, Australia, and Antarctica (Kron et al. 2002b). Vaccinieae is the largest tribe (ca. 32 genera and 1270 species) among the tribes of subfamily Vaccinioideae as well as the family Ericaceae (Kron and Luteyn 2005). The vast majority of the taxa of Vaccinieae (ca. 30 genera and 900 species) are concentrated in the New World Tropics and the remaining taxa in the Old World Tropics (Luteyn 2002a) and some genera of this tribe do not seem to be monophyletic according to molecular data (Kron et al. 2002a). *Vaccinium* L. is the largest (ca. 500 species) genus of this subfamily followed by *Gaultheria* (130) and *Cavendishia* (130). Two homoplasious characters diagnose Vaccinioideae: the presence of disintegration tissue on the back of the anthers and a base chromosome number of 12, but in the combined morphological and molecular analyses, Vaccinioideae are strongly supported (Kron et al. 2002a).

Early comprehensive treatments of Ericaceae prepared by Hooker (1876) and Drude (1889) are different in their placement of the Vaccinioideae. Hooker (1876) separated the taxa of the tribe Vaccinieae from Ericaceae and recognized as a separate family Vacciniaceae, emphasizing the presence of an inferior ovary in Vacciniaceae. However, the most subsequent workers described it as a tribe within the subfamily Vaccinioideae of the

Ericaceae (Drude 1889, Watson et al. 1967, Stevens 1971). In the classification of Stevens (1971), the circumscription of Vaccinioideae was largely enlarged by the inclusion of Arbutae, Andromedae, Cassiopeae and Enkiantheae. In the most recent classification of the Ericaceae (Kron et al. 2002a), Vaccinieae are sister to Andromedae s.s. and Gaultherieae, which form together with Lyonieae and Oxydendreae the rest of the subfamily Vaccinioideae. This subfamily contains many species that are sources of economically important plants e.g., blueberries and cranberries, wintergreen oil etc. Many species are medicinal or used as herbal remedies. There are also many ornamentals in this subfamily: wintergreen, *Gaultheria*, sourwood, *Oxydendrum*, fetterfush, *Leucothoë*, bog-rosemary, *Andromeda*, and staggerbush, *Lyonia* (Luteyn 2002b).

There are many literatures published on the pollen morphology of this subfamily (e.g., Ricardi and Marticorena 1961, Kocon et al. 1981, Premathilake et al. 1999) and has been mentioned fragmentally in the regional pollen floras. However, most of these works are based on mainly LM observations and the number of species reported in these works is still limited. Moreover, some of the common taxa are described in many times. Therefore, the present investigation was carried out with LM and SEM for all the specimens, and TEM to a limited extent, and the taxonomic significance of the pollen morphology is discussed in light of recent classification of Ericaceae (Kron et al. 2002a). The monophyly of some genera is also assessed in light of palynological features.

Results

Pollen morphology of the subfamily Vaccinioideae

Pollen grains are commonly united in tetrahedral tetrad, normal, lobed or compact, rarely in other configurations; viscin threads absent. In range of average value, D 24.8 – 72.4

μm , P 12.5 – 39.3 μm , E 19.0 – 50.8 μm , D/d 1.19 – 1.54, P/E 0.61 – 0.83, oblate, rarely suboblate. Three aperturate, apertures arranged according to “Fischer’s Law”, rarely 4-aperturate, colpor(oid)ate, colpi distinct, 2f 12.5 – 42.4 μm , W 0.4 – 5.1 μm , 2f/W 4.73 – 70.25, 2f/D 0.34 – 0.76, significantly wider at middle, generally acute, sometimes tapering towards ends, colpus margin distinct. Costae usually present, but indistinct in some species. Endoaperture is distinct, but indistinct in some species, lalongate, 0.4 – 5.9 μm long, 5.0 – 17.2 μm wide. Exine tectate, apocolpial exine 1.1 – 3.3 μm thick, septum 0.5 – 2.6 μm thick, rarely perforated, apocolpial exine sculpture varies from finely verrucate to finely rugulate or verrucate to rugulate in most of the species, but coarsely verrucate or coarsely rugulate or psilate and/or finely to faintly sculptured or sometimes obscure in some species.

In SEM, pollen surface is uneven rugged to somewhat flat, 1) primary apocolpial exine sculpture moderate to coarsely rugulate without any secondary sculpture (Type R; Figs. 3-23 D, K, 3-24 D, O, 3-25 A, D, F – G, I – J, L – N, 3-27 M – O, 3-28 B, M, 3-29 G, 3-30 A – B, 3-35 E – F, 3-40 G – H, O, 3-41 C); or 2) primary exine sculpture moderate to coarsely rugulate-psilate, the rugulae with minute (diam. < 0.2 μm) striate (Type RS; Figs. 3-23 E, 3-24 M, 3-25 B – C, H, 3-27 E, 3-31 K – M, O, 3-32 A – D, 3-33 F, 3-34 F – G, 3-35 O, 3-37 H, 3-39 L – O, 3-41 F, I, 4-42 I, L – O, 3-43 C, E – F, 3-44 F, J – K, O, 3-45 F, I – J); or 3) primary exine sculpture psilate, covered with secondary striate sculpture (Type PS; Figs. 3-24 G, 3-27 D, 3-29 L, 3-31 G, 3-43 J – L, 3-44 H – I); or 4) primary exine sculpture moderate to coarsely rugulate-psilate, the rugulae with moderate (diam. > 0.2 μm) granulate to short striate (Type RGS; Figs. 3-25 E, 3-35 D, I, 3-36 L) or striate with minute (diam. < 0.2 μm) granules (Type RSG; Figs. 3-41 A, 3-45 C); or 5) primary exine sculpture indistinct, secondary sculpture fine short striate with verrucae (Type FS; Fig. 3-31 D); or 6) primary exine sculpture moderate to coarsely rugulate-psilate, the rugulae with minute (diam. < 0.2 μm) granules (Type RG; Figs. 3-35 C, G – H, L, 3-36 A, 3-38 C, 3-41 B, H); or 7) primary exine sculpture moderate psilate (Type P; 3-43 O); or 8) primary exine sculpture indistinct,

secondary sculpture unit fine (diam. < 0.5 μm) gemmate-pilate (Type FG; Fig. 3-44 L); or 9) intermediate types. Exine sculpture along the colpi is similar to that appearing at distal pole, but at the mesocolpial exine having a tendency to decrease in lateral extension of the rugulae with more distinct units. Colpus membrane is commonly granular, sometimes granuloid, or more or less smooth.

In TEM, the apocolpial exine is composed of ectexine; tectum, columellae (rod-like elements distinct) and foot layer, and endexine with higher electron density (e.g., Fig. 3-23). Sexine is ca. 0.4 – 1.0 μm thick and a total exine is ca. 0.9 – 1.8 μm thick. In the proximal exine (septum), tectum is lacking and two foot layers of adjacent grains are connected by columellae; septum is ca. 0.3 – 1.5 μm thick, sometimes perforated, and thicker towards peripheral regions. Intine is almost evenly thick around the pollen tetrad, showing lower electron density than the endexine at both apocolpial and septal exine.

Pollen morphology of tribe Andromedeae [2 genera / 2 genera examined: *Andromeda* and *Zenobia*]

Andromeda [1 sp. / 2 specimens examined: *A. polifolia*, *A. polifolia* var. *glaucophylla*]

Pollen grains are in compact tetrahedral tetrad; viscin thread absent; D 43.3 – 44.6 μm , P 21.9 – 23.8 μm , E 32.5 – 33.5 μm , D/d 1.30 – 1.37, P/E 0.66 – 0.73, oblate; 3-colporate, rarely 4-colporate in one specimen (Takahashi & Fujita 9753) of *A. polifolia*, 2f 21.3 – 27.3 μm , W 2.1 – 3.0 μm , 2f/W 7.33 – 10.5, 2f/D 0.48 – 0.62, significantly wider at middle, acute towards end, colpus margin distinct, costae present; endocracks absent or indistinct; endoaperture lalongate, 1.3 – 2.2 μm long, 7.8 – 10.6 μm wide; apocolpial exine 1.9 – 2.4 μm thick, septum 0.7 – 1.0 μm thick, sculptured and/or perforated; tectate, exine sculpture coarse rugulate.

In SEM, pollen surface is somewhat flat, primary apocolpial exine sculpture moderate to coarsely rugulate without any secondary sculpture (Type R; Fig. 3-23 D), or surface flat,

primary exine sculpture coarsely rugulate-psilate, the rugulae with minute (diam. < 0.2 μm) striate (Type RS; Fig. 2-23 E); colpus membrane granulate. The exine sculpture of *A. polifolia* var. *glaucophylla* could not be studied due to unavailability of grains on SEM stub, but it is very similar to that of *A. polifolia* by LM.

In TEM for *A. polifolia*, the apocolpial exine is composed of ectexine and endexine (Fig. 2-23 G). Sexine is ca. 0.9 μm thick, sexine and nexine almost equal in thickness and a total exine is ca. 1.8 μm thick (Fig. 2-23 H). The septum is ca. 0.7 – 1.3 μm thick, distinctly perforated (Fig. 2-23 I). Intine is almost evenly thick around the pollen tetrad (Fig. 2-23 G).

Zenobia [1 sp. / 1 sp. examined: *Z. pulverulenta*]

Pollen grains are in compact tetrahedral tetrad; viscin thread absent; D 35.5 μm , P 17.9 μm , E 27.4 μm , D/d 1.30, P/E 0.65, oblate; 3-colporate, 2f 23.3 μm , W 2.2 μm , 2f/W 10.59, 2f/D 0.66, significantly wider at middle, acute towards end, sometimes tip of colpi bifurcated, colpus margin distinct, costae present; endocracks absent or indistinct; endoaperture lalongate, 1.5 μm long, 7.7 μm wide; apocolpial exine 1.7 μm thick, septum 0.9 μm thick, perforated; tectate, exine sculpture from verrucate to rugulate.

In SEM, pollen surface is somewhat flat, primary apocolpial exine sculpture moderate to coarsely rugulate without any secondary sculpture (Type R; Fig. 2-23K); colpus membrane granulate.

Pollen morphology of tribe Gaultherieae [6 genera / 5 genera examined: *Chamaedaphne*, *Diplycosia*, *Gaultheria*, *Leucothoë* and *Tepuia*]

Chamaedaphne [1 sp. / 1 sp. examined: *C. calyculata*]

Pollen grains are in compact tetrahedral tetrad; viscin thread absent; D 30.6 – 32.6 μm , P 15.9 – 16.6 μm , E 22.8 – 23.0 μm , D/d 1.33 – 1.43, P/E 0.69 – 0.73, oblate; 3-colporate, 2f 19.2 – 20.8 μm , W 0.5 – 1.4 μm , 2f/W 13.71 – 41.60, 2f/D 0.63 – 0.64, significantly wider at

middle, acute towards end, sometime tip of the colpi bifurcated, colpus margin distinct, costae present; endocracks present; endoaperture lalongate, 0.5 – 1.4 μm long, 7.2 μm wide; apocolpial exine 1.6 μm thick, septum 0.8 – 1.8 μm thick; tectate, exine sculpture from fine verrucate to fine rugulate.

In SEM, pollen surface is somewhat flat, primary apocolpial exine sculpture moderate to coarsely rugulate without any secondary sculpture (Type R; Fig. 2-24 D); colpus membrane granulate or granuloid.

Diplycosia [100 spp. / 1 sp. examined: *D. heterophylla*]

Pollen grains are in tetrahedral tetrad; viscin thread absent; D 41.9 μm , P 21.5 μm , E 29.5 μm , D/d 1.42. P/E 0.73, oblate; 3-colpor(oid)ate, 2f 28.0 μm , W 2.1 μm , 2f/W 13.33, 2f/D 0.67, significantly wider at middle, acute towards end, colpus margin distinct, costae present; endocracks absent or indistinct; endoaperture lalongate, 2.4 μm long, 9.1 μm wide; apocolpial exine 2.2 μm thick, septum 1.2 μm thick; tectate, exine sculpture from verrucate or rugulate.

In SEM, pollen surface is flat, primary apocolpial exine sculpture psilate, covered with secondary striate sculpture (Type PS; Fig. 3-24 G); colpus membrane granulate.

Gaultheria [130 spp. / 21 spp. examined: *G. adenostrix*, *G. anastonosans*, *G. appressa*, *G. bracteata*, *G. buxifolia*, *G. erecta*, *G. eriophylla* var. *eriophylla*, *G. foliolosa*, *G. gracilis*, *G. insane*, *G. itatiae*, *G. itoana*, *G. miqueliana*, *G. myrtilloides* var. *myrtilloides*, *G. oppositifolia*, *G. procumbens*, *G. prostrate*, *G. rigida*, *G. shallon*, *G. tomentosa* and *G. vacciniodes*]

Pollen grains are both in normal and compact tetrahedral tetrad, rarely in other configurations, often or sometimes broken along colpi in *G. erecta* and *G. prostrate*, often shrink in *G. itatiae*; viscin thread absent; D 24.8 – 44.3 μm , P 12.5 – 22.7 μm , E 19.0 – 35.8 μm , D/d 1.19 – 1.39, P/E 0.63 – 0.72, oblate; 3-colpor(oid)ate, rarely 4- colpor(oid)ate in *G.*

shallon, 2f 14.5 – 23.3 μm , W 0.6 – 3.0 μm , 2f/W 6.2 – 28.67, 2f/D 0.47 – 0.64, significantly wider at middle, acute but rarely tapering towards end, colpus margin distinct, costae present; endocracks present and distinct, but sometimes indistinct; endoaperture lalongate, 0.4 – 2.0 μm long, 5.2 – 10.8 μm wide; apocolpial exine 1.4 – 2.3 μm thick, septum 0.6 – 1.7 μm thick; tectate, exine sculpture from verrucate to rugulate or psilate.

In SEM, 1) pollen surface is uneven and rugged, primary apocolpial exine sculpture moderate to coarsely rugulate-psilate, the rugulae with minute (diam. < 0.2 μm) striate (Type RS; Figs. 3-24 M, 3-25 C, H); or 2) surface somewhat flat, primary exine sculpture moderate to coarsely rugulate without any secondary sculpture (Type R; Figs. 3-24 O, 3-25 A – B, D, F – G, I – J, L – N); or 3) surface somewhat flat, primary exine sculpture moderate to coarsely rugulate-psilate, the rugulae with moderate (diam. > 0.2 μm) granulate to short striate (Type RGS; Fig. 3-25 H); or intermediate type (R/RS, Fig. 3-24 N, 3-25 K); colpus membrane from granulate to smooth.

Three species of *Gaultheria*; *G. itatiae*, *G. insane* and *G. rigida*, are studied with TEM. The apocolpial exine is composed of ectexine and endexine (e.g., Fig. 3-26 A). Sexine is ca. 0.5 – 0.7 μm thick, endexine is very thin and a total exine is 1.0 – 1.6 μm thick (e.g., Fig. 3-26 C). The septum is ca. 0.4 – 1.2 μm thick. Intine is almost evenly thick around the pollen tetrad (e.g., Fig. 3-26 A), but sometimes comparatively thicker near the colpus region.

Leucothoë [6 spp. / 2 spp. examined: *L. grayana* var. *oblongifolia* and *L. keiskei*]

Pollen grains are both in normal and compact tetrahedral tetrad, grains often broken along colpi in *L. grayana* var. *oblongifolia*; viscin thread absent; D 40.3 – 41.5 μm , P 21.0 – 21.9 μm , E 29.2 – 32.4 μm , D/d 1.28 – 1.38, P/E 0.65 – 0.75, oblate; 3-colpor(oid)ate, rarely 4-colpor(oid)ate in *L. grayana* var. *oblongifolia*, 2f 16.4 – 22.2 μm , W 2.0 – 2.3 μm , 2f/W 7.13 – 11.10, 2f/D 0.41 – 0.53, significantly wider at middle, acute towards end, colpus margin distinct, costae present; endocracks absent or indistinct; endoaperture lalongate, 1.5 μm long,

6.9 μm wide; apocolpial exine 1.9 – 2.5 μm thick, septum 0.8 – 1.8 μm thick; tectate, exine sculpture from fine verrucate to fine rugulate.

In SEM, pollen surface is flat, 1) primary apocolpial exine sculpture psilate, covered with secondary striate sculpture (Type PS; Fig. 3-27 D); or 2) primary exine sculpture moderate to coarsely rugulate-psilate, the rugulae with minute (diam. < 0.2 μm) striate (Type RS; Fig. 3-27 E); colpus membrane granulate.

Tepuia [7 spp. / 1 sp. examined: *T. venusta*]

Pollen grains are in tetrahedral tetrad, 1 or 2 grains often shrink; viscin thread absent; D 59.6 μm , P 30.5 μm , E 44.9 μm , D/d 1.33, P/E 0.68, oblate; 3-colporate, 2f 28.3 μm , W 5.1 μm , 2f/W 5.55, 2f/D 0.47, significantly wider at middle, acute towards end, tip often bifurcated, colpus margin distinct, costae present; endocracks absent or indistinct; endoaperture lalongate, 3.5 μm long, 17.2 μm wide; apocolpial exine 3.1 μm thick, septum 1.1 μm thick; tectate, exine sculpture from verrucate or rugulate.

In SEM, pollen surface is somewhat flat, primary apocolpial exine sculpture coarsely rugulate, the rugulae with very minutely striate (R/RS; Fig. 3-27 H); colpus membrane granulate.

Pollen morphology of tribe Lyonieae [4 genera / 4 genera examined: *Agarista*, *Craibiodendron*, *Lyonia* and *Pieris*]

Agarista [30 spp. / 5 spp. examined: *A. chlorantha*, *A. coriifolia* var. *coriifolia*, *A. eucalyptiodes*, *A. populifolia* and *A. salicifolia*]

Pollen grains are in both normal and compact tetrahedral tetrad, often 1 – 2 grains in each tetrad shrink in *A. salicifolia*; viscin thread absent; D 30.5 – 44.3 μm , P 16.3 – 23.2 μm , E 22.9 – 33.3 μm , D/d 1.22 – 1.41, P/E 0.62 – 0.74, oblate; 3-colporate, 2f 12.5 – 27.3 μm , W 0.4 – 2.4 μm , 2f/W 7.86 – 31.25, 2f/D 0.38 – 0.67, significantly wider at middle, acute

towards end, colpus margin distinct, costae present, thick in *A. populifolia*, short in *A. salicifolia*, indistinct in one specimen of *A. eucalyptiodes* (Dusen 2011); endocracks present and distinct, but sometimes indistinct; endoaperture lalongate, 0.8 – 2.4 μm long, 7.8 – 17.3 μm wide; apocolpial exine 1.8 – 2.6 μm thick, septum 0.7 – 1.4 μm thick; tectate, exine sculpture from finely verrucate to coarsely rugulate.

In SEM, pollen surface is somewhat flat, primary apocolpial exine sculpture moderate to coarsely rugulate without any secondary sculpture (Type R; Figs. 3-27 M – O, 3-28 B), or intermediate type (R/P; Figs. 3-27 L, 3-28 A); colpus membrane granulate or granuloid.

Craibiodendron [5 spp. / 1 sp. examined: *C. yunnanensis*]

Pollen grains are in compact tetrahedral tetrad (Fig. 3-34 A – B); viscin thread absent; D 32.3 μm , P 17.1 μm , E 23.7 μm , D/d 1.36, P/E 0.72, oblate; 3-colporate, 2f 18.9 μm , W 1.6 μm , 2f/W 11.81, 2f/D 0.59, significantly wider at middle, acute towards end, colpus margin distinct and psilate, costae present; endocracks present; endoaperture very lalongate, 0.7 μm long, 9.9 μm wide; apocolpial exine 2.3 μm thick, septum 2.5 μm thick; tectate, exine sculpture rugulate.

In SEM, pollen surface is uneven and rugged, primary apocolpial exine sculpture coarsely rugulate-psilate, intermediate type (RS/R; Fig. 3-28 F); colpus membrane granulate.

Lyonia [35 spp. / 6 spp. examined: *L. buchii*, *L. jamaicensis*, *L. ligustrina*, *L. lucida*, *L. macrophylla* and *L. ovalifolia* var. *elliptica*]

Pollen grains are commonly in normal tetrahedral tetrad (Fig. 3-34 D), rarely compact, often 1 or 2 grains in each tetrad shrink in *L. buchii*; viscin thread absent; D 28.0 – 37.0 μm , P 15.1 – 19.0 μm , E 22.0 – 28.6 μm , D/d 1.27 – 1.38, P/E 0.65 – 0.73, oblate; 3-colporate, but colporoidate in *L. lucida*, 2f 14.1 – 19.2 μm , W 0.5 – 1.4 μm , 2f/W 11.77 – 28.2, 2f/D 0.47 – 0.57, significantly wider at middle, acute towards end, colpus margin distinct, costae

present but sometimes indistinct; endocracks commonly absent or indistinct, but sometimes distinct; endoaperture lalongate, 0.5 – 1.1 μm long, 5.0 – 6.9 μm wide; apocolpial exine 1.4 – 2.0 μm thick, septum 0.7 – 2.0 μm thick, septum very thin or absent in *L. ligustrina*; tectate, exine sculpture from verrucate to rugulate or psilate.

In SEM, 1) pollen surface uneven and rugged to somewhat flat, primary apocolpial exine sculpture coarsely rugulate to coarsely rugulate-psilate, intermediate type (RS/R; Figs. 3-28 J – K, O); or 2) surface is somewhat flat, exine sculpture coarsely rugulate without any secondary sculpture (Type R; Fig. 3-28 M); colpus membrane variable.

In TEM for *L. buchii*, the apocolpial exine is composed of ectexine and endexine (Fig. 3-29 A). Sexine is ca. 0.9 μm thick, sexine and nexine almost equal in thickness and a total exine is ca. 1.7 μm thick (Fig. 3-29 B). The septum is ca. 0.7 – 1.3 μm thick (Fig. 3-29 C). Intine is almost evenly thick around the pollen tetrad.

Pieris [8 spp. / 7 spp. examined: *P. cubensis*, *P. floribunda*, *P. formosa*, *P. japonica*, *P. koidzumiana*, *P. nana* and *P. phillyreifolia*]

Pollen grains are in tetrahedral tetrad (Fig. 3-35 A), rarely other configurations, most grains somewhat shrink in *P. phillyreifolia*; viscin thread absent; D 31.9 – 48.6 μm , P 17.1 – 24.3 μm , E 24.3 – 35.6 μm , D/d 1.28 – 1.37, P/E 0.66 – 0.72, oblate; 3-colporate, 2f 13.8 – 29.0 μm , W 0.6 – 2.0 μm , 2f/W 6.9 – 41.43, 2f/D 0.33 – 0.60, significantly wider at middle, somewhat obtuse to acute towards end, colpus margin distinct, costae present sometimes indistinct, thick in *P. cubensis*, faint in *P. japonica*; endocracks present; endoaperture lalongate, 1.0 – 3.0 μm long, 6.4 – 11.0 μm wide; apocolpial exine 1.4 – 2.6 μm thick, septum 0.7 – 2.2 μm thick; tectate, exine sculpture from verrucate to rugulate.

In SEM, pollen surface uneven to somewhat flat and rugged, primary apocolpial exine sculpture coarsely rugulate without any secondary sculpture (Type R; Figs. 3-29 G, 3-30 A – B); or 2) primary exine sculpture psilate, covered with secondary striate sculpture (Type PS;

Fig. 3-29 L); or 3) surface uneven and rugged to somewhat flat, exine sculpture coarsely rugulate to coarsely rugulate-psilate, intermediate types (R/RS; Figs. 3-29 I, K, 3-30 D, F – G, RS/PS; Fig. 3-29 J); colpus membrane granulate or granuloid.

Pollen morphology of tribe Oxydendreae [monotypic, genera examined: *Oxydendrum*]

Oxydendrum [1 sp. / 1 sp. examined: *O. arboreum*]

Pollen grains are in compact tetrahedral tetrad circular in shape (Fig. 3-30 H – I); viscin thread absent; D 33.4 μm , P 16.5 μm , E 26.5 μm , D/d 1.26, P/E 0.62, oblate; 3-colporate, 2f 17.3 μm , W 0.7 μm , 2f/W 24.71, 2f/D 0.52, significantly wider at middle, acute towards end, colpus margin distinct, costae present; endocracks absent or indistinct; endoaperture lalongate, 0.9 μm long, 9.4 μm wide; apocolpial exine 2.0 μm thick, septum 1.2 μm thick; tectate, exine sculpture from finely verrucate to finely rugulate.

Pollen of *O. arboreum* could not be studied under SEM due to either shrinkage and/or breakdown of all grains on SEM stub.

In TEM, the apocolpial exine is composed of ektexine and endexine (Fig. 3-30 J). Sexine is ca. 0.43 – 0.44 μm thick, sexine (especially tectum) identically thinner compared to nexine and a total exine is ca. 1.03 μm thick (Fig. 3-30 K). The septum is ca. 0.5 – 0.8 μm thick (Fig. 3-30 L). The exine in LM appears about 2 times thicker than in TEM. Intine is almost evenly thick around the pollen tetrad.

Table 3-6-1. Pollen morphological data of subfamily Vaccinioideae based on light microscopic investigation.

Name of Taxa	Config- ration ²	D ³	P ⁴	D/d ⁵	P/E ⁶	2f ⁷	2f/W ⁸	2f/D ⁹	Apo. Exine thickness ¹⁰	Septum Thickness ¹¹	Orname- ntation ¹²	Colpus Memb. ¹³	Remark ¹⁴	
Tribe Andromedeae (2/2)¹														
<i>Andromeda polifolia</i>	Takahashi 9889	CT	III	III	IV	II	II	II	V	III	I P	R	G	
	Johnson s.n.	T	III	III	IV	II	II	II	III	II	I (P)	-	G	
	Takahashi & Fujita 9753	CT	III	III	IV	II	II	I	IV	III	I P	RS	G	5, 7
<i>A. polifolia</i> var. <i>glaucophylla</i>		CT	III	III	IV	II	II	I	III	III	I P	-	-	
<i>Zenobia pulverulenta</i>		CT	II	II	IV	I	II	II	V	II	I P	R*	G	
Tribe Gaultherieae (5/6)														
<i>Chamaedaphne calyculata</i>	DeSimone et al. 6910	CT	II	II	V	II	II	V	V	II	III	-	Gr	7
	Takahashi & Fujita 9755	T	II	II	IV	II	I	II	V	II	I	R*	G	7
<i>Diplycosia heterophylla</i>		T	III	III	V	II	II	II	V	III	II	PS	LG	2
<i>Gaultheria</i>														
Section <i>Amblyandra</i>														
<i>G. adenothrix</i>		CT	II	II	IV	II	II	II	V	III	II	RS	G	
Section <i>Brossaea</i>														
Subsection <i>Botryphoros</i>														
Series <i>Hispidae</i>														
<i>G. appressa</i>		T	II	II	IV	II	I	III	IV	II	II	-	-	1
Series <i>Leucothoides</i>														
<i>G. miqueliana</i>		CT	II	II	IV	II	I	III	V	I	I	R/RS	LG	2
<i>G. prostrate</i>		T	II	II	IV	II	I	II	IV	II	II	R*	G/LG	2
Series <i>Ruprestres</i>														
<i>G. oppositifolia.</i>		CT	I	I	IV	II	I	II	IV	II	I	-	-	4
Subsection <i>Dasyphyta</i>														
Series <i>Domingenses</i>														
<i>G. bracteata</i>		CT	II	II	IV	II	I	II	III	II	I	R	S/G	
<i>G. erecta</i>		CT	II	II	IV	II	II	II	IV	II	II	RS	G	7
<i>G. gracilis</i>		CT	II	II	II	I	I	II	III	II	I	-	-	4
<i>G. rigida</i>		CT	II	II	III	I	I	I	IV	II	I	R	G	1, 4
<i>G. shallon</i>		CT	n.d.	n.d.	n.d.	n.d.	n.d.	n.d.	n.d.	n.d.	n.d.	RGS	?	5
Series <i>Tomentosae</i>														
<i>G. eriophylla</i> var. <i>eriophylla</i>		T	II	II	IV	II	I	II	III	II	I	R	LG	
<i>G. tomentosa</i>		CT	II	II	IV	II	I	II	IV	II	I	R	Gr/G	

Table 3-6-1. Continued.

Name of Taxa	Config- ration ²	D ³	P ⁴	D/d ⁵	P/E ⁶	2f ⁷	2f/W ⁸	2f/D ⁹	Apo. Exine thickness ¹⁰	Septum Thickness ¹¹	Orname- ntation ¹²	Colpus Memb. ¹³	Remark ¹⁴
Section Gaultheria													
<i>G. procumbens</i>	CT	n.d.	n.d.	n.d.	n.d.	n.d.	n.d.	n.d.	n.d.	n.d.	RS	?	
Section <i>Monoanthemona</i>													
Series <i>Antipodae</i>													
<i>G. anastomosans</i>	CT	II	II	III	II	II	II	V	II	I	R	G/Gr	4
<i>G. buxifolia</i>	CT	II	II	IV	II	I	I	IV	II	I	R	G	2, 7
<i>G. foliolosa</i>	CT	II	II	IV	II	I	II	IV	III	II	R/RS	G	7
<i>G. vaccinoides</i>	CT	II	II	IV	II	I	II	IV	II	I	-	-	4, 5
Series <i>Itatiaiae</i>													
<i>G. itatiaiae</i>	CT	II	II	III	I	II	I	IV	III	I	R	Gr	4
Series <i>Myrtilloideae</i>													
<i>G. myrtilloides</i> var. <i>myrtilloides</i>	CT	I	I	IV	II	I	III	V	II	I	R	G	7, 8
Section <i>Pseudogaultheria</i>													
<i>G. insane</i>	CT	III	III	III	I	II	II	IV	II	III	R	G/Gr	
<i>Leucothoë grayana</i> var. <i>oblongifolia</i>	CT	III	III	III	I	II	II	IV	II	I	PS	G	2, 5
<i>L. keiskei</i>	T	III	III	IV	II	I	I	III	III	III	RS	?	
<i>Tepuia venusta</i>	T	IV	V	IV	II	II	I	III	V	II	R/RS	G	
Tribe Lyonieae (4/4)													
<i>Agarista</i>													
Section <i>Agarista</i>													
<i>Agarista chlorantha</i> Hats. & Guim. 24777	CT	III	III	III	II	I	II	III	III	II	R/P	G	7
Jonsson 1398a	T	III	III	IV	II	II	III	III	II	I			7
<i>A. coriifolia</i> var. <i>coriifolia</i>	CT	III	III	III	II	I	I	II	IV	I	R	Gr/G	
<i>A. eucalyptoides</i> Dusen 2011	CT	II	II	IV	II	I	III	IV	II	I	R	Gr	4
Hatschbach 44720	CT	II	II	III	I	I	III	n.d.	IV	I	R	Gr/G	
<i>A. populifolia</i>	T	III	III	V	II	II	II	V	II	I	R/P	Gr	7
Section <i>Agauria</i>													
<i>A. salicifolia</i> Schlieben 1160A	T	II	II	IV	II	I	II	III	II	II	R	G/Gr	
Dorr & Barnett 3165	T	II	II	IV	II	II	IV	IV	III	II		?	
<i>Craibiodendron yunnanensis</i>	CT	III	II	IV	II	I	II	IV	III	IV	RS/R	G	
<i>Lyonia</i>													
Section <i>Arsenococcus</i>													
<i>L. ligustrina</i>	T	II	II	IV	I	I	II	IV	I	0	R/RS	S/Gr	
Section <i>Lyonia</i>													
<i>Lyonia buchii</i>	T	II	II	III	II	I	III	IV	II	I	R/RS	G/Gr	4, 7
<i>L. jamaicensis</i>	CT	I	II	III	II	I	III	III	II	I	-	-	4

Table 3-6-1. Continued.

Name of Taxa	Config- ration ²	D ³	P ⁴	D/d ⁵	P/E ⁶	2f ⁷	2f/W ⁸	2f/D ⁹	Apo. Exine thickness ¹⁰	Septum Thickness ¹¹	Orname- ntation ¹²	Colpus Memb. ¹³	Remark ¹⁴
<i>L. macrophylla</i>	T	II	II	IV	II	I	III	IV	II	I	-	-	4
Section <i>Maria</i>													
<i>L. lucida</i>	T	II	II	IV	II	I	III	IV	II	III	R	?	2
Section <i>Pieridopsis</i>													
<i>L. ovalifolia</i> var. <i>elliptica</i>	T	II	II	IV	II	I	II	III	II	I	R/RS	S/Gr	
<i>Pieris</i>													
Subgenus <i>Arcterica</i>													
<i>P. nana</i>													
Fukuda 180	T	II	II	IV	II	I	I	IV	III	III	R	Gr/G	
Takahashi 2571	T	n.d.	n.d.	n.d.	n.d.	n.d.	n.d.	n.d.	n.d.	n.d.	R/RS	G	
Subgenus <i>Pieris</i>													
Section <i>Pieris</i>													
<i>P. floribunda</i>	T	III	III	IV	II	II	II	IV	I	III	RS/PS	?	
<i>P. formosa</i>	T	III	III	IV	II	I	I	II	III	IV	PS	LG	7
<i>P. japonica</i>	T	III	III	III	II	II	II	III	III	II	R	LG	
<i>P. koidzumiana</i>	T	II	III	IV	II	I	II	III	III	III	R/RS	G	
Section <i>Phillyreoides</i>													
<i>P. cubensis</i>	T	II	III	III	II	I	IV	III	III	I	R/RS	Gr	7
<i>P. phillyreifolia</i>	T	III	III	IV	II	II	V	V	II	I	R/RS	?	4
Tribe Oxydendreae (1/1)													
<i>Oxydendrum arboreum</i>	CT	II	II	III	I	I	III	IV	II	II	-	-	
Tribe Vaccinieae (23/33)													
<i>Agapetes bracteata</i>	T	II	II	IV	II	I	II	III	II	I	FS	Gr	
<i>A. lobbii</i>	T	III	IV	IV	II	III	V	V	IV	II	R/RS	?	7
<i>A. oblonga</i>	T	III	III	V	II	II	II	IV	III	II	PS	Gr	2
<i>Anthopterus verticillatus</i>	T	III	III	V	II	I	I	II	II	II	-		1
<i>Cavendishia adenophora</i>	T	III	III	IV	II	I	I	II	II	II	RS	Gr	
<i>C. bracteata</i>	T	III	III	V	II	I	I	II	II	II	RS	-	
<i>C. capitulata</i>	T	III	III	IV	II	II	I	II	II	I P	RS	G/Gr	
<i>C. divaricata</i>	T	III	III	IV	II	I	I	III	II	I	RS	Gr/S	4
<i>C. isernnii</i> var. <i>pseudospicata</i>	CT	III	III	IV	II	I	II	II	II	II	RS	?	7
<i>C. marginata</i>	CT	IV	IV	IV	II	I	I	II	I	I	RS	?	4
<i>C. pubescens</i>	CT	III	III	III	II	I	I	II	II	I	RS	Gr/S	4
<i>C. tarapotana</i> var. <i>gilgiana</i>	CT	III	IV	IV	II	II	I	II	I	I	R/P	G/Gr	
<i>Ceratostema lanigerum</i>	CT	II	II	IV	II	II	III	V	I	0		G	2
<i>C. loranthiflorum</i>	CT	I	II	IV	II	II	III	V	I	0		S/Gr	8
<i>Costera endertii</i>	CT	II	III	II	II	II	I	IV	IV	III	RSG/MG	?	7

Table 3-6-1. Continued.

Name of Taxa	Config- ration ²	D ³	P ⁴	D/d ⁵	P/E ⁶	2f ⁷	2f/W ⁸	2f/D ⁹	Apo. Exine thickness ¹⁰	Septum Thickness ¹¹	Orname- ntation ¹²	Colpus Memb. ¹³	Remark ¹⁴
<i>Demostenesia mandonii</i>	LT	III	IV	V	III	III	IV	VI	II	I	R/RS	G	
<i>D. weberbaueri</i>	LT	IV	IV	IV	II	II	III	III	III	II	RS	Gr/S	4
<i>Dimorphanthera collinsii</i> var. <i>montis-wilhelmi</i>	CT	IV	IV	IV	II	II	II	III	IV	I	R/RS	Gr/G	7
<i>D. leucostoma</i>	T	IV	IV	IV	II	II	III	IV	III	I	R/RS	Gr	7
<i>D. microphylla</i>	T	VI	VI	V	III	III	II	III	II	I	R/RS	G/Gr	
<i>Diogenesia floribunda</i>	CT	III	III	III	II	II	II	IV	III	II	-	-	7
<i>D. octandra</i>	CT	II	II	IV	II	I	II	IV	II	I	-	-	4
<i>Disterigma acuminatum</i>	CT	I	I	IV	II	I	III	V	II	I	RG	Gr	
<i>D. alaternoides</i>	T	IV	IV	V	II	II	III	IV	IV	V	RGS	Gr	5
<i>D. emperifolium</i>	CT	II	III	IV	II	II	IV	IV	II	II	R	G	5, 7
<i>D. humboldtii</i>	CT	III	III	IV	II	II	II	V	III	I	RG	Gr/G	7
<i>D. popenoei</i>	T	III	III	IV	II	II	III	IV	III	I	RG or RGS	G/Gr	7
<i>Gaylussacia</i>													
Section <i>Decamerium</i>													
<i>G. baccata</i>	T	III	III	IV	II	I	I	II	II	III	RG	G/Gr	2
Section <i>Gaylussacia</i>													
<i>G. amoena</i>	T	III	III	III	II	I	II	III	IV	I	RS/R	G/Gr	
<i>G. brasiliensis</i>	T	III	III	IV	II	II	I	III	II	III	RS/R	S/Gr	7
<i>G. dumosa</i>	T	-	-	-	-	-	-	-	-	-	RS	LG	
<i>G. reticulata</i>	T	III	III	III	II	II	I	III	III	II	RG	Gr	4
<i>G. virgata</i> var. <i>virgata</i>	CT	III	III	III	II	I	II	III	III	I	R/P	G	
<i>Gonocalyx smilacifolius</i>	T/IT	II	II	III	II	I	II	IV	IV	II	RGS	S/Gr	7
<i>Macleania bullata</i>	T	III	III	IV	II	III	II	V	II	I	R/RS	G	7, 8
<i>M. crassa</i>	T	V	V	IV	II	n.d.	n.d.	n.d.	II	II	R/RS	G	8
<i>M. farinosa</i>	T/IT	-	-	-	-	-	-	-	-	-	R/RS	LG	8
<i>M. portmanii</i>	T	III	III	IV	II	II	III	V	II	I	R/RS	LG	
<i>M. rupestris</i>	T	IV	IV	V	II	III	II	IV	III	II	RS	Gr/S	2
<i>M. stricta</i>	IT	-	-	-	-	-	-	-	-	-	R/RS	G	
<i>Notopora schomburgkii</i>	T	IV	IV	IV	II	III	I	V	IV	II	?	G	7
<i>Orthaea abbreviata</i>	T	IV	IV	IV	II	II	II	IV	III	I (P)	R/P	G	7
<i>O. secundiflora</i>	CT	IV	IV	V	II	II	II	III	III	IV	RG	G	
<i>Pellegrinia harmisiana</i>	LT	III	III	V	III	II	VII	V	II	II	-	-	4
<i>Plutarchia guascensis</i>	T/CT	IV	IV	IV	II	III	II	IV	III	III	R/RS	G/Gr	
<i>P. rigida</i>	T	IV	IV	IV	II	III	IV	IV	III	II (P)	R/RS	S/Gr	7
<i>Psammisia ecuadorensis</i>	T	IV	IV	IV	II	III	III	V	III	I	R/RS	LG/Gr	4
<i>P. ferruginea</i>	T	n.d.	n.d.	n.d.	n.d.	n.d.	n.d.	n.d.	n.d.	n.d.	R/RS	S	

Table 3-6-1. Continued.

Name of Taxa	Config- ration ²	D ³	P ⁴	D/d ⁵	P/E ⁶	2f ⁷	2f/W ⁸	2f/D ⁹	Apo. Exine thickness ¹⁰	Septum Thickness ¹¹	Orname- ntation ¹²	Colpus Memb. ¹³	Remark ¹⁴
<i>P. sodiroi</i>	T/IT	n.d.	n.d.	n.d.	n.d.	n.d.	n.d.	n.d.	n.d.	n.d.	RS/R	G	
<i>Satyria leucostoma</i>	T	III	III	IV	II	I	II	II	III	II	R/RS	G	
<i>S. panurensis</i>	T	III	IV	III	II	II	II	IV	III	III	RS	LG	
<i>S. pilosa</i>	T	III	III	IV	II	II	II	IV	II	II	RS	SG	
<i>S. warszewiczii</i>	T	III	III	IV	II	II	I	IV	II	I	RS	G	
<i>Siphonandra elliptica</i>	LT	IV	IV	VI	III	III	II	VI	II	II	R/RS	G	2
<i>Sphyrospermum boekii</i>	T/IT	n.d.	n.d.	n.d.	n.d.	n.d.	n.d.	n.d.	n.d.	n.d.	R	G	
<i>S. buxifolium</i>	CT/IT	II	II	IV	II	I	II	III	I	II	R	G/Gr	5
<i>Themistoclesia anfracia</i>	T/IT	n.d.	n.d.	n.d.	n.d.	n.d.	n.d.	n.d.	n.d.	n.d.	R	?	
<i>T. cutucuensis</i>	T	II	II	IV	II	I	II	IV	II	I	RSG	Gr/G	7
<i>T. epiphytia</i>	T	II	II	IV	II	I	I	III	II	II	RG	S/Gr	4
<i>T. mucronata</i>	T	II	II	IV	II	II	I	IV	II	II	R	S/Gr	2
<i>Thibaudia albiflora</i>	CT	III	III	III	II	I	II	III	III	II	RS	G/Gr	
<i>T. angustifolia</i>	T	V	V	V	II	IV	IV	V	III	I	RS/R	Gr	8
<i>T. domingensis</i>	CT	III	III	IV	II	II	I	III	III	I P	RG	LG	4
<i>T. floribunda</i>	CT	IV	IV	IV	II	II	II	III	III	II	RS	Gr/G	2
<i>T. parvifolia</i>	CT	V	V	IV	II	IV	II	V	II	I	R/RS	G/Gr	2
						Sneidern 1864							
						Harling & Anderson 12242							7
<i>Vaccinium</i>													
Section <i>Batodendron</i>													
<i>V. cubense</i>	T	IV	IV	III	II	II	II	IV	II	III	RS/R	G	1
Section <i>Bracteata</i>													
<i>Vaccinium bracteatum</i>	CT	I	II	III	II	I	I	III	III	IV	R/RS	G	1, 6
<i>V. randaiense</i>	T	II	III	III	II	I	I	III	II	III	RS/R	G	1, 3
<i>V. wrightii</i>	T	III	III	III	II	I	I	III	II	III	RS	S/Gr	1, 2
Section <i>Ciliata</i>													
<i>V. oldhamii</i>	T	III	III	IV	II	II	I	III	I	IV	RS	G	1
Section <i>Conchophyllum</i>													
<i>V. emarginatum</i>	T	III	III	III	III	I	II	III	II	II	RS	G	1, sometimes 2,
Section <i>Cyanococcus</i>													
<i>V. corymbosum</i>	T	IV	III	III	II	II	I	III	II	III	R	G	6
						Spon. & Bouf. 1764							
						Meyer & Mazzeo 13278							
						Utech et al. 83-050							
<i>V. myrsinites</i>	T	III	III	III	II	II	I	III	I	I	R	G	
<i>V. myrtilloides</i>	T	II	III	III	II	II	II	IV	II	I	RS	G	
<i>V. pallidum</i>	T	III	III	III	II	I	I	III	II	II	RS/R	G	1, 3

Table 3-6-1. Continued.

Name of Taxa	Config- ration ²	D ³	P ⁴	D/d ⁵	P/E ⁶	2f ⁷	2f/W ⁸	2f/D ⁹	Apo. Exine thickness ¹⁰	Septum Thickness ¹¹	Orname- ntation ¹²	Colpus Memb. ¹³	Remark ¹⁴
Section <i>Eococcus</i>													
<i>V. leucanthum</i>	T	III	III	III	I	I	II	III	II	II	RS/R	S/Gr	6
<i>V. meridionale</i>	T	IV	III	II	II	II	III	IV	III	II	RS/R	G	2, 7
<i>V. sprengelii</i>	CT	III	II	II	I	I	II	III	II	I	RS	G	7
Section <i>Epigynium</i>													
<i>V. vacciniaceum</i>	CT	III	III	IV	II	II	II	IV	II	II	PS	G	
Section <i>Hemimyrtillus</i>													
<i>V. hirtum</i>	T	I	II	III	II	I	I	IV	I	III	RS/R	S/Gr	1
<i>V. smallii</i>	CT	III	III	II	II	II	I	III	II	II	P	S/Gr	1, 3
	CT	II	II	III	II	II	II	IV	II	IV	R	S/Gr	1, 2
Section <i>Herpothamnus</i>													
<i>V. crassifolium</i>	T	II	III	IV	III	I	I	III	II	III	R/RS	G	6
Section <i>Macropelma</i>													
<i>V. calycinum</i> f. <i>glabreccens</i>	T	III	III	III	II	II	II	IV	I	I	RS/R	G	2
Section <i>Myrtillus</i>													
<i>V. caespitosum</i>	T	II	II	IV	II	I	I	II	II	II	R/RS	G	2, 6
<i>V. myrtillus</i>	T	II	II	III	II	I	I	III	II	II	RS	G	5, 7
<i>V. ovalifolium</i>	T	II	III	III	II	I	I	III	I	III	R/RS	G	2
<i>V. parvifolium</i>	LT	III	III	IV	III	I	I	III	III	III	PS	G	1, 2
<i>V. scoparium</i>	T	n.d.	n.d.	n.d.	n.d.	n.d.	n.d.	n.d.	n.d.	n.d.	RS	LG	
Section <i>Oxycoccoides</i>													
<i>V. japonicum</i>	CT	I	II	III	II	II	I	V	II	III	FG	G	
Section <i>Oxycoccus</i>													
<i>V. microcarpum</i>	CT	n.d.	n.d.	n.d.	n.d.	n.d.	n.d.	n.d.	n.d.	n.d.	R	?	
<i>V. macrocarpon</i>	CT	II	II	III	II	II	II	V	I	I	RS	G	7, 8
<i>V. oxycoccus</i>	T	IV	III	IV	III	II	II	III	IV	IV	R/RS	S/Gr	5
Section <i>Polycodium</i>													
<i>V. stamineum</i>	T	III	III	IV	III	II	I	IV	II	IV	RSG	S/Gr	1, 2
Section <i>Praestantia</i>													
<i>V. praestans</i>	T	I	II	III	II	I	I	III	II	II	R/RS	S/Gr	
Section <i>Polycodium</i>													
<i>V. consanguineum</i>	T	IV	III	III	II	II	II	IV	IV	I	RS/R	G	
<i>V. floribundum</i> var. <i>floribundum</i>	T	II	II	III	II	II	III	IV	I	I	RS	G	7
<i>V. ovatum</i>	T	II	II	III	II	I	I	III	I	II	RS/R	G	1

Table 3-6-1. Continued.

Name of Taxa	Config- ration ²	D ³	P ⁴	D/d ⁵	P/E ⁶	2f ⁷	2f/W ⁸	2f/D ⁹	Apo. Exine thickness ¹⁰	Septum Thickness ¹¹	Orname- ntation ¹²	Colpus Memb. ¹³	Remark ¹⁴
Section <i>Uliginosa</i>													
<i>V. uliginosum</i>													
Takahashi 9864	T	II	II	III	II	II	II	V	I	I	RS/R	G	4, 8
Takahashi 9908	T	III	III	III	II	II	II	IV	I	I	RS	G	4
Section <i>Vitis-Idaea</i>													
<i>V. vitis-idaea</i>	CT	II	II	III	II	II	II	V	II	I	RS	G	7
Section <i>not known</i>													
<i>V. donianum</i>	T	II	II	II	I	II	II	IV	I	II	RS/R	G	8

D: tetrad diameter, P: polar length, d(E): equatorial diameter, 2f: ectoaperture length, W: ectoaperture width, Apo.: apocolpial, Memb.: membrane, n.d.: not discerned.

¹ Genera examined/total no. of genera

⁸ I: – 10.0, II: 10.1 – 20.0, III: 20.1 – 30.0, IV: 30.1 – 40.0, V: 40.1 – 50.0, VI 50.1 – 60.0,

² T: Tetrahedral tetrad, CT: Compact tetrahedral tetrad, LT: Lobed tetrahedral tetrad

VII: 60.1 –

³ I: 20.1 – 30.0µm, II: 30.1 – 40.0µm, III: 40.1 – 50.0µm, IV: 50.1 – 60.0µm, V: 60.1 – 70.0µm

⁹ I: – 0.30, II: 0.31 – 0.40, III: 0.41 – 0.50, IV: 0.51 – 0.60, V: 0.61 – 0.70, VI: 0.71 –

¹⁰ I: 1.1 – 1.5µm, II: 1.6 – 2.0µm, III: 2.1 – 2.5µm, IV: 2.6 – 3.0µm, V: 3.5µm –

⁴ I: – 15.0µm, II: 15.1 – 20.0µm, III: 20.1 – 25.0µm, IV: 25.1 – 30.0µm, V: 30.1 – 35.0µm, VI: 35.1 µm –

¹¹ I: – 1.0µm, II: 1.1 – 1.5µm, III: 1.6 – 2.0µm, IV: 2.1 – 2.5 µm, V: 2.6µm – , P: Perforated

¹² Exine ornamentation type by SEM corresponding to Fig. 3.

⁵ I: – 1.19, II: 1.20 -1.29 III: 1.30 – 1.39, IV: 1.40 – 1.49, V: 1.50 – 1.59, VI: 1.60 –

¹³ G: Granulate, Gr: Granuloid, LG: Largely granulate, LGr: Largely granuloid, S: Smooth

⁶ II: 0.61 – 0.65, III: 0.66 – 0.70, IV: 0.71 – 0.75, V: 0.76 – 0.80, VI: 0.81 –

¹⁴ 1: Noticed in other configurations, 2: Endoaperture indistinct, 3: Endoaperture circular, 4:

⁷ I: 10.1 – 20.0µm, II: 20.1 – 30.0µm, III: 30.1 – 40.0µm, IV: 40.1 – 50.0µm

Costae indistinct, 5: Rarely 4-aperture, 6: Colpus tapering towards end, 7: Endocracks distinct, 8: Apocolpial region small

Table 3-6-2. Variation in palynological characters of subfamily Vaccinioideae showing mean value in μm and standard deviation.

Name of Species	D	P	d	D/d	P/E	Ectoaperture			2f/D	Endoaperture		Apo. exine thickness	Septum thickness	
						Length (2f)	Width (W)	2f/W		Length	Width			
Tribe Andomedeae														
<i>Andromeda polifolia</i>	Takahashi 9889	43.9 \pm 3.7 (36.3-49.5)	22.9 \pm 2.2 (19.5-27.2)	33.5 \pm 2.5 (27.2-36.3)	1.31	0.68	27.3 \pm 2.8 (24.8-34.7)	2.6 \pm 0.6 (1.7-3.3)	10.5	0.62	2.2 \pm 0.8 (1.3-3.6)	7.8 \pm 2.3 (5.0-11.6)	2.4 \pm 0.4 (2.0-3.3)	0.8 \pm 0.4 (0.5-1.7)
	Johnson s.n.	44.6 \pm 2.1 (40.9-47.4)	23.8 \pm 1.0 (22.4-25.4)	32.5 \pm 1.5 (30.0-33.8)	1.37	0.73	21.3 \pm 1.8 (18.2-24.8)	2.1 \pm 0.5 (1.3-3.3)	10.14	0.48	1.3 \pm 0.5 (0.4-1.7)	10.6 \pm 1.2 (9.9-13.2)	1.9 \pm 0.2 (1.7-2.1)	1.0 \pm 0.4 (0.3-1.5)
	Takahashi & Fujita 9753	43.3 \pm 1.6 (42.3-46.2)	21.9 \pm 1.5 (19.5-24.8)	33.3-1.7 (30.5-35.5)	1.30	0.66	22.0 \pm 1.9 (19.8-24.8)	3.0 \pm 0.6 (2.5-4.0)	7.33	0.54	1.7 \pm 0.4 (1.3-2.5)	8.7 \pm 1.6 (6.6-9.9)	2.1 \pm 0.4 (1.7-3.0)	0.7 \pm 0.3 (0.3-1.2)
<i>A. polifolia</i> var. <i>glaucophylla</i>		43.5 \pm 1.2 (41.9-44.4)	22.4 \pm 1.0 (21.1-24.1)	33.1 \pm 1.2 (30.7-34.7)	1.31	0.68	21.3 \pm 2.0 (18.2-24.8)	2.9 \pm 0.7 (1.7-3.6)	7.34	0.50	1.9 \pm 0.7 (0.8-3.0)	9.9 \pm 1.6 (8.3-13.2)	2.3 \pm 0.4 (1.7-3.0)	0.9 \pm 0.4 (0.2-1.7)
<i>Zenobia pulverulenta</i>		35.5 \pm 1.3 (33.2-37.1)	17.9 \pm 1.0 (16.5-19.8)	27.4 \pm 1.5 (24.8-29.7)	1.30	0.65	23.3 \pm 1.9 (20.6-26.4)	2.2 \pm 0.7 (1.3-3.3)	10.59	0.66	1.5 \pm 0.6 (0.8-2.5)	7.7 \pm 0.8 (6.6-8.3)	1.7 \pm 0.1 (1.5-2.0)	0.9 \pm 0.3 (0.3-1.5)
Tribe Gaultherieae														
<i>Chamaedaphne calyculata</i>	DeSimone et al. 6910	32.6 \pm 1.5 (29.7-34.3)	16.6 \pm 0.8 (15.7-18.3)	22.8 \pm 1.5 (19.8-24.8)	1.43	0.73	20.8 \pm 0.8 (19.8-21.5)	0.5 \pm 0.1 (0.3-0.7)	41.6	0.64	0.5 \pm 0.1 (0.3-0.7)	7.2 \pm 2.5 (5.0-9.9)	1.6 \pm 0.1 (1.5-1.8)	1.8 \pm 0.6 (1.2-3.0)
	Takahashi & Fujita 9755	30.6 \pm 1.5 (28.9-33.3)	15.9 \pm 1.6 (13.2-17.8)	23.0 \pm 1.0 (21.5-25.1)	1.33	0.69	19.2 \pm 1.4 (16.5-21.5)	1.4 \pm 0.7 (0.8-3.3)	13.71	0.63	1.4 \pm 0.5 (0.5-2.5)	7.2 \pm 2.5 (5.0-13.2)	1.6 \pm 0.3 (1.2-2.0)	0.8 \pm 0.3 (0.3-1.2)
<i>Diplycosia heterophylla</i>		41.9 \pm 2.6 (36.9-47.5)	21.5 \pm 0.7 (20.1-23.1)	29.5 \pm 2.1 (28.1-34.7)	1.42	0.73	28.0 \pm 1.6 (25.6-31.4)	2.1 \pm 0.7 (1.3-3.3)	13.33	0.67	2.4 \pm 0.6 (1.7-3.3)	9.1 \pm 3.0 (3.0-13.2)	2.2 \pm 0.3 (1.7-2.6)	1.2 \pm 0.4 (0.7-1.7)
<i>Gaultheria</i>														
Section <i>Amblyandra</i>														
	<i>G. adenostrix</i>	33.3 \pm 1.3 (31.3-34.7)	16.8 \pm 1.1 (14.9-18.3)	25.0 \pm 1.2 (22.8-26.4)	1.33	0.67	20.5 \pm 1.9 (18.5-23.1)	1.2 \pm 0.5 (0.7-2.1)	17.08	0.62	1.0 \pm 0.5 (0.3-1.7)	7.2 \pm 2.0 (5.0-9.9)	2.1 \pm 0.7 (1.8-2.4)	1.2 \pm 0.3 (0.7-1.5)
Section <i>Brossaea</i>														
Subsection <i>Botryphoros</i>														
Series <i>Hispidae</i>														
	<i>G. appressa</i>	30.4 \pm 2.3 (28.1-35.0)	15.1 \pm 1.3 (13.2-17.2)	21.9 \pm 1.9 (19.8-25.1)	1.39	0.69	17.2 \pm 1.0 (15.7-18.2)	0.6 \pm 0.3 (0.3-1.3)	28.67	0.57	0.6 \pm 0.4 (0.3-1.7)	5.2 \pm 1.0 (3.3-6.6)	1.9 \pm 0.2 (1.7-2.0)	1.2 \pm 0.5 (0.5-2.3)
Series <i>Leucothoides</i>														
	<i>G. miqueliana</i>	30.8 \pm 1.7 (29.0-34.2)	15.8 \pm 1.0 (14.5-17.7)	22.7 \pm 1.0 (21.5-24.8)	1.37	0.70	18.8 \pm 1.5 (16.5-21.5)	0.9 \pm 0.6 (0.3-1.3)	20.89	0.61	0.6 \pm 0.5 (0.3-1.7)	9.9 \pm 3.1 (6.6-14.9)	1.4 \pm 0.2 (1.2-1.7)	0.8 \pm 0.3 (0.3-1.3)
	<i>G. prostrate</i>	32.4 \pm 2.1 (29.7-36.3)	16.4 \pm 0.8 (15.3-18.2)	23.4 \pm 1.5 (21.5-26.4)	1.38	0.70	19.2 \pm 1.1 (18.2-21.5)	1.4 \pm 0.6 (0.5-2.5)	13.71	0.59	0.4 \pm 0.1 (0.3-0.5)	6.1 \pm 1.9 (5.0-8.2)	1.7 \pm 0.1 (1.5-2.0)	1.4 \pm 0.2 (1.2-1.7)
Series <i>Ruprestres</i>														
	<i>G. oppositifolia</i>	24.8 \pm 1.7 (23.0-28.5)	12.5 \pm 1.0 (11.6-14.9)	19.0 \pm 1.0 (18.2-20.6)	1.31	0.66	14.5 \pm 0.7 (13.2-14.9)	0.9 \pm 0.4 (0.3-1.3)	16.11	0.58	0.7 \pm 0.1 (0.7-0.8)	7.2 \pm 1.0 (6.6-8.3)	1.8 \pm 0.1 (1.7-2.0)	1.0 \pm 0.2 (0.8-1.3)

Table 3-6-2. Continued.

Name of Species	D	P	d	D/d	P/E	Ectoaperture			2f/D	Endoaperture		Apo. exine thickness	Septum thickness
						Length (2f)	Width (W)	2f/W		Length	Width		
Subsection <i>Dasyphyta</i>													
Series <i>Domingenses</i>													
<i>G. bracteata</i>	35.4±1.4 (32.7-37.5)	18.3±0.7 (17.3-19.5)	26.5±1.3 (24.8-28.1)	1.34	0.69	17.2±1.1 (14.9-18.2)	1.3±0.2 (1.0-1.7)	13.23	0.49	1.4±0.4 (0.8-1.7)	8.3±3.0 (5.0-13.2)	2.0±0.3 (1.7-2.5)	1.0±0.2 (0.5-1.3)
<i>G. erecta</i>	38.2±1.5 (36.0-40.4)	19.0±0.7 (18.2-19.8)	28.1±1.0 (26.4-29.7)	1.36	0.68	21.0±1.0 (19.8-22.3)	1.1±0.4 (0.5-1.7)	19.09	0.55	1.2±0.5 (0.3-1.7)	8.0±1.1 (6.6-9.9)	1.8±0.2 (1.5-2.0)	1.1±0.5 (0.5-1.7)
<i>G. gracilis</i>	32.9±1.4 (31.7-36.0)	16.9±1.0 (15.7-18.5)	27.5±1.1 (26.1-29.4)	1.19	0.61	15.3±1.6 (13.2-16.5)	1.4±0.2 (1.2-1.7)	10.93	0.47	0.9±0.1 (0.8-0.9)	6.6±4.7 (3.3-9.9)	1.9±0.1 (1.7-2.0)	0.9±0.2 (0.5-1.3)
<i>G. rigida</i>	31.0±1.0 (29.7-32.3)	15.5±0.9 (14.0-16.5)	24.7±1.1 (23.1-26.4)	1.26	0.63	18.6±1.2 (16.5-19.8)	3.0±0.4 (2.0-3.6)	6.20	0.60	1.7±0.6 (0.7-2.5)	7.8±0.8 (6.6-8.3)	1.8±0.2 (1.3-2.1)	0.6±0.3 (0.5-1.3)
Series <i>Tomentosae</i>													
<i>G. eriophylla</i> var. <i>eriophylla</i>	35.4±1.5 (33.0-37.5)	18.2±0.5 (17.8-19.3)	26.6±1.0 (24.8-27.7)	1.33	0.68	17.7±1.7 (14.9-20.6)	1.3±0.4 (0.7-1.7)	13.62	0.50	1.9±0.8 (0.7-3.3)	7.0±1.4 (5.0-8.3)	1.9±0.1 (1.8-2.1)	0.8±0.4 (0.3-1.3)
<i>G. tomentosa</i>	33.3±1.0 (32.0-35.1)	17.0±0.6 (16.5-18.2)	25.3±1.0 (23.4-26.4)	1.32	0.67	17.1±2.9 (14.9-24.8)	1.3±0.4 (0.7-1.8)	13.15	0.51	2.0±0.7 (1.2-3.0)	9.0±1.6 (6.6-11.6)	1.8±0.1 (1.7-2.1)	0.8±0.4 (0.3-1.3)
Section <i>Monoanthemona</i>													
Series <i>Antipodae</i>													
<i>G. anastomosans</i>	36.5±0.9 (35.0-38.0)	19.2±1.3 (16.8-21.1)	28.3±1.7 (25.6-29.7)	1.29	0.68	23.3±1.3 (21.1-25.6)	2.2±0.6 (1.3-3.0)	10.59	0.64	1.8±0.8 (0.8-3.6)	10.0±2.4 (5.8-13.2)	2.0±0.1 (1.8-2.1)	0.9±0.4 (0.3-1.7)
<i>G. buxifolia</i>	34.4±1.6 (32.2-36.5)	17.5±1.6 (15.8-20.5)	26.4±1.8 (23.4-28.9)	1.30	0.66	19.6±2.0 (17.3-23.1)	2.2±0.6 (1.2-3.0)	8.91	0.57	1.8±0.9 (0.5-2.5)	8.0±2.4 (3.3-11.6)	1.9±0.3 (1.7-2.5)	0.9±0.3 (0.5-1.3)
<i>G. foliolosa</i>	34.0±1.0 (32.7-35.3)	17.9±0.9 (16.5-19.3)	25.3±1.2 (23.9-27.7)	1.34	0.71	18.3±0.9 (17.3-19.8)	1.4±0.6 (0.5-3.0)	13.07	0.54	1.1±0.4 (0.5-1.7)	7.7±1.1 (6.6-9.9)	2.3±0.3 (2.0-3.0)	1.1±0.4 (0.5-1.7)
<i>G. vaccinoides</i>	31.7±1.9 (29.7-34.7)	17.0±1.2 (15.3-19.3)	24.2±1.0 (22.3-25.6)	1.31	0.70	18.9±1.6 (16.5-21.5)	1.1±0.8 (0.3-3.0)	17.18	0.60	1.4±0.8 (0.3-2.5)	7.9±1.4 (5.0-9.9)	1.8±0.2 (1.7-2.1)	0.6±0.3 (0.3-1.0)
Series <i>Itatiaiae</i>													
<i>G. itatiaiae</i>	38.3±1.8 (36.1-41.3)	19.4±1.3 (17.0-21.5)	30.3±1.8 (26.4-32.2)	1.26	0.64	20.3±1.5 (17.3-23.1)	2.1±0.6 (1.3-3.1)	9.67	0.53	1.2±0.5 (0.5-2.1)	10.7±2.6 (8.3-16.5)	2.3±0.3 (2.0-2.8)	0.6±0.3 (0.2-1.3)
Series <i>Myrtilloideae</i>													
<i>G. myrtilloides</i> var. <i>myrtilloides</i>	27.8±1.3 (26.4-30.9)	14.6±0.7 (13.5-15.5)	20.3±0.7 (19.5-21.5)	1.37	0.72	17.4±0.8 (16.5-18.2)	0.7±0.2 (0.5-1.0)	24.86	0.63	0.8±0.4 (0.5-1.7)	8.2±3.9 (3.3-14.9)	1.7±0.2 (1.5-2.0)	0.9±0.2 (0.7-1.3)
Section <i>Pseudogaultheria</i>													
<i>G. insane</i>	44.3±2.4 (41.3-46.2)	22.7±1.3 (21.5-24.8)	35.8±3.1 (31.4-37.1)	1.24	0.63	23.0±2.5 (19.8-26.4)	1.2±0.3 (0.7-1.7)	19.17	0.52	1.1±0.2 (0.7-1.3)	10.8±2.8 (8.3-16.5)	2.0±0.4 (1.7-2.6)	1.7±0.5 (1.3-2.0)

Table 3-6-2. Continued.

Name of Species	D	P	d	D/d	P/E	Ectoaperture			2f/D	Endoaperture		Apo. exine thickness	Septum thickness	
						Length (2f)	Width (W)	2f/W		Length	Width			
<i>Leucothoë grayana</i> var. <i>oblongifolia</i>	41.5±1.0 (39.6-42.9)	21.0±1.1 (19.5-22.8)	32.4±1.4 (31.4-34.7)	1.28	0.65	22.2±1.4 (21.5-24.8)	2.0±1.1 (0.5-3.3)	11.10	0.53	1.5±1.2 (0.5-3.3)	6.9±2.7 (5.0-9.9)	1.9±0.2 (1.7-2.3)	0.8±0.3 (0.5-1.3)	
<i>L. keisei</i>	40.3±3.3 (35.5-43.2)	21.9±1.3 (18.7-24.0)	29.2±1.9 (25.9-31.7)	1.38	0.75	16.4±3.1 (14.4-19.2)	2.3±0.5 (1.9-2.9)	7.13	0.41	n.d.	n.d.	2.5±0.4 (1.9-2.9)	1.8±0.4 (1.0-2.4)	
<i>Tepuia venusta</i>	59.6±2.2 (55.6-63.5)	30.5±1.5 (28.1-32.7)	44.9±2.2 (42.6-48.7)	1.33	0.68	28.3±2.3 (26.4-33.0)	5.1±0.6 (4.3-5.8)	5.55	0.47	3.5±1.2 (1.7-5.0)	17.2±3.7 (11.6-23.1)	3.1±0.4 (2.3-3.6)	1.1±0.4 (0.7-1.8)	
Tribe Lyonia														
<i>Agarista</i>														
Section <i>Agarista</i>														
<i>A. chlorantha</i>	Hatsch. & Guimar. 24777	40.9±1.7 (38.0-42.9)	21.0±1.2 (19.8-22.9)	31.8±1.0 (29.7-33.0)	1.29	0.66	19.7±3.0 (15.7-26.4)	1.1±0.9 (0.3-3.0)	17.91	0.48	1.5±0.4 (0.5-2.0)	13.3±4.9 (6.6-19.8)	2.4±0.5 (1.8-3.0)	1.2±0.3 (0.5-1.7)
	Jonsson 1398a	44.3±2.2 (41.3-48.5)	23.2±1.4 (21.1-25.1)	32.1±1.6 (29.7-34.3)	1.38	0.72	20.7±2.2 (16.5-24.8)	0.7±0.4 (0.5-1.8)	29.57	0.47	1.5±0.6 (0.7-2.6)	9.5±1.5 (8.8-13.2)	2.0±0.1 (1.8-2.3)	1.0±0.6 (0.3-2.3)
<i>A. coriifolia</i> var. <i>coriifolia</i>		43.1±3.7 (39.6-49.5)	22.9±2.8 (19.5-27.1)	33.3±2.8 (31.3-38.0)	1.29	0.69	16.5±2.3 (14.9-18.2)	2.1±1.3 (1.2-3.0)	7.86	0.38	2.0±0.5 (1.7-2.3)	17.3±1.2 (16.5-18.2)	2.6±0.3 (2.1-3.0)	0.9±0.4 (0.5-1.3)
<i>A. eucalyptoides</i>	Dusén 2011	35.8±1.6 (33.5-38.0)	19.6±0.7 (18.2-20.1)	27.1±1.1 (25.1-28.1)	1.32	0.72	18.8±2.7 (13.2-21.5)	0.9±0.4 (0.5-1.7)	20.89	0.53	1.1±0.4 (0.5-1.7)	12.7±2.6 (8.3-16.5)	1.8±0.2 (1.7-2.1)	0.9±0.4 (0.5-1.7)
	Hatschbach 44720	38.3±1.3 (36.3-39.6)	19.4±1.5 (17.8-22.3)	31.2±0.9 (29.7-33.0)	1.22	0.62	19.5±1.1 (18.2-21.5)	1.9±0.5 (1.3-2.5)	21.67	0.51	1.9±0.8 (0.7-3.0)	11.1±3.5 (6.6-16.5)	2.2±0.5 (1.7-2.8)	1.1±0.3 (0.0.7-1.7)
<i>A. populifolia</i>		41.0±1.4 (39.6-43.2)	21.4±1.3 (19.3-23.1)	28.9±0.5 (28.1-29.7)	1.41	0.74	27.3±2.8 (24.8-34.7)	2.4±0.9 (1.7-3.3)	11.38	0.67	2.2±0.8 (1.3-3.6)	7.8±2.3 (5.0-11.6)	1.8±0.2 (1.3-2.1)	0.7±0.3 (0.2-1.2)
Section <i>Agauria</i>														
<i>A. salicifolia</i>	Schlieben 1106a	30.5±1.5 (27.7-33.0)	16.3±1.9 (12.9-18.2)	22.9±0.9 (21.5-24.8)	1.33	0.71	12.5±1.3 (11.6-15.7)	0.4±0.1 (0.3-0.7)	31.25	0.41	0.8±0.6 (0.3-1.7)	7.9±2.4 (5.0-11.6)	2.0±0.2 (1.7-2.1)	1.3±0.4 (0.7-1.7)
	Dorr & Barnett 3156	39.8±2.0 (38.0-43.9)	20.0±1.7 (16.5-23.1)	29.1±2.0 (26.4-31.4)	1.37	0.69	20.2±2.0 (16.5-22.3)	1.1±0.2 (0.8-1.3)	18.36	0.58	2.4±1.1 (0.7-3.6)	11.9±2.4 (8.3-14.9)	2.1±0.2 (2.0-2.6)	1.4±0.3 (1.0-1.7)
<i>Craibiodendron yunnanensis</i>		32.3±1.5 (29.7-35.3)	17.1±0.6 (16.0-18.2)	23.7±1.1 (21.5-25.1)	1.36	0.72	18.9±1.8 (17.3-23.1)	1.6±0.5 (0.7-2.0)	11.81	0.59	0.7±0.2 (0.5-1.0)	9.9±3.6 (6.6-14.9)	2.3±0.2 (2.0-2.8)	2.5±0.9 (1.0-3.6)
<i>Lyonia</i>														
Section <i>Arsenococcus</i>														
<i>L. ligustrina</i>		33.1±2.0 (31.3-36.3)	16.2±1.0 (14.9-17.3)	25.0±1.3 (23.1-26.4)	1.32	0.65	17.9±0.5 (17.3-18.2)	1.4±1.3 (0.3-2.8)	12.79	0.54	1.1±0.8 (0.5-1.7)	5.0±2.3 (3.3-6.6)	1.4±0.1 (1.3-1.9)	0
Section <i>Lyonia</i>														
<i>L. buchii</i>		37.0±2.2 (33.3-40.1)	19.0±1.2 (17.8-21.8)	28.6±1.9 (25.6-32.7)	1.29	0.66	19.0±1.9 (16.5-21.5)	0.9±0.3 (0.5-1.3)	21.11	0.51	1.1±0.5 (0.7-2.0)	6.8±1.3 (5.0-8.3)	2.0±0.2 (1.7-2.5)	0.9±0.4 (0.3-1.5)

Table 3-6-2. Continued.

Name of Species	D	P	d	D/d	P/E	Ectoaperture			2f/D	Endoaperture		Apo. exine thickness	Septum thickness
						Length (2f)	Width (W)	2f/W		Length	Width		
<i>L. jamaicensis</i>	28.0±1.4 (25.1-29.7)	15.1±0.7 (14.0-16.3)	22.0±1.2 (19.5-23.3)	1.27	0.69	14.1±2.1 (9.1-16.5)	0.5±0.1 (0.3-0.8)	28.20	0.50	0.5±0.4 (0.3-1.7)	5.0±1.1 (3.3-6.6)	1.9±0.1 (1.8-2.1)	0.9±0.3 (0.3-1.3)
<i>L. macrophylla</i>	30.9±1.2 (28.4-33.0)	16.2±1.0 (14.7-17.5)	22.3±1.0 (21.5-24.1)	1.38	0.73	17.7±0.6 (16.5-18.2)	0.7±0.3 (0.5-1.2)	25.29	0.57	0.8±0.4 (0.5-1.7)	6.9±1.1 (5.0-8.3)	1.7±0.2 (1.5-2.1)	0.7±0.3 (0.3-1.3)
Section <i>Maria</i>													
<i>L. lucida</i>	33.8±0.9 (32.2-34.7)	17.8±1.2 (15.7-19.8)	24.6±0.5 (23.1-25.1)	1.37	0.72	19.2±2.8 (16.5-25.6)	0.8±0.3 (0.5-1.3)	24.00	0.57	1.1±0.6 (0.5-1.7)	5.6±1.9 (3.3-8.3)	1.9±0.3 (1.3-2.3)	2.0±0.7 (1.3-3.3)
Section <i>Pieridopsis</i>													
<i>L. ovalifolia</i> var. <i>elliptica</i>	32.5±1.5 (30.4-35.5)	16.8±0.8 (15.3-17.8)	24.8±1.5 (22.3-26.4)	1.31	0.68	15.3±1.4 (13.2-18.2)	1.3±0.6 (0.5-2.5)	11.77	0.47	1.1±0.7 (0.3-2.0)	6.1±1.7 (3.3-8.3)	1.7±0.2 (1.3-2.0)	0.7±0.2 (0.5-1.2)
<i>Pieris</i>													
Subgenus <i>Arcterica</i>													
<i>P. nana</i>	31.9±1.4 (30.0-34.6)	17.1±1.9 (14.9-20.6)	24.3±2.5 (21.1-30.0)	1.31	0.70	17.3±2.8 (13.9-21.6)	2.0±0.3 (1.7-2.4)	8.65	0.54	1.5±0.1 (1.4-1.7)	6.4±0.6 (5.8-7.2)	2.2±0.2 (1.9-2.4)	1.6±0.3 (1.2-1.9)
Subgenus <i>Pieris</i>													
Section <i>Pieris</i>													
<i>P. floribunda</i>	40.9±1.8 (38.0-43.7)	22.3±1.6 (18.2-23.5)	30.8±1.6 (28.3-32.6)	1.33	0.72	21.5±2.4 (16.3-24.5)	1.7±0.2 (1.4-1.9)	12.65	0.53	1.5±0.3 (1.2-1.9)	8.0±1.1 (5.8-9.1)	1.4±0.3 (1.0-1.9)	1.7±0.4 (1.0-1.9)
<i>P. formosa</i>	41.5±2.6 (37.2-45.6)	22.1±1.4 (19.9-27.7)	30.5±2.5 (27.8-34.8)	1.36	0.72	13.8±1.2 (12.5-16.8)	2.0±0.3 (1.4-2.4)	6.90	0.33	1.3±0.3 (1.0-1.7)	11.0±0.9 (10.1-12.0)	2.1±0.2 (1.9-2.4)	2.2±0.2 (1.9-2.4)
<i>P. japonica</i>	42.8±2.4 (39.3-46.2)	22.0±1.5 (19.5-24.4)	33.1±1.4 (31.4-36.0)	1.29	0.66	20.2±2.5 (16.5-24.8)	1.6±0.6 (0.7-2.5)	13.63	0.47	1.0±0.4 (0.5-1.7)	9.3±1.9 (6.6-13.2)	2.4±0.3 (2.1-3.0)	1.1±0.3 (0.7-1.5)
<i>P. koidzumiana</i>	39.3±2.1 (37.4-42.7)	21.4±1.6 (19.0-23.5)	29.7±1.5 (27.2-31.2)	1.32	0.72	16.9±2.8 (13.4-20.6)	1.6±0.5 (0.7-1.9)	10.56	0.43	1.3±0.6 (0.5-2.0)	7.5±0.9 (6.7-8.9)	2.6±0.3 (2.2-2.9)	1.7±0.2 (1.4-2.2)
Section <i>Phillyreoides</i>													
<i>P. cubensis</i>	39.3±1.2 (38.0-41.3)	20.8±1.0 (19.822.8)	30.7±1.2 (29.4-33.0)	1.28	0.68	18.6±1.4 (17.3-21.4)	0.6±0.1 (0.5-0.8)	31.0	0.47	1.4±0.4 (0.7-2.0)	9.2±1.2 (8.2-11.6)	2.3±0.3 (2.0-2.8)	0.7±0.2 (0.5-1.2)
<i>P. phillyreifolia</i>	48.6±1.6 (47.0-51.2)	24.3±2.0 (20.8-27.7)	35.6±2.2 (32.2-39.6)	1.37	0.68	29.0±2.8 (24.8-33.0)	0.7±0.3 (0.5-1.5)	41.43	0.60	3.0±0.4 (1.5-3.3)	7.9±1.2 (6.6-9.9)	1.9±0.5 (1.3-2.8)	1.0±0.4 (0.5-1.7)
Tribe Oxydendreae													
<i>Oxydendrum arboreum</i>	33.4±1.1 (32.2-35.3)	16.5±1.2 (13.7-18.0)	26.5±1.2 (24.8-28.1)	1.26	0.62	17.3±0.8 (16.5-18.2)	0.7±0.3 (0.5-1.3)	24.71	0.52	0.9±0.4 (0.5-1.7)	9.4±2.3 (6.6-13.2)	2.0±0.2 (1.7-2.2)	1.2±0.5 (0.3-1.7)
Tribe Vaccinieae													
<i>Agapetes bracteata</i>	37.9±1.5 (36.0-40.6)	18.9±0.9 (17.3-20.5)	28.5±1.1 (26.4-30.5)	1.33	0.66	17.9±1.0 (16.5-19.8)	1.7±1.0 (0.5-3.3)	10.53	0.47	1.8±0.9 (0.7-3.3)	9.4±1.2 (8.3-11.6)	1.7±0.3 (1.3-2.1)	0.9±0.3 (0.3-1.2)

Table 3-6-2. Continued.

Name of Species	D	P	d	D/d	P/E	Ectoaperture			2f/D	Endoaperture		Apo. exine thickness	Septum thickness
						Length (2f)	Width (W)	2f/W		Length	Width		
<i>A. lobbii</i>	49.7±2.3 (44.6-52.6)	26.4±2.4 (22.8-29.7)	36.7±1.5 (34.3-38.5)	1.35	0.72	30.7±2.1 (28.1-34.7)	0.7±0.3 (0.3-1.3)	43.86	0.62	2.2±0.7 (1.3-3.6)	9.2±1.0 (7.4-9.9)	3.0±0.3 (2.3-3.3)	1.2±0.3 (0.8-1.7)
<i>A. oblonga</i>	42.0±1.9 (39.6-46.2)	21.3±1.2 (19.0-22.8)	29.9±0.9 (28.1-31.4)	1.40	0.71	21.5±1.7 (18.2-23.1)	1.4±0.6 (0.5-2.3)	15.36	0.51	1.3±0.4 (0.8-1.7)	6.1±1.0 (5.0-6.6)	2.1±0.1 (2.0-2.3)	1.5±0.4 (1.0-2.0)
<i>Anthopterus verticillatus</i>	40.4±0.9 (39.3-41.6)	21.0±1.7 (19.0-23.9)	28.8±1.3 (26.4-31.0)	1.40	0.73	14.9±1.8 (12.4-17.3)	2.6±0.4 (2.0-3.3)	5.73	0.37	1.0±0.4 (0.5-1.7)	7.9±1.5 (6.6-11.6)	1.7±0.2 (1.5-2.0)	1.1±0.3 (0.5-1.7)
<i>Cavendishia adenophora.</i>	47.3±2.0 (43.6-49.5)	24.6±1.4 (21.8-26.1)	34.6±1.2 (33.0-36.5)	1.37	0.71	17.7±1.0 (17.0-19.8)	4.2±0.8 (3.0-5.0)	4.12	0.37	3.0±0.8 (1.7-4.1)	10.6±1.8 (8.3-13.2)	1.7±0.2 (1.3-2.0)	1.1±0.3 (0.5-1.5)
<i>C. bracteata</i>	47.2±2.2 (44.2-49.8)	24.7±2.4 (20.1-28.9)	34.6±1.1 (32.2-36.3)	1.40	0.71	18.6±2.9 (14.9-23.1)	3.3±1.0 (2.1-5.0)	5.64	0.39	3.1±1.0 (2.5-4.5)	8.9±2.6 (6.6-11.2)	1.9±0.4 (1.2-2.5)	1.5±0.4 (1.0-2.0)
<i>C. capitulata</i>	44.7±2.2 (41.6-47.9)	23.3±1.4 (19.8-24.8)	33.0±1.5 (30.5-34.7)	1.35	0.71	17.0±1.1 (16.5-19.8)	2.3±0.9 (1.2-4.1)	7.39	0.38	1.7±0.3 (1.7-2.5)	9.4±1.6 (6.6-11.6)	1.6±0.2 (1.3-2.0)	0.9±0.3 (0.5-1.3)
<i>C. divaricata</i>	47.3±2.3 (44.6-51.2)	23.8±1.5 (21.1-26.4)	34.5±1.8 (31.4-36.8)	1.37	0.69	21.1±2.0 (18.2-24.8)	2.4±1.2 (0.7-5.0)	8.79	0.45	1.6±0.4 (1.3-2.6)	9.4±1.6 (6.6-11.6)	1.9±0.4 (1.2-2.5)	0.6±0.2 (0.3-1.2)
<i>C. isernnii</i> var. <i>pseudospicata</i>	45.2±0.8 (44.2-46.5)	24.1±1.5 (21.6-26.4)	34.9±0.7 (33.8-36.3)	1.30	0.69	17.6±1.9 (14.5-20.6)	1.0±0.6 (0.5-2.5)	17.6	0.39	1.2±0.6 (0.5-2.5)	11.6±1.6 (9.1-13.2)	2.0±0.5 (1.5-3.0)	1.1±0.3 (0.5-1.5)
<i>C. marginata</i>	54.6±2.2 (52.0-59.4)	29.0±2.4 (25.6-33.0)	39.2±2.2 (36.3-44.6)	1.39	0.74	19.3±1.8 (16.5-22.3)	2.5±0.6 (1.8-3.8)	7.72	0.35	2.5±0.5 (1.7-3.3)	11.4±3.0 (8.3-16.5)	1.2±0.3 (0.7-1.8)	0.8±0.3 (0.3-1.2)
<i>C. pubescens</i>	45.9±1.5 (44.6-49.5)	23.4±1.0 (21.9-24.8)	36.5±0.8 (35.5-38.0)	1.26	0.64	15.9±1.3 (14.0-18.2)	2.5±0.5 (1.8-3.3)	6.36	0.35	2.2±0.6 (0.8-3.0)	9.3±1.1 (8.3-11.6)	1.8±0.4 (1.3-2.4)	0.8±0.3 (0.3-1.3)
<i>C. tarapotana</i> var. <i>gilgiana</i>	49.0±2.8 (44.6-52.0)	25.2±2.1 (22.3-28.9)	35.2±1.9 (33.0-38.0)	1.39	0.72	16.5±1.7 (14.9-18.2)	2.6±0.6 (2.2-3.3)	6.35	0.34	2.8±0.6 (2.2-3.3)	10.1±1.7 (8.3-11.6)	1.2±0.3 (0.8-1.5)	1.0±0.3 (0.7-1.3)
<i>Ceratostema lanigerum</i>	31.5±1.3 (29.7-33.0)	16.4±1.8 (14.0-20.1)	24.0±1.7 (21.5-26.4)	1.31	0.69	21.7±0.8 (20.6-23.1)	1.0±0.5 (0.5-1.7)	21.7	0.69	1.5±0.2 (1.3-1.7)	9.9±2.3 (8.3-11.6)	1.1±0.4 (0.5-1.7)	0
<i>C. loranthifolium</i>	29.9±1.5 (26.4-31.4)	15.3±1.2 (13.5-17.3)	21.9±0.9 (20.6-23.1)	1.37	0.70	20.7±0.9 (20.6-22.3)	1.0±0.6 (0.3-2.9)	20.7	0.69	1.2±1.0 (0.5-3.8)	9.4±2.4 (5.8-13.2)	1.5±0.3 (1.0-2.0)	0
<i>Costera endertii</i>	39.3±2.5 (37.2-42.7)	21.3±2.6 (18.5-24.0)	30.6±2.5 (27.4-33.1)	1.28	0.70	21.9±2.8 (18.7-25.9)	2.6±0.8 (1.9-3.8)	8.42	0.56	n.d.	n.d.	2.3±0.2 (1.9-2.4)	1.7±0.2 (1.4-1.9)
<i>Demostenesia mandonii</i>	48.7±2.8 (44.9-52.5)	25.5±0.9 (24.3-26.7)	32.5±2.2 (28.9-35.1)	1.40	0.78	34.6±3.0 (28.1-38.0)	1.1±0.6 (0.3-2.0)		0.76	1.6±0.7 (0.7-3.3)	9.2±2.9 (6.6-14.9)	1.8±0.3 (1.5-2.6)	1.0±0.5 (0.2-1.7)
<i>D. weberbaueri</i>	51.6±3.9 (45.9-58.2)	27.8±2.0 (24.9-31.0)	37.7±2.0 (34.7-41.2)	1.37	0.74	22.6±2.5 (19.8-24.8)	1.0±0.5 (0.5-1.5)		0.44	1.7±1.2 (0.5-3.0)	8.3±1.7 (6.6-9.9)	2.3±0.3 (2.0-2.8)	1.2±0.2 (0.8-1.7)
<i>Dimorphanthera collinsii</i> var. <i>montis-wilhelmi</i>	53.9±2.6 (49.2-57.8)	27.7±1.5 (25.1-29.7)	40.7±2.2 (36.3-46.6)	1.32	0.68	23.3±1.7 (19.8-24.8)	1.2±0.5 (0.5-1.7)		0.43	2.7±0.9 (1.3-4.1)	10.1±2.1 (6.6-13.2)	2.6±0.5 (1.8-3.5)	0.9±0.3 (0.3-1.3)
<i>D. leucostoma</i>	55.5±3.1 (51.2-60.7)	29.0±1.7 (26.4-32.7)	41.0±1.9 (38.0-44.6)	1.35	0.71	29.7±2.1 (26.4-33.0)	1.0±0.6 (0.5-2.0)		0.54	2.4±1.2 (0.5-4.1)	10.3±3.9 (3.0-16.5)	2.4±0.5 (2.0-3.0)	0.9±0.3 (0.5-1.3)

Table 3-6-2. Continued.

Name of Species	D	P	d	D/d	P/E	Ectoaperture			2f/D	Endoaperture		Apo. exine thickness	Septum thickness
						Length (2f)	Width (W)	2f/W		Length	Width		
<i>D. microphylla</i>	72.4±4.7 (64.4-79.2)	39.3±2.6 (34.7-42.9)	50.8±2.7 (47.9-56.1)	1.43	0.77	34.7±4.2 (28.1-41.3)	2.7±0.6 (1.8-3.5)	12.85	0.48	5.9±1.9 (3.3-9.9)	11.4±3.2 (3.3-14.9)	1.9±0.3 (1.3-2.3)	0.9±0.5 (0.3-1.7)
<i>Diogenesia floribunda</i>	41.4±1.1 (39.9-42.9)	21.6±0.8 (20.5-22.8)	32.0±0.7 (31.4-33.0)	1.29	0.68	23.0±1.2 (21.5-24.8)	1.5±0.7 (0.5-3.0)	15.33	0.56	1.3±0.2 (1.0-1.7)	9.2±2.0 (7.4-13.2)	2.5±0.4 (2.0-3.0)	1.1±0.3 (0.5-1.3)
<i>D. octandra</i>	36.9±2.1 (33.0-40.6)	19.9±1.0 (18.3-21.1)	27.7±1.5 (24.8-29.7)	1.33	0.72	19.0±0.7 (18.2-19.8)	1.8±0.8 (0.7-3.0)	10.56	0.51	1.4±0.7 (0.5-2.5)	7.5±2.1 (5.0-11.6)	1.8±0.2 (1.2-2.0)	1.0±0.3 (0.5-1.3)
<i>Disterigma acuminatum</i>	28.6±1.4 (26.7-31.8)	15.0±1.0 (13.5-16.7)	21.8±1.1 (19.3-23.1)	1.31	0.69	17.6±1.5 (15.7-19.8)	0.7±0.4 (0.3-1.7)	25.14	0.62	0.6±0.1 (0.5-0.8)	11.1±2.6 (6.6-14.9)	1.7±0.2 (1.3-2.0)	0.9±0.2 (0.7-1.2)
<i>D. alaternoides.</i>	51.2±1.5 (48.7-53.6)	26.9±2.2 (23.4-31.4)	36.2±2.5 (31.4-39.6)	1.41	0.74	29.2±2.6 (25.6-33.0)	1.1±0.4 (0.7-1.7)	26.55	0.57	0.6±0.4 (0.7-1.7)	10.5±3.4 (6.6-16.5)	2.8±0.4 (2.1-3.3)	2.6±0.9 (1.3-3.3)
<i>D. empetrifolium</i>	39.3±1.8 (36.3-41.9)	21.0±1.0 (19.8-22.8)	28.6±1.4 (26.4-30.5)	1.37	0.73	22.7±2.3 (19.8-26.4)	0.7±0.2 (0.5-1.2)	32.43	0.58	1.4±0.5 (0.7-2.5)	11.2±1.3 (9.9-13.2)	1.8±0.3 (1.0-2.1)	1.1±0.5 (0.3-1.7)
<i>D. humboldtii.</i>	44.1±2.1 (41.2-48.2)	23.8±1.1 (22.8-26.2)	32.6±1.0 (30.5-33.0)	1.35	0.73	26.7±2.0 (24.8-31.4)	1.6±0.5 (0.8-2.5)	16.69	0.61	1.7±0.4 (1.2-2.5)	12.0±2.3 (9.9-16.5)	2.2±0.4 (1.8-2.8)	1.0±0.2 (0.5-1.5)
<i>D. popenoei</i>	41.7±1.8 (38.8-44.2)	22.4±1.3 (19.8-24.4)	30.6±1.3 (28.4-33.0)	1.36	0.73	24.8±1.3 (23.1-27.2)	1.1±0.4 (0.5-1.7)	22.55	0.59	1.6±0.5 (0.8-2.1)	10.6±1.5 (8.3-11.6)	2.3±0.3 (2.0-2.6)	1.0±0.4 (0.5-1.7)
<i>Gaylussacia</i>													
Section <i>Decamerium</i>													
<i>G. baccata</i>	42.9±2.3 (38.8-46.2)	22.8±1.8 (20.5-25.4)	31.4±1.3 (29.7-33.3)	1.37	0.73	15.6±2.1 (12.4-18.2)	3.3±0.8 (2.1-4.6)	4.73	0.36	1.9±0.7 (0.8-3.3)	8.4±1.7 (5.0-9.9)	1.9±0.1 (1.7-2.0)	1.6±1.0 (0.7-3.3)
Section <i>Gaylussacia</i>													
<i>G. amoena</i>	46.1±2.3 (42.9-47.9)	24.6±1.5 (23.3-26.4)	36.3±1.3 (34.7-38.0)	1.27	0.68	19.8±1.2 (18.2-21.5)	1.7±0.6 (1.0-2.5)	11.65	0.43	1.9±1.0 (0.8-3.3)	6.4±0.9 (8.3-11.6)	2.6±0.3 (2.3-3.0)	0.9±0.4 (0.5-1.5)
<i>G. brasiliensis.</i>	47.8±3.9 (42.1-54.5)	24.6±1.1 (22.3-26.7)	35.2±1.6 (32.2-37.1)	1.36	0.70	20.8±2.1 (17.3-24.8)	2.5±0.9 (0.8-3.3)	8.32	0.44	2.0±1.0 (0.7-3.0)	8.1±1.2 (6.6-9.9)	2.0±0.2 (1.7-2.5)	1.6±0.5 (0.8-2.0)
<i>G. reticulata</i>	48.2±1.3 (46.2-49.5)	25.0±1.6 (23.1-26.4)	38.1±1.5 (36.3-40.4)	1.27	0.67	23.0±5.1 (19.0-33.0)	2.8±0.8 (1.3-3.5)	8.21	0.48	2.6±0.5 (2.0-3.3)	11.8±1.5 (9.9-13.2)	2.3±0.5 (1.8-3.0)	1.2±0.2 (1.0-1.3)
<i>G. virgata var. virgata</i>	41.4±2.2 (38.0-44.6)	21.1±0.9 (19.8-22.1)	32.2±1.6 (29.7-34.7)	1.29	0.66	18.3±1.8 (14.9-19.8)	1.6±0.3 (1.3-2.1)	11.44	0.44	1.7±0.4 (1.0-2.1)	10.4±2.5 (6.6-13.2)	2.4±0.2 (2.0-2.6)	1.0±0.4 (0.5-1.7)
<i>Gonocalyx smilacifolius</i>	35.2±3.1 (32.4-43.7)	19.4±1.4 (18.0-21.6)	26.6±0.9 (25.2-27.6)	1.32	0.73	20.0±2.1 (17.3-22.1)	1.8±0.6 (1.0-2.4)	11.11	0.57	2.1±0.7 (1.2-2.9)	8.5±0.8 (7.7-9.6)	2.1±0.4 (1.7-2.9)	1.3±0.4 (1.0-1.9)
<i>Macleania bullata</i>	48.5±1.5 (46.2-50.8)	24.5±2.2 (20.3-27.2)	35.6±1.1 (33.0-36.3)	1.36	0.69	31.4±2.3 (28.1-33.0)	2.1±0.6 (1.5-3.0)	14.95	0.65	2.4±0.8 (1.7-3.6)	10.2±1.5 (8.3-11.6)	1.9±0.2 (1.5-2.1)	0.9±0.3 (0.7-1.3)
<i>M. crassa</i>	64.8±5.8 (57.8-71.0)	34.0±3.5 (29.7-38.0)	48.0±3.7 (44.2-52.8)	1.35	0.71	n.d.	n.d.	n.d.	n.d.	n.d.	n.d.	1.6±0.4 (1.2-2.0)	1.1±0.4 (0.7-1.3)

Table 3-6-2. Continued.

Name of Species	D	P	d	D/d	P/E	Ectoaperture			2f/D	Endoaperture		Apo. exine thickness	Septum thickness
						Length (2f)	Width (W)	2f/W		Length	Width		
<i>M. portmanii</i>	46.8±1.1 (44.6-48.2)	23.6±1.4 (21.5-25.4)	34.4±1.9 (31.4-38.0)	1.36	0.69	28.6±2.7 (24.8-33.0)	1.2±0.7 (0.5-2.2)	23.83	0.61	2.1±0.7 (1.3-3.3)	7.3±1.5 (5.0-9.9)	1.8±0.2 (1.5-2.2)	0.9±0.2 (0.5-1.2)
<i>M. rupestris</i>	55.6±5.6 (43.2-61.4)	28.4±2.2 (23.9-31.4)	38.7±2.4 (33.8-41.6)	1.44	0.73	31.6±4.3 (24.8-41.3)	2.4±1 (0.8-4.1)	13.17	0.57	n.d.	n.d.	2.1±0.2 (1.8-2.3)	1.5±1.0 (0.3-2.5)
<i>Notopora schomburgkii</i>	53.7±3.1 (49.5-60.2)	26.7±2.0 (22.3-28.9)	40.1±2.7 (37.2-44.9)	1.37	0.67	34.0±2.2 (31.4-38.0)	3.5±0.7 (3.0-5.0)	9.71	0.63	2.5±0.9 (0.8-3.3)	12.2±2.1 (9.9-16.5)	3.0±0.5 (2.0-3.6)	1.1±0.4 (0.3-1.3)
<i>Orthaea abbreviata</i>	52.3±2.0 (50.3-56.1)	27.8±1.4 (26.1-29.7)	39.4±1.3 (37.1-41.3)	1.33	0.71	29.9±2.5 (24.8-33.0)	2.0±0.4 (1.5-2.8)	14.95	0.57	2.0±0.5 (1.7-3.0)	10.3±1.4 (8.3-13.2)	2.3±0.5 (1.8-3.3)	0.9±0.3 (0.5-1.3)
<i>O. secundiflora</i>	52.4±4.8 (42.3-59.4)	27.4±2.3 (24.8-31.4)	39.6±2.6 (34.7-42.9)	1.42	0.69	22.5±4.3 (13.2-28.1)	1.6±1.3 (0.3-4.6)	14.06	0.43	1.3±0.8 (0.3-2.5)	10.6±2.6 (8.3-14.9)	2.1±0.5 (1.7-3.0)	2.4±0.5 (1.7-3.3)
<i>Pellegrinia harmisiana</i>	41.3±2.1 (38.0-44.6)	23.1±1.7 (20.1-26.1)	28.1±2.1 (25.2-30.0)	1.47	0.82	28.1±1.1 (26.4-29.7)	0.4±0.1 (0.3-0.5)	70.25	0.68	0.7±0.5 (0.3-1.7)	8.6±1.1 (6.6-9.9)	1.7±0.2 (1.3-2.0)	1.1±0.2 (0.7-1.3)
<i>Plutarchia guascensis</i>	51.6±2.8 (46.2-56.1)	26.8±2.4 (23.1-29.7)	37.3±1.6 (34.7-39.6)	1.38	0.72	30.4±3.2 (24.8-33.0)	1.6±0.7 (0.8-3.0)	19.0	0.59	2.1±0.7 (0.8-3.3)	9.5±1.2 (8.3-11.6)	2.3±0.4 (1.7-3.0)	2.0±0.4 (1.7-2.5)
<i>P. rigida</i>	52.7±2.2 (48.8-56.1)	27.4±1.1 (26.1-29.7)	38.8±2.3 (34.7-42.9)	1.36	0.71	31.3±1.9 (28.1-33.8)	1.0±0.8 (0.3-3.0)	31.3	0.59	1.0±0.5 (0.3-1.7)	9.4±1.9 (7.4-13.2)	2.3±0.5 (1.7-3.0)	1.3±0.5 (0.7-2.2)
<i>Psammisia ecuadorensis</i>	50.4±2.9 (46.2-56.1)	27.0±1.6 (23.4-29.7)	36.5±1.5 (34.7-39.6)	1.38	0.71	32.4±1.6 (29.7-34.7)	1.5±0.6 (1.2-2.2)	21.6	0.64	1.8±0.6 (1.3-3.0)	10.0±1.7 (8.3-13.2)	2.1±0.3 (2.0-2.8)	0.8±0.5 (0.3-1.5)
<i>Satyria leucistoma</i>	41.3±1.3 (38.8-42.9)	21.2±1.3 (19.0-23.1)	31.4±1.2 (28.9-33.0)	1.32	0.68	15.2±1.5 (13.2-18.2)	1.0±0.3 (0.7-1.5)	15.2	0.37	0.9±0.5 (0.5-1.7)	7.2±2.1 (5.0-9.9)	2.2±0.4 (1.7-2.8)	1.2±0.3 (0.8-1.5)
<i>S. panurensis</i>	47.6±2.7 (42.2-51.2)	25.2±2.5 (21.5-31.0)	37.8±2.4 (34.7-42.9)	1.26	0.67	28.1±3.9 (21.5-31.5)	1.7±0.8 (0.7-2.5)	16.53	0.59	1.5±0.2 (1.3-1.7)	8.9±2.1 (6.6-11.6)	2.1±0.4 (1.7-3.0)	1.9±0.2 (1.7-2.0)
<i>S. pilosa</i>	43.7±1.7 (42.1-44.6)	22.9±1.9 (21.1-26.1)	33.0±1.8 (29.7-36.0)	1.32	0.69	23.0±1.6 (19.8-25.6)	1.8±0.7 (1.2-3.0)	12.78	0.53	2.2±0.7 (1.3-3.3)	9.7±1.9 (8.3-13.2)	1.7±0.2 (1.3-2.1)	1.1±0.4 (0.3-1.5)
<i>S. warszewiczii</i>	43.7±1.2 (41.9-45.9)	23.0±1.0 (20.6-24.4)	33.5±0.8 (32.7-34.7)	1.30	0.69	22.7±2.2 (18.2-25.6)	2.5±0.6 (1.7-3.3)	9.08	0.52	1.7±0.4 (0.8-2.5)	9.7±3.0 (8.3-16.5)	1.8±0.3 (1.5-2.5)	0.9±0.4 (0.3-1.3)
<i>Siphonandra elliptica</i>	54.4±1.8 (52.0-57.8)	27.7±1.7 (25.1-30.0)	35.4±1.6 (33.0-38.0)	1.54	0.78	38.6±3.1 (34.7-46.2)	2.3±0.9 (1.2-2.9)	16.78	0.71	n.d.	n.d.	2.0±0.3 (1.3-2.5)	1.4±0.3 (1.0-1.7)
<i>Spherospermum buxifolium</i>	31.6±1.6 (30.0-34.7)	16.3±1.5 (14.0-19.8)	24.2±1.3 (22.3-26.4)	1.31	0.67	13.4±1.2 (11.6-14.9)	1.3±0.3 (0.8-1.7)	10.31	0.42	1.3±0.6 (0.7-2.5)	7.4±2.7 (5.0-11.6)	1.5±0.3 (1.2-2.0)	1.3±0.3 (0.7-2.0)
<i>Themistoclesia cutucuensis</i>	33.6±1.5 (31.7-36.3)	16.9±0.6 (16.0-18.2)	25.4±1.1 (24.4-28.1)	1.32	0.67	19.1±1.5 (16.5-21.5)	1.0±0.4 (0.5-1.5)	19.1	0.53	0.6±0.3 (0.3-1.3)	7.4±1.2 (5.8-9.9)	2.0±0.1 (1.8-2.3)	0.9±0.2 (0.5-1.2)
<i>T. epiphytia</i>	32.8±2.3 (29.7-36.0)	17.8±1.4 (15.8-19.8)	25.1±1.2 (23.9-27.2)	1.31	0.71	16.2±2.7 (13.2-18.2)	2.4±1.6 (1.2-4.3)	6.75	0.49	0.9±0.3 (0.7-1.3)	10.7±2.1 (8.3-13.2)	1.7±0.3 (1.3-2.0)	1.3±0.2 (1.2-1.7)
<i>T. mucronata.</i>	38.1±2.1 (35.1-41.7)	19.5±1.1 (18.2-21.4)	28.8±0.8 (28.1-29.7)	1.32	0.68	21.1±1.9 (19.3-24.8)	2.3±0.9 (1.3-3.6)	9.17	0.55	0.7±0.4 (0.5-1.3)	10.4±2.7 (7.4-14.9)	1.9±0.2 (1.7-2.5)	1.4±0.3 (1.0-2.0)

Table 3-6-2. Continued.

Name of Species	D	P	d	D/d	P/E	Ectoaperture			2f/D	Endoaperture		Apo. exine thickness	Septum thickness
						Length (2f)	Width (W)	2f/W		Length	Width		
<i>Thibaudia albiflora</i>	44.9±2.1 (43.1-47.9)	22.5±1.8 (19.5-26.1)	35.6±1.3 (34.7-38.0)	1.26	0.63	19.6±1.9 (16.5-21.5)	1.5±0.6 (0.7-2.8)	13.07	0.44	1.3±0.6 (0.7-2.9)	9.3±2.3 (6.6-13.2)	2.4±0.5 (1.1-3.0)	1.2±0.2 (0.7-1.5)
<i>T. angustifolia</i>	66.1±4.0 (61.9-75.1)	34.4±2.6 (31.4-39.6)	45.6±1.6 (44.2-49.5)	1.45	0.75	42.4±3.6 (34.7-47.9)	1.2±0.5 (0.5-2.0)	35.33	0.64	1.8±0.8 (0.5-3.3)	12.0±2.9 (8.3-16.5)	2.2±0.4 (1.8-3.0)	0.8±0.3 (0.3-1.3)
<i>T. domingensis</i>	45.2±2.0 (42.9-49.5)	22.7±1.5 (20.6-25.6)	32.9±1.4 (31.4-36.9)	1.37	0.69	21.2±1.8 (18.2-23.1)	2.3±1.4 (1.2-5.8)	9.22	0.47	1.7±0.7 (0.8-3.3)	9.5±1.8 (6.6-11.6)	2.3±0.5 (1.7-3.0)	0.8±0.2 (0.5-1.2)
<i>T. floribunda</i>	55.3±3.5 (51.2-62.7)	28.6±2.5 (25.1-33.0)	41.3±1.3 (38.8-42.9)	1.34	0.69	24.7±1.6 (21.5-26.4)	1.8±0.5 (1.2-2.5)	13.72	0.45	2.2±0.9 (1.3-3.3)	5.6±2.5 (2.5-8.3)	2.1±0.3 (1.7-2.5)	1.4±0.4 (1.2-1.7)
<i>T. parvifolia</i>	Sneidern 1864 60.2±3.2 (52.8-64.4)	31.8±1.9 (29.7-33.8)	43.3±2.6 (38.0-46.2)	1.39	0.73	41.3±3.0 (38.0-46.2)	2.1±1.1 (0.5-3.8)	19.67	0.69	1.5±1.0 (0.7-3.8)	11.0±2.7 (6.6-14.9)	1.8±0.2 (1.5-2.1)	0.7±0.3 (0.3-1.3)
	Harling & Andersson 12242 66.3±3.5 (61.1-72.6)	35.0±3.0 (31.4-39.6)	49.1±2.3 (46.2-53.1)	1.35	0.71	39.6±1.3 (38.0-41.3)	1.0±0.4 (0.5-1.7)	39.6	0.60	2.6±1.3 (0.8-5.0)	10.7±2.5 (8.3-16.5)	3.3±0.4 (2.5-4.0)	1.1±0.4 (0.3-1.7)
<i>Vaccinium</i>													
Section <i>Batodendron</i>													
<i>V. cubense</i>	49.2±2.4 (46.2-52.8)	26.0±1.4 (24.3-28.1)	37.2±1.7 (35.5-41.2)	1.32	0.70	29.0±2.3 (24.8-33.0)	1.5±0.5 (0.7-2.4)	19.33	0.59	2.5±0.7 (1.7-3.3)	10.3±4.4 (6.6-19.8)	2.3±0.4 (2.0-3.0)	2
Section <i>Bracteata</i>													
<i>V. bracteatum</i>	34.3±2.7 (31.2-38.4)	19.1±1.8 (18.7-21.1)	25.3±3.3 (23.0-31.2)	1.36	0.75	15.4±2.0 (12.5-18.0)	1.6±0.7 (1.2-2.9)	9.63	0.45	n.d.	n.d.	2.5±0.2 (2.4-2.9)	2.4±0.7 (2.0-3.4)
<i>V. randaiense</i>	39.0±1.8 (36.0-41.3)	20.8±1.7 (19.2-24.0)	29.2±1.2 (27.8-31.2)	1.34	0.71	18.4±2.5 (13.6-21.6)	2.4±0.4 (1.9-2.9)	7.67	0.47	n.d.	n.d.	2.3±0.5 (1.4-2.9)	1.6±0.5 (1.2-2.9)
<i>V. wrightii</i>	40.2±2.0 (36.6-42.7)	21.2±1.9 (18.7-24.7)	30.8±1.3 (28.8-32.6)	1.31	0.69	17.5±1.3 (16.3-20.6)	2.1±0.5 (1.4-2.9)		0.44	n.d.	n.d.	2.3±0.3 (1.9-2.9)	1.8±0.3 (1.4-2.4)
Section <i>Ciliata</i>													
<i>V. oldhamii</i>	43.3±3.2 (40.8-50.4)	22.5±4.0 (16.3-30.0)	30.2±3.0 (26.4-36.0)	1.43	0.75	21.3±4.8 (10.8-24.5)	2.7±1.0 (1.4-4.3)	7.89	0.49	n.d.	n.d.	1.9±0.4 (1.4-2.4)	2.3±0.4 (1.9-2.9)
Section <i>Conchophyllum</i>													
<i>V. emarginatum</i>	42.5±2.5 (38.4-47.0)	24.5±4.3 (19.7-30.7)	31.2±3.6 (22.8-36.0)	1.36	0.79	19.5±2.2 (14.4-21.8)	1.7±0.6 (1.0-2.9)	11.47	0.46	n.d.	n.d.	2.3±0.3 (1.9-2.6)	1.5±0.4 (1.2-2.4)
Section <i>Cyanococcus</i>													
<i>V. corymbosum</i>	Utech et al. 83-050 43.3±2.9 (39.4-48.0)	22.6±0.8 (21.1-23.5)	31.3±1.4 (29.8-33.1)	1.38	0.72	21.0±5.1 (14.4-28.8)	3.0±0.9 (1.9-4.3)	7.0	0.48	n.d.	n.d.	2.8±0.6 (1.9-3.6)	1.9±0.4 (1.4-2.4)
	Spon. & Bouf. 1764 45.7±2.5 (41.8-48.0)	26.0±2.4 (23.4-28.1)	34.9±3.0 (32.4-38.4)	1.31	0.74	16.2±3.3 (13.9-21.1)	2.0±0.5 (1.4-2.6)	8.1	0.35	n.d.	n.d.	2.3±0.3 (1.9-2.6)	1.9±0.4 (1.4-2.4)
<i>V. myrsinites</i>	41.2±2.5 (36.5-44.6)	21.7±2.2 (18.2-24.8)	31.1±1.1 (29.5-33.0)	1.32	0.70	20.7±2.1 (17.3-24.0)	2.4±0.6 (1.3-3.0)	8.63	0.50	1.5±0.5 (0.8-2.5)	8.9±2.3 (6.6-13.2)	1.5±0.2 (1.3-1.8)	0.8±0.3 (0.3-1.3)

Table 3-6-2. Continued.

Name of Species	D	P	d	D/d	P/E	Ectoaperture			2f/D	Endoaperture		Apo. exine thickness	Septum thickness
						Length (2f)	Width (W)	2f/W		Length	Width		
<i>V. myrtilloides</i>	38.4±2.4 (34.7-42.6)	20.5±1.2 (18.2-22.1)	28.7±1.3 (26.4-30.0)	1.34	0.71	21.3±2.4 (18.2-24.8)	1.3±0.3 (0.7-1.8)	16.38	0.55	1.2±0.4 (0.7-1.7)	8.9±1.8 (6.6-11.6)	2.0±0.3 (1.7-2.5)	0.7±0.2 (0.3-1.2)
<i>V. pallidum</i>	42.4±1.9 (39.6-45.2)	22.8±1.7 (20.4-25.4)	31.7±1.6 (29.3-34.1)	1.34	0.72	17.3±3.4 (12.0-23.0)	2.3±0.6 (1.4-3.4)	7.52	0.41	n.d.	n.d.	2.3±0.5 (1.4-2.9)	1.5±0.4 (1.0-1.9)
Section <i>Eococcus</i>													
<i>V. leucanthum</i>	44.8±4.2 (36.3-49.2)	21.3±2.4 (18.2-25.4)	33.3±3.2 (28.1-38.0)	1.34	0.64	19.0±2.1 (16.8-21.5)	1.8±0.4 (1.3-2.4)	10.56	0.42	1.3±0.6 (0.5-2.0)	9.1±3.2 (5.0-11.6)	2.3±0.5 (1.7-3.0)	1.3±0.2 (1.2-1.7)
<i>V. meridionale</i>	45.5±2.2 (40.6-49.5)	24.1±2.5 (21.5-29.7)	35.4±1.9 (32.2-38.0)	1.29	0.68	24.4±1.9 (19.8-26.4)	1.1±0.8 (0.3-2.8)	22.18	0.54	1.9±0.3 (0.7-2.8)	9.2±3.2 (5.0-13.2)	2.6±0.5 (2.0-3.3)	1.1±0.2 (0.5-1.3)
<i>V. sprengelii</i>	40.1±1.0 (38.8-41.3)	20.0±1.5 (18.5-21.9)	32.4±0.9 (31.4-33.3)	1.24	0.62	18.9±1.5 (16.5-21.5)	1.3±0.8 (0.5-2.5)	14.54	0.47	0.9±0.3 (0.5-1.3)	7.2±1.2 (5.0-8.3)	2.4±0.3 (2.0-3.0)	0.9±0.4 (0.3-1.3)
Section <i>Epigynium</i>													
<i>V. vacciniaceum</i>	42.6±1.9 (39.8-46.6)	23.4±2.7 (18.7-26.9)	30.1±2.3 (25.4-32.2)	1.42	0.78	22.8±3.9 (18.0-28.8)	2.0±0.4 (1.4-2.4)	11.4	0.54	n.d.	n.d.	2.0±0.4 (1.4-2.6)	1.4±0.3 (1.0-1.9)
Section <i>Hemimyrtillus</i>													
<i>V. hirtum</i>	33.1±2.0 (29.3-36.0)	17.1±2.7 (12.5-20.4)	24.3±2.2 (20.2-27.6)	1.36	0.70	18.6±2.8 (14.4-22.8)	2.1±0.5 (1.2-2.9)	8.86	0.56	n.d.	n.d.	1.8±0.4 (1.2-2.4)	1.7±0.4 (1.4-2.4)
<i>V. smallii</i>	Takahashi 24491 43.9±1.6 (42.2-47.0)	23.1±1.4 (21.2-25.0)	35.0±1.9 (32.6-38.0)	1.25	0.66	22.1±3.8 (15.6-25.9)	2.3±0.4 (1.4-2.9)	9.61	0.50	n.d.	n.d.	2.2±0.3 (1.9-2.6)	1.3±0.3 (1.0-1.9)
<i>Kikuchii s.n.</i>	36.3±2.2 (32.6-39.6)	18.6±1.5 (16.8-21.1)	26.5±2.0 (23.8-31.2)	1.37	0.70	21.1±3.0 (18.2-27.6)	1.4±0.4 (1.0-2.2)	15.07	0.58	n.d.	n.d.	2.1±0.4 (1.4-2.9)	2.2±0.3 (1.7-2.6)
Section <i>Herpothamnus</i>													
<i>V. crassifolium</i>	35.7±2.3 (31.7-38.9)	20.5±2.6 (18.7-23.5)	25.1±2.3 (22.1-29.3)	1.42	0.83	14.5±1.9 (13.7-18.2)	1.7±0.3 (1.2-2.9)	8.53	0.41	n.d.	n.d.	2.1±0.3 (1.7-2.9)	1.8±0.6 (1.6-2.4)
Section <i>Macropelma</i>													
<i>V. calycinum f. glabreccens</i>	42.1±1.3 (39.6-43.9)	21.7±0.8 (20.6-23.1)	30.6±1.5 (28.1-33.0)	1.38	0.71	23.0±1.7 (19.8-24.8)	1.5±0.4 (0.7-2.0)	15.33	0.54	1.3±0.7 (0.3-2.5)	8.0±1.6 (5.0-9.9)	1.9±0.2 (1.7-2.4)	0.7±0.3 (0.3-1.3)
Section <i>Myrtillus</i>													
<i>V. caespitosum</i>	36.4±4.2 (31.2-41.8)	16.4±4.5 (12.0-21.6)	25.5±1.7 (24.0-28.6)	1.43	0.64	14.0±1.8 (12.0-15.6)	2.0±0.1 (1.9-2.2)	7.0	0.38	n.d.	n.d.	2.2±0.3 (1.9-2.4)	1.4±0.1 (1.2-1.4)
<i>V. myrtillus</i>	38.4±2.5 (36.0-42.7)	19.1±2.7 (15.6-22.1)	28.1±2.6 (23.0-30.2)	1.37	0.68	18.3±1.2 (16.8-20.2)	2.6±0.5 (1.9-3.0)	7.04	0.48	n.d.	n.d.	2.2±0.4 (1.9-2.9)	1.3±0.3 (1.0-1.7)
<i>V. ovalifolium</i>	39.0±4.5 (30.0-44.4)	21.8±2.3 (19.2-25.2)	29.1±1.4 (26.4-31.7)	1.34	0.75	17.1±1.8 (14.4-20.2)	2.2±0.6 (1.4-3.1)	7.77	0.44	n.d.	n.d.	1.9±0.3 (1.4-2.4)	2.0±0.4 (1.4-2.6)
<i>V. parvifolium</i>	44.1±2.9 (38.4-46.8)	24.7±2.3 (21.6-27.8)	31.0±1.4 (28.3-31.4)	1.42	0.80	18.7±2.8 (15.4-24.2)	2.3±0.2 (2.2-2.6)	8.13	0.42	n.d.	n.d.	2.6±0.3 (2.4-3.2)	2.0±0.4 (1.4-2.4)

Table 3-6-2. Continued.

Name of Species	D	P	d	D/d	P/E	Ectoaperture			2f/D	Endoaperture		Apo. exine thickness	Septum thickness	
						Length (2f)	Width (W)	2f/W		Length	Width			
Section <i>Oxycoccoides</i>														
<i>V. japonicum</i>	32.5±1.2 (30.7-34.1)	15.7±1.6 (13.9-18.2)	24.5±1.3 (21.6-26.4)	1.33	0.70	20.2±3.0 (13.2-24.0)	2.3±0.7 (1.4-3.6)	8.78	0.62	n.d.	n.d.	2.2±0.3 (1.4-2.4)	1.9±0.3 (1.4-2.4)	
Section <i>Oxycoccus</i>														
<i>V. macrocarpon</i>	37.0±1.7 (34.7-39.6)	18.7±0.9 (17.3-20.1)	27.5±1.1 (25.9-29.4)	1.35	0.68	26.0±2.1 (23.1-29.7)	1.6±0.3 (1.0-2.0)	16.25	0.70	1.9±0.4 (1.7-3.0)	8.6±2.9 (6.6-14.9)	1.9±0.2 (1.7-2.5)	0.9±0.4 (0.5-1.3)	
<i>V. oxycoccus</i>	46.1±2.5 (42.0-49.9)	24.9±3.4 (20.4-30.0)	32.3±2.2 (28.8-35.0)	1.43	0.77	20.7±3.5 (16.8-26.4)	2.0±0.3 (1.4-2.4)	10.35	0.45	n.d.	n.d.	3.0±0.5 (2.4-3.8)	2.2±0.3 (1.9-2.6)	
Section <i>Polycodium</i>														
<i>V. stamineum</i>	42.6±2.4 (38.4-46.1)	23.3±1.9 (20.6-25.0)	30.4±1.5 (28.6-32.6)	1.40	0.77	21.9±0.9 (20.9-23.5)	2.3±0.3 (1.9-2.9)	9.52	0.51	n.d.	n.d.	2.1±0.3 (1.7-2.4)	2.4±0.6 (1.4-3.4)	
Section <i>Praestantia</i>														
<i>V. praestans</i>	34.3±1.7 (30.7-36.0)	17.9±2.7 (13.9-23.5)	25.1±1.6 (21.6-26.9)	1.37	0.71	16.4±2.7 (14.9-19.2)	1.7±0.8 (1.2-1.9)	9.65	0.48	n.d.	n.d.	2.0±0.3 (1.7-2.4)	1.2±0.3 (1.0-1.7)	
Section <i>Pyxothamnus</i>														
<i>V. consanguineum</i>	46.6±1.2 (45.2-48.7)	23.5±1.4 (20.6-24.8)	35.8±0.6 (34.7-36.3)	1.30	0.66	25.9±2.3 (23.1-29.7)	2.4±0.8 (1.2-3.3)	10.79	0.55	2.1±0.7 (1.3-3.3)	9.2±1.2 (8.3-11.6)	3.3±0.4 (2.7-3.8)	1.0±0.4 (0.5-1.3)	
<i>V. floribundum</i> var. <i>floribundum</i>	38.3±1.3 (36.3-40.4)	20.0±0.7 (18.8-21.1)	28.5±1.3 (26.4-30.0)	1.34	0.70	21.9±3.3 (14.9-28.1)	0.9±0.3 (0.5-1.3)	24.33	0.57	1.6±0.9 (0.5-3.3)	8.6±2.7 (5.0-14.8)	1.7±0.3 (1.2-2.4)	0.9±0.3 (0.5-1.2)	
<i>V. ovatum</i>	36.9±2.1 (33.1-40.3)	18.8±1.8 (15.6-21.6)	28.1±1.8 (26.4-31.2)	1.31	0.67	18.0±1.8 (14.4-20.6)	2.3±0.8 (1.4-4.0)	7.83	0.49	1.6±1.1 (1.0-2.9)	8.0±1.4 (7.2-9.6)	1.7±0.2 (1.4-1.9)	1.2±0.3 (1.4-1.7)	
Section <i>Uliginosa</i>														
<i>V. uliginosum</i>	Takahashi 9864	35.7±2.1 (33.3-37.5)	19.9±1.1 (18.6-20.7)	26.8±1.1 (26.1-28.1)	1.33	0.74	22.2±2.3 (19.5-24.8)	2.2±0.6 (1.7-3.0)	10.09	0.62	2.4±0.8 (1.7-3.3)	5.5±1.0 (5.0-6.6)	1.7±0.3 (1.5-2.0)	0.6±0.1 (0.5-0.7)
		Takahashi 9908	41.2±1.2 (39.6-42.6)	21.2±1.5 (19.5-22.6)	30.6±1.0 (29.7-31.5)	1.35	0.69	23.4±2.5 (19.8-27.2)	2.0±0.7 (1.3-3.0)	11.7	0.57	0.9±0.3 (0.5-1.3)	8.0±1.9 (5.0-9.9)	1.7±0.2 (1.5-2.0)
Section <i>Vitis-Idaea</i>														
<i>V. vitis-idaea</i>	35.9±1.6 (33.5-38.0)	18.0±1.0 (16.8-19.8)	27.0±1.2 (24.8-28.4)	1.33	0.67	21.9±1.5 (18.2-23.9)	1.3±0.3 (1.2-1.7)	16.85	0.61	1.3±0.6 (0.3-2.5)	7.0±2.6 (5.0-13.2)	2.0±0.2 (1.7-2.5)	0.6±0.2 (0.5-1.0)	
Section <i>not known</i>														
<i>V. donianum</i>	37.5±1.6 (35.0-41.9)	18.9±1.3 (17.0-21.5)	29.5±0.9 (27.9-31.0)	1.27	0.64	20.4±1.9 (17.3-23.1)	2.0±0.9 (0.7-3.5)	10.2	0.54	1.3±0.6 (0.5-2.1)	9.9±2.8 (6.6-13.2)	1.9±0.2 (1.7-2.2)	1.1±0.3 (0.5-1.2)	

D: tetrad diameter, P: polar length, d(E): equatorial diameter, Apo.: apocolpium, n.d.: not discerned, minimum–maximum value in μm in parenthesis.

Pollen morphology of tribe Vaccinieae [32 genera / 22 genera examined: *Anthopterus*, *Cavendishia*, *Ceratostema*, *Costera*, *Demosthenesia*, *Dimorphanthera*, *Diogenesis*, *Disterigma*, *Gaylussacia*, *Gonocalyx*, *Macleania*, *Notopora*, *Orthaea*, *Pellegrinia*, *Plutarchia*, *Psammisia*, *Satyria*, *Siphonandra*, *Sphyrospermum*, *Themistoclesia*, *Thibaudia* and *Vaccinium* (including *Agapetes*)]

Agapetes [?? spp. / 3 spp. examined: *A. bracteata*, *A. lobbii* and *A. oblonga*]

Pollen grains are in tetrahedral tetrad; viscin thread absent; D 37.9 – 49.7 μm , P 18.9 – 26.4 μm , E 28.5 – 36.7 μm , D/d 1.33 – 1.40, P/E 0.66 – 0.72, oblate; 3-colporate, 2f 17.9 – 30.7 μm , W 0.7 – 1.7 μm , 2f/W 10.53 – 43.86, 2f/D 0.47 – 0.62, significantly wider at middle, acute towards end, colpus margin distinct, costae present; endocracks absent or indistinct, but distinct in *A. lobbii*; endoaperture lalongate or indistinct in *A. oblonga*, 1.3 – 2.2 μm long, 6.1 – 9.4 μm wide; apocolpial exine 1.7 – 3.0 μm thick, septum 0.9 – 1.5 μm thick, tectate; exine sculpture from verrucate to rugulate or finely verrucate to finely rugulate.

In SEM, 1) pollen surface is flat, primary apocolpial exine sculpture indistinct, secondary sculpture fine short striate with verrucae (Type FS; Fig. 3-31 D); or 2) surface somewhat flat, primary exine sculpture psilate, covered with secondary striate sculpture (Type PS; Fig. 3-31 G); or 3) exine sculpture coarsely rugulate-psilate, intermediate type (RS/R; Fig. 3-31 F); colpus membrane granuloid or indistinct.

Anthopterus [11 spp. / 1 sp. examined: *A. verticillatus*]

Pollen grains are in tetrahedral tetrad but many tetrads in different configurations; viscin thread absent; D 40.4 μm , P 21.0 μm , E 28.8 μm , D/d 1.40, P/E 0.73, oblate; 3-colporate, 2f 14.9 μm , W 2.6 μm , 2f/W 5.73, 2f/D 0.37, significantly wider at middle, acute towards end, colpus margin distinct, costae present; endocracks absent or indistinct; endoaperture lalongate, 1.0 μm long, 7.9 μm wide; apocolpial exine 1.7 μm thick, septum 1.1

µm thick, tectate; exine sculpture from verrucate to rugulate or finely verrucate to finely rugulate.

The pollen of *A. verticillatus* could not be studied due to unavailability of grains on SEM stub.

Cavendishia [130 spp. / 8 spp. examined: *C. adenophora*, *C. bracteata*, *C. capitulata*, *C. divaricata*, *C. isernnii*, *C. marginata*, *C. pubescens* and *C. tarapotana* var. *gilgiana*]

Pollen grains are in both normal and compact tetrahedral tetrad, sometimes in other configurations, often 1 or 2 grains shrink in *C. bracteata*, all grains somewhat shrink in *C. marginata* and *C. tarapotana* var. *gilgiana*; viscin thread absent; D 44.7 – 54.6 µm, P 23.3 – 29.0 µm, E 33.0 – 39.2 µm, D/d 1.26 – 1.40, P/E 0.64 – 0.74, oblate; 3-colporate, 2f 15.9 – 21.1 µm, W 1.0 – 4.2 µm, 2f/W 4.12 – 17.6, 2f/D 0.34 – 0.45, significantly wider at middle, acute towards end, colpus margin distinct, costae present but sometimes indistinct; endocracks commonly absent or indistinct, but sometimes distinct; endoaperture lalongate, tip often indistinct in *C. bracteata*, 1.2 – 3.1 µm long, 8.9 – 11.6 µm wide; apocolpial exine 1.2 – 2.0 µm thick, septum 0.6 – 1.5 µm thick, perforated in *C. capitulate*; tectate, exine sculpture from verrucate to rugulate or psilate.

In SEM, 1) pollen surface is uneven and rugged to somewhat flat, primary apocolpial exine sculpture moderate to coarsely rugulate-psilate, the rugulae with minute (diam. < 0.2 µm) striate (Type RS; Figs. 3-31 K – M, O, 3-32 A – D); or 2) surface somewhat flat, primary exine sculpture intermediate type, secondary sculpture unit beaded striate (R/P; Fig. 3-32 F); colpus membrane granuloid to smooth, sometimes granulate.

In TEM for *C. capitulata* and *C. marginata*, the apocolpial exine is composed of ectexine and endexine (Fig. 3-32 G, J). Sexine is ca. 0.4 µm thick and a total exine is ca. 0.90 – 1.1 µm thick (Fig. 3-32 H, K). Although the total exine is thicker in *C. marginata*, the

tectum and the endexine are relatively thinner compared to that of *C. capitulata*. The septum is ca. 0.6 – 1.3 μm thick (Fig. 3-32 I, L). Intine is almost evenly thick around the pollen tetrad.

Ceratostema [35 spp. / 2 spp. examined: *C. lanigerum* and *C. loranthifolium*]

Pollen grains are in compact tetrahedral tetrad; viscin thread absent; D 29.9 – 31.5 μm , P 15.3 – 16.4 μm , E 21.9 – 24.0 μm , D/d 1.31 – 1.37, P/E 0.69 – 0.70, oblate; 3-colporate, 2f 20.7 – 21.7 μm , W 1.0 μm , 2f/W 20.7 – 21.7, 2f/D 0.69, wider at middle, acute towards end, colpus margin distinct, costae present; endocracks absent or indistinct; endoaperture lalongate, 1.2 – 1.5 μm long, 9.4 – 9.9 μm wide; apocolpial exine 1.1 – 1.5 μm thick, septum absent; tectate, exine sculpture from verrucate to rugulate, apocolpium and margin of colpi psilate and mesocolpium rugulate in *C. lanigerum*.

In SEM, 1) pollen surface is surface somewhat flat, primary apocolpial exine sculpture coarsely rugulate-psilate (R/P; Fig. 3-33 D); 2) surface uneven and rugged, exine sculpture coarsely rugulate, the rugulae with minute (diam. < 0.2 μm) striate (Type RS; Fig. 3-33 F); colpus membrane variable.

Both species of *Ceratostema* are studied with TEM. The apocolpial exine is composed of ectexine and endexine (Fig. 3-33 G – H). Sexine is ca. 0.5 – 0.6 μm thick, and a total exine is ca. 1.0 μm thick (e.g., Fig. 3-33 I). The septum is lacking (Fig. 3-33 G – H). Intine is almost evenly thick around the pollen tetrad, but sometimes comparatively thicker near the vestigial septal exine.

Costera [9 spp. / 1 sp. examined: *C. endertii*]

Pollen grains are in compact tetrahedral tetrad, one grains of tetrad small or little shrinks; viscin thread absent; D 39.3 μm , P 21.3 μm , E 30.6 μm , D/d 1.28, P/E 0.70, oblate; 3-colporate, 2f 21.9 μm , W 2.6 μm , 2f/W 8.42, 2f/D 0.56, significantly wider at middle, acute towards end, colpus margin distinct, costae present; endocracks present and distinct;

endoaperture lalongate, slit like, sometime more than one (2 or 3); apocolpial exine 2.3 μm thick, septum 1.7 μm thick; tectate, exine sculpture coarsely rugulate.

In SEM, pollen surface is uneven and rugged, primary apocolpial exine sculpture coarsely rugulate-psilate, the rugulae with moderate (diam. $> 0.2 \mu\text{m}$) striate, intermediate type (RSG/MG; Fig. 3-34 B); colpus membrane variable.

Demostenesia [11 spp. / 2 spp. examined: *D. mandonii* and *D. weberbaueri*]

Pollen grains are in lobed tetrahedral tetrad, grains often broken in *D. weberbaueri*; viscin thread absent; D 48.7 – 51.6 μm , P 25.5 – 27.8 μm , E 32.5 – 37.7 μm , D/d 1.37 – 1.40, P/E 0.74 – 0.78, oblate; 3-colporate, 2f 22.6 – 34.6 μm , W 1.0 – 1.1 μm , 2f/W 22.6 – 31.45, 2f/D 0.44 – 0.76, wider at middle, acute towards end, colpus margin distinct, costae present but indistinct in *D. weberbaueri*; endocracks absent or indistinct; endoaperture lalongate, 1.6 – 1.7 μm long, 8.3 – 9.2 μm wide; apocolpial exine 1.8 – 2.3 μm thick, septum 1.0 – 1.2 μm thick; tectate, exine sculpture from verrucate to rugulate or rugulate.

In SEM, 1) pollen surface is uneven and rugged to flat, primary apocolpial exine sculpture coarsely rugulate-psilate, intermediate type (RS/R; Fig. 3-34 E), or the rugulae with minute (diam. $< 0.2 \mu\text{m}$) striate (Type RS; Figs. 3-34 F – G); colpus membrane variable.

Dimorphanthera [85 spp. / 3 spp. examined: *D. collinsii* var. *montis-wilhelmi*, *D. leucostoma* and *D. microphylla*]

Pollen grains are in both normal and compact tetrahedral tetrad, all grains somewhat shrink in *D. microphylla*; viscin thread absent; D 53.9 – 72.4 μm , P 27.7 – 39.3 μm , E 40.7 – 50.8 μm , D/d 1.32 – 1.43, P/E 0.68 – 0.77, commonly oblate, but suboblate in *D. microphylla*; 3-colporate, 2f 23.3 – 34.7 μm , W 1.0 – 2.7 μm , 2f/W 12.85 – 29.7, 2f/D 0.43 – 0.54, significantly wider at middle, acute towards end, colpus margin distinct, costae present; endocracks present; endoaperture lalongate, 2.4 – 5.9 μm long, 10.1 – 11.4 μm wide;

apocolpial exine 1.9 – 2.6 μm thick, septum 0.9 μm thick; tectate, exine sculpture from verrucate to rugulate or coarsely rugulate.

In SEM, pollen surface is uneven and rugged, primary apocolpial exine sculpture coarsely rugulate-psilate, the rugulae with very minute (diam. $< 0.1 \mu\text{m}$) striate, intermediate type (RS/R; Figs. 3-34 I, K – L); colpus membrane granulate or granuloid.

Diogenesia [13 spp. / 2 spp. examined: *D. floribunda* and *D. octandra*]

Pollen grains are in compact tetrahedral tetrad (Fig. 3-34 M); viscin thread absent; D 36.9 – 41.4 μm , P 19.9 – 21.6 μm , E 27.7 – 32.0 μm , D/d 1.29 – 1.33, P/E 0.68 – 0.72, oblate; 3-colporate, 2f 19.0 – 23.0 μm , W 1.5 – 1.8 μm , 2f/W 10.56 – 15.33, 2f/D 0.51 – 0.56, significantly wider at middle, acute towards end, colpus margin distinct, costae present but indistinct in *D. octandra*; endocracks present; endoaperture lalongate, 1.3 – 1.4 μm long, 7.5 – 9.2 μm wide; apocolpial exine 1.8 – 2.5 μm thick, septum 1.0 – 1.1 μm thick; tectate, exine sculpture from verrucate to rugulate or coarsely rugulate.

In SEM, the pollen of any *Diogenesia* species could not be studied due to unavailability of grains on SEM stub.

Disterigma [35 spp. / 5 spp. examined: *D. acuminatum*, *D. alaternoides*, *D. empetrifolium*, *D. humboldtii* and *D. papenoei*]

Pollen grains are in normal or compact tetrahedral tetrad, grains often shrink in *D. alaternoides* or split along colpi in *D. empetrifolium*; viscin thread absent; D 28.6 – 51.2 μm , P 15.0 – 26.9 μm , E 21.8 – 36.2 μm , D/d 1.31 – 1.41, P/E 0.69 – 0.74, oblate; 3-colporate, often or rarely 4-colporate in *D. alaternoides* and *D. empetrifolium* (Figs. 3-40 L – M), 2f 17.6 – 29.2 μm , W 0.7 – 1.6 μm , 2f/W 16.69 – 32.43, 2f/D 0.57 – 0.62, significantly wider at middle, acute towards end, colpus margin distinct, costae present; endocracks present and distinct, but sometimes indistinct; endoaperture lalongate, 0.6 – 1.7 μm long, 10.5 – 12.0 μm

wide; apocolpial exine 1.7 – 2.8 μm thick, septum 0.9 – 2.6 μm thick; tectate, exine sculpture from verrucate to rugulate, or psilate.

In SEM, 1) pollen surface uneven and rugged, primary apocolpial exine sculpture moderate to coarsely rugulate-psilate, the rugulae with minute (diam. $< 0.2 \mu\text{m}$) granules (Type RG; Figs. 3-35 C, G – H); or 2) surface somewhat flat, primary exine sculpture moderate to coarsely rugulate-psilate, the rugulae with moderate (diam. $> 0.2 \mu\text{m}$) granulate to short striate (Type RGS; Figs. 3-35 D, I); or 3) primary exine sculpture coarsely rugulate without any secondary sculpture (Type R; Fig. 3-35 E); colpus membrane granulate or granuloid.

Gaylussacia [50 spp. / 6 spp. examined: *G. amoena*, *G. baccata*, *G. brasiliensis*, *G. dumosa*, *G. reticulate* and *G. virgata* var. *virgata*]

Pollen grains are in normal tetrahedral tetrad or compact in *G. virgata* var. *virgata*, grains often split along colpi in *G. amoena* or shrink in *G. brasiliensis*; viscin thread absent; D 41.4 – 48.2 μm , P 21.1 – 25.0 μm , E 31.4 – 38.1 μm , D/d 1.27 – 1.37, P/E 0.66 – 0.73, oblate; 3-colporate, 2f 15.6 – 23.0 μm , W 1.6 – 3.3 μm , 2f/W 4.73 – 11.65, 2f/D 0.36 – 0.48, significantly wider at middle, acute towards end, colpus margin distinct, costae present but indistinct in *G. reticulate*; endocracks absent or indistinct; endoaperture lalongate, 1.7 – 2.6 μm long, 6.4 – 11.8 μm wide; apocolpial exine 1.9 – 2.6 μm thick, septum 0.9 – 1.6 μm thick; tectate, exine sculpture from verrucate to rugulate or psilate.

In SEM, 1) pollen surface is uneven and rugged to somewhat flat, primary apocolpial exine sculpture coarsely rugulate-psilate, the rugulae with minute (diam. $< 0.2 \mu\text{m}$) granules (Type RG; Figs. 3-35 L, 3-36 A); 2) surface uneven and rugged, primary exine sculpture moderate to coarsely rugulate-psilate, the rugulae with minute (diam. $< 0.2 \mu\text{m}$) striate (Type RS; Fig. 3-35 O) or intermediate type (RS/R; Figs. 3-35 M – N); or 3) surface somewhat flat,

primary exine sculpture coarsely rugulate-psilate, intermediate type (R/P; Fig. 3-36 B); colpus membrane granulate or granuloid.

Gonocalyx [10 spp. / 1 sp. examined: *G. smilacifolia*]

Pollen grains are in heterodynamosporus tetrads (Figs. 3-37A – H), tetrahedral tetrads fewer in number (ca. 25%); viscin thread absent; D 35.2 μm , P 19.4 μm , E 26.6 μm , D/d 1.32, P/E 0.73, oblate; 3-colporate, 2f 20.0 μm , W 1.8 μm , 2f/W 11.11, 2f/D 0.57, significantly wider at middle, acute towards end, colpus margin distinct, costae present; endocracks present; endoaperture lalongate, 2.1 μm long, 8.5 μm wide; apocolpial exine 2.1 μm thick, septum 1.3 μm thick, perforated; tectate, exine sculpture coarse rugulate.

In SEM, pollen surface is uneven and rugged, primary apocolpial exine sculpture coarsely rugulate-psilate with perforations, the rugulae with moderate (diam. > 0.2 μm) granulate to short striate (Type RGS; Fig. 3-36 L); colpus membrane granuloid to smooth.

In TEM, the apocolpial exine is composed of ectexine and endexine (Fig. 3-36 M – N). Sexine is ca. 0.5 μm thick and a total exine is ca. 0.9 μm thick (Fig. 3-36 O). The septum is ca. 0.3 – 0.4 μm thick Intine is almost evenly thick around the pollen tetrad and comparatively thicker near the colpus region.

Macleania [40 spp. / 6 spp. examined: *M. bullata*, *M. crassa*, *M. farinosa*, *M. portmanii*, *M. rupestris* and *M. stricta*]

Pollen grains are in tetrahedral tetrad (Fig. 3-37 A), 1 or 2 grains disintegrate in *M. farinosa* and *M. stricta* (Fig. 3-37 B), grains often shrink or broken except *M. portmanii*; viscin thread absent; D 46.8 – 64.8 μm , P 23.6 – 34.0 μm , E 34.4 – 48.0 μm , D/d 1.35 – 1.44, P/E 0.69 – 0.73, oblate; 3-colporate, 2f 28.6 – 31.6 μm , W 1.2 – 2.4 μm , 2f/W 13.17 – 23.83, 2f/D 0.57 – 0.65, significantly wider at middle, acute towards end, colpus margin distinct, costae present; endocracks present and distinct, but sometimes indistinct; endoaperture

lalongate, indistinct in *M. rupestris*, 2.1 – 2.4 μm long, 7.3 – 10.2 μm wide; apocolpial exine 1.6 – 2.1 μm thick, septum 0.9 – 1.5 μm thick; tectate, exine sculpture from verrucate to rugulate.

In SEM, pollen surface is uneven and rugged to somewhat flat, primary apocolpial exine sculpture moderate to coarsely rugulate-psilate, the rugulae with minute (diam. < 0.2 μm) striate (Type RS; Fig. 3-37 H) or intermediate type (RS/R; Figs. 3-37 D – G, I); colpus membrane granulate or granuloid to smooth.

Notopora [5 spp. / 1 sp. examined: *N. schomburgkii*]

Pollen grains are in tetrahedral tetrad, most grains broken; viscin threads absent, but sometimes pollenkitt ropes present; D 53.7 μm , P 26.7 μm , E 40.1 μm , D/d 1.37, P/E 0.67, oblate; 3-colporate, 2f 34.0 μm , W 3.5 μm , 2f/W 9.71, 2f/D 0.63, significantly wider at middle, acute towards end, colpus margin distinct, costae present; endocracks present; endoaperture lalongate, 2.5 μm long, 12.2 μm wide; apocolpial exine 3.0 μm thick, septum 1.1 μm thick; tectate, exine sculpture from verrucate or coarse verrucate to rugulate.

In SEM, pollen surface is flat, apocolpial exine sculpture could not be studied clearly as partly covered with pollenkitt debris (Fig. 3-37 L); colpus membrane granulate.

In TEM, the apocolpial exine is composed of ektexine and endexine (Fig. 3-37 M). Sexine is ca. 1.0 μm thick and a total exine is ca. 1.8 μm thick (Fig. 3-37 N). The septum is ca. 1.0 – 1.5 μm thick. Intine is almost evenly thick around the pollen tetrad.

Orthaea [53 spp. / 2 spp. examined: *O. abbreviate* and *O. secundiflora*]

Pollen grains are in normal or compact tetrahedral tetrad; viscin threads absent; D 52.3 – 52.4 μm , P 27.4 – 27.8 μm , E 39.4 – 39.6 μm , D/d 1.33 – 1.42, P/E 0.69 – 0.71, oblate; 3-colporate, 2f 22.5 – 29.9 μm , W 1.6 – 2.0 μm , 2f/W 14.06 – 14.95, 2f/D 0.43 – 0.57, significantly wider at middle, acute towards end, colpus margin distinct, costae present;

endocracks present; endoaperture lalongate, 1.3 – 2.0 μm long, 10.3 – 10.6 μm wide; apocolpial exine 2.1 – 2.3 μm thick, septum 0.9 – 2.4 μm thick, faintly perforated in *O. abbreviate*; tectate, exine sculpture rugulate.

In SEM, pollen surface is somewhat flat, primary apocolpial exine sculpture coarsely rugulate-psilate, the rugulae with minute (diam. < 0.2 μm) granules (Type RG; Fig. 3-38 C) or intermediate type (R/P; Fig. 3-38 B); colpus membrane granulate.

In TEM for *O. abbreviate*, the apocolpial exine is composed of ectexine and endexine (Fig. 3-38 D). Sexine is ca. 0.8 μm thick and a total exine is ca. 1.4 μm thick (Fig. 3-38 E). The septum is ca. 1.2 – 1.3 μm in thickness, faintly to clearly perforate. Intine is almost evenly thick around the pollen tetrad.

Pellegrinia [5 spp. / 1 sp. examined: *P. harmisiana*]

Pollen grains are in lobed tetrahedral tetrad (Fig. 3-38 G), most grains somewhat shrink; viscin threads absent; D 41.3 μm , P 23.1 μm , E 28.1 μm , D/d 1.47, P/E 0.82, oblate; 3-colporate, elongate and narrow, 2f 28.1 μm , W 0.4 μm , 2f/W 70.25, 2f/D 0.68, colpus margin distinct, costae indistinct; endocracks absent or indistinct; endoaperture lalongate, 0.7 μm long, 8.6 μm wide; apocolpial exine 1.7 μm thick, septum 1.1 μm thick; tectate, exine sculpture coarsely verrucate.

In SEM, the pollen of *P. harmisiana* could not be studied due to all grains somewhat shrink like in LM.

Plutarchia [11 spp. / 2 spp. examined: *P. guascensis* and *P. rigida*]

Pollen grains are in tetrahedral tetrad, grains sometimes broken along colpi in *P. rigida*; viscin threads absent; D 51.6 – 52.7 μm , P 26.8 – 27.4 μm , E 37.3 – 38.8 μm , D/d 1.36 – 1.38, P/E 0.71 – 0.72, oblate; 3-colpor(oid)ate, 2f 30.4 – 31.3 μm , W 1.0 – 1.6 μm , 2f/W 19.0 – 31.3, 2f/D 0.59, wider at middle, acute towards end, tip indistinct in *P.*

guascensis, colpus margin distinct, costae present; endocracks present and distinct in *P. rigida*, indistinct in *P. guascensis*; endoaperture lalongate, 1.0 – 2.1 μm long, 9.4 – 9.5 μm wide; apocolpial exine 2.3 μm thick, septum 1.3 – 2.0 μm thick, faintly sculptured in *P. rigida*; tectate, exine sculpture from verrucate to rugulate or obscure.

In SEM, pollen surface is somewhat flat, primary apocolpial exine sculpture coarsely rugulate-psilate, intermediate type (R/RS; Figs. 3-38 J, L); colpus membrane variable.

Psammisia [80 spp. / 3 spp. examined: *P. eucadorensis*, *P. ferruginea* and *P. sodiroi*]

Pollen grains are in isodynamosporus tetrahedral tetrad (Fig. 3-39 A), all grains severely shrink in *P. ferruginea* or heterodynamosporus tetrads in *P. sodiroi* (Fig. 3-39 B); viscin threads absent; D 50.4 μm , P 27.0 μm , E 36.5 μm , D/d 1.38, P/E 0.71, oblate; 3-colporate, 2f 32.4 μm , W 1.5 μm , 2f/W 21.6, 2f/D 0.64, significantly wider at middle, acute towards end, colpus margin distinct, costae indistinct; endocracks absent or indistinct; endoaperture lalongate, 1.8 μm long, 10.0 μm wide; apocolpial exine 2.1 μm thick, septum 0.8 μm thick; tectate, exine sculpture from finely verrucate-rugulate to rugulate.

In SEM, pollen surface is uneven and rugged, primary apocolpial exine sculpture moderate to coarsely rugulate-psilate, intermediate type (R/RS; Figs. 3-39 D, F – G); colpi narrow and elongate in *P. ferruginea*, membrane granulate or granuloid.

Satyria [35 spp. / 4 spp. examined: *S. leucostoma*, *S. panurensis*, *S. pilosa* and *S. warszewiczii*]

Pollen grains are in tetrahedral tetrad, most grains shrink/broken in *S. panurensis*; viscin threads absent; D 41.3 – 47.6 μm , P 21.2 – 25.2 μm , E 31.4 – 37.8 μm , D/d 1.26 – 1.32, P/E 0.67 – 0.69, oblate; 3-colporate, 2f 15.2 – 28.1 μm , W 1.0 – 2.5 μm , 2f/W 9.08 – 16.53, 2f/D 0.37 – 0.59, significantly wider at middle, acute towards end, colpus margin distinct, narrow and not well demarked in *S. panurensis*, costae present; endocracks absent or

indistinct; endoaperture lalongate, 0.9 – 2.2 μm long, 7.2 – 9.7 μm wide; apocolpial exine 1.7 – 2.2 μm thick, septum 0.9 – 1.9 μm thick; tectate, exine sculpture psilate or from verrucate to rugulate.

In SEM, pollen surface is somewhat flat, primary apocolpial exine sculpture moderate to coarsely rugulate-psilate, the rugulae with minute (diam. < 0.2 μm) striate (Type RS; Figs. 3-39 L – O) or intermediate type (RS/R; Fig. 3-39 K); colpus membrane granulate.

Siphonandra [3 spp. / 1 sp. examined: *S. elliptica*]

Pollen grains are in lobed tetrahedral tetrad; viscin threads absent; D 54.4 μm , P 27.7 μm , E 35.4 μm , D/d 1.54, P/E 0.78, suboblate; 3-colpor(oid)ate, 2f 38.6 μm , W 2.3 μm , 2f/W 16.78, 2f/D 0.71, significantly wider at middle, obtuse or acute towards end, colpus margin distinct, granules found in the colpi, costae present; endocracks absent or indistinct; endoaperture indistinct; apocolpial exine 2.0 μm thick, septum 1.4 μm thick; tectate, exine sculpture from verrucate to rugulate.

In SEM, pollen surface is somewhat flat, primary apocolpial exine sculpture coarsely rugulate-psilate, intermediate type (RS/R; Fig. 3-40 C); colpus membrane granulate.

Spherospermum [35 spp. / 2 spp. examined: *S. boekii* and *S. buxifolium*]

Pollen grains are in compact tetrahedral tetrad, 1 or 2 grains of tetrads degenerate and look like dyads or triads in *S. boekii*, sometimes in *S. buxifolium* also; viscin threads absent; D 31.6 μm , P 16.3 μm , E 24.2 μm , D/d 1.31, P/E 0.67, oblate; 3-colporate, rarely 4-colporate in *S. buxifolium*, colpi distinct, 2f 13.4 μm , W 1.3 μm , 2f/W 10.31, 2f/D 0.42, wider at middle, acute towards end, colpus margin distinct, costae present; endocracks absent or indistinct; endoaperture lalongate, 1.3 μm long, 7.4 μm wide; apocolpial exine 1.5 μm thick, septum 1.3 μm thick; tectate, exine sculpture rugulate.

In SEM, pollen surface flat, primary apocolpial exine sculpture moderate to coarsely rugulate without any secondary sculpture (Type R; Figs. 3-40 G – H); colpus membrane granulate or granuloid.

Themistoclesia [30 spp. / 4 spp. examined: *T. anfracia*, *T. cutucuensis*, *T. epiphytia* and *T. mucronata*]

Pollen grains are in isodynamosporus tetrahedral tetrad (Fig. 3-40 J – K), heterodynamosporus tetrads in *T. anfracia* (Fig. 3-40 L – N), most grains shrink in *T. epiphytica*; viscin threads absent; D 32.8 – 38.1 μm , P 16.9 – 19.5 μm , E 25.1 – 28.8 μm , D/d 1.31 – 1.32, P/E 0.67 – 0.71, oblate; 3-colpor(oid)ate, 2f 16.2 – 21.1 μm , W 1.0 – 2.4 μm , 2f/W 6.75 – 19.1, 2f/D 0.49 – 0.55, significantly wider at middle, acute towards end, colpus margin distinct, costae present; endocracks present; endoaperture lalongate, 0.6 – 0.9 μm long, 7.4 – 10.7 μm wide; apocolpial exine 1.7 – 2.0 μm thick, septum 0.9 – 1.4 μm thick; tectate, exine sculpture from verrucate to rugulate or psilate.

In SEM, 1) pollen surface is somewhat flat, primary apocolpial exine sculpture moderate to coarsely rugulate without any secondary sculpture (Type R; Figs. 3-40 O, 3-41 C); or 2) surface somewhat flat, primary exine sculpture moderately rugulate-psilate, the rugulae striate with minute (diam. < 0.2 μm) granules (Type RSG; Fig. 3-41 A); or 3) surface somewhat flat, primary exine sculpture coarsely rugulate-psilate, the rugulae with minute (diam. < 0.2 μm) granules (Type RG; Fig. 3-41 B); colpus membrane smooth to granuloid or granulate.

Thibaudia [70 spp. / 5 spp. examined: *T. albiflora*, *T. angustifolia*, *T. domingensis*, *T. floribunda* and *T. parvifolia*]

Pollen grains are in compact or normal tetrahedral tetrad, all grains somewhat shrink in *T. angustifolia* and *T. floribunda*; viscin threads absent; D 44.9 – 66.3 μm , P 22.5 – 35.0

μm , E 32.9 – 49.1 μm , D/d 1.26 – 1.45, P/E 0.63 – 0.75, oblate; 3-colpor(oid)ate, 2f 19.6 – 42.4 μm , W 1.0 – 2.3 μm , 2f/W 9.22 – 39.6, 2f/D 0.44 – 0.69, significantly wider at middle, acute towards end, colpus margin distinct, costae present; endocracks present and distinct, but sometimes indistinct; endoaperture lalongate, 1.3 – 2.6 μm long, 5.6 – 12.0 μm wide; apocolpial exine 1.8 – 3.3 μm thick, septum 0.7 – 1.4 μm thick, perforated in *T. domingensis*; tectate, exine sculpture psilate or from verrucate to rugulate.

In SEM, 1) pollen surface is flat, primary apocolpial exine sculpture moderate to coarsely rugulate-psilate, the rugulae with minute (diam. < 0.2 μm) striate (Type RS; Figs. 3-41 F, I) or intermediate type (R/RS; Figs. 3-41 G, J, L); or 2) surface uneven and rugged, primary exine sculpture coarsely rugulate-psilate, the rugulae with minute (diam. < 0.2 μm) granules (Type RG; Fig. 3-41 H); colpus membrane granulate or granuloid.

In TEM for *T. domingensis*, the apocolpial exine is composed of ectexine and endexine (Fig. 3-41 M). Sexine is ca. 0.8 μm thick and a total exine is ca. 1.2 μm thick (Fig. 3-41 N). The septum is ca. 0.8 – 1.2 μm thick and finely perforated (Fig. 3-41 O). The exine in LM appears about 2 times thicker than in TEM. Intine is almost evenly thick around the pollen tetrad.

Vaccinium [500 spp. / 37 spp. examined: *V. angustifolium*, *V. bracteatum*, *V. caespitosum*, *V. calycinum* f. *glabreccens*, *V. consanguineum*, *V. corymbosum*, *V. crassifolium*, *V. cubense*, *V. donianum*, *V. emarginatum*, *V. floribundum* var. *floribundum*, *V. hirsutum*, *V. hirtum*, *V. japonicum*, *V. leucanthum*, *V. macrocarpon*, *V. meridionale*, *V. microcarpum*, *V. myrsinites*, *V. myrtilloides*, *V. myrtilus*, *V. oldhamii*, *V. ovalifolium*, *V. ovatum*, *V. oxycoccus*, *V. pallidum*, *V. parvifolium*, *V. praestans*, *V. randaiense*, *V. scoparium*, *V. smallii*, *V. sprengelii*, *V. stamineum*, *V. uliginosum*, *V. vacciniaceum*, *V. vitis-idaea* and *V. wrightii*]

Pollen grains are commonly in both lobed and compact tetrahedral tetrad, sometimes in other configurations or one grain of the tetrad poorly developed, abnormal pollen tetrads:

only one grain of tetrad has developed and/or whole tetrads are shrunk or deformed or broken, observed in one specimen of *V. corymbosum* (Meyer and Mazzeo 13278); viscin threads absent; D 32.5 – 49.2 μm , P 15.7 – 26.1 μm , E 24.3 – 37.2 μm , D/d 1.24 – 1.43, P/E 0.62 – 0.83, oblate but sometimes suboblate; 3-colpor(oid)ate, rarely 4-colpor(oid)ate, 2f 14.0 – 29.0 μm , W 0.9 – 3.0 μm , 2f/W 7.0 – 24.33, 2f/D 0.35 – 0.70, significantly wider at middle, generally acute, sometimes tapering towards ends, colpus margin distinct, costae usually present, though in *V. uliginosum* not clear; endocracks absent or indistinct, but sometimes distinct; endoaperture distinct, but indistinct in some species, commonly lalongate, rarely circular, 0.9 – 2.5 μm long, 7.2 – 10.3 μm wide; apocolpial exine 1.5 – 3.3 μm thick, septum thickness 0.5 – 2.4 μm ; exine tectate, exine sculpture verrucate to rugulate or psilate.

In SEM, pollen surface is flat or somewhat flat, 1) primary apocolpial exine sculpture coarsely rugulate-psilate, the rugulae with minute (diam. < 0.2 μm) striate (Type RS; Figs. 3-42 I, L – O, 3-43 C, E – F, 3-44 F, J – K, O, 3-45 F, I – J) or intermediate type (RS/R; Figs. 3-42 G – H, J – K, 3-43 G – I, M, 3-44 C – E, G, 3-45 K); or 2) primary exine sculpture moderate to coarsely rugulate without any secondary sculpture (Type R; Figs. 3-43 A – B, D, 3-44 A, N) or intermediate type (R/P; Fig. 3-43 N, R/RS; Figs. 3-44 B, 3-45 B, D – E, G – H); or 3) primary exine sculpture psilate, covered with secondary striate sculpture (Type PS; Figs. 3-43 J – L, 3-44 H – I); or 4) primary exine sculpture psilate (Type P; Fig. 3-43 O); or 5) primary exine sculpture indistinct, secondary sculpture unit fine (diam. < 0.5 μm) gemmate-pilate (Type FG; Fig. 3-44 L); or 6) primary exine sculpture moderate to coarsely rugulate-psilate, the rugulae striate with minute (diam. < 0.2 μm) granules (Type RSG; Fig. 3-45 C). Exine sculpture along the colpi similar to that appearing at distal pole, but the mesocolpial exine has a tendency to decrease in lateral extension of the rugulae with more distinct units. Colpus membrane is commonly granular, but has sometimes a tendency towards smooth or granuloid.

In TEM for *V. smallii*, the apocolpial exine is composed of ektexine and endexine (Fig. 3-45 M). Sexine is ca. 0.6 μm thick and a total exine is ca. 1.1 μm thick (Fig. 3-45 N). The septum is ca. 0.5 – 0.8 μm thick (Fig. 3-45 O). The exine in LM appears about 2 times thicker than in TEM. Intine is almost evenly thick around the pollen tetrad.

Discussion

Variation in palynological characters

My palynological observations largely agree with the earlier descriptions (Heusser 1971, Luteyn 1978, Maguire et al. 1978, Waha 1984, Warner and Chinnappa 1986), although some differences have been observed. For instance, different type of pollen dispersal unit i.e. irregular aggregate of 2 – 4 grains (heterodynamosporus tetrads as Erdtman 1952), along with the regular form of tetrahedral tetrads (isodynamosporus tetrads as Erdtman 1952) have been observed in Vaccinieae. Especially the pollen grains of *Gonocalyx smilacifolius* were assemblage in variable tetrads viz., tetrads, dyads and rarely triads, like the genus *Leucopogon* of subfamily Styphelioideae (Smith-White 1959). Davis (1997) also reported this type of heterodynamosporus tetrads for *Macleania bullata* in Vaccinieae. The close palynological relationship between the Epacridaceae and Ericaceae has been pointed out by Erdtman (1952), but he did not report the occurrence of heterodynamosporus tetrads in Ericaceae. The occurrence of both iso- and hetero-dynamosporus tetrads seems to confirm the closer relationship between the subfamilies Styphelioideae and Vaccinioideae as found in morphological and molecular data (Kron et al. 1999, 2002a). This might be an indication that the pseudomonad pollen is evolved independently in the tribes Oligarrheneae and Styphelieae of the subfamily Styphelioideae and the tribe Vaccinieae of the subfamily Vaccinioideae.

Tribes Andromedeae, Gaultherieae and Oxydendreae were characterized by compact pollen tetrads and those of tribes Lyonieae and Vaccinieae relatively lobed or normal. In the most recent classification of Ericaceae (Kron et al. 2002a) tribe Vaccinieae is identified as the most advanced tribe within the family. Therefore, the character state compact tetrad is symplesiomorphic for the subfamily Vaccinioideae and the relatively lobed tetrad is derived and evolved independently in the tribes Lyonieae and Vaccinieae, which also support the evolutionary trend of pollen tetrads by Warner and Chinnappa (1986).

Under LM, another specialized pollen tetrad type, tetrad without septum, is found in two species of *Ceratostema*; *C. lanigerum* and *C. loranthifolium* of the tribe Vaccinieae, and one species of *Lyonia*; *L. ligustrina* of the tribe Lyonieae. The unique mature pollen tetrads without septum found in *Ceratostema* has been reported for the first time in Ericaceae as well as other angiosperm families (Sarwar et al. 2006b). Although no significant correlation was found between compactness of tetrad and septum thickness in the Vaccinieae, these two *Ceratostema* species have minute pollen grains united at compact tetrad, and more or less circular at polar view. The small tetrad size of *Ceratostema* pollen may be the necessary but not the sufficient conditions for the absence of the septum, as I have found relatively smaller pollen tetrads with well developed septum in some other genera; e.g., *Disterigma*, and *Gaultheria* within the Vaccinioideae (Table 3-6-2). Le Thomas et al. (1986) discussed the possibility of completely lacking of septal exine in Annonaceae. According to them (Le Thomas et al. 1986), one of the most typical features of most tetrads or polyads of Annonaceae and other families is the reduced septum (proximal exine) which leads to a functional unit. The first step in formation of tetrad is certainly a more or less loose aggregation with monads which do not differ significantly from the single pollen grain type and do not have reduced septum. Later the pollen tetrad forms a functional unit, and the septum becomes progressively reduced. It is emphasized that the reduction of septum is not a condition for tetrad evolution but a consequence (Le Thomas et al. 1986). Warner and

Chinnappa (1986) postulated that the evolutionary trend in pollen dispersal unit within Ericales is from tetrad to monad. The pollen tetrad without septum is probably another evolutionary trend from standard pollen tetrads with septum.

The rare occurrences (less than 5% of total observed grains) of unusual 4-aperturate pollen are observed in some taxa (Table 3-6-1). This might be due to abnormality in the microsporogenesis stage of pollen development, or related to ploidy level and/or pollen size (Lewis 1964, Takahashi 1987a). But, *Disterigma* species have pollen grains of similar size in comparison to other 3-aperturate species and *Sphyrospermum buxifolium* has even smaller (Table 3-6-2). Interestingly, *Disterigma emperifolium* has relatively smaller pollen grains compared to those of *D. alaternoides*, but more consistent with 4-aperturate pollen (Table 3-6-2). Three aperturate pollen grains found at most of the taxa, are seems to be symplesiomorphic and 4-aperturate to be derived. Tricolpate pollen is the main and basic type found in most eudicots while other aperture types such as 5-colpate, 6-colpate, porate, colpate, pororate, are regarded as being derived among the eudicots (Walker and Doyle 1975). The shape of tetrahedral tetrads with 4-aperturate grains was little different from of tetrahedral tetrads with 3-aperturate grains (Fig. 3-35).

The palynological features are summarized in Table 3-6-1 and all the palynological characters studied with LM are listed in Table 3-6-2. A wide range of variation in tetrad diameter was found in both infra- and inter-generic level. Among the species studied, pollen grains of *Dimorphanthera microphylla* possessed the largest values of D, P, and E (72.4 μm , 39.3 μm and 50.8 μm , respectively) and those of *Gaultheria oppositifolia* had the lowest values (24.8 μm , 12.5 μm and 19.0 μm , respectively) (Table 3-6-2). One of the causes of wide infrageneric variations in tetrad diameter might be due to variations in ploidy level among the species within the same genus. Generally values of morphological traits increase with the increase in ploidy level. Cockerham and Galletta (1976) reported that the mean pollen diameter was 11% larger in the tetraploids compared to that in the diploids in certain

Vaccinium species. However, the opposite condition i.e. no correlation between tetrad diameter and ploidy level, is also observed in the genera *Erica* and *Kalmia* of the Ericaceae (Chapter 3-3). The medium sized pollen found in most of the specimens thought to be symplesiomorphic pollen character state, and minute pollen in some specimens viz., *Agarista salicifolia*, *Ceratostema lanigerum*, *C. loranthiflorum*, *Disterigma acuminata* etc. or large pollen in *Dimorphanthera microphylla* is hypothesized as to be evolved independently within these taxa. Similar evolutionary trends in pollen size from medium towards large or towards minute, have also been discussed by Walker and Doyle (1975). But, they also reported the easy reversibility of this character. The largest values of $2f$ and W (42.4 μm and 5.5 μm , respectively) are found in *Thibaudia angustifolia* and *Tepuia venusta*, respectively and the lowest (12.5 μm and 0.4 μm , respectively) are found in *Agarista salicifolia* (Schlieben 1106a) (Table 3-6-2). Sometimes parameter with common value is found in different genera viz. D/d value 1.26 was found in *Cavendishia pubescens*, *Satyria panurensis*, and *Thibaudia albiflora* (Table 3-6-2). Similar pattern of distribution is also found for other parameters including P/E ratio. Similar to size pattern, oblate shaped pollen is hypothesized as to be synapomorphic character, and suboblate as to be evolved independently to the plesiomorphic state within these taxa. Along with D, P and E, the thickness of apocolpial exine (1.1 – 3.3 μm) and septum (0.5 – 2.6 μm) also showed a wide variation (Table 3-6-2). Usually the former is thicker than the latter. But septum thicker than apocolpial exine was also noticed in different species (Tables 3-6-1 – 3-6-2).

Waha (1984) observed the presence of viscin threads in one specimen of the genus *Gaylussacia* (without mentioning the species name). In the present study or any other previous studies (e.g., Lieux and Godfrey 1982), we did not observe viscin threads in any of the species of *Gaylussacia*; even though, pollenkitt was observed in *Notopora schomburgkii* (Sarwar et al. 2005). Moreover due to presence of pollenkitt debris on the exine surface, I am unable to study the apocolpial exine sculpture of *N. schomburgkii* in detail under SEM (Fig.

3-37 L). The apocolpial exine sculpture seems to be psilate from TEM observations (Maguire et al. 1978, Sarwar et al. 2005).

The SEM observations showed a wide variation in the apocolpial exine sculptures from striate through rugulate to psilate within the members of the subfamily Vaccinioideae (Figs. 3-23 – 3-45). The rugulae with “secondary sculpture”; faintly and finely to clearly striate was the common feature in the subfamily Vaccinioideae. So, the exine surface with secondary sculpture characterized the subfamily Vaccinioideae, may be a synapomorphic palynological character state within the subfamily as well as the family Ericaceae. Although, a more or less continuous and serial variation was found in the exine sculpture among the taxa, the synapomorphic state of exine sculpture for this subfamily is not clear as the exine sculpture very often evolved parallelly. At least the psilate sculpture might be the most specialized character state situated at the end of a serial variation of exine sculpturing within this subfamily. The major morphological trend of the exine sculpture is postulated; from coarse rugulate to psilate.

Sometimes variations on the exine sculpture are found within or among the specimens of different taxa e.g., *Andromeda polifolia* (Figs. 3-23 D vs. E), *Pieris floribunda* (Figs. 3-29 J vs. K), *Cavendishia adenophora* (Figs. 3-31 K vs. L), *Demosthenesia weberbaueri* (Figs. 3-34 F vs. G) etc. These types of variation on the exine sculpture are very common phenomena in Ericaceae as well as other angiosperm families (e.g., Takahashi 1986b). One of the causes might be variation due to geographical distribution, as reported for other morphological characters.

Only fifteen specimens are studied representing the eleven genera, but representing all the tribes of the Vaccinioideae with TEM. Though the basic pollen wall structures is same, they show significant differences in the thickness of different substratum (Table 4-3; e.g., Figs. 3-32 G – L), which are helpful for the identification of taxa. The TEM observations are also helped to confirm some critical observations which are observed under LM or SEM, e.g.,

the absence of septum in *Ceratostema*, presence of pollenkitt rope in *Notopora*, heterodynamospore tetrad in *Gonocalyx*, etc.

Taxonomic significances of palynological characters

Tribe Andromedeae

Although the members of the tribe Andromedeae *s.s.*; *Andromeda* and *Zenobia*, were previously included in the tribe Andromedeae *s.l.* (Stevens 1971), they are described as isolated genera and/or as member of *Gaultheria* group. The genera of the tribe Andromedeae is characterized by compact tetrads and relatively thinner (Class I) and perforated septum (Table 3-6-1; Figs. 3-23 B, I). The apocolpial exine sculpture of the genera of Andromedeae is also similar (Type R; Figs. 3-23 D, K). The close relationship between tribes Andromedeae *s.s.* and Gaultherieae, as identified by morphological and molecular data (Kron et al. 2002a), is well supported by both quantitative and qualitative palynological characters (Tables 3-6-1 – 3-6-2; Figs. 3-23 – 3-27 A – I). However, the palynological features of other tribes Lyonieae and Oxydendreae are not clearly differentiate from those of Andromedeae *s.s.* and Gaultherieae (Table 3-6-2).

Among the genera of the tribe Andromedeae, *Andromeda* is characterized by relatively larger pollen tetrads (Class III) and grains with thicker apocolpial exine compared to those of *Zenobia* (Tables 3-6-1 – 3-6-2). One specimen of *Andromeda polifolia* (Johnson s.n.) showed relatively larger value of D/d ratio than that of all other taxa of this tribe (Table 3-6-2). The larger D/d value might be an indication of relative looseness of pollen grains in tetrads of this taxon or a variation due to the geographic distribution, as *Andromeda polifolia* is widely distributed in cooler regions of the northern hemisphere.

Tribe Gaultherieae

Members of the tribe Gaultherieae were previously included as *Gaultheria* group of genera of the tribe Andromedeae *sensu* Stevens (1971), and characterized by their multicellular hairs with multiseriate stalks; stamens with straight, rather stout filaments, often longer anthers with white disintegration tissue on the anthers and terminal awns or lacking both awns and disintegration tissue; testa cells variable in shape, but often about as broad as long and distinctly thickened; foliar stomata are usually paracytic; epidermal lignification on the leaf is not seen; lignified cells in the phloem not occurring in bands (Stevens 1969).

Based on exine sculpture, two distinct groups are identified among the genera of the tribe Gaultherieae. Group one composed of *Diplycosia* and *Leucothoë*, is characterized by coarsely rugulate-psilate to psilate primary exine sculpture with clearly striate secondary sculpture (Type PS or RS; Figs. 3-24 G, 3-27 D – E). And the other group composed of *Chamaedaphne*, *Gaultheria* and *Tepuia*, is characterized by exine sculpture of coarsely rugulate to coarsely rugulate-psilate, the rugulae with faintly to finely and clearly striate (Type R or intermediate R/RS; Figs. 3-24 D, M – O, 3-25, 3-27 H). The palynological close relationship between *Gaultheria* and *Tepuia* is well supported by morphological and molecular data, but *Chamaedaphne* is situated at relatively distant position (Powell and Kron 2001). In this combined analysis (Powell and Kron 2001), *G. procumbens* is also emerged as sister to *G. cumingiana* + the *Diplycosia* clade. Although I did not study pollen of *G. cumingiana*, the distinctness of secondary striate sculpture may give additional support to the close relationship between *G. procumbens* (Type RS; Fig. 3-25 H) and *D. heterophylla* (Type PS; Fig. 3-24 G), thus may also support the closer relation between these two genera; *Gaultheria* and *Diplycosia* (Stevens 1971).

The monophyly of *Leucothoë* is supported by quantitative palynological features (Tables 3-6-1 – 3-6-2) and apocolpial exine sculpture with striate secondary sculpture (Types PS or RS; Figs. 3-27 D – E), but has not been supported by molecular data (Powell and Kron

2001). Taxon sampling might have played a role in the fragmenting of a genus and the relationships within and/or among the genera (Kron et al. 2002b), increased sampling of *Leucothoë* species may help to resolve the details of the relationships within this genus and other taxa of the tribe Gaultherieae as well as subfamily Vaccinioideae.

The range of variation found in the exine sculptures of *Gaultheria* (Table 3-6-2; Figs. 3-24 M – O, 3-25), might possess taxonomic importance and has been used to add additional insights on the infrageneric classification for the genus *Gaultheria* (Middleton 1991).

Tribe Lyonieae

Members of the tribe Lyonieae were previously included as *Lyonia* group of genera of the tribe Andromedeae *sensu* Stevens (1971), and characterized by having multicellular hairs with biseriate stalk; stamens with slender, prominently geniculate filaments, short anthers with white disintegration tissue at the anther filament junction; staminal appendages, if any, are spurs borne either on the filaments or dorsally on the anther; style often swollen; testa cells elongated and thin walled; foliar stomata are usually anomocytic; the upper epidermis of the leaf is often lignified; band of fibers are found in the secondary phloem (Stevens 1969). The monophyly of the tribe and each of its genera has been well supported in the phylogenetic studies of this tribe as well as the family Ericaceae (Kron and Judd 1997, Kron et al. 2002a). Palynological features of the tribe Lyonieae also do not vary very widely (Tables 3-6-1 – 3-6-2; Figs. 3-27 J – O – 3-30), which may support the monophyly of the tribe.

Palynological features of *Craibiodendron yunnanensis* are very similar to those of *Lyonia*, and *Agarista* to *Pieris* (Tables 3-6-1 – 3-6-2; Figs. 3-27 J – O – 3-30). These similarities in pollen characters may indicate the closer relationship among and/or between the genera of this tribe, which is also supported by molecular data. In the combined analysis of morphological and molecular data, the sister relationship has been observed between

Agarista and *Pieris*, and *Craibiodendron* more closely related to *Lyonia* than to *Pieris* and *Agarista* (Kron and Judd 1997).

The range of variation found in the palynological features especially in the exine sculpture of *Agarista*, *Lyonia* and *Pieris* (Tables 3-6-1 – 3-6-2; Figs. 3-27 J – O – 3-30), possessed taxonomic importance and has been used to add additional insights on the infrageneric classifications for these genera based on morphological and anatomical observations.

Tribe Oxydendreae

Oxydendrum, the only genus of the monotypic tribe Oxydendreae, was included as an isolated genus within the tribe Andromedeae (*sensu* Stevens 1971) and characterized by terminal paniculate inflorescence produces fruits in the same year the shoot is initiated; distinct floral anatomy–tapered floral receptacle, all traces to the floral organs leave the elongate floral axis separately; fruit the elongate-ovoid capsule.

The compact tetrahedral pollen tetrads of *Oxydendrum arboreum* are characteristically circular in shape (Table 3-6-1). The circular shape of tetrahedral tetrads distinguishes its pollen unit from the subtriangular ones of all other Vaccinioideae as well as Ericaceae investigated in this study. But, the exine sculpture with SEM is similar to other taxa of the subfamily Vaccinioideae (Plate LXIX, Fig. 1 in Lieux and Godfrey 1982).

Hitherto, the circular shaped tetrahedral pollen tetrad is reported in two other species; *Arctostaphylos uva-ursi* (Oldfield 1959, Moriya 1976) and *Arbutus menziesii* (Warner and Chinnappa 1986), both from subfamily Arbutoideae of the Ericaceae, but the exine sculpture of these two species is very similar to other species of these two genera (Figs. 3-6 – 3-7; Fig. 3 in Foss and Doyle 1988). Although Oldfield (1959) reported the presence of circular shaped tetrahedral tetrad also in *Arctostaphylos alpina*, the photograph clearly showing subtriangular in shape (Fig. 11 in Plate 2 of Oldfield 1959).

Tribe Vaccinieae

Members of the Tribe Vaccinieae, the largest tribe of the family Ericaceae, are extremely diverse in vegetative and floral morphology, and are characterized by inferior ovary; anthers usually lacking of integration tissue but with tubules; fruit fleshy, a berry or 10-pitted drupe, but the monophyly of most of the genera of Vaccinieae has not been rigorously assessed (Kron et al. 2002a). Palynological characters of this tribe are also very variable (Tables 3-6-1 – 3-6-2; Figs. 3-31 – 3-45). Kron et al. (2002b) for the first time studied the phylogenetic relationships within Vaccinieae from a global perspective with the *matK* and nrITS analysis. And the result indicated that generally the traditional generic circumscriptions were not corroborated, but some well supported clades were found. In order to comment on recent generic monophyly and realignments within the tribe based on palynological data, I concentrate my discussion with the well supported clades which were recovered by Kron et al. (2002b).

The *Agapetes* clade comprises several species of temperate and tropical Asian *Vaccinium* species and species of *Agapetes* (Kron et al. 2002b). In present study all the three species of *Agapetes*; *A. bracteata*, *A. lobbii* and *A. oblonga*, have 3-aperturate, oblate and mediae pollen grains with exine sculpture varies from reticulate to coarsely rugulate-psilate (Fig. 3-31 D – H). Stevens (1985) reported that *Agapetes* subg. *Agapetes* and a number of sections of *Vaccinium* from mainland SE Asia are clearly closely related in a number of morphological and anatomical features. This opinion is also correct for palynological features. Exine sculptures of *Agapetes* species (Figs. 3-31 F – G) are similar to some of those of *Vaccinium* species (Figs. 3-42 – 3-45), except *A. bracteata* which has a very identical exine sculpture reticulate, even within the subfamily (Type FS; Fig. 3-31 D). This might be an indication of polyphyly of this genus as suggested by Kron et al. (2002b). Goldy et al. (1984) indicated that the exine sculpture patterning might provide useful information on taxonomic relationships and inheritance in *Vaccinium*. The preliminary cytological studies by Atkinson

et al. (1995) and morphological and anatomical studies by Stevens (1997) suggest that Malesian and SE Asian *Vaccinium* and mainland *Agapetes* form the core of a monophyletic unit, and must be included in *Vaccinium* (Kron and Luteyn 2005, Stevens, P.F. personal communication). And *Agapetes* subgenus *Paphia* section *Paphia* is to be considered as a new genus *Paphia sensu* (Stevens 2003). The palynological observations of this study support the close relation and may also be the inclusion of *Agapetes* in the genus *Vaccinium*.

The *Bracteata-Oarianthe* clade, comprised of species of *Vaccinium* from New Guinea and Borneo represent sects. *Bracteata* and *Oarianthe*, is related to *Agapetes* clade (Kron et al. 2002b). According to their analysis both of these sections were polyphyletic. No species from sect. *Oarianthe* was included in this palynological study and the exine sculpture of the members of sect. *Bracteata* form two groups based on distinctness of secondary sculpture on the rugulae (R/RS; Figs. 4-42 I – J vs. RS/R or Type RS; Figs. 4-42 K – L). Although the quantitative palynological characters of the studied species of the sect. *Bracteata* are very similar (Tables 3-6-1 – 3-6-2), the exine sculpture may support the polyphyly of sect. *Bracteata*.

The *Myrtillus* clade contains species of *Vaccinium* from sections; *Hemimyrtillus*, *Macropelma*, and *Myrtillus*, and *Costera endertii*, although its relationship was unresolved with respect to *Vaccinium* species (Kron et al. 2002b). Although the sister relationship between *Vaccinium* sects. *Macropelma* and *Myrtillus* is well supported, the species composition of sect. *Hemimyrtillus* is subject of much debate until today (Sarwar et al. 2006a). And the exine sculpture of *Costera endertii* (RSG/MG; Fig. 3-34 B) is very similar to that of *Vaccinium stamineum* of sect. *Polycodium* (Type RSG; Fig. 3-45 C). A combined analysis of morphological and molecular data may helpful to clarify the relationship between the members of *Vaccinium* and *Costera endertii* of this clade.

Two species of the genus *Orthaea*; *O. apophysata* and *O. venamensis*, were strongly monophyletic by molecular data, but the monophyly of *Orthaea* was not supported when the

third species *O. fimbriata* was added to the analysis (Kron et al. 2002b). The quantitative palynological characters of two studied species of *Orthaea* are similar (Tables 3-6-1 – 3-6-2), but the difference in apocolpial exine sculpture (R/P; Fig. 3-38 B vs. Type RG; Fig. 3-38 C) may support the polyphyly/paraphyly of the genus *Orthaea*. The combined analyses of morphological, palynological and molecular data, from both larger number of species and specimens, are needed to make a confident comment on the monophyly of this genus. Palynological observations may also support the taxonomic position of *Orthaea/Notoropa* clade as sister to East Malesian clade and *Vaccinium* clade of Kron et al. (2002b) (Tables 3-6-1 – 3-6-2; Figs. 3-34 H – L; Sarwar et al. 2006a).

The East Malesian clade is strongly monophyletic and comprises species belonging to *Paphia* and *Dimorphanthera*, and all the studied *Dimorphanthera* species are monophyletic except *D. keysseri* which is sister to *Paphia stenantha* (Kron et al. 2002b). Later, Stevens (2003) suggested the inclusion of the members of *Dimorphanthera* section *Pachyantha* (e.g., *D. keysseri*) to the genus *Paphia*. Among the studied species *D. microphylla* possesses the largest D, P and E, and longest ora among the taxa of the tribe Vaccinieae as well as the subfamily Vaccinioideae, but two other species of *Dimorphanthera* have very similar palynological characters (Table 3-6-1 – 3-6-2). Moreover, all these three species have similar apocolpial exine sculpture (R/RS; Figs. 3-34 I, K – L). From the result of present study, it may reveal that the exine sculpture is more important feature to identify the monophyly of species. As I did not study the pollen grains of either *D. keysseri* or any species of *Paphia*, so I am not in a position to make any specific comment on the opinion of Stevens (2003). However, the sister relationship of East Malesian clade with the Andean + Meso-American/Caribbean clade (Kron et al. 2002b), is supported by our palynological observations (Tables 3-6-1 – 3-6-2; Figs. 3-35 D – I, 3-36 L, 3-37 A – D).

The Meso-American/Caribbean clade contains taxa seemingly dissimilar morphology, but it is a well-supported clade that contains one species each from the genera *Disterigma*,

Gonocalyx, *Macleania*, *Symphysia*, *Utleya* and *Vaccinium*, generally found in the Central America and the Caribbean (Kron et al. 2002b). Luteyn (2001) recognized *Macleania megabracteolata* of this clade as *Gonocalyx megabracteolatum* and recently, *Vaccinium poasanum* is also renamed as *Symphysia poasanum* (Vander Kloet et al. 2004) those reduced the number of genera to four in this clade. One species of *Gonocalyx* and five species of *Disterigma* were included in this study, but, I am not sure about the position of *Disterigma* species. The genus *Disterigma* is opinioned as a polyphyletic genus and many of its species are included in Andean clade also (Kron et al. 2002b; Powell and Kron 2003). Pollen morphological observations of this study may support the close relationship between *Gonocalyx* and *Disterigma* as a member of same clade, and also polyphyly/paraphyly of the genus *Disterigma* (Tables 3-6-1 – 3-6-2; Figs. 3-35 C – I, 3-36 L). And *D. acuminatum* has the smallest values of D, P and E within the tribe Vaccinieae (Table 3-6-2).

The Andean clade has the largest species diversity within the tribe Vaccinieae and includes most of the Neotropical species concentrated in the moist, montane forest of the northern Andes (Kron et al. 2002b). In their study the monophyly of the Andean clade was strongly supported, but within this group two major subclades were also found. Out of 13 genera, only *Anthopterus*, *Macleania* and *Themistoclesia* were monophyletic and some genera were widely fragmented between the Andean clade and other well supported clades (Fig. 6 in Kron et al. 2002b). Another combined phylogenetic analysis of the Northern Andean blueberries by Powell and Kron (2003) identified seven major clades and more elaborately discussed the relationships among these genera. According to them only four genera viz. *Anthopterus*, *Themistoclesia*, *Cavendishia*, and *Sphyrospermum*, of this clade were monophyletic. The monophyly of the genus *Macleania* is not supported in latter study. The results of our palynological study generally support the opinion of Powell and Kron (2003) except in *Macleania*. The palynological features also support the monophyly of *Macleania* (Tables 3-6-1 – 3-6-2; intermediate R/RS or Type RS; Figs. 3-37 A – I) as

reported by Kron et al. (2002b). The *Ceratostema-Macleania* clade comprises of genera *Ceratostema*, *Macleania*, and *Psammisia*, is described as sister to the rest of the Andean clade (Powell and Kron 2003). The similarity of the exine sculptures may support a close relationship among them (Figs. 3-33 D, F, 3-37 D – I, 3-39 D, F – G).

Like the wood anatomical characters (Lens et al. 2004), the palynological features of this study also do not support for the division into two major subclades within the Andean clade by Kron et al. (2002b). Kron et al. (2002b) also concluded that the taxon sampling might have a role in the fragmenting of genera and the relationships among the genera, and a major generic realignment is to be necessary within the Neotropical Andean clade. Palynological features may play an important role in the generic realignment within the Neotropical Andean clade.

Relationships of *Satyria* have been debated in the literature (e.g., Smith 1932, MacBride 1944, Stevens 1974, Maguire et al. 1978). The palynological data might be helpful to conclude the debate on the relationships and placement of *Satyria*. Along with the previous molecular studies (Kron et al. 1999, 2002b, Powell and Kron 2003), the palynological observations of this study also support the sister relationship between *Cavendishia* and *Satyria* (Type RS; Figs. 3-31 I – O, 3-32, 3-39 H – O).

The genus *Thibaudia* has been described as “waste basket” genus of Andean blueberries, and analyses of molecular characters also indicate its polyphyly (Kron et al. 2002b, Powell and Kron 2003). The palynological characters of the studied species of *Thibaudia* make two distinct subgroups; *T. albiflora*, *T. dominensis* and *T. floribunda* vs. *T. angustifolia* and *T. parviflora* (Tables 3-6-1 – 3-6-2; Type RS; Figs. 3-41 F, I vs. RS/R or R/RS; Figs. 3-41 G, J – K), with exception on exine sculpture of *T. dominensis* which has uneven and rugged pollen surface, coarsely rugulate-psilate, the rugulae closely packed and finely striate (Type FG; Fig. 3-41 H).

The sister relationship of Andean clade with the Meso-American/Caribbean clade (Kron et al. 2002b), seems also justified according to pollen morphology; both clades showed similarities in tetrad diameter, pollen dimensions, exine sculptures (Tables 3-6-1 – 3-6-2; Figs. 3-34 N– O, 3-35 A – I, 3-36 L).

In the molecular phylogeny analyses on Vaccinieae (Kron et al. 2002b, Powell and Kron 2002), they have reported some relationships among the *Vaccinium* species. Some of these are supported by this palynological study e.g., the sister relationship between *V. meridionale* of sect. *Eococcus* and *V. consanguineum* of sect. *Pyxothamnus* is well supported by palynological characters as identified by molecular analysis (Tables 3-6-1 – 3-6-2; Figs. 3-43 I, 3-45 E, Sarwar et al. 2006a).

Maguire et al. (1978) opined that *Gaylussacia* is closely related to *Vaccinium* and being separated from it basically on the basis of the 10-locular, drupaceous fruit. Although *Gaylussacia* has a disjunct distribution with some species in the southeastern USA and the most of the species in Brazil (three species scattered in the Andes), both the quantitative data by LM (Tables 3-6-1 – 3-6-2) and apocolpial exine sculpture; coarsely rugulate-psilate exine sculpture (Figs. 3-35 L – O, 3-36 A – C) by SEM showed a similarity among them. The combined analysis of morphological and molecular data of *Gaylussacia* (Floyd 2002) showed that the sections *Gaylussacia* and *Decamerium* are monophyletic and monotypic sect. *Vitis-idaea* should be included and classified with the genus *Vaccinium*. According to Kron et al. (2002b), *Gaylussacia dumosa* does not include with any other clades e.g., Meso-American/Caribbean or Andean or *Orthaea/Notoropa* clade, but makes a common clade with *Vaccinium crassifolium* and sister to *Orthaea/Notoropa* clade. Similarity in the exine sculptures may also support the close relationship between *G. dumosa* (Type RS; Fig. 3-35 O) and *V. crassifolium* (R/RS; Fig. 3-44 B). Lens et al. (2004) also observed similarities in some wood anatomical features among *G. dumosa* and some of *Vaccinium* species. All these evidences may also support the closer relationship between *Gaylussacia* and *Vaccinium* as

opinioned by Maguire et al. (1978). An intensive sampling of *Gaylussacia* and representatives of pseudo-ten-locular *Vaccinium* may help us to resolve the generic limit and relationship between these two genera completely.

The palynological characters showed some infra- and inter-clade variations and/or overlaps, both at quantitative and qualitative characters, among the clades identified by phylogenetic analysis of molecular data of Vaccinieae. Similar result was found for the genera *Enkianthus* (Sarwar and Takahashi 2006b) and *Vaccinium* (Sarwar et al. 2006a). Although any subdivision in pollen morphological characters could not be found correlating with these clades, but they gave some/much useful information regarding taxonomic relationships and helpful insight in some taxonomic problems within the members of this tribe, as discussed above and identified as an important tool to identify monophyly of some of the genera. Further research including the study of higher number of specimens, both generic and species levels, and combined analysis of phenotypic (morphological, anatomical, palynological, chromosome number, and secondary chemistry) and molecular data, is needed to clarify the phylogenetic relationships among and within the genera of the tribe Vaccinieae.

Infrageneric classifications

The infrageneric classifications based on morphological and anatomical characters for the genera; *Agarista* (Judd 1984), *Gaultheria* (Middleton 1991), *Gaylussacia* (Sleumer 1967) and *Lyonia* (Judd 1995a), are generally supported and/or confirmed by the palynological characters (Table 3-6-1 – 3-6-2; Figs. 3-24 – 3-25, 3-27 – 3-28, 3-35 – 3-36). Palynological features have also been supported infrageneric classification for the genus *Pieris* (Judd 1982) and *Vaccinium* (Sleumer 1941 with modifications thereafter) (for detail Sarwar and Takahashi 2006a, and Sarwar et al. 2006a, respectively).

Agarista

The genus *Agarista* includes 31 species of trees and shrubs and is divided into two sections; monotypic sect. *Agauria* (including *A. salicifolia*) and sect. *Agarista* (including the remaining 30 species) (Judd 1984). The placement of *A. salicifolia* in the monotypic sect. *Agauria* is supported by many exceptional palynological characters of this taxon within the genus *Agarista* viz., lobed, significantly smaller pollen tetrads (D 30.5 μm), minute grains (P16.3 μm X E22.9 μm) and coarsely rugulate exine sculpture (Tables 3-6-1 – 3-6-2; Type R; Fig. 3-28 B).

Based on the palynological features, two distinct pollen morphological groups were identified among the members of sect. *Agarista*. One group composed of *A. chlorantha* and *A. coriifolia* var. *coriifolia*, is characterized by relatively larger pollen tetrads (D Class III), thicker apocolpial exine (Class III – IV), but smaller D/d (Class II) and P/E (Class II) values. And the other composed of *A. eucalyptoides* and *A. populifolia*, is characterized by relatively larger D/d (Class III – IV) and P/E (Class III) values, but smaller pollen tetrads (D Class II – III) and thinner apocolpial exine (Class II) (Tables 3-6-1 – 3-6-2). Previously, the cladistic analysis of morphological and anatomical data also produced six more or less weakly diagnosed clades within the species of this section (Judd 1995b). So, combined analyses of morphological, anatomical, palynological and molecular data are suggested for better understanding of the relationships among the members of *Agarista* sect. *Agarista*.

Gaultheria

Gaultheria (including *Pernettya*) is a genus of about 134 species of shrubs and subshrubs widespread in temperate regions and tropical montane habitat and in both the Old and New World (Middleton 1991). Middleton (1991) classified the genus *Gaultheria* into ten sections (one with two subsections) and 22 series based on morphological and anatomical features. Though Luteyn (1995b) opinioned that the fruit difference (i.e., berry in *Pernettya*

and capsule in *Gaultheria*) might be sufficient to recognize two genera. In this discussion we follow Middleton's (1991) infrageneric classification of *Gaultheria*, as it was also followed in the recent classification of Ericaceae (Kron et al. 2002a).

Members of sect. *Amblyandra* are characterized by campanulate flowers, exaristate and basally dilated stamens and large leaves for solitary flowered species (Middleton 1991) and compact pollen tetrads with exine sculpture coarsely rugulate, the rugulae coarsely striate (Type RS; Fig. 3-24 M). The exine sculpture of *G. adenothrix* showed some similarities to *G. miqueliana*, *G. erecta*, *G. shallon* and *G. procumbens* (with finely striate rugulae) (Type RS; Figs. 3-24 M – N, 3-25 C, H or Type RGS; Fig. 3-25 E) but clearly different from other species (intermediate R/RS or Type R; Figs. 3-24 O, 3-25 A – B, D, F – N).

Section *Brossaea* the largest section of *Gaultheria*, contains extremely variable species and is characterized by racemose flower, but rarely (only) solitary species (Middleton 1991). The wide morphological variability is also found and supported by the palynological characters (Tables 3-6-1 – 3-6-2). Within the Sect. *Brossaea*, pollen tetrads of subsect. *Botryphoros* is characterized by minute grains ($E \leq 23.4 \mu\text{m}$) and subsect. *Dasyphyta* by relatively larger grains ($E \geq 24.7 \mu\text{m}$) (Table 3). The close relationship among members of ser. *Domingenses* and ser. *Tomentosae* of subsect. *Dasyphyta* (Middleton 1991) is also supported by palynological observations (Tables 3-6-1 – 3-6-2; Figs. 3-25 A, C – G).

Most species of *Gaultheria* are characterized by the exine sculpture coarsely rugulate to coarsely rugulate-psilate, the rugulae faintly and finely striate, the relatively exceptional exine sculpture with clearly striate rugulae (Type RS; Fig. 3-25 H) may support the recognition of *G. procumbens* as a member of monotypic sect. *Gaultheria* (Table 2). Moreover, the exine sculptures of *G. procumbens* (Fig. 3-25 H) and *G. maqueliiana* (R/RS; Fig. 3-24 G) may also support the close relationship between these two species as reported by Airy-Shaw (1940).

Section *Monoanthea*, one of the large sections of *Gaultheria*, contains most of the solitary flowered species without apical bracteoles, and the monotypic sect. *Pseudogaultheria* primarily characterized by racemose type of inflorescence and temperate South American distribution (Middleton 1991). Palynological characters of both these two section have some distinctions, which support their systematic position as different sections within the genus *Gaultheria* (Tables 3-6-1 – 3-6-2, Figs. 3-25 I – N).

Gaylussacia

Gaylussacia is a genus of about 50 understory shrub commonly known as huckleberries, is distributed geographically in a disjunct pattern in North and South America (Floyd 2002). Based on morphology Sleumer (1967) recognized these species in three sections: sect. *Gaylussacia*, *Decamerium* and *Vitis-idaea*.

Gaylussacia baccata of sect. *Decamerium* is characterized by relatively smaller pollen tetrad with lower values in aperture length, $2f/D$ and apocolpial exine thickness (42.9 μm , 15.6 μm , 0.36 and 1.9 μm , respectively), higher values in D/d , P/E , aperture width and septum thickness (1.37, 0.73, 3.3 μm and 1.6 μm , respectively) and relatively exceptional sculpture (Tables 3-6-1 – 3-6-2; Type RG; Fig. 3-35 O).

On contrary, species of sect. *Gaylussacia* are characterized by relatively larger pollen tetrad with higher values in aperture length, $2f/D$ and apocolpial exine thickness, lower values in D/d , P/E , aperture width and septum thickness (Tables 3-6-1 – 3-6-2; Figs. 3-35 M – O, 3-36 A – B) except in *G. virgata* var. *virgata* which possessed the smallest tetrads (41.4 μm). Thus palynological features may support the infrageneric classification of *Gaylussacia* by Sleumer (1967).

Lyonia

Lyonia, a genus of 36 species (52 taxa) of trees and shrubs, occurs in eastern Asia, the

Greater Antilles and continental North America (Judd 1995a). The genus *Lyonia* is divided into four sections; sect. *Pieridopsis* (comprising 5 species, occurring in eastern Asia), monotypic sect. *Arsenococcus* (including *L. ligustrina*), sect. *Maria* (including *L. mariana* and *L. lucida*), and sect. *Lyonia* (comprising 28 species, occurring mostly in mountainous regions of Greater Antilles).

The palynological features of different sections support the infrageneric classification of *Lyonia* (Tables 3-6-1 – 3-6-2, Figs. 3-28 H – O). The sister relationship between *Lyonia ligustrina* and *L. ovalifolia* as identified by combined analysis morphological and molecular data (Kron and Judd 1997), may also be supported and confirmed by palynological data (Tables 3-6-1 – 3-6-2; R/RS; Figs. 3-28 J, O).

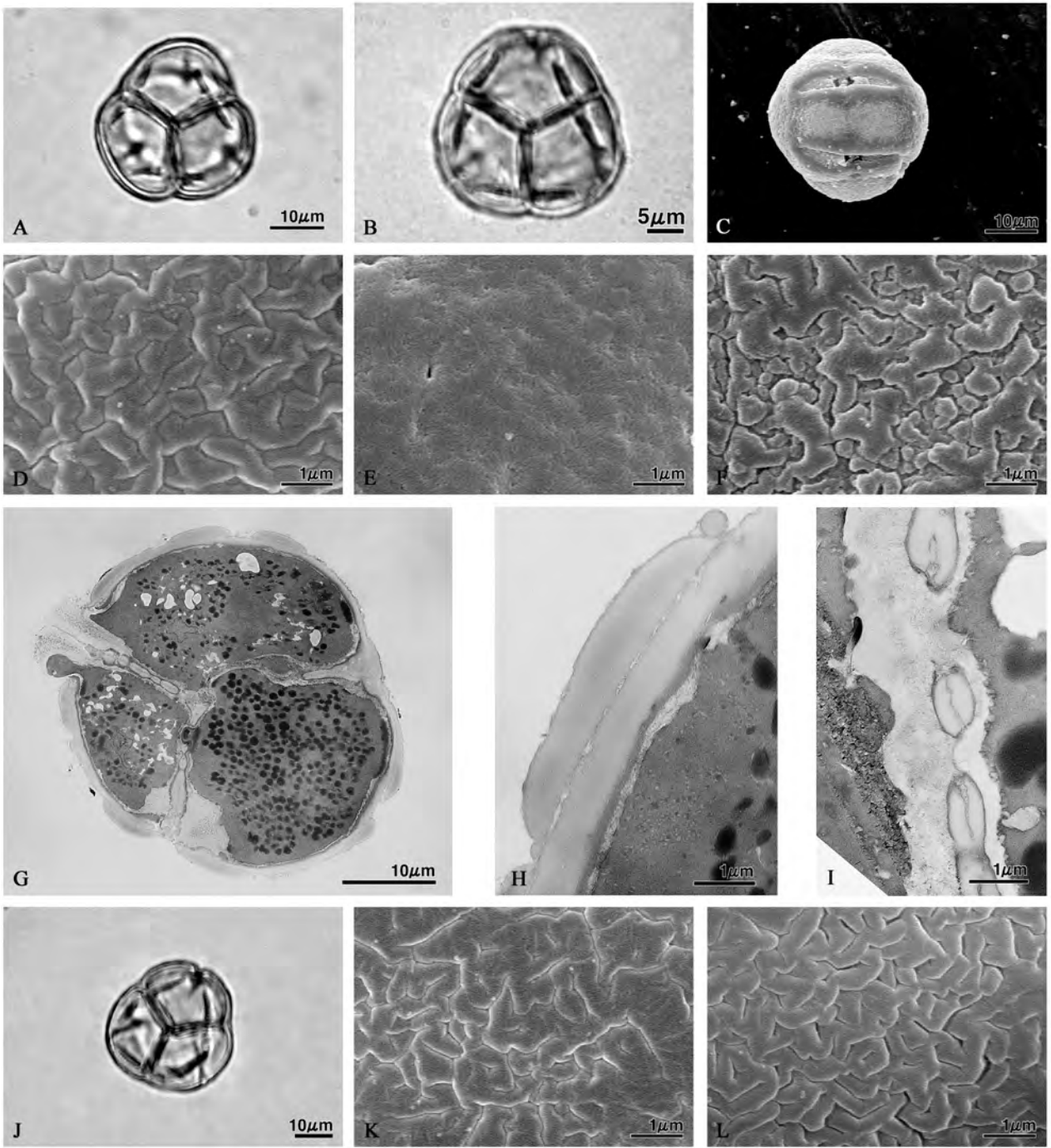

Fig. 3-23.

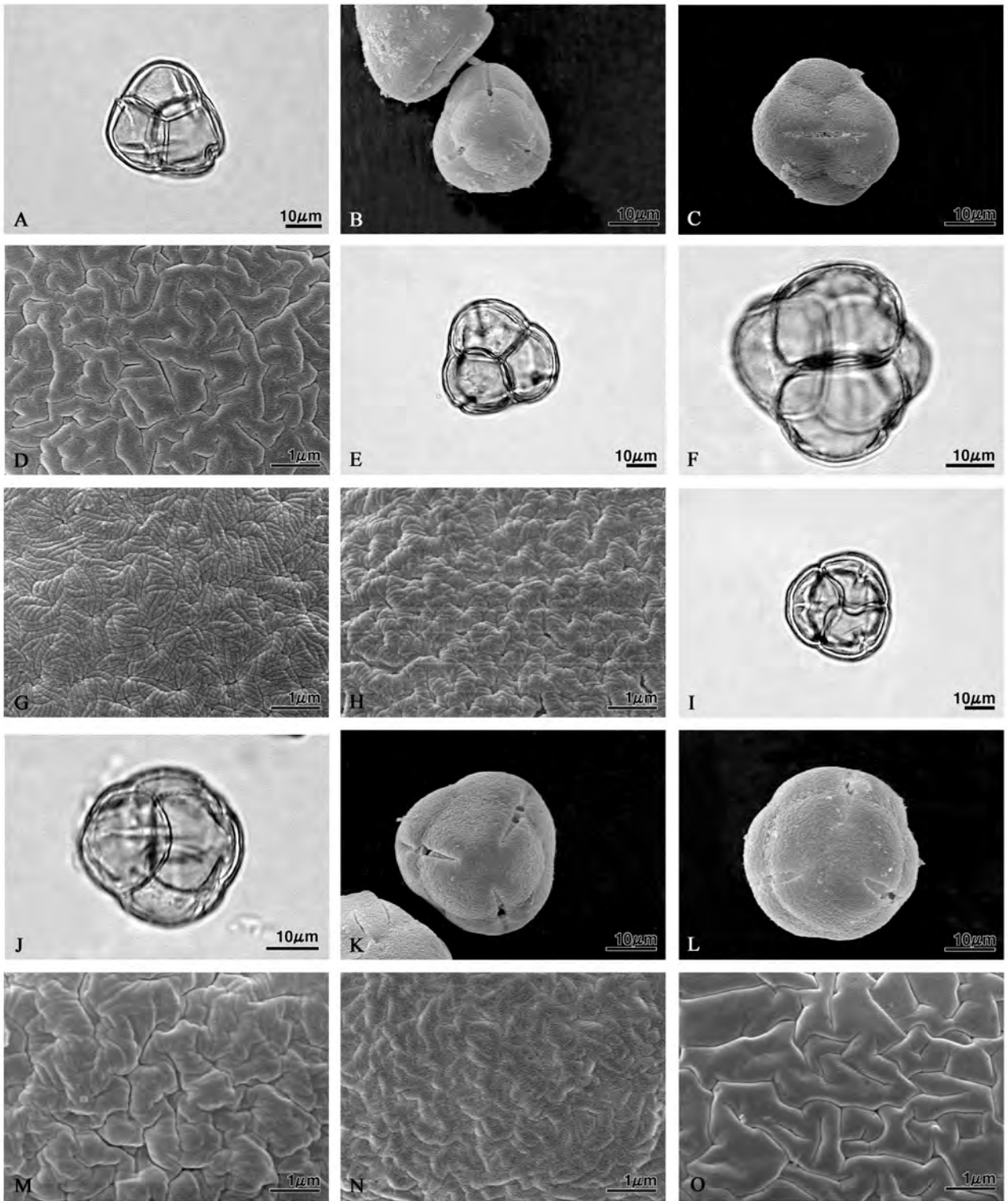

Fig. 3-24.

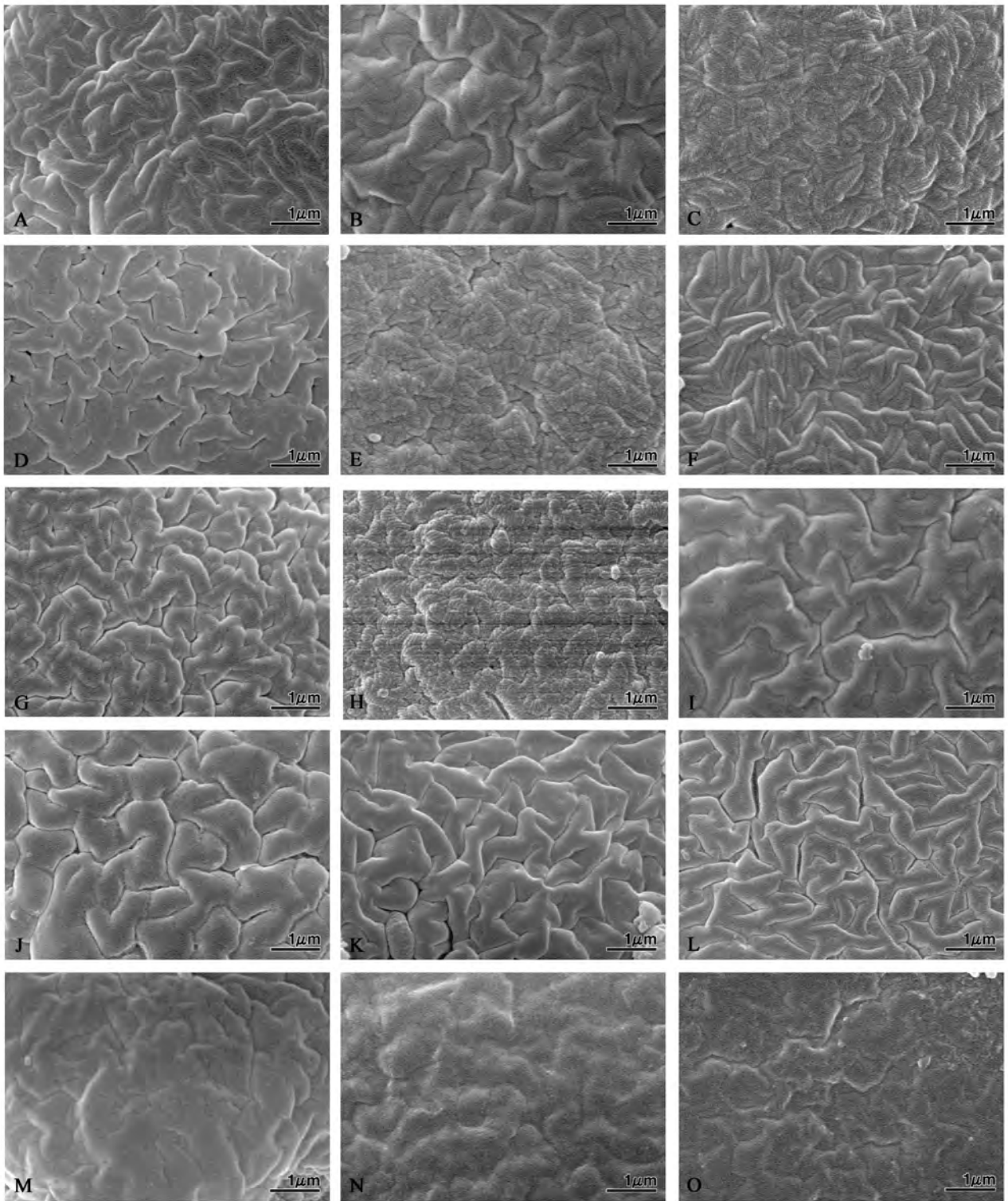

Fig. 3-25.

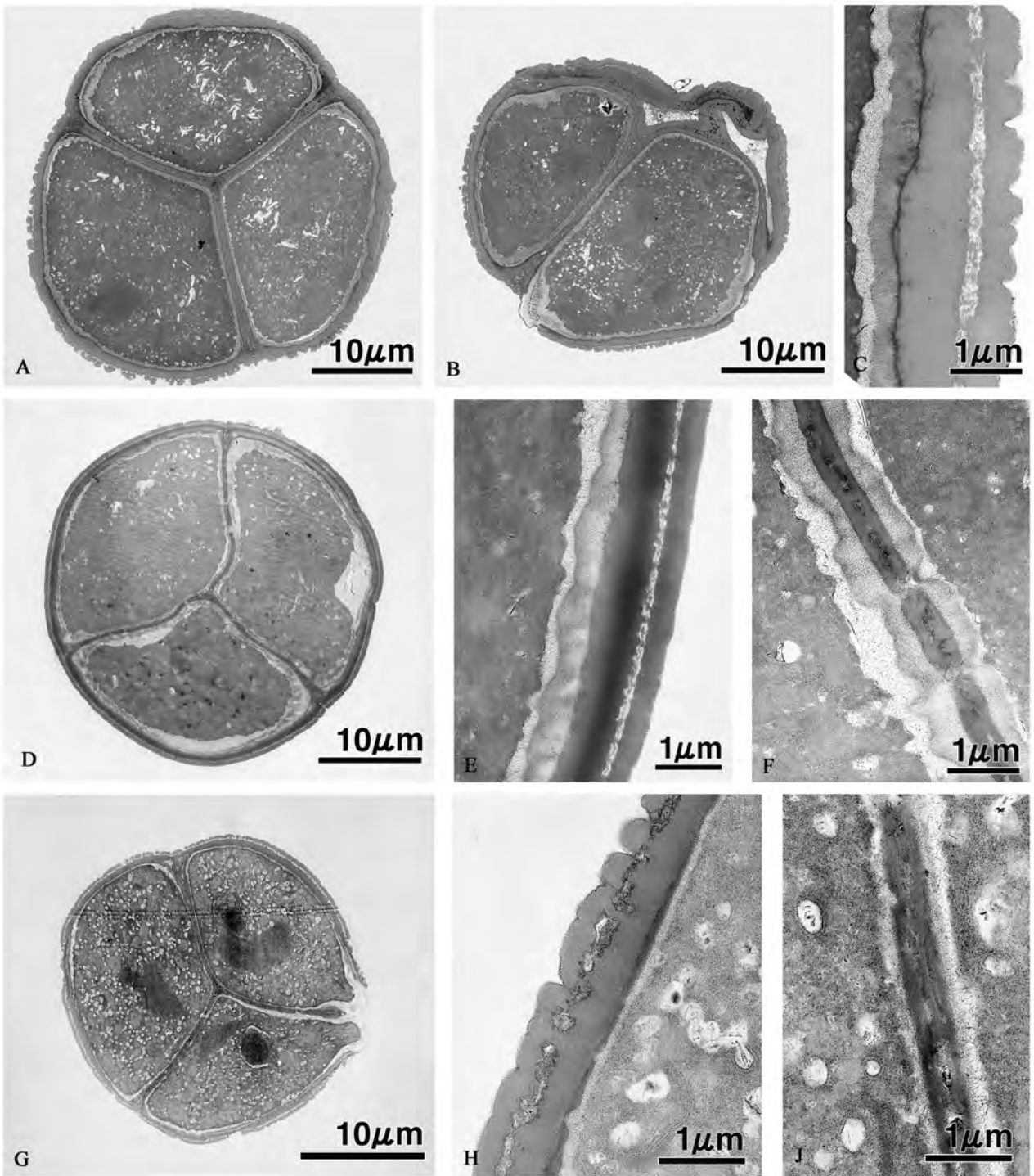

Fig. 3-26.

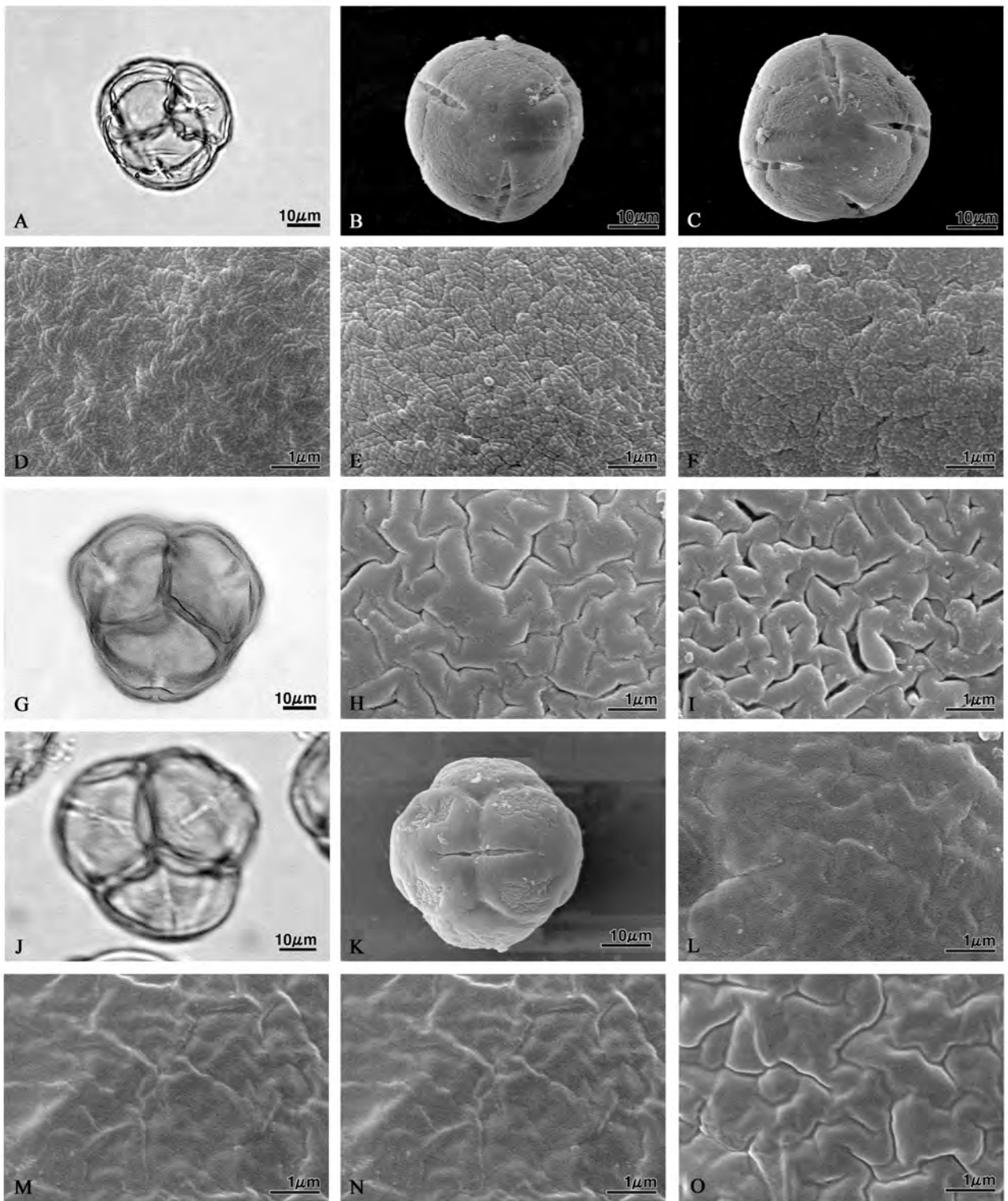

Fig. 3-27.

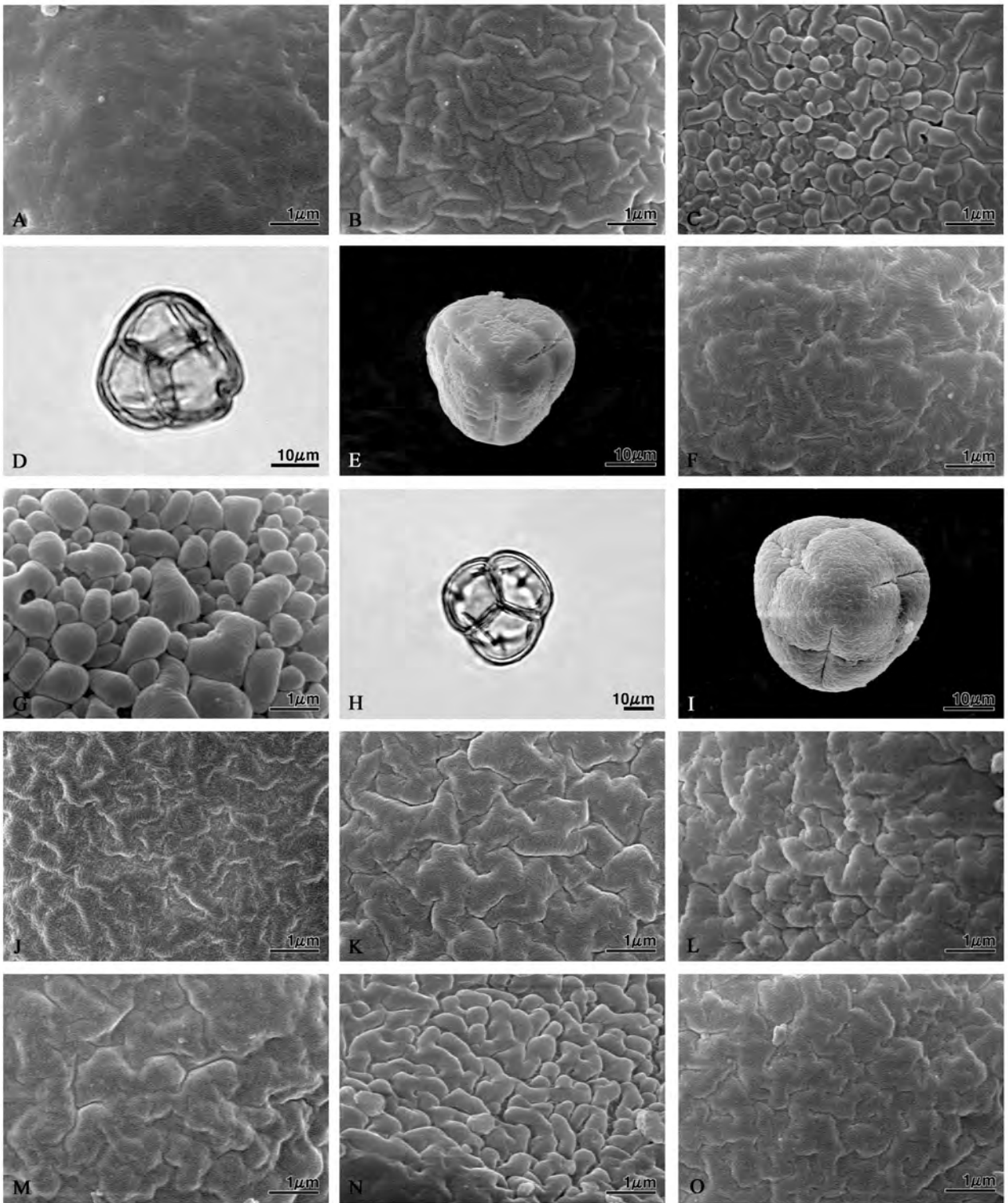

Fig. 3-28.

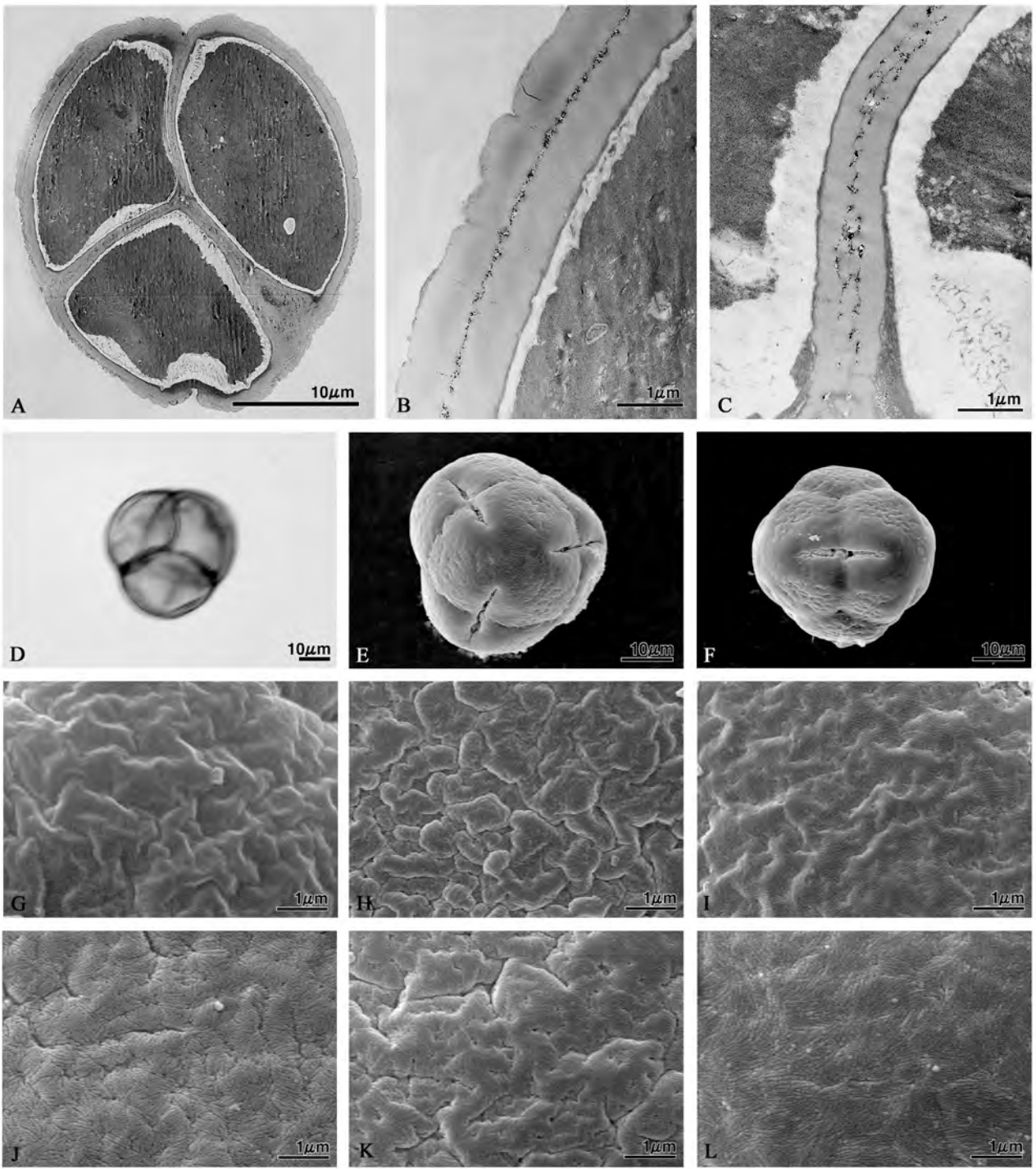

Fig. 3-29.

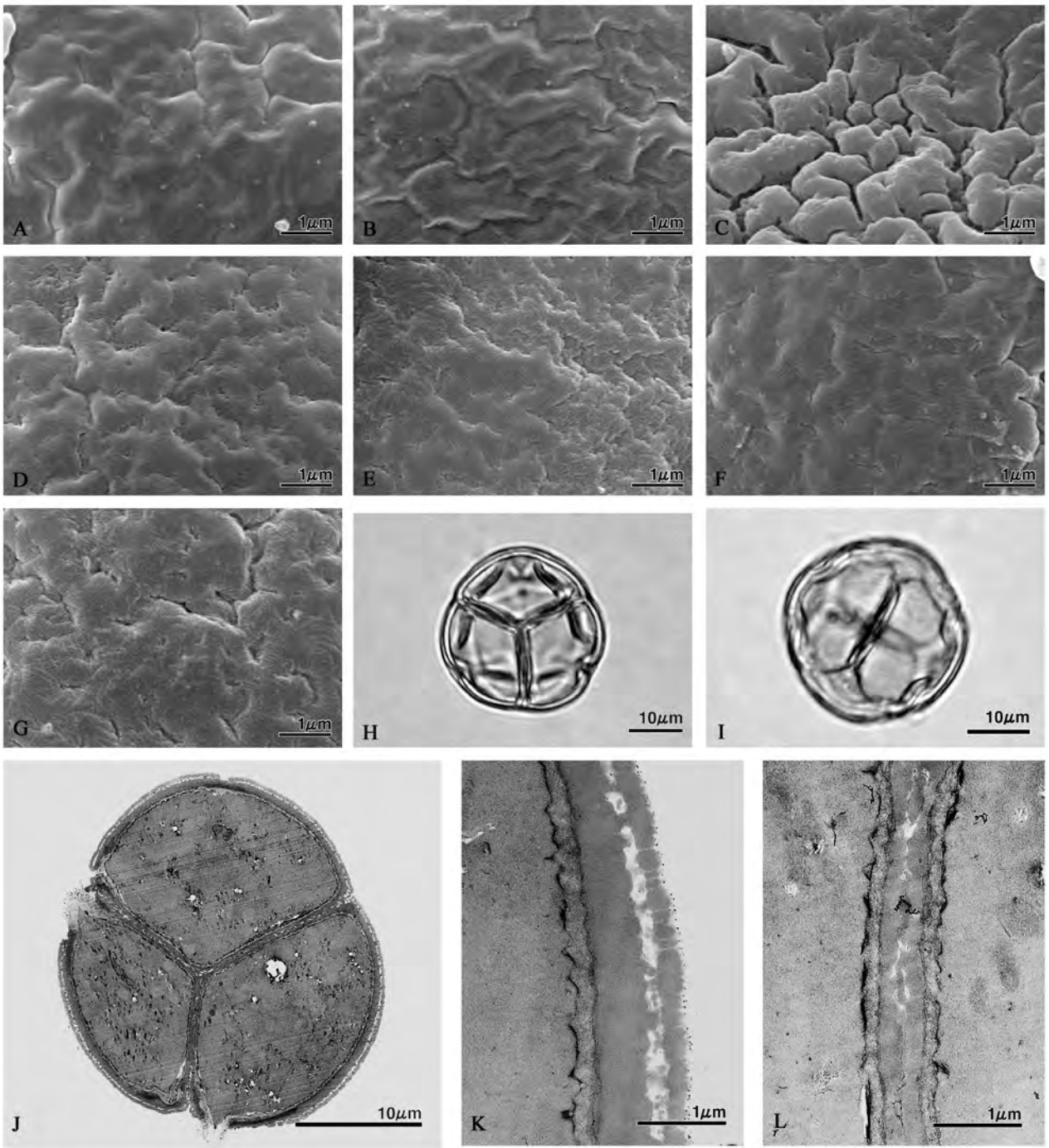

Fig. 3-30.

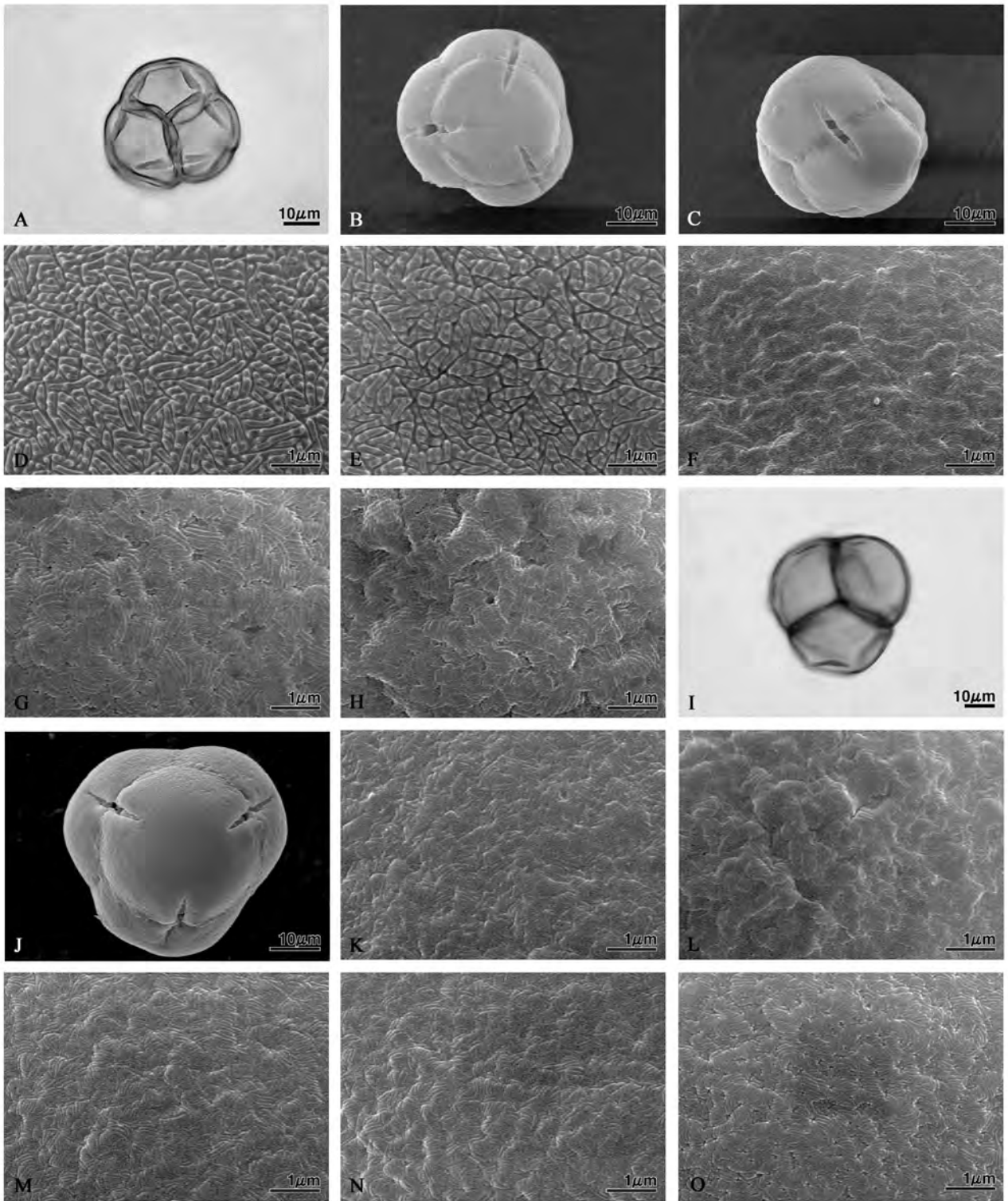

Fig. 3-31.

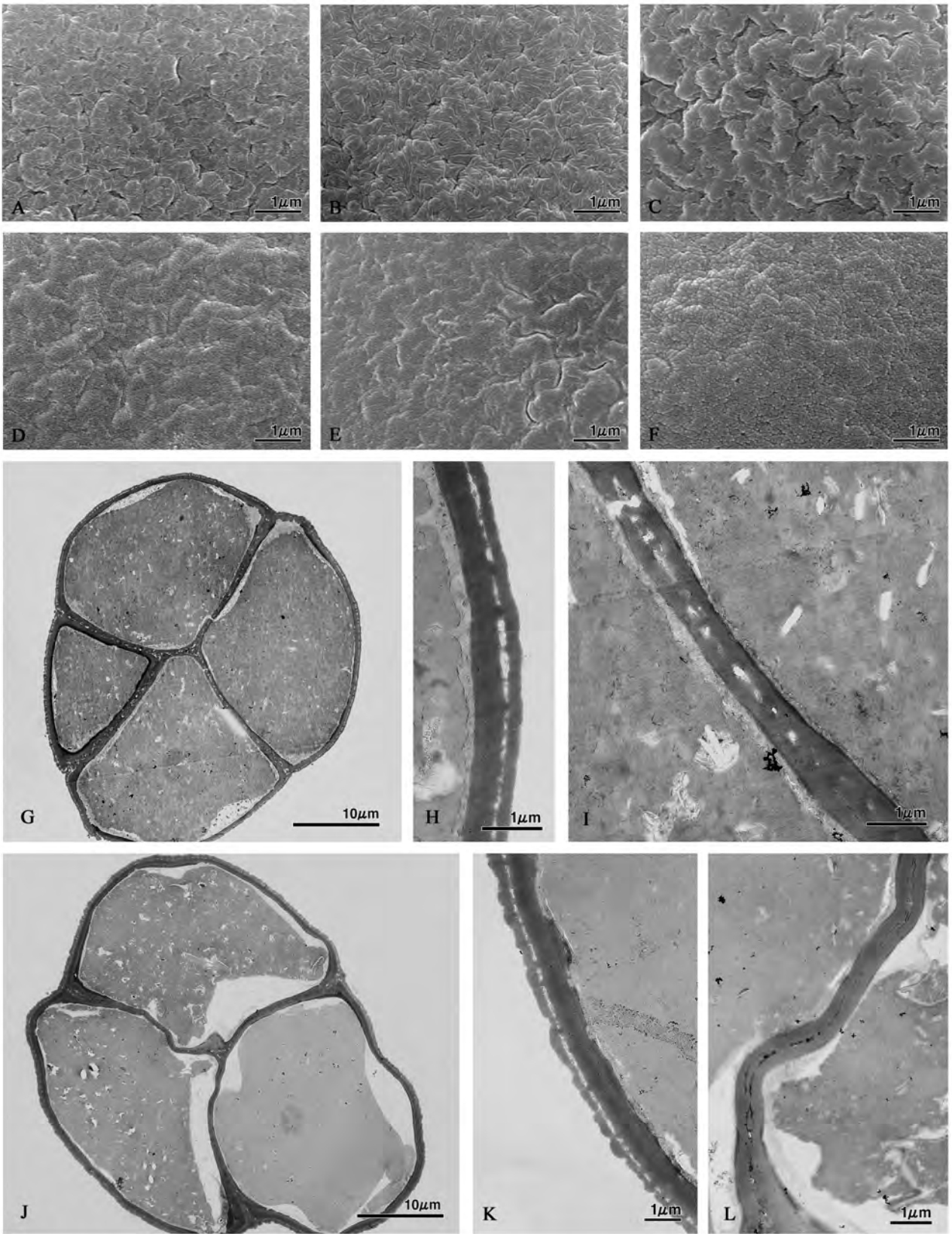

Fig. 3-32.

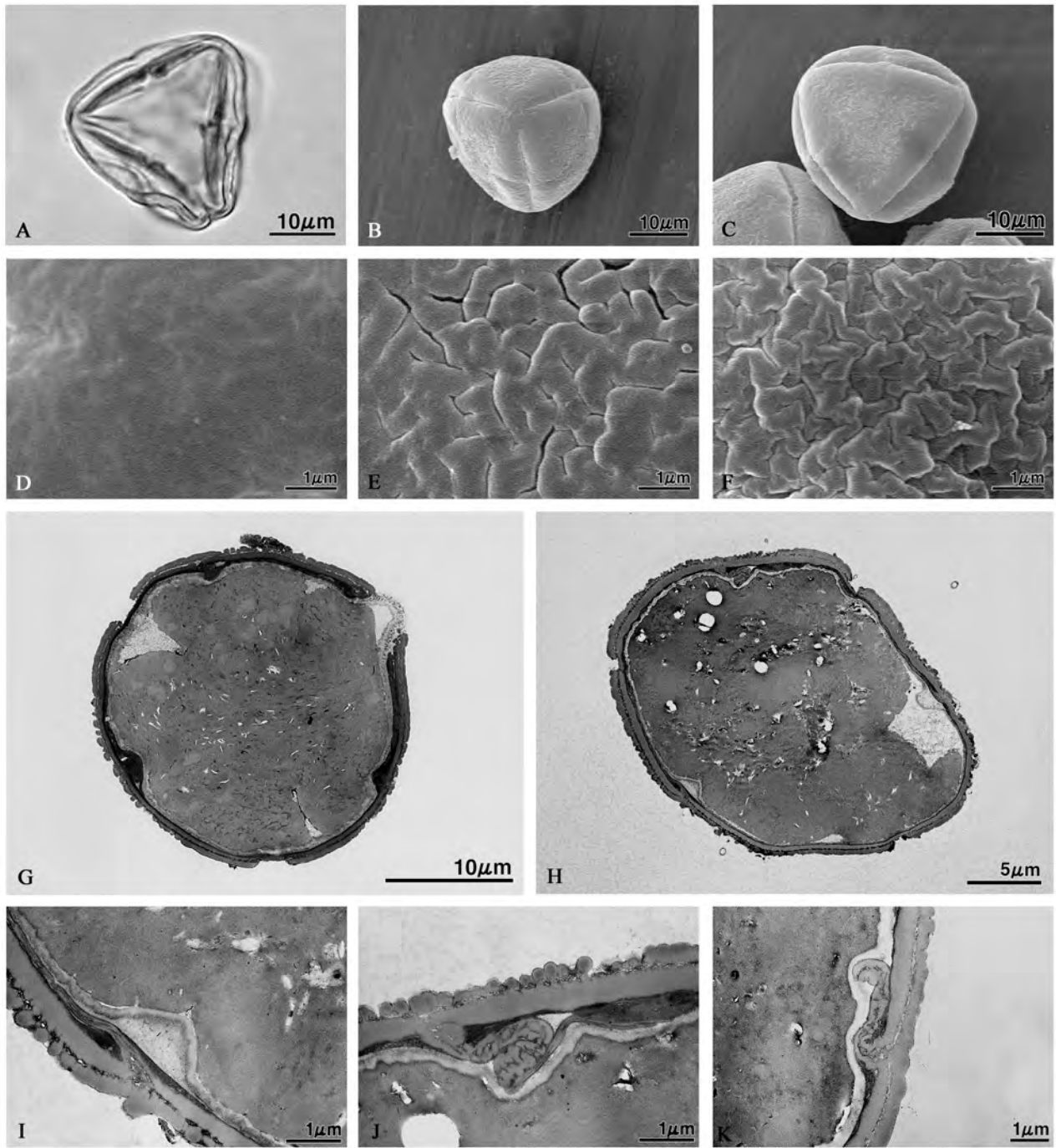

Fig. 3-33.

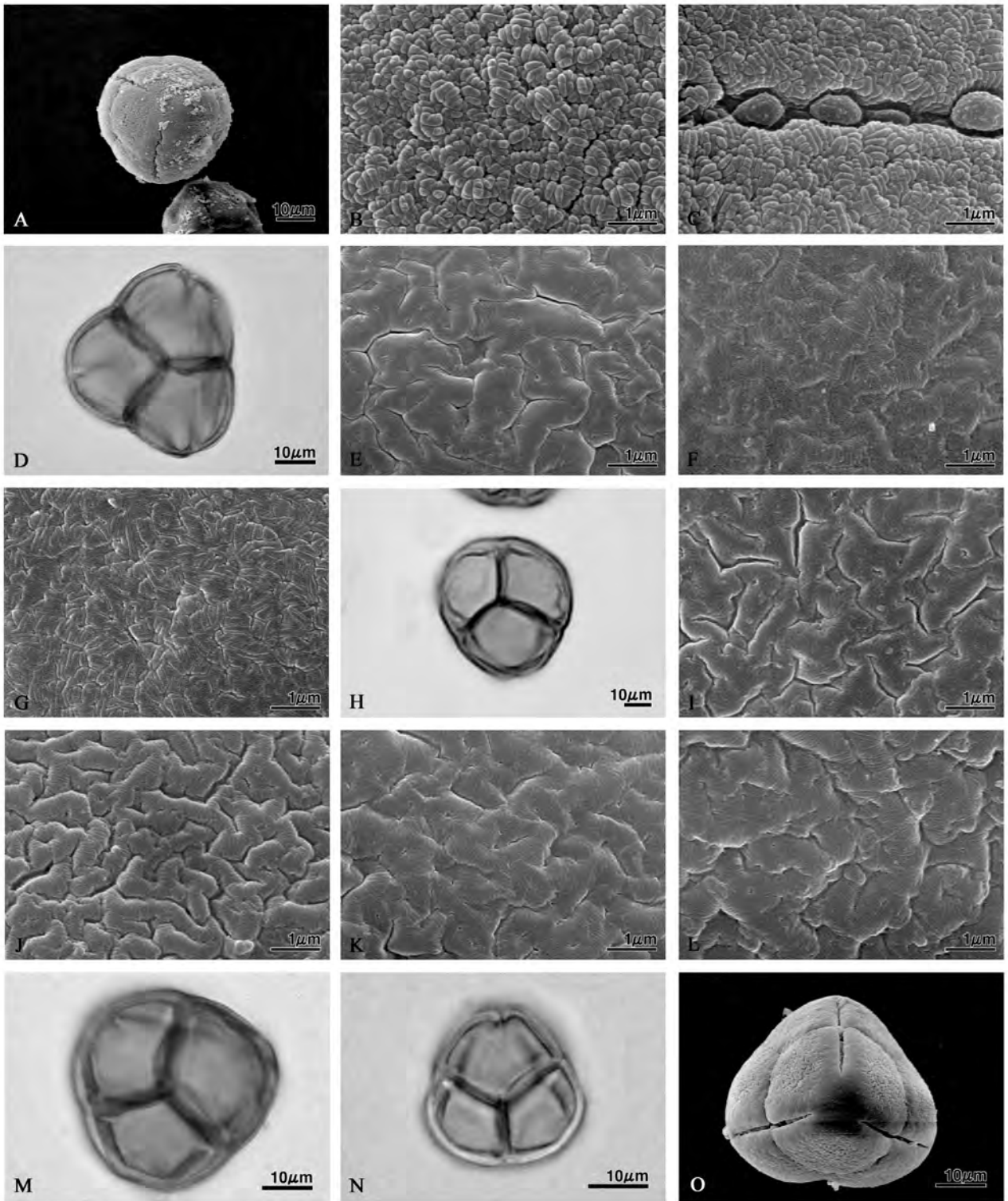

Fig. 3-34.

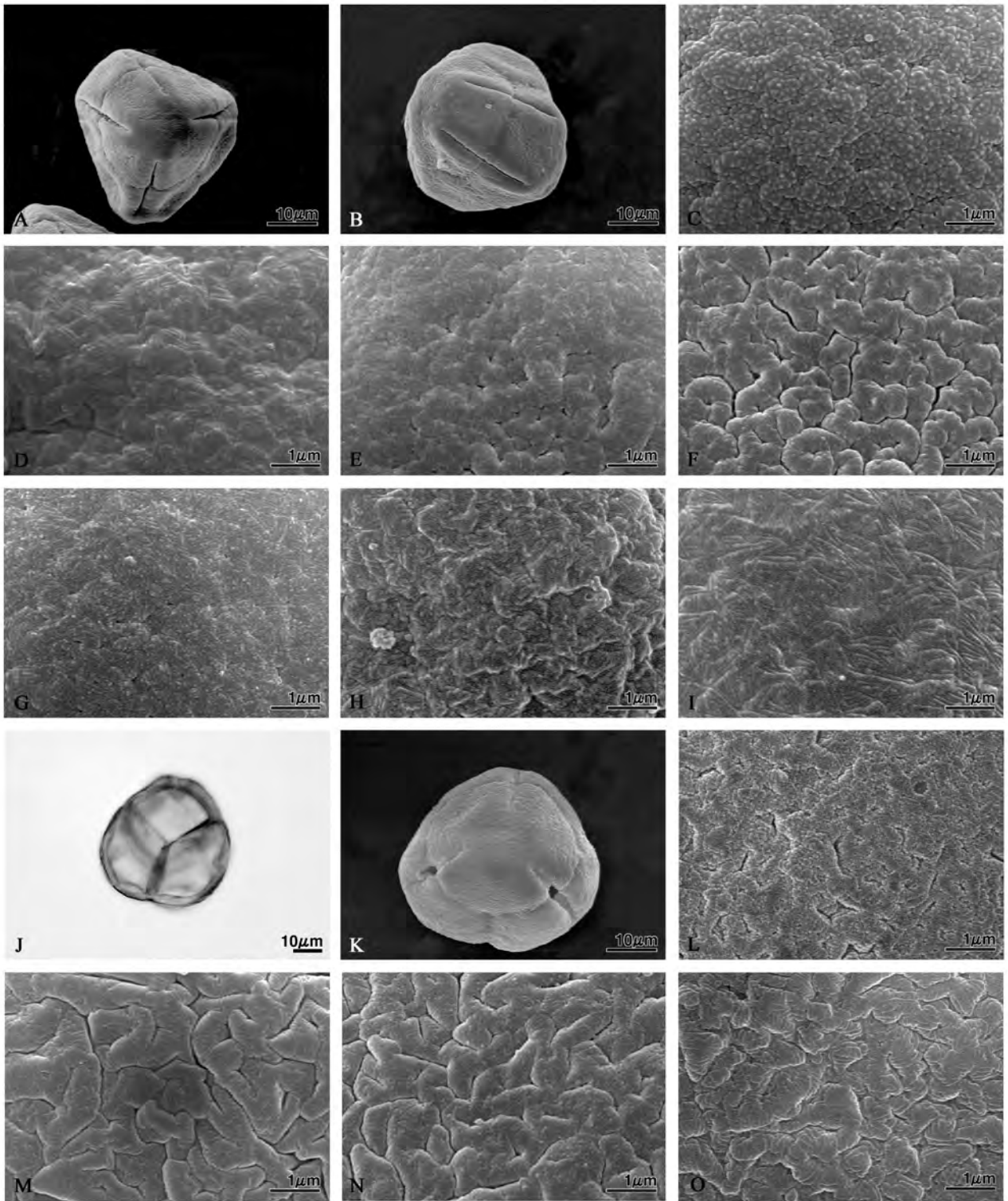

Fig. 3-35.

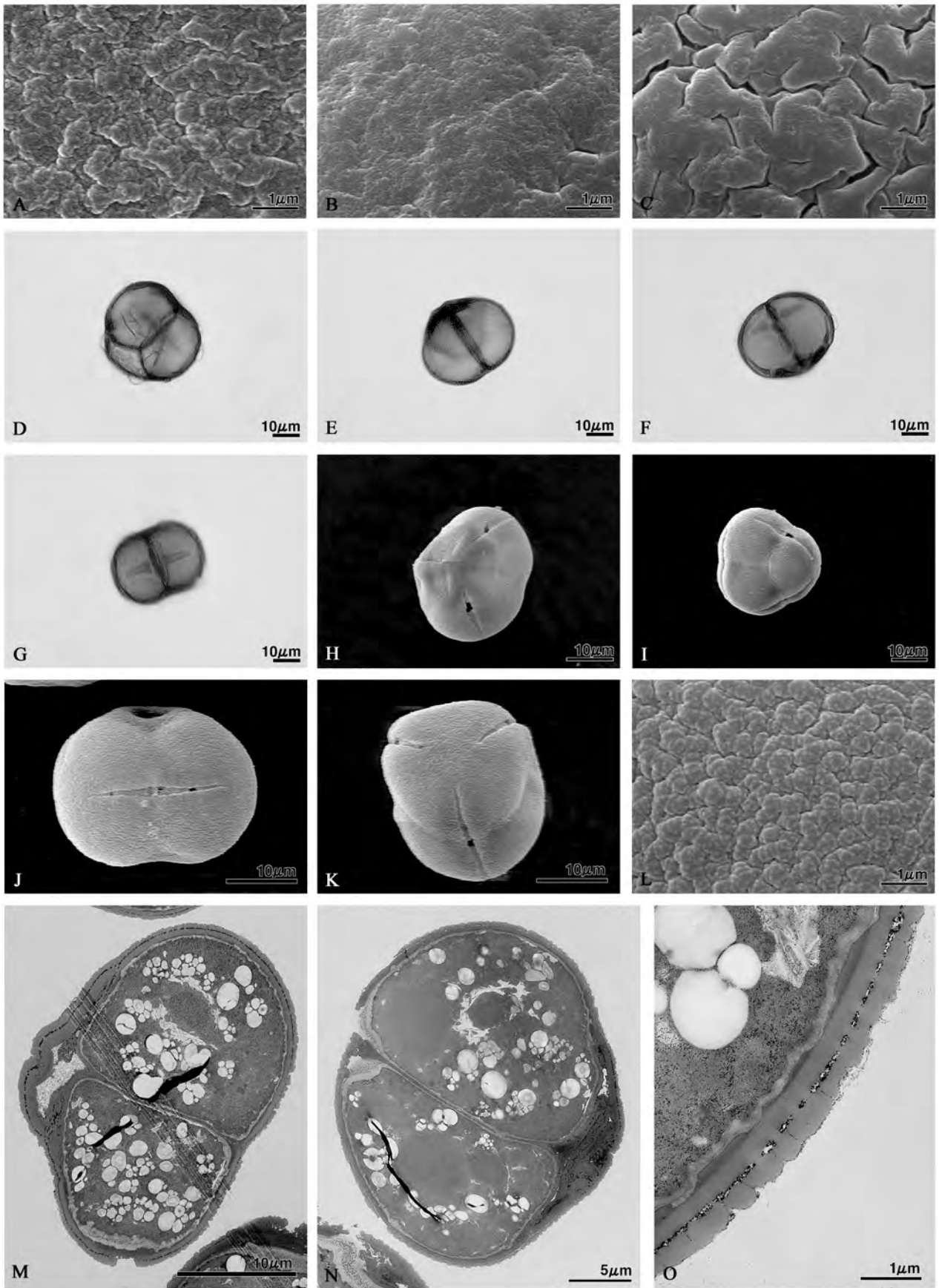

Fig. 3-36.

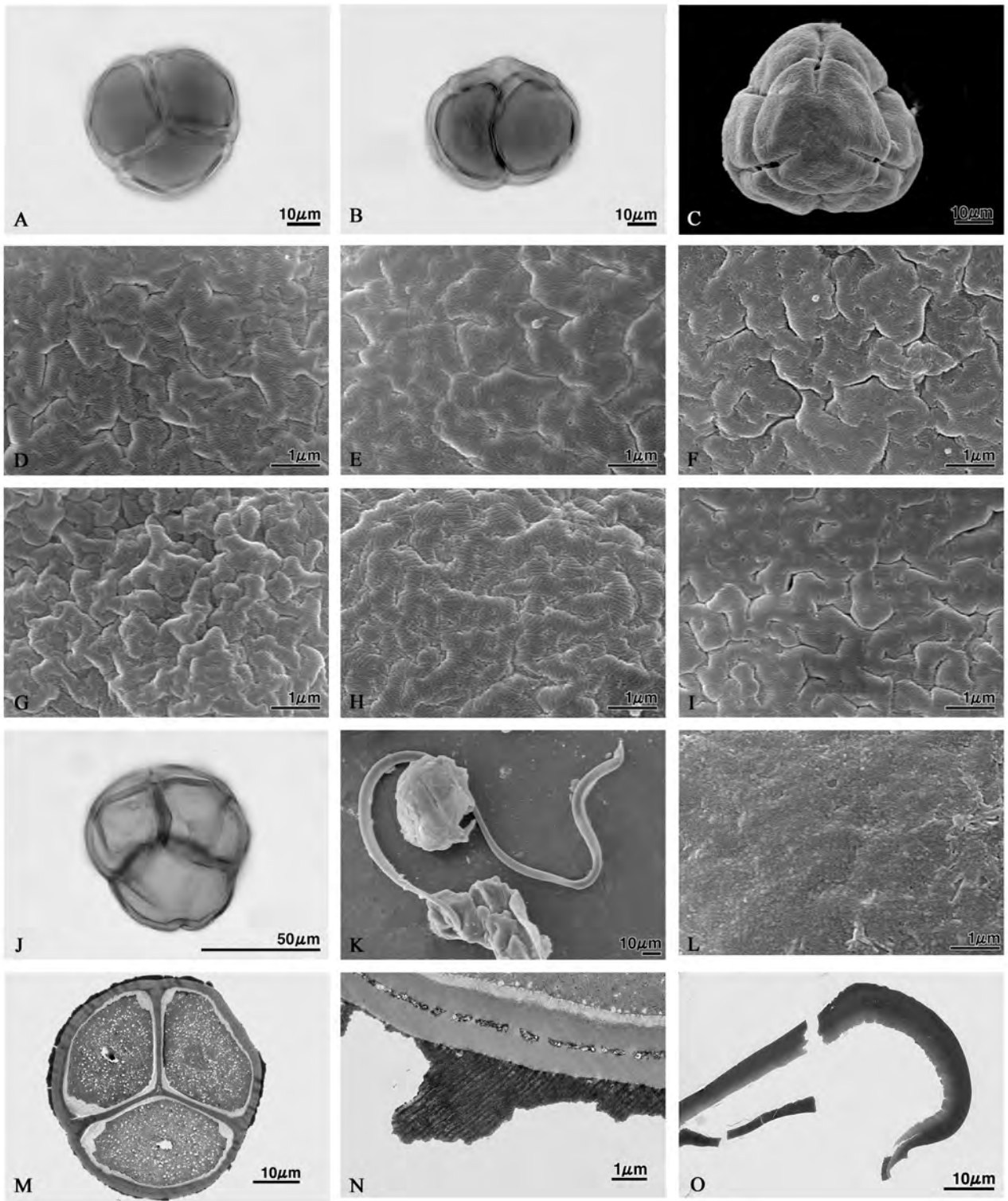

Fig. 3-37.

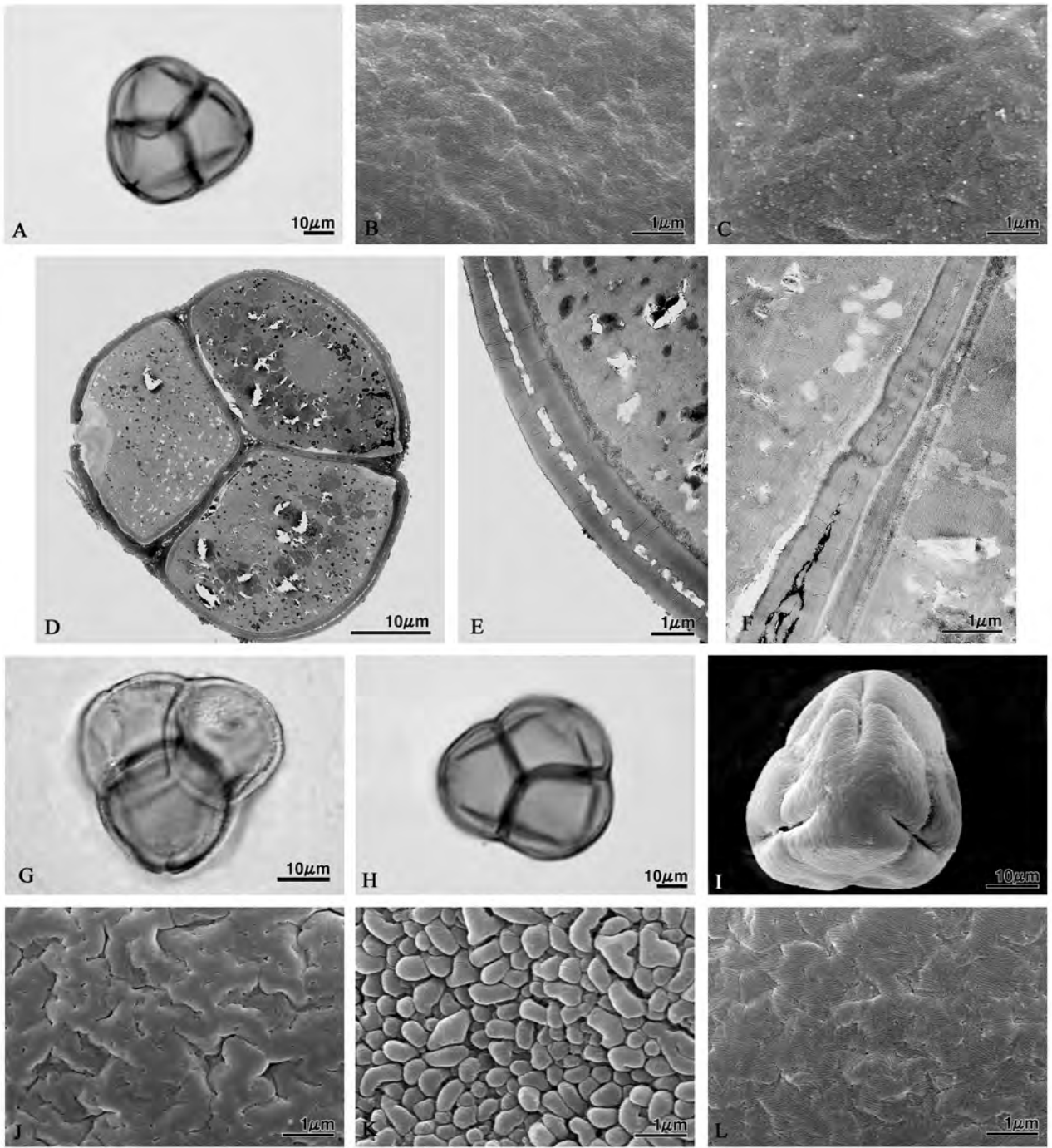

Fig. 3-38.

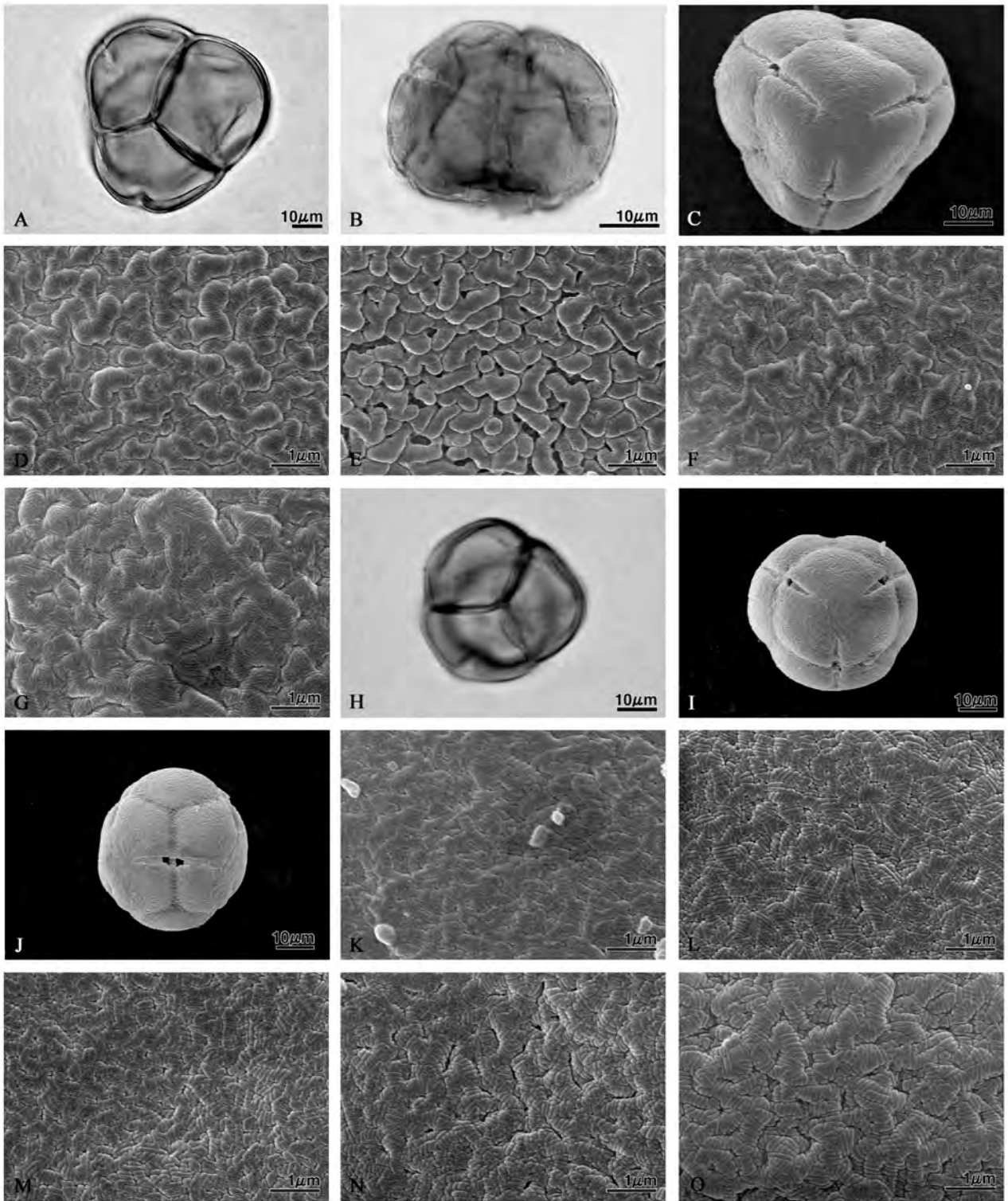

Fig. 3-39.

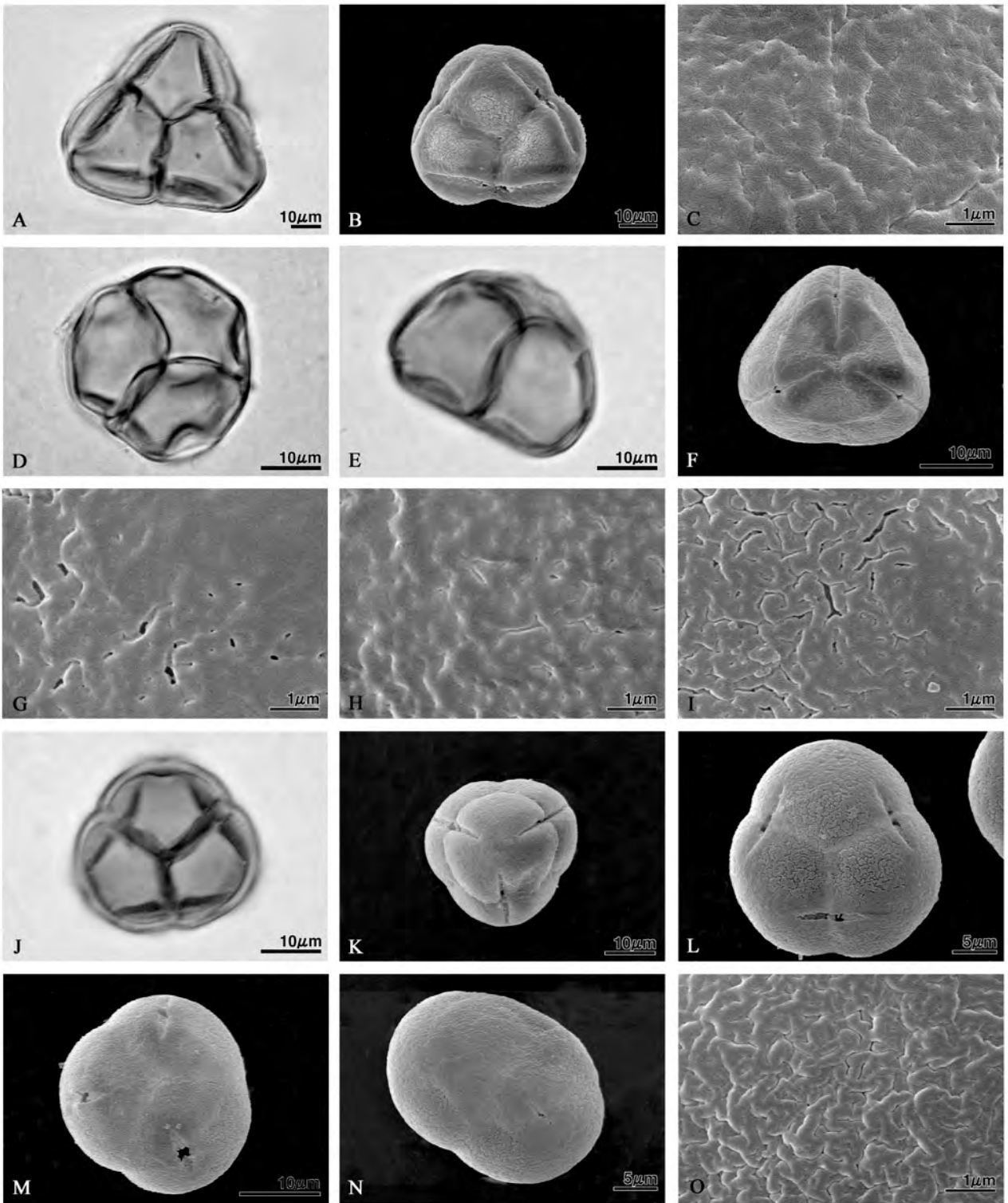

Fig. 3-40.

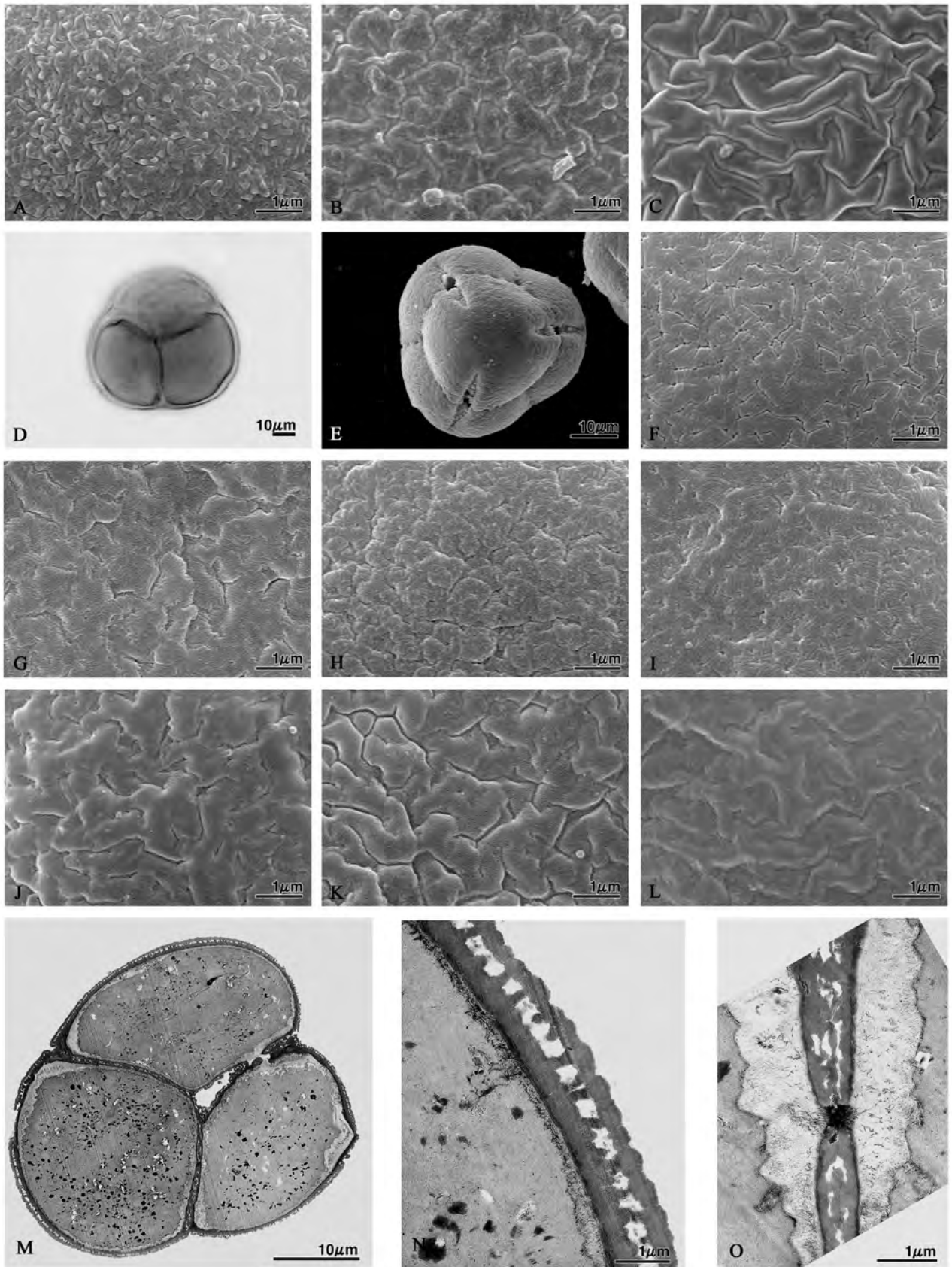

Fig. 3-41.

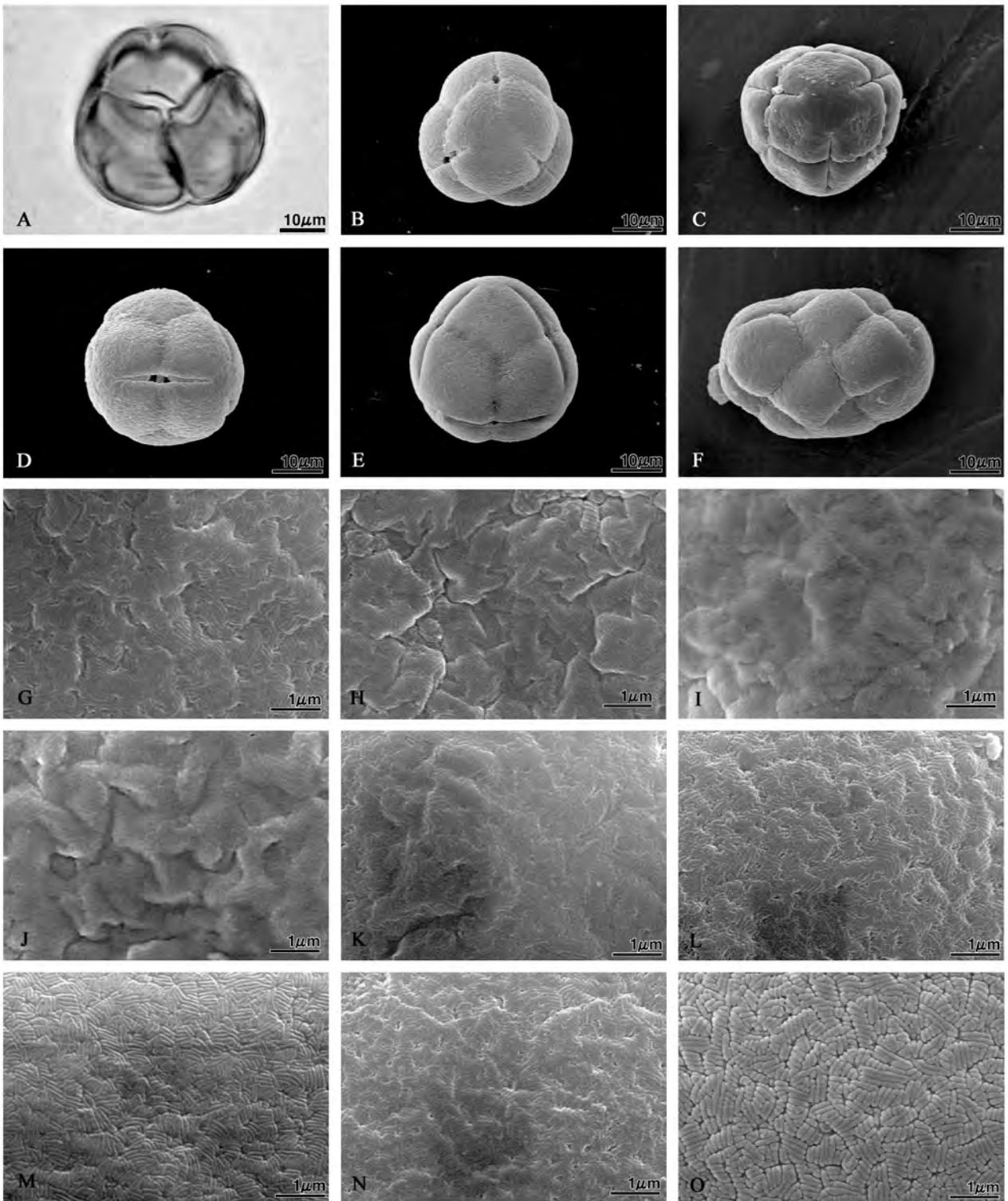

Fig. 3-42.

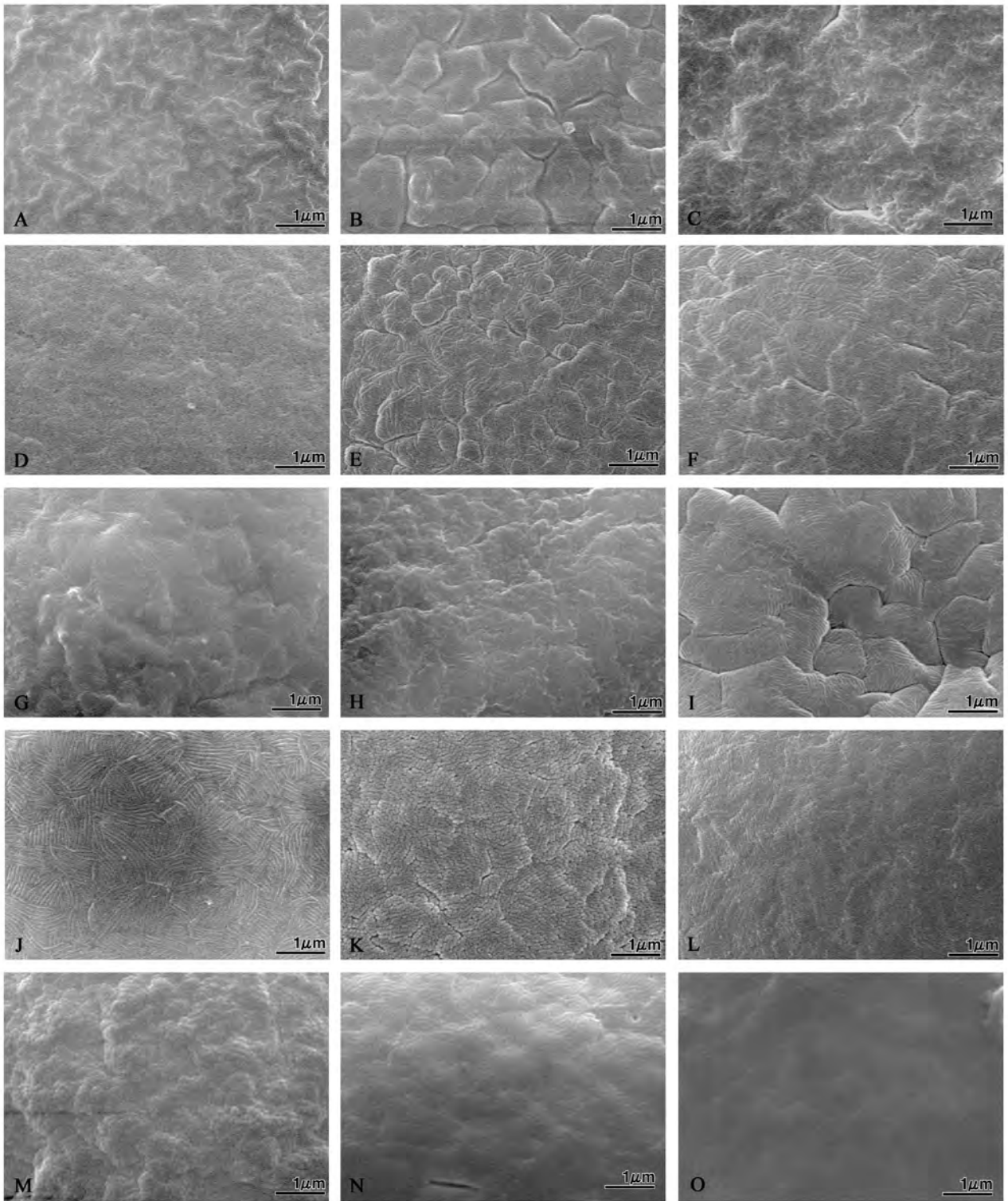

Fig. 3-43.

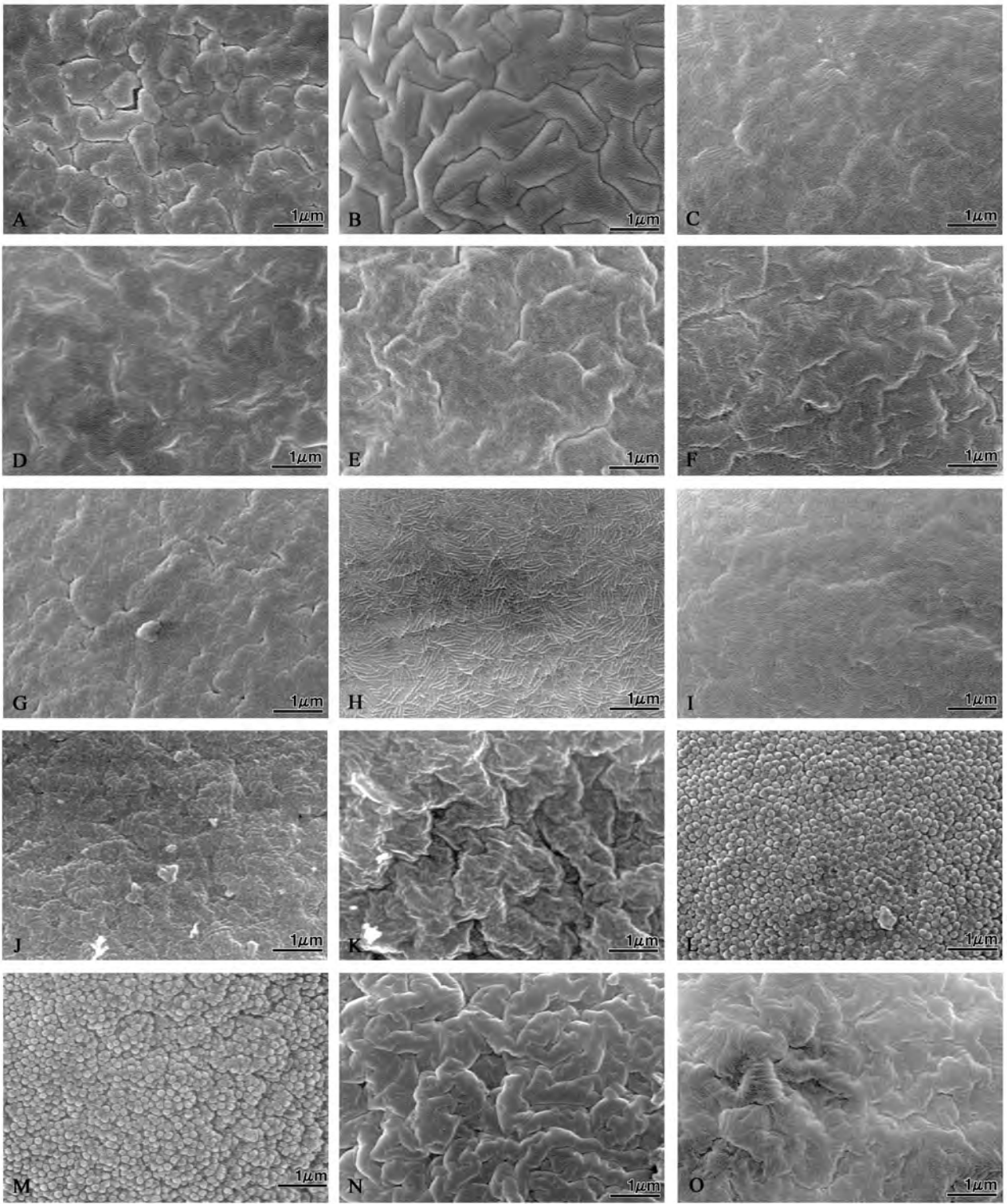

Fig. 3-44.

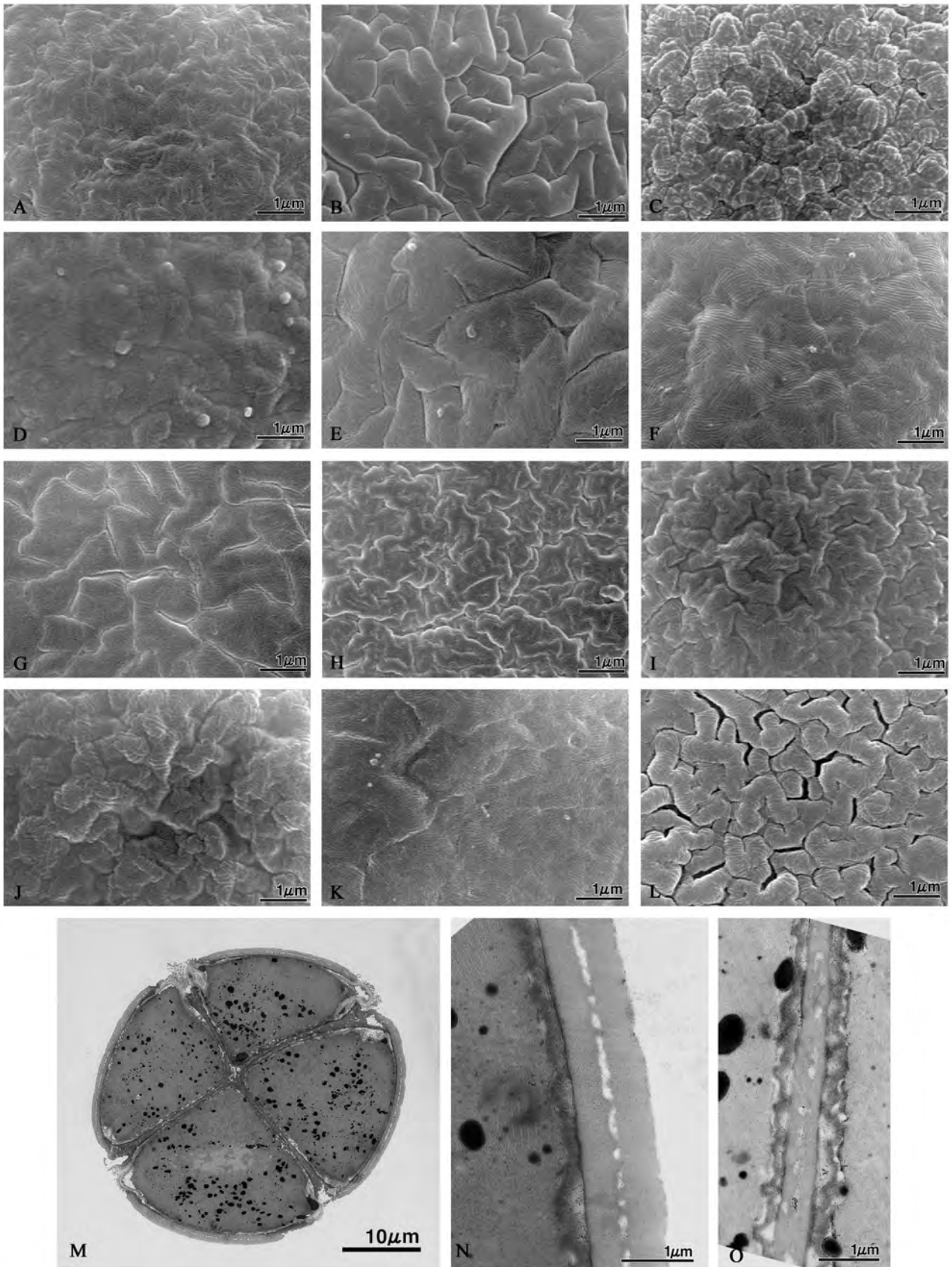

Fig. 3-45.

Chapter 4

General Discussion

A large number of palynological features were assessed in this study and their taxonomic utilities have been discussed in previous chapter. All these characters did not possess the similar taxonomic importance. This was done, because there is no way to know beforehand (a priori) whether a character will be valuable taxonomically or not (Stuessy 1990). As illustrated in the previous chapter (Chapter 3), certain pollen characters may be very plastic in one group and rather conserved in another. Hence, no overall systematic value can be assigned to these characters or character states, and their values should be assessed separately for each group studied. This is very much in accordance with what is observed for most morphological characters within Ericaceae. Different palynological features were emerged as taxonomically important in taxa of different taxonomic levels (Chapter 3). Similar conclusion was also drawn for the palynological characters of the family Rubiaceae (Dessein et al. 2005).

Five palynological characters are plotted on the phylogenetic tree of Ericaceae (Kron et al. 2002a; Fig. 1-2), i.e., pollen dispersal unit (Fig. 4-1), compactness of tetrad (Fig. 4-2), grain shape (Fig. 4-3), the type and/or presence of secondary sculpture (Fig. 4-9) and the sexine-nexine ratio (Fig. 4-10). But, all the pollen morphological differences among the species of Ericaceae are considered in this study and their taxonomic and evolutionary significances are discussed in the following paragraphs. The possible relationship of pollen morphology of Ericaceae with other biotic and abiotic factors such as pollination biology and geographical distribution, are also discussed.

Pollen dispersal unit

All three major types of pollen dispersal units (PDU), viz. monad, tetrads – isodynamosporus or heterodynamosporus, and polyad occur in Ericaceae (Takahashi 1986a & b, 1987a, Quinn et al. 2005). No species were found having both monad and tetrad pollen grains. Tetrad is the most common dispersal unit found in the most genera of this family and polyads are found in only one genus *Chimaphila* (Table 4-1). Although the monad is very common type of PDU in angiosperms, it is rare in Ericaceae. Only found in genus *Enkianthus* of the monogeneric subfamily Enkianthoideae, in the tribe Monotropeae and Pterosporeae, *Orthilia* of Pyroleae, and some *Erica* species of Ericaceae. Monad pollen varies a little in their gross morphology (e.g., only in P/E ratio, Chapter 3). On the other hand, tetrad pollen differs greatly in their arrangement and gross morphology; commonly isodynamosporus – tetrahedral, rarely decussate, tetragonal or other uniplanar tetrad, but heterodynamosporus in Styphelioideae (Quinn et al. 2005) and sometimes Vaccinioideae (Chapter 3). The pollen of *Calluna vulgaris* generally occurs as irregular tetrads. The genus *Erica* is the only member of Ericaceae which possesses both monad and tetrad type of PDU. Although it was previously reported that both monads and tetrads are the pollen dispersal units in Ericaceae (e.g., Erdtman 1952, Oldfield 1959), a partial information, tetrads as the only pollen dispersal unit was also reported by some researchers (e.g., Maguire et al. 1978), or monad pollen grains only found in the subfamily Ericoideae *sensu* (Stevens 1971) and not in the subfamily Rhododendroideae and Vaccinioideae (e.g., Davis 1997). This misconception most probably arose because they studied pollen morphology of a limited geographic area and/or exclusion of some taxa which have monad pollen grains.

Previously pollen in heterodynamosporus tetrad was thought to be a specialized palynological character found only in the subfamily Styphelioideae (e.g., Erdtman 1952, Quinn et al. 2005). But in the present study, pollen grains in heterodynamosporus tetrads were also found in the tribe Vaccinieae, and 1 – 2 grains of pollen tetrad poorly developed in

Table 4-1. Pollen dispersal units in Ericaceae.

Name of Taxa	Pollen Dispersal Unit*	Reference
Ericaceae		
Enkianthoideae	Monad	This study
Monotropoideae		
Pyroleae	Monad, Tetrad, Polyad	Takahashi, 1986 a, b
Monotropeae	Monad	Takahashi, 1987
Pterosporeae	Monad	Takahashi, 1987
Arbutoideae	Isodynamosporus tetrad	This study
Ericoideae		This study
Bejarieae	Isodynamosporus tetrad	
Ericaceae	Isodynamosporus tetrad, Monad	This study
Phyllodoceae	Isodynamosporus tetrad	This study
Empetreae	Isodynamosporus tetrad	This study
Rhodoreae	Isodynamosporus tetrad	This study
Cassiopoideae	Isodynamosporus tetrad	This study
Harrimanelloideae	Isodynamosporus tetrad	This study
Styphelioideae		
Prionoteae	Isodynamosporus tetrad	Kron et al, 2002
Archerieae	Isodynamosporus tetrad	Quinn et al. 2005
Oligarrheneae	“Monad”, Iso- and Hetero-dynamosporus tetrad	Quinn et al. 2005
Richeeae	Iso- and Hetero-dynamosporus tetrad	Powell et al. 1997
Epacrideae	Isodynamosporus tetrad	Quinn et al. 2005
Cosmelieae	Isodynamosporus tetrad	Kron et al. 2002
Styphelieae	“Monad”, Iso- and Hetero-dynamosporus tetrad	Quinn et al. 2005
Vaccinioideae		This study
Oxydendreae	Isodynamosporus tetrad	
Lyonieae	Isodynamosporus tetrad	This study
Andromedeae	Isodynamosporus tetrad	This study
Gaultherieae	Isodynamosporus tetrad	This study
Vaccinieae	Iso- and Hetero-dynamosporus tetrad	This study

* “Monad” means not properly investigated; either after acetolysis treatment or with TEM.

tribe Vaccinieae as well as other tribes and/or subfamilies of Ericaceae. These results indicate the possible parallel evolution of “monad breakdown type” pollen development in the tribes Oligarrheneae and Styphelieae of subfamily Styphelioideae and the tribe Vaccinieae of subfamily Vaccinioideae (Tables 4-1, 4-4; Fig. 4-1). The close relationship between the Epacridaceae and Ericaceae on palynological ground has been pointed out by Erdtman (1952), but he did not report the occurrence of heterodynamosporus tetrads in Ericaceae. The occurrence of both iso- and hetero-dynamosporus tetrads seems to confirm the close relationship between the subfamilies Styphelioideae and Vaccinioideae as found in other morphological and molecular data (Kron et al. 2002a).

ERICACEAE stat. nov.

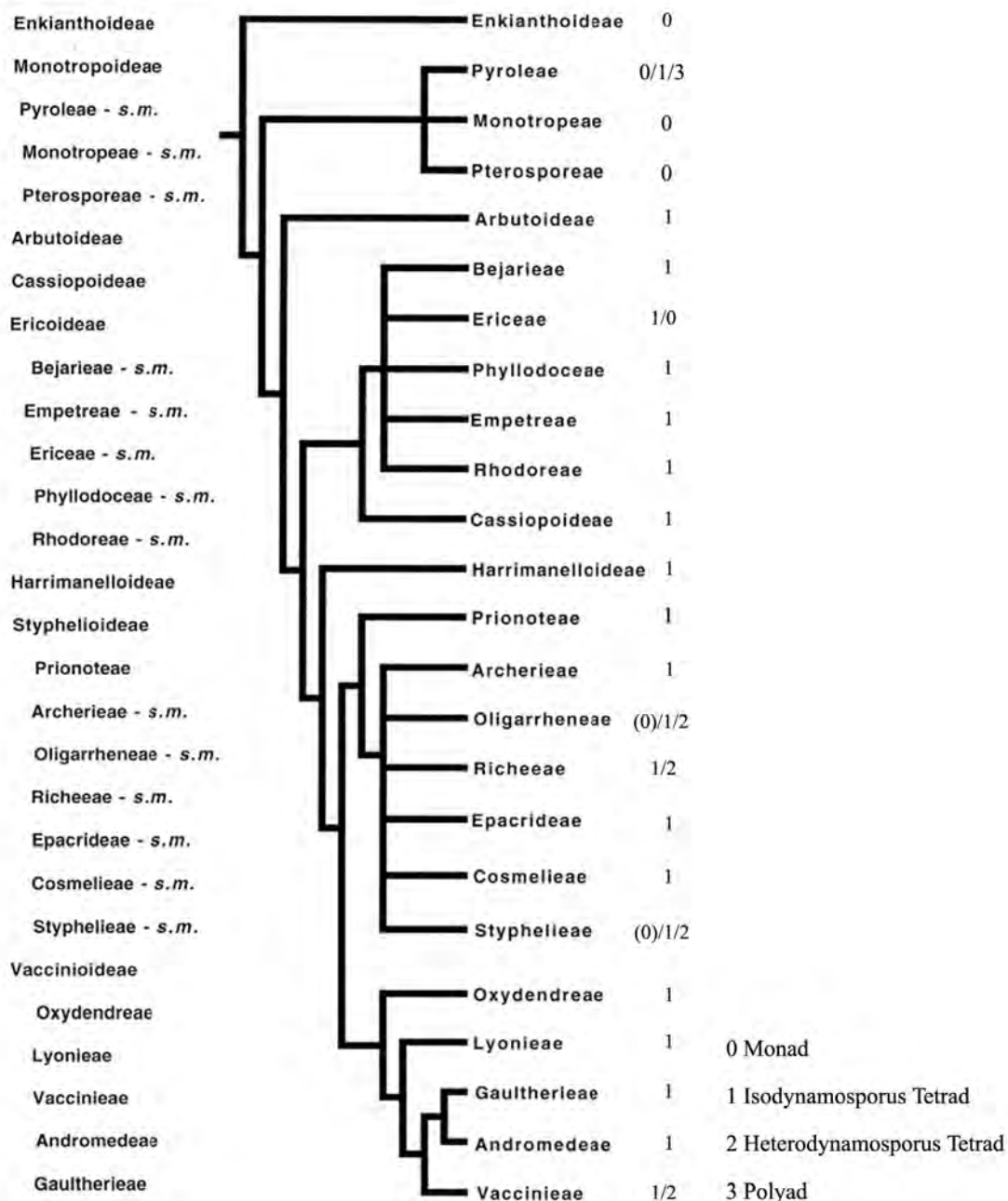

Fig. 4-1. Pollen dispersal units incorporated on the phylogenetic tree of Ericaceae (Kron et al. 2002a);

For character states see Table 4-4; Parenthesis means not methodically indentified.

ERICACEAE stat. nov.

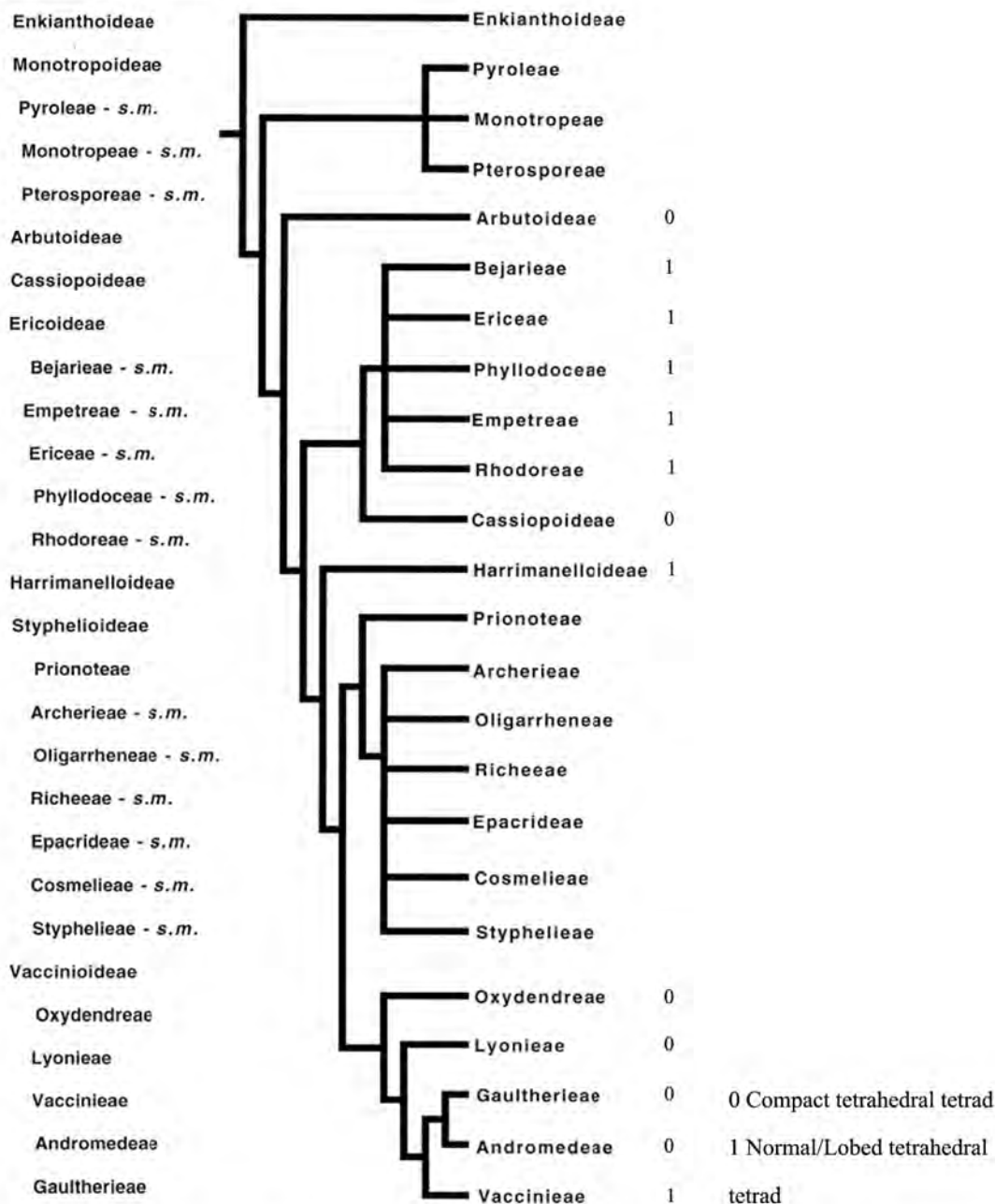

Fig. 4-2. Compactness of pollen tetrads incorporated on the phylogenetic tree of Ericaceae (Kron et al. 2002a); For character states see Table 4-4.

Monad assumed to represent the symplesiomorphic pollen character state is found in the subfamily Enkianthoideae and Monotropeoideae which are identified as sister of the rest of the Ericaceae. On the other hand, the isodynamosporous pollen tetrads are supposed to be the derived one in the Ericaceae (Fig. 4-1). Moreover, the pollen tetrads thereafter evolved again to monad and/or heterodynamosporous tetrad state in the subfamilies Ericoideae, Styphelioideae and Vaccinioideae (Fig. 4-1). Parallel evolution of tetrad pollen is also found in the tribe Pyroleae of subfamily Monotropeoideae which has changed into more derived pollen character state, polyads of indefinite number of tetrads (Takahashi 1986a & b). But, the possibility of the evolution of polyads (in *Chimaphila*) directly from monads also should not be ignored, as they are very loosely attached together. If pollen tetrads are considered to have evolved only once, then the features become synapomorphic for all Ericaceae except *Enkianthus* (Kron et al. 2002a), and reversed to plesiomorphic pollen character state (monad) in most members of the subfamily Monotropeoideae (Fig. 4-1). From the palynological point of view, it is better to consider the monad is the symplesiomorphic pollen character state for the subfamily Enkianthoideae and Monotropeoideae.

Walker and Doyle (1975) also regarded monads as the basic angiosperm pollen-unit and permanent tetrads, a derived characters state which have been evolved separately in number of lines. However, monads and/or pseudomonad (cryptotetrad) may have secondarily evolved from tetrads and represent a derived rather than a plesiomorphic character state. Previously, the heterodynamosporous pollen tetrads were considered as derived pollen character and they characterized the tribes Oligarrheneae and Styphelieae of subfamily Styphelioideae (Quinn et al. 2005). But in this study heterodynamosporous pollen tetrads were also found in the tribe Vaccinieae of subfamily Vaccinioideae. This might be the indication of parallel evolution of pseudomonad pollen in subfamily Styphelioideae and Vaccinioideae.

Evidence from the fossil pollen records may also support this trend. The oldest known Ericalean fossil from mid-Cretaceous deposits (Turonian, ca. 90 MYBP) was reported by

Nixon and Crepet (1993). The flower is described as being sympetalous and 5-merous, and the sepals partly connate. The androecium consists of free stamens with awned, inverted anther, pollen grains with monads and viscin threads present. The fossils suggest affinities with basal Ericaceae, probably near extant *Enkianthus*, a taxon that also shares the monadinous pollen, but interestingly viscin threads present with the fossil. The recent phylogenetic study of *Erica* (McGuire and Kron 2005) showed that *Erica spiculifolia* is sister to all other *Erica* species in combined analysis of both nuclear and chloroplast data. This taxon has monad pollen, it may indicate that tetrad pollen changed to derived monad state in the ancestors of *Erica* and modified again into plesiomorphic tetrad state within *Erica*. The evolutionary trend in pollen dispersal unit, monad → tetrad → monad is observed in other families also e.g., in Annonaceae (Le Thomas et al. 1986).

The round compact tetrads are considered as plesiomorphic in Ericaceae. This pollen type characterizes the subfamilies Arbutoideae, Cassiopoideae and most of members of Vaccinioideae (Table 4-4; Fig. 4-2). This pollen character is also considered as primitive for Ericales by Warner and Chinnappa (1986). Warner and Chinnappa (1986) assumed that the loose tetrads of *Chimaphila* indicate an advancement as the pollen tetrads begin to dissociate.

In general, the evolution of the PDU as tetrads and/or polyads correlates significantly with a high ovule number per ovary (Walker 1971). The only two angiosperm families which have pollinia (the Orchidaceae and Asclepiadaceae) are both characterized by having numerous seeds per ovule. Within the Ericaceae this correlation is quite evident. For example, a reduction series from many down to one ovule per locules has observed in Ericaceae and Styphelioideae, in where both type of pollen dispersal units; tetrads and monads, are found (Oliver 2000). But, exception of this common correlation is also observed in Ericaceae e.g., in the subfamily Arbutoideae. Although the members of this subfamily possess the pollen in tetrads, the ovule number varies from few to one, whereas most Ericaceae have more or less numerous ovules per locule (Kron et al. 2002a).

ERICACEAE stat. nov.

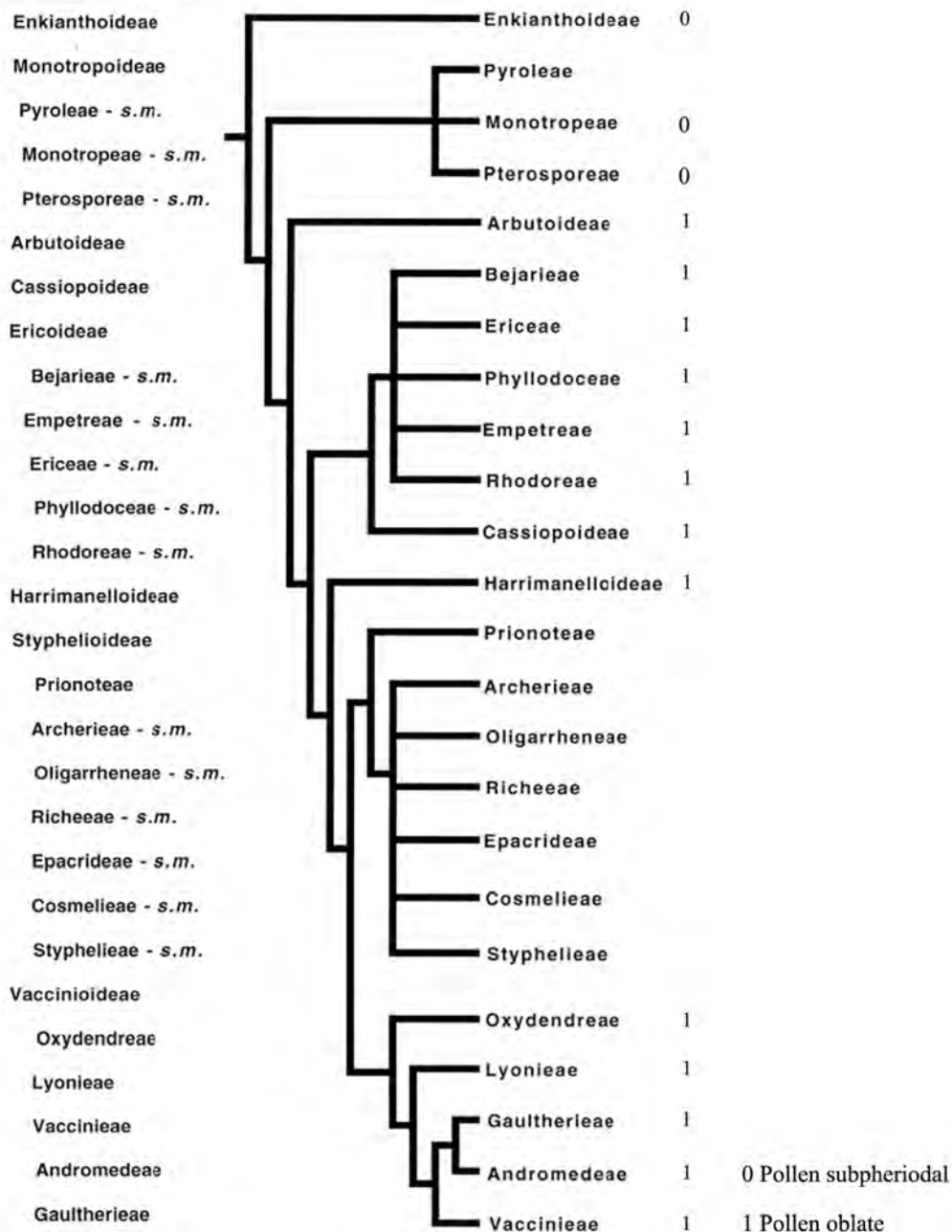

Fig. 4-3. Pollen shape incorporated on the phylogenetic tree of Ericaceae (Kron et al. 2002a);

For character states see Table 4-4.

Size and shape of pollen dispersal units

Pollen tetrad of the “average” Ericaceae species is in medium sized (30.1 – 50.0 μm). In range of average values, the size of pollen tetrads (D) in Ericaceae varies from 24.4 – 72.4 μm and grains minute to medium rarely large; polar length (P) 12.5 – 39.3 μm and equatorial diameter (E) 16.8 – 50.8 μm (Chapter 3; Table 4-5). No significant difference was found in the pollen size of monads and tetrads, and the pollen size shows wide overlap between monads and tetrads. The size of pollen grains for a particular specimen did not vary in a large extent (Chapter 3). The size of pollen grains was sometime used to distinguish pollen groups within the ericaceous species (e.g., Diez and Fernandez 1989). But in the present study, the pollen size did not emerge as a good criterion for taxonomic purposes in the family Ericaceae as a whole. Kim et al. (1988) also concluded that the size of the pollen tetrad and pollen grains, as well as the apocolpium diameter do not offer diagnostic data for identification of taxa of the tribe Empetreae. However, the pollen size is useful to a limited extent at the inter- or infra-generic classifications for different genera (Sarwar and Takahashi 2006a & b, Sarwar et al. 2006a, Chapter 3); or it may be accepted as an additional palynological feature for the delimitation of groups (Davis 1997). Various factors such as nutrition and ploidy (Bell 1959), harmomegathic effect of various chemical treatments for microscopy (Reitsma 1969) and geographic distribution (Takahashi 1986b), have been shown to affect the size of pollen grains. Moreover, Schols et al. (2003) reported that the tuber type (annual vs. persistent) also affect the size of pollen grains in *Dioscorea*.

Although the majority of systematic palynologists as well as this study use acetolysis method of Erdtman (1960) or the slightly modified methods (e.g., Reitsma 1969, Takahashi 1987a) for the preparation of pollen grains for LM and SEM observations, these methods themselves also affect the size of pollen grains. And the increase of pollen size after acetolysis is varied among the genera, sometimes even among the species also. In most

instances acetolysing for three minutes or more does not affect the size significantly (Reitsma 1969) or between 6 and 30 % (Schols et al. 2004).

A positive correlation may exist between pollen size and flower size in some taxa of Ericaceae, but I did not make any correlation study between pollen size and flower size as well as any other floral traits. Moreover, a positive correlation between pollen size and style length was reported for Caprifoliaceae s.l. by Donoghue (1985).

Dessein et al. (2005) discussed the probability of using several methods for the coding of different continuous pollen characters viz., tetrad diameter, length of polar axis, and equatorial diameter, as well as ectoaperture length, for the phylogenetic analysis of the family Rubiaceae. And they recommended the testing of different methods so that a reasonable amount of potential phylogenetic information is obtained by the grouping achieved. These methods may also be useful for the coding of different continuous pollen characters in Ericaceae.

The shape of pollen (based on P/E ratio) did not vary a large scale within the same type of pollen dispersal unit. The pollen shape commonly varies from oblate to suboblate in tetrad; and from suboblate to subprolate in monads. In the pollen tetrads, four grains are closely united together and worked as one harmomegathic unit, so the P/E values were considerably smaller; as well as pollen shape showed a difference in two types of dispersal units. Pollen shape and the ratio of tetrad diameter to equatorial diameter pollen (D/d) sometimes show their superiority as taxonomic character over pollen size (Chapter 3). The D/d value sometimes acts as an indicator of compactness or looseness of pollen tetrads e.g., *Andromeda polifolia*, but not universally found for the other taxa.

The medium (25 – 50 µm) pollen size is considered as a symplesiomorphic pollen character state for the family Ericaceae and minute (10 – 25 µm) pollen as derived, and has evolved independently in different taxa. And the subspheroidal (P/E 0.75 – 1.33) pollen shape is considered as plesiomorphic pollen character state for the family Ericaceae and oblate (P/E

0.50 – 0.75) pollen as derived and synapomorphic (Table 4-4; Fig. 4-3), but has reversed to plesiomorphic state independently in some of the taxa. Similar evolutionary trend in pollen size and shape has also been discussed for the angiosperms by Walker and Doyle (1975) and in pollen shape was reported in other families (e.g., Dichapetalaceae, Punt 1975). Primitive angiosperm pollen falls largely between 50 – 99 μm in the large pollen grain class. From large pollen grains two different evolutionary trends are apparent already within the subclass Magnoliidae – one trend toward even more larger or gigantic grains, and another trend toward smaller grains (Walker and Doyle 1975). But, they also reported the easily reversibility of this character.

Aperture

Apertures are well-defined areas of pollen surface where the external part of the wall, mostly ectexine, is reduced or absent. They function as openings, permitting pollen tube growth, exchanges with the surrounding medium, and preventing pollen wall breakage by accommodating variation in pollen volume (Thanikaimoni 1986). The number of aperture per pollen grain is a relatively plastic feature in the basal clade of Ericaceae when compared with that of the more derived clades (Kron et al. 2002a). For example, in the most basal monophyletic clade Enkianthoideae, the pollen of *Enkianthus* has three to five apertures, also rarely two (Chapter 3-1).

Generally, the pollen grains of Ericaceae are 3-aperturate, but 4-aperture also found in members of some genera having monads and/or tetrads viz., *Enkianthus*, *Erica*, *Rhododendron*, *Kalmia*, *Vaccinium*, *Leucothoe*, *Disterigma* etc., or 5-aperture in *Enkianthus* (Chapter 3). An increase in aperture number offers a potential selective advantage because it increase the number of prospective germination sites, thus increasing the likelihood of contact between at least one germination site and the stigmatic surface. At the base of eudicot clade, an apparently fundamental shift in aperture position from polar to equatorial apertures

was coupled with an increase in aperture number. This transition could be one of the key innovations underlying eudicots success (Furness and Rudall 2004). In core eudicots plants producing tetra-aperturate pollen, the fourth aperture of each microspore results from the duplication of the pair of apertures placed between microspores descending from the same second meiotic division (Huynh 1968 cf. Ressayre et al. 2002).

The aperture length (L or 2f) varied from 11.5 – 42.4 μm and width (W) 0.4 – 5.1 μm . No significant difference was found in aperture length between monads and tetrads, but the aperture length of monad pollen grains varies less than that of tetrad pollen grains. The length to width ratio (L/W or 2f/W) varied from 3.60 – 70.25. The narrower aperture width or the higher L/W or 2f/W value might have some significance for adaptation in the drier regions. A very narrow slits-like apertures found in Empetreae pollen, appears to be genetically controlled characters as it also observed consistently in previous works (Díez 1987, Kim et al. 1988). However, the possibility of narrow aperture due to incompletely (not fully) expanded pollen grains (Moore et al. 1991) should not also be ignored. The length/width ratio of aperture was sometimes used as criterion for comparison and differentiation between taxa (e.g., Luteyn 1978). The L/P (for monads) and 2f/D (for tetrads) ratio varied from 0.56 – 0.84 and 0.26 – 0.76, respectively. The length of aperture is directly correlated with polar length of monad pollen. The correlation between aperture length and tetrad diameter is also very common, but not always found e.g., *Bejaria resinosa* where it has relatively large tetrads but the average aperture length is only 11.8 μm (2f/D 0.26) (Chapter 3). Warner and Chinnappa (1986) showed that 2f/D ratio possessed some taxonomic implications to differentiate subfamily Rhododendroideae and Vaccinioideae, and had some evolutionary significance. Smaller colpi in relation to the overall diameter of the tetrads in some genera implies an evolutionary tendency to a reduced colpus, (Warner and Chinnappa 1986). Similar situation may also prevail for *Bejaria* (Chapter 3).

The 3- to 4-porate condition of *Monotropastrum humile* is probably most advanced in the subfamily Monotropeoideae, even in the Ericaceae (Takahashi 1987a), and an apomorphic pollen character state for this subfamily. Warner and Chinnappa (1986) also reported the evolutionary trend in aperture type; from colporate to porate, using the *Monotropa uniflora* pollen of the subfamily Monotropeoideae. However, the palynological difference due to geographical distribution is revealed in *M. uniflora*. The New World collection is characterized by 3-porate pollen and the Old World collection by 3-colporate pollen (Warner and Chinnappa 1986, Takahashi 1987a), though 4-porate condition is frequently observed in the New World collection. The evolution of compound apertures (colporate) towards the simple apertures (only porate) agrees with Huynh (1976).

Apertures are significantly wider at middle and acute towards the end. However, colpi with slightly tapering to obtuse or with bifurcated tip were found in different species and syncolpate pollen was found, rarely, in one specimen of *Enkianthus campanulatus* (Chapter 3-1). As a more or less serial and continuous variation was found in aperture length, therefore, it also has a limited value as a criterion for taxonomic purposes in the family Ericaceae.

Apertures are commonly colporate (endoaperture distinct), but colporoidate apertures (endoaperture indistinct) are also found in some species. Endoaperture is generally lalongate (equatorially elongate), 0.4 μ m – 5.9 μ m long and 3.7 μ m – 17.2 μ m wide; however, lolongate (vertically elongate) or both situation occur in some species (Davis 1997), or rarely circular or H-shaped (Chapter 3). One endoaperture per ectoaperture (colpus) is usual situation in Ericaceae, two or more endoaperture per colpus were observed in some specimens. Similar situation was also observed by Davis (1997) in his work on Ericoideae. Since in both of these works (this study and Davis 1997) commonly only one pollen sample of each species has been investigated, no conclusion could be drawn as to whether this phenomenon of more than one endoaperture per ectoaperture is a standard feature of these species or just random of occurrence. Rare occurrence of more than one endoaperture per ectoaperture was also

reported for other taxa (e.g., Faegri and Iversen 1989 in Buxaceae), but the situation they refer to was probably not similar to the one encountered in this study (Davis 1997). Aperture (colpus) membrane is granulate or granuloid in almost all the taxa studied, is considered as symplesiomorphic pollen character state in the Ericaceae and the smooth colpus membrane is as derived independently in different taxa (Chapter 3).

Evolution of pollen aperture types was also described and discussed in detail by Walker and Doyle (1975). In angiosperm pollen two basic aperture types are generally recognized: monosulcate or monosulcate-derived vs. tricolpate or tricolpate-derived (e.g., tricolporate, triporate etc.), and colpate pollen is essentially restricted to dicotyledonous angiosperms. From the basic tricolpate form other aperture types such as 5-colpate, 6-colpate, porate, colporate, pororate etc. are derived among the eudicots (Walker and Doyle 1975). This evolutionary trend of pollen aperture types may also be possible at generic level e.g., in *Enkianthus* as well as in the family Ericaceae (Chapter 3-1).

The initial evolution of the pollen aperture was certainly in response to the need for a more efficient means of exit for the germinating pollen tube (Walker 1971), and can be associated with an increase in reproductive fitness (Dajoz et al. 1991); but as Wodehouse (1935) has pointed out, the aperture also serves a harmomegathic function in permitting changes in the volume of the grain with varying humidity. Dajoz et al. (1991) described the 3-aperturate pollen grains as slow-germinating and long-lived, whereas 4-aperturate pollen grains as quick-germinating and short-lived. Similar observation is also noted in legume pollen where fewer or smaller apertures are associated with slower desiccation rates and longer viability (Banks 2004). However, higher aperture number due to the abnormality in the microsporogenesis stage of pollen development (Huynh 1968, Sarwar et al. 2006a), or related to dimorphic flower (Kaplan and Mulcahy 1971), ploidy level and/or pollen size was also reported previously (e.g., Lewis 1964, Takahashi 1986a & b, 1987a). Lower temperature may also cause variation in aperture number (Stanley and Linskens 1974).

Ressayre et al. (2002) investigated the probable role of interactions between nuclei, mediated through microtubules, in the aperture patterns ontogeny. They concluded that aperture pattern i.e. aperture number and distribution on pollen surface, ontogeny could be linked to the processes ensuring the apportionment of the cytoplasm to the four microspores. This apportionment is achieved by radial arrays of microtubules organized around the nuclei (Ressayre et al. 2002).

Exine thickness

The exine thickness does not differ substantially between monad and tetrad pollen grains. However, monads generally have thinner apocolpial exine, ranging from 1.0 μm – 3.1 μm compared with those of tetrads, ranging from 0.9 μm – 3.8 μm . The reversal condition was found in monads with thicker mesocolpial exine, and tetrads with thinner septal exine, although septal (proximal) exine in tetrads had relatively wider range (0.5 μm – 3.2 μm) than that mesocolpial exine (1.1 μm – 2.8 μm) in monads. Similar trend was reported for Ericoideae in Ericaceae (Davis 1997) and other families also (e.g., Le Thomas et al. 1986 in Annonaceae). One of the most typical features of most tetrads or polyads of Annonaceae and other families is the reduced septal exine, leading to a functional unit of compound pollen grains. The first step in formation of tetrad is certainly a more or less loose aggregation with monads which do not differ significantly from the single pollen grain type and have no reduced septum. Later the pollen tetrad form a functional unit, the septum becomes progressively reduced. Le Thomas et al. (1986) also discussed the possibility of completely lacking of septum. It is emphasized that the reduction of septum is not a condition for tetrad evolution but a consequence (Le Thomas et al. 1986). The reduction of septum is also observed in Ericaceae pollen. Moreover, an extreme example of tetrad without septal wall is found in two species of *Ceratostema*; *C. lanigerum* and *C. loranthifolium*, in the tribe Vaccinieae (Fig. 3-33), and the mature pollen tetrads without septal wall found in

Ceratostema is the first report for the Ericaceae as well as other angiosperm families (Sarwar et al. 2006b).

The septum with perforations is not rare palynological feature in the families having pollen tetrads (e.g., in Winteraceae, Praglowski 1979). But, this character is characterized only a few taxa of Ericaceae e.g., *Andromeda*, *Arctostaphylos*, etc. (Chapter 3), and has emerged as a character of taxonomic importance within this family.

Usually exine thickness does not differ significantly among the species within a genus and the apocolpial exine is thicker than mesocolpial or septal exine. But apocolpial exine with thinner or equal thickness has been found in some species, e.g., *Enkianthus chinensis*, *Craibiodendron yunnanensis*, *Erica trimera* ssp. *keniensis*, *Lyonia lucidus* etc., which may possess some systematic significance as discussed in Chapter 3.

Correlations among the quantitative palynological characters of Ericaceae

Seven primary quantitative palynological characters of the Ericaceae viz., D, P, E, 2f, W, apocolpial exine and septum thickness (for details see Chapter II), are strongly correlated (level of significance 1%) with each other, except septum thickness which is relatively weakly correlated (level of significance 5%) with only apocolpial exine thickness (Fig. 4-4). This indicates that the septum thickness might primarily depend upon the mode of attachment (compact or loose) of pollen grains in pollen tetrads as discussed in previous paragraphs. Similar correlation has also been discussed for other angiosperm families (e.g., Annonaceae, Le Thomas et al. 1986).

Among the secondary quantitative characters viz., D/d, P/E, 2f/W and 2f/D, D/d is correlated with P/E, 2f, and both D/d and P/E with 2f/W. The P/E is also negatively correlated with W. The 2f/W is positively correlated with 2f/D and negatively with E and W (Fig. 4-4).

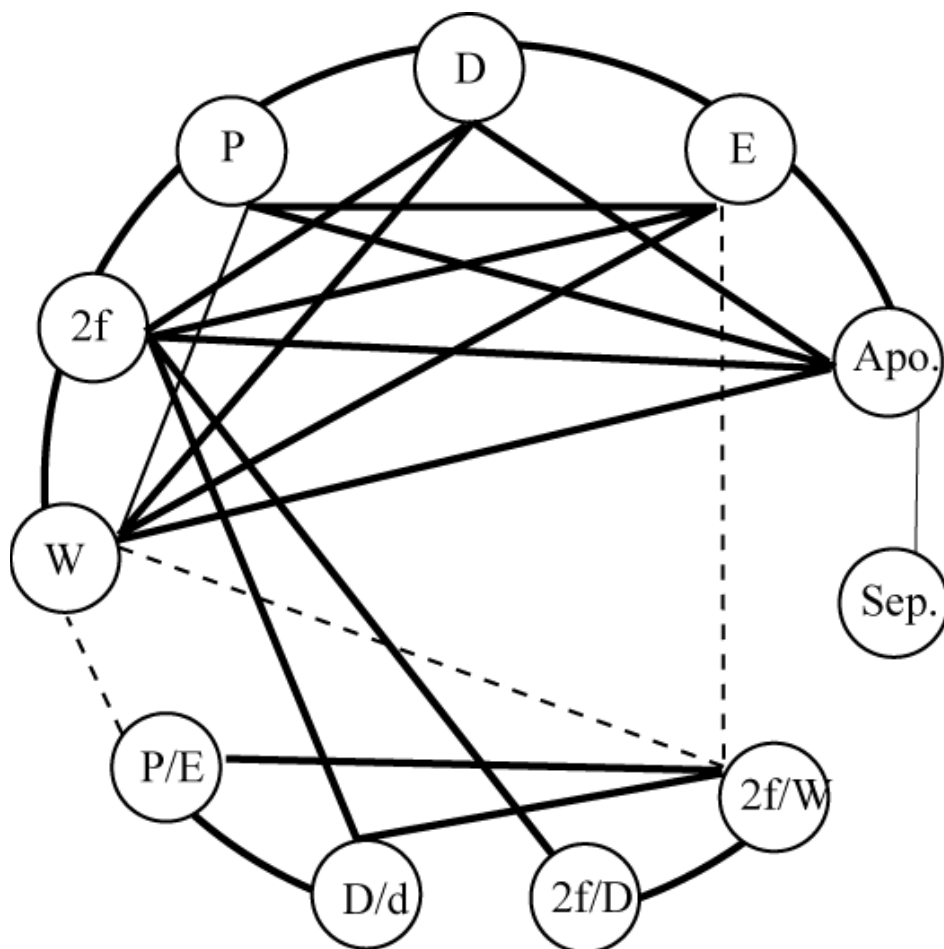

Fig. 4-4. Correlations of eleven pollen morphological characters. Bold lines indicate strong correlation (level of significance 1 %), thin line weak correlated (level of significance 5 %) and broken lines negative correlations (level of significance 5 % or lesser).

It is very interesting that the secondary quantitative palynological features viz., D/d, P/E and 2f/D are weakly correlated (level of significance below 5%) with their respective primary characters viz., D, P and d(E). This indicates that these characters i.e. D/d, P/E and 2f/D, might evolve independently within the family Ericaceae and they possess some taxonomic values as discussed at Chapter 3.

Taxonomic significance of quantitative palynological characters in Ericaceae

The quantitative palynological features of the family Ericaceae have wide variations enough even to clarify the differentiation of the species within the genus, but has a limited

potential to clarify the higher level relationships e.g., at the tribal or subfamilial classification (Chapter 3). On the cluster analysis, the seven primary quantitative palynological characters studied viz., D, P, E, 2f, W, apocolpial exine and septum thickness (for details see Chapter 2), either individually or collectively, have always produced two major clades with different taxa. But, they could not efficiently separate the members of same tribes and/or subfamilies of the Ericaceae (Kron et al. 2002a). When the P/E ratio was included as eighth character, they clustered the members of the same tribes or subfamilies relatively more efficiently (Table 4-2; Fig. 4-5).

The Clade 1 (left major clade) includes the members of subfamilies Arbutoideae and Vaccinioideae (mainly members of tribes Andromedeae and Vaccinieae). Palynological characters of the members of the subfamily Arbutoideae are sufficient enough to make a clade within this major clade (Fig. 4-5; L1 – L3). Members of the tribe Andromedeae are also positioned in a same clade, though they are not closely positioned (Fig. 4-5; L20 –L21). On the other hand, the Clade 2 (right major clade) includes the members of subfamilies Cassiopoideae, Ericoideae, Harrimanelloideae and the rest members of Vaccinioideae, but the members of different subfamilies are positioned scatteredly (Fig. 4-5). Although members of the almost all subfamilies and/or tribes positioned at same major clade, members of the tribes Gaultherieae and Vaccinieae positioned at both Clade 1 and 2 (Fig. 4-5; L22 – L26, L32 – L54). These may indicate the quantitative palynological characters have a limited potential to clarify the higher level relationships e.g., at the tribal and/or subfamilial classification.

Adding other secondary quantitative characters viz., D/d, 2f/D and 2f/W, to the AHC analysis also produce two major clade, but naturally the members of each clade are different (e.g., Fig. 4-6). It is noteworthy that the members of the subfamily Arbutoideae always make a clade within either Clade 1 or Clade 2 (e.g., Fig. 4-6; L1 – L3), which may indicate the strong support of quantitative palynological characters to the monophyly of this subfamily.

Table 4-2: Data matrix of eleven palynological characters and genera for statistical analyses.Average value for the genus in μm . Apo. apocolpial exine thickness, Sep. septum thickness.

No.	Genus	D	P	E	2f	W	Apo.	Sep.	P/E	D/d	2f/W	2f/D
1.	<i>Arbutus</i>	49.9	25.5	39.4	31.9	1.6	2.4	1.4	0.65	1.26	21.06	0.61
2.	<i>Arctostaphylos</i>	44.2	22.5	36.6	25.9	1.7	2.4	1.0	0.61	1.20	20.62	0.59
3.	<i>Comarostaphylis</i>	42.2	21.4	35.0	26.8	1.8	2.1	0.9	0.62	1.17	16.53	0.63
4.	<i>Bejaria</i>	43.5	23.0	32.1	13.9	1.5	2.6	1.8	0.72	1.36	9.60	0.33
5.	<i>Bryanthus</i>	33.3	17.4	19.9	23.1	0.4	2.1	0.9	0.87	1.67	57.75	0.69
6.	<i>Corema</i>	32.5	17.8	22.9	17.6	0.9	2.0	2.5	0.78	1.42	19.56	0.54
7.	<i>Calluna</i>	39.8	20.4	25.7	12.7	0.8	1.9	0.7	0.79	1.55	15.88	0.32
8.	<i>Daboecia</i>	32.5	17.2	22.8	23.8	1.0	1.5	1.4	0.75	1.42	25.53	0.73
9.	<i>Erica</i>	36.8	18.9	27.3	21.2	1.4	2.4	1.7	0.69	1.42	19.69	0.57
10.	<i>Elliottia</i>	50.4	26.0	36.6	20.0	1.7	1.9	1.3	0.71	1.38	13.43	0.40
11.	<i>Epigaea</i>	38.5	19.8	29	21.5	2.1	2.5	1.4	0.68	1.33	10.24	0.56
12.	<i>Kalmia</i>	31.2	16.3	22.3	15.2	0.7	1.9	1.1	0.73	1.40	24.47	0.49
13.	<i>Phyllodoce</i>	30.8	16.7	23.6	13.7	1.6	1.8	1.0	0.71	1.31	11.28	0.45
14.	<i>Rhodothamnus</i>	42.4	22.3	31.5	17.7	1.6	1.8	1.5	0.7	1.35	11.06	0.42
15.	<i>Menziesia</i>	35.5	18.1	25.8	16.5	1.4	1.7	1.1	0.71	1.38	12.53	0.47
16.	<i>Rhododendron</i>	52.4	27.7	37.2	20.0	1.4	2.7	1.7	0.75	1.41	16.70	0.39
17.	<i>Therorhodon</i>	50	26.5	35	14.8	2.9	2.2	1.4	0.76	1.43	18.6	0.3
18.	<i>Cassiope</i>	27.4	14.2	19.6	19.1	0.7	1.4	0.9	0.73	1.41	26.99	0.70
19.	<i>Harrimanella</i>	28.3	14.6	20.1	22.2	0.4	1.9	0.7	0.73	1.4	55.5	0.78
20.	<i>Andromeda</i>	43.8	22.8	33.1	23.0	2.6	2.2	0.9	0.69	1.32	8.83	0.54
21.	<i>Zenobia</i>	35.5	17.9	27.4	23.3	2.2	1.7	0.9	0.65	1.3	10.59	0.66
22.	<i>Chamaedaphne</i>	31.6	16.3	22.9	20	1.0	1.6	1.3	0.71	1.38	27.66	0.64
23.	<i>Diplycosia</i>	41.9	21.5	29.5	28	2.1	2.2	1.2	0.73	1.42	13.33	0.67
24.	<i>Gaultheria</i>	33.6	17.1	25.6	18.8	1.4	1.9	1.0	0.67	1.32	15.34	0.56
25.	<i>Leucothoe</i>	39.9	20.2	31.8	20.9	2.0	2.1	1.0	0.64	1.25	6.34	0.52
26.	<i>Tepuia</i>	59.6	30.5	44.9	28.3	5.1	3.1	1.1	0.68	1.33	5.55	0.47
27.	<i>Agarista</i>	39.3	20.6	29.3	18.6	1.2	2.1	1.1	0.71	1.34	20.08	0.48
28.	<i>Craibiodendron</i>	32.3	17.1	23.7	18.9	1.6	2.3	2.5	0.72	1.36	11.81	0.59
29.	<i>Lyonia</i>	32.6	16.9	25.2	17.2	0.9	1.8	0.9	0.69	1.32	20.53	0.53
30.	<i>Pieris</i>	40.6	21.4	30.7	19.6	1.5	2.1	1.4	0.70	1.32	17.83	0.48
31.	<i>Oxydendrum</i>	33.4	16.5	26.5	17.3	0.7	2	1.2	0.62	1.26	24.71	0.52
32.	<i>Agapetes</i>	43.2	22.2	31.7	23.4	1.3	2.3	1.2	0.70	1.36	23.3	0.53
33.	<i>Anthopterus</i>	40.4	21.0	28.8	14.9	2.6	1.7	1.1	0.73	1.4	5.73	0.37
34.	<i>Cavendishia</i>	47.7	24.8	35.3	18.0	2.6	1.7	1.0	0.70	1.4	8.0	0.38
35.	<i>Verastema</i>	30.7	15.9	23.0	21.2	1.0	1.3	0	0.70	1.34	21.2	0.69
36.	<i>Costera</i>	39.3	21.3	30.6	21.9	2.6	2.3	1.7	0.7	1.28	8.42	0.56
37.	<i>Demostenesia</i>	48.5	26.5	35.1	28.6	1.1	2.1	1	0.76	1.39	27.03	0.6
38.	<i>Dimorphanthera</i>	60.6	32.0	44.2	29.2	1.6	2.3	0.9	0.72	1.37	20.66	0.48
39.	<i>Diogenesia</i>	39.2	20.8	29.9	21.0	1.7	2.2	1.1	0.7	1.31	12.95	0.54
40.	<i>Disterigma</i>	41.0	21.8	30.0	24.2	1.0	2.2	1.3	0.72	1.36	24.67	0.59
41.	<i>Gonocalyx</i>	35.2	19.4	26.6	20	1.8	2.1	1.3	0.73	1.32	11.11	0.57
42.	<i>Gaylussacia</i>	45.3	23.6	34.6	19.5	2.4	2.2	1.3	0.69	1.31	8.87	0.43
43.	<i>Macleania</i>	50.3	25.5	36.2	30.5	1.9	1.9	1.1	0.70	1.39	17.32	0.61
44.	<i>Notopora</i>	53.7	26.7	40.1	34.0	3.5	3	1.1	0.67	1.37	9.71	0.63
45.	<i>Orthaea</i>	52.4	27.6	39.5	26.2	1.8	2.2	1.7	0.7	1.38	14.51	0.5
46.	<i>Pellegrinia</i>	41.3	23.1	28.1	28.1	0.4	1.7	1.1	0.82	1.47	70.25	0.68
47.	<i>Plutarchia</i>	52.2	27.1	38.1	30.9	1.3	2.3	1.7	0.72	1.37	25.15	0.59
48.	<i>Psammisia</i>	50.4	27.0	36.5	32.4	1.5	2.1	0.8	0.71	1.38	21.6	0.64
49.	<i>Satyria</i>	44.1	23.1	33.9	22.3	1.8	2.0	1.3	0.68	1.3	13.40	0.50
50.	<i>Siphonandra</i>	54.4	27.7	35.4	38.6	2.3	2	1.4	0.78	1.54	16.78	0.71
51.	<i>Sphyraspermum</i>	31.6	16.3	24.2	13.4	1.3	1.5	1.3	0.67	1.31	10.31	0.42
52.	<i>Themistoclesia</i>	34.8	18.1	26.4	18.3	1.9	1.9	1.5	0.69	1.32	11.67	0.52
53.	<i>Thibaudia</i>	56.3	29.1	41.3	31.5	1.7	2.4	1.0	0.7	1.36	21.77	0.55
54.	<i>Vaccinium</i>	40.2	21.1	29.8	20.3	2.0	2.2	1.4	0.71	1.35	11.23	0.51

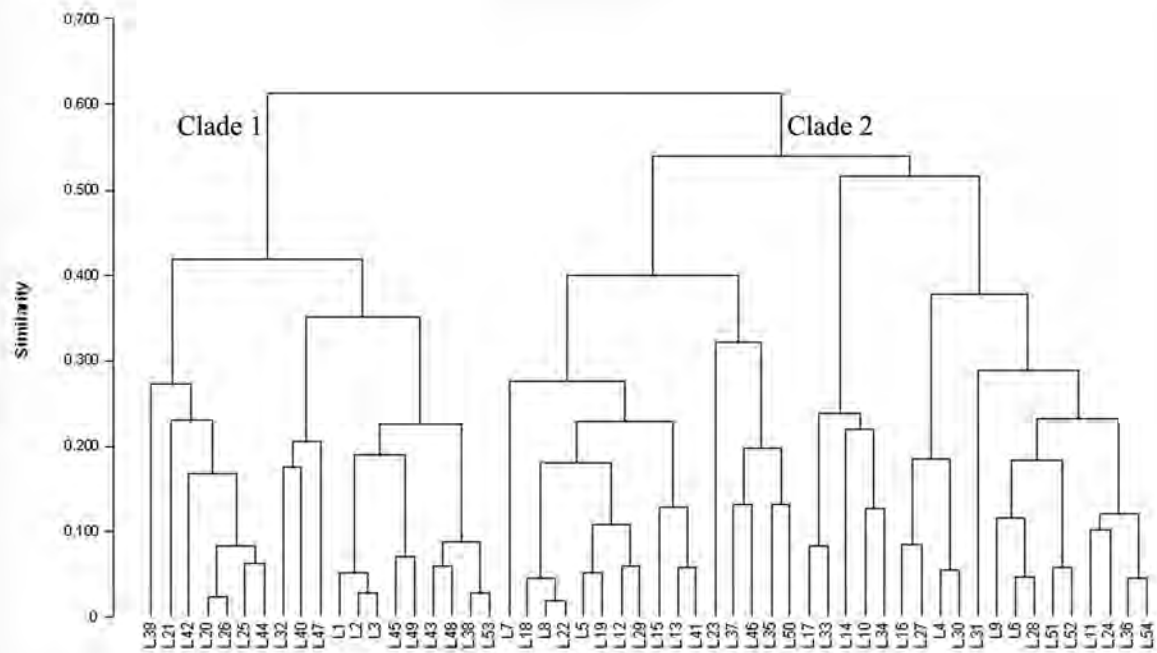

Fig. 4-5. Dendrogram made from the first eight palynological characters of 54 Ericaceous genera by Agglomerative Hierarchical Clustering analysis. For characters and taxa see Table 4-4.

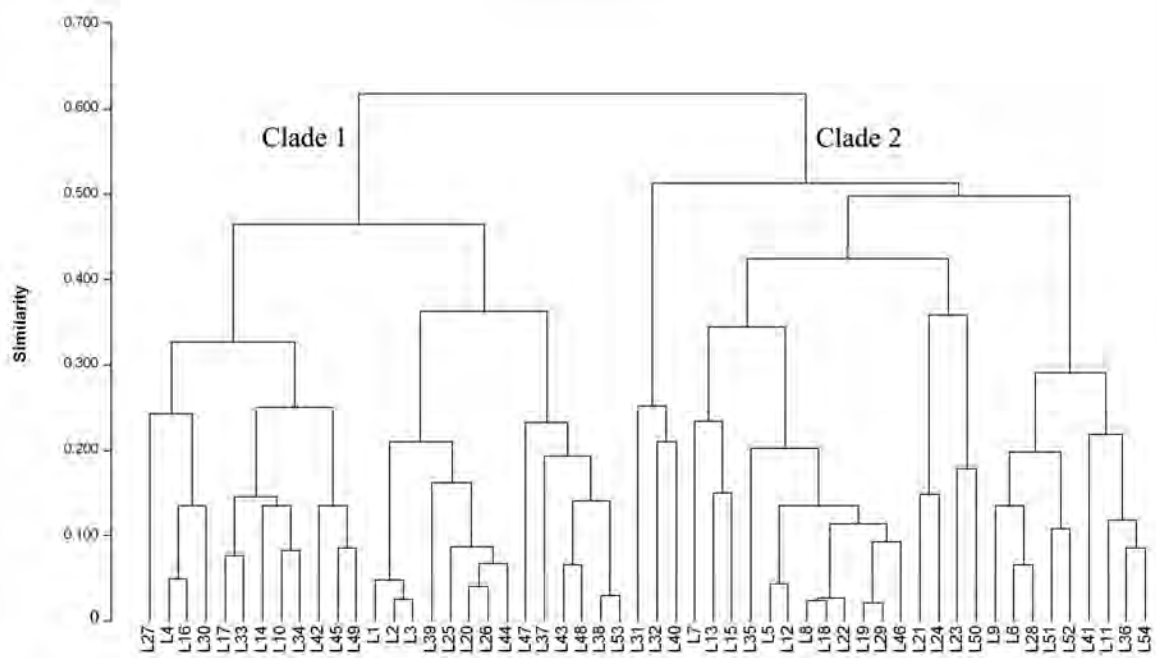

Fig. 4-6. Dendrogram made from eleven palynological characters of 54 Ericaceous genera by Agglomerative Hierarchical Clustering analysis. For characters and taxa see Table 4-4.

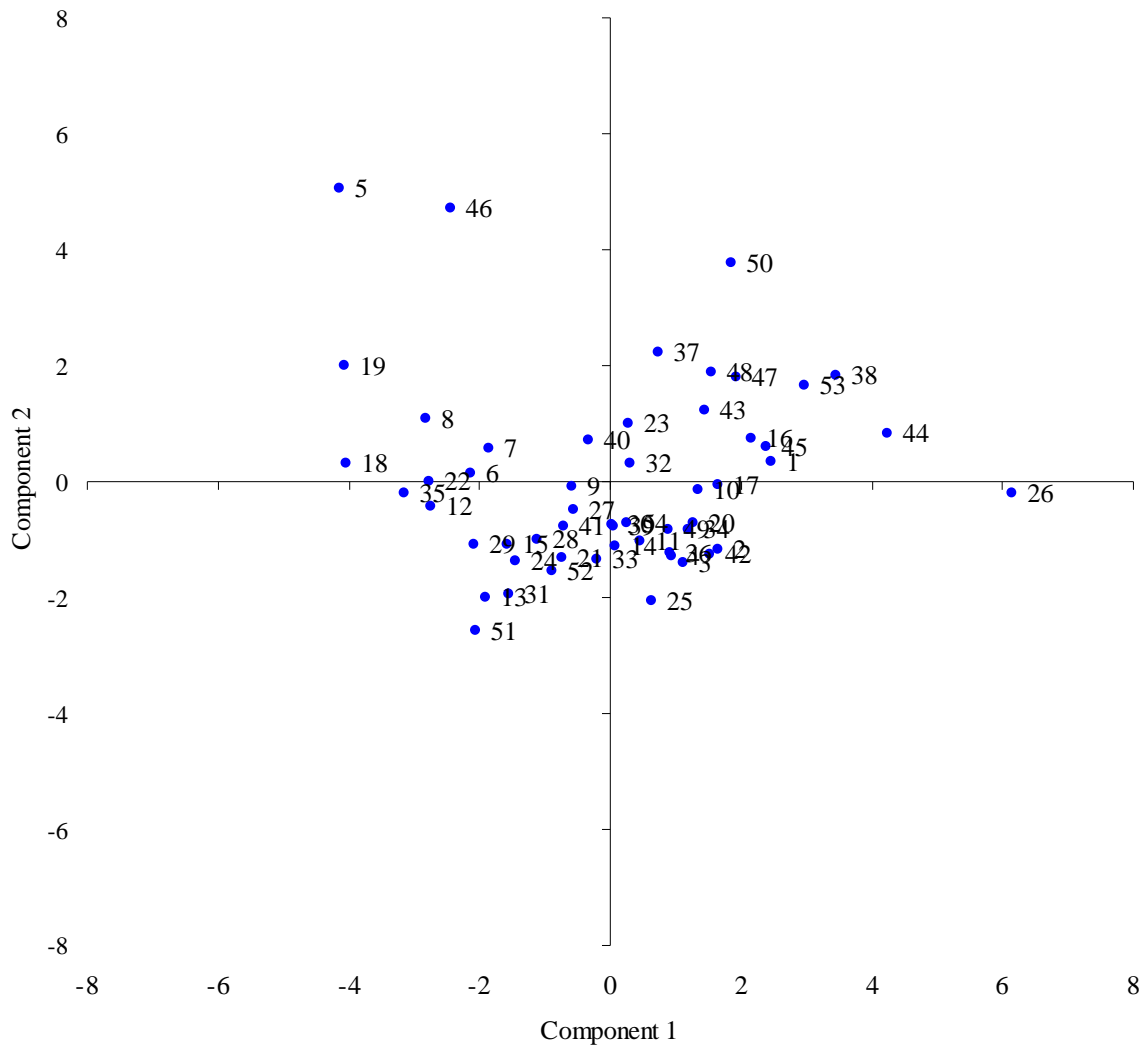

Fig. 4-7. Two dimensional diagram of component 1 and 2 of pollen tetrads of 54 Ericaceous genera based on principal component analysis of eleven palynological characters. For characters and taxa see Table 4-2.

In PCA, the values of first component (e.g., D, P, d(E), apocolpial exine thickness, etc.) varied widely compared to those of second component (e.g., D/d, P/E, 2f/D etc.) (Table 4-2; Fig. 4-7). The genus *Tepuia* is situated at the right edge of the total variation of the Ericaceae pollen which shows the highest value of the first component (26 in Fig. 4-7). And the genus *Bryanthus* situate at the upper left edge which show the highest value of second component and lowest value of first component (5 in Fig. 4-7). Generally, members of the

same tribe and/or subfamily are positioned at nearer position especially in the value of second component (e.g., 1 – 3, 7 – 9 in Fig. 4-7). But the members of the tribe Bejarieae situated at very far position (4 – 5 in Fig. 4-7), which may indicate that the generic composition of this tribe needs to be revised as also discussed in Chapter 3-3.

Endocracks

Endocracks are defined as irregular grooves or small cracks observed in the inner surface of the endexine/nexine (Oldfield 1959). These cracks are readily apparent in acetolysed pollen of the family Ericaceae as well as other angiosperm families (e.g., Apocynaceae, Nilsson 1990). The taxonomic utility of this pollen character is still questionable in Ericaceae. Oldfield (1959) reported that the endocracks are sometimes useful in distinguishing between types showing superficial resemblances. Moore et al. (1991) also frequently refer to endocracks in their palynological key for the Ericaceae. Foss and Doyle (1988) did not emphasize the endocracks in their investigation of ericaceous pollen, because they are not easily visible in SEM micrographs. But, endocracks are sometimes believed as to be artifacts (Faegri and Iversen 1989). It seems that endocracks are not regarded as being of any significant taxonomic value.

In this study, endocracks may have some taxonomic value. They are very clearly visible and characterized the pollen of the subfamily Ericoideae, but absent and/or indistinct in most of the members of the other subfamilies, e.g., Vaccinioideae (Chapter 3).

Viscin threads

Viscin threads occur only in three not closely related angiosperm families, the Onagraceae, Ericaceae, and Caesalpinioideae (Leguminosae) (Hesse 1981). The viscin threads of Ericaceae are smooth surfaced; more fragile, much thinner and rarer than in Onagraceae, and occur on the distal polar surface of pollen tetrads (Skvarla et al. 1978, Waha

1984). In Ericaceae, viscin threads are found only on pollen tetrads of members of the tribes Bejarieae, Phyllodoceae and Rhodoreae of subfamily Ericoideae, and in a single genus *Gaylussacia* of the tribe Vaccinieae of subfamily Vaccinioideae (Waha 1984). She (Waha 1984) also reported that viscin threads within Ericaceae are mostly limited to species with erect flowers, while they lack in those with pending flowers. The presence of viscin threads in the pollen of *Gaylussacia* is not supported by the present study or any other previous studies (e.g., Lieux and Godfrey 1982), even though pollenkitt ropes are present in *Notopora schomburgkii* (Sarwar et al. 2005). Therefore, a detailed palynological study of *Gaylussacia* with large number of species and specimens is suggested to confirm the presence or absence of viscin threads in this genus. Pollen grains with viscin threads reflect an adaptation to zoophilous pollination and will be discussed later. The presence of viscin threads in *Paleoenkianthus* (Nixon and Crepet 1993) suggests that they may have evolved more than once within the history of Ericaceae.

Because the genus *Rhododendron* is known from the Upper Paleocene from seeds (Collinson and Crane 1978), this may indicate that *Rhododendron* is one of the oldest genera of Ericaceae. Pollen with viscin threads may be one of the plesiomorphic palynological characters state and entomophyly is the primitive mode of pollination in family Ericaceae. Similar view was also opined by previous workers (e.g., Faegari and Iversen 1989). According to them, pollen with viscin threads is most probably a primitive character since they may occasionally be found in fossilized material (Faegari and Iversen 1989). The position of the Ericoid clade (with the genera having viscin threads on their pollen tetrads) in the present classification of Ericaceae (Kron et al. 2002a) may also support this supposition.

Exine sculpture and its taxonomic significance in Ericaceae

Although a more or less continuous and serial variation was found in the exine sculpture among the taxa of Ericaceae with SEM, the exine sculpture have emerged as

taxonomically more important palynological feature than quantitative characters viz., tetrad diameter, aperture length, etc. especially to identify the monophyly of a taxon e.g., genus (Chapter 3). Davis (1997) also came to a similar conclusion, and presented his tentative grouping of Ericoid taxa mainly on the basis of exine sculpturing.

Like quantitative characters, the exine sculpture also makes two large group; primary exine sculpture distinct vs. primary exine sculpture indistinct, among the studied taxa of Ericaceae. The exine sculpture of Ericaceae has divided into twelve major types (Fig. 3), although there are many intermediate types observed in this family (Chapter 3). Among these sculpture types, three types; Type 7, 10 and 11, were very specialized and observed either in only one species (Fig. 3-31), or in one genus (Figs. 3-16, 3-21). The exine sculpture type has proved to be very valuable for purpose of identification especially when all other pollen morphological data are included (e.g., in *Menziesia*). This kind of identification would result in “morphological pollen species” (Faegri and Iversen 1989). Another noteworthy observation is the exine without distinct primary sculpture and fine to moderate secondary sculptures (Type 8 – 9, 11 – 12) generally characterized the basal subfamilies of Ericaceae; Enkianthoideae, Arbutoideae and Ericoideae (Figs. 3-1 – 3-20). And coarsely rugulate to coarsely rugulate-psilate primary sculpture, the rugulae with different secondary sculptures (Type 1 – 6) characterized the subfamily Vaccinioideae (Figs. 3-23 – 3-35). The synapomorphic state of exine sculpture for this family is not clear as the exine sculpture very often evolved parallelly. Although the psilate pollen is the basic type of exine sculpture in primitive angiosperms (Walker 1976), the psilate apocolpial exine sculpture situated at the end of a serial variation of exine sculpturing within Ericaceae may be the most specialized character state for this family. The major morphological trend of the exine sculpture is postulated; from fine verrucate through rugulate to psilate, and their interrelationship has presented in Fig. 4-8.

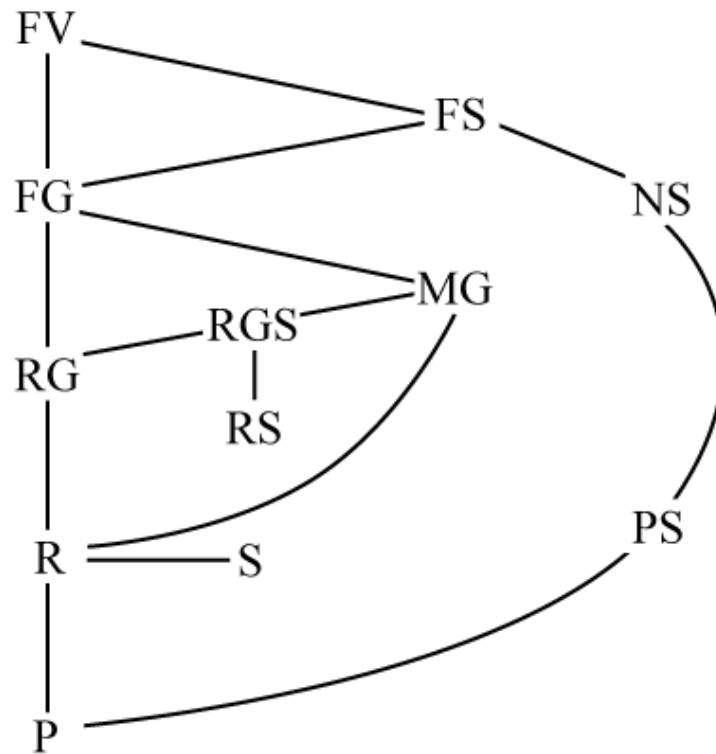

Fig. 4-8. Diagrammatic representation of morphological variations in exine sculptural types and their relationships within the Ericaceae. For exine sculptural types see Chapter 3.

Moreover, a distinct trend was found in “secondary sculpture” on the rugulae. The primary exine sculpture with granules and/or spinules is the common feature in the subfamily Enkianthoideae (Chapter 3-1; Figs. 3-1 – 3-3). On the other hand, the rugulae with faintly to finely and clearly striate secondary sculpture was the common feature in the subfamily Vaccinioideae (Chapter 3-6; Figs. 3-23 – 3-45). So, the primary exine sculpture with secondary sculptures, characterized the subfamily Vaccinioideae, may be a synapomorphic palynological character state within Ericaceae (Table 4-4; Fig. 4-9), but may be evolved parallelly in the taxa of different subfamilies (Chapter 3, Table 4-5).

ERICACEAE stat. nov.

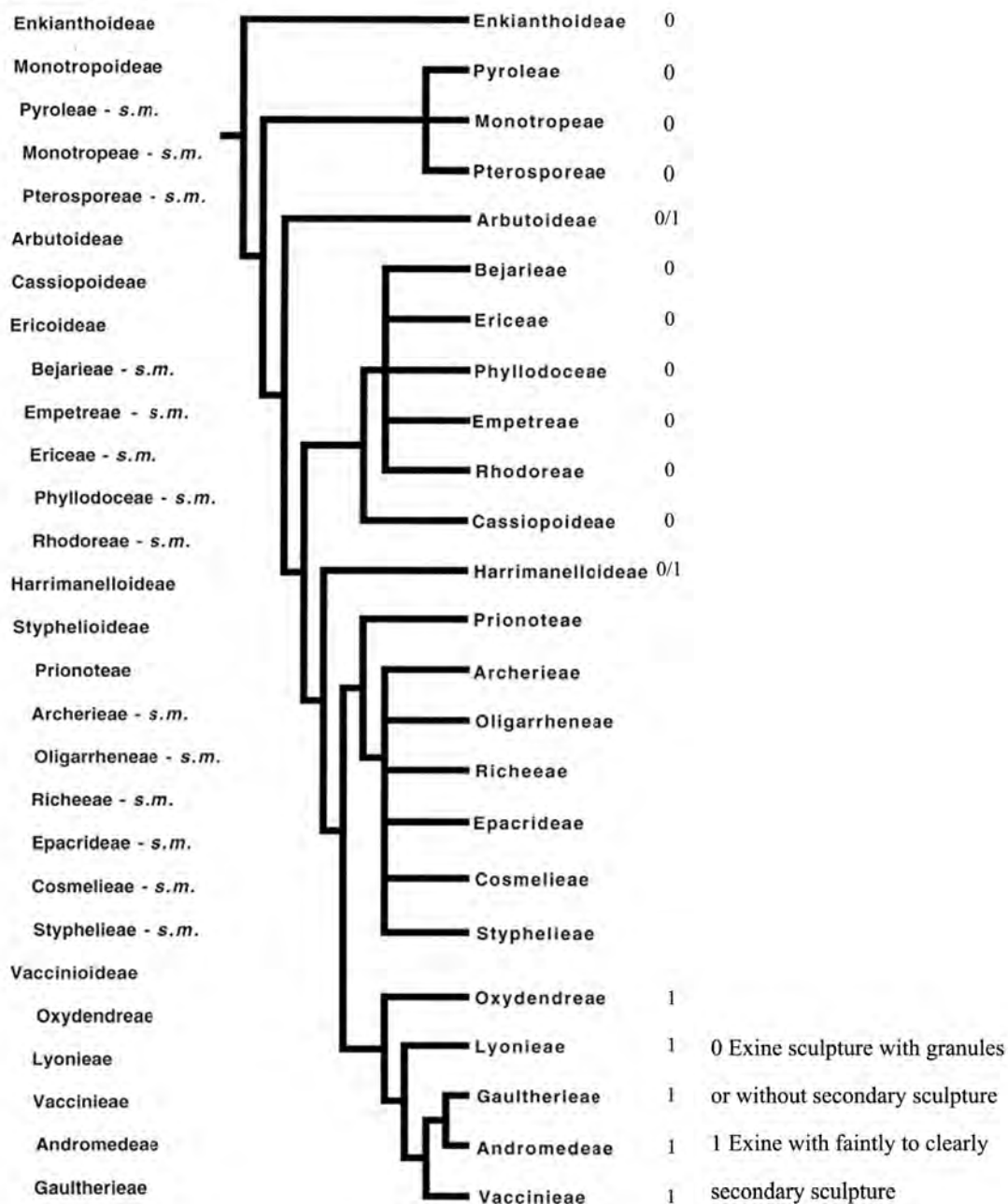

Fig. 4-9. Exine sculpture incorporated on the phylogenetic tree of Ericaceae (Kron et al. 2002a);

For character states see Table 4-4.

Exine structure

Although pollen wall morphology has often been shown to contain taxonomically interesting and important information (e.g., Walker and Skvarla 1975, Walker 1976), studies on the ultrastructure of pollen wall of the Ericaceous species (Keri and Zetter 1992, Davis 1997) as well as other ericoid genera (Zhang and Anderberg 2002) are scanty. In general, Ericaceous pollen corresponds to the basic pattern of pollen-wall stratification in angiosperm. The pollen wall is composed of exine; sexine (tectum + columellae) and nexine (foot layer + endexine), and intine (e.g., Fig. 3-3 A). The relative proportions of the respective layer are variable (Table 4-3), even within the one pollen grain (e.g., Fig. 3-3 B). Tectum and foot layer are relatively thicker and commonly constitute the major portion of sexine and nexine, respectively. The presence of thick tectum is probably not unusual in angiosperm pollen and found in many other families also (e.g., Betulaceae, Faegri and Iversen 1989).

An infratectal collumellar layer separates the tectum from the nexine, and the distinctness and thickness of columellae varied from species to species. The columellae (rod-like element) are well defined and distinct in all the studied taxa except in two *Erica* species, *E. barbiger*a and *E. recurvifolia*, where granular columellae have been found (Figs. 3-13 D – I). Pollen having the incipient, rudimentary, granular columellae is considered to be primitive, which is evolved to pollen with well-developed columellae (Walker and Skvarla 1975). Within the ericoid families, the granular infratectum (columellae) has evolved in different ways (Zhang and Anderberg 2002). Walker and Skvarla (1975) also suggested that the columellae have evolved independently a number of times, even within different subfamilies of the same family, e.g., Annonaceae. The monad pollen of these two *Erica* taxa, *E. barbiger*a and *E. recurvifolia*, is regarded as derived character state (see discussion under pollen dispersal units). Therefore, the granular columellae observed in these taxa might be a synapomorphic pollen character state for the Ericaceae.

Table 4-3. Data of exine structural components with TEM.

Name of Taxa	Thickness of Sexine	Thickness of Nexine	Total Exine	Sexine-Nexine Ratio
Subfamily Enkianthoideae				
<i>Enkianthus campanulatus</i>	0.5 (0.4 – 0.6)	0.4 (0.3 – 0.5)	0.9 (0.8 – 1.1)	1.3
<i>E. perulatus</i>	0.5 (0.4 – 0.5)	0.3 (0.3 – 0.4)	0.8 (0.6– 0.82)	1.7
Subfamily Arbutoideae				
<i>Arctostaphylos auriculata</i>	0.8 (0.5 – 1.0)	0.8 (0.7 – 1.0)	1.6 (1.3 – 2.1)	1.0
<i>Comarostaphylis glaucescens</i>	0.9 (0.7 – 1.0)	1.0 (0.7 – 1.4)	1.9 (1.6 – 2.3)	0.9
Subfamily Ericoideae				
Tribe Bejariaeae				
<i>Bejaria subsessilis</i>	1.2 (0.9 – 1.6)	1.0 (0.6 – 1.2)	2.2 (1.9 – 2.6)	1.2
Tribe Ericaceae				
<i>Erica multiflora</i>	0.6 (0.4 – 0.7)	0.6 (0.5 – 0.8)	1.2 (0.8 – 1.5)	1.0
<i>E. trimera</i> ssp. <i>keniensis</i>	0.9 (0.5 – 1.0)	0.8 (0.6 – 0.9)	1.7 (1.1 – 1.9)	1.1
<i>E. barbiger</i>	(0.7 – 1.4)	(0.4 – 2.0)	(1.1 – 3.4)	
<i>E. recurvifolia</i>	0.9 (0.4 – 1.0)	0.5 (0.4 – 0.6)	1.4 (0.9 – 1.6)	1.8
Tribe Phyllodoceae				
<i>Kalmia latifolia</i>	0.5 (0.3 – 0.5)	0.5 (0.4 – 0.8)	1.0 (0.8 – 1.4)	1.0
Tribe Rhodoreae				
<i>Menziesia pentandra</i>	1.0 (0.8 – 1.3)	0.9 (0.7 – 1.1)	1.9 (1.6 – 2.4)	1.1
<i>Rhododendron japonicum</i>	1.3 (1.1 – 1.3)	0.8 (0.7 – 0.9)	2.1 (1.8 – 2.1)	1.6
<i>R. schlippenbachii</i>	1.1 (0.6 – 1.4)	0.7 (0.5 – 0.8)	1.8 (1.1 – 2.2)	1.6
<i>R. tsusiophyllum</i>	1.1 (0.7 – 1.2)	1.0 (0.7 – 1.1)	2.1 (1.4 – 2.2)	1.1
Subfamily Cassiopoideae				
<i>Cassiope lycopodiodes</i>	0.4 (0.4 – 0.5)	0.4 (0.3 – 0.6)	0.8 (0.7 – 1.0)	1.0
Subfamily Harrimanelloideae				
<i>Harrimanella stelleriana</i>	0.6 (0.56 – 0.64)	0.5 (0.3 – 0.7)	1.1 (0.9 – 1.4)	1.2
Subfamily Vaccinioideae				
Tribe Andromedeae				
<i>Andromeda polifolia</i>	0.9 (0.8 – 1.0)	0.90 (0.8 – 1.0)	1.8 (1.6 – 2.1)	1.0
Tribe Gaultherieae				
<i>Gaultheria itatiaiae</i>	0.7 (0.7 – 0.8)	0.9 (0.6 – 1.1)	1.6 (1.1 – 1.9)	0.8
<i>G. insane</i>	0.5 (0.4 – 0.5)	0.7 (0.6 - 0.8)	1.2 (1.1 – 1.3)	0.7
<i>G. rigida</i>	0.5 (0.4 – 0.5)	0.50 (0.3 – 0.6)	1.0 (0.7 – 1.2)	1.0
Tribe Lyonieae				
<i>Lyonia buchii</i>	0.9 (0.8 – 0.9)	0.8 (0.7 – 0.8)	1.7 (1.6 – 1.7)	1.1
Tribe Oxydendreae				
<i>Oxydendrum arboreum</i>	0.4 (0.37 – 0.44)	0.6 (0.5 – 0.7)	1.0 (0.9 – 1.2)	0.7

Table 4-3. Continued.

Name of Taxa	Thickness of Sexine	Thickness of Nexine	Total Exine	Sexine-Nexine Ratio
Tribe Vaccinieae				
<i>Cavendishia capitulata</i>	0.4 (0.2 – 0.4)	0.5 (0.4 – 0.7)	0.9 (0.8 – 1.1)	0.8
<i>C. marginata</i>	0.4 (0.2 – 0.7)	0.7 (0.67 – 0.74)	1.1 (0.9 – 1.4)	0.6
<i>Ceratostema lanigerum</i>	0.6 (0.6 – 0.7)	0.4 (0.4 – 0.6)	1.0 (0.8 – 1.3)	1.5
<i>C. loranthifolium</i>	0.5 (0.4 – 0.7)	0.5 (0.3 – 0.6)	1.0 (0.7 – 1.3)	1.0
<i>Gonocalyx smilacifolius</i>	0.5 (0.4 – 0.5)	0.4 (0.3 – 0.5)	0.9 (0.8 – 1.0)	1.2
<i>Orthaea abbreviata</i>	0.8 (0.7 – 0.8)	0.6 (0.6 – 0.7)	1.4 (1.3 – 1.5)	1.3
<i>Thibaudia domingensis</i>	0.8 (0.7 – 0.8)	0.5 (0.4 – 0.5)	1.2 (0.9 – 1.3)	1.6
<i>Notopora schomburgkii</i>	1.0 (0.9 – 1.1)	0.8 (0.7 – 0.9)	1.8 (1.7 – 1.9)	1.3
<i>Vaccinium smallii</i>	0.6 (0.6 – 0.7)	0.5 (0.4 – 0.6)	1.1 (1.1 – 1.3)	1.2

Table 4-4. Data matrix of palynological characters and taxa.

Pollen Characters	A	B	C	D	E
<i>Enkianthoideae</i>	0	-	0	0	0
<i>Monotropeoideae</i>					
<i>Pyroleae</i>	0/1/3	?	?	0	0/2
<i>Monotropeae</i>	0	?	0	0	0/2
<i>Pterosporeae</i>	0	?	0	0	0
<i>Arbutoideae</i>	1	0	1	0/1	1/2
<i>Ericoideae</i>					
<i>Bejariaceae</i>	1	1	1	0	0
<i>Ericaceae</i>	1/0	1	1	0	0/1
<i>Phyllodoceae</i>	1	1	1	0	1
<i>Empetreae</i>	1	1	1	0	2
<i>Rhodoreae</i>	1	1	1	0	0
<i>Cassiopoideae</i>	1	0	1	0	1
<i>Harrimanelloideae</i>	1	1	1	0/1	0
<i>Styphelioideae</i>					
<i>Prionoteae</i>	1	?	?	?	?
<i>Archeriaceae</i>	1	?	?	?	?
<i>Oligarrheneae</i>	(0)/1/2	?	?	?	?
<i>Richeae</i>	1/2	?	?	?	?
<i>Epacrideae</i>	1	?	?	?	?
<i>Cosmelieae</i>	1	?	?	?	?
<i>Styphelieae</i>	(0)/1/2	?	?	?	?
<i>Vaccinioideae</i>					
<i>Oxydendreae</i>	1	0	1	1	2
<i>Lyonieae</i>	1	0	1	1	0
<i>Andromedeae</i>	1	0	1	1	1
<i>Gaultherieae</i>	1	0	1	1	1/2
<i>Vaccinieae</i>	1/2	1	1	1	0/2

Explanation of symbol:

- A. Pollen dispersal unit - monad (0); isodynamosporus tetrad (1); heterodynamosporus tetrad (2); polyad (3);
 parenthesis means not methodically identified e.g., either by and/or after acetolysis treatment or with TEM
- B. Isodynamosporus tetrad - compact (0); normal or distinctly lobed (1); not known (?)
- C. Pollen grains - subspheroidal (0); oblate (1)
- D. Primary exine sculptures - with granules or without secondary sculpture (0); with faintly and finely to clearly striate secondary sculpture (1)
- E. Sexine-Nexine ratio - larger than 1 (0); equal to 1 (1); smaller than 1 (2)

ERICACEAE stat. nov.

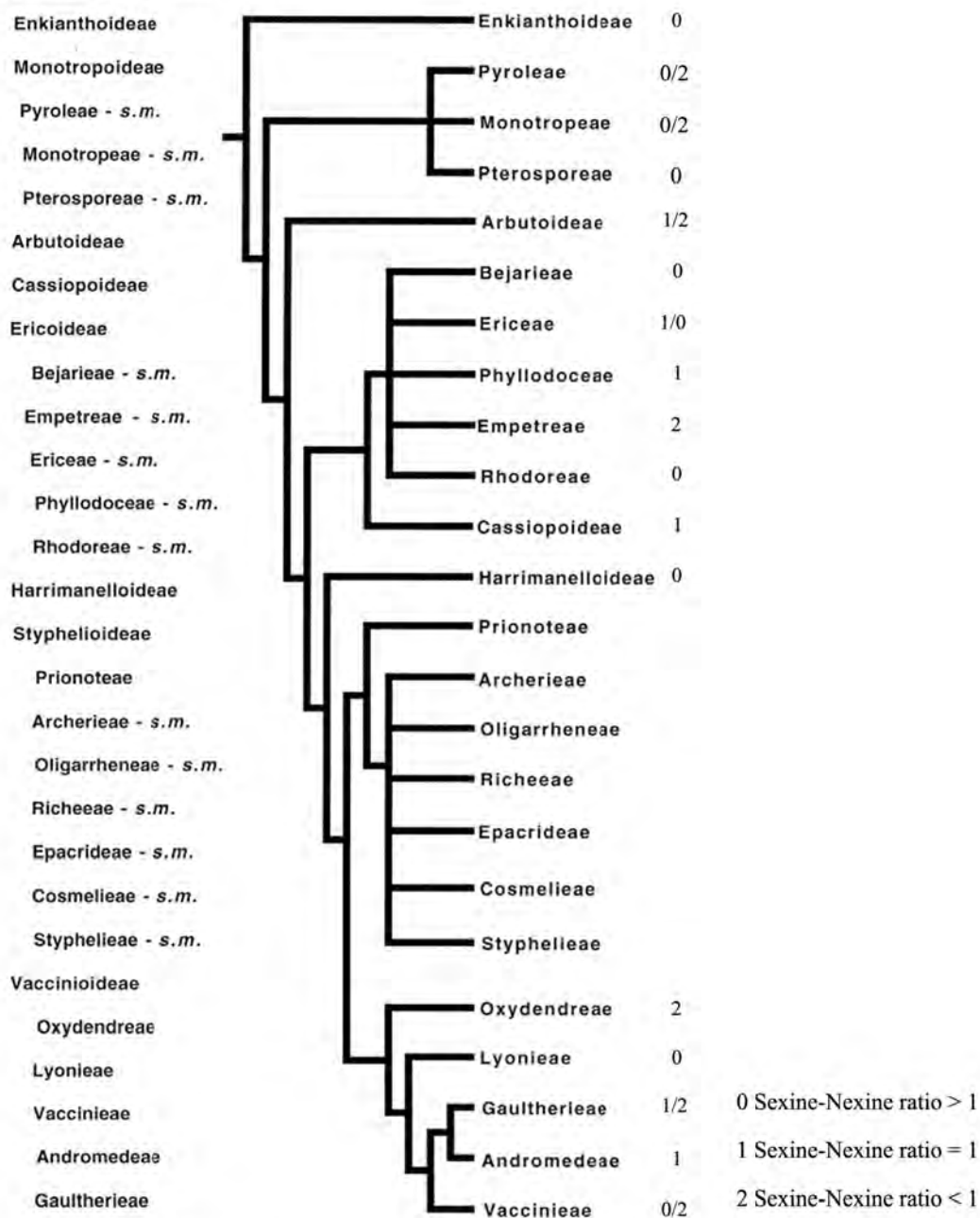

Fig. 4-10. Sexine-Nexine ratio incorporated on the phylogenetic tree of Ericaceae (Kron et al. 2002a);

For character states see Table 4-4.

Foot layer is lacking or very thin at the oroid (aperture) regions. Intine is thicker at aperture region compared to other areas of pollen wall. The endexine is commonly thin and identified with higher electron density. But, endexine seems to be absent, or is not clearly discernable from foot layer in the pollen grains of some species in this study (Chapter 3) as well as in the previous studies of the Ericaceae (Monotropeoideae, Takahashi 1986b, 1987a; Ericoideae, Davis 1997). The absence of endexine may be a primitive character state of the exine in angiosperm pollen grains, and the endexine have evolved under the apertural regions and then spread out the non-apertural areas of exine (Walker 1976). As only few (31) specimens of 21 genera were investigated, and the presence or absence of endexine occurs within the same genus (Davis 1997), so I could not able to make evolutionary conclusions for this character state as well as the other character states of the exine stratification from these observations (Chapter 3).

In the septum, the tectum either thin and fragmental appearances or completely lacking where two foot layers of adjacent grains are connected by columellae, is observed (e.g., Figs. 3-7 K, M, 3-12 J, L). The observations of this present study collaborate with the previous findings of exine structure in the Ericaceae (e.g., Ridgway 1970, Nilsson et al. 1977, McGlone 1978a & b, Waha 1984, Praglowski and Grafström 1985, Takahashi 1986a, Kim et al. 1988). Hitherto, the adaptive or taxonomic significance of presence or absence of tectum in the septal exine is not known. But many factors, e.g., compactness of tetrads, thickness of the septal exine, etc. may play important roles on presence or absence of tectum in the septal exine. Generally, pollen tetrads (both normal and lobed) with relatively thicker septum possess tectum, either well defined or thin and fragmental, in their septal exine (e.g., Figs. 3-12 J, L). The absence of tectum in the septal exine of compact tetrads (e.g., Fig. 3-7) might be one of the intermediate steps towards the tetrads without proximal wall (septum) as found in the genus *Ceratostema* (Fig. 3-33). A range of variation is observed in the thickness of different layers or substrata of pollen wall (Chapter 3; Table 4-3). The TEM studies have

found to be useful for identification of taxa and confirm some critical observations with LM and SEM (e.g., Kim et al. 1988).

The sexine-nexine ratio has been identified as one of the phylogenetically important palynological characters (Walker and Doyle 1975). After plotting the data of sexine-nexine ratio on the phylogenetic tree of the Ericaceae (Kron et al. 2002a), the sexine-nexine ratio greater than 1.00 is emerged as plesiomorphic state, is smaller than 1.00 as apomorphic state for this pollen character, but has evolved independently a number of times, even within tribes of the Ericaceae (Table 4-4, Fig. 4-10). As in this research, ultrastructure of pollen wall of only few taxa was studied with TEM, so it seems to be better not to make any specific comment on the evolutionary trend of sexine-nexine ratio in Ericaceae from this very limited data.

From the above discussion, it would appear that the ultrastructure of the exine generally agrees with the findings of other investigators of Ericaceae. But, further TEM investigations of the pollen of Ericaceae, with both higher number of genera and species, are necessary to make comments on the evolutionary trend of exine structure of Walker and Doyle (1975) and Walker (1976).

Shrinkage

Pollen grains, either in monads or tetrads, were sometimes shrunken and/or broken, and probably susceptible to acetolysis. Therefore, it was difficult to study these pollen grains with LM and SEM. The shrinkage of pollen might be due to the poorly developed exine caused by genetic abnormalities and/or obstruction during pollen development process. The thinner exine or tectum might be readily destroyed during acetolysis treatments and/or broken down under high pressure in SEM, may cause the shrinkage and/or breakdown of pollen on SEM stub in some specimens. In this present study, I have tried to find out the possible reasons of pollen shrinkage with the help of TEM observations. And I have reached to a

conclusion that many factors viz., thin tectum (*Oxydendrum*), poorly developed septum wall (e.g., undulated septum in *Cavendishia*), heterodynamosporus tetrads (e.g., *Gaultheria*), etc. either independently or collectively might be responsible for the shrinkage of pollen grains.

Pollen morphology and the taxonomic system

Palynological observations of the present study supported the family delimitation of Ericaceae *sensu* Kron et al. (2002a) which recognized eight subfamilies and twenty tribes (Chapter 3; previous discussion). Although the palynological features of the Ericaceae is eurypalynous enough to differentiate the species within the genus, these have limited potential to clarify the higher taxonomic levels e.g., at the tribal and/or subfamilial classification (Chapter 3). The overall distribution pattern of palynological characters among the tribes and/or subfamilies is presented in Table 4-5 and based on LM and SEM observations two dichotomous keys to the Ericaceae pollen have been made. Although many intermediate types of exine sculpture were observed with SEM, the latter key has found sometimes effective to identify the lower level taxa (e.g., species).

Dichotomous key to Ericaceae pollen based on LM observations.

- 1a. Pollen grains dispersed as monad -----
 ----- Enkianthoideae, Monotropeae, Pterosporeae, *Orthilia* and some *Erica* spp.
- 1b. Pollen grains dispersed as other than monad ----- 2
 - 2a. Polyads ----- *Chimaphila*
 - 2b. Tetrads ----- 3
 - 3a. Heterodynamosporus tetrads -----
 ----- some taxa of Vaccinieae, Oligarrheneae, Richeeae and Styphelieae
 - 3b. Isodynamosporus tetrads ----- 4

- 4a. Viscin threads present ----- *Bejaria, Elliottia, Epigaea, Kalmia, Phyllodoce, Rhodothamnus, Menziesia, Rhododendron* and *Therorhodion*,
- 4b. Viscin threads absent ----- 5
- 5a. Septal (partition) wall completely absent between two neighboring grains -
----- *Ceratostema* and *Lyonia ligustrina*
- 5b. Septal wall present between two neighboring grains ----- 6
- 6a. With distinct perforations -----
----- *Andromedeae, Arctostaphylos* and *Comarostaphylis*
- 6b. Without distinct perforations ----- 7
- 7a. Endocracks distinct ----- rest of the Ericoideae
- 7b. Endocracks absent or indistinct ----- *Arbutoideae, Cassiopoideae, Harrimanelloideae,* and rest of the *Vaccinioideae*

Dichotomous key to Ericaceae pollen based on the exine sculpture with SEM.

- 1a. Primary sculpture distinct ----- 2
- 2a. Primary sculpture moderate to coarsely (muri width > 0.5 μm) rugulate-psilate (rarely verrucate like) -----3
- 3a. Primary sculpture rugulate (rarely verrucate) ----- 4
- 4a. Primary sculpture unit covered with secondary sculpture ----- 5
- 5a. Secondary sculpture unit minute (diam. < 0.2 μm) ----- 6
- 6a. Secondary sculpture minute granules ----- Type 1 – RG
- 6b. Secondary sculpture striate ----- Type 2 – RS
- 5b. Secondary sculpture unit moderate (diam. > 0.2 μm) granulate to short striate ----- Type 3 – RGS
- 4b. Primary sculpture unit without distinct secondary sculpture ----- Type 4 – R
- 3b. Primary sculpture perfectly psilate ----- 7

- 7a. Without any secondary sculpture ----- Type 5 – P
- 7a. With striate secondary sculpture ----- Type 6 – PS
- 2b. Primary sculpture striate ----- Type 7 – S
- 1b. Primary sculpture indistinct ----- 8
- 8a. Secondary sculpture unit fine (diam. < 0.5 μ m) ----- 9
- 9a. Secondary sculpture laterally not elongated ----- 10
- 10a. Secondary sculpture fine (diam. < 0.5 μ m) verrucate ----- Type 8 – FV
- 10b. Secondary sculpture fine gemmate-pilate ----- Type 9 – FG
- 9b. Secondary sculpture clearly elongated laterally (striate) ----- 11
- 11a. Secondary sculpture fine short striate with verrucae ----- Type 10 – FS
- 11b. Secondary sculpture fine, narrow straight-edged striate ----- Type 11 – NS
- 8b. Secondary sculpture unit moderate (diam. > 0.5 μ m) ----- 12
- 12a. Secondary sculpture moderate gemmate-pilate ----- Type 12 – MG
- 12b. Secondary sculpture moderate rugulate-pilate ----- 2a

Type 1 – RG: *Enkianthus nudipes*, *E. subsessilis*, *E. quinqueflorus*, *E. serotinus*, *Arctostaphylos nummularia* (Rose s.n, Rose 61009), *Ceratiola ericoides*, *Erica multiflora*, *E. tetralix*, *E. barbiger*, *E. curvistyla*, *E. globiceps* ssp. *consors*, *E. similis*, *E. spiculifolia*, *E. uberiflora*, *Disterigma acuminatum*, *D. humboldtii*, *D. popenoei*, *Gaylussacia baccata*, *G. reticulata*, *Orthaea secundiflora*, *Themistoclesia epiphytia*, *Thibaudia domingensis*

Type 2 – RS: *Arbutus canariensis*, *Arctostaphylos andersonii*, *A. auriculata*, *A. bakeri*, *A. densiflora*, *Comarostaphylis discolor* ssp. *discolor*, *C. glaucescens*, *Rhodothamnus chamaecistus*, *Andromeda polifolia* (Takahashi & Fujita 9753), *Gaultheria adenothrix*, *G. erecta*, *G. procumbens*, *Leucothoë keiskei*, *Cavendishia adenophora*, *C. bracteata*,

C. capitulata, *C. divaricata*, *C. isernii* var. *pseudospicata*, *C. marginata*, *C. pubescens*, *Demostenesia weberbaueri*, *Gaylussacia dumosa*, *Macleania rupestris*, *Satyria panurensis*, *S. pilosa*, *S. warszewiczii*, *Thibaudia albiflora*, *T. floribunda*, *Vaccinium bracteatum*, *V. wrightii*, *V. oldhamii*, *V. emarginatum*, *V. corymbosum* (Utech et al. 83-050), *V. myrtilloides*, *V. sprengelii*, *V. myrtilus*, *V. scoparium*, *V. macrocarpon*, *V. floribundum* var. *floribundum*, *V. uliginosum* (9908), *V. vitis-idaea*

Type 3 – RGS: *Kalmia ericoides* var. *aggregata*, *Gaultheria shallon*, *Disterigma alaternoides*, *D. popenoei*, *Gonocalyx smilacifolius*, *Themistoclesia cutucuensis*, *V. stamineum*

Type 4 – R: *Enkianthus nudipes*, *Arctostaphylos glauca*, *A. viscida*, *Kalmia angustifolia*, *K. buxifolia*, *K. latifolia*, *K. polifolia*, *Phyllodoce caerulea*, *P. nipponica* var. *oblonga*, *Menziesia pentandra*, *Rhododendron tsusiophyllum*, *R. decorum*, *R. diversipilosum*, *R. subarcticum*, *Harrimanella stelleriana*, *Andromeda polifolia* (Takahashi 9889), *Zenobia pulverulenta*, *Chamaedaphne calyculata*, *Gaultheria prostrate*, *G. bracteata*, *G. rigida*, *G. eriophylla* var. *eriophylla*, *G. tomentosa*, *G. anastomosans*, *G. buxifolia*, *G. itatiaiae*, *G. myrtilloides* var. *myrtilloides*, *G. insane*, *Agarista coriifolia* var. *coriifolia*, *A. eucalyptoides*, *A. salicifolia*, *Lyonia ferruginea*, *L. lucida*, *Pieris nana*, *P. japonicum*, *Disterigma empetrifolium*, *Sphyrospermum boekii*, *S. buxifolium*, *Themistoclesia anfracta*, *T. mucronata*, *Vaccinium corymbosum* (Spon. & Bouf. 1764, Meyer & Mazzeo 13278), *V. myrsinites*, *V. smallii* (Kikuchi s.n.), *V. microcarpum*

Type 5 – P: *Bryanthus gmelinii*, *Erica dumosa*, *E. recurvifolia*, *Kalmia procumbens*, *Vaccinium smallii* (Takahashi 24491)

Type 6 – PS: *Diplycosia heterophylla*, *Leucothoë grayana* var. *oblongifolia*, *Agapetes oblonga*, *Vaccinium sprengelii*, *V. vacciniaceum*, *V. parvifolium*

Type 7 – S: *Cassiope* spp.

Type 8 – FV: *Enkianthus chinensis*, *E. deflexus* (Yamazaki 2537), *E. campanulatus*, *E. campanulatus* var. *palbinii*, *Erica cinerea*

Type 9 – FG: *Enkianthus cernuus*, *E. cernuus* f. *rubens*, *E. sikokianus*, *Bejaria aestuans*, *B. resinosa*, *B. subsessilis*, *B. racemosa*, *Rhododendron dilatatum*, *R. hidakanum*, *R. indicum*, *R. japonicum*, *R. kaempferi*, *R. macrosepalum*, *R. nudipes* var. *niphonphyllum*, *R. schlippenbachii*, *R. semibarbatum*, *R. trinerve*, *R. wadanum*, *R. weyrichii*, *R. quinquefolium*, *R. aureum*, *R. brachycarpum*, *R. degronianum*, *R. macrostemon*, *R. viscistylum* var. *amakusaense*, *R. arborescens*, *R. albrechtii*, *R. dauricum*, *R. davidsoniaum*, *R. formosanum*, *R. kieskie*, *R. lapponicum*, *R. mucronulatum* var. *ciliatum*, *Therorhodion camtschaticum*, *T. redowskianum*, *Vaccinium japonicum*

Type 10 – FS: *Agapetes bracteata*

Type 11 – NS: *Menziesia* spp.

Type 12 – MG: *Corema conradii*, *Empetrum nigrum*, *Daboecia cantabrica*, *Erica axillaris*, *E. trimera* ssp. *keniensis*, *E. plumosa*, *Elliottia bracteata*

Table 4-5: Variation in pollen characters among the tribes/subfamilies of Ericaceae showing the range of mean values in μm .

Name of Tribe/ Subfamily	PDU*	D	P	d	D/d	P/E	L or 2f	W	L/W or 2f/W	L/P or 2f/D	Endoap. Length	Endoap. Width	Apo. Exine Thick.	Meso./ Septum Thick.	Sculpture Type**	Sexine Thick. †	Nexine Thick. †	Sexine- Nexine ratio †
Enkianthoideae	M	-	17.9-29.9	15.1-29.9	-	0.95-1.48	13.1-24.3	0.7-2.3	7.74-34.71	0.56-0.84	0.5-2.8	5.2-9.0	1.0-2.6	1.1-2.2	FV, FG, RG, R	0.5	0.3-0.4	1.26-1.44
Arbutoideae	T	38.8-54.4	19.0-28.5	31.7-44.1	1.12-1.29	0.59-0.65	22.1-34.3	0.5-2.8	7.89-64.80	0.44-0.68	0.7-2.9	5.8-14.9	1.6-3.8	0.6-1.9	RS, RG, R	0.8-0.9	0.8-1.0	0.85-0.95
Ericoideae																		
Bejarieae	T	33.3-48.8	17.4-25.0	19.9-35.7	1.31-1.67	0.68-0.87	11.8-23.1	0.4-1.7	6.94-57.75	0.26-0.69	1.0-1.8	6.3-13.4	2.1-3.0	0.9-2.8	FG, P	1.2	1.0	1.2
Empetreae	T	32.5-37.5	17.8-20.2	22.9-27.3	1.37-1.42	0.74-0.78	13.6-17.6	0.9	19.56	0.36-0.54	0.6	5.2	2.0-2.1	2.5	RG, MG	n.d.	n.d.	n.d.
Ericaceae	T/M	29.8-48.4	15.5-26.4	16.8-36.8	1.27-1.55	0.66-1.37	12.1-29.5	0.4-4.3	3.6-37.2	0.32-0.75	0.4-3.4	3.7-11.2	1.4-3.1	0.7-3.2	MG, FV, RG, P	0.6-0.9	0.5-0.8	1.0-1.8
Phyllodoceae	T	24.4-53.3	12.8-26.9	17.3-38.7	1.31-1.49	0.66-0.76	11.5-21.5	0.4-2.3	5.0-41.0	0.34-0.67	0.4-2.0	5.8-11.6	1.6-2.5	0.7-1.9	MG, R, RGS, P, RS	0.5	0.5	1.0
Rhodoreae	T	30.9-67.1	16.3-35.8	16.3-35.8	1.31-1.51	0.66-0.81	14.5-30.4	0.7-2.9	5.1-35.43	0.30-0.54	0.6-2.6	6.2-15.2	1.7-3.6	0.6-3.6	NS, FG, R	1.1-1.3	0.7-1.0	1.1-1.6
Cassiopoideae	T	24.4-30.4	12.8-15.4	17.0-22.5	1.34-1.49	0.68-0.78	17.2-22.4	0.6-1.0	22.4-30.83	0.64-0.76	0.5-0.8	6.9-9.4	0.9-1.7	0.7-1.1	S	0.4	0.4	1.0
Harrimanelloideae	T	28.3	14.6	20.1	1.40	0.73	22.5	0.4	55.5	0.78	0.6	9.5	1.9	0.7	R/P, R/RS	0.6	0.5	1.07
Vaccinioideae																		
Andromedeae	T	35.5-44.6	17.9-23.8	27.4-33.5	1.30-1.37	0.65-0.73	21.3-27.3	2.1-3.0	7.33-10.5	0.48-0.66	1.3-2.2	7.7-10.6	1.7-2.4	0.7-1.0	R, RS	0.9	0.9	1.0
Gaultherieae	T	24.8-59.6	12.5-30.5	19.0-44.9	1.19-1.43	0.63-0.75	14.5-28.3	0.5-5.1	5.55-41.60	0.41-0.67	0.4-3.5	5.2-17.2	1.4-3.1	0.6-1.8	R, PS, RS, RGS	0.5-0.7	0.5-0.9	0.7-1.0
Lyonieae	T	28.0-48.6	15.1-24.3	22.0-35.6	1.22-1.41	0.62-0.74	12.5-29.0	0.4-2.4	6.9-41.43	0.33-0.67	0.5-3.0	5.0-17.3	1.4-2.6	0.7-2.5	R, PS	0.9	0.8	1.1
Oxydendreae	T	33.4	16.5	26.5	1.26	0.62	17.3	0.7	24.71	0.52	0.9	9.4	2.0	1.2	n.d.	0.4	0.6	0.7
Vaccinieae	T/IT	28.6-72.4	15.0-39.3	21.8-50.8	1.26-1.54	0.63-0.78	13.4-42.4	0.4-4.2	4.12-43.86	0.36-0.69	0.6-5.9	6.4-12.2	1.1-3.0	0.7-2.6	FS, PS, RS, RG, RGS, R, P	0.4-1.0	0.4-0.8	0.6-1.6

PDU: pollen dispersal unit, D: tetrad diameter, P: polar length, d(E): equatorial diameter, 2f(L): ectoaperture length, W: ectoaperture width, Endoap.:

Endoaperture, Apo.: apocolpial, Thick.: thickness, Meso.: mesocolpial, n.d.: not discerned.

* M: Monad, T: Isodynamosporus tetrad, IT: Heterodynamosporus tetrad

** Based on SEM observation; Abbreviations of Types are described in preceding paragraphs and shown in Fig. 3.

† Based on TEM observations.

Pollen morphology and mode of pollination in Ericaceae

The existence of a general relationship between pollen morphology and the pollen vectors of anemophilous and entomophilous species has suggested by Wodehouse (1935). In general, wind pollinated species have smooth, dry pollen, while entomophilous plants have highly sculptured, oily pollen grains. But, the question of whether and to what extent the features of the angiosperm pollen reflect adaptations to the respective pollination mode, is remained unsettled (Hesse 2000). One of the major reasons of this problem is the present little knowledge about the pollination vectors in many taxa, even at the family level. Similar situation also prevails in Ericaceae, especially its tropical members, despite its popularity among horticulturalists. Most records of pollinators are simply of flower visitors, and how effective these visitors may be in pollination is unknown (Stevens 2004). Flowers are usually hermaphroditic and autogamy is quite common in Ericaceae (Stevens 2004 and references therein). The pendulous, urn-shaped, cylindrical, or bell-shaped flowers typically produce nectar and are visited by bees and wasps in temperate and subtropical latitudes. In the montane tropics many species have tubular red flowers and pollinated by hummingbirds (Navaro 2001, Luteyn 2002b and references therein, Judd et al. 2002, Freitas et al. 2006). A small portion of species is also wind pollinated e.g., Empetreae (Kron 1996), *Erica* (Oliver 2000). In the following paragraphs, I will discuss the possible correlation between pollen morphology and pollination mechanism of the Ericaceae.

About 20000 species in 72 families of flowering plants are presumed to be buzz-pollinated by bees (Buchmann 1983 and references therein). These buzz-pollinated flowers share a number of floral traits viz., often open bowl-shaped or reflex petals, small to average-sized, often lack of nectar, and pollen grains usually in monad form (Buchmann 1983). Although some exceptions are observed, the feature shared by most buzz-pollinated flowers is anther dehiscence by small apical pores. Pollen of buzz-pollinated plants is characterized by its small size (5 – 40 μm), relatively dry surface and smooth exine with little sculpturing

(Buchmann 1983). Many genera of Ericaceae e.g., *Arbutus*, *Arctostaphylos*, *Cassiope*, *Erica*, *Kalmia*, *Vaccinium* etc. are known as buzz-pollinated (Buchmann 1983, Knudsen and Olesen 1993, Jacquemart 1997, Mahy et al. 1998, Houston and Ladd 2002, Javorek et al. 2002, Escaravage and Wagner 2004). All of these genera are characterized by anther dehiscence by apical pores (Stevens 1971), medium to small sized (<50 μm) pollen tetrads, and smooth ornamentation (mostly coarsely rugulate to coarsely rugulate-psilate or psilate) which may give additional insight on their pollination behavior. Here the small pollen grains may be adaptive to buzz-pollination (Buchmann 1983). Although the medium sized (20 – 40 μm) dry pollen grains with smooth ornamentation also characterized wind pollination (Linder 2000 and references therein), these pollen characters do not represent the wind pollination mode in Ericaceae as flowers are characterized by poricidal dehiscence of anther. In the Ericaceae, though the genus *Rhododendron* has two, large, and rounded apical pores per anther, is not buzz-pollinated, or rarely so (Buchmann 1983). The pollen of *Rhododendron* is attached in long sticky viscin threads which reflect an adaptation to the highly specialized zoophilous pollination mode as discussed succeeding paragraph.

The viscin threads associated with the pollen tetrads is characterized mostly species belong to tribes Bejarieae, Phyllodoceae and Rhodoreae, which are pollinated by bumblebees, honeybees, birds, and some degree, also by flies, the viscin threads are restricted to taxa with erect flowers (Wallace 1975) and are much thinner, smooth and more rare than in Onagraceae (Skvarla et al. 1978, Waha 1984). Recently, Hesse et al. (2000) reviewed the origin, nature, systematic distribution, and the respective function of highly variable and diverse thread-forming structures including viscin threads in angiosperm anther. Any pollen material with viscin threads points to the highly specialized pollination mode. It has been suggested that viscin threads increase the efficiency of pollination, and their presence implies highly specific pollinators for accurate delivery of pollen to stigma. Although many authors thought that the primary and only function of viscin threads is to form a large, flexible pollen aggregates

during the pollen transfer, rather to fix the pollen at the border of the opened pollen sac, to prevent pollen from premature falling (Hesse et al. 2000). The viscin threads would also play a role in pollen presentation. According to Skvarla et al. (1978) there is significant association between the structure of viscin threads in Onagraceae and the pollen vector: beaded viscin threads associated with birds and moth pollinated taxa whereas smooth ones occur in bee pollinated taxa. The presence of viscin threads in *Paleoenkianthus* suggests that the highly specific modes of pollination in insect-pollinated angiosperms had evolved by the mid-Cretaceous (Nixon and Crepet 1993).

Hummingbirds are other important pollinators of Ericaceous plants especially in the Neotropics (Luteyn 2002b). The hummingbirds-pollinated flowers share a number of floral traits viz., hanging flowers (and more generally flowers exhibiting negative angles with respect to the horizontal), red color, tubular shape, absence of scent, and produce large amounts of diluted nectar rich in sucrose (Aizen 2003). However, the studied Neotropical hummingbirds-pollinated species of Ericaceae also do not show any special features in their pollen morphology.

Empetraceae have reduced perianth parts and often wind pollinated (Kron 1996). Pollen grains of the members of the tribe Empetreae *sensu* Kron et al. (2002a) are medium, aperture elongate and narrow, exine sculpture spinuliferous, consisting of irregular elements forming a regular pattern (Kim et al. 1988). Narrow aperture of Empetreae pollen may be an adaptation to anemophily to reduce/avoid water loss during transportation, but exine sculpture contradicts with general know-how that the wind pollinated species have relatively smooth exine, with strong sculpturing being characteristic of zoophilous species (Faegri and Iversen 1989, Linder 2000). Similar result was also reported by Davis (1997), viz. zoophilous species (by insects and/or birds) with smooth exine sculpture and anemophilous species with very granular sculpture within Ericoideae.

It may be concluded that there is a clear correlation between floral morphology, pollen characters and pollination in Ericaceae as indicated in other taxa also (e.g., Ferguson and Pearce 1986 in *Bauhinia*). And the floral morphology mostly influenced the mode of pollination in Ericaceae. Rebelo et al. (1985) also reached to similar conclusion for *Erica*, the three pollination syndromes (bird, insect, and wind) found in this genus are highly correlated with floral morphology. This type of direct correlation between floral morphology and the pollination mechanism is also reported for other taxa in different families (e.g., *Pedicularis*, Wang et al. 2003; Marcgraviaceae, Lens et al. 2005). The presence of significant correlation between pollen morphology and mode of pollination is also reported for different taxa (e.g., Leguminosae, Ferguson and Skvarla 1982; Araceae, Grayum 1986; Hydrocharitaceae, Tanaka et al. 2004). But based on the fragmentary knowledge of pollination biology in Ericaceae so far, we may conclude that the palynological features of Ericaceae fail to demonstrate a clear relationship with different pollen dispersal mechanisms. However, some of the pollen characters e.g., presence of viscin threads, small and smooth ornamentation etc. show some distinct correlations with the mode of pollination in Ericaceae e.g., in Rhododendroideae. Field studies on the pollination mechanisms in the family would be of high interest in the light of the information now known concerning trends of specialization of its pollen.

Recently, Fenster et al. (2004) reviewed and discussed the different aspect pollination syndromes and floral specialization. According to them, different floral traits viz., rewards (e.g., pollen, nectar, resins, oils, etc.), color, morphology, fragrance etc. are responsible for selection of functional groups of pollinators. Pollen is the reward offered by plants with poricidally dehiscent anthers, and almost exclusively to bees that can vibrate their flight muscles to buzz the flowers (Fenster et al. 2004). Adaptive floral features e.g., poricidal dehiscent anther, production both of pollen and nectar as reward, etc., in most members of the Ericaceae helped buzz-pollination to emerge as the commonest pollination mode in Ericaceae.

Biogeography and palynological features of Ericaceae

In this study, the palynological characters as a whole did not show any correlation or specific distribution pattern with the wide geographical distribution of the family Ericaceae. But variation in different palynological characters, e.g., pollen size, aperture number etc., due to geographical distribution was found in species level or other lower taxa (e.g., Takahashi 1987a, Sarwar and Takahashi 2006b, Chapter 3). In the following paragraphs I will concentrate this discussion only on the character distribution pattern of pollen tetrads, as the studied species with monad pollen is distributed in two restricted area viz., the SE Asia and the Cape Region of South Africa.

Palynologically, the South American and Asian specimens are more diverse than those of other regions. In range of average value, tetrad diameter Class II and 3 (30.1 – 50.0 μm) constituted the major portion of pollen all over the geographical distributions (Table 4-6). South American and Asian taxa had relatively larger pollen tetrads compared to other geographical regions, and interestingly all African taxa in the Class II (30.1 – 40.0 μm). Only seven taxa (4 South American and 3 Asian) possessed pollen tetrad of diameter Class V (60.1 – 70.0 μm) and only one Oceanian species, *Dimorphanthera microphylla*, possessed diameter Class VI (72.4 μm) pollen tetrad (Table 4-6). Distribution pattern for the other palynological features viz., P, D/d, P/E, 2f/W, 2f/D, apocolpial and septum exine thickness, also found similar (lies between 15.1 – 25.0 μm , 1.20 – 1.39, 0.66 – 0.75, 20.0, 0.41 – 0.60, 1.6 – 2.5 μm and < 1.5 μm , respectively) (Table 4-6). However, the septum thickness distribution pattern was quite different between South American and Asian taxa. The South American taxa had relatively thinner (< 1.6 μm) septum, the Asian taxa possessed relatively thicker (> 1.6 μm) septum. Another interesting finding, the pollen tetrads with perforated septum were commonly found in New World taxa, rarely in Old World taxa.

Table 4-6. Geographical distribution pattern of different palynological features of the Ericaceous pollen tetrads.

Geographical Regions	Tetrad Diameter (D)						Polar Length (P)						D/d					
	I	II	III	IV	V	VI	I	II	III	IV	V	VI	I	II	III	IV	V	VI
North America	1	16	22	3	0	0	1	14	22	5	0	0	4	10	16	10	1	0
South America	3	20	26	14	4	0	2	19	27	14	5	0	0	1	17	40	8	1
Central America and the Caribbean	1	8	8	2	0	0	0	8	9	2	0	0	2	1	7	9	0	0
Asia	5	20	17	9	4	0	0	24	16	9	2	3	0	3	24	24	2	1
Europe	1	5	6	3	0	0	0	2	9	3	1	0	0	3	8	3	1	0
Africa	0	7	0	0	0	0	0	7	0	0	0	0	0	1	3	3	0	0
Oceania	1	1	0	2	0	1	1	1	0	2	0	1	0	0	0	4	1	0

Table 4-6: Continued.

Geographical Regions	P/E				Ectoaperture Length (2f)				2f/W						
	I	II	III	IV	I	II	III	IV	I	II	III	IV	V	VI	VII
North America	16	22	4	0	15	24	3	0	13	23	2	0	3	0	1
South America	6	57	4	0	31	24	9	2	19	27	14	5	0	0	1
Central America and the Caribbean	4	14	1	0	8	10	1	0	3	10	5	1	0	0	0
Asia	3	42	8	1	34	20	2	0	18	25	7	1	1	1	0
Europe	2	10	3	1	6	8	1	0	1	9	3	2	0	0	0
Africa	0	7	0	0	4	3	0	0	0	5	0	2	0	0	0
Oceania	0	4	1	0	2	2	1	0	0	3	2	0	0	0	0

Table 4-6: Continued.

Geographical Regions	2f/D						Apocolpial Exine Thickness						Septum Thickness					
	I	II	III	IV	V	VI	I	II	III	IV	V	VI	I	II	III	IV	V	VI
North America	0	6	8	18	10	0	6	20	13	2	1	0	20	8	10	2	0	0
South America	2	10	16	23	12	2	6	32	20	7	2	0	31	27	4	1	2	0
Central America and the Caribbean	0	2	5	9	3	0	0	12	6	1	0	0	13	3	3	0	0	0
Asia	1	11	22	12	7	0	5	23	14	7	4	1	11	20	14	7	0	1
Europe	0	4	2	6	2	2	5	4	4	2	1	0	6	7	2	1	0	0
Africa	0	0	2	3	1	1	0	3	1	1	1	1	0	2	3	0	2	0
Oceania	0	0	2	3	0	0	0	3	1	1	0	0	3	2	0	0	0	0

Classes of the palynological feature refer to Table 2-2.

The primary exine sculpture of Ericaceae pollen commonly varies from indistinct to distinct; moderately-coarsely rugulate through coarsely rugulate-psilate to psilate, and like the other palynological features, does not show any correlation with geographical distribution of plants. However, a distinct geographical distribution pattern is observed in the secondary sculptures on the primary exine sculpture; finely to clearly striate in New World taxa vs. finely to clearly granulate, or faintly striate in Old World taxa (Chapter 3).

Neither taxa from the Old World show some characteristic palynological features, nor the New World taxa. This suggests that the diversity of palynological features of the Ericaceae may be due to independent diversification resulting from strong selecting pressure from pollinators as discussed in the preceding part of discussion, rather than a result of single origin. The diversity observed in palynological features of the Ericaceae may also support the Gondwanan origin of this group of plants (Raven and Axelrod 1974). However, the recent study on origin and biogeographic patterns in Ericaceae has indicated that the family Ericaceae originated in Laurasia (either North America, or North America + Eurasia) instead of in Gondwana, and the highly diverse “Gondwana” groups, both morphologically and palynologically, are actually derived from within Ericaceae (Kron and Luteyn 2005).

ACKNOWLEDGMENTS

Firstly, I am thankful to the Almighty for blessing me life to pen these words.

I would like to express my sincerest gratitude and obligation to my supervisor Professor Dr. Hideki Takahashi, Laboratory of Systematic Botany, Hokkaido University, for his scholastic guidance, intellectual stimulation, constant motivation, support and warmth of character that made my research period so comfortable to accomplish this mammoth task. I most heartily thank him for giving me the opportunity and freedom to pursue my goal, and to expand my horizons in field of Palynology. I would like to thank him again for collecting most of the pollen specimens used in this investigation during his visits to different herbaria, thus saving me hours of work collecting pollen from herbarium specimens or in the field, and for permission to use many of his unpublished data.

I thank my graduate committee members, Professor Dr. Toshihiko Yamada and Associate Professor Dr. Hiroko Fujita of the Field Science Center for Northern Biosphere, Hokkaido University, and Professor Dr. Masaaki Suwa and Associate Professor Dr. Masahiro Ohara of the Laboratory of Systematic Entomology, Hokkaido University, for their insightful discussion and wise counsel during the course of my study at Hokkaido University. All of them read and provide valuable suggestions and improvements to the draft of this dissertation. I learnt a multitude of important thinking from our discussions.

I am grateful to the directors and curators of the following herbaria: C, E, GB, KYO, NSW, S, SAPS, SAPT, TI and TUS, for allowing me or us to examine and/or send specimens on loan and the use of polliniferous material from their collection.

I duly acknowledge my gratefulness and thanks to Mr. Toshiaki Ito and Ms. Aoyama Yuriko, Laboratory of Electron Microscopy, Faculty of Agriculture for their invaluable

technical assistance and cooperation during scanning and transmission electron microscopic studies and photography of pollen grains.

I express my gratitude to all members of Systematic Botany Laboratory for providing a cordial and a highly enthusiastic atmosphere at the Lab. While working on my research many people have supported me with motivation, inspiration and technical assistance. Especially, I would like to thank Ms. Narita Masumi for her help during my early establishment period; Dr. Mochida Makoto, Ms. Murakami Maki and Mr. Izawa Takeshi, for their help in all official matter related to save and peaceful stay in Sapporo; and Mr. Tomas Lackner for friendly and useful linguistic discussion on different topics. My sincere thanks to all staffs and members of the Botanic Garden, and the Museum of Hokkaido University for their cordial help and inspiration during my study period. I am thankful to the Monbukagakusho, Japan for proving me the scholarship and supporting my research activity, and to Bangladesh Agricultural University, Bangladesh for the study leave.

Last, but not least, I desire to express my warmest thanks and love to my wife for her considerate and sacrificing care in helping me to fulfill my commitment, and finally I must pay gratitude to my beloved children for their unremitting lack of complaint and loving support all these days in Sapporo.

Summary

A detailed description of the range of pollen morphological variation within the family Ericaceae *sensu* Kron et al. (2002a) has been presented. For this palynological investigation, 275 taxa of 270 species representing 57 genera and 6 subfamilies of Ericaceae were studied with light and scanning electron microscopy. Thirty one species from these taxa were further examined with transmission electron microscopy. The systematic significance and evolutionary trends of palynological characters have been discussed in the light of the recent phylogenetic classification of the Ericaceae. The main results of this study are summed up as follows:

1) Morphological: Pollen grains are dispersed as monads, tetrads (both iso- and hetero-dynamosporous) or polyads (in *Chimaphila*), commonly medium (30 – 50 µm) in size and 3-colpor(oid)ate. Viscin threads are commonly absent, but present only in a few genera: *Bejaria*, *Elliottia*, *Epigaea*, *Kalmia*, *Phyllodoce*, *Rhodothamnus*, *Menziesia*, *Rhododendron* and *Therorhodion*, all belonging to the subfamily Ericoideae. A dichotomous key to the pollen of Ericaceae was prepared with the characters observed under LM. With SEM, exine sculpture varies from finely verrucate to psilate, and twelve major exine sculptural types have been recognized. A dichotomous key to the pollen of Ericaceae was also prepared based on the SEM observations of the exine sculpture. With TEM, the exine structure of ericaceous pollen is basically the same, and is composed of sexine; tectum and columellae and nexine; foot layer and endexine. The TEM observations were found useful to confirm some critical palynological observations with LM and/or SEM viz., heterodynamosporous tetrads (in *Gonocalyx*), different types of exine sculpture, tetrads without septa (in *Ceratostema*), presence of pollenkitt and pollenkitt ropes (in *Notopora*), cause of pollen shrinkage, and identification and realignment of taxa (e.g., *Tsusiophyllum tanakae*).

2) Systematic: The family Ericaceae is eurypalynous enough to clarify the differentiation of the species within the genus, but has limited potential to clarify the higher level relationships e.g., at the tribal or subfamilial classification (Chapter 3). In general, the family definition of Ericaceae *sensu* Kron et al. (2002a), which recognizes eight subfamilies: Enkianthoideae, Monotropeoideae, Arbutoideae, Ericoideae, Cassiopoideae, Harrimanelloideae, Styphelioideae and Vaccinioideae, and twenty tribes, is supported by the present palynological point of view. The relationships among the genera of different subfamilies and tribes have also been supported with some exceptions. Qualitative palynological characters viz., compactness of tetrads, exine sculpture, etc. were found to be taxonomically more important than quantitative characters viz., tetrad diameter, aperture length, etc., and different characters important for different taxonomic groups viz., genera, tribes and/or subfamilies. Exine structure is found to be important to distinguish and/or segregate the closely related taxa.

Subfamily Enkianthoideae is characterized by monad pollen grains. The primary exine sculpture of Enkianthoideae taxa varied from indistinct to coarsely rugulate-psilate with the secondary exine sculpture fine granulate to fine gemmate-pilate. Based on quantitative palynological characters, members of the subfamily Arbutoideae always make a clade which indicates strong support to the monophyly of this subfamily. The genus *Arctostaphylos* and *Comarostaphylis* of the Arbutoideae are characterized by perforated septum. Along with other characters, endocracks have emerged as a character of taxonomic importance within this family. The pollen grains of subfamily Ericoideae are characterized by the clearly visible endocracks, which are absent and/or indistinct in most of the members of other subfamilies. Tribe Empetreae is characterized by relatively thicker septum than apocolpial exine. The very narrow slit-like aperture of Empetreae pollen appears to be a genetically controlled character, and might be an adaptation to anemophily to reduce/avoid the water loss during the period of transport. The geographical variation of tetrad diameter of *Erica* has supported the

evolutionary trend in pollen size from medium (25 – 50 μm) to minute (< 25 μm). Monad pollen grains of two *Erica* species, *E. barbiger*a and *E. recurvifolia*, showed very unique palynological features, granular columellae and canalized tectum. The tectum with canals was also found in *Rhododendron japonicum* and *Oxydendrum arboreum*, but the canals were few in number. The pollen tetrads with viscin threads of the tribe Bejarieae, Phyllodoceae and Rhodoreae of the subfamily Ericoideae has clearly shown the adaptation to a highly specialized zoophilous pollination mode.

From a palynological point of view, the subfamily Cassiopoideae is a very good entity and is characterized by striate exine sculpture. The striate type of exine sculpture was found to be extremely rare in the Ericaceae, though it is a somewhat common type within the angiosperms. The occurrence of both iso- and hetero-dynamosporus tetrads confirms the close relationship between the subfamily Vaccinioideae and Styphelioideae, and indicates the possible parallel evolution of “monad breakdown type” pollen development in these two subfamilies of Ericaceae. Tribe Andromedeae of subfamily Vaccinioideae is characterized by thin and perforated septum. The apocolpial exine sculpture has emerged as a good criterion to identify the monophyly of a genus (e.g., *Dimorphanthera*), and to describe relationships among the genera within tribes and/or subfamilies (e.g., *Satyria*). The secondary exine sculpture on the primary sculptures has emerged as a criterion to identify some of the tribes and/or subfamilies of Ericaceae (e.g., Vaccinieae). The report of the presence of viscin threads in pollen tetrads of *Gaylussacia* is not supported by the present study. Palynological features may play an important role in the generic realignment within the Neotropical Andean clade as suggested by molecular data (Kron et al. 2002b). The palynological features are also found important to the infrageneric classifications of some genera viz., *Arctostaphylos*, *Agarista*, *Enkianthus*, *Gaultheria*, *Gaylussacia*, *Lyonia*, *Pieris* and *Vaccinium*.

However, some taxonomic problems were presented and realignments of some taxa have been proposed from the palynological view point. For example, the present generic

composition of the tribe Bejarieae (subfamily Ericoideae) has not been supported by palynological characters. The two genera studied from this tribe are palynologically distinctly different; presence of viscin threads and finely gemmate-pilate exine sculpture in *Bejaria* vs. absence of viscin threads and psilate exine sculpture in *Bryanthus*. Therefore, the tribal limit of the tribe Bejarieae should be reassessed by the combined analyses of morphological, palynological and molecular data from higher number of both species and specimens. Individual generic status of three taxa has been suggested from their present recognition viz., *Erica recurvifolia* E.G.H. Oliv. to *Eremia recurvata* Klotzsch, which is characterized by the smallest equatorial diameter of pollen grains, and psilate primary exine sculpture with very fine (diam. < 0.1 μm) striate secondary sculpture; *Rhododendron tsusiophyllum* Sugim. to *Tsusiophyllum tanakae* Maxim., which is characterized by relatively smaller pollen tetrads, coarsely rugulate exine sculpture, and the smallest sexine-nexine ratio; and *Vaccinium japonicum* Miq. to *Hugeria japonica* (Miq.) Nakai, which is characterized by the smallest pollen tetrads, and the very exceptional exine sculpture where primary exine sculpture is indistinct, the secondary sculpture fine gemmate-pilate. A number of misplaced species have been identified in the course of this study, e.g., *Enkianthus sikokianus* (Palibin) Ohwi was incorporated into *E. campanulatus* (Miq.) Nicholson, *Pieris koidzumiana* Ohwi into *P. japonica* (Thunb.) D. Don.

Based on fragmentary knowledge of the pollination biology of the family, there are no clear correlations between pollinators and pollen features, except viscin threads which are directly correlated with insect pollination. Palynological features of the family Ericaceae do not show variation corresponding to the geographical distribution clearly, but variations are present at lower level taxa e.g., within genera (e.g., in *Enkianthus*, *Bejaria*, *Erica*, *Epigaea* etc.). The diversity observed in palynological features of the Ericaceae may support the Gondwanan origin of this group of plants. But, the recent study on origin and biogeographic patterns in Ericaceae has indicated that the family Ericaceae originated in Laurasia, and the

highly palynological diversity in “Gondwana” groups have been described as derived from within Ericaceae.

3) Evolutionary: The present study revealed a number of interesting primary evolutionary trends in different palynological features viz., pollen dispersal units is from monads to isodynamosporus tetrads to polyads or heterodynamosporus tetrads; compactness of tetrads – from compact to lobed; pollen size and shape – from medium to minute, and from subspheroidal to oblate; aperture number – from three to five; and exine sculpture – secondary sculpture absent or granulate to striate, within the family Ericaceae and suggestions have been made concerning the selective value of some of these trends. The palynological character evolution has also been found within a genus (e.g., *Enkianthus*, *Erica*, *Kalmia*, etc.).

In the course of the pollen survey a number of interesting discoveries were made. The most important discoveries include the following:

1) An extremely interesting and unique trend was discovered in the tetrad genera, in which the entire septal (proximal) wall of the pollen grains is completely lacking within the pollen tetrads (e.g., *Ceratostema*).

2) The parallel evolution of pseudomonad pollen tetrad development was discovered in the subfamilies Styphelioideae and Vaccinioideae.

3) Pollenkitt ropes were found for the first time on the dried herbarium specimen of Ericaceae as well as any other angiosperm families (e.g., *Notopora*).

4) Four aperturate grains in the pollen tetrads have been reported in a number of taxa for the first time in the family (e.g., *Vaccinium*).

Reference

- Airy-Shaw, H.K. 1940. Studies in the Ericales IV. Classification on the Asiatic species of *Gaultheria*. Kew Bull. 1940: 304–330.
- Aizen, M.A. 2003. Down-facing flowers, hummingbirds and rain. *Taxon* 52: 675–680.
- Anderberg, A.A. 1993. Cladistic interrelationships and major clades of the Ericales. *Plant Syst. Evol.* 184: 207–231.
- Anderberg, A.A. 1994. Cladistic analysis of *Enkianthus* with notes on the early diversification of the Ericaceae. *Nord. J. Bot.* 14: 385–401.
- Atkinson, R., Jong, K. and Argent, G. 1995. Cytotaxonomic observations in tropical *Vaccinieae* (Ericaceae). *Bot. J. Linn. Soc.* 117: 135–145.
- Banks, H. 2004. Structure in cesalpinoid legumes (Abs.). *Polen* 14: 50.
- Barth, O.M. and Barbosa, A.F. 1972. Catálogo sistemático dos pollens das plantas arbóreas do Brasil Meridional. XVI – Ericaceae. *Mem. Inst. Oswaldo Cruz* 70: 555–569 (with 3 plates) (in Spanish).
- Bell, C.R. 1959. Mineral nutrition and flower to flower pollen size variation. *Am. J. Bot.* 46: 621–624.
- Beug, H.J. 1961. Leitfaden der Pollenbestimmung. Gustav Fischer Verlag, Stuttgart. 4–9 pp. (in German)
- Blackmore, S. and Ferguson, I.K. (eds.) 1986. *Pollen and Spores: Forms and Function*. Linn. Soc. Symp. Series 12. Academic Press, London. 443 pp.
- Bohm, B.A., Brim, S.W., Hebda, R.J. and Stevens, P.F. 1978. Generic limits of the tribe Cladothamneae (Ericaceae), and its position in the Rhododendroideae. *J. Arnold Arbor.* 59: 311 – 341.

- Bouda, H. 1989. Pollen Morphology. Meisei-kikaku, Tokyo. 99–103 pp. (in Japanese)
- Buchmann, S.L. 1983. Buzz pollination in angiosperms. In Jones, C.E. and Little, R.J. (eds.). Handbook of Experimental Pollination Biology. Sci. Acad. Eds., New York. 73–113 pp.
- Carlquist, S. 1964. Pollen morphology and evolution of Sarcolaenaceae (Chalaenaceae). *Brittonia* 16: 231 – 254.
- Chen, S.-C., Zhang, X.-P., Ni, S.-F., Fu, C.-X. and Cameron, K.M. 2006. The systematic value of pollen morphology in Smilacaceae. *Plant Syst. Evol.* 259: 19–37.
- Clements, S.E. 1995. *Bejaria*. In Luteyn, J.L. (ed.). *Ericaceae – Part II: The superior-ovaryed genera*. Fl. Neotrop. Monogr. 66, New York Bot. Gard., Bronx. 54–106 pp.
- Cockerham, L.A. and Galletta, G.J. 1976. A survey of pollen characteristics in certain *Vaccinium* species. *J. Amer. Soc. Hort. Sci.* 101: 671–676.
- Cole, G.T. and Behnke, H.D. 1975. Electron microscopy and plant systematics. *Taxon* 24: 3–15.
- Collinson, M.E. and Crane, P.R. 1978. *Rhododendron* seeds from the Paleocene of southern England. *Bot. J. Linn. Soc.* 76: 195–205.
- Comtois, P. and Larouche, A. 1981. Morphologie pollinique des Éricales du Québec. *Natur. Can.* 108: 245–262. (in French)
- Cox, H.T. 1948. Studies in the comparative anatomy of the Ericales 2. Ericaceae subfamily Arbutoideae. *Am. Midl. Nat.*, 40: 493–516.
- Crane P.R., Friis E.M. and Pedersen K.R. 1986. Angiosperm flowers from the Lower Cretaceous: fossil evidence on the early radiation of dicotyledons. *Science* 232: 952–854.
- Crane P.R., Friis E.M. and Pedersen K.R. 1995. The origin and early diversification of angiosperms. *Nature* 374: 27–33.

- Cronquist, A. 1981. An Integrated System of Classification of Flowering Plants. Columbia Univ. Press. 479–483 pp.
- Dajoz, I., Till-Bottraud, I. and Gouyon, P.H. 1991. Evolution of pollen morphology. *Science* 253: 66–68.
- Davis, R.A. 1997. A palynological investigation of the Ericaceae, subfamily Ericoideae. Unpub. M.Sc. thesis. Univ. Stellenbosch, South Africa. 152 pp.
- Dessein, S., Ochoterena, H., de Block, P., Lens, F., Robbrecht, E., Schols, P., Smet, E., Vinckier, S. and Huyamans, S. 2005. Palynological characters and their phylogenetic signal in Rubiaceae. *Bot. Rev.* 71: 354–414.
- Díez, M.J. 1987. Empetraceae. In Valdes, B. Díez, M. J., and Fernandez, I. (eds.). Atlas Polinico de Andalucía Occidental. 161 p. (in Spanish)
- Díez, M.J. and Cornesa, J.L.P. 1987. Ericaceae. In Valdes, B. Díez, M. J., and Fernandez, I. (eds.). Atlas Polinico de Andalucía Occidental. 161–168 pp. (in Spanish)
- Diez, M.J. and Fernandez, I. 1989. Identification of Spanish Ericaceae by pollen morphology. *Pollen Spores* 31: 215–227. (in Spanish with English abstract)
- Diggs, G.M.Jr. 1995a. *Comarostaphylis*. In Luteyn, J.L. (ed.). Ericaceae Part II: the superior-ovary genera. Fl. Neotrop. Monogr. 66, New York Bot. Gard., Bronx. 146–193 pp.
- Diggs, G.M.Jr. 1995b. *Arctostaphylos*. In Luteyn, J.L. (ed.). Ericaceae Part II: the superior-ovary genera. Fl. Neotrop. Monogr. 66, New York Bot. Gard., Bronx. 133–145 pp.
- Donoghue, M.J. 1985. Pollen diversity and exine evolution in *Viburnum* and the Caprifoliaceae *sensu lato*. *J. Arn. Arbor.* 66: 421–469.
- Drude, O. 1889. Ericaceae. In Engler, A. and Prantl, K. Die Natürlichen Pflanzenfamilien, 4, 1. Leipzig. Engleman. 15–65 pp.
- Engler, A. and Prantl, K. 1889. Die Natürlichen Pflanzenfamilien, 4, 1. Leipzig. Engleman.
- Engler, A. and Prantl, K. 1891. Die Natürlichen Pflanzenfamilien, 3, 5. Leipzig. Engleman.

- Erdtman, G. 1952. Pollen Morphology and Plant Taxonomy- Angiosperms. Almqvist & Wiksell, Stockholm, Sweden. 161–162 pp.
- Erdtman, G. 1960. The acetolysis method– A revised description. *Svensk Bot. Tidskr.* 54: 561–564.
- Erdtman, G. 1986. Pollen Morphology and Plant Taxonomy- Angiosperms. E. J. Brill, Leiden. 553 pp.
- Erdtman, G., Berglund, B.E. and Praglowski, J. 1961. An Introduction to Scandinavian Flora. I. Almqvist and Wiksell, Stockholm. 92 pp.
- Escaravage, N. and Wagner, J. 2004. Pollination effectiveness and pollen dispersal in a *Rhododendron ferrugineum* (Ericaceae) population. *Plant Biol.* 6: 606–615.
- Fabre, G.M. and Paquereau, M. 1956. La détermination spécifique des pollens de bruyères en palynologie. Extrait 15th Cong. Préhist. France. pp. 709–717. (in French)
- Faegri, K. and Iversen, J. 1989. Textbook of Pollen Analysis. 4th ed. Faegri, K., Kaland, P.E. and Krzywinski, K. (eds.), John Wiley and Sons, UK. 328 pp.
- Fang, R. and Stevens, P.F. 2005. *Enkianthus*. In Wu, Z and Raven, P.H. (Eds.), Flora of China Vol. 14 (Apicaceae through Ericaceae). Science Press, Beijing, and Missouri Bot. Gard. Press, St. Louis. 243-245 pp.
- Fenster, C.B., Armbruster, W.S., Wilson, P., Duhash, M.R. and Thomson, J.D. 2004. Pollination syndrome and floral specialization. *Ann. Rev. Ecol. Evol. Syst.* 35: 375–403.
- Ferguson, I.K. and Pearce, K.J. 1986. Observations on the pollen morphology of the genus *Bauhinia* L. (Leguminosae: Caesalpinioideae) in the Neotropics. In Blackmore, S. and Ferguson, I.K. (eds.). Pollen and Spores: Form and Function, Acad. Press, London. 283–296 pp.

- Floyd, J.W. 2002. Phylogenetic and biogeographic patterns in *Gaylussacia* (Ericaceae) based on morphological, nuclear DNA, and chloroplast DNA variation. *Syst. Bot.* 27: 99–115.
- Foss, P. J. and Doyle, G. J. 1988. A palynological study of the Irish Ericaceae and *Empetrum*. *Pollen Spores* 30: 151–178.
- Frank, J.W. and Watson, L. 1963. The pollen morphology of some critical Ericales. *Pollen Spores* 5: 51–66.
- Freitas, L., Galetto, L. and Sazima, M. 2006. Pollination by hummingbirds and bees in eight syntopic species and putative hybrid in Ericaceae in southeastern Brazil. *Plant Syst. Evol.* 258: 41–61.
- Fuhsung, W., Nanfen, C., Yulong, Z. and Huiqiu, Y. 1995. *Pollen Flora of China*. 2nd ed. Inst. Botany, Academia Sinica. 461 pp. + 205 plates. (in Chinese)
- Furness, C.A. and Rudall, P.J. 2004. Pollen aperture evolution – a crucial factor for eudicots success? *Trends Plant Sci.* 9: 154–158.
- Genier, G. 1966. Le pollen des Ericaceae dans les milieux Français. *Ann. Abeille* 9: 271–321. (in French)
- Gillespie, E., Bush, C. and Kron, K.A. 2006. Phylogeny of Ericoideae (Ericaceae) based on multiple nuclear and chloroplast genes. Abs., Botany 2006 - Looking to the Future, Conserving the Past.
<http://www.botanyconference.org/engine/search/index.php?func=detail&aid=611>
- Goetsch, L., Eckert, A.J. and Hall, B.D. 2005. The molecular systematics of *Rhododendron* (Ericaceae): A phylogeny based on *RPB2* gene sequences. *Syst. Bot.* 30: 616–626.
- Goldy, R.G., Munoz, C.E. and Lyrence, P.M. 1984. Pollen morphology of some *Vaccinium* species and their hybrids. *J. Amer. Soc. Hort. Sci.* 109: 237–244.
- Grayum, M.H. 1986. Correlation between pollination biology and pollen morphology in the Araceae, with some implications for angiosperm evolution. In Blackmore, S. and

- Ferguson, I.K. (eds.). Pollen and Spores: Form and Function, Acad. Press, London. 313–328 pp.
- Guinet, P. 1965. Remerques sur les pollens composés a parois intermer perforées. Pollen Spores 7: 13–18. (in French)
- Haber, E. 1984. A comparative study of *Pyrola minor* X *Pyrola asarifolia* (Ericaceae) and its parental species in North America. Can. J. Bot. 62: 1054–1061.
- Haber, E. and Takahashi, H. 1993. Taxonomic status of the East Asian *Pyrola faureana* (Ericaceae). J. Jpn. Bot. 68:8–22.
- Hara, H. 1966. Taxonomic comparison between corresponding taxa of spermatophyta in eastern Himalaya and Japan. In H. Hara (ed.), The Flora of Eastern Himalaya, Univ. Tokyo, Tokyo. 627–657 pp.
- Hayat, M.A. 1986. Basic techniques for transmission electron microscopy. Acad. Press, London.
- Hesse, M. 1979. Development and ultrastructure of pollenkitt and exine in closely related Entomo- and Anemophilous angiosperms: Salicaceae, Tiliaceae and Ericaceae. Flora 168: 540–557.
- Hesse, M. 1981. Pollenkitt and viscin threads: their role in cementing pollen grains. Grana 20: 145–152.
- Hesse, M. 1984. An exine architectural model for viscin threads. Grana 23: 69–75.
- Hesse, M. 1985. Hemispheric surface processes of exine and orbicules in *Calluna* (Ericaceae). Grana 24: 93–98.
- Hesse, M. 2000. Pollen wall stratification and pollination. Plant Syst. Evol. 222: 1–17.
- Hesse, M., Vogel, S. and Halbritter, H. 2000. Thread-forming structures in angiosperm anthers: their diverse role in pollination ecology. Plant Syst. Evol. 222: 281–292.
- Heusser, C.J. 1971. Pollen and Spores of Chile. Univ. Arizona Press, Tucson, Ariz. 167 pp.

- Hileman, L.C., Vasey, M.C. and Parker, V.S. 2001. Phylogeny and biogeography of the Arbutoideae (Ericaceae): Implementations for the Madrean-Tethyan hypothesis. *Sys. Bot.* 26: 131–143.
- Holmgren, P.K., Holmgren, N.H., and Barnett, L.C. (eds.). 1990. *Index Herbariorum, Part I: The Herbaria of the World*. 8th ed. New York Bot. Gard., Bronx. 704 pp.
- Hooker, J.D. 1876. Ericaceae. In Benthum, G. and Hooker, J.D. *Genera Plantarum*, 2, 2. Reeve & Co., London. 557–604 pp.
- Hörandl, E. 2006. Paraphyletic versus monophyletic taxa – evolutionary versus cladistic classification. *Taxon* 55: 564–570.
- Houston, T.F. and Ladd, P.G. 2002. Buzz pollination in Epacridaceae. *Aust. J. Bot.* 50: 83–91.
- Hsu, T.Z. 1982. Classification, distribution and phylogeny of the genus *Enkianthus*. *Acta Bot. Yunnanica* 4: 355–362. (in Chinese with English abstract)
- Huang, T.C. 1972. *Pollen Flora of Taiwan*. Nat. Taiwan Univ., Bot. Dept. Press. 297 pp.
- Hutchinson, J. 1973. *Evolution and Phylogeny of Flowering Plants*. 3rd ed. Clarendon Press, Oxford. 353–398 pp.
- Huynh, K.L. 1968. Etude de l'arrangement du pollen dans la tétrade chez les angiospermes sur la base de données cytologiques. *Bull. Soc. Bot. Suisse* 78: 151–179.
- Huynh, K.L. 1976. Arrangement of some moosulcate, disulcate, trisulcate, dicolpate, and tricolpate pollen types in the tetrads, and some aspect of evolution in the angiosperms. In Ferguson, I.K. and Muller, J. (eds.). *The evolutionary Significance of the exine*, Acad. Press, London. 101–124 pp.
- Ikuse, M. 1954. The presence of the viscin threads among the pollen grains in Phyllodoceae, etc. of Ericaceae. *J. Jap. Bot.* 29: 146–148.
- Ikuse, M. 1956. *Pollen grains of Japan*. Hirokawa Pub.Co., Tokyo. 115–121 pp. (in Japanese)
- Ikuse, M. 2001. *Pollen grains of Japan*, 2nd ed. Hirokawa Pub. Co., Tokyo. 259 pp. + 369 plates (in Japanese)

- Jacquemart, A.-L. 1997. Floral and pollination biology of the four European *Vaccinium* (Ericaceae) species in the Upper Ardennes, Belgium. *Acta Hort.* 437: 401–406.
- Janaki Ammal, E.K., Enoch, I.C. and Bridgwater, M. 1950. Chromosome numbers in species of *Rhododendron*. *The Rhododendron Yearbook*. Royal Hort. Soc. pp. 78–91.
- Javorek, S.K., Mackenzie, K.E. and Vander Kloet, S.P. 2002. Comparative pollination effectiveness among bees (Hymenoptera: Apoideae) on lowbush blueberry (Ericaceae: *Vaccinium angustifolium*). *Ann. Entomol. Soc. Am.* 95: 345–351.
- Jaynes, J.B. 1969. Chromosome counts of *Kalmia* species and reevaluation of *K. polifolia* var. *microphylla*. *Rhodora* 71: 280–284.
- Judd, W.S. 1982. A taxonomic revision of *Pieris* (Ericaceae). *J. Arnold Arb.* 63: 103–144.
- Judd, W.S. 1984. A taxonomic revision of the American species of *Agarista* (Ericaceae). *J. Arnold Arb.* 65: 255–342.
- Judd, W.S. 1995a. *Lyonia*. In Luteyn, J.L. (ed.), *Ericaceae – Part II: The superior-ovaryed genera*. *Fl. Neotrop. Monogr.* 66, New York Bot. Gard., Bronx. 222–294 pp.
- Judd, W.S. 1995b. *Agarista*. In Luteyn, J.L. (ed.), *Ericaceae – Part II: The superior-ovaryed genera*. *Fl. Neotrop. Monogr.* 66, New York Bot. Gard., Bronx. 295–344 pp.
- Judd, W.S. and Kron, K.A. 1993. Circumscription of Ericaceae (Ericales) as determined by preliminary cladistics analyses based on morphological, anatomical and embryological features. *Brittonia* 45: 99–114.
- Judd, W.S., Campbell, C.S., Kellogg, E.A., Stevens, P.F. and Donoghue, M.J. 2002. *Plant Systematics: A Phylogenetic Approach*. 2nd ed. Sinauer Assoc. Inc. Pub., Massachusetts. 431–433 pp.
- Kaplan, S.M. and Mulcahy, D.L. 1971. Mode of pollination and floral sexuality in *Thalictrum*. *Evolution* 25: 659–668.
- Kenrick, P. 1999. The family tree flowers. *Nature* 402: 358–359.

- Keri, C. and Zetter, R. 1992. Notes on the exine ultrastructure of Onagraceae and Rhododendroideae (Ericaceae). *Grana* 31: 119–123.
- Kim, K.H., Nilsson, S. and Pragłowski, J. 1988. A note on the pollen morphology of the Empetraceae. *Grana* 27: 283–290.
- Klotzsch, J.F. 1838. *Ericearum genera et species*. *Linnaea* 12: 211–247.
- Knudsen, J.T. and Olesen, J.M. 1993. Buzz-pollination and patterns in sexual traits in north European Pyrolaceae. *Am. J. Bot.* 80: 900–913.
- Kocoń, J., Pliszka, K. and Muszyński, S. 1981. Pollen grain surface in *Vaccinium myrtillus* as seen in scanning electron microscopy. *Acta Soc. Bot. Poloniae* 50: 583–584 (with 4 figures).
- Kron, K.A. 1996. Phylogenetic relationships of Empetraceae, Epacridaceae, Ericaceae, Monotropaceae, Pyrolaceae: Evidence from nuclear ribosomal 18s sequence data. *Ann. Bot.* 77: 293–303.
- Kron, K.A. 1997. Phylogenetic relationships of Rhododendroideae (Ericaceae). *Am. J. Bot.* 84: 973–980.
- Kron, K.A. and Chase, M. 1993. Systematics of the Ericaceae, Empetraceae, Epacridaceae and related taxa based upon *rbcL* sequence data. *Ann. Missouri Bot. Gard.* 80: 735–741.
- Kron, K.A. and Judd, W.S. 1990. Phylogenetic relationships within the Rhodoreae (Ericaceae) with specific comments on the placement of *Ledum*. *Syst. Bot.* 15: 57–68.
- Kron, K.A. and Judd, W.S. 1997. Systematics of the *Lyonia* group (Andromedeae, Ericaceae) and the use of species as terminals in higher-level cladistic analyses. *Syst. Bot.* 22: 479–492.
- Kron, K.A. and King, J.M. 1996. Cladistic relationships of *Kalmia*, *Leiophyllum* and *Loiseleuria* (Phyllodoceae, Ericaceae) based on *rbcL* and nrITS data. *Syst. Bot.* 21: 17–29.

- Kron, K.A. and Luteyn, J.L. 2005. Origin and biogeographic patterns in Ericaceae: New insight from recent phylogenetic analyses. In Friis, Ib. and Balslev, H. (eds.). Plant Diversity and Complexity Pattern – Local, Regional and Global Dimensions. Biol. Skrifter 55. The Roy. Aca. Sci. Lett., Copenhagen. 479–500 pp.
- Kron, K.A., Fuller, R., Crayn, D.M., Gadek, P.A. and Quinn, C.J. 1999. Phylogenetic relationships of epacrids and vaccinioids (Ericaceae s.l.) based on *matK* sequence data. Plant Syst. Evol. 218: 55–65.
- Kron, K.A., Judd, W.S., Stevens, P.F., Crayn, D.M., Anderberg, A.A., Gadek, P.A., Quinn, C.J. and Luteyn, J.L. 2002a. Phylogenetic classification of Ericaceae: molecular and morphological evidence. Bot. Rev. 68: 335–423.
- Kron, K.A., Powell, E.A. and Luteyn, J.L. 2002b. Phylogenetic relationships within the blueberry tribe (Vaccinieae, Ericaceae) based on sequence data from *matK* and nuclear ribosomal ITS regions, with comments on the placement of *Satyria*. Amer. J. Bot. 89: 327–336.
- Kurashige, Y., Etoh, J.I., Handa, T., Takayanagi, K. and Yukawa, T. 2001. Sectional relationships in the genus *Rhododendron* (Ericaceae): evidence from *matK* and *trnK* intron sequences. Plant Syst. Evol. 228: 1–14.
- Kurosawa, K. 1991. SEM Photographs of Pollen of Angiosperms. Osaka Museum of Natural History, Osaka. 189 pp. (in Japanese)
- Le Thomas, A., Morawetz, W. and Waha, M. 1986. Pollen of palaeo- and neotropical Annonaceae: definition of the aperture by morphological and functional characters. In Blackmore, S. and Ferguson, I.K. (eds.). Pollen and Spores: Form and Function, Acad. Press, London. 375–388 pp.
- Lens, F., Dressler, S., Vinckier, S., Jansen, S., Desein, S., Van Evelghem, L. and Smets, E. 2005. Palynological variation in Balsaminoid Ericales. I. Marcgraviaceae. Ann. Bot. 96: 1047–1060.

- Lens, F., Kron, K.A., Luteyn, J.L. Smets, E. and Jansen, S. 2004. Comparative wood anatomy of the blueberry tribe (Vaccinieae, Ericaceae s.l.). *Ann. Missouri Bot. Gard.* 91: 566–592.
- Lewis, W.H. 1964. *Oldenlandia corymbosa* (Rubiaceae). *Grana Palynol.* 5: 330–341.
- Lewis, W.H., Vinay, P. and Zenger, V.E. 1983. *Airborne and Allergenic Pollen of North America*. John Hopkins Uni. Press, London. 288 pp.
- Li, H.L., Lu, S.Y., Yang, Y.P. and Tseng, Y.H. 1998. Ericaceae. In Huang, T.C. (eds.), *Flora of Taiwan Vol. 4*, 2nd ed. Dept. Bot., Natl. Taiwan Univ., Taipei, Taiwan. 17–39 pp.
- Li, J., Alexander III, J., Ward, T., Tredici, P.D. and Nicholson, R. 2002. Phylogenetic relationships of Empetraceae inferred from sequences of chloroplast gene *matK* and nuclear ribosomal DNA ITS region. *Mol. Phylog. Evol.* 25: 306–315.
- Lieux, M.H. and Godfrey, W M. 1982. An atlas of pollen of trees, shrubs and woody vines of Louisiana and other southeastern states, part III. Polygonaceae to Ericaceae. *Pollen Spore* 24: 21–64.
- Linder, H.P. 2000. Pollen morphology and wind pollination in angiosperms. In Harley, M.M., Morton, C.M. and Blackmore, S. (eds.), *Pollen and Spore: Morphology and Biology*, Royal Botanical Garden, Kew.
- Luteyn, J.L. 1978. Notes on Neotropical Vaccinieae (Ericaceae). VI. New species from the Cordillera Vilcabamba and adjacent eastern Peru. *Brittonia* 30: 426–439.
- Luteyn, J.L. (ed.). 1995a. Ericaceae – Part II: The superior-ovariated genera. *Fl. Neotrop. Monogr.* 66, New York Bot. Gard., Bronx. 560 pp.
- Luteyn, J.L. 1995b. *Gaultheria*. In Luteyn, J.L. (ed.), Ericaceae – Part II: The superior-ovariated genera. *Fl. Neotrop. Monogr.* 66, New York Bot. Gard., Bronx. 384–488 pp.
- Luteyn, J.L. 1995c. *Ledothamnus*. In Luteyn, J.L. (ed.), Ericaceae – Part II: The superior-ovariated genera. *Fl. Neotrop. Monogr.* 66, New York Bot. Gard., Bronx. 107–122 pp.

- Luteyn, J.L. 2001. Two new species and two new combinations in Mesoamerican Ericaceae. *Brittonia* 53: 436–446.
- Luteyn, J.L. 2002a. Diversity, adaptation, and endemism in Neotropical Ericaceae: Biogeographical patterns in the Vaccinieae. *Bot. Rev.* 68: 55–87.
- Luteyn, J.L. 2002b. Neotropical Blueberries: The plant family Ericaceae. Available online from <http://www.nybg.org/bsci/res/lut2/>
- Lutz, R.W. and Sjolund, R.D. 1973. Development of the generative cell wall in *Monotropa uniflora* L. *Plant Physiol.* 52: 498–500.
- MacBride, J.F. 1944. *Vaccinium* and relatives in the Andes of Peru. Univ. Wyoming Publ. 11: 37–46.
- Maguire, B., Steyermark, J.A. and Luteyn, J.L. 1978. The botany of the Guayana highland – Part X. Ericaceae. *Mem. New York Bot. Gard.* 29: 139–203.
- Mahy, G., De Sloover, J. and Jacquemart, A.-L. 1998. The generalist pollination system and reproductive success of *Calluna vulgaris* in the upper Ardenne. *Can. J. Bot.* 76: 1842–1851.
- Mansfeld, R. and Sleumer, H. 1935. Revision der gattung *Befaria* Mutis. *Bot. Gart. Berlin-Dahlem* 12: 235–276.
- Martin, H.A. 1993. *Monotoca*-type (Epacridaceae) pollen in the late tertiary of Southern Australia. *Aus. J. Bot.* 41: 709–720.
- Mass, J.L. 1977. Pollen ultrastructure of Strawberry and other small-fruit crops. *J. Amer. Soc. Hort. Sci.* 102: 560–571.
- Mateus, J.E. 1989. Pollen morphology of Portuguese Ericales. *Rev. Biol. Lisboa.* 14: 135–208.
- Matthews, J.M. 1966. Some descriptions of the pollen morphology of *Epacris* Forst., Emnd. *Cav. Pollen Spores* 8: 461–478.

- McGlone, M.S. 1978a. Pollen wall structure of the New Zealand species of *Epacris* (Epacridaceae). *New Zealand J. Bot.* 16: 83–89.
- McGlone, M.S. 1978b. Pollen structure of the New Zealand members of the Styphelieae (Epacridaceae). *New Zealand J. Bot.* 16: 91–101.
- McGuire, A.F. and Kron, K.A. 2005. Phylogenetic relationships of European and African *Ericas*. *Int. J. Plant Sci.* 166: 311–318.
- Middleton, D.J. 1991. Infrageneric classification of the genus *Gaultheria* L. (Ericaceae). *Bot. J. Linn. Soc.* 106: 220–258.
- Milne, R.I. 2006. Northern hemisphere plant disjunctions: A window on tertiary land bridges and climate change? *Ann. Bot.* 98: 465–472.
- Moore, P.D. Webb, J.A. and Collinson, M.E. 1991. *Pollen Analysis*. 2nd ed. Blackwell Sci. Publ., London. 216 pp.
- Moriya, K. 1976. *Flora and Palynomorphs of Alaska*. Kodansha, Tokyo. 288–297 pp. + 124–136 plates. (in Japanese)
- Nair, P.K.K. 1965. *Pollen Grains of Western Himalayan Plants*. Asia Publ. House, Bombay. 102 pp.
- Nakamura, J. 1980. *Diagnostic Characters of Pollen Grains of Japan*. Vol. I and II. Osaka Museum of Natural History, Osaka. 91 pp. + 157 plates (in Japanese).
- Navarro, L. 2001. Reproductive biology and effect of nectar robbing on fruit production in *Macleania bullata* (Ericaceae). *Plant Ecol.* 152: 59–65.
- Nilsson, S. 1990. Taxonomic and evolutionary significance of pollen morphology in the Apocynaceae. In Hesse, M. and Ehrendofer, F. (eds.), *Morphology, Development, and Systematic Relevance of Pollen and Spores*. *Plant Syst. Evol. Suppl.* 5. Springer-Verlag, New York. 91–102 pp.
- Nilsson, S., Endress, M.E. and Grafström, E. 1993. On the relationship of the Apocynaceae and Periplocaceae. *Grana Suppl.* 2: 3–20.

- Nilsson, S., Praglowski, J. and Nilsson, S. 1977. Atlas of airborne pollen grains and spores in northern Europe. Örebro. 48–51 pp.
- Nixon, K.C. and Crepet, W.L. 1993. Late cretaceous fossil flowers of Ericalean affinity. *Am. J. Bot.* 80: 616–623.
- Nowicke, J.W. 1966. Pollen morphology and classification of the Pyrolaceae and Monotropaceae. *Ann. Missouri Bot. Gard.* 53: 213–219.
- Oldfield, F. 1959. The pollen morphology of some of the West European Ericales- Preliminary descriptions and a tentative key to their identification. *Pollen Spores* 1: 19–48.
- Oliver, E.G.H. 2000. Systematics of Ericaceae (Ericaceae: Ericoideae) - Species with Indehiscent and Partially Dehiscent Fruits. *Contrib. Bolus Herb.* 19, Univ. Cape Town, South Africa. 483 pp.
- Overbeck, V.F. 1934. Zur Kenntnis der pollen mittel- und nord-europäischer Ericales. *Beih. Bot. Centrbl.* 51: 566–583.
- Palibin, J.V. 1899. Revisio generis *Enkianthus* Lour. *Scripta Bot. Horti Univ. Imp. Petropolitanae* 15: 1–18.
- Palser, B.F. 1952. Studies in the floral morphology of the Ericales 2. Megasporogenesis and megagametophyte development in the Andromedeae. *Bot. Gaz.* 114: 33–52.
- Paquereau, M.M. 1959. Détermination générique et spécifique du pollen de quelques Éricacées. Extrait des P.-V. de la Société Linnéenne de Bordeaux 97: 1–7 (with two plates). (in French)
- Powell, E.A. and Kron, K.A. 2001. An analysis of the phylogenetic relationships in the wintergreen group (*Diplycosia*, *Gaultheria*, *Pernettya*, *Tepuia*; Ericaceae). *Syst. Bot.* 26: 808–817.

- Powell, E.A. and Kron, K.A. 2002. Hawaiian blueberries and their relatives – A phylogenetic analysis of *Vaccinium* sections *Macropelma*, *Myrtillus*, and *Hemimyrtillus* (Ericaceae). *Syst. Bot.* 27: 768–779.
- Powell, E.A. and Kron, K.A. 2003. Molecular systematics of the Northern Andean blueberries (Vaccinieae, Vaccinioideae, Ericaceae). *Int. J. Plant Sci.* 164: 987–995.
- Powell, J.M., Morrison, D.A., Gadek, P.A. Crayn, D.M. and Quinn, C.J. 1997. Relationships and generic concepts within Styphelieae (Epacridaceae). *Austral. Syst. Bot.* 10: 15–29.
- Pragłowski, J. 1979. Winteraceae. In Nilsson, S. (ed.). *World Pollen and Spore Flora* 8: 1–25. (with 10 figs.).
- Pragłowski, J. and Grafström, E. 1985. The genus *Carpodetus* (Escalloniaceae): a pollenmorphological enigma. *Grana* 24: 11–21.
- Pragłowski, J., Skvarla, J.J., Raven, P.H. and Nowicke, J.W. 1983. Oragraceae. In Nilsson, S. (ed.). *World Pollen and Spore Flora* 12: 1–41.
- Premathilake, R., Epitawatta, S. and Nilsson, S. 1999. Pollen morphology of some selected plant species from Horton plain, Sri Lanka. *Grana* 38: 289–295.
- Punt, W. 1975. Pollen morphology of the Dichapetalaceae with special references to the evolutionary trends and mutual relationships of pollen types. *Rev. Palaeobot. Palynol.* 19: 1–97.
- Punt, W., Blackmore, S., Nilsson, S. and Le Thomas, A. 1994. Glossary of pollen and spore terminology. LPP Contrib. Ser. 1, LPP Found., Utrecht.
- Quinn, C.J. Brown, E.A., Heslewood, M.M and Crayn, D.M. 2005. Generic concepts in Styphelieae (Ericaceae): the *Cyathodes* group. *Austral. Syst. Bot.* 18: 439–454.
- Raven, P.H. and Axelrod, D.I. 1974. Angiosperm biogeography and past continental movements. *Ann. Mo. Bot. Gard.* 61: 539–673.
- Rebelo, A.G., Siegfried, W.R. and Oliver, E.G.H. 1985. Pollination syndromes of *Erica* species in the south-western Cape. *South African J. Bot.* 51: 270–280.

- Reitsma, T. 1969. Size modification of recent pollen grains under different treatments. *Rev. Palaeo. Palynol.* 9: 175–202.
- Rendle, A.B. 1956. *The Classification of Flowering Plants. II. Dicotyledons.* Cambridge Uni. Press. 304–434 pp.
- Ressayre, A., Raquin, C., Mignot, A., Godele, B. and Gouyon, P.H. 2002. Correlated variation in microtubule distribution, callose deposition during male post-meiotic cytokinesis and pollen aperture number across *Nicotiana* species (Solanaceae). *Amer. J. Bot.* 89: 393–400.
- Ricardi, M. and Marticorena, C. 1961. Contribución a la diagnosis de *Gaultheria rengifoana* *Phill. Bull. Soc. Argentina Bot.* 9: 325–329. (in Spanish).
- Ridgway, J.E., 1970. Pollen germination in *Monotropa*. *Ann. Missouri Bot. Gard.* 57: 384–385.
- Rosatti, T.J. 1988. Pollen morphology of *Arctostaphylos uva-ursi* (Ericaceae) in North America. *Grana* 27: 115–121.
- Rowley, J.R. 2001. Why the endexine and the ectexine differ in resistance to oxidation. *Calluna* as a model system. *Grana* 40: 159–162.
- Samuelsson, G. 1913. Studien über die Entwicklungsgeschichte der Blüten einiger *Bicornes*-Typen. *Svensk Bot. Tidskr.* 7: 97–188.
- Sarwar, A.K.M. Golam and Takahashi, H. 2006a. Pollen morphology of *Pieris* D. Don (Lyoniaeae, Ericaceae) and its taxonomic significance. *J. Jpn. Bot.* 81: 225–234.
- Sarwar, A.K.M. Golam and Takahashi, H. 2006b. Pollen morphology of *Enkianthus* (Ericaceae) and its taxonomic significance. *Grana* 45: 161–174.
- Sarwar, A.K.M. Golam, Ito, T. and Takahashi, H. 2005. Pollenkitt ropes of *Notopora schomburgkii* Hook. f. (Ericaceae, Vaccinieae). *Jpn. J. Palynol.* 51: 65–68.

- Sarwar, A.K.M. Golam, Ito, T. and Takahashi, H. 2006a. An overview of pollen morphology and its relevance to the sectional classification of *Vaccinium* L. (Ericaceae). Jpn. J. Palynol. 52: 15–34.
- Sarwar, A.K.M. Golam, Ito, T. and Takahashi, H. 2006b. Pollen of *Ceratostema* Jussieu (Ericaceae, Vaccinieae): Tetrads without septa. J. Plant Res. 119: 685–689.
- Schols, P., Es, K., D’hondt, C., Merckx, V., Smets, E. and Huysmans, S. 2004. A new enzyme-based method for the treatment of fragile pollen grains collected from herbarium material. Taxon 53: 777–782.
- Schols, P., Furness, C.A. Wilkin, P., Smets, E., Cielen, V. and Huysmans, S. 2003. Pollen morphology of *Dioscorea* (Dioscoraceae) and its relation to systematics. Bot. J. Linn. Soc. 143: 375–390.
- Shimakura, M. 1973. Palynomorphs of Japanese Plant. Spec. Publ. Osaka Mus. Nat. Hist. 5: 1–60. (in Japanese)
- Simpson, M.G. 2005. Plant Systematics. Elsevier Acad. Press, Amsterdam. 590 pp.
- Skvarla, J.J., Raven, P.H., Chissoe, W.F. and Sharp, M. 1978. An ultrastructural study of viscin threads of Onagraceae pollen. Pollen Spores 20: 5–143.
- Sladkov, A.N. 1953. About morphological traits of pollen of Ericaceae. Proc. USSR Acad. Sci. 92: 1065–1068. (in Russian)
- Sladkov, A.N. 1954. Morphological description of the pollen of the Pyrolaceae, Monotropaceae, Ericaceae, Vacciniaceae and Empetraceae of the European part of USSR. Works Inst. Geo. USSR Acad. Sci. 61: 119–156. (in Russian)
- Sleumer, H. 1941. Vaccinioideen-Studien. Bot. Jahrb. 71: 375–510. (in German)
- Sleumer, H. 1967. Die Gattung *Gaylussacia* H.B.K. Bot. Jahrb. 86: 309–384. (in German)
- Smith, A. C. 1932. The American species of Thibaudieae. Cont. U.S. Nat. Herb. 28: 311–547.
- Smith-White, S. 1959. Pollen development patterns in the Epacridaceae. Proc. Linn. Soc. New South Wells. 84: 8–35. with two plates.

- Southall, R.M. and Hardin, J.W. 1974. A taxonomic revision of *Kalmia* (Ericaceae). J. Elisha Mitchell Sci. Soc. 90: 1–23.
- Stace, C.A. 2005. Plant taxonomy and biosystematics – does DNA provide all the answers? Taxon 54: 999–1007.
- Stanley, R.G. and Linskens, H.F. 1974. Pollen: Biology, Biochemistry, and Management. Springer-Verlag, Berlin. 307 pp.
- Stevens, P.F. 1969. Taxonomic studies in the Ericaceae. Unpub. PhD thesis, Univ. Edinburgh, UK. 678 pp.
- Stevens, P.F. 1971. A classification of the Ericaceae: subfamilies and tribes. Bot. J. Linn. Soc. 64: 1–53.
- Stevens, P.F. 1974. Circumscription and relationships in *Dimorphanthera* (Ericaceae) with notes on some Papuasian species. Contr. Herb. Austral. 8: 1–34.
- Stevens, P.F. 1985. Notes on *Vaccinium* and *Agapetes* (Ericaceae) in Southeast Asia. J. Arn. Arbor. 66: 471–490.
- Stevens, P.F. 1995. Familial and infrafamilial relationships. In: Luteyn, J.L. (ed.). Ericaceae Part II: the superior-ovary genera. Fl. Neotrop. Monogr. 66, New York Bot. Gard., Bronx. 1–10 pp.
- Stevens, P.F. 1997. What kind of classification should the practicing taxonomist use to be saved? In Dransfield, J., Coode, M.J.E. and Simpson, D.A. (eds.) Plant Diversity in Malesia III, Royal Botanic Gardens, Kew, London. 295–319 pp.
- Stevens, P.F. 2003. New taxa in *Paphia* and *Dimorphanthera* (Ericaceae) in Papuasias and the problem of generic limits of Vaccinieae. Edinburgh J. Bot. 60: 267–298.
- Stevens, P.F. 2004. Ericaceae. In Kubitzki, K. (eds.) The Families and Genera of Vascular Plants. 6, Springer, Berlin. 145–194 pp.
- Stevens, P.F. 2006. Angiosperm Phylogeny Website. Ver.7, <http://www.mobot.org/MOBOT/research/APweb/>.

- Stuessy, T.F. 1990. Plant Taxonomy. Columbia Univ. Press, New York.
- Takahashi, H. 1979. Pollen development in *Chimaphila japonica* Miq. (Pyrolaceae). Sci. Rep. Tohoku Uni. 4th Ser. Biol. 37: 263–272.
- Takahashi, H. 1986a. Pollen polyads and their variation in *Chimaphila* (Pyrolaceae). Grana 25: 161–169.
- Takahashi, H. 1986b. Pollen morphology of *Pyrola* and its taxonomic significance. Bot. Mag. Tokyo 99: 137–154.
- Takahashi, H. 1987a. Pollen morphology and its taxonomic significance of the Monotropeoideae (Ericaceae). Bot. Mag. Tokyo 100: 385–405.
- Takahashi, H. 1987b. Pollen morphology and development of *Orthilia secunda* (L.) House (Pyrolaceae). J. Fac. Agr. Hokkaido Univ. 63: 145–153. with 4 plates.
- Takahashi, H. 1988. Pollen morphology and systematics in two sub-families of Ericaceae: Pyroloideae and Monotropeoideae. Korean J. Plant Tax. 18: 9–17.
- Takahashi, H. and Sohma, M. 1980. Pollen development in *Pyrola japonica* Klenze. Sci. Rep. Tohoku Uni. 4th Ser. Biol. 38: 57–71.
- Takahashi, H. and Sohma, M. 1982. Pollen morphology of Droseraceae and its related taxa. Sci. Rep. Tohoku Uni. 4th Ser. Biol. 38: 81–156.
- Takhtajan, A. 1997. Diversity and Classification of Flowering Plants. Columbia Univ. Press. New York. 185–190 pp.
- Tanaka, N., Uehara, K. and Murata, J. 2004. Correlation between pollen morphology and pollination mechanisms in the Hydrocharitaceae. J. Plant Res. 117: 265–276.
- Tarnavschi, I.T. and Radulescu, D. 1960. Cercetari asupra morfologiei polenului speciilor ordinului Ericales din Flora R.P.R. St.Cerc. Bio., ser. Biol. Veg. Romin. 12: 165–175. (in Romanian)
- Terzioğlu, S., Merev, N. and Anşin, R. 2001. A study of Turkish *Rhododendron* L. (Ericaceae). Turkish J. Agric. For. 25: 311–317.

- Thanikaimoni, G. 1986. Pollen apertures: form and function. In Blackmore, S. and Ferguson, I.K. (eds.). *Pollen and Spores: Form and Function*, Acad. Press, London. 119–136 pp.
- Thorne, R.F. 1992. Classification and geography of flowering plants. *Bot. Rev.* 58: 225–348.
- Ueno, J. 1950. On *Enkianthus*: A classification of the genus *Enkianthus* based upon the characters of pollen grains and crystals in the leaf. *J. Inst. Polyt. Osaka City Univ. Ser. D*, 1, 55–62.
- Ueno, J. 1962. Palynological notes on Ericaceae and Pyrolaceae from Japan and its neighbours. *Acta Phytotaxo. Geobot.* 20: 101–111. (in Japanese with English abstract)
- Ueno, J. 1980. *Study of Palynology*. Kazama Shobo Pub. Co. Tokyo. 84–95 pp. (in Japanese)
- Vander Kloet, S.P., Baltzer, J.L., Appleby, J.H., Evans, R.C. and Stewart, D.T. 2004. A re-examination of the taxonomic boundaries of *Symphysia* (Ericaceae). *Taxon* 53: 91–98.
- Vasanthy, G. and Pocock, S.A.J. 1987. On the pollen tetrads of the south Indian Ericaceae, *Gaultheria*, *Rhododendron* and *Vaccinium* with special reference to *R. nilagiricum* Zenk. *Bull. Jard. Bot. Nat. Belg.* 57: 213–245.
- Venkata Rao, C. 1961. Pollen types in the Epacridaceae. *J. Indian Bot. Soc.* 40: 409–423.
- Visset, L. 1971. Les pollens D'Ericacées du Massif Armoricaïn microscope électronique a balayage. *Bull. Soc. Sci. Bretagne* 46: 193–198 (with 37 photographs). (in French)
- Visset, L. 1972. Complements pour la determination au microscope electronique a balayage des Ericacees du Massif Amoricain. *Bull. Soc. Sci. Nat. France* 70: 13–16. (in French)
- Visset, L. 1975. Etude au microscope électronique à balayage des pollens des espèces européennes du genre *Erica* L. *Bull. Sci. Bot. France* 122: 203–216. (in French)
- Visset, L. 1977. Les pollens D'Éricacées et la metallisaton par pulverization cathodique. *Bull. Soc. Sci. Nat. Quest de la France* 75: 35–40. (in French)
- Waha, M. 1984. Ultrastructure and function of pollen connecting threads in Ericaceae and other Angiosperm families. *Plant Syst. Evol.* 147: 189–203. (in German with English abstract)

- Walker, J.W. 1971. Pollen morphology, phytogeography, and phylogeny of the Annonaceae. *Contrib. Gray Herb. No. 202*: 3–130.
- Walker, J.W. 1976. The evolutionary significance of the exine in the pollen of primitive angiosperms. In Ferguson, I.K. and Muller, J. (eds.). *The evolutionary Significance of the exine*, Acad. Press, London. 251–308 pp.
- Walker, J.W. and Doyle, J.A. 1975. The bases of angiosperm phylogeny: Palynology. *Ann. Mo. Bot. Gard.* 62: 664–723.
- Walker, J.W. and Skvarla, J.J. 1975. Primitively columellaless pollen: A new concept in the evolutionary morphology of angiosperms. *Science* 187: 445–447.
- Wallace, G.D. 1975. Interrelationship of the subfamilies of Ericaceae and derivation of the Monotropeoideae. *Bot. Not.* 128: 286–298.
- Wang, H., Mill, R.R. and Blackmore, S. 2003. Pollen morphology and inter-generic evolutionary relationships in some Chinese species of *Pedicularis* (Scrophulariaceae). *Plant Syst. Evol.* 237: 1–17.
- Warner, B.G. and Chinnappa, C.C. 1986. Taxonomic implications and evolutionary trends in Canadian Ericales. *Can. J. Bot.* 64: 3113–3126.
- Watson, L., William, W.T. and Lance, G.N. 1967. A mix-data approach to Angiosperm taxonomy: the classification of Ericales. *Proc. Linn. Soc. London* 178: 25–35.
- Wei, Z. 2003. *Pollen Flora of Seed Plants*. Yunnan Sci. and Tech. Press, Yunnan. 161 pp. + 131 plates (in Chinese)
- Wells, P.V. 1992. Subgenera and sections of *Arctostaphylos*. *Four Seasons* 9: 64–69.
- Wodehouse, R.P. 1935. *Pollen grains. Their structure, identification and significance in science and medicine*. McGraw Hill, New York. 574 pp.
- Yamazaki, T. 1991. Morphological structure of the anther of *Tsusiophyllum tanakae* Maxim. *J. Jpn. Bot.* 66: 35–38.

- Yamazaki, T. 1993a. *Enkianthus*. In Iwatsuki, K., Yamazaki, Y., Boufford, D.E. and Ohba, H. (eds.), Flora of Japan. IIIa. Kodansha, Tokyo. pp. 45–47.
- Yamazaki, T. 1993b. *Rhododendron*. In Iwatsuki, K., Yamazaki, Y., Boufford, D.E. and Ohba, H. (eds.), Flora of Japan. IIIa. Kodansha, Tokyo. pp. 16–44.
- Yang, B.Y. 1952. Pollen grain morphology in the Ericaceae. Quar. J. Taiwan Mus. 5: 1–24.
(in Chinese)
- Zetter, R. and Hesse, M. 1996. The morphology of pollen tetrads and viscin threads in some tertiary, *Rhododendron*-like Ericaceae. Grana 35: 285–294.
- Zhang, X.P. and Anderberg, A.A. 2002. Pollen morphology in the ericoid clade of the order Ericales, with special emphasis on Cyrillaceae. Grana 41: 201–215.

Legends

Fig. 3-1. LM and SEM micrographs of *Enkianthus* pollen. A. *E. campanulatus* (Takahashi 511); B. *E. perulatus* (Takahashi 509); C. *E. chinensis* (Forest 30465); D. *E. perulatus* (Sarwar & Takahashi s.n.); E. *E. sikokianus* (Onooka 27245); F. *E. subsessilis* (Ohashi et al. 11824); G. *E. nudipes* (Onooka 27182); H. *E. deflexus* (Yamazaki 2537); I – J. *E. campanulatus* (Sukawa s.n. and Tatewaki et al. s.n., respectively), K. *E. chinensis* (Forest 30465); L. *E. deflexus* (Yamazaki 2537); M – O. *E. campanulatus* (M. Sukawa s.n., N – O. Takahashi 511). Pollen grains at equatorial view (A – D, H, I); syncolpate pollen at polar view (J); micrographs with mesocolpial exine sculpture details (K – O).

Fig. 3-2. SEM micrographs of *Enkianthus* pollen. A. *E. campanulatus* var. *longilobus* (Tashiro s.n.); B. *E. campanulatus* var. *palbinii* (Tatewaki s.n.); C. *E. cernuus* (Takahashi 1827); D – F. *E. cernuus* f. *rubens* (D – E. Tohyama s.n., F. Matsuda s.n.); G – H. *E. sikokianus* (Onooka 27206 and Onooka 27245, respectively); I – J. *E. nudipes* (Onooka 27182 and Nakajima s.n., respectively); K – L. *E. subsessilis* (Tohyama s.n. and Ohashi et al. 11824, respectively); M. *E. perulatus* (Sarwar & Takahashi s.n.); N. *E. quinqueflorus* (McClure s.n.); O. *E. serotinus* (Togashi & Murata 8032). Micrographs with mesocolpial exine sculpture details (K – O).

Fig. 3-3. TEM micrographs of *Enkianthus* pollen. A – C. *E. campanulatus*; D – F. *E. perulatus*. Whole tetrad (A); mesocolpial exine showing tectum, columellae, unevenly thick foot layer and relatively thick endexine (B); in aperture region ectexine lacking, consists thick endexine and intine (C); whole tetrad showing numerous lipid and starch globules in the cytoplasm, pollenkitt observed around the tectum (D); mesocolpial exine showing tectum, columellae, thick foot layer and thin to indistinguishable endexine (E); in aperture region sexine lacking, consists thick nexine and intine, aperture covered with thin pollenkitt (F).

Legends

Fig. 3-6. LM and SEM pollen micrographs. A. *Arbutus menzeisii* (Grant s.n.); B. *A. canariensis* (E. & R. Wahlstrom s.n.); C. *A. menzeisii* (Grant s.n.); D. *A. andrachne* (Segelberg s.n.); E – F. *A. canariensis* (E. & R. Wahlstrom s.n.); G – H. *A. menzeisii* (Grant s.n.); I – J. *A. texana* (Sorensen et al. 7310E); K. *Arctostaphylos glauca* (Skottsberg s.n.); L. *A. viscida* (Rose 60006); M. *A. andersonii* (Rose 47029); N. *A. auriculata* (Rose 49004); O. *A. crustacea* (Rose 42007). Pollen tetrads at polar view (A – C, K – L); micrographs with apocolpial exine sculpture details (D, E, G, I, M – O); micrographs with mesocolpial exine sculpture details (F, H, J).

Fig. 3-7. SEM and TEM micrographs of *Arctostaphylos* pollen. A. *A. crustacea* (Rose 42007); B. *A. glauca* (Skottsberg s.n.); C – D. *A. bakeri* (Rose 55031); E. *A. densiflora* (Rose 55005); F – G. *A. nevadensis* (Allen 110); H – I. *A. viscida* (Rose 60006); J – L. *A. nummularia* (J. Rose s.n., K – L. Rose 61009); M – O. *A. andersonii* (Rose 47029). Micrographs with apocolpial exine sculpture details (B, C, E – F, H, J – K); micrographs with mesocolpial exine sculpture details (A, D, G, I, L); whole tetrad showing relatively thicker endexine and intine near aperture area (M); apocolpial exine showing tectum, columellae and relatively thicker foot layer (N); septum consisting of reduced tectum, foot layer of two adjacent grains connected by columellae, perforated, showing an intine connection between two adjacent grains (O).

Fig. 3-8. LM, SEM and TEM micrographs of *Comarostaphylis* pollen. A. *C. glaucescens* (Pringle 13762); B – D. *C. discolor* ssp. *discolor* (Pringle 6815); E – I. *C. glaucescens* (Pringle 13762). Pollen tetrads at polar view (A – B); micrographs with apocolpial exine sculpture details (C, E); micrographs with mesocolpial exine sculpture details (D, F); whole tetrad showing endcracks (G); apocolpial exine showing tectum, columellae, foot layer and thick endexine with (endo)cracks (H); perforated septum showing an cytoplasmic connection between two adjacent grains (I).

Legends

Fig. 3-9. LM, SEM and TEM pollen micrographs. A. *Bejaria aestuans* (Lutyen et al. 5296); B. *B. subsessilis* (Lójtant & Molau 15010); C – D. *B. aestuans* (Lutyen et al. 5296); E – F. *B. resinosa* (Sneidern 1069); G. *B. subsessilis* (Lójtant & Molau 15010); H – I. *B. racemosa* (Moldenke 601); J – L. *B. subsessilis* (Lójtant & Molau 15010); M – O. *Bryanthus gmelinii* (Takahashi et al. 2881). Pollen tetrads at polar view (A – B, M – N); pollen tetrad with viscin threads (B); micrographs with apocolpial exine sculpture details (C, E, H, O); micrographs with mesocolpial exine sculpture details (D, F, I); whole tetrad (J); apocolpial exine showing tectum with fine gemmae-pila, columellae, foot layer and thick endexine with (endo)cracks (K); in septum, tectum lacking, foot layer of two adjacent grains connected by columellae, endexine thick with (endo)cracks (L).

Fig. 3-10. LM and SEM pollen micrographs. A – B. *Corema conradii* (Jurr s.n.); C. *Empetrum nigrum* (Takahashi 18549); D. *Ceratiola ericoides* (Howard 8050); E – F. *C. conradii* (Jurr s.n.); G – H. *Calluna vulgaris* (Takahashi 10013); I – O. *Daboecia cantabrica* (I – M. Halliday 123/70, N – O. Nilsson & Degelius s.n.). Pollen tetrads at polar view (A – C, G, I – J); pollen grain at equatorial view (K); micrographs with apocolpial exine sculpture details (D – E, H, L, N); micrographs with mesocolpial exine sculpture details (F, M, O).

Fig. 3-11. LM and SEM micrographs of *Erica* pollen. A. *E. arborea* (Westphal & Westphal-Stevens 1657); B. *E. xeranthemifolia* (Goldblatt 2627); C. *E. bokkeveldia* (Oliver 4010); D. *E. puberuliflora* (Sidey 1842); E. *E. arborea* (Westphal & Westphal-Stevens 1657); F. *E. barbigera* (Sidey 1853); G – H. *E. curvistyla* (Oliver 4072); I. *E. arborea* (Westphal & Westphal-Stevens 1657); J. *E. axillaries* (Bulus 48); K. *E. cinerea* (Bot. Inv. 1104); L. *E. dumosa* (Stokoe 67017); M. *E. multiflora* (Costa & Valdés-Bermejo 2827EV); N. *E. tetralix* (Jacobsen & Svendsen 137); O. *E. trimera* ssp. *keniensis* (Hedberg 1829). Pollen tetrads at polar view (A, D – F); pollen grain at equatorial view (B – C, G – H); micrographs with apocolpial exine sculpture details (I – O).

Fig. 3-12. SEM and TEM micrographs of *Erica* pollen. A. *E. barbiger*a (Sidey 1853); B. *E. curvistyla* (Oliver 4072); C. *E. globiceps* ssp. *consors* (Orchard 546); D. *E. plumose* (Oliver 4305); E. *E. recurvifolia* (Esterhuysen 35333); F. *E. labilis* (Goldblatt 1622); G. *E. spiculifolia* (Cyrèn s.n.); H. *E. uberiflora* (Dahstrand 1683); I. *E. xeranthofolia* (Goldblatt 2627); J – L. *E. trimera* ssp. *keniensis* (Hedberg 1829). Micrographs with apocolpial exine sculpture details (A – I); whole tetrad (J); apocolpial exine showing tectum with moderate gemmae-pila, and thick foot layer with (endo)cracks, endexine very thin or indistinguishable (K); septum consisting of reduced and/or fragmentary tectum, thin columellae, thick foot layer and endexine with (endo)cracks (L).

Fig. 3-13. TEM micrographs of *Erica* pollen. A – C. *E. multiflora* (Costa & Valdès-Bermejo 2827 EV); D – F. *E. barbiger*a (Sidey 1853); G – I. *E. recurvifolia* (Esterhuysen 35333). Whole tetrad (A); apocolpial exine showing tectum, columellae, foot layer and thick endexine with (endo)cracks (B); septum consisting of reduced and/or fragmentary tectum, short columellae, thick foot layer and endexine with (endo)cracks (C); monad pollen (D, G); mesocolpial exine showing canalized tectum, granular columellae, foot layer variable in thickness and endexine (E, H – I); aperture characterized by lacking of exine, thick intine with many cytoplasmic canals (F).

Fig. 3-14. LM and SEM pollen micrographs. A – B. *Elliottia paniculata* (Takahashi 7802); C. *E. bracteata* (Takahashi 4500); D – E. *E. paniculata* (Takahashi 7802); F – G. *Epigaea repens* (Clausen 19207); H. *E. asiatica* (Hara 5212); I – J. *E. repens* (Clausen 19207); K. *Kalmia angustifolia* (DeSimon 415); L. *K. buxifolia* (Godfrey & White 7110); M – O. *K. ericoides* var. *aggregate* (Ekman 18165). Pollen tetrads at polar view (A – B, F – G, K – N); tetrad with viscin threads (B, G); micrographs with apocolpial exine sculpture details (C – D, H – I); micrographs with mesocolpial exine sculpture details (E, J); pollen tetrad with viscin threads at equatorial view (O).

Fig. 3-15. LM, SEM and TEM pollen micrographs. A. *Kalmia angustifolia* (DeSimon 415); B. *K. buxifolia* (Godfrey & White 7110); C – D. *K. ericoides* var. *aggregata* (Ekman 18165); E. *K. latifolia* (Feldman 63); F. *K. polifolia* (Allen s.n.); G. *K. procumbens* (Takahashi et al. 2644); H. *Phyllodoce caerulea* (Takahashi 4569); I. *P. aleutica* (Takahashi et al. 3666); J – L. *K. latifolia* (Feldman 63); M. *P. aleutica* (Takahashi et al. 3666); N. *P. caerulea* (Takahashi 4569); O. *P. nipponica* var. *oblonga* (Takahashi 4568). Micrographs with apocolpial exine sculpture details (A – C, E – G, M – O); micrographs with mesocolpial exine sculpture details (D); pollen tetrads at polar view (H – I); whole tetrad (J); apocolpial exine showing tectum with base of a viscin thread, columellae, foot layer and thick endexine with (endo)cracks (K); in septum, tectum lacking, two foot layer of adjacent grains connected by short or rudimentary columellae (L).

Fig. 3-16. LM, SEM and TEM pollen micrographs. A. *Phyllodoce nipponica* var. *oblonga* (Takahashi 4568); B – D. *Rhodothamnus chamaecistus* (Segelberg s.n.); E. *Menziesia pentandra* (Takahashi 2687); F. *M. multiflora* (Takahashi 767); G – H. *M. cilicalyx* (Tateishi & Hoshi 13689); I. *M. multiflora* (Takahashi 767); J. *M. pentandra* (Takahashi 2687); K. *Rhododendron formosnum* (Murata 17561); L. *R. maddenii* (Kanai et al. 346?); M – O. *Menziesia pentandra* (Takahashi 2687). Micrographs with mesocolpial exine sculpture details (A); pollen tetrads at polar view (B – C, F – F, K – L); 4-aperturate tetrad (C); micrographs with apocolpial exine sculpture details (D, G, I – J); whole tetrad (M); apocolpial exine showing tectum with narrow straight-edged striae, columellae, foot layer and thin undulated endexine (N); septum with tectum, and well defined columellae and foot layer of two adjacent grains (O).

Fig. 3-17. LM and SEM micrographs of *Rhododendron* pollen. A. *R. tsusiophyllum* (Sawada s.n.); B. *R. aureum* (Takahashi 2512); C. *R. kaempferi* (Iketsu et al. 95); D. *R. dilatatum* (Togashi s.n.); E. *R. hidakanum* (Tateishi & Togashi s.n.); F. *R. indicum* (Miyabe s.n.); G. *R. japonicum* (Takahashi 3998); H. *R. kaempferi* (Iketsu et al. 95); I. *R. macrosepalum* (Takahashi 1033); J. *R. nudipes* var. *niphonphyllum* (Murata 10910); K. *R. semibarbatum* (Murata 7987); L. *R. trinerve* (Togashi s.n.); M. *R. tsusiophyllum* (Sawada s.n.); N. *R. wadanum* (Takahashi 550); O. *R. weyrichii* (Shimamura et al. s.n.). Pollen tetrads at polar view (A – B); tetrads with viscin threads (B – C); pollen tetrads at equatorial view (C); micrographs with apocolpial exine sculpture details (D – O).

Fig. 3-18. SEM micrographs of *Rhododendron* pollen. A. *R. albrechtii* (Takahashi 3975); B. *R. quinquefolium* (Ogura 1637); C. *R. schlippenbachii* (Sarwar & Takahashi s.n.); D. *R. aureum* (Takahashi 2512); E. *R. brachycarpum* (Takahashi et al. 40); F. *R. decorum* (Smith 2016); G. *R. degronianum* (Iketani 1763); H. *R. formosanum* (Murata 17561); I. *R. macrostemon* (Togashi 688); J. *R. viscistylum* var. *amakusaense* (Minamidani 29613); K. *R. arborescens* (Unknown s.n.); L. *R. lapponicum* (Gillett 1835); M. *R. parvifolium* (Tatewaki 20940); N. *R. dauricum* (Kanayama et al. 04-9050); O. *R. mucronulatum* var. *ciliatum* (Yokoyama 299). Micrographs with apocolpial exine sculpture details (A – O); base of viscin threads attached with apocolpial exine (tectum) (C).

Fig. 3-19. SEM and TEM micrographs of *Rhododendron* pollen. A. *R. davidsoniaum* (C. 9180); B – C. *R. kieskie* (Murata et al. 17861); D. *R. diversipilosum* (Takahashi 206); E – F. *R. subarcticum* (Takahashi 2643); G – I. *R. japonicum* (Takahashi 3998); J – L. *R. tsusiophyllum* (Sawada s.n.). Micrographs with apocolpial exine sculpture details (A, B, D); micrographs with mesocolpial exine sculpture details (C, F); whole tetrad (G, J); apocolpial exine showing canalized tectum with fine gemmae-pila, columellae, foot layer and thin endexine (H); in septum, tectum lacking, two foot layer of adjacent grains connected by short or rudimentary columellae, endexine thick (I, L); apocolpial exine showing tectum, columellae, foot layer and thick endexine with (endo)cracks (K).

Fig. 3-20. LM, SEM and TEM pollen micrographs. A – C. *Rhododendron schlippenbachii* (Sarwar & Takahashi s.n.); D – E. *Therorhodion camtschaticum* (Takahashi et al. 5836); F. *T. redowskianum* (Yoshimura & Hara s.n.); G. *T. camtschaticum* (Takahashi et al. 5836); H – I. *T. redowskianum* (Yoshimura & Hara s.n.). Whole tetrads showing tectum with fine gemmae-pila, columellae, foot layer and thin endexine (A); apocolpial exine showing tectum with fine gemmae-pila, columellae, foot layer and thin endexine (B); in septum, tectum fragmentary, two foot layer of adjacent grains sometimes connected by columellae, endexine thick (C); pollen tetrads at polar view (D – E); pollen tetrads at equatorial view (F); micrographs with apocolpial exine sculpture details (G – H); micrographs with mesocolpial exine sculpture details (I).

Legends

Fig. 3-21. LM, SEM and TEM micrographs of *Cassiope* pollen. A. *C. fastigiata* (Ludlow et al. 20708); B. *C. mertensiana* (Calder & Savile 10837); C. *C. lycopodiodes* (Takahashi et al. 7185); D. *C. fastigiata* (Ludlow et al. 20708); E. *C. lycopodiodes* (Takahashi et al. 7185); F. *C. mertensiana* (Calder & Savile 10837); G – I. *C. lycopodiodes* (Takahashi et al. 7185). Pollen tetrads at polar view (A – B); pollen tetrads at equatorial view (C); micrographs with apocolpial exine sculpture details (D – F); whole tetrads showing thick intine layer near aperture region (G); apocolpial exine showing tectum with striae, columellae, foot layer and thick endexine with (endo)cracks (H); in septum, tectum fragmentary, two foot layer of adjacent grains sometimes connected by columellae, endexine and thick intine (I).

Legends

Fig. 3-22. LM, SEM and TEM micrographs of *Harrimanella* pollen. A – J. *H. stelleriana* (Takahashi 2513). Pollen tetrads at polar view (A – B); pollen tetrads at equatorial view (C); micrographs with apocolpial exine sculpture details (D – E); micrographs with mescolpial exine sculpture details (F); whole tetrads (G); apocolpial exine showing tectum, columellae, thick foot layer with (endo)cracks and endexine indistinguishable (H); septum faintly perforated, tectum fragmentary, two foot layer of adjacent grains sometimes connected by columellae, very thin or indistinguishable endexine and thick intine (I); aperture region characterized by thick foot layer, thin endexine and thick intine (J).

Legends

Fig. 3-23. LM, SEM and TEM pollen micrographs. A – I. *Andromeda polifolia* (A – B, D, G – I, Takahashi 9889; C, E – F, Takahashi & Fujita 9753); J – L. *Zenobia pulverulenta* (Britt 3109). Pollen tetrads at polar view (A – B); 4-aperturate pollen tetrads at equatorial view (C); micrographs with apocolpial exine sculpture details (D – E, K); micrographs with mesocolpial exine sculpture details (F, L); whole tetrads (G); apocolpial exine showing tectum, short columellae, foot layer and thick endexine (H); septum perforated showing an intine connection between two adjacent grains, consists reduced tectum, two foot layer of adjacent grains connected by columellae, very thin or indistinguishable endexine and thick intine (I).

Fig. 3-24. LM and SEM pollen micrographs. A – D. *Chamaedaphne calyculata* (Takahashi & Fujita 9755); E – H. *Diplycosia heterophylla* (Kjellberg s.n.); I. *Gaultheria adenothrix* (Takahashi et al. 7574); J. *G. prostrata* (Webster et al. 11395); K. *G. erecta* (Pringle 8896); L. *G. itatiaiae* (Hatschbach 1756); M. *G. adenothrix* (Takahashi et al. 7574); N. *G. miqueliana* (Endo et al. 2505); O. *G. prostrata* (Webster et al. 11395). Pollen tetrads at polar view (A – B, E, I, K – L); pollen tetrads at equatorial view (C, F, J); micrographs with apocolpial exine sculpture details (D, G, M – O); micrographs with mesocolpial exine sculpture details (H).

Fig. 3-25. SEM micrographs of *Gaultheria* pollen. A – B. *G. bracteata* (Asplund 13613); C. *G. erecta* (Pringle 8896); D. *G. rigida* (Meyer 9490); E. *G. shallon* (Hammond 264); F. *G. eriophylla* var. *eriophylla* (Dusén 57); G. *G. tomentosa* (Harling et al. 14981); H. *G. procumbens* (Miyabe s.n.); I. *G. anastomosans* (Killip & Smith 17683); J. *G. buxifolia* (Alston 7959); K. *G. foliolosa* (Harling & Andersson 23657); L. *G. itatiaiae* (Hatschbach 1756); M. *G. myrtilloides* var. *myrtilloides* (de Barba 1639); N – O. *G. insane* (Valentin n.s.). Micrographs with apocolpial exine sculpture details (A, C – N); micrographs with mesocolpial exine sculpture details (B, O).

Fig. 3-26. TEM micrographs of *Gaultheria* pollen. A – C. *G. itatiaiae* (Hatschbach 1756); D – F. *G. insane* (Valentin n.s.); G – I. *G. rigida* (Meyer 9490). Whole isodynamosporus tetrads (A, D, G); whole heterodynamosporus tetrads (B); apocolpial exine showing tectum, columellae, thick foot layer and thin endexine (C, E, H); septum consists reduced tectum, two foot layer of adjacent grains connected by columellae, very thin or indistinguishable endexine and thick intine (F, I).

Fig. 3-27. LM and SEM pollen micrographs. A – D. *Leucothoë grayana* var. *oblongifolia* (Takahashi 165); E – F. *L. keiskei* (Ohwi s.n.); G – I. *Tepuia venusta* (Luteyn & Steyermark 9578); J – L. *Agarista chlorantha* (Hatschbach & Guimaraes 24777); M. *A. coriifolia* var. *coriifolia* (Macedo 3757); N – O. *A. eucalyptoides* (Dusen 2011 and Hatschbach 44720, respectively). Pollen tetrads at polar view (A – C, G, J); pollen tetrads at equatorial view (K); micrographs with apocolpial exine sculpture details (D – E, H, L – O); micrographs with mesocolpial exine sculpture details (F, I).

Fig. 3-28. LM and SEM pollen micrographs. A. *Agarista populifolia* (Biltmore Herbarium 2656a); B – C. *A. salicifolia* (Dorr & Barnett 3156); D – G. *Craibiodendron yunnanense* (Forrest 8218); H – I. *Lyonia buchii* (Ekman 3236); J. *L. lingustriana* (DeSimone 420); K. *L. buchii* (Ekman 3236); L. *L. ferruginea* (Faxon s.n.); M – N. *L. lucida* (Ekman 12150); O. *L. ovalifolia* var. *elliptica* (Takahashi 1887). Micrographs with apocolpial exine sculpture details (A – B, F, J – K, M, O); micrographs with mesocolpial exine sculpture details (C, G, L, N); pollen tetrads at polar view (D – E, H – I).

Fig. 3-29. LM, SEM and TEM pollen micrographs. A – C. *Lyonia buchii* (Ekman 3236); D. *Pieris cubensis* (Ekman 16387); E. *P. koidzumiana* (Sonohara 10); F. *P. formosa* (McLaren 32F); G – I, *P. nana* (G – H. Fukuda 180, I. Takahashi et al. 2571); J – K. *P. floribunda* (Boufford & Wood 21058 and Unknown s.n., respectively); L. *P. formosa* (McLaren 32F). Whole tetrad (A); apocolpial exine showing thick tectum, very short columellae, thick foot layer and thin endexine with traces of (endo)cracks (B); in septum, tectum reduced or lacking, two foot layer of adjacent grains connected by columellae, thin endexine and thick intine (C); pollen tetrads at polar view (D – E); pollen tetrads at equatorial view (F); micrographs with apocolpial exine sculpture details (G, I – L); micrographs with mesocolpial exine sculpture details (H).

Fig. 3-30. LM, SEM and TEM pollen micrographs. A. *Pieris japonicum* (A. Takahashi 457, B – C. Sasao s.n.); D – E. *P. koidzumiana* (Sonohara 10); F. *P. cubensis* (Ekman 16387); G. *P. phillyreifolia* (Newcombe 267). H – L. *Oxydendrum arboreum* (Small & Heller 113). Micrographs with apocolpial exine sculpture details (A – B, D, F – G); micrographs with mesocolpial exine sculpture details (C, E); pollen tetrads at polar view (H); pollen tetrads at equatorial view (I); whole tetrad (J); apocolpial exine showing relatively thin and canalized tectum, columellae, thick foot layer and thin endexine (K); in septum, tectum reduced and fragmentary, two foot layer of adjacent grains sometimes connected by columellae, thin endexine and thick intine (L).

Fig. 3-31. LM and SEM pollen micrographs. A – E. *Agapetes bracteata* (Hanseen et al. 11367); F. *A. lobbii* (Hennipman 3557); G – H. *A. oblonga* (Malaise s.n.); I. *Cavendishia adenophora* (Ericsson & Kundsén 95); J. *C. divaricata* (Sneidern 268); K – L. *C. adenophora* (Ericsson & Kundsén 95); M – N. *C. capitulata* (Skutch 3790); O. *C. divaricata* (Sneidern 268). Pollen tetrads at polar view (A – B, I – J); pollen tetrads at equatorial view (C); micrographs with apocolpial exine sculpture details (D, F – G, K – M, O); micrographs with mesocolpial exine sculpture details (E, H, N).

Fig. 3-32. SEM and TEM micrographs of *Cavendishia* pollen. A – B. *C. isernii* var. *pseudospicata* (Lugo 1163); C. *C. marginata* (Sleider 938); D – E. *C. pubescens* (Sleider 3317); F. *C. tarapotana* var. *gilgiana* (Melin 221); G – I. *C. capitulata* (Skutch 3790); J – L. *C. marginata* (Sleider 938). Micrographs with apocolpial exine sculpture details (A – D, F); micrographs with mesocolpial exine sculpture details (E); whole tetrad in rhomboidal or tetrahedral arrangement, septum sometimes undulated (G, J); apocolpial exine showing relatively thin tectum, columellae, thick foot layer, and indistinguishable or thin endexine (H, K); in septum, tectum reduced and lacking, two foot layer of adjacent grains connected by columellae, thin endexine and intine (I, L).

Fig. 3-33. LM, SEM and TEM micrographs of *Ceratostema* pollen. A – E. *C. lanigerum* (Asplund 18937); F. *C. loranthiflorum* (Sparre 16627); G. *C. lanigerum* (Asplund 18937); H – K. *C. loranthiflorum* (Sparre 16627). Pollen tetrads at polar view (A – B); tetrad without septa (A); pollen tetrads at equatorial view (C); micrographs with apocolpial exine sculpture details (D, F); micrographs with mesocolpial exine sculpture details (E); whole tetrad showing aborted and convoluted septum (G, H); apocolpial exine structure with aborted and convoluted septum, consists tectum, columellae, foot layer and endexine, intine thick near the vestigial septal exine (I – K).

Fig. 3-34. LM and SEM pollen micrographs. A – C. *Costera endertii* (Argent 801197P10); D – E. *Demostenesia mandonii* (Britton & Rusby 1939); F – G. *D. weberbaueri* (Luteyn 6349); H – J. *Dimorphanthera collinsii* var. *montis-wilhelmi* (Vink 16003); K. *D. leucostoma* (Balgooy 403); L. *D. microphylla* (Balgooy 315); M. *Diogenesia floribunda* (Luteyn & Lebron-Lutyen 5675); N. *Disterigma acuminatum* (Hamilton & Holligan 1120); O. *D. humboldtii* (Skutch 3245). Pollen tetrads at polar view (A, D, H, M – O); micrographs with apocolpial exine sculpture details (B, E – G, I, K – L); micrographs showing narrow aperture with very large granules (C); micrographs with mesocolpial exine sculpture details (J).

Fig. 3-35. LM and SEM pollen micrographs. A – B. *Disterigma empetrifolium* (Schneider 861); C. *D. acuminatum* (Hamilton & Holligan 1120); D. *D. alaternoides* (Sneidern 2501); E – F. *D. empetrifolium* (Schneider 861); G. *D. humboldtii* (Skutch 3245); H – I. *D. popenoei* (Lojtnant et al. 11985); J. *Gaylussacia amoena* (Dusen s.n.); K. *G. dumosa* (Unknown s.n.); L. *G. baccata* (Rogers & Mullens 67033); M. *G. amoena* (Dusen s.n.); N. *G. brasiliensis* (Rambo 50350); O. *G. dumosa* (Unknown s.n.). Four aperturate pollen tetrads at polar view (A); 4-aperturate pollen tetrads at equatorial view (B); micrographs with apocolpial exine sculpture details (C – E, G – I, L – O); micrographs with mesocolpial exine sculpture details (F); pollen tetrads at polar view (J – K).

Fig. 3-36. LM, SEM and TEM pollen micrographs. A. *Gaylussacia reticulata* (Irwin et al. 20939); B – C. *G. virgata* var. *virgata* (Hatschbach 27485); E – O. *Gonocalyx smilacifolius* (Chambers 2606). Micrographs with apocolpial exine sculpture details (A – B, L); micrographs with mesocolpial exine sculpture details (C); heterodynamosporus tetrads at equatorial view (D – G, I – J); heterodynamosporus tetrads at polar view (H, K); whole heterodynamosporus tetrads (M – N); apocolpial exine showing tectum, columellae, foot layer and thick endexine with (endo)crack (O).

Fig. 3-37. LM, SEM and TEM pollen micrographs. A. *Macleania bullata* (Plowman & Davis 4437); B. *M. farinosa* (Harling & Anderson 21448); C. *M. rupestris* (Alston 8112); D. *M. bullata* (Plowman & Davis 4437); E. *M. crassa* (Sneidern 1655); F. *M. farinosa* (Harling & Anderson 21448); G. *M. portmanii* (Lutyen et al. 6540); H. *M. rupestris* (Alston 8112); I. *M. stricta* (Sneidern A565); J – O. *Notopora schomburgkii* (Lutyen et al. 6286). Pollen tetrads at polar view (A, C, J); heterodynamosporus pollen tetrads at equatorial view (B); micrographs with apocolpial exine sculpture details (D – I, L); pollenkitt rope (K); whole tetrad (M); apocolpial exine showing tectum, columellae, foot layer and endexine, thick pollenkitt layer on tectum (N); pollenkitt rope (O).

Fig. 3-38. LM, SEM and TEM pollen micrographs. A – B. *Orthaea abbreviata* (Harling & Anderson 21371); C. *O. secundiflora* (Lutyen & Cotton 11302); D – F. *O. abbreviata* (Harling & Anderson 21371); G. *Pellegrinia harmisiana* (Asplund 13074); H. *Plutarchia rigida* (Sneidern 1867); I – K. *P. guascensis* (Haught 6228); L. *P. rigida* (Sneidern 1867). Pollen tetrads at polar view (A, G – I); micrographs with apocolpial exine sculpture details (B – C, J – L); whole tetrad (D); apocolpial exine showing tectum, columellae, foot layer and endexine (E); septum with faint perforation, tectum reduced, two foot layer of adjacent grains connected by columellae, thin endexine and intine (F); micrographs with mesocolpial exine sculpture details (K).

Fig. 3-39. LM and SEM pollen micrographs. A. *Psammisia ecuadorensis* (Sparre. 17009); B. *P. sodiroi* (Harling 3850); C – E. *P. ecuadorensis* (Sparre. 17009); F. *P. ferruginea* (Sneidern 4448); G. *P. sodiroi* (Harling 3850); H. *Satyria leucostoma* (Asplund 18814); I – J. *S. warszewiczii* (Skutch 3410); K. *S. leucostoma* (Asplund 18814); L. *S. panurensis* (Smith 2798); M – N. *S. pilosa* (Luteyn & Roldan 12440); O. *S. warszewiczii* (Skutch 3410). Isodynamosporus pollen tetrads at polar view (A, C, H – I); heterodynamosporus pollen tetrads at equatorial view (B); micrographs with apocolpial exine sculpture details (D, F – G, K – M, O); micrographs with mesocolpial exine sculpture details (E, N); isodynamosporus pollen tetrads at equatorial view (J).

Fig. 3-40. LM and SEM pollen micrographs. A – C. *Siphonandra elliptica* (Pennell 13857); D. *Sphyrospermum buxifolium* (Asplund 12493); E – G. *S. boekii* (Ollgaard & Balslev 8481); H – I. *S. buxifolium* (Asplund 12493); J – K. *Themistoclesia cutucuensis* (Holguer 5960); L – O. *T. anfracia* (Sneidern 2493). Isodynamosporus pollen tetrads at polar view (A, D, J – K); isodynamosporus pollen tetrads at equatorial view (B); micrographs with apocolpial exine sculpture details (C, G – H, O); heterodynamosporus pollen tetrads at equatorial view (E, L); heterodynamosporus pollen tetrads at polar view (F, M – N); micrographs with mesocolpial exine sculpture details (I).

Fig. 3-41. LM, SEM and TEM pollen micrographs. A. *Themistoclesia cutucuensis* (Holguer 5960); B. *T. epiphytica* (Werff & Palacios 9371); C. *P. mucronata* (Sneidern 2511); D. *Thibaudia parviflora* (Sneidern 1864); E. *T. domingensis* (Ekman 32125); F. *T. albiflora* (Harling & Anderson 23307); G. *T. angustifolia* (Wurdack 983); H. *T. domingensis* (Ekman 32125); I. *T. floribunda* (Alston 8103); J – L. *T. parviflora* (J – K. Sneidern 1864; L. Harling and Anderson 12242); M – O. *T. domingensis* (Ekman 32125). Micrographs with apocolpial exine sculpture details (A – C, F – J, L); pollen tetrads at polar view (D – E); micrographs with mesocolpial exine sculpture details (K); whole tetrad (M); apocolpial exine showing tectum, columellae, foot layer and endexine (N); septum with faint perforation, tectum fragmentary, two foot layer of adjacent grains sometimes connected by columellae, thin endexine and intine (O).

Fig. 3-42. LM and SEM micrographs of *Vaccinium* pollen. A. *V. calycinum* f. *glabreccens* (Skottsberg 1132); B. *V. myrtilloides* (Turesson & Alm 146); C. *V. bracteatum* (Oka s.n.); D. *V. hirtum* (Takahashi 7153); E. *V. japonicum* (Takahashi 1544); F. *V. oxycoccus* (Furuse 8915); G – H. *V. cubense* (Ekman 5294); I. *V. bracteatum* (Oka s.n.); J. *V. randaiense* (Kikuchi s.n.); K – L. *V. wrightii* (Unknown s.n.); M – N. *V. oldhamii* (Takahashi 232); O. *V. emarginatum* (Wang 1022). Pollen tetrads at polar view (A – C); pollen tetrads at equatorial view (D – F); rhomboidal tetrad (F); micrographs with apocolpial exine sculpture details (G – O).

Fig. 3-43. SEM micrographs of *Vaccinium* pollen. A – C. *V. corymbosum* (Spon. & Bouf. 1764, Meyer & Mazzeo 13278 and Utech et al. 83-050, respectively); D. *V. myrsinites* (Moldenke 948); E – F. *V. myrtilloides* (Turesson & Alm 146); G. *V. pallidum* (Setchell s.n.); H. *V. leucanthum* (Luteyn & Lebron-Luteyn 11574); I. *V. meridionale* (Luteyn 6031); J. *V. sprengelii* (Larsen et al. 2016); K – L. *V. vacciniaceum* (Nishioka 1211); M. *V. hirtum* (Takahashi 7153); N – O. *V. smallii* (Takahashi 24491). Micrographs with apocolpial exine sculpture details (A – O).

Fig. 3-44. SEM micrographs of *Vaccinium* pollen. A. *V. smallii* (Kikuchi s.n.); B. *V. crassifolium* (Iltis and Botany 16 23116); C – D. *V. calycinum* f. *glabreccens* (Skottsberg 1132); E. *V. caespitosum* (Churchill s.n.); F. *V. myrtillus* (Willoline s.n.); G. *V. ovalifolium* (Takahashi et al. 27579); H – I. *V. parvifolium* (Allen 71); J – K. *V. scoparium* (Porsild & Breitung 12504); L – M. *V. japonicum* (Takahashi 1544); N. *V. microcarpum* (Takahashi 9873); O. *V. macrocarpon* (Ernest & LeBlanc 61141). Micrographs with apocolpial exine sculpture details (A – L, N – O); micrographs with mesocolpial exine sculpture details (M).

Fig. 3-45. SEM and TEM micrographs of *Vaccinium* pollen. A. *V. macrocarpon* (Ernest & LeBlanc 61141); B. *V. oxycoccus* (Furuse 8915); C. *V. stamineum* (Unknown s.n.); D. *V. praestans* (Takahashi et al. 27575); E. *V. consanguineum* (Allen 4768); F. *V. floribundum* var. *floribundum* (Larsson s.n.); G. *V. ovatum* (Unknown 26); H – I. *V. uliginosum* (Takahashi 9864 and 9908, respectively); J. *V. vitis-idaea* (Takahashi 9856); K – L. *V. donianum* (Alsterlund 100); M – O. *V. smallii* (Sarwar & Takahashi s.n.). Micrographs with apocolpial exine sculpture details (A – K); micrographs with mesocolpial exine sculpture details (L); whole tetrad (M); apocolpial exine showing tectum, columellae, foot layer and endexine (N); in septum tectum lacking, two foot layer of adjacent grains connected by columellae, thin endexine and intine (O).

Legends

Fig. 4-5. Dendrogram made from the first 8 palynological characters of 54 Ericaceous genera by Agglomerative Hierarchical Clustering analysis. For characters and taxa see Table 4-4.

Fig. 4-6. Dendrogram made from all eleven palynological characters of 54 Ericaceous genera by Agglomerative Hierarchical Clustering analysis. For characters and taxa see Table 4-4.

Fig. 4-7. Two dimensional diagram of component 1 and 2 of pollen tetrads of 54 Ericaceous genera based on Principal Component Analysis of eleven palynological characters. For characters and taxa see Table 4-4.

Fig. 4-8. Diagrammatic representation of morphological variations and relationships within exine sculptural types of the Ericaceae.

Appendix 1

Comparison among the different classification systems of Ericaceae.

Hooker (1876):

Family Vacciniaceae

Thiabaudieae : including *Agapetes* and *Notopora*

Vaccinieae : including *Chiogenes*, *Wittsteinia* and *Sphyrospermum*

Family Ericaceae

Arbuteae : *Arbutus*, *Arctostaphylos*, *Pernettya*

Andromedeae : *Gaultheria*, *Diplycosia* – *Cassandra*, *Cassiope*, *Leucothoe*, *Oxydendrum*, *Orphanidesia*, *Epigaea* – *Agauria*, *Agarista*, *Lyonia* – *Zenobia*, *Andromeda*, *Pieris*, *Enkianthus*

Ericaceae

Euericeae : including *Calluna*

Salaxideae

Rhodoreae : *Loiseleuria*, *Bryanthus*, *Phyllodoce*, *Daboecia*, *Kalmia*, *Rhodothamnus*, *Diplarche* – *Leiophyllum*, *Ledothamnus*, *Cladostamnus*, *Elliottia* – *Ledum*, *Bejaria* – *Rhododendron*, *Menziesia*, *Tsusiophyllum*

Pyroleae

Genus anomalum : *Clethra*

Family Monotropeae

Family Empetraceae

Family Epacridaceae

Drude (1889):

Family Pyrolaceae

Pyrolloidae : *Ramischia*, *Chimaphila*, *Pyrola*, *Moneses*

Monotropoideae : (two tribes, the Monotropeae and Pleuricosporeae)

Family Ericaceae

Rhododendroideae

Ledeae : *Ledum*, *Elliottia*, *Cladostamnus*, *Tripetaleia*, *Bejaria*

Rhodoreae : *Rhododendron*, *Menziesia*, *Tsusiophyllum*

Phyllodoceae : *Ledothamnus*, *Leiophyllum*, *Loiseleuria*, *Diplarche*, *Rhodothamnus*, *Kalmia*, *Phyllodoce*, *Bryanthus*, *Daboecia*

- Arbutoideae
- Andromedeae : *Andromeda, Enkianthus, Cassiope, Leucothoë, Lyonia, Agauria, Oxydendrum, Orphanidesia, Epigaea, Peiris, Chamaedaphne, Zenobia, Agauria*
- Gaultherieae : *Gaultheria, Diplycosia, Pernettya, Chiogenes, Wittsteinia*
- Arbuteae : *Arbutus, Arctostaphylos, Arcois*
- Vaccinioideae
- Vaccinieae : *Gaylussacia, Vaccinium, Oxycoccus*
- Thibaudieae : including *Cavendishia, Sphyraspermum, Agapetes, Notopora, Ceratostema, Pentapterygium*
- Ericoideae
- Ericaceae : including *Calluna*
- Salaxideae

Family Epacridaceae

- Styphelieae : *Styphelia, Coleanthera, Astroloma, Conostephium, Melichrus, Pentachondra, Cyathodes, Trochocarpa, Brachyloma, Needhamia, Lissanthe, Leucopogon, Decatoca, Monotoca, Cyathopsis, Acrotriche, Oligarrhena*
- Epacrideae : *Epacris, Lysinema, Rupicola, Archeria, Cosmelia, Andersonia, Richea, Dracophyllum, Sprengelia, Sphenostema*
- Prionoteae : *Lebetanthus, Prionotes*

Rendle (1956):

Family Ericaceae

- Rhododendroideae : *Rhododendron (including Azalea), Ledum, Dabeocia, Loiseleuria, Phyllodoce, etc.*
- Arbutoideae : *Gaultheria, Arbutus, Arctostaphylos, Andromeda, Epigaea, etc.*
- Vaccinioideae : *Vaccinium, Thibaudia, etc.*
- Ericoideae : *Erica, Blaeria, Calluna, etc.*

Family Pyrolaceae

- Pyroloidae : *Pyrola, Chimaphila, etc.*
- Monotropoideae : *Monotropa, Pterospora, Sarcodes, etc.*

Family Epacridaceae : *Styphelia, Epacris, Lebetanthus, Prionotes, etc.*

Family Empetraceae

Watson et al. (1967):

Family Ericaceae

Subfamily I (Ericoids)

- Tribe 1 : *Calluna, Cassiope*
- Tribe 2 : all the Ericoideae *sensu* Drude and Hooker except *Calluna*

Subfamily II (Rhododendroids)

- Tribe 1 : *Rhododendron, Ledum, Elliottia (Tripetaleia), Menziesia, Tsusiophyllum*
 Tribe 2 : *Bejaria*
 Tribe 3 (with Vaccinioids affinities) : *Epigaea, Ledothamnus, Leiophyllum, Loiseleuria, Daboecia, Phyllodoce (Bryanthus), Rhodothamnus, Kalmia,*

Subfamily III (Vaccinioids)

- Tribe 1 (Arbuteae) : *Arbutus, Arctostaphylos, Arcoüs*
 Tribe 2 (Andromedeae p.p.) : *Andromeda, Oxydendrum, Gaultheria, Pernettya, Lyonia, Pieris, Leucothoë, Chamaedaphne, Zenobia, Enkianthus, Agauria, Diplycosia*
 Tribe 3 : the Vaccinieae and Thibaudieae *sensu* Hooker combined, i.e. including *Chiogene*

Family Epacridaceae

Subfamily I

Tribe 1 (Styphelieae)

- Subtribe I : *Styphelia, Astroloma, Coleanthera, Conostephium, Melichrus, Cyathodes, Lissanthe, Pentachondra, Trochocarpa, Brachyloma, Acrotliche, Leucopogon, Decatoca, Monotoca, Cyathopsis*

- Subtribe I : *Needhamia,*
 Subtribe I : *Oligarrhena*

Subfamily II

- Tribe 1 : *Epacris, Lysinema, Rupicola, Archeria, Lebetanthus, Prionotes*
 Tribe 2 : *Cosmelia, Andersonia, Sprengelia*
 Tribe 3 : *Richea, Sphenostema, Dracophyllum*

- Isolated genus : *Wittsteinia*

Stevens (1971):

Family Ericaceae

Rhododendroideae

- Bejariaeae : *Bejaria*
 Rhodoreae : *Rhododendron, Therorhodon, Tsusiophyllum, Menziesia, Ledum*
 Cladothamneae : *Cladothamnus, Elliottia*
 Epigaeae : *Epigaea*
 Phyllodoceae : *Kalmia, Phyllodoce, Kalmiopsis, Rhodothamnus, Bryanthus, Ledothamnus, Leiophyllum, Loiseleuria*
 Daboeciaeae : *Daboecia*
 Diplarcheae : *Diplarche*

Ericoideae

Ericaceae and Salaxideae perhaps combined

- Calluneae : *Calluna*

Vaccinioideae

- Arbuteae : *Arbutus, Comarostaphylis, Ornithostaphylis, Xylococcus, Arctostaphylos, Arcoüs*
 Enkiantheae : *Enkianthus*
 Cassiopeae : *Cassiope, Harrimanella*
 Andromedeae : *Andromeda, Oxydendrum, Craibiodendron, Lyonia, Pieris, Agauria, Agarista, Arctericia, Chamaedaphne, Zenobia, Leucothoë, Gaultheria, Pernettyopsis, Tepuia, Diplycosia*

- Vaccinieae
- Pyroloideae : *Pyrola, Moneses, Chimaphila*
- Monotropoideae
- Wittsteinioideae : *Wittsteinia*

Hutchinson (1973):

- Family Pyrolaceae : including Retalaceae, *Chimaphila, Moneses, Orthilia, Pyrola, Erxlebenia*
- Family Ericaceae : *Arbutus, Arcotstaphylos, Pernettya, Gaultheria, Cassiope, Leucothoe, Agarista, Andromeda, Pieris, Enkianthus, Calluna, Erica, Philippia, Blaeria, Grisebachia, Simocheilus, Scyphogyne, Loiseleuria, Bryanthus, Daboecia (Daeocia), Kalmia, Elliottia, Ledum, Rhododendron (Azalea), etc.*
- Family Prionotaceae : *Prionotes, Lebetanthus, Wittsteinia*
- Family Epacrideae : *Astroloma, Leucopogon, Epacris, Andersonia, Richea, Dracophyllum, etc.*
- Family Monotropaceae : *Monotropa, Hypopitys, Allotropa, Cheilothea, Pleuricospora, Eremotropa, Monotropastrum, Monotropsis (Cryptophila), Pityopsis, Hemitomes, Pterospora, Sarcodes, Newberrya*
- Family Vacciniaceae : *Psammisia, Cavendishia, Ceratostema, Agapetes (Pentapterygium), Gaylussacia, Vaccinium, Oxycoccus, etc.*

- Family Empetraceae : including Ramostigmaceae

Cronquist (1981):

- Family Empetraceae

- Family Epacridaceae

- Family Ericaceae : He described the subfamilial classification of Ericaceae as in dispute and did not make any specific comment on it, but accepted the subfamilial status for the Vaccinioideae. In his words, “It has been customary to recognized 4 subfamilies, the Ericoideae, Rhododendroideae, Arbutoideae, and Vaccinioideae, but some more recent authors would recognized an additional small subfamily Epigaeoideae, and submerged the Arbutoideae in the Vaccinioideae”

- Family Pyrolaceae : *Chimaphila, Moneses, Orthilia, Pyrola*

- Family Monotropaceae : *Allotropa, Cheilothea, Hemitomes, Hypopitys, Monotropsis, Pityopsis, Monotropastrum, Pleuricospora, Pterospora, Sarcodes*

Thorne (1992):

- Family Ericaceae
 - Rhododendroideae : including 15 genera, 700 species
 - Ericoideae : including 17 genera, 865 species

- Vaccinioideae : including Arbuteae, 54 genera, 660 species
 Pyroloideae : including 3 genera; *Chimaphila*, *Moneses*, *Pyrola*, 10 species
 Monotropeoideae : including 10 genera, 12 species

Family Epacridaceae : excluding *Wittsteinia*

Family Empetraceae

Takhtajan (1997):

Family Ericaceae

Rhododendroideae

Bejariaceae : *Bejaria*

Rhododendreae : *Rhododendron* (including *Ledum*), *Therorhodon*, *Tsusiophyllum*, *Menziesia*

Cladothamneae : *Elliottia*

Phyllodoceae : *Kalmia*, *Phyllodoce*, *Kalmiopsis*, *Rhodothamnus*, *Bryanthus*, *Ledothamnus*,
Leiophyllum, *Loiseleuria*

Daboecieae : *Daboecia*

Diplarcheae : *Diplarche*

Epigaeoideae : *Epigaea*

Ericoideae

Ericaceae : *Erica*, *Bruckenthalia*, etc.

Salaxideae : *Salaxis*, *Eremia*, etc.

Calluneae : *Calluna*

Vaccinioideae

Arbuteae : *Arbutus*, *Comarostaphylis*, *Ornithostaphylis*, *Xylococcus*, *Arctostaphylos*

Enkiantheae : *Enkianthus*

Cassiopeae : *Cassiope*, *Harrimanella*

Andromedaeae : *Andromeda*, *Oxydendrum*, *Craibiodendron*, *Lyonia*, *Pieris*, *Agarista*, *Chamaedaphne*,
Zenobia, *Leucothoë*, *Gaultheria*, *Pernettyopsis*, *Tepuia*, *Diplycosia*

Vaccinieae : *Gaylussacia*, *Vaccinium* (including *Oxycoccus*), *Thibaudia*, etc.

Pyroloideae : *Pyrola*, *Orthilia*, *Chimaphila*, *Moneses*

Monotropeoideae

Pterosporeae : *Pterospora*, *Sarcodes*, *Allotropa*

Pleuricosporeae : *Pleuricospora*

Monotropeae : *Cheilothea*, *Monotropis*, *Monotropa*, *Monotropastrum*, etc.,

Hemitomeae : *Hemitomes*

Family Empetraceae

Family Epacridaceae

The recent phylogenetic classification by Kron et al. (2002a):

Family Ericaceae

- Enkianthoideae : *Enkianthus*
- Monotropeoideae
 - Pyroleae : *Chimaphila, Moneses, Orthilia, Pyrola*
 - Monotropeae : *Allotropa, Cheilotheca, Hemitomes, Hypopitys, Monotropastrum, Monotropsis, Pityopsis, Pleuricospora*
 - Pterosporeae : *Pterospora, Sarcodes*
- Arbutoideae : *Arbutus, Arcotstaphylos, Comarostaphylis, Ornithostaphylos*
- Ericoideae
 - Bejariaceae : *Bejaria, Bryanthus, Ledothamnus*
 - Ericaceae : *Calluna, Daboecia, Erica*
 - Phyllodoceae : *Elliottia, Epigaea, Kalmia* (including *Leiophyllum, Loiseleuria*), *Phyllodoce, Rhodothamnus*
 - Empetreae : *Ceratiola, Corema, Empetrum*
 - Rhodoreae : *Diplarche, Menziesia, Rhododendron, Throerhodium*
- Cassiopoideae : *Cassiope*
- Harrimanelloideae : *Harrimanella*
- Styphelioideae
 - Prionoteae : *Lebetanthus, Prionotes*
 - Archeriaceae : *Archeria*
 - Oligarrheneae : *Needhamiella, Oligarrhena*
 - Richeaceae : *Dracophyllum, Richea, Sphenotoma*
 - Epacrideae : *Epacris* (including *Rupicola and Budawangia*), *Lysinema, Woollsia*
 - Cosmelieae : *Andersonia, Cosmelia, Sprengelia*
 - Styphelieae : *Acrotriche, Androstoma, Astroloma, Brachyloma, Coleanthera, Conostephium, Croninia, Cyathodes, Cyathopsis, Decatoca, Leptecophylla, Leucopogon, Lissanthe, Melichrus, Monotoca, Pentachondra, Planocarpa, Styphelia, Trochocarpa*
- Vaccinioideae
 - Oxydendreae : *Oxydendrum*
 - Lyonieae : *Agarista, Craibiodendron, Lyonia, Pieris*
 - Andromedeae : *Andromeda, Zenobia*
 - Gaultherieae : *Chamaedaphne, Diplycosia, Gaultheria, Leucothoe, Tepuia*
 - Vaccinieae : *Antheopteropsis, Anthopterus, Cavendishia, Ceratostema, Costera, Demostenesia, Didonica, Dimorphantha, Diogenesia, Disterigma, Gaylussacia, Gonocalyx, Lateropora, Macleania, Mycerinus, Notopora, Oreanthes, Orthaea, Paphia, Pellegrinia, Plutarchia, Polyclita, Psammisia, Rusbya, Satyria, Semiramisia, Siphonandra, Sphyrropermum, Themistoclesia, Thibaudia, Utleja, Vaccinium* (including *Agapetes, Rigiolepis*)

Appendix 2

The following is a list of the specimens studied in this investigation. The herbarium of origin of the material is indicated by the abbreviations used in the Index Herbariorum (Holmgren et al.1990) except SAPT (the Botanic Garden of Hokkaido University, Sapporo). The arrangement of the tribe, genus and species (where applicable) is alphabetic.

Taxa and Voucher Information

Subfamily Enkianthoideae Kron, Judd & Anderb.

- Enkianthus campanulatus* (Miq.) Nichols. Japan: Sendai-shi, 24.05.1977. H. Takahashi 511 (SAPS) LM silde no. 21.082, SEM stub no. 4
Honshu, Kaga, Mt. Hakusan, no day.07.1889. C. Sukawa s.n. (SAPS) LM slide & SEM Stub no. 8
Honshu, Shinano, near Omagari-Zorin-Zigyosyo, cultivated plant, 10.06.1961. M. Tatewaki, K. Ito & T. Nigi. s.n. (SAPS) LM silde & SEM stub no. 1
Hokkaido, Sapporo-shi, Hokkaido University, Botanic Garden, 02.06.2004. Sarwar & H. Takahashi s.n. (SAPS) SEM stub no. 4a
- E. campanulatus* (Miq.) Nichols. var. *longilobus* (Nakai) Makino Japan: Bungo, Mt. Kuju, 11.06.1928. Z. Tashiro s.n. (TI) LM silde no. & SEM stub no. 8a
- E. campanulatus* (Miq.) Nichols. var. *palibinii* (Craib) Bean Japan: Honshu, Shimotsuke, Nikko, the pass of Sanno, 23.06.1961. M. Tatewaki s.n. (SAPS) LM silde & SEM stub no. 11
- E. cernuus* (Sieb. et Zucc.) Makino Japan: Shikoku, 21.6.1984. M. Takahashi 1827 (SAPT) LM silde no. 21.081, SEM stub no. 6
- E. cernuus* (Sieb. et Zucc.) Makino f. *rubens* (Maxim.) Ohwi Japan: Honshu, Kanagawa, Hakone, Mt. Kami-Futago, 04.06.1967. M. Tohyama s.n. (SAPS) LM silde & SEM stub no. 2
Honshu, Chichibu-Musashi, 17.05.1901. S. Matsuda s.n. (SAPS) LM silde & SEM stub no. 7
Honshu, Kii, Koyasan, 09.06.1929. K. Numajiri s.n. (SAPS) SEM stub no. 6a
Honshu, Wakayama, Kozagawa-cho, Hirai, 20-24.05.1970. T. Kumata s.n. (SAPS) SEM stub no. 8b
- E. chinensis* Franch. Flora of SW China: NE Upper Burma and SE Tibet (Ex. Herb. Hort. Bot. Reg. Edin) Forrest 30465 (TI) LM silde & SEM stub no. 12
C China, W Hukeh, on date, E. H. Wilson 1002 (E 00201100) SEM stub no. 14
- E. deflexus* (Griff.) Schn. Japan: Tokyo, cultivated, 24.05.1981. T. Yamazaki 2537 (TI 1326237) LM silde & SEM stub no. 12a
Bhutan: Tzatogang (3200m) – Dotanang (2500m), 27.05.1967. H. Hara et al. 21810 (TI) SEM stub no. 12b
China: W Yunnan, Huadianba Farm, W of N end of Cangshan, alt. 2900m. 19.05.1981. Unknown 0814 (E 00201099)* SEM stub no. 12c
NW Yunnan, Mountain of Wei-Hsi, alt. 3080m, no day.07.1928. J. F. Rock 17142 (E 00201101)* SEM stub no. 14a

- E. nudipes* (Honda) Ohwi Japan: Honshu, Wakayama Exp. For. 03.05.1937. T. Onooka 27182 (SAPS) LM silde & SEM stub no. 10
Honshu, Kii, Mt. Meshimori, 30.04.1928. T. Nakajima s.n. (SAPS) SEM stub no. 10a
- E. perulatus* (Miq.) C.K. Schn. Japan: Sendai-shi, cultivated, 02.05.1977. H. Takahashi 509 (SAPS) LM silde no. 21.068, SEM stub no. 5
Hokkaido, Sapporo-shi, Hokkaido University, Botanic Garden, 18.05.2004. Sarwar & H. Takahashi s.n. (SAPS) SEM stub no. 5a
- E. quinqueflorus* Lour. China: Flora of Kwangtung, Herb. Canton Christian Coll. No. 13271, 13.03.1967. F. A. McClure s.n. (TI) LM silde & SEM stub no. 13
- E. serotinus* Chun & Fang China: Kwangtung, Chiow-lung, Ta-mao-shan, alt. 300-700m. 16.01.1964. M. Togashi & G. Murata 8032 (TI) LM silde & SEM stub no. 13a
- E. sikokianus* (Palib.) Ohwi Japan: Honshu, Kii, Upper Koga, Tamanotami, 13.05.1937. T. Onooka 27206 (SAPS) LM silde & SEM stub no. 3
Honshu, Wakaya, Exp. Forest, 03.06.1937. T. Onooka 27245 (SAPS) SEM stub no. 3a
- E. subsessilis* (Miq.) Makino Japan: Honshu, Utsunomiya -shi, 28.05.1982. H. Ohashi et al. 11824 (SAPT) LM silde no. 21.067, SEM stub no. 9a
Honshu, Kodzuke, Mt. Tanigawa, 21.06.1956. M. Tohyama s.n. (SAPS) SEM stub no. 9
Honshu, Nikko, Yagenbori, 07.07.1903. H. Takeda s.n. (SAPS) SEM stub no. 9b

Subfamily Arbutoideae Nied.

- Arbutus andrachne* L. Greece: Rhodes, Petalondes, 06.03.1959. I. Segelberg s.n. (S) LM silde no. 21.046, SEM stub no. 213
- A. canariensis* Veill. Canary Islands: Tenerif, in vicin peg, cult., no day.01.1933. E. & R. Wahlstom s.n. (C) LM silde no. 21.184, SEM stub no. 214
- A. menziesii* Pursh USA: Washington, Marysville, sea shore, no day.04.1927. J.M. Grant s.n. (S) LM silde no. 21.047, SEM stub no. 215
- A. texana* Buckl. USA: Texas, Jeff Davis Co., Davis Mount Resort, 7500ft, 18.04.1973. P.D. Sorensen, T. Huton & J. Irager 7310E (C) LM silde no. 21.155, SEM stub no. 216
- Arctostaphylos andersonii* Gray USA: California, Santa Cruz Co., Brookdate, 11.03.1947. L.S. Rose 47029 (GB) LM silde no. 21.222, SEM stub no. 219
- A. auriculata* Eastwood USA: California, Contra Costa Co., Mt. Diablo, above Rock city, 1700ft alt., 06.03.1949. L.S. Rose 49004 (GB) LM silde no. 21.221, SEM stub no. 220
- A. bakeri* Eastwood USA: California, S Sonoma Co., 2 mi. NE of Occidental, serpentine hills, 700 ft alt., 21.03.1955. L.S. Rose 55031 (GB) LM silde no. 21.220, SEM stub no. 221
- A. crustacea* Eastwood USA: California, San Mateo Co., Kings Mt. Rocky brushy hills, 30.03.1942. L.S. Rose 42007 (C) LM silde no. 21.154, SEM stub no. 222
- A. densiflora* M.S. Baker USA: California, Sonoma Co., Vine hill, 9 mi. W of Santa Rosa, 28.02.1955. L.S. Rose 55005 (GB) LM silde no. 21.219, SEM stub no. 223
- A. glauca* Lindl. USA: California, Contra Costa Co., Mt. Diablo, 2000ft alt., 09.01.1949. C. Skottsberg s.n. (GB) LM silde no. 21.218, SEM stub no. 224
- A. nevadensis* Gray USA: Washington, Cascade Mts., upper valley of the Nesqually, 27. 04.1895. O.D. Allen 110 (C) LM silde no. 21.153, SEM stub no. 225

- A. nummularia* Gray USA: California, Santa Cruz Co., N entrance to the Bis Basin hill slopes, alt. 1900ft, 05.05.1937. L. S. Rose s.n. (S) LM silde no. 21.001, SEM stub no. 230
California, marin Co., S slope of Mt. Tamalpais, 1000ft alt., 17.02.1961. L.S. Rose 61009 (GB) LM silde no. 21.217, SEM stub no. 226
- A. patula* Greene. USA: California, Shaver Lake campground, elev. 5450ft, 25.05.1971. R.F. Thorne & C.W. Tilforth 39693 (SAPT) LM silde no. 21.086, SEM stub no. 227
- A. pungens* H.B.K. USA: Arizona, Mt. Lemmon, 06.03.1960. J. Gray s.n. (TUS 7321) SEM stub no. 227a
- A. viscida* Parry. USA: California, Toulumne Co. Confidence, dry slopes, Alt. 4200ft, 01.05.1962. L.S. Rose 60006 (S) LM silde no. 21.010, SEM stub no. 229
- Comarostaphylis discolor* (Hook.) Diggs. ssp. *discolor* Mexico: State of Mexico, Sierra de las Cruces, 1000ft, 20.04.1898. C. G. Pringle 6815 (C) LM silde no. 21.150, SEM stub no. 217
Guatemala: Dept. Huehuenango, Cerro Pixpix, above San Ildefonso Ixtahuacan, alt. 1600-2800m, 15.08.1945. J.A. Steyermark 5059b (S) LM silde no. 21.114, SEM stub no. 228
- C. glaucescens* (H.B.K.) Zucc. Ex Klotz. Mexico: State of Oaxaca, hills above Oaxaca city, 7000ft, 22.05.1906. C.G. Pringle 13762 (C) LM silde no. 21.149, SEM stub no. 218

Subfamily Ericoideae Link

Tribe Bejarieae Copeland

- Bejaria aestuans* Mutis ex L. Venezuela: Edo, Tachira Hwy.9, 37 km S of Delicias, 28.01.1978 J.L. Luteyn et al. 5296 (S) LM silde no. 20.999, SEM stub no. 234
- B. racemosa* Vent. USA: Florida, Dade Co., W of Fulford, in dry sandy soil among palmettos, flowers pink, somewhat viscid, 10.02.1930. H.N. Moldenke 601 (S) LM silde no. 21.061, SEM stub no. 235
- B. resinosa* Mutis ex L. fil. Colombia: District Cauca, ad pag, El Tambo, 3060m, 08.11.1936. K. von Sneidern 1069 (S) LM silde no. 1.113, SEM stub no. 236
- B. subsessalis* Benthum Ecuador: Prov. Loja-Zamora road, 2 – 7km W of the pass, 2400 – 2700m alt. 17.06.1979. B. Lójtant & U. Molau 15010 (GB) LM silde no. 21.231, SEM stub no. 237
- Bryanthus gmelinii* D. Don. Japan: Hokkaido, Mts. Daisetsu, between Mt. Goshikiga-take and Mt. Kaun-dake 07.08.1982. H. Takahashi et al. 2881 (SAPS) LM silde no. 21.079, SEM stub no. 178

Tribe Empetreae D. Don

- Ceratiola ericoides* Michx. USA: Florida, Palm Beach Co., 5 miles north of Jupiter (Plantae Exsiccatae Grayanea), 14.12.1945. R.A. Howard 8050 (SAPS) LM silde & SEM stub no. 281
- Corema conradii* Torr. No locality, (Herb. Arbor. Harvard University), 8.4.1892. Jurr s.n. (SAPS) LM silde & SEM stub no. 282
- Empetrum nigrum* L. Russia: Kuril Inlands, Urup Inland, Okhotsk side, Otkrytyy Bay, SW of the Peresheek river, 5.8.1995. H. Takahashi 18549 (UR-95-HT-008)(SAPS) LM silde & SEM stub no. 283

Tribe Ericaceae DC. Ex Dudy

- Calluna vulgaris* (L.) Hull. Sweden: Uppland, Uppsala, Jumkil, light open field, 13.08.1989. H. Takahashi 10013 (SAPS) LM silde no. 21.076, SEM stub no. 245
USSR: Provincia Kalinin, districtus Bologoje, pinetum prope stat. Berezajka 20.08.1975. A. Matsenko 187 (SAPT) LM silde no. 21.085, SEM stub no. 245a
- Daboecia cantabrica* (Huds.) C. Koch. Ireland: West Galway, Oughterard, Glann, on low banks in boggy field, 14.08.1970. G. Halliday 123/70 (C) LM silde no. 21.148, SEM stub no. 246

- Daboecia cantabrica* (Huds.) C. Koch. Ireland: Galway, 23.07.1933. B. Nilsson & G. Degelius s.n. (S) LM silde no. 21.043, SEM stub no. 247
- Erica arborea* L. Ethiopia: 10 km from Asella, road to Bekoji, red loamy soil, 2500m alt., 04.09.1967. E. Westphal & J.M.C. Westphal-Stevels 1657 (C) LM silde no. 21.156, SEM stub no. 239
- E. axillaris* Thunb. South Africa: In dunis arenosia Peninsulae Capensis, no day.03.1884. H.O. Bolus 48 (S) LM silde no. 21.000, SEM stub no. 250
- E. barbiger* (G. Don.) E.G.H. Oliv. South Africa: SW Cape, Hedmanus Dist., 26.09.1949. J.L. Sidey 1853 (S) LM silde no. 21.021, SEM stub no. 264
- E. bokkeveldia* E.G.H. Oliv. South Africa: SW Cape, Wagenbooms river in the Northern Bokkeveld, alt. 2150ft, 01.10.1972. E.G.H. Oliver 4010 (S) LM silde no. 21.003, SEM stub no. 253
- E. cinerea* L. Denmark: Faroe Islands, District Strómó, Loc. 70, Husareyn, alt. 300 – 600m, 23.07.1960. The Botanical Investigations 1104 (SAPT) LM silde no. 21.069, SEM stub no. 240
- E. curvistyla* (N.E. Br.) E.G.H. Oliv. South Africa: SW Cape, Grootfontein, SE of Grassruggens, Oifants river valley, 27.10.1972. E.G.H. Oliver 4072 (C) LM silde no. 21.157, SEM stub no. 263
- E. dumosa* (Wendl.) E.G.H. Oliv. South Africa: Cape, Caledon Div. Palmiet riv., no day.12.1952. T.P. Stokoe 67017 (S) LM silde no. 21.002, SEM stub no. 248
- E. glabella* Thunb. South Africa: Cape Prov., Caledon Div. Hottentots Holland Mts. Moordenaars kop, 5000ft alt., no day.02.1943. T.P. Stokoe s.n. (GB) LM silde no. 21.216, SEM stub no. 249
- E. globiceps* (N.E. Br.) E.G.H. Oliv. ssp. *consors* (N.E. Br.) E.G.H. Oliv. South Africa: Cape Prov., 34.19 AD Caledon, Fern Kloof Nature Reserve, Hermanus, 02.04.1980. E.R. Orchard 546 (C) LM silde no. 21.146, SEM stub no. 258
- E. labilis* Salisb. South Africa: Cape Prov., Caledon Distr., 16.04.1974. P. Goldblatt 1622 (S) LM silde no. 21.007, SEM stub no. 260
- E. mucosa* (Ait.) E.G.H. Oliv. South Africa: Cape Pen., Klader Hlsv (?), 02.12.1937. E. Watt 3614 (S) LM silde no. 21.008, SEM stub no. 262
- E. multiflora* L. Spain: Valencia, Cofrentes, in dumosis calcareis, 440m alt., 22.10.1977. M. Costa & E. Valdés-Bermejo 2827 EV (C) LM silde no. 21.141, SEM stub no. 241
- E. nabea* Guthrie & Bolus. South Africa: Cradock peak, S.W. Cape, 01.10.1978. R. Granby 134 (C) LM silde no. 21.144, SEM stub no. 242
- E. plumosa* Thunb. South Africa: SW Cape, Bontebok National Park, sandy flats at base of escarpment near Grootfonteinskloof, 21.07.1983. E.G.H. Oliver 4305 (C) LM silde no. 21.147, SEM stub no. 257
- E. puberuliflora* E.G.H. Oliv. South Africa: W Cape, Klim river valley, 25.09.1949. J.L. Sidey 1842 (S) LM silde no. 21.006, SEM stub no. 254
- E. recurvifolia* E.G.H. Oliv. South Africa: Cape Prov., Piketberg Dist., Zebra Kop, alt. 4600ft, 16.12.1979. E. Esterhuysen 35333 (S) LM silde no. 21.004, SEM stub no. 255
- E. sicala* Guss. Cyprus: North Range, Klippen, 28.03.1970. Axao s.n. (C) LM silde no. 21.032, SEM stub no. 243
- E. similis* (N.E. Br.) E.G.H. Oliv. South Africa: Cape Peninsula, Kenilworth Race Course, 19.02.1970. E. Esterhuysen 32395 (S) LM silde no. 21.005, SEM stub no. 261
- E. spiculifolia* (Rchb.) E.G.H. Oliv. Bulgaria: Musalla, no date.1932. O. Cyrén s.n. (S) LM silde no. 21.022, SEM stub no. 252

- E. tetralix* L. Denmark: Zealand, Gudmindrup Lyng, W of Nykøbing, 13.08.1969. N. Jacobsen & J. Svendsen 137 (SAPT) LM silde no. 21.074, SEM stub no. 244
- E. trimera* (Engl.) E.G.H. Oliv. ssp. *keniensis* (S. Moore) Hedb. Kenya: Mt. Kenya, Teleki Valley, alpine region, 400m, 06.08.1948. O. Hedberg 1829 (S) LM silde no. 21.018, SEM stub no. 251
- E. uberiflora* E.G.H. Oliv. South Africa: Humansdorp Distr., Strom river Forest Reserve, 100 – 200m alt., 30.12.1968. K.Å. Dahstrand 1683 (GB) LM silde no. 21.213, SEM stub no. 259
- E. xeranthemifolia* Salisb. South Africa: Cape Prov., Caledon district, top of Shaws pass, between Caledon and Hermanus, 12.09.1974. P. Goldblatt 2627 (C) LM silde no. 21.178, SEM stub no. 256

Tribe Phyllodoceae Drude, Engl. & Prantl.

- Elliottia bracteata* (Maxim.) Benth. et Hook.f. Japan: Hokkaido, Prov. Teshio, Masike-gun, Masike-cho, Mt. Shokanbetsu, 28.07.1983. H. Takahashi 4500 (SAPS) LM silde no. 21.236, SEM stub no. 180
- E. paniculata* (Sieb. et Zucc.) Benth. et Hook.f. Japan: Hokkaido, Hiyama-sicho, Kudoo-gun, Taisei-cho, Mt. Ohta-san, 06.08.1987. H. Takahashi 7802 (SAPS) LM silde no. 21.235, SEM stub no. 181
- E. pyroliflora* (Bong.) S.W. Brim & P.F. Stevens USA: Alaska, Juneau Quadrangle, Mt. Roberts behind, no day.08.1967. L.A. Viereck 8624 (S) LM silde no. 21.060, SEM stub no. 179
- Epigaea asiatica* Maxim. Japan: Hokkaido, Hiyama-shicho, Kaminokuni-cho, 18.04.1982. M. Hara 5212 (SAPS) SEM stub no. 177a
- E. repens* L. USA: New York, Tomplins Co., slopes on east side of valley of Cayuga Intel, about 2 miles north of W Danby, 13.04.1935. R.I. Clausen 19207 (S) LM silde no. 21.056, SEM stub no. 177
- Kalmia angustifolia* L. USA: Connecticut, Litchfield Co., Norfolk, Great Mt. Forest, Tobey bog, 23.06.1983. S. DeSimon 415 (SAPT) LM silde no. 21.070, SEM stub no. 183
- K. buxifolia* (Berg.) Gift, Kron, & Stevens USA: North Carolina, Brunswi. Co., 12 miles S of Wilmington, 06.04.1939. R.K. Godfrey & R.N. White 7110 (S) LM silde no. 21.041, SEM stub no. 185
- K. ericoides* Wright ex Grisebatch var. *aggregate* Small Cuba: prov. Pinar del Rio, La Grifa, 19.11.1923. E.L. Ekman 18165 (S) LM silde no. 21.054, SEM stub no. 182
- K. latifolia* L. USA: Connecticut, Litchfield Co., Mt. Riga State Park, near Riga lake, moist woods, 16.06.1981. G. Feldman 63 (SAPT) LM silde no. 21.071, SEM stub no. 184
- K. microphylla* (Hook.) Heller USA: Washington, Mt. Rainier, alt. ca. 8000 ft. (Flora of Cascade Mountains), 13.08.1804. O.D. Allen s.n. (SAPS) SEM stub no. 271
- K. polifolia* Wangenh. USA: Washington, swamp, upper valley of the Nesqually, (Flora of Cascade Mountains), 27.05.1893. O.D. Allen s.n. (SAPS) LM silde & SEM stub no. 270
- K. procumbens* (L.) Gift, Kron, & Stevens Japan: Hokkaido, Prov. Kitami, Monbestu-gun, Shirataki-mura, Mt. Taira-yama, 30.06.1980. H. Takahashi et al. 2644 (SAPS) LM silde no. 21.078, SEM stub no. 186
- Sweden: Torne Lappmark, Abisco, Mt Njulla, 20.07.1989. H. Takahashi 9907 (SAPS) LM silde no. 20.971
- Phyllodoce aleutica* (Spreng.) A. Heller Japan: Hokkaido, Jyozankei, Mt. Yoici-dake, 1480m alt. 02.09.1982. H. Takahashi et al. 3666 (SAPS) LM silde no. 21.241, SEM stub no. 187
- P. caerulea* (L.) Bab. Japan: Hokkaido, the Hidaka range, Mt. Poroshiri – Mt. Tottabetsu, 01.08.1983. H. Takahashi 4569 (SAPS) LM silde no. 21.242, SEM stub no. 188
- P. nipponica* Makino var. *oblong-ovata* (Tatew.) Toyokuni Japan: Hokkaido, Hidaka range, Mt. Poroshiri – Mt. Tottabetsu, 01.08.1983. H. Takahashi 4568 (SAPS) LM silde no. 21.243, SEM stub no. 189

Rhodothamnus chamaecistus (L.) Rchb. Austria: Kärnten, Loibl-pass, 1350m, 28.05.1960. I. Segelberg s.n. (S)
LM silde no. 21.042, SEM stub no. 190

Tribe Rhodoreae DC. Ex Duby

Menziesia cicalyx (Miq.) Maxim. Japan: Shiga Pref., Ika-gun, Yogo-machi, SE side of Mt. Anzouyama, alt. 330 – 550m, 03.05.1988. Y. Tateishi & H. Hoshi 13689 (TUS) SEM stub no. 319

M. goyozanensis M. Kikuchi Japan: Iwate Pref., Ofunato-shi, S side of Mt. Goyozan, Tatamiishi (1023m) – top (1341.3m), 07.07.1984. M. Mieno 445 (TUS) SEM stub no. 318

M. multiflora Maxim. Japan: Prov. Rikuzen, Miyagi-gun, Izumigatake, 14.06.1978. H. Takahashi 767 (SAPS) LM silde no. 21.237, SEM stub no. 211

M. pentandra Maxim. Japan: Hokkaido, Ishikari, Sapporo-shi, Mt. Muine 600 – 970m alt, 06.07.1982. H. Takahashi 2687 (SAPS) LM silde no. 21.238, SEM stub no. 212

Rhododendron albrechtii Maxim. Japan: Hokkaido, Prov. Shiribeshi, between Niki-machi and Kyow-machi, Inaho pass, 22.05.1983. H. Takahashi 3975 (SAPS) LM silde no. 21.244, SEM stub no. 191

R. arborescens Torr. USA: no locality, (Herb. Arbor. Harvard Univ.,) Fl. 28.06.1892, Fr. 01.11.1892. Unknown s.n. (SAPS) SEM stub no. 313

R. aureum Gergi. Japan: Hokkaido, Mt. Daisetsu; Mt. Asahi-dake; Sugatamino-ike, 1600 – 1700m alt. 20.06.1982. H. Takahashi 2512 (SAPS) LM silde no. 21.245, SEM stub no. 192

R. brachycarpum D. Don. Japan: Honshu, the boarder of Miyagi and Yamagata Pref., Mt. Zao, 1540 – 1745m alt. 08.07.1983. H. Takahashi et al. 40 (SAPS) LM silde no. 21.226, SEM stub no. 193

R. dauricum L. Japan: Hokkaido, Iburi-shicho, Hobetsu-cho, 11.05.2004. Y. Kanayama et al. 04-9050 (SAPS) SEM stub no. 309

R. davidsonianum Rehd. & E.H. Wils. Scotland: cult. plants in the Royal Botanic Gardens, Edinburg, raised from seed of Wilson 1274, no day.05.1971. C9180 (GB) LM silde no. 21.236, SEM stub no. 194

R. decorum Franch. China: Prov. Sze-chuan, reg. austr., Teng-hsiang-ying 2000 – 2850m alt. 20.05.1922. H. Smith 2016 (GB) LM silde no. 21.190, SEM stub no. 195

R. degronianum Carr. Japan: Nagano Pref., Minamisaku-gun, Kawakami-mura, Mt. Kimpu-san, alt. ca. 2300m, 22.06.1975. H. Iketani 1763 (TUS 129348) SEM stub no. 307

R. dilatatum Mig. Japan: Yamanashi Pref., Minamitsuru-gun, Yamanakako-mura, 950m alt., 01.05.1983. M. Togashi s.n. (SAPT) LM silde no. 21.248, SEM stub no. 196

R. diversipilosum (Nakai) Harmaja Japan: Prov. Mutsu, Mt. Hakkoda, Shimokenashi, alt. 1020m, 30.06.1978. H. Takahashi 206 (SAPS) LM silde no. 21.083, SEM stub no. 210

R. formosanum Hemsl. Taiwan: Taichung Co., Gukan 800m – Chinsan 1100m, 16.03.1985. J. Murata 17561 (TUS) LM slide & SEM stub no. 315

R. groenlandicum (Oeder) Kron & Judd Greenland: Godthabsfjord, Ilulailik, Igdlorssuit, alt. 175m, 17.7.1976. Hansen & B. Fredskild 1007 (SAPT) LM silde no. 21.087, SEM stub no. 208

R. hidakanum Hara Japan: Hokkaido, Hidaka, Horoizumi-cho, Syoya, 10.5.1977. Y. Tateishi & M. Togashi s.n. (TUS 66107) SEM stub no. 304

R. indicum Sw. Japan: Tokyo, cult., no day.05.1882. K. Miyabe s.n. (SAPS) SEM stub no. 303

R. japonicum (A. Gray) Suring. Japan: C. Honshu, Nagano Pref. between Shirakaba-ko and Mt. Tateshinayama, 29.05.1983. H. Takahashi 3998 (SAPS) LM silde no. 21.249, SEM stub no. 197

- R. kaempferi* Planch. Japan: Honshu, Miyagi Pref., Kakuda-shi, Abukuma Mountains, Wariyama pass, 50 – 100m alt., 10.05.1986. J. Iketsu et al. 95 (SAPT) LM silde no. 21.250, SEM stub no. 198
- R. keiskei* Miq. Japan: Kagoshima Pref., Yaku Is. Yakusugi-land – Mt. Tachudake, alt. 100 – 1497m, 10.05.1984. J. Murata, M. Kato & D. Darnaedi 17861 (TUS) SEM stub no. 314
- R. lapponicum* (L.) Wahlenb. Canada: Manitoba, Churchill, 57° 45' N 94° 05' W, 26.06.1984. J.M. Gillett 1835 (C) LM silde no. 21.142, SEM stub no. 199
- R. macrosepalum* Maxim. Japan: Shokoku Isl., Kagawa Pref., Kida-gun, Goken-zan, 200m alt., 05.05.1982. H. Takahashi 1033 (SAPS) LM silde no. 21.251, SEM stub no. 200
- R. macrostemon* Maxim. Japan: Hondo, Yamamoto in Settsu, cult., 10.05.1953. I. Togasi 688 (SAPS) SEM stub no. 310
- R. maddenii* Hook. f. Bhutan: Thimphu (2250m)–Nimchling (2150m)–Tanalum Bridge (2000m)–Bunakha (2100m)–Chima Khoti (2150m), 01.06.1967. H. Kanai et al. 346? (TUS 57346) SEM stub no. 316
- R. mucronulatum* Turcz. var. *ciliatum* Nakai Korea: Keisho-Nando, 20.05.1039. H. Yokoyama 299 (SAPS) SEM stub no. 312
- R. nudipes* Nakai. ssp. *niphophyllum* Japan: Honshu, Shiga Pref., Shiga-gun, Shiga-machi, Mts. Hirasan, 06.05.1981. J. Murata 10910 (SAPT) LM silde no. 21.252, SEM stub no. 201
- R. parvifolium* Adams. Japan: Prov. Nemuro, Ochii-shi, 16.06.1934. M. Tatewaki 20940 (SAPS) SEM stub no. 311
- R. quinquefolium* Bisset et Moore Japan: Rikuzen, Mt. Funagata, 06.05.1972. H. S. Ogura 1637 (TUS 68874) SEM stub no. 306
- R. schlippenbachii* Maxim. Japan: Hokkaido, Sapporo-shi, Hokkaido University campus, cult., 18.05.2004. Sarwar & H. Takahashi s.n. (SAPS) LM slide & SEM stub no. 301
- R. semibarbatum* Maxim. Japan: Kyushu, Ooita Pref., Takeda-shi, Shirouzu-Ooshoojiwa (Mts. Sobokutamuki), alt. 700 – 150 m, 07.07.1979. J. Murata 7987 (TUS 57400) SEM stub no. 305
- R. subarcticum* Harmaja Japan: Hokkaido, Prov. Kitami, Monbetsu-gun, Shirataki-mura, Mt. Taira-yama, alt. 1170m, 30.06.1982. H. Takahashi et al. 2643 (SAPS) LM silde no. 21.084, SEM stub no. 209
- R. trinerve* Fr. Japan: Niigata, Iwafune-gun, Sekikawa- mura, Takanosu-yama, alt. 400m, 10.07.1974. M. Togashi s.n. (TUS 67214) SEM stub no. 317
- R. tschonokii* Maxim. Japan: Honshu, the border of Miyagi and Yamagata Pref., Mt. Zao, 1540 – 1745m alt., 08.07.1983. H. Takahashi et al. 33 (SAPS) LM silde no. 21.232, SEM stub no. 203
- R. tsusiophyllum* Sugim. Japan: Hakone, Mt. Koma, 31.07.1926. T. Sawada s.n. (C) LM silde no. 21.040, SEM stub no. 207
- Japan: Sagami, Komagatake in Mt. Hakone, 10.08.1927. Y. Asahina & K. Hisauchi s.n. (TUS 4578) SEM stub no. 207a
- R. viscistylum* Nakai var. *amakusaense* Takada ex Yamazaki Japan: Kumamoto Pref., Amakusa-gun, Kyroragi, Mt. Nokogiridake, 30.04.1978. T. Minamidani 29613 (TUS 100748) SEM stub no. 308
- R. wadanum* Makino Japan: Prov. Rikuzen, Sendai-shi, Aoba-yama, 29.04.1977. H. Takahashi 550 (SAPS) LM silde no. 21.233, SEM stub no. 204
- R. weyrichii* Maxim. Japan: Shikoku, Kagawa Pref., Takamatsu-shi, Goshikidai, 28.04.1973. Y. Shimamura et al. s.n. (SAPT) LM silde no. 21.234, SEM stub no. 205

- Therhodion camtschaticum* (Pall.) Small. Japan: Hokkaido, Prov. Hidaka, N part of Mts. Hidaka, Mt. Chiroro, 07.08.1985. H. Takahashi et al. 5836 (SAPS) LM silde no. 21.247, SEM stub no. 206
- T. redowskianum* (Maxim.) Hutch. Russia: South Sakhalin, Poronaysk, per. Brusnichnyy, 15.7.1937. B. Yoshimura & M. Hara s.n. (SAPS) SEM stub no. 302

Subfamily Cassiopoideae Kron & Judd

- Cassiopo fastigiata* D. Don. Bhutan: Shringe, Me La, 125000ft alt., 08.06.1949. F. Ludlow, G. Sherriff & J. Hicks 20708 (GB) LM silde no. 21.215, SEM stub no. 231
- C. lycopodioides* (Pall.) D. Don. Japan: Hokkaido, Kawakami-sicho, Kawakami-gun, Kawakami-cho, Mts. Daisetsu, Sugataminoike – Susoaidaira, alt. 1600 – 1750m, 16.07.1987. H. Takahashi et.al. 7185 (SAPS) LM silde no. 21.077, SEM stub no. 232
- USA: Alaska, Mt. Marathon, Seward, Kenai Pen. 60⁰ 06' N, 149⁰ 27' W, 13.07.1951. J.A. Calder 5850 (C) LM silde no. 21.152
- C. mertensiana* (Bong.) G. Don. Canada: British Columbia, Mt. Revelstoke Nat. Park, vicinity of Heather lodge, 22.07.1953. J.A. Calder & D.B.O. Savile 10837 (C) LM silde no. 21.151, SEM stub no. 233

Subfamily Harrimanelloideae Kron & Judd

- Harrimanella stelleriana* (Pall.) Cov. Japan: Hokkaido, Daisetsu, Mt. Ashi-dake, Sugatamino-ike, alt. 1600 – 1700m, 20.06.1982 H. Takahashi 2513 (SAPS) LM silde no. 21.080, SEM stub no. 176

Subfamily Vaccinioideae Am.

Tribe Andromedeae Klotzsch

- Andromeda polifolia* L. Sweden: Torne lappmark, Abisco, S of Abisco ö station, 19.07.1989. H. Takahashi 9889 (SAPS) LM silde no. 20.964, SEM stub no. 147
- Canada: Port Radium, Great Bear Lake, NWT. 01.07.1965. L. Johnson s.n. (C) LM silde no. 21.183, SEM stub no. 147a
- Japan: Hokkaido, Kushiro-sicho, Kushiro-sitsugen, 17.06.1989. H. Takahashi & Y. Fujita 9753 (SAPS) LM silde no. 21.089, SEM stub no. 147b
- A. polifolia* L. var. *glaucophylla* (Link) DC. USA: Wisconsin, Rusk Co., bog on south edge of two bear Lake, 22.05.1971. M.R. Moore s.n. (C) LM silde no. 21.182, SEM stub no. 146
- Zenobia pulverulenta* (Bart.) Pollard. USA: North Carolina, Robeson Co., Pocosin 4 miles SSW of St. Pauls along Co. 1763, 23.05.1965. R.F. Britt 3109 (C) LM silde no. 21.143, SEM stub no. 150

Tribe Gaultherieae Nied.

- Chamaedaphne calyculata* (L.) Moench. USA: Connecticut, Litchfield Co., Norfolk, Canaan Mt. 09.05.1983. S. DiSimone et al. 6910 (SAPT) LM silde no. 21.064, SEM stub no. 151
- Japan: Hokkaido, Kushiro-sicho, Kushiro-sitsugen, 17.06.1989. H. Takahashi & Y. Fujita 9755 (SAPS) LM silde no. 21.090, SEM stub no. 151a
- Diplycosia heterophylla* Bl. Indonesia: Java, Papandajan, 2000m, no day.03.1930. G. Kjellberg s.n. (S) LM silde no. 21.013, SEM stub no. 173
- Gaultheria adenostrix* (Miq.) Maxim. Japan: Hokkaido, Mt. Yubari-dake, E side of Maedake to Ikoino-sawa, 29.07.1987. H. Takahashi et al. 7574 (SAPS) LM silde no. 21.065, SEM stub no. 154
- G. anastomosans* (L.F.) H.B.K. Colombia: Eastern Cordillera, Dept. Statander, Pardo Rico, near Vetas, 18.01.1927. E.P. Killip & A.C. Smith 17683 (S) LM silde no. 21.107, SEM stub no. 155

- G. appressa* A.W. Hill Australia: N.S.W., 25 miles south of Oberon, Werong Range, Mount Werong. 26.11.1962. E.F. Constable 4081 (S) LM silde no. 21.057, SEM stub no. 156
- G. bracteata* (Cav.) G. Don. Peru: Dep. Huánuco, Prov. Pachitea, Pano, Bushy slope, alt. 2500m, 11.09.1940. E. Asplund 13613 (S) LM silde no. 21.106, SEM stub no. 157
- G. buxifolia* Willd. Colombia: Piendamor, alt. 1700m, 11.04.1939. A.H.G. Alston 7959 (S) LM silde no. 21.105, SEM stub no. 158
- G. erecta* Ventenat Mexico: State of Puebla, Pine forests near Honey Station, 22.04.1904. C.G. Pringle 8896 (S) LM silde no. 21.058, SEM stub no. 162
- G. eriophylla* (Pers.) Sleum. ex Burt var. *eriophylla* Brazil: Itatinga, alt. 1850m, 21.05.1902. P. Dusén 57 (S) LM silde no. 21.104, SEM stub no. 159
- G. foliolosa* Benth. Ecuador: Zamora-Chinchi, Nudo de Sabanilla, on road Yangana-Valladolid, 04.04.1985. G. Harling & L. Andersson 23657 (GB) LM silde no. 21.224, SEM stub no. 160
- G. gracilis* Small Costa Rica: Prov. San José and Cartago, about 22km SE of Empalme, 27.11.1969. W.C. Burger & R.L. Leisner 6470 (S) LM silde no. 21.103, SEM stub no. 161
- G. insane* (Molina) Middleton Chile: Prov. Concepcion, Talcahuano, 17.10.1921. A. Valentin n.s. (S) LM silde no. 21.039, SEM stub no. 168
- G. itatiaiae* Wawra Brazil: Est. Paraná, Mun. Morretes, Pico Olimpo, alt. 1547m, 15.01.1950. G. Hatschbach 1756 (S) LM silde no. 21.102, SEM stub no. 163
- G. itoana* Hayata Taiwan: Kaohsiung Co., Taoyuan-hsiang, Mt. Hsitou-shan, alt. ca. 2800m, 11.05.1984. H. Idzumi s.n. (TUS 106429) SEM stub no. 269a
- G. miqueliana* Takeda Japan: Honshu, Fukusima Pref., Mt. Bandaisan, East slop, Numanodaira, alt. 1390m, 08.07.1985. Y. Endo et al. 2505 (SAPT) LM silde no. 21.075, SEM stub no. 164
- G. myrtilloides* Cham. & Schl. var. *myrtilloides* Argentina: Gob. Neuquén, Ladera Co., Belveder, alt. 1500m, 15.01.1947. R. de Barba 1639 (S) LM silde no. 21.100, SEM stub no. 169
- G. oppositifolia* Hook.f. New Zealand: N.J. Rotorna District, Maunga Kakaramea, 21.10.1938. C. Skottsberg s.n. (GB) LM silde no. 21.214, SEM stub no. 165
- G. procumbens* L. USA: Shelburne, n.b., no day.07.1887. K. Miyabe s.n. (SAPS) SEM stub no. 269
- G. prostrata* W.W. Smith Mexico: Pineland 4 miles below (west of) Paso de Cortez, 16.06.1962. G.L. Webster, W.P. Adams, Kim & Lillian Miller 11395 (S) LM silde no. 21.045, SEM stub no. 170
- G. rigida* H.B.K. Chile: Juan Fernandez Islands, Mas Atierra, alt. 1000ft., 09.12.1965. F.G. Meyer 9490 (S) LM silde no. 21.115, SEM stub no. 171
- G. shallon* Pursh USA: Wiener, Jackson Co., Oregon, 29.05.1892. E.W. Hammond 264 (SAPS) SEM stub no. 165a
- G. tomentosa* H.B.K. Ecuador: Canar, Road Taday-Azogues, paramo and mountain scrub, 04.11.1977. G. Harling, U. Eliasson & L. Andersson 14981 (GB) LM silde no. 21.189, SEM stub no. 166
- G. vaccinoides* Weddel Peru: Dep Huáncó, Prov. Huáncó, Carpis, open slop, alt. 2850m, 06.08.1940. E. Asplund 12874 (S) LM silde no. 21.101, SEM stub no. 167
- Leucothoe grayana* Maxim. var. *oblongifolia* (Miq.) Ohwi Japan: Prov. Mutsu, Shimokita pen., 28.06.1978. H. Takahashi 165 (SAPS) LM silde no. 21.072, SEM stub no. 153
- L. keiskei* Miq. Japan: Wakayama Pref., Mt. Nachi, (Ex Herb. J. O.), 29.07.1883. J. Ohwi s.n. (SAPS) LM silde & SEM stub no. 41

Tepuia venusta Camp. Venezuela: Bolivar, Parq. Nac Canaima, Auyantepui, 1829m alt., 18.02.1984. J.L. Luteyn & J. A. Steyermark 9578 (GB) LM silde no. 21.173, SEM stub no. 172

Tribe Lyonieae Kron & Judd

Agarista chlorantha (Cham.) G. Don. Brazil: Rio Jeronimo (mm. s. Jeronimo de Serra) Parana, 26.09.1970. G. Hatschbach & O. Guimaraes 24777 (C) LM silde no. 21.181, SEM stub no. 131

Parana, Pinhaes, in Compo., 14.10.1914. G. Jonsson 1398a (S) LM silde no. 20.998, SEM stub no. 131a

A. coriifolia (Thunb.) Hook.f. var. *coriifolia* Brazil: Serra de Cipo, Vermelhas, 05.09.1952. A. Macedo 3757 (S) LM silde no. 21.099, SEM stub no. 132

A. eucalyptoides (Cham. & Schlecht.) G. Don. Brazil: Serra de Itatiaia, in compo, alt. 2100m, 18.10.1903. P. Dusen 2011 (S) LM silde no. 21.098, SEM stub no. 133

Minas Gerais, Rod. Guinda-Cons. Mata, km 17 (mun. Diamantina), 14.03.1982. G. Hatschbach 44720 (GB) LM silde no. 21.188, SEM stub no. 152

A. populifolia (Lam.) Judd USA: North Carolina, Buncombe Co. (cult. from plants coll. at Jacksonville, Florida), 11.06.1898. Biltmore Herbarium 2656a (S) LM silde no. 21.097, SEM stub no. 134

A. salicifolia (Comm. ex Lam.) G. Don Tanzania: Strogabiet des oberen Ruhudje, Landschaft Lupembe, nördlich des Flusses, no date.1931. H.J. Schlieben 1160A (S) LM silde no. 21.059, SEM stub no. 149

Madagascar: Antananarivo Prov., Antananarivo, Parc de Isimbazaza 180 55' S; 470 31' E, cultivated, 21.10.1984. L.J. Dorr & L.C. Barnett 3156 (S) LM silde no. 21.062, SEM stub no. 148

Craibiodendron yunnanensis W.W. Sm. China: Flanks of volcanic mountain, NW of Tengyueh, alt. 7000ft, no day.06.1912. G. Forrest 8218 (S) LM silde no. 21.009, SEM stub no. 135

Lyonia buchii Urban Haiti: Massif de la Selle, Foureg. Alt.1450m, 13.02.1925. E.L. Ekman (Pl. Idn. Occ. 3236) (S) LM silde no. 21.096, SEM stub no. 136

L. ferruginea (Walter) Nuttall USA: Jacksonville, Florida, 01.04.1885. C.E. Faxon s.n. (SAPS) SEM stub no. 146a

L. jamaicensis (Swartz) D. Don Jamaica: Blue Mountains, 12.06.1894. W. Harris s.n. (S) LM silde no. 21.094, SEM stub no. 137

L. ligustrina DC. USA: Connecticut, Litchfield Co., Sharon, Miles Wildlife Sanctuary, 24.06.1983. S. DeSimone 420 (SAPT) LM silde no. 21.066, SEM stub no. 138

L. lucida (Lam.) K. Koch Cuba: Isla de Pinos, Los Fridios, 08.11.1920. E.L. Ekman 12150 (S) LM silde no. 20.991, SEM stub no. 139

L. macrophylla (Britton) Ekman ex Urban Cuba: Prov. Orienta, Sierra de Nipe, alt. 725m, 11.07.1919. E.L. Ekman (Pl. It. Reg. 9702) (S) LM silde no. 21.093, SEM stub no. 140

L. ovalifolia (Wall.) Drude var. *elliptica* (Sieb. & Zucc.) Hand-Mazz. Japan: Shikoku, Kagawa Pref., Ohkawagun, 01.06.1984. M. Takahashi 1887 (SAPT) LM silde no. 21.073, SEM stub no. 142

Miyagi Pref., Miyagi-machi, Yoshinari, alt. ca. 180m, 08.06.1982. A. Takehara 1486 (TUS 74434) SEM stub no. 142a

Pieris cubensis (Greseb.) Small Cuba: Prov. Pinar del Rio, Sierra de los Organos, 31.03.1923. E.L. Ekman (Pl. Ind. Occ. 16387) (S) LM silde no. 21.095, SEM stub no. 143

P. floribunda (Pursh) B. & H. USA: West Virginia, Pendleton Co., 19.05.1979. D.E. Boufford & E.W. Wood 21058 (TUS 90950) LM silde & SEM stub no. 268

No locality, (Herb. Arbor. Harvard University), no date, Unknown s.n. (SAPS) SEM stub no. 146b

- P. formosa* (Wallich) D. Don China: Yunnan, Pai-ching, 13.04.1936. (Ex Herb. Hort. Bot. Reg. Edin.) McLaren 32F (KYO) LM silde & SEM stub no. 175
- P. japonica* (Thunb.) D. Don Japan: Prov. Tokyo, Koishikawa Botanical Garden, cultivated, petal pink, 23.03.1980. H. Takahashi 457 (SAPS) LM silde no. 21.240, SEM stub no. 144
Taiwan: Prov. Taichû, Kantojum, 20.11.1931 Sasao s.n. (SAPS) LM silde & SEM stub no. 175
- P. koidzumiana* Ohwi Japan: Okinawa Islands, Kunigami, Hendona, no date. Sonohara 10 (KYO) LM silde & SEM stub no. 267
- P. nana* (Maxim.) Makino Japan: Honshu, Rikutyu, Mt. Hayatine, 19.06.1932. Fukuda 180,181 (KYO) LM silde & SEM stub no. 266
Hokkaido, Prov. Kitami, Monbetsu-gun, Shirataki-mura, Mt. Taira-yama, alt. 1770m, 29.06.1982. Takahashi et al. 2571 (SAPS) LM slide & SEM stub no. 266a
- P. phillyreifolia* (Hook.) DC. USA: Georgia, Charlton Co., Okefenokee National Wildlife Refuge, 13.09.1982. L. Newcombe 267 (SAPT) LM silde no. 21.239, SEM stub no. 145

Tribe Oxydendreae Cox

- Oxydendrum arboreum* DC. USA: WN Carolina, Caldwell Co., the eastern slopes of Blowing Rock Mountain, 31.07.1891. J.K. Small & A.A. Heller 113 (S) LM silde no. 21.055, SEM stub no. 141

Tribe Vaccinieae Rchb.

- Agapetes bracteata* Hook.f. Thailand: Khao Khio ridge, alt. 1300 m, 08.03.1964, B. Hanseen, G. Seidenfaden & T. Smitinad 11367 (C) LM silde no. 21.179, SEM stub no. 71
- A. lobbii* Clarke Thailand: Phu (Mt) Luang, Sandstone plateau with grassy swards and scattered tree groups, alt. 1300 m, 08.01.1966, E. Hennipman 3557 (C) LM silde no. 21.180, SEM stub no. 72
- A. oblonga* Craib. NE Burma: Kambaiti (73 km E of Myitkyina), alt. 2,100 m, 02.04.1934, R. Malaise s.n. (S) LM silde no. 21.012, SEM stub no. 73
- Anthopterus verticillatus* Luteyn Ecuador: Prov. Pichinca, Campamento Siglal between San Juan and Chiriboga, cliff, 2300m alt. 20.01.1965. E. Asplund 19042 (S) LM silde no. 21.111, SEM stub no. 276
- Cavendishia adenophora* Mansf. Colombia: Valle del Cauca, Alto Anchicaya, S of Campamentos de Yatacue (CVC), 04.03.1988. R. Ericsson & J. Kundsén 95 (GB) LM silde no. 21.230, SEM stub no. 74
- C. bracteata* (R. & P.) Hoerold Peru: Maria del Valle, about 7000ft, 30.04.1923. J.F. Macbride 3558(S) LM silde no. 20.995, SEM stub no. 75
- C. capitulata* D. Smith Costa Rica, Vicinity of Vara Blanca, N slope of Central Cordillera, alt. 1880m, June, 1938. A.F. Skutch 3790 (S) LM silde no. 21.123, SEM stub no. 76
- C. divaricata* A.C. Smith Colombia: Distr. Cauca, ad pag. El Tambo, alt. 2000m, 10.01.1935. K. von Sneidern 268 (S) LM silde no. 21.122, SEM stub no. 77
- C. isernii* Sleumer var. *pseudospicata* (Sleumer) Luteyn Ecuador: Pastaza, Mera, 1100m alt. 22.04.1969. Houguer Lugo S. 1163 (GB) LM silde no. 21.229, SEM stub no. 78
- C. marginata* A.C. Smith Colombia: Distr. Cauca, ad pag. El Tambo, La Costa, alt. 2300m, 01.08.1936. K. von Sleidern 938 (S) LM silde no. 21.121, SEM stub no. 79
- C. pubescens* (H.B.K.) Hemsl. Colombia: Dep. Tolima, Toche, alt.2200m. 27.04.1942. K. von Sleidern 3317 (S) LM silde no. 21.120, SEM stub no. 80
- C. tarapotana* Benth. & Hook.f. var. *gilgiana* (Hoer.) Luteyn Peru: Dep. San Martin, Roque, 04.07.1925. D. Melin 221 (S) LM silde no. 21.119, SEM stub no. 81

- Ceratostema lanigerum* (Sleum.) Luteyn Ecuador: Prov. Napo-Pastaza, Mera, in rastrijo, alt. 1100m.
21.12.1955. E. Asplund 18937 (S) LM silde no. 20.989, SEM stub no. 82
- C. loranthiflorum* Benth. Ecuador: Prov. Loja, Cerro Villonaco, 20 km to Catomyo, 2600m alt. 22.05.1967. B. Sparre 16627 (S) LM silde no. 21.138, SEM stub no. 83
- Costera endertii* J.J. Smith Indonesia: Sabah, no day.2/3.1980. Argent Acc. No. 801197 P10 (E 00212345)
LM silde & SEM stub no. 291
- Demosthenesia mandonii* (Britton.) A.C. Smith Bolivia: A Miquel Bang Lectae, Ex Herbario Collegii
Columbiae, no date. Britton & H.H. Rusby distributae 1939 (S) LM silde no. 21.134, SEM stub no. 84
- D. weberbaueri* Sleum. Peru: Dept. Ayacucho, 33-36 km NNE of Tambo, vicinity of Pantes, 33353m alt.
02.12.1978. J.L. Luteyn 6349 (GB) LM silde no. 21.228, SEM stub no. 85
- Dimorphanthera collinsii* Sleum. var. *montis-wilhelmi* Sleum. New Guinea: Western Highlands, Kubor Range,
Nona-Minj Divide, 25.06.1963. W. Vink 16003 (C) LM silde no. 21.160, SEM stub no. 86
- D. leucostoma* Sleum. New Guinea: Eastern Highl. Distr. Mt. Wilhelm, alt. 3300m, 20.05.1965. M.M.J.V.
Balgooy 403 (C) LM silde no. 21.159, SEM stub no. 87
- D. microphylla* Sleum. New Guinea: Eastern Highl. Distr. Mt. Wilhelm, alt. 3400m, 12.05.1965. M.M.J.V.
Balgooy 315 (C) LM silde no. 21.158, SEM stub no. 88
- Diogenesia floribunda* (A.C. Smith) Sleum. Ecuador: Prov. Napo-Pastaza, Baeza-Tena road, 2030-2175m alt.
06.04.1978. J.L. Luteyn & M. Lebron-Luteyn 5675 (GB) LM silde no. 21.226
- D. octandra* Sleum. Colombia: Prov. Cauca, Munchique, in silva, 3000m alt. 25.09.1939. K. von Sneidern
2481 (S) LM silde no. 21.132
- Disterigma acuminatum* (H.B.K.) Nied. Peru: Depto. San Martin, Huallaga, valley of Rio Apisoncho,
07.08.1965. A.C. Hamilton & P.M. Holligan 1120 (S) LM silde no. 21.129, SEM stub no. 89
- D. alaternoides* (H.B.K.) Nied. Colombia: Prov. Huila, La Plata, in silva. 3000m, 29.03.1939. K. von Sneidern
2501 (S) LM silde no. 21.036, SEM stub no. 90
- D. emperifolium* (H.B.K.) Drude Colombia: Dep. Cundinamaoca Fundort, alt. 3200 – 3500m, 06.08.1949. M.
Schneider 861 (S) LM silde no. 21.128, SEM stub no. 91
- D. humboldtii* (KI) Nied. Costa Rica: Vara Blanca de Sarapiqui, N slop of Central Cardillera, alt. 1500-1700m,
no day.07-09.1937. A.T. Skutch 3245 (S) LM silde no. 21.127, SEM stub no. 92
- D. popenoei* Blake Ecuador: Prov. Napo, Cartagena, alt. 2800m, 08.04.1979. B. Lojtnant, U. Molau & M.
Madison 11985 (GB) LM silde no. 21.225, SEM stub no. 93
- Gaylussacia amoena* Cham. Brazil: Serra do Itaiiaia, alt. 1850m, 20.10.1903. P. Dusen s.n. (S) LM silde no.
21.113, SEM stub no. 95
- G. baccata* (Wang) K. Koch USA: South Carolina, Greenville Co. Oak woods. 27.04.1967. C.L. Rogers & N.
Mullens 67033 (S) LM silde no. 21.017, SEM stub no. 96
- G. brasiliensis* (Spr.) Meissn. Brazil: Sta Catarina, in sumo monte Cambirela pr. Florianopolis, 18.07.1951. B.
Rambo 50350 (S) LM silde no. 21.038, SEM stub no. 97
- G. dumosa* (Andr.) T. & G. USA: No locality, (Herb. Arbor. Harvard University), no date, Unknown s.n.
(SAPS) SEM stub no. 43
- G. reticulata* Mart. Brazil: Minas Gerais, Serra do Espinhaco, ca 27 km N of Serro on road (MG2) to
Diamantina, alt. 1200m, 26.02.1968. H.S. Irwin et al. 20939 (S) LM silde no. 21.110, SEM stub no. 98

- G. virgata* Mart. var. *virgata* Brazil: Minas Gerais, Serra do Espinhaco, (mun. Diamantina), 8.09.1971. G. Hatschbach 27485 (S) LM silde no. 21.109, SEM stub no. 99
- Gonocalyx smilacifolius* (Griseb.) A.C. Sm. West Indies: Dominica, 20.01.1966. Chambers 2606 (E 00212346) LM silde & SEM stub no. 292
- Macleania bullata* P.F. Yeo. Ecuador: Prov. Pichinca, road from Quito to Puerto Quito, between Nono and Tandayapa, 15.11.1974. Plowman & E.W. Davis 4437 (S) LM silde no. 21.140, SEM stub no. 107
- M. crassa* A.C. Smith Colombia: Distr. Cauca, ad pag. El Tambo, alt. 2500m, 25.03.1938. K. von Sneidern 1655 (S) LM silde no. 21.126, SEM stub no. 108
- M. farinosa* Mansf. Ecuador: Zamora-Chinchipe, above Valladolid on road to Yangata, alt. 2700m, 02.02.1985. G. Harling & L. Anderson 21448 (GB) LM silde no. 21.187, SEM stub no. 109
- M. portmanii* Drake. Ecuador: Loja - Zamora / Chinchipe border area, alt. 2500 - 2700m, 31.12.1978. J.L. Luteyn, M. Labron-Luteyn & B. Mcalpin 6540 (GB) LM silde no. 21.169, SEM stub no. 110
- M. rupestris* (HBK) A.C. Smith Colombia: Purace, Km. 12, 2850m, 17.04.1939. A.H.G. Alston 8112 (S) LM silde no. 20.993, SEM stub no. 111
- M. stricta* A.C. Smith Colombia: Dep. Narino, Ricáyrte, alt. 1300m, 12.04.1941. K. von Sneidern A565 (S) LM silde no. 21.125, SEM stub no. 94
- Notopora schomburgkii* Hook. f. Venezuela: Edo. Bolivar, Gran. Sabana, alt.1280m, 17.11.1978. J.L. Luteyn, M. Labron-Luteyn & J.A. Steyermark 6286 (GB) LM silde no. 21.170, SEM stub no. 112
- Orthaea abbreviata* Drake. Ecuador: Zamora-Chinchipe, above Valladolid on road to Yangana, alt. 2300m, 01.02.1985. G. Harling & L. Anderson 21371 (GB) LM silde no. 21.171, SEM stub no. 100
- O. secundiflora* (P. & E.) KI. Ecuador: Loja, Km marker 10 E Loja towards Zamora, alt. 240m, 28.01.1985. J.L. Luteyn & E. Cotton 11302 (S) LM silde no. 20.990, SEM stub no. 101
- Pellegrinia harmisiana* (Hoer.) Sleum. Peru: Dep. Huanuco, Carpish, open slope, alt. 2850m, 15.08.1940. E. Asplund 13074 (S) LM silde no. 6817, SEM stub no. 277
- Plutarchia guascensis* (Cuatr.) A.C. Smith Colombia: Paramo of Guasca, Dept of Cunainamarca, alt. 3100m, 21.03.1948. O. Haight 6228 (S) LM silde no. 20.998, SEM stub no. 113
- P. rigida* (Benth.) A.C. Smith Colombia: deistr. Cauca, Cordillera Cenral, Purace, in paramo, alt. 4000m, 20.02.1938. K. von Sneidern 1867 (S) LM silde no. 21.112, SEM stub no. 114
- Psammisia ecuadorensis* Hoer. Ecuador: Prov. Pichincha, road Chillogallo – Chiriboga, alt. 160 – 200m, 12.06.1967. B. Sparre. 17009 (S) LM silde no. 21.136, SEM stub no. 115
- P. ferruginea* A.C. Smith Colombia: Dep. Valle, Espinal., alt. 1000m, 27.06.1945. K. von Sneidern 4448 (S) LM silde no. 21.118, SEM stub no. 278
- P. sodiroi* Hoerold. Ecuador: Prov. Napo Pastaza, Borja (Virgillo Davila), alt. 650m. 15-26.01.1959. G. Harling 3850 (S) LM silde no. 21.137, SEM stub no. 116
- Satyria leucostoma* Sleum. Ecuador: Prov. Napo-Pastaza, Mera, alt.1100m, climbing epiphyte shrub, 12.12.1955. E. Asplund 18814 (S) LM silde no. 21.227, SEM stub no. 118
- S. panurensis* (Benth.) B. & H. British Guiana: Basin of Essequibo river, near mouth of Onoro Creek, lat. about 10 35` N, 15-24.02.1937. A.C. Smith 2798 (S) LM silde no. 21.035, SEM stub no. 121
- S. pilosa* A.C. Smith Colombia: Choco, Carmen del Atrato-Quibdord, 7 – 11km W of El Siete, alt. 950 – 1500m, 26.05.1988. J.L. Luteyn & J. Roldan 12440 (GB) LM silde no. 21.172, SEM stub no. 119

- S. warszewiczii* Kl. Costa Rica: Vara Blanca de Sarapiquí, N slope of Central Cordillera, between Poas and Barba volcanoes, no day.01.1938. A.F. Skutch 3410 (S) LM silde no. 21.133, SEM stub no. 120
- Siphonandra elliptica* (R. et. P.) Kl. Peru: Paso de Tres Cruces, Cerro de Cusilluyoc, alt. 3800-3900m, 03.05.1925. F.W. Pennell 13857 (S) LM silde no. 21.034, SEM stub no. 122
- Sphyrospermum boekii* Luteyn Ecuador: Prov. Carchi, road Tulcan – Maldonado, ca. 10 km from Maldonado, 05.08.1976. Ollgaard & H. Balslev 8481 (S) LM silde no. 21.139, SEM stub no. 123
- S. buxifolium* P. & E. Peru: Dep. Huanuco, Prov. Huanuco, Tingo Maria, forest, 24.07.1940. E. Asplund 12493 (S) LM silde no. 20.992, SEM stub no. 124
- Themistoclesia anfracia* (A.C.Sm.) Sleum. Colombia: Prov. Cauca, Puracé, alt. 3400m, 29.03.1939. K. von Sneidern 2493 (S) LM silde no. 21.124, SEM stub no. 125
- T. cutucuensis* A.C. Smith Ecuador: Morona-Santiago, 2-4 km N of Arapicos, alt. 800-900m, 04.04.1981. L.S. Holguer 5960 (S) LM silde no. 21.092, SEM stub no. 126
- T. epiphytica* A.C. Smith Ecuador: Prov. Zamora Chinchipe, alt. 2500m, 06.05.1987. H. van der Werff & W. Palacios 9371 (GB) LM silde no. 21.174, SEM stub no. 127
- T. mucronata* (Benth.) Slum. Colombia: Prov. Cauca, Purace, in silvula, alt. 3450m, 02.04.1939. K. von Sneidern 2511 (S) LM silde no. 20.994, SEM stub no. 128
- Thibaudia albiflora* A.C. Smith Ecuador: Pichincha, Reserva Endesa, alt. 800m, 25.03.1985. G. Harling & L. Anderson 23307 (GB) LM silde no. 21.175, SEM stub no. 102
- T. angustifolia* Hook. Peru: Departamento de Amazonas, Proviincia de Bongara, Jalca zone, 3 km S of Pomacocha, alt. 2400m, 20.06.1962. J.J. Wurdack 983 (S) LM silde no. 21.1116, SEM stub no. 103
- T. domingensis* Urb. Haiti: Massif de la Selle, alt. 1900m, 28.01.1925. E.L. Ekman 32125 (S) LM silde no. 21.117, SEM stub no. 104
- T. floribunda* H.B.K. Colombia: Purace, 3000m alt. 17.04.1939. A.H.G. Alston 8103 (S) LM silde no. 21.033, SEM stub no. 105
- T. parvifolia* (Benth.) Hoerold. Colombia: distr. Cauca, Cordillera Central, Purace, in peramo, alt. 3450m, no day.02.1938. K. von Sneidern 1864 (S) LM silde no. 21.135, SEM stub no. 106
- Ecuador: Carchi, Road Tulcan – El Carmelo (El Pun.) 3100-3200m alt. 26.11.1974. G. Harling & L. Anderson 12242 (S) LM silde no. 21.176, SEM stub no. 106a
- Vaccinium angustifolium* Ait. USA: Wisconsin, Columbia Co., on the edge of sand prairie, 10.05.1960. Laferriere 233 (SAPS) LM silde & SEM stub no. 25
- V. bracteatum* Th. Japan: Nagasaki Pref., Nagasaki-shi, Mt. Inasa-yama. 13.07.1896. Oka s.n. (SAPS) LM silde & SEM stub no. 16
- V. caespitosum* Michx. USA: N. H., Mt. Washington, White Mountains, 08. 07.1895. Churchill s.n. (SAPS) LM silde & SEM stub no. 26
- V. calycinum* Sm. f. *glabreccens* Sk. USA: Hawaii, Kauai, Waimea, 29.10.1922. Skottsberg 1132 (GB) LM silde no. 21.212, SEM stub no. 46
- V. consanguineum* Kl. Panama: Prov. Chiriqui, forested ridges south of Finca Lerida, alt. 6000-7000 ft., 26.07.1947. Allen 4768 (S) LM silde no. 21.108, SEM stub no. 48
- V. corymbosum* L. USA: Georgia, Wayne Co. edge of Jessup, 27.03.1973. Meyer & Mazzeo 13278 (TUS 75346) LM silde & SEM stub no. 36

- V. corymbosum* L. USA: North Carolina, Transylvania Co., 09.05.1982 Spongberg & Boufford 1764 (TUS 117140) LM silde & SEM stub no. 31
Alabama, Sumter Co., ca. 1.0 mi W of US hwy 80 from junction US hwy 80 and ALA hwy 28, 23.03.1983. Utech, Ohara & Thompson 83-050 (TUS 96720) LM silde & SEM stub no. 35
- V. crassifolium* Andr. USA: South Carolina, Sumter Co., in open low moist, sandy, coastal plain, 21.04.1965. Iltis & Botany 16 23116 (KYO) LM silde & SEM stub no. 59
- V. cubense* (A. Rich.) Griseb. Cuba: Prov. Oriente, Sierra Maestra, 1725m., 07.04.1915. Ekman 5294 (S) LM silde no. 21.037, SEM stub no. 49
- V. donianum* Wight. Burma: West Central region, Southern Chin hills, Mt. Victoria region Mindat, alt. 4800 ft., 19.03.1956. Alsterlund 100 (GB) LM silde no. 21.194, SEM stub no. 50
- V. emarginatum* Hayata Taiwan: Pingtung Hsien, Wutai Hsiang, Wutoushan nature protected area, forest road to Chihpen, second. broadleaf forest, 23.04.1995. Wang 1022(KYO) LM silde & SEM stub no. 60
- V. floribundum* H.B.K. var. *floribundum* Colombia: Cundinamarca, Bogota, Paramo de Guerrero, alt. 3100 m., no day.05.1962. Larsson s.n. (S) LM silde no. 21.131, SEM stub no. 51
- V. hirsutum* Buckley USA: Tennessee, Polk Co. NE of the town of Parksville, alt. c. 750m, 16.05.1985. Boufford & Wood 23586 (TUS127189) LM silde & SEM stub no. 29
- V. hirtum* Thunb. Japan: Hokkaido, Kawakami-sicho, Kawakami-gun, Kawakami-cho, Asahidake spa, alt. 1080m, 15.07.1987. H. Takahashi 7153 (SAPS) LM silde & SEM stub no. 17
- V. japonicum* Miq. Japan: Hokkaido, Prov. Ishikari, Sapporo-shi, Jyozankei, between Shiraihutamata and Kumanosawa, alt. c. 400m, 26.07.1981. H. Takahashi 1544 (SAPS) LM silde & SEM stub no. 18
- V. leucanthum* Cham. & Schlecht. Mexico: Chapas, Sierra Madre de Chiapas, alt. 2500 m, 18.06.1985. J.L. Luteyn & Lebron-Luteyn 11574 (GB) LM silde no. 21.177, SEM stub no. 52
- V. macrocarpon* Ait. Canada: Quebecc, Gaspesie, Barrachois, 23.07.1961. Ernest & LeBlanc 61141 (GB) LM silde no. 21.193, SEM stub no. 53
- V. meridionale* Sw. Venezuela: Edo Tachira, Paramo de Portachuelo, alt 2860 m, 23.10.1978. J.L Luteyn 6031 (S) LM silde no. 21.130, SEM stub no. 54
- V. microcarpum* (Turcz.) Schmalh. Sweden: Torne Lappmark, Abisco, S of Abisco Ö station, alt. 400-500m, within moss on the heath, 19.07.1989. H. Takahashi 9873 (SAPS) SEM stub no. 39
- V. myrsinites* Lam. USA: Florida, Lee Co., Fort Myers, in dry sandy pineland. 12.04.1930. Moldenke 948 (GB) LM silde no. 21.192, SEM stub no. 55
- V. myrtilloides* Michx. USA: Maine, Washington Co., Columbia Falls, at the border of Jonesboro, 13.06.1938. Turesson & Alm 146 (GB) LM silde no. 21.200, SEM stub no. 47
- V. myrtillos* L. No locality, 06.05.1882. Willoline s.n. (SAPS) LM silde & SEM stub no. 27
- V. oldhamii* Miq. Japan: Hokkaido, Prov. Hidaka, lower elevation of Mt Apoi, alt. c.150m, 05.07.1978. H. Takahashi 232 (SAPS) LM silde & SEM stub no. 20
- V. ovalifolium* Sm. Japan: SW Hokkaido, between Shimamaki-mura and Setana-cho, Mt Kariba-yama, 05.07.2000. H. Takahashi, Yamazaki & Mochida 27579 (SAPS) LM silde & SEM stub no. 21
- V. ovatum* Pursh. USA: Contra Cota Co., north exposure of hills at head of San Leandro canyon, 25.03.1916. Unknown 26 (SAPS) LM silde & SEM stub no. 30
- V. oxycoccus* L. Japan: Teshio Prov. Teshio-gun, Horonobe-cho, Shimo-Sarobetsu moor, 25.06.1975. Furuse 8915 (TUS 112787) LM silde & SEM stub no. 37

- V. pallidum* Ait. USA: California, Norwich Co., no day, 05.1883. Setchell s.n. (SAPS) LM silde & SEM stub no. 33
- V. parvifolium* Sm. USA: Casade Mountain, upper valley of the Nesqually, 28.05.1894, 21.08.1894. Allen 71 (SAPS) LM silde & SEM stub no. 29
- V. praestans* Lamb. Japan: SW Hokkaido, between Shimamaki-mura and Setana-cho, Mt Kariba-yama, 05.07.2000. H. Takahashi, Yamazaki & Mochida 27575 (SAPS) LM silde & SEM stub no. 22
- V. randaiense* Hayata Taiwan: Baibara, 15.06.1925. Kikuchi s.n. (SAPS) LM silde & SEM stub no. 23
- V. scoparium* Leiberg Canada: Alberta, Mt. Redoubt, in timberline forest, alt. 6500ft., 4-14.07.1945. Porsild & Breitung 12504 (SAPS) LM silde & SEM stub no. 33
- V. smallii* A. Gray Japan: Hokkaido, Hiyama-sicho, Setana-gun, Imakane-cho, Mt Kanikan-dake, alt. 260-580m, 21.05.1998. H. Takahashi 24491 (SAPS) LM silde & SEM stub no. 24
Yamagata Pref., Nishimurayama-gun, Hongo-mura. 23.5.1932. Kikuchi s.n. (SAPS) LM silde & SEM stub no. 19
Hokkaido, Sapporo-shi, Hokkaido University, Botanic Garden, cult., 02.06.2004. Sarwar & Takahashi s.n. (SAPS)
- V. sprengelii* (Don.) Sleum. Thailand: Northern, 30 km S of Bo Luang along the Om Koi trail, 18⁰02' N, 98⁰24' E, 03.07. 1968. Larsen, Santisuk & Warncke 2016 (C) LM silde no. 21.145, SEM stub no. 56
- V. stamineum* L. North America: no locality (Herbarium of the Arboretum, Harvard Univ.), 07.06.1892. Unknown s.n. (SAPS) LM silde & SEM stub no. 34
- V. uliginosum* L. Sweden: Torne Lappmark, Abisco, S of Abisco Ö station, 19.07.1989. H. Takahashi 9864 (SAPS) LM silde no. 20.968, SEM stub no. 40
Torne Lappmark, Abisco, Mt. Njulla, 20.07.1989. H. Takahashi 9908 (SAPS) LM silde no. 21.088, SEM stub no. 57
- V. vacciniaceum* (Roxbgh.) Sleum. Eastern Nepal: near Marimajua, alt. 1650m, 23.04.1962. Nishioka 1211 (KYO) LM silde & SEM stub no. 61
- V. vitis-idaea* L. Sweden: Torne Lappmark, Abisco, S of Abisco Ö station, 19.07.1989. H. Takahashi 9856 (SAPS) LM silde no. 20.970, SEM stub no. 61
- V. wrightii* A. Gray Japan: Okinawa, Hachiyama, no day, 03.1888. Unknown s.n. (SAPS) LM silde & SEM stub no. 38
-

* Taxa with intermediate morphological characters.