

PRO-MED

Knochenchirurgie / Neurochirurgie / Mikrochirurgie

Bone Surgery / Neuro Surgery / Micro Surgery

Chirurgie osseuse / Neurochirurgie / Microchirurgie

Cirurgia osea / Neuro Cirugia / Micro Cirugia

PRO-MED**WA Distributor:**

MEDICAL

■ PHONE: 0423 178 332

■ FAX: 08- 9446 2637

SONITA MEDIC

SURGICAL

■ EMAIL: info@sonitamedic.com.au■ WEB: www.sonitamedic.com.au

SUPPLIES

■ POSTAL ADDRESS: P.O BOX 1289, Osborne Park Business Centre, Osborne Park, WA 6916

Garantierte Qualitätsinstrumente
Guaranteed Quality Instruments
Instruments de Chirurgie de qualité garantié
Instrumentos de Calidad con garantia

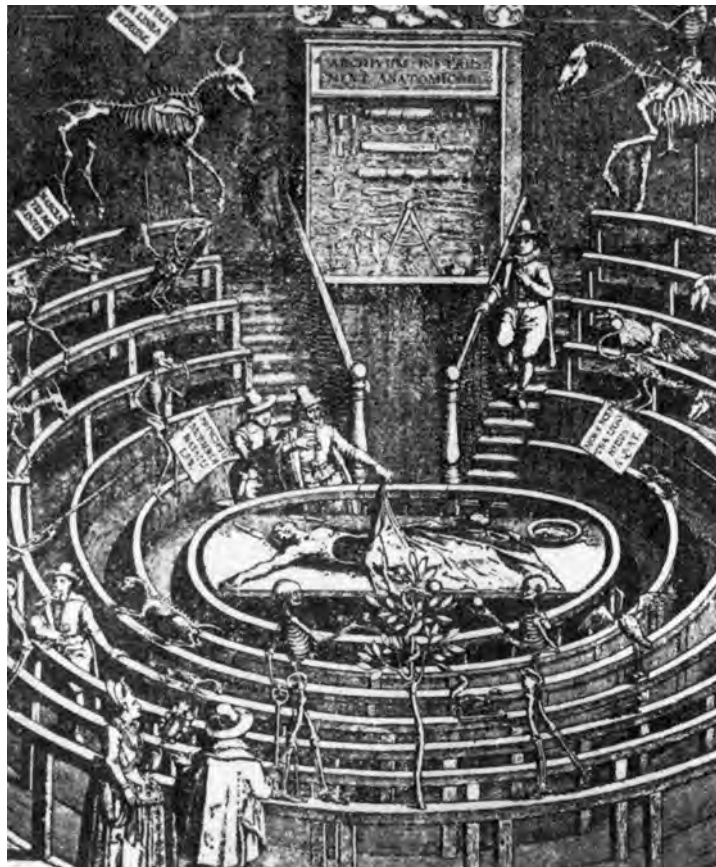

PRO-MED Instrumente GmbH
Gänsäcker 9
D-78532 TUTTLINGEN
Germany

Telephone +49(0) 74 62 / 20 42 40
Telefax +49(0) 74 62 / 20 42 49 0
E-Mail pro-med-tut@t-online.de
Internet www.pro-med-tut.de

PRO-MED

Qualität ist eine Frage des Anspruchs ...

Quality is a question of demand ...

La qualité est une question d'exigence ...

Calidad es la pregunta de pretension ...



1

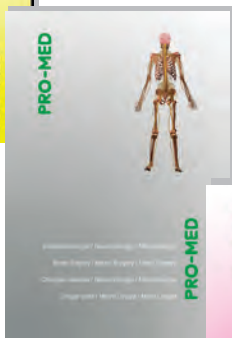

2

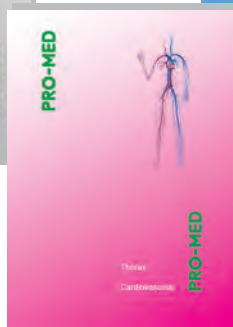

3



4

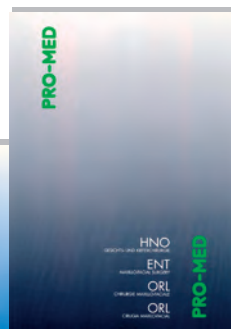

5

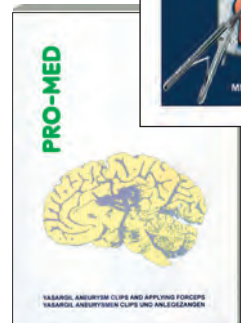

6



7

Catalogs

- 1 General Instruments
- 2 Bone Surgery / Neuro Surgery / Micro Surgery
- 3 Thorax / Cardiovascular
- 4 Stomach / Intestines / Rectum / Liver / Gall Kidneys / Urology / Gynecology / Obstetrics
- 5 ENT
- 6 Aneurysm Clips
- 7 MIC System

17	WUNDHAKEN RETRACTORS ECARTEURS SEPARADORES	7-16
17.5	WUNDSPERRER SELF-RETAINING RETRATORS ECARTEURS AUTOSTATIQUES SEPARADORES AUTOSTATICAS	17-24
22	AMPUTATION AMPUTATION AMPUTATION AMPUTACIÓN	25-26
23	<i>KNOCHENCHIRURGIE BONE SURGERY CHIRURGIE OSSEUSE CIRUGIA ÓSEA</i>	27-111
23	ELEVATORIEN, RASPATORIEN, DISSEKTOREN ELEVATORS, RASPATORIES, DISSECTORS ELEVATEURS, RUGINES, DISSECTEURS ELEVADORES, DISECADORES, PERIOSTÓTOMOS	27-39
23	FEILEN, RASPELN, STÖSSEL BONE FILES, RASPS, HEMOSTATS LIMES, RÂPES, BURINS À HÉMOSTASE LIMAS, ESCOFINAS, HEMOSTATICOS	40-42
23	SCHARFE LÖFFEL BONE CURETTES CURETTES TRANCHANTES CUCHARILLAS CORTANTES	43-49
23	HÄMMER MALLETS MAILLETS MARTILLOS Y MAZOS	50-54
23	MEISSEL, HOHLMEISSEL, OSTEOTOME CHISELS, GOUGES, OSTEOTOMES CISEAUX-BURINS, GOUGES, OSTÉOTOMES CINCELES, OSTEÓTOMOS, GUBIAS	55-66
23	KNOCHENHALTEZANGEN BONE HOLDING FORCEPS DAVIERS PINZAS PORTE-HUESOS	67-75
23	HOHLMEISSELZANGEN BONE RONGEURS PINCES-GOUGES PINZAS-GUBIAS	76-84
23	KNOCHENSPLITTERZANGEN BONE CUTTING FORCEPS PINCES COUPANTES POUR OS PINZAS CORTANTES PARA HUESOS	85-87

23	INSTRUMENTE FÜR FINGER- UND ZEHENNÄGEL NAIL INSTRUMENTS INSTRUMENTS À ONGLES INSTRUMENTOS PARA UÑAS	88-89
23	SEHNENINSTRUMENTE TENDON INSTRUMENTS INSTRUMENTS POUR TENDONS INSTRUMENTOS PARA TENDONES	90-91
23	MENISKUS INSTRUMENTE MENISCUS INSTRUMENTS INSTRUMENTS À MENISQUE INSTRUMENTOS PARA MENISCOS	92-95
23	CERCLAGE- UND DRAHT-INSTRUMENTE BONE WIRE- AND WIRE-CUTTING INSTRUMENTS CERCLAGE ET INSTRUMENTS HILOS Y INSTRUMENTOS PARA HILOS Y ALAMBRES	96-106
23	BOHRDRÄHTE, EXTENSION WIRE DRILLS, EXTENSION BOWS BROCHES, ETRIERS TALADROS FILIFORMES, EXTENSIÓN	106-108
23	BOHR-INSTRUMENTE BONE DRILLS PERFORATEURS PERFORADORES	109-111
24	<i>TRAUMATOLOGIE</i> <i>TRAUMATOLOGY</i> <i>TRAUMATOLOGIE</i> <i>TRAUMATOLOGÍA</i>	112-129
24	INSTRUMENTE FÜR MARKNAGELUNG INSTRUMENTS FOR INTRAMEDULLARY NAILS INSTRUMENTS POUR CLOUS INTRAMEDULLAIRES INSTRUMENTOS PARA CLAVOS INTRAMEDULARES	112-118
24	PLATTEN UND SCHRAUBEN, INSTRUMENTE BONE PLATES, SCREWS, AND INSTRUMENTS PLAQUES, VIS ET INSTRUMENTS PLACAS, TORNILLOS, Y INSTRUMENTOS	119-129
27	<i>NEUROCHIRURGIE</i> <i>NEUROSURGERY</i> <i>NEUROCHIRURGIE</i> <i>NEUROCIRUGIA</i>	130-188
27	SAUGROHRE SUCTION TIPS TUBES À ASPIRATION TUBOS DE ASPIRACIÓN	131-133
27	INSTRUMENTE ZUR SCHÄDELÖFFNUNG CRANIOTOMY INSTRUMENTS INSTRUMENTS POUR CRANIOTOMIE INSTRUMENTOS PARA ABERTURA CRANEANA	134-137

27	LEYLA RETRAKTOREN-SYSTEM LEYLA RETRACTOR SYSTEM ECARTEURS SYSTÈME LEYLA SEPARADORES SISTEMA LEYLA	138-140
27	DURAHAKEN, ELEVATOREN, MESSER, SPATELN KNIVES, ELEVATORS, DURA-HOOKS, SPATULAS COUTEAUS, ÉLÉVATEURS, CROCHETS, SPATULES BISTURIES, ELEVADORES, GANCHOS, etc.	140-152
27	WIRBELKÖRPERSPREIZER LAMINA SPREADERS ÉCARTEURS POUR CORPS VERTEBRAUX SEPARADORES PARA COURPOS VERTEBRALES	153-159
27	BANDSCHEIBENSTANZEN, LAMINEKTOMIEZANGEN INTERVERTEBRAL DISC- AND LAMINECTOMY RONGEURS RONGEURS À LAMES VERTEBRALE, PINCES À DISQUES PINZAS PARA DISCOS INTERVERTEBRALES Y LAMINECTOMIA	160-173
27	PINZETTEN FÜR NEUROCHIRURGIE NEUROSURGICAL FORCEPS PINCES POUR NEUROCHIRURGIE PINZAS PARA NEUROCIRUGIA	174
27	INSTRUMENTE FÜR HIRNHAUT INSTRUMENTS FOR BRAIN SUTURE INSTRUMENTS À SUTURE CÉRÉBRALE INSTRUMENTOS PARA SUTURA CEREBRAL	175-176
27	INSTRUMENTE FÜR LAMINEKTOMIE UND HEMILAMINEKTOMIE INSTRUMENTS FOR LAMINECTOMY AND HEMILAMINETOMY INSTRUMENTS POUR LAMINECTOMIE ET HEMILAMINECTOMIE INSTRUMENTOS PARA LAMINECTOMIA Y HEMILAMINECTOMIA	177-187
28	MIKROCHIRURGIE MICROSURGERY MIKROCHIRURGIE MICROCIRUGIA	189-263
28	MIKRO-PINZETTEN MICRO-DISSECTING FORCEPS MICRO-PINCES À DISSECTION MICRO-PINZAS DE DISECCIÓN	190-204
28	MIKRO-SCHEREN MICRO-SCISSORS MICRO-CISEAUX MICRO-TIJERAS	206-219. 236
28	MIKRO-NADELHALTER MICRO-NEEDLEHOLDERS MICRO-PORTE-AIGUILLES MICRO-PORTA-AGUJAS	219-234
28	HYPOPHYSEKTOMIE INSTRUMENTE PITUITARY INSTRUMENTS INSTRUMENTS POUR HYPOPHYSECTOMIE INSTRUMENTOS PARA LA HIPOFISECTOMÍA	235-236

28	MIKRO-INSTRUMENTE MICRO-INSTRUMENTS MICRO-INSTRUMENTS SUR MANCHE INSTRUMENTOS PARA MICROCIRUGIA	237-246
27,40	NEURO-MIKRO- UND MIKRO-GEFÄSSCHIRURGIE NEURO-MICRO- AND MICRO-VASCULAR SURGERY NEURO-MICROCHIRURGIE ET CHIRURGIE MICRO-VASCULAIRE NEURO-MICROCIRUGIA Y CIRUGIA MICRO-VASCULAR	247-261
28	KOPFLUPEN BINOCULAR LOUPES LOUPES BINOCULAIRES LUPAS BINOCULARES	261-263
	INHALTSVERZEICHNISSE INDEX INDEX INDICE	265-306



17.0721



17.0722



17.0723



17.0724



17.0726



17.0728

scharf / sharp / pointu / agudo



VOLKMANN
21,5 cm



17.0731



17.0732



17.0733



17.0734



17.0736



17.0738

stumpf / blunt / mousse / romo



17.0741



17.0742



17.0743



17.0744



17.0746



17.0748

halbscharf / semi-sharp / semi-pointu / semiagudo



17.0751



17.0752



17.0753



17.0754



17.0756



17.0758

scharf / sharp / pointu / agudo



KOCHER
22 cm



17.0761



17.0762



17.0763



17.0764



17.0766



17.0768

stumpf / blunt / mousse / romo



17.0771



17.0772



17.0773



17.0774



17.0776



17.0778

halbscharf / semi-sharp / semi-pointu / semiagudo

Knochenhaken
Bone Retractors
Ecarteurs pour os
Separadores para huesos



17.0780
25 cm



VOLKMANN
22 cm



17.0781



17.0784



MURPHY
19 cm



17.0822



17.0823



17.0824



17.0826

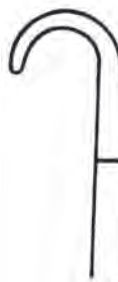

17.0832



17.0833



17.0834



17.0836



WASSMUND
17.0900 20 cm
33 x 20 mm



OLLIER
17.0912 22,5 cm
36 x 60 mm



17.0910
36 x 30 mm

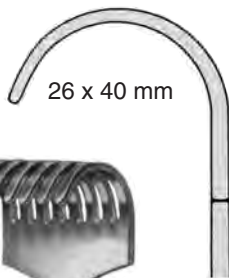

26 x 40 mm



KOERTE
17.0922 24 cm
stumpf
blunt
mousse
romo

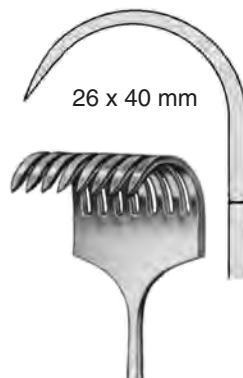

26 x 40 mm

17.0920
scharf
sharp
pointu
agudo



KOERTE
17.0925
23 cm
46 x 55 mm



ISRAEL
25 cm



17.0930
40 x 40 mm



17.0931
45 x 50 mm



17.0932
50 x 60 mm



17.0934
70 x 70 mm



KOCHER

21 cm

- 17.1011 25 x 6 mm
- 17.1012 35 x 8 mm
- 17.1013 35 x 11 mm
- 17.1014 35 x 15 mm
- 17.1015 40 x 11 mm
- 17.1016 55 x 11 mm
- 17.1017 70 x 14 mm
- 17.1018 80 x 12 mm
- 17.1019 80 x 16 mm



KOCHER

23 cm

- 17.1020 40 x 18 mm
- 17.1021 60 x 20 mm
- 17.1022 60 x 25 mm
- 17.1023 75 x 30 mm
- 17.1024 75 x 40 mm
- 17.1025 80 x 20 mm



LANGENBECK
17.1040 - 17.1045
22 cm



17.1040 30 x 11 mm
17.1050 30 x 11 mm



17.1043 40 x 11 mm
17.1053 40 x 11 mm



17.1041 30 x 14 mm
17.1051 30 x 14 mm



17.1044 40 x 15 mm
17.1054 40 x 15 mm



17.1042 30 x 16 mm
17.1052 30 x 16 mm



17.1045 50 x 11 mm
17.1055 50 x 11 mm



LANGENBECK
17.1050 - 17.1055
22 cm

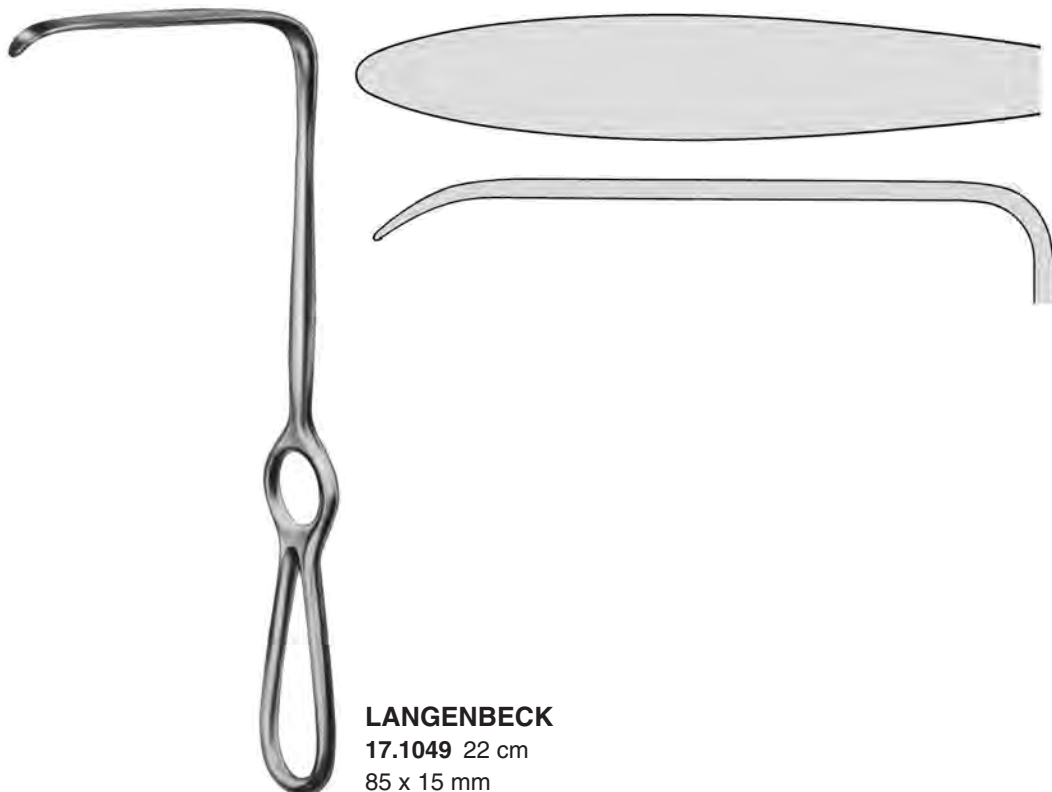

LANGENBECK
17.1049 22 cm
85 x 15 mm

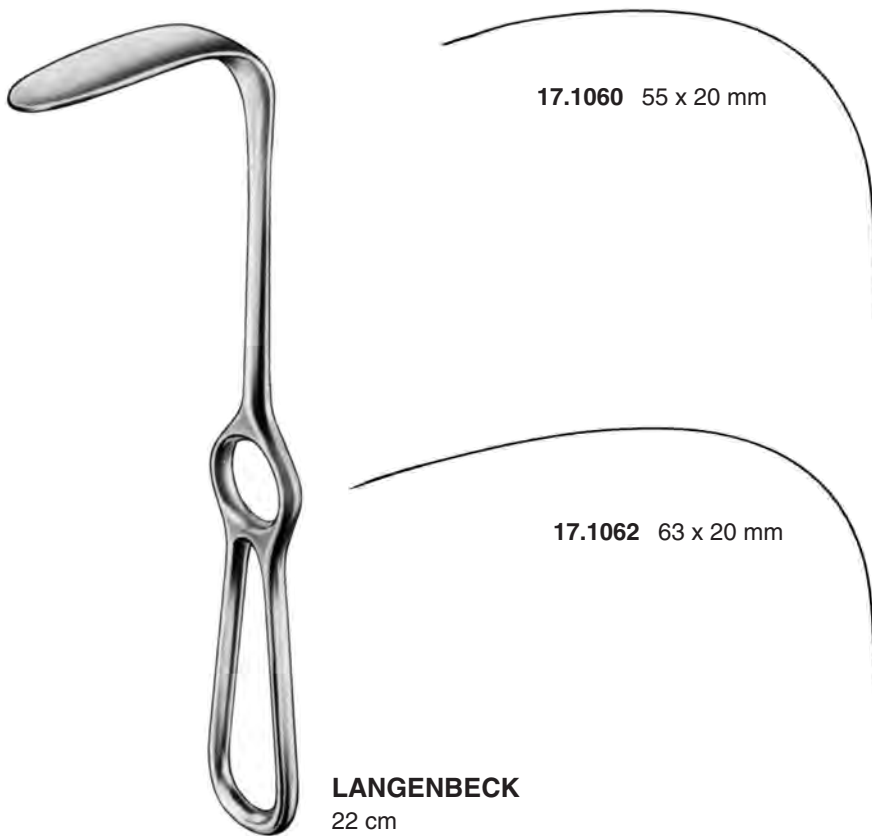



CASPAR
27.5222
20 cm



DOCKHORN
20 cm



34.4020
40 x 12 mm



34.4022
55 x 14 mm



MIDDELDORPF
22 cm
17.1080 16 x 17 mm
17.1081 20 x 22 mm
17.1082 26 x 30 mm



MIDDELDORPF
23 cm
17.1086 20 x 22 mm
17.1087 26 x 30 mm



GREEN
17.1088 22 cm

Knie-Wundhaken
 Retractors for knee
 Ecarteurs pour genou
 Separadores para rodilla



SMILLIE
 14 cm

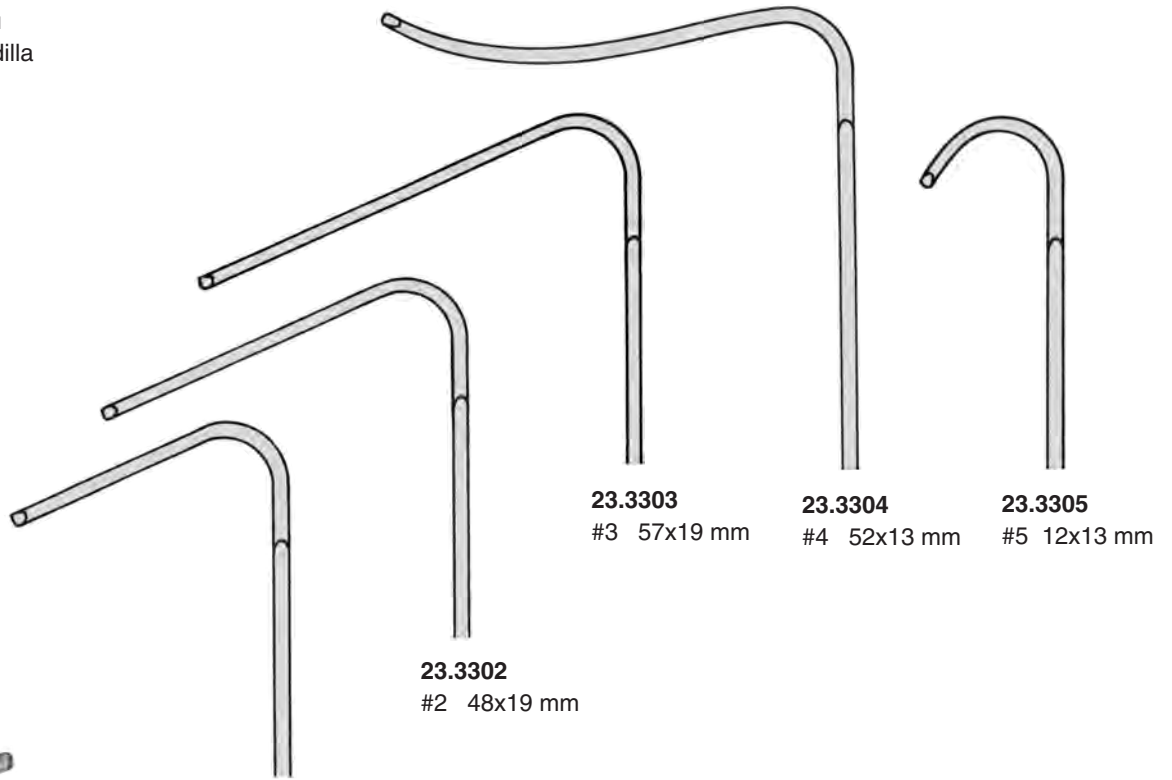

23.3301
 #1 32x19 mm

23.3302
 #2 48x19 mm

23.3303
 #3 57x19 mm

23.3304
 #4 52x13 mm

23.3305
 #5 12x13 mm



BLOUNT
 23.3310 18 cm



23.3312
 21 cm / 38 x 9 mm



MEYERDING
 17.1160 22 cm
 50 x 16 mm
 17.1162 22 cm
 75 x 25 cm
 17.1164 24 cm
 90 x 50 mm

geriefte Valven
Serrated blades
valves striées
valvas estriadas

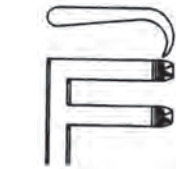

17.5206 13 cm



17.5207 13 cm

PLESTER



COX
17.5210
12 cm

für Finger und Zehen
Finger- and Toe Retractor
pour doigts et orteils
para dedos



SCALP-CONTOUR

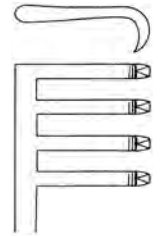

17.5224 14 cm

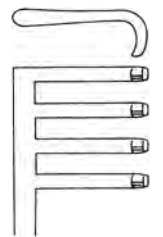

17.5225 14 cm



WEITLANER-BABY
17.5290 14 cm

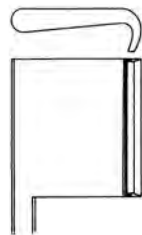

WEITLANER

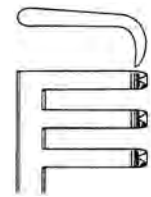

17.5300 10,5 cm

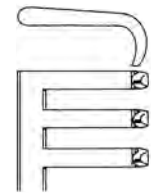

17.5301 10,5 cm



WEITLANER

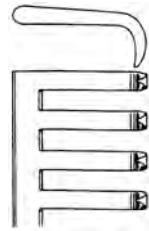

17.5302 14 cm
17.5304 16,5 cm

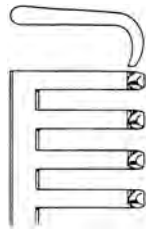

17.5303 14 cm
17.5305 16,5 cm



WEITLANER

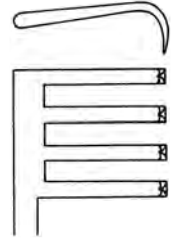

17.5306 20 cm

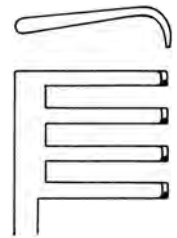

17.5307 20 cm



WEITLANER



17.5308 24 cm



17.5309 24 cm



ADSON

17.5320 19 cm scharf/sharp/pointu/agudo
17.5321 19 cm stumpf/blunt/mousse/romo



NORFOLK-NORWICH
17.5340
20 cm

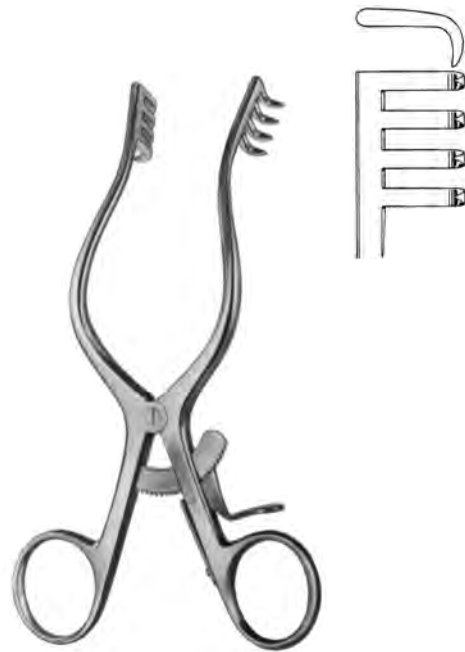

MOLLISON
17.5406 15 cm

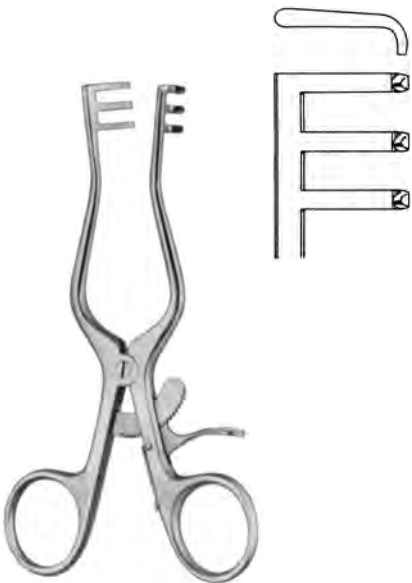

MILLIGAN
17.5410 13 cm

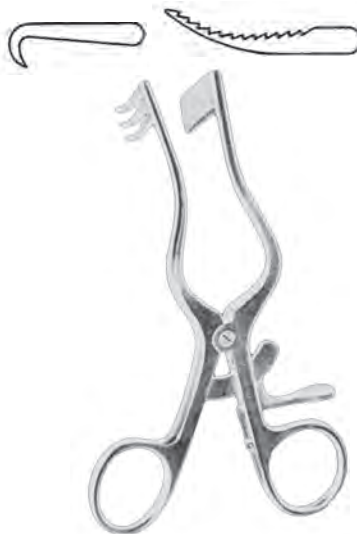

PERKINS-R
17.5446
13 cm



PERKINS-L
17.5447
13 cm

spitz
 sharp
 pointu
 agudo

stumpf
 blunt
 mousse
 romo

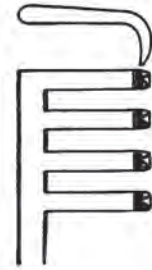

17.5600
 14 cm

17.5601
 14 cm



17.5602
 16,5 cm

17.5603
 16,5 cm

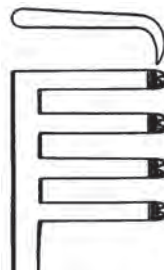

17.5604
 20 cm

17.5605
 20 cm

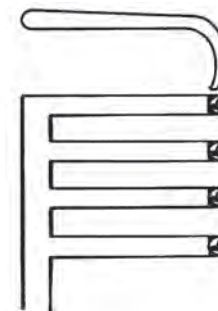
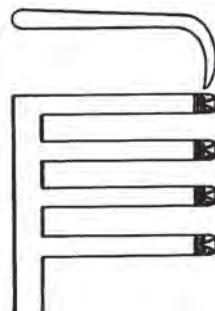

17.5606
 26 cm

17.5607
 26 cm



BECKMANN-WEITLANER
 (Adson)

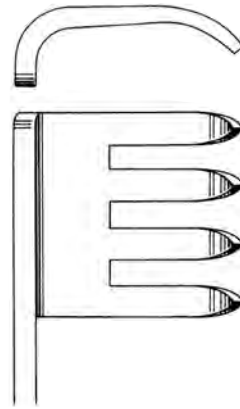
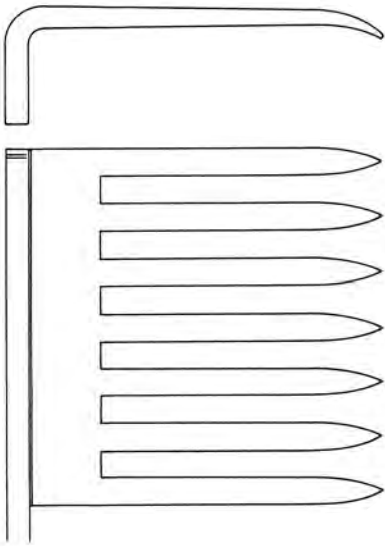

17.5635 25 mm

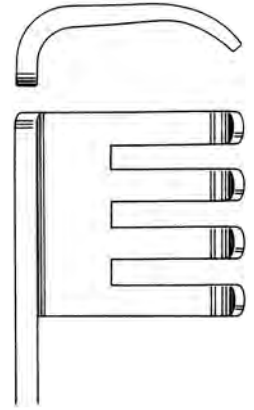

17.5636 25 mm



BECKMANN-EATON
17.5620 32 cm



BECKMANN-ADSON
31 cm

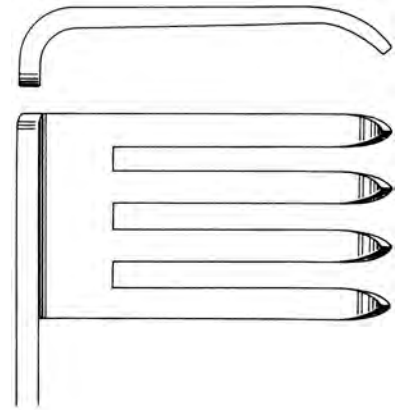

17.5637 44 mm

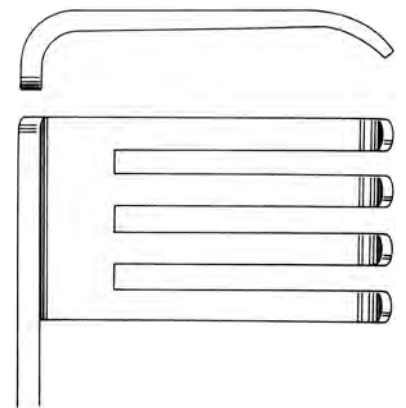

17.5638 44 mm

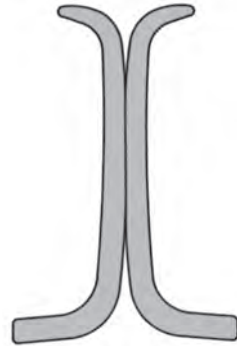

HARVEY-JACKSON
17.5640
28 cm

76x40

64x25 mm



DARLING
17.5670 18 cm

64x25

76x40 mm



DARLING
17.5672 18 cm

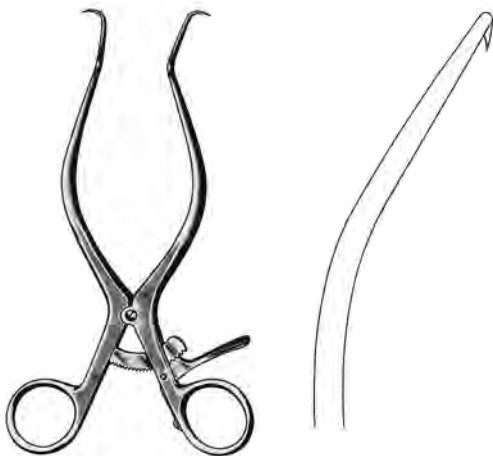

GELPI-MINI
17.5899 10 cm

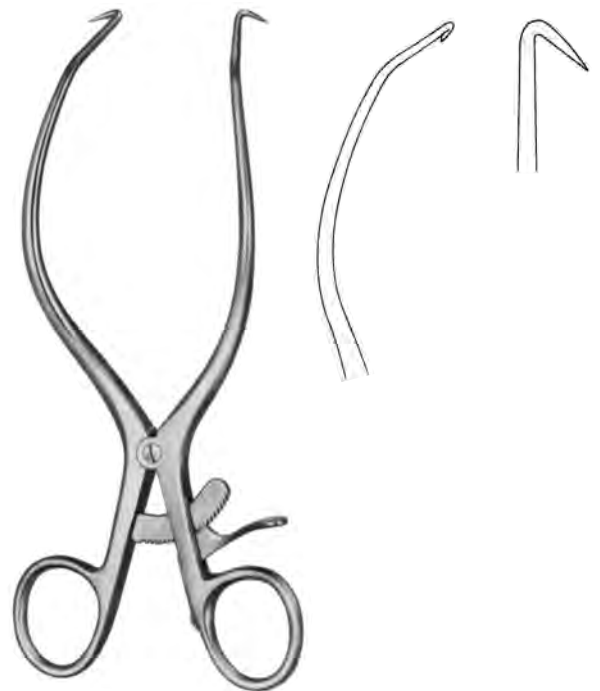

GELPI-BABY
17.5900 14 cm



GELPI
17.5901 18 cm



GELPI-SELETZ
17.5907 15 cm



JACKSON-BURROWS
17.5908 18,5 cm



COMPRIMETER
22.0010

komplett mit Manschette für Oberarm und Oberschenkel
complete with cuff for upper arm and leg
complet avec manchette pour bras et la cuisse
completo con brazaletes para el mizlo & el brazo

22.0011

Oberarm-Manschette
Cuff for the upper arm
Manchette pour le bras
Brazaletes para brazo

22.0012

Oberschenkel-Manschette
Cuff for the leg
Manchette pour la cuisse
Brazaletes para pierna

22.0013

Manschette für Kinder
Cuff for children
Manchette pour enfants
Brazaletes para niños

22.0015

Luftpumpe mit Manometer
Pump with manometer only
Pompe avec manometre, seuls
Bomba neumatica con manometro



ESMARCH
22.0020

Staubinde 5 m x 6 cm
Compression Bandage 5 m x 6 cm
Bande-compression 5 m x 6 cm
Banda-compresión 5 m x 6 cm

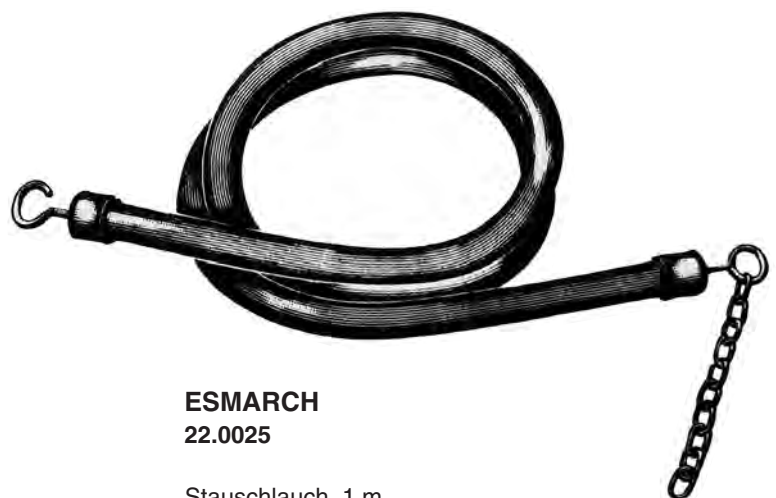

ESMARCH
22.0025

Stauschlauch 1 m
Compression Tube 1 m
Garrot 1 m
Tubo-compresión 1 m

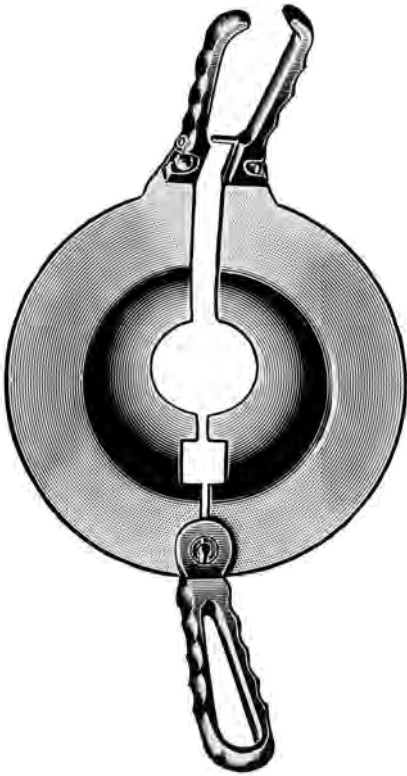

PERCY
22.0050
 mit abnehmbaren Griffen
 with detachable handles
 avec poignées démontables
 con mangos desmontables



LANGENBECK
22.0100 23 cm



CHARRIERE
22.0110 30 cm

22.0111
 Ersatzsägeblatt/spare saw blade/
 lame de rechange/hoja de repuesto



Ersatzsägeblatt
 spare saw blade
 lame de rechange
 hoja de repuesto



CHARRIERE
22.0115 35 cm

22.0116 12 mm
22.0117 15 mm



SATTERLEE
22.0120 31 cm

22.0129
 Ersatzsägeblatt/spare saw blade/
 lame de rechange/hoja de repuesto



BIER
22.0130 42 cm

Ersatzsägeblatt
 spare saw blade
 lame de rechange
 hoja de repuesto



22.0134 4 mm
22.0136 6 mm
22.0138 8 mm



23.0010
 14 cm / 3 mm



23.0012
 15 cm / 5 mm



23.0014
 15 cm / 7 mm



23.0015
 12 cm / 16 mm



23.0016
 16 cm / 15 mm



WILLIGER
23.0020
 16 cm / 5 mm



WILLIGER
23.0022
 17 cm / 6,5 mm



WALTON
23.0025 16 cm

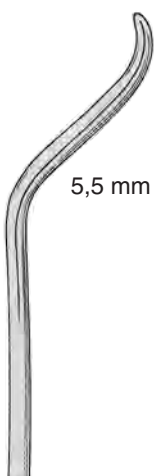

KOENIG
23.0028 15 cm



KOENIG
23.0029 15 cm



SEBILEAU
23.0030
 17 cm / 5 mm



ALDERDYCE
23.0036 21 cm



6 mm



8 mm



LANGENBECK

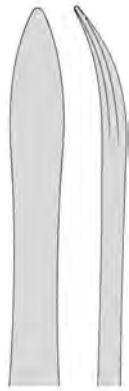

23.0050
20 cm / 7 mm

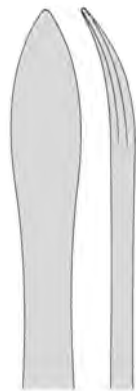

23.0052
20 cm / 10 mm

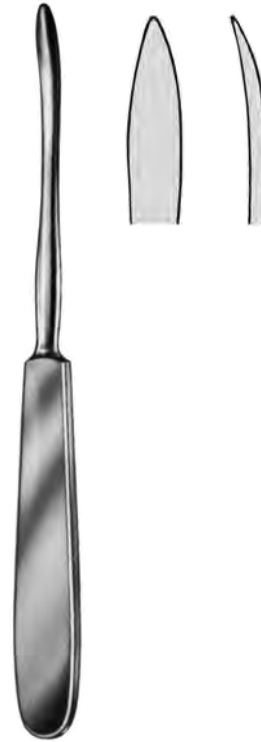

QUERVAIN

23.0060
20 cm / 6 mm



23.0080
28 cm / 9,5 mm



23.0081
28 cm / 13 mm



23.0082
28 cm / 19 mm



COBB



KEY

23.0090	17 cm / 3 mm
23.0091	17 cm / 6 mm
23.0092	17 cm / 9 mm
23.0093	17 cm / 12 mm
23.0094	19 cm / 19 mm
23.0095	19 cm / 25 mm

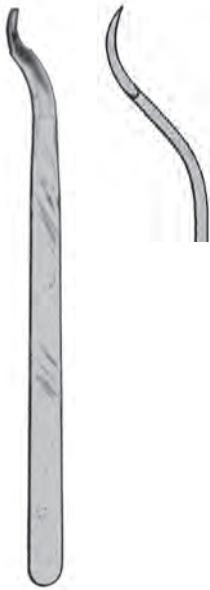

BUCK-GRAMCKO
23.0199
15 cm / 7,5 mm



HOHMANN-MINI
16 cm



23.0200
6 mm



23.0201
8 mm

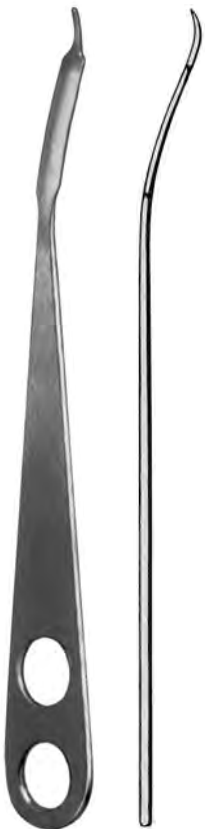

HOHMANN
23.0202
22 cm / 8 mm

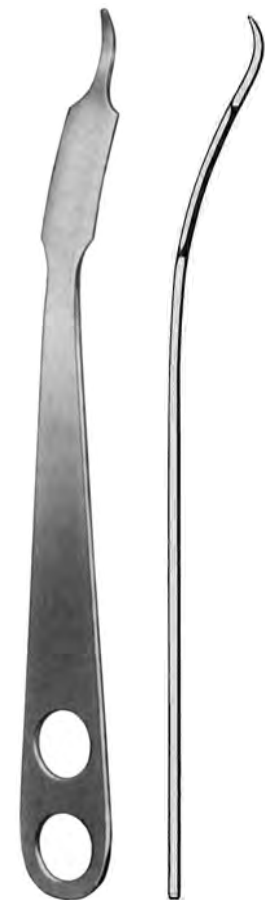

HOHMANN
23.0203
22 cm / 17 mm

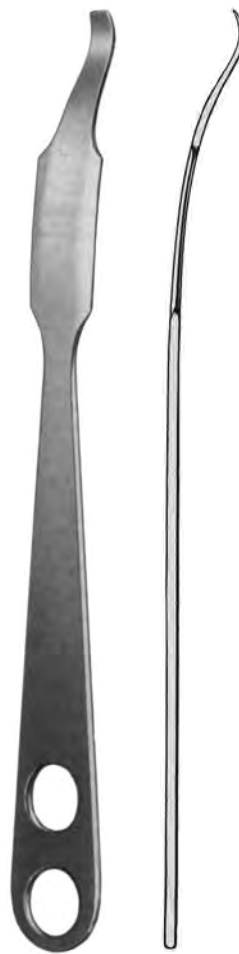

HOHMANN
23.0204
26 cm / 24 mm



HOHMANN
23.0205
28,5 cm / 34 mm



HOHMANN
23.0210
24 cm / 42 mm



HOHMANN
23.0212
24 cm / 65 mm

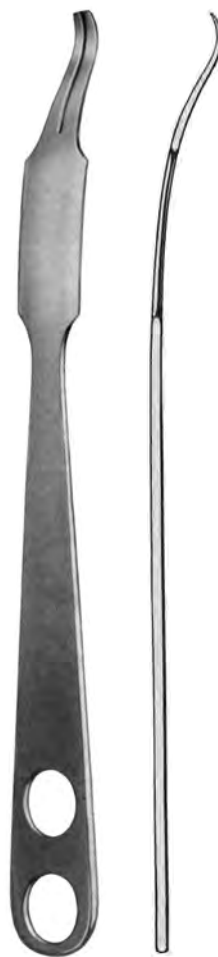

HOHMANN
23.0214
26 cm / 22 mm



HOHMANN
23.0220
24 cm / 43 mm



HOHMANN-ALDINGER
23.0225
27 cm / 24 mm



BLOUNT
23.0245
26 cm #1



BLOUNT
23.0246
26 cm #2



23.0250
27 cm 24 mm / 13 mm



LAMBOTTE
23.0255
27 cm



BENNET
23.0320
25 cm / 45 mm



BENNET
23.0321
25 cm / 64 mm



LANE-TRETHOWAN
23.0330
21,5 cm



MURPHY-LANE
23.0350
30 cm



AUFRANC
23.0360 spitz gerieft/sharp serrated/
pointu striée/agudo estriado
23.0361 spitz glatt/sharp smooth/
pointu lisse/agudo liso
23.0362 stumpf gerieft/blunt serrated/
mousse striée/romo estriado
23.0363 stumpf glatt/blunt smooth/
mousse lisse/romo liso
26 cm / 32 mm

RASPATORIEN mit Ferrozellgriff
RASPATORIES with artificial wood-handles
RUGINES avec manches en bois artificiel
PERIOSTOTOMOS con mangos de madera artificial

PRO-MED



RASPATORIUM
23.0417
 19 cm / 3 mm



RASPATORIUM
23.0418
 19 cm / 6 mm



RASPATORIUM
23.0419
 19 cm / 6 mm



RASPATORIUM
23.0421
 19 cm / 6 mm



RASPATORIUM
23.0423
 19 cm / 13 mm



RASPATORIUM
23.0424
 19 cm / 14 mm

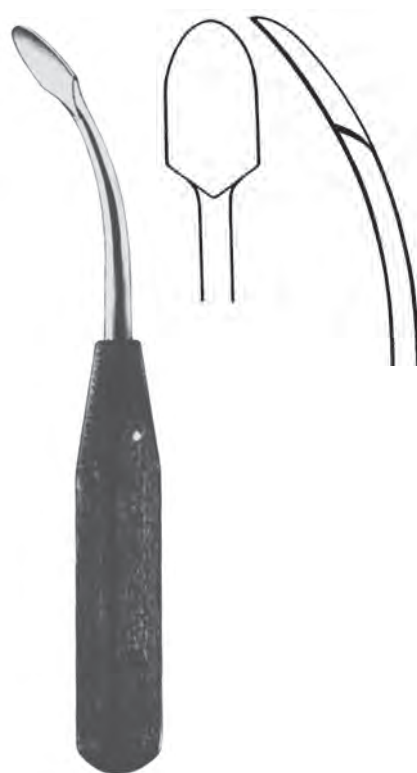

RASPATORIUM
23.0425
 19 cm / 14 mm



RASPATORIUM
23.0426
 20 cm / 20 mm



WILLIGER
23.0500
13 cm / 4 mm

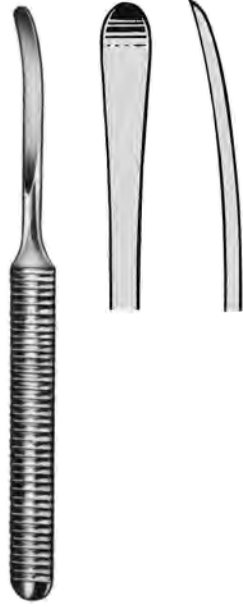

WILLIGER
23.0502
16 cm / 6,5 mm

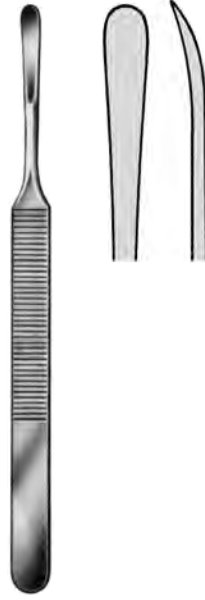

KOENIG
23.0505
15,5 cm / 5 mm

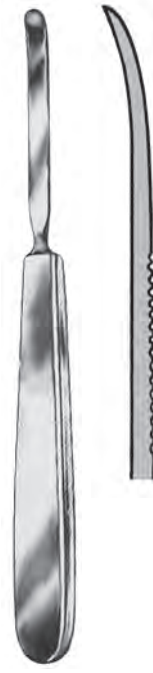

RASPATORIUM
17 cm

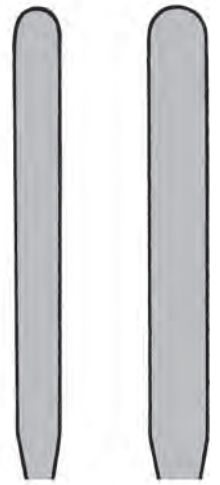

23.0506
6 mm

23.0508
8 mm



SEWALL
23.0510
20 cm / 6 mm

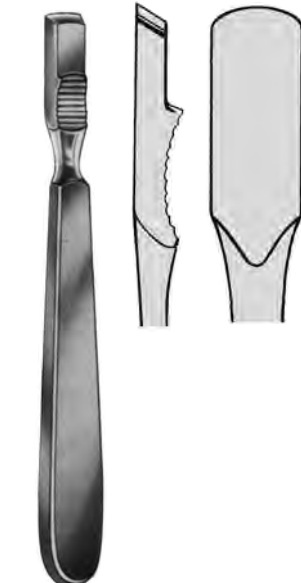

23.0515
16 cm / 5 mm

23.0516
16 cm / 6 mm

23.0517
16 cm / 7 mm

KIRMISSION
23.0519
16,5 cm / 15 mm

FARABEUF
23.0520
15 cm / 13 mm

FARABEUF
23.0521
15 cm / 13 mm



FARABEU-FCOLLIN
15,5 cm / 11 mm

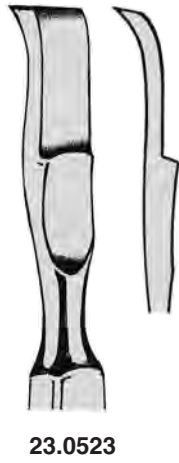

HYLIN
14,5 cm



LANGENBECK
23.0530
19 cm / 16 mm



LANGENBECK
23.0531 19 cm



JANSEN
23.0536
16,5 cm / 15 mm



LAMBOTTE

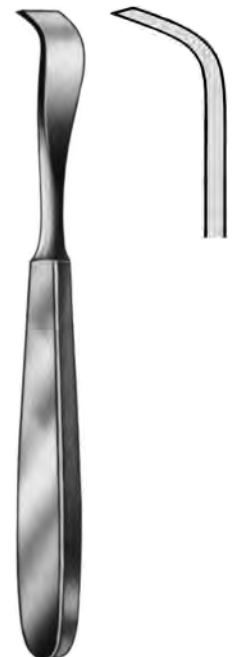

SCHNEIDER
23.0550
17,5 cm / 13 mm



SCHNEIDER-SAUERBRUCH
23.0552
19 cm



SEDILLOT
23.0570
18 cm / 18 mm



SEDILLOT
23.0575
21 cm / 15 mm



DOYEN



23.0580 17 cm



23.0581

Kinder / Children / Enfants / Ninos



23.0582 17 cm
23.0584 24 cm



23.0583
23.0585

Erwachsene / Adult / Adulte / Adultos



23.0601
 17,5 cm
 #1



23.0602
 21 cm
 #2



23.0603
 17,5 cm
 #3



23.0604
 21 cm
 #4



23.0605
 20,5 cm
 #5



23.0606
 20,5 cm
 #6



23.0607
 22,5 cm
 #7

SEM



WAGNER
 33 cm



23.0608
 8 mm



23.0609
 17 mm

mit Ferrozellgriff
 with artificial wood-handles
 avec manches en bois artificiel
 con mangos de madera artificial



RASPATORIUM
23.0610
 27,5 cm / 21 mm

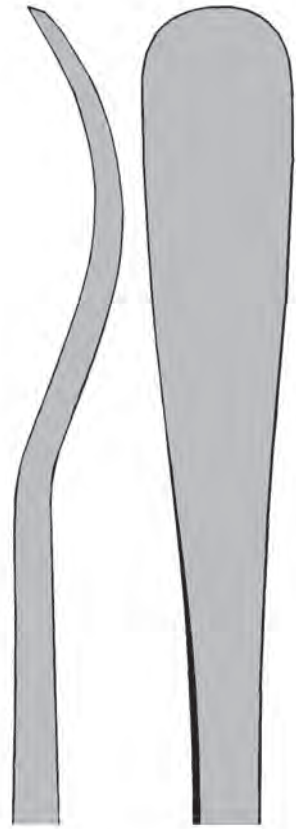



COBB
25 cm



23.0611
10mm



23.0612
13 mm



23.0613
19 mm



23.0614
25 mm

mit Ferrozellgriff
with artificial wood-handles
avec manches en bois artificiel
con mangos de madera artificial



CUSHING
19 cm



23.0620



23.0621

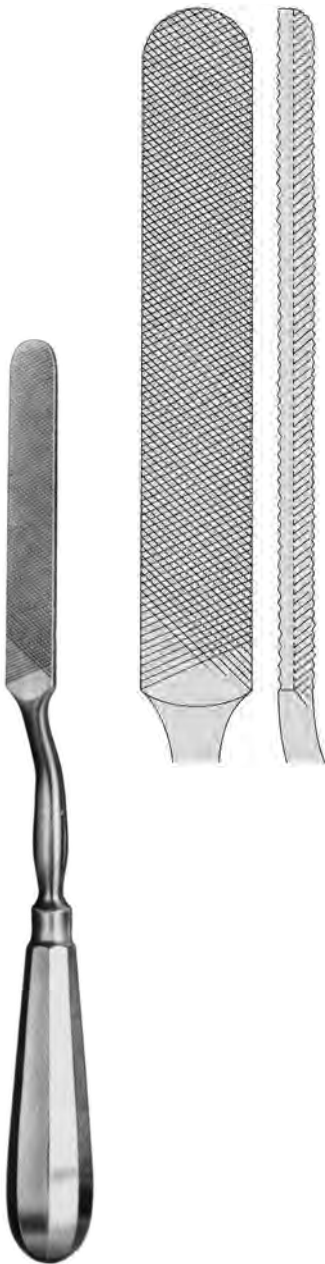

23.0800
24 cm



23.0810
28 cm



23.0820
22 cm / 20 mm



PUTTI
23.0830
30 cm



PUTTI
23.0832
28 cm



FOMON
33.2224
21 cm d/e



FOMON
33.2225
21 cm
fein / fine
fine / fina



FOMON
33.2226
21 cm
grob / coarse
grosse / gruesa





15,5 cm

23.0842
2 mm



23.0843
3 mm

23.0844
4 mm

23.0845
5 mm

23.0846
6 mm

23.0848
8 mm

23.0850
10 mm



PASSOW

23.0860 2,5 mm

23.0862 3,5 mm



23.0990
15 cm

Reinigungsinstrument
Scaler
Instrument pour nettoyer
Instrumento para limpiar



23.1000
000

23.1002
0

23.1004
2

23.1006
4

23.1001
00

23.1003
1

23.1005
3

23.1007
5

SPRATT
17 cm



VOLKMANN
23.1010 13 cm
23.1011 14 cm
23.1012 17 cm
23.1013 20 cm



VOLKMANN
23.1015 13 cm
23.1016 16 cm
23.1017 20 cm



23.1020
00

23.1022
1

23.1025
00

23.1027
1

23.1021
0

23.1023
2

23.1026
0

23.1028
2

WILLIGER
17,5 cm



00

0

23.1030

0

1

23.1031

1

2

23.1032

MARTINI
13,5 cm



JANSEN
 23.1036 16 cm



JANSEN
 23.1037 16 cm

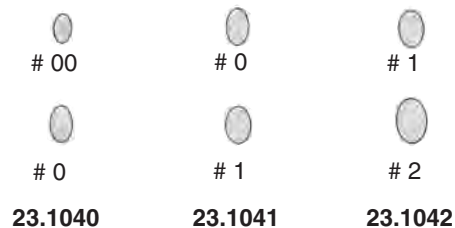

WILLIGER
 13,5 cm

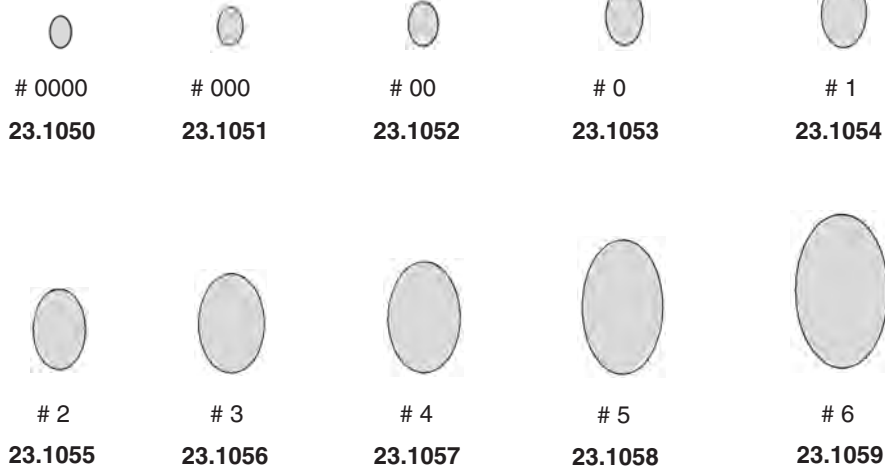

VOLKMANN
 17 cm



BRUNS
17 cm

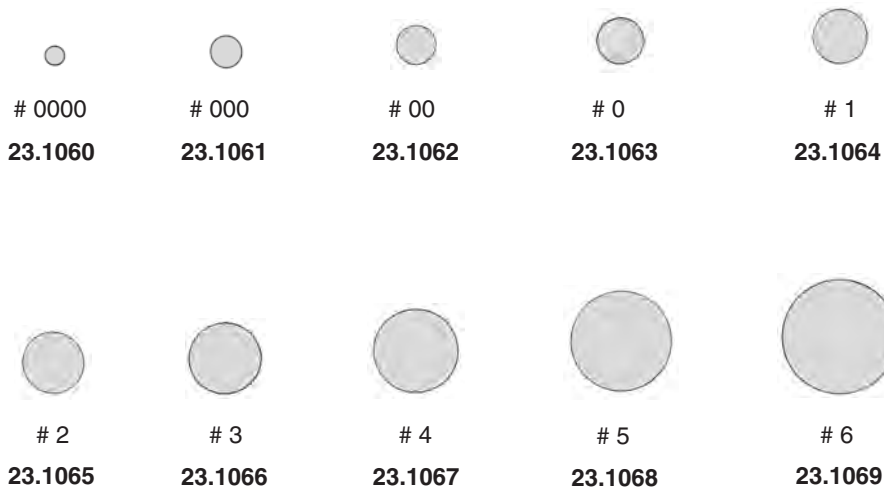

SCHEDE
17 cm

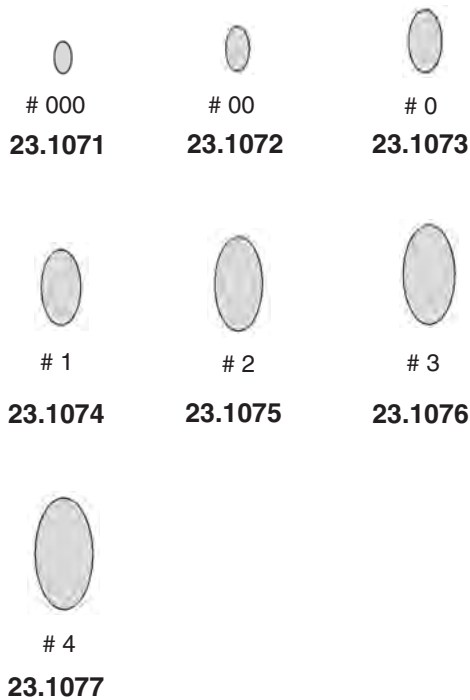

DAUBENSPECK
20 cm

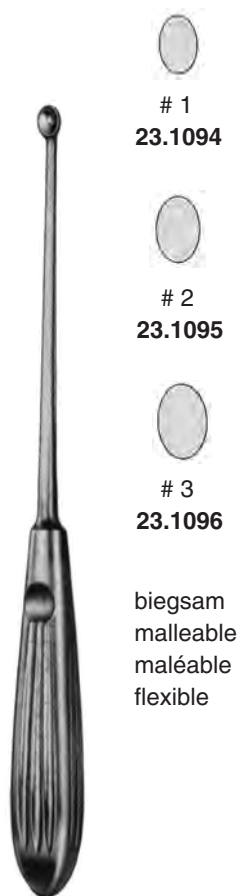

biegsam
malleable
maléable
flexible

HALLE
21 cm

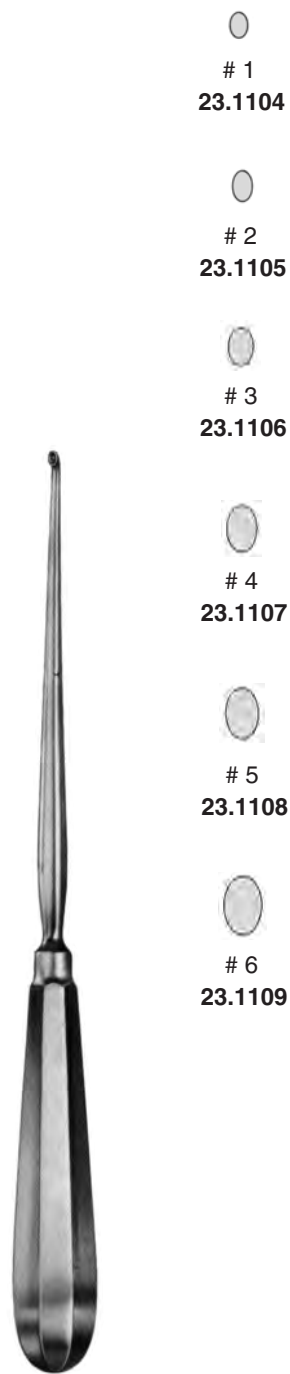

SIMON
24 cm



BRUNS
23 cm

- 23.1111 # 000
- 23.1112 # 00
- 23.1113 # 0
- 23.1114 # 1
- 23.1115 # 2
- 23.1116 # 3
- 23.1117 # 4
- 23.1118 # 5
- 23.1119 # 6



BRUNS
23 cm

- 23.1121 # 000
- 23.1122 # 00
- 23.1123 # 0
- 23.1124 # 1
- 23.1125 # 2
- 23.1126 # 3
- 23.1127 # 4
- 23.1128 # 5
- 23.1129 # 6



BRUNS
23 cm

- 23.1131 # 000
- 23.1132 # 00
- 23.1133 # 0
- 23.1134 # 1
- 23.1135 # 2
- 23.1136 # 3
- 23.1137 # 4
- 23.1138 # 5
- 23.1139 # 6





25 cm



23.1140
3,6 mm



23.1141
4,4 mm



23.1142
5,2 mm



23.1143
6,0 mm



25 cm



23.1144
3,6 mm



23.1145
4,4 mm



23.1146
5,2 mm



23.1147
6,0 mm



BUSHE
25 cm

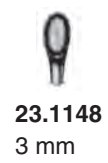

23.1148
3 mm



23.1149
4 mm



23.1150
5 mm



VOLKMANN
27 cm

mit Ferrozellgriff
with artificial wood-handles
avec manches en bois artificiel
con mangos de madera artificial



USA
16 cm

gerade / straight / droit / recta

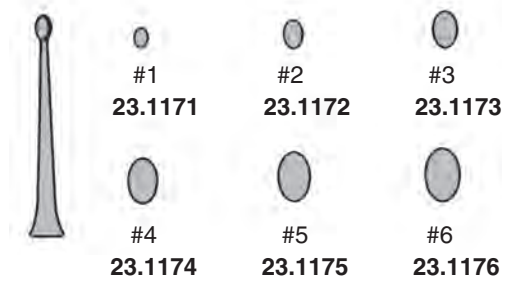

rechts gebogen / curved to right
courbe à droite / curvo derecho

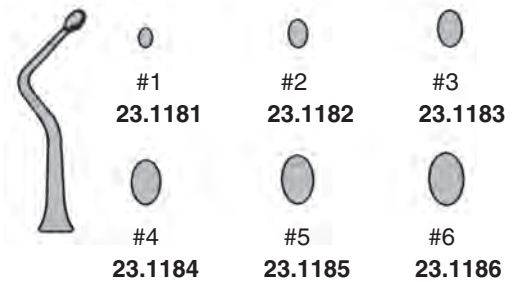

links gebogen / curved to left
courbe à gauche / curvo izquierdo

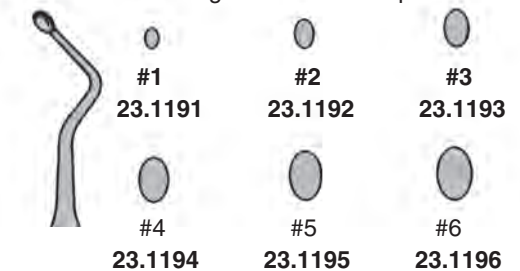



23.1280
22 mm Ø
200 g
bleigefüllt
lead filled
alourdi de plomb
relleno de plomo

23.1281
22 mm Ø
Stahl, massiv
steel, solid
acier, massif
acero, macizo

PARTSCH
18 cm



23.1290
26 mm Ø
300 g
bleigefüllt
lead filled
alourdi de plomb
relleno de plomo

WILLIGER
24 cm



23.1300
27 mm Ø
180 g
Stahl, massiv
steel, solid
acier, massif
acero, macizo

HAJEK
21 cm



23.1302
20 mm Ø
140 g
bleigefüllt
lead filled
alourdi de plomb
relleno de plomo

23.1304
20 mm Ø
Stahl, massiv
steel, solid
acier, massif
acero, macizo

THIESS
16,5 cm



23.1305
25 mm Ø
200 g
mit auswechselbaren Kunststoffbacken
with interchangeable nylon disks
avec disques en nylon interchangeables
con tapas de nylon intercambiables

23.1306
25 mm Ø
Kunststoffbacken allein, paarweise
nylon disks only, pair
disques en nylon de rechange, paire
tapas de nylon sueltas, par

18 cm

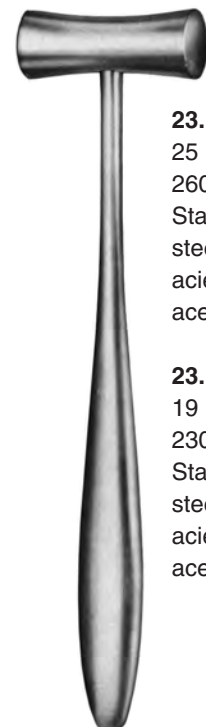

23.1310
25 mm Ø
260 g
Stahl, massiv
steel, solid
acier, massif
acero, macizo

23.1311
19 mm Ø
230 g
Stahl, massiv
steel, solid
acier, massif
acero, macizo

LUCAE
19 cm



COTTLE
19 cm

23.1315
30 mm Ø
300 g
flach / convex
flat / convex
plat / convexe
plano / convexo

Stahl, massiv
steel, solid
acier, massif
acero, macizo



COLLIN
20 cm

23.1316
30 mm Ø
200 g
Stahl, massiv
steel, solid
acier, massif
acero, macizo



GERZOG
18 cm

23.1320
30 mm Ø
400 g
bleigefüllt
lead filled
alourdi de plomb
relleno de plomo



MEAD
17 cm

23.1330
26 mm Ø
320 g
auswechselbare Kunststoffbacken
interchangeable plastic disks
disques en matière plastique
interchangeables
tapas plasticas intercambiables

23.1339
Kunststoffbacken allein, paarweise
plastic disks only, pair
disques de rechange, plastique
tapas de plastica suelto par

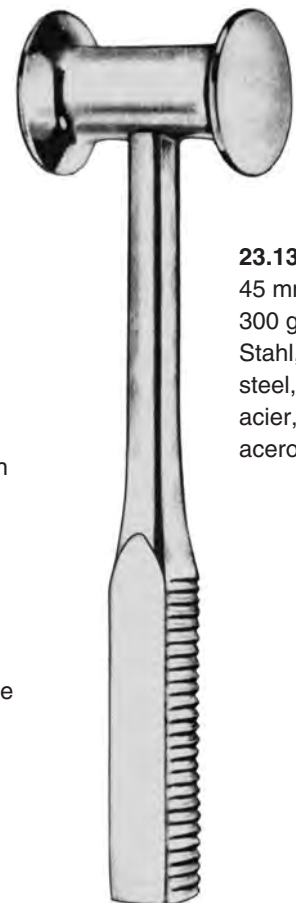

BERGMANN
24 cm

23.1340
45 mm Ø
300 g
Stahl, massiv
steel, solid
acier, massif
acero, macizo

Stahl, massiv
steel, solid
acier, massif
acero, macizo



BERGMANN

23.1342
24 cm
30 mm Ø
300 g

Stahl, massiv
steel, solid
acier, massif
acero, macizo



23.1346
24 cm
28 / 42 mm Ø
400 g

Stahl, massiv
steel, solid
acier, massif
acero, macizo

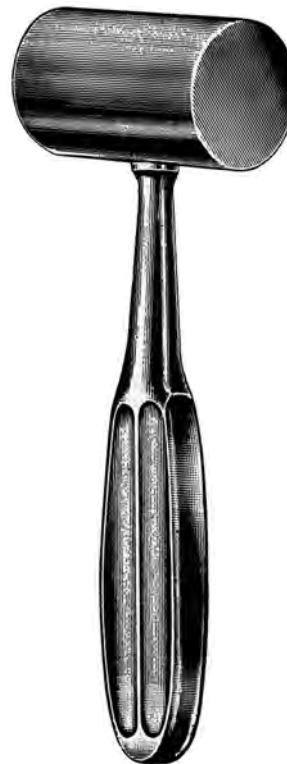

KIRK

23.1350
20 cm
40 mm Ø
680 g

Kunststoff
plastic material
matiere plastique
material plastica



23.1360
26 cm
42 mm Ø
400 g

23.1362
26 cm
50 mm Ø
400 g

Stahl, massiv
steel, solid
acier, massif
acero, macizo

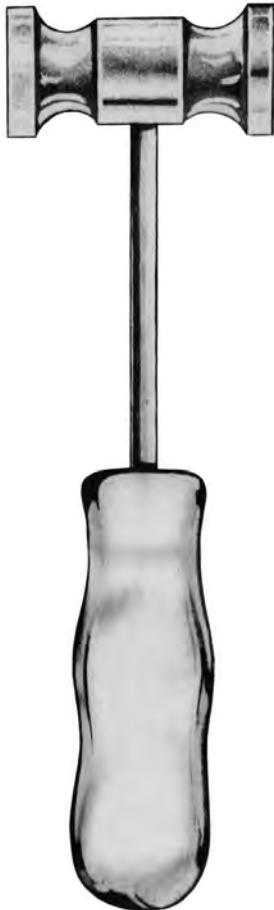

23.1371
24 cm
500 g
23.1372
24 cm
800 g

Stahl, massiv
steel, solid
acier, massif
acero, macizo



OMBREDANNE
23.1380
24 cm
40 mm Ø
550 g

Kupferfüllung
copper filled
alourdi de cuivre
relleno de cobre



HEATH
23.1385
18 cm
40 mm Ø
700 g
23.1386
18 cm
45 mm Ø
700 g

Besondere Silikonmischung höchster Qualität

Reißfestigkeit: ~12 N/mm²

Reißdehnung: ~ 600%

Härte: ~ 80 Shore A

Temperaturbeständig: - 40°C - + 200°C (kurzfristig bis +300°C)

Wasserdampfbeständig: bis 160°C

Hohe chemische Beständigkeit gegen Laugen, Salze und verdünnte Säuren. Lichtecht, unempfindlich gegenüber medizinischer Gamma-Strahlung, Physiologische Zulassung im Lebensmittel- und Pharmabereich nach BGA/BGVV und FDA.

Special Silicone composition of highest quality standard

Tensile strength: ~12 N/mm²

Yield stress: ~ 600%

hardness: ~ 80 Shore A

max. temperature: - 40°C - + 200°C (for short periods up to +300°C)

Steam sterilization: up to 160°C

Excellent chemical resistance for alkaline, saline and acidic solutions.

Non-fading; resistant against medical gamma-radiation. Biocompatible acc. to BGA/BGVV and FDA.

Stahl massiv / steel solid / acier, massif / acero, macizo

mit auswechselbaren Kunststoffbacken
 with interchangeable plastic discs
 avec disques en matière plastique interchangeables
 con tapas plasticas intercambiables



23.1390
 24 cm
 27 mm Ø
 300 g



23.1391
 24 cm
 35 mm Ø
 500 g



23.1392
 24 cm
 40 mm Ø
 700 g



23.1398
 24 cm
 30 mm Ø
 250 g

23.1399

Paar Ersatzbacken f. 23.1398

Spare disks pair for 23.1398

Disques de rechange pour 23.1398

Tapas/recambio para 23.1398

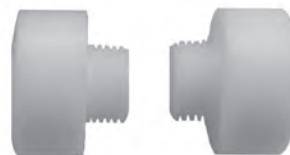



BUCKLEY
16 cm



23.1902
2 mm



23.1903
3 mm



23.1904
4 mm



23.1912
2 mm



23.1913
3 mm



23.1914
4 mm



BUCK-GRAMCKO
23.1930
11 cm



BUCK-GRAMCKO
23.1931
11 cm



BUCK-GRAMCKO
23.1933
11 cm



BUCK-GRAMCKO
23.1935
11 cm



- 23.1410** 13,5 cm / 2 mm
- 23.1411** 13,5 cm / 3 mm
- 23.1412** 13,5 cm / 4 mm
- 23.1413** 13,5 cm / 5 mm
- 23.1414** 13,5 cm / 6 mm
- 23.1415** 13,5 cm / 7 mm
- 23.1416** 13,5 cm / 8 mm

- 23.1420** 17,0 cm / 2 mm
- 23.1421** 17,0 cm / 3 mm
- 23.1422** 17,0 cm / 4 mm
- 23.1423** 17,0 cm / 5 mm
- 23.1424** 17,0 cm / 6 mm
- 23.1425** 17,0 cm / 7 mm
- 23.1426** 17,0 cm / 8 mm

PARTSCH



- 23.1440** 13,5 cm / 2 mm
- 23.1441** 13,5 cm / 3 mm
- 23.1442** 13,5 cm / 4 mm
- 23.1443** 13,5 cm / 5 mm
- 23.1444** 13,5 cm / 6 mm
- 23.1445** 13,5 cm / 7 mm
- 23.1446** 13,5 cm / 8 mm

- 23.1450** 17,0 cm / 2 mm
- 23.1451** 17,0 cm / 3 mm
- 23.1452** 17,0 cm / 4 mm
- 23.1453** 17,0 cm / 5 mm
- 23.1454** 17,0 cm / 6 mm
- 23.1455** 17,0 cm / 7 mm
- 23.1456** 17,0 cm / 8 mm

PARTSCH



- 23.1458** 13,5 cm / 4 mm
- 23.1459** 13,5 cm / 6 mm
- 23.1460** 13,5 cm / 8 mm
- 23.1461** 13,5 cm / 10 mm
- 23.1462** 13,5 cm / 12 mm
- 23.1463** 13,5 cm / 14 mm
- 23.1464** 13,5 cm / 16 mm



- 23.1468** 13,5 cm / 4 mm
- 23.1469** 13,5 cm / 6 mm
- 23.1470** 13,5 cm / 8 mm
- 23.1471** 13,5 cm / 10 mm
- 23.1472** 13,5 cm / 12 mm
- 23.1473** 13,5 cm / 14 mm
- 23.1474** 13,5 cm / 16 mm



- 23.1478** 13,5 cm / 4 mm
- 23.1479** 13,5 cm / 6 mm
- 23.1480** 13,5 cm / 8 mm
- 23.1481** 13,5 cm / 10 mm
- 23.1482** 13,5 cm / 12 mm
- 23.1483** 13,5 cm / 14 mm
- 23.1484** 13,5 cm / 16 mm



- 23.1486 3 mm
- 23.1488 4 mm
- 23.1490 5 mm
- 23.1492 6 mm
- 23.1494 8 mm
- 23.1496 10 mm
- 23.1498 12 mm

HOKE
14 cm



- 23.1487 3 mm
- 23.1489 4 mm
- 23.1491 5 mm
- 23.1493 6 mm
- 23.1495 8 mm
- 23.1497 10 mm
- 23.1499 12 mm

HOKE
14 cm

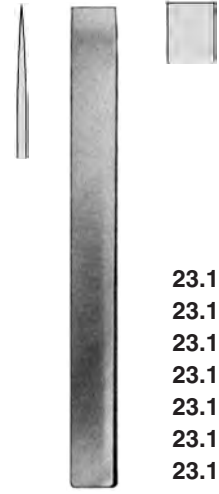

- 23.1500 3 mm
- 23.1501 4 mm
- 23.1503 6 mm
- 23.1504 8 mm
- 23.1505 10 mm
- 23.1506 12 mm
- 23.1507 15 mm

MINI-LAMBOTTE
12,5 cm



- 23.1509 4 mm
- 23.1510 6 mm
- 23.1511 13 mm
- 23.1512 15 mm
- 23.1513 20 mm
- 23.1514 25 mm
- 23.1515 30 mm
- 23.1516 38 mm
- 23.1517 44 mm
- 23.1518 50 mm

LAMBOTTE
25 cm



- 23.1520 6 mm
- 23.1521 13 mm
- 23.1522 15 mm
- 23.1523 20 mm
- 23.1524 25 mm
- 23.1525 30 mm
- 23.1526 38 mm
- 23.1527 44 mm
- 23.1528 50 mm

LAMBOTTE
25 cm

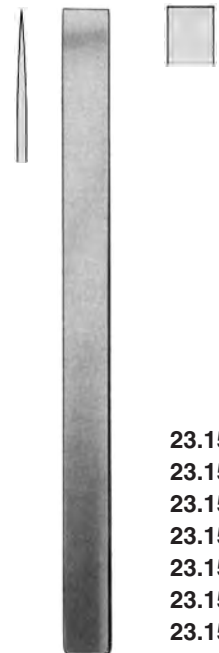

- 23.1530 3 mm
- 23.1531 4 mm
- 23.1532 6 mm
- 23.1533 8 mm
- 23.1534 10 mm
- 23.1535 12 mm
- 23.1536 15 mm

MINI-LAMBOTTE
17 cm



- 23.1540 4 mm
- 23.1541 6 mm
- 23.1542 8 mm
- 23.1543 10 mm
- 23.1544 12 mm
- 23.1545 14 mm

ALEXANDER
17,5 cm



- 23.1550 4 mm
- 23.1551 6 mm
- 23.1552 8 mm
- 23.1553 10 mm
- 23.1554 12 mm
- 23.1555 14 mm

ALEXANDER
18 cm



- 23.1560 4 mm
- 23.1561 6 mm
- 23.1562 8 mm
- 23.1563 10 mm
- 23.1564 12 mm
- 23.1565 14 mm

ALEXANDER
17,5 cm



- 23.1578 12 mm
- 23.1579 8 mm
- 23.1580 10 mm
- 23.1581 15 mm
- 23.1582 20 mm
- 23.1583 25 mm
- 23.1584 30 mm

STILLE
20 cm



- 23.1588 12 mm
- 23.1589 8 mm
- 23.1590 10 mm
- 23.1591 15 mm
- 23.1592 20 mm
- 23.1593 25 mm
- 23.1594 30 mm

STILLE
20 cm



- 23.1595 8 mm
- 23.1596 10 mm
- 23.1597 12 mm
- 23.1598 15 mm
- 23.1599 20 mm
- 23.1600 25 mm

STILLE
20 cm



- 23.1604 8 mm
- 23.1605 10 mm
- 23.1606 12 mm
- 23.1607 15 mm
- 23.1608 20 mm
- 23.1609 25 mm

STILLE
20 cm

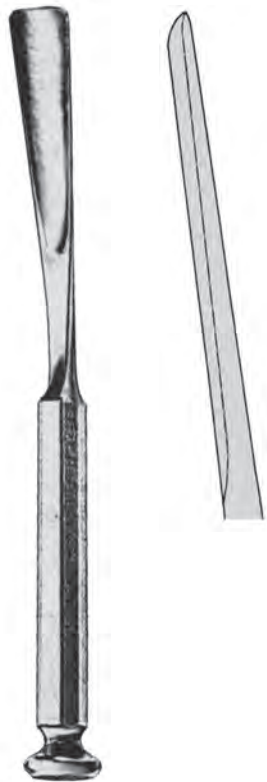

WALTER
23.1615 10 mm
23.1617 15 mm
20 cm



LEXER
23.1620 20 mm
25 cm



LEXER
23.1621 16 mm
26 cm

mit Ferrozellgriff
with artificial wood-handles
avec manches en bois artificiel
con mangos de madera artificial

mit Ferrozellgriff
with artificial wood-handles
avec manches en bois artificiel
con mangos de madera artificial

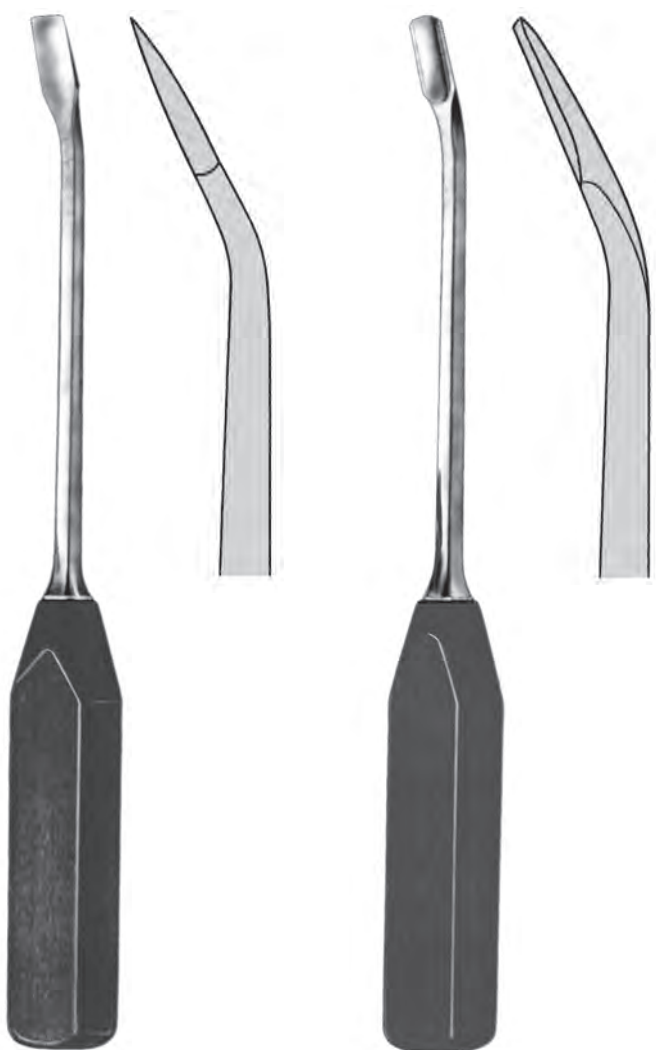

LEXER

23.1623 10 mm
23.1624 15 mm
27 cm

LEXER

23.1625 10 mm
23.1626 15 mm
27 cm

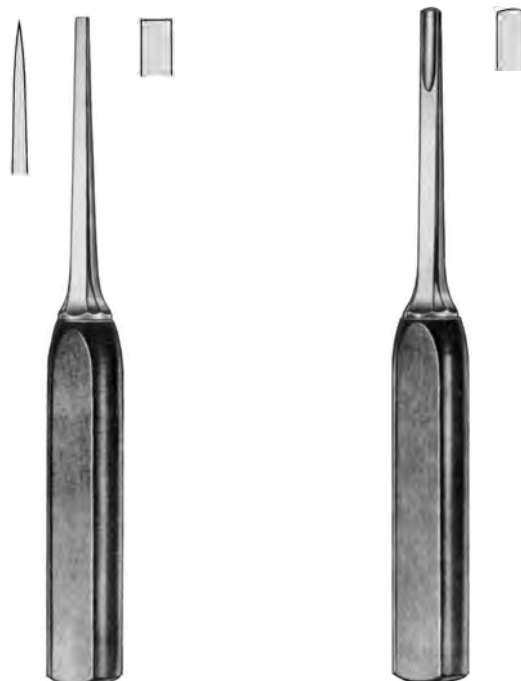

MINI-LEXER

23.1630 4 mm
23.1631 6 mm
23.1632 8 mm
23.1633 10 mm
23.1634 12 mm
18 cm

MINI-LEXER

23.1640 4 mm
23.1641 6 mm
23.1642 8 mm
23.1643 10 mm
23.1644 12 mm
18 cm

mit Ferrozellgriff
with artificial wood-handles
avec manches en bois artificiel
con mangos de madera artificial



- 23.1650 7 mm
- 23.1651 10 mm
- 23.1652 15 mm
- 23.1653 20 mm
- 23.1654 25 mm
- 23.1655 30 mm

LEXER
22 cm



- 23.1660 7 mm
- 23.1661 10 mm
- 23.1662 15 mm
- 23.1663 20 mm
- 23.1664 25 mm
- 23.1665 30 mm

LEXER
22 cm



- 23.1671 5,5 mm
- 23.1673 9,0 mm

ZIELKE
23 cm



- 23.1680 10 mm
- 23.1682 15 mm
- 23.1684 20 mm

OSTEOTOME
20 cm



- 23.1681 10 mm
- 23.1683 15 mm
- 23.1685 20 mm

OSTEOTOME
20 cm



SMITH-PETERSEN

20 cm

- 23.1700 6 mm
- 23.1702 9 mm
- 23.1704 13 mm
- 23.1706 16 mm
- 23.1708 19 mm
- 23.1710 25 mm
- 23.1712 32 mm

SMITH-PETERSEN

20 cm

- 23.1701 6 mm
- 23.1703 9 mm
- 23.1705 13 mm
- 23.1707 16 mm
- 23.1709 19 mm
- 23.1711 25 mm
- 23.1713 32 mm

SMITH-PETERSEN

20 cm

- 23.1720 6 mm
- 23.1722 9 mm
- 23.1724 13 mm
- 23.1726 16 mm
- 23.1728 19 mm
- 23.1730 25 mm
- 23.1732 32 mm

SMITH-PETERSEN

20 cm

- 23.1721 6 mm
- 23.1723 9 mm
- 23.1725 13 mm
- 23.1727 16 mm
- 23.1729 19 mm
- 23.1731 25 mm
- 23.1733 32 mm

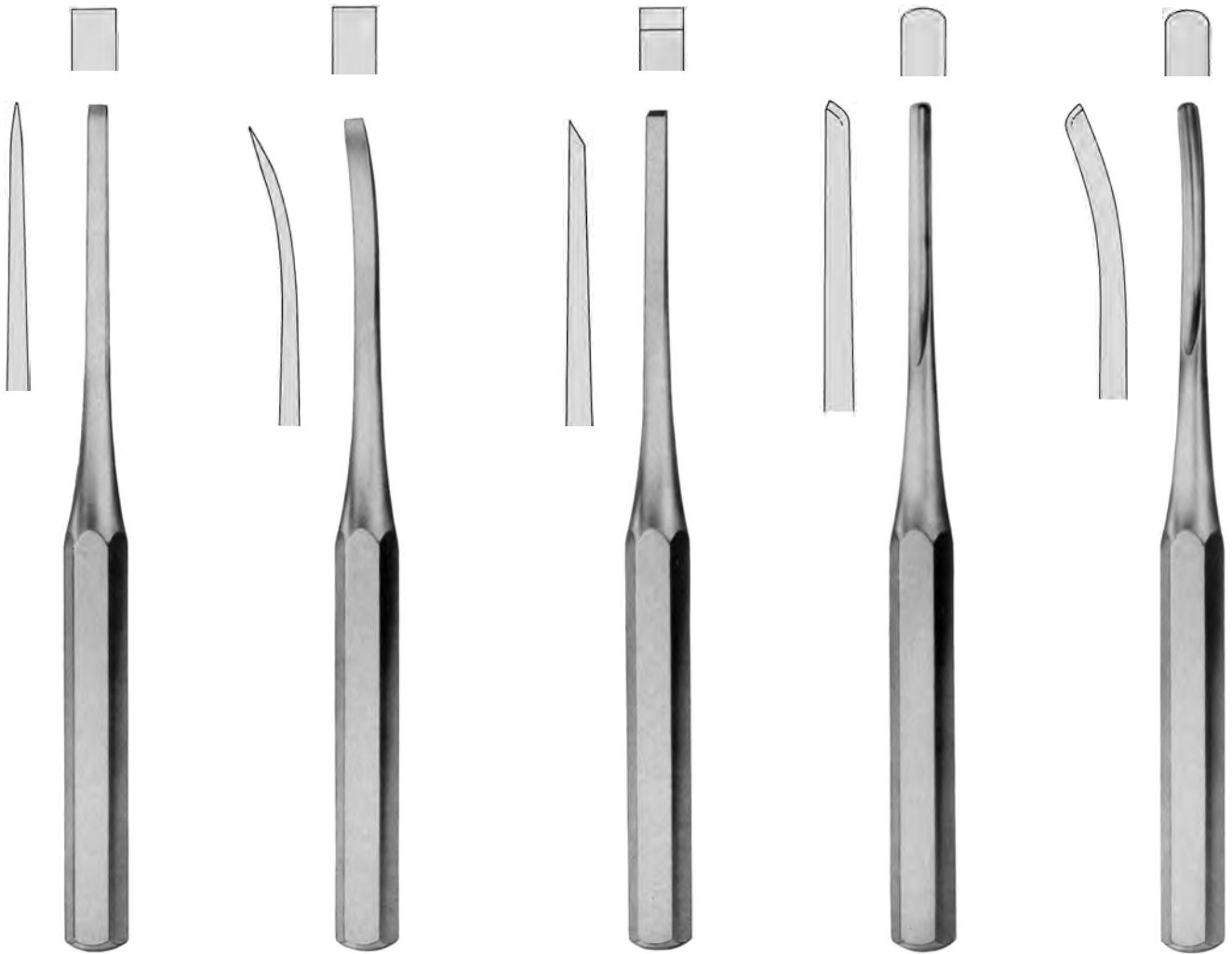

HIBBS

24 cm

- 23.1750 6 mm
- 23.1752 13 mm
- 23.1754 19 mm
- 23.1756 25 mm
- 23.1758 32 mm

HIBBS

24 cm

- 23.1751 6 mm
- 23.1753 13 mm
- 23.1755 19 mm
- 23.1757 25 mm
- 23.1759 32 mm

HIBBS

24 cm

- 23.1770 6 mm
- 23.1772 13 mm
- 23.1774 19 mm
- 23.1776 25 mm
- 23.1778 32 mm

HIBBS

24 cm

- 23.1790 6 mm
- 23.1792 13 mm
- 23.1794 19 mm
- 23.1796 25 mm
- 23.1798 32 mm

HIBBS

24 cm

- 23.1791 6 mm
- 23.1793 13 mm
- 23.1795 19 mm
- 23.1797 25 mm
- 23.1799 32 mm

mit Ferrozellgriff
with artificial wood-handles
avec manches en bois artificiel
con mangos de madera artificial



COBB
23.1800
28 cm / 8 mm



COBB
23.1801
28 cm / 8 mm



COBB
23.1802
28 cm / 8 mm



COBB
23.1803
28 cm / 8 mm

mit Ferrozellgriff
 with artificial wood-handles
 avec manches en bois artificiel
 con mangos de madera artificial



WAGNER
 34 cm



9 mm

15 mm



23.1810

aufgebogen
 inclined forward
 coudé en avant
 curva hacia adelante

23.1811



23.1812

rückwärts gebogen
 inclined backward
 coudé en arrière
 curva hacia atrás

23.1813



23.1814

gerade
 straight
 droite
 recta

23.1815

mit Ferrozellgriff
with artificial wood-handles
avec manches en bois artificiel
con mangos de madera artificial



SPONGIOSA

25 cm

23.1820 5 mm

23.1822 10 mm

23.1824 15 mm



SPONGIOSA

25 cm

23.1821 5 mm

23.1823 10 mm

23.1825 15 mm



23.2001
13,5 cm
für Kleinfragmente
for small fragments
pour petits fragments
para fragmentos pequeños



REILL
23.2002
17 cm
Repositionszange
Reposition Forceps
Pince à réduction
Pinza para reducción



23.2004
14 cm
Fingerknochen-Haltezange
Phalangeal Forceps
Pince pour phalanges
Pinza para coger falanges



23.2005
12 cm



LEWIN
23.2010
18 cm



SETTER
23.2040
13,5 cm



SETTER

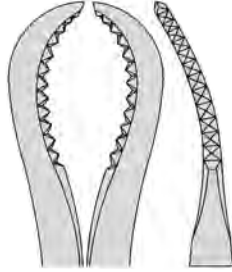

23.2042
16 cm

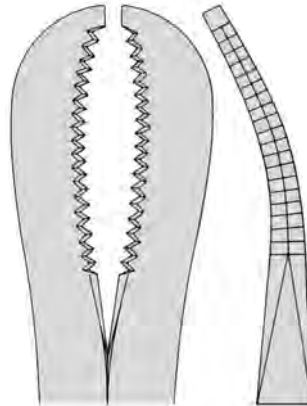

23.2044
22 cm

Repositionszangen
Reposition Forceps
Pinces à réduction
Pinzas para reducción

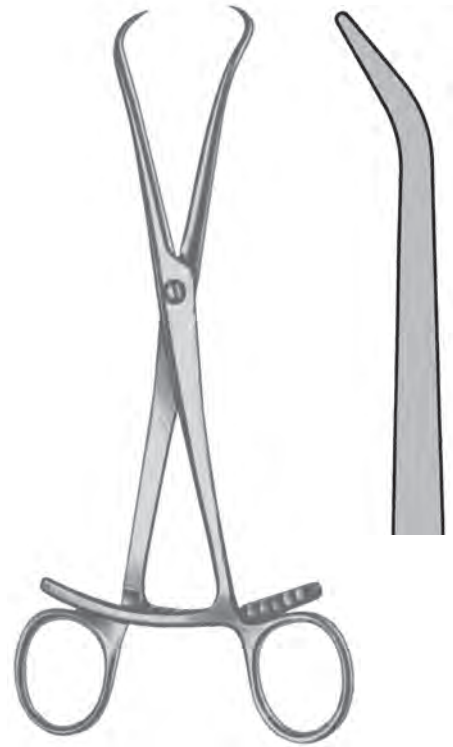

23.2050
20 cm

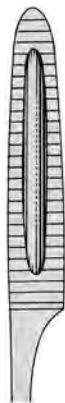

23.2100
20 cm



23.2101
20 cm

Sequesterzangen
Sequestrum Forceps
Pinces à séquestre
Pinzas para secuestro

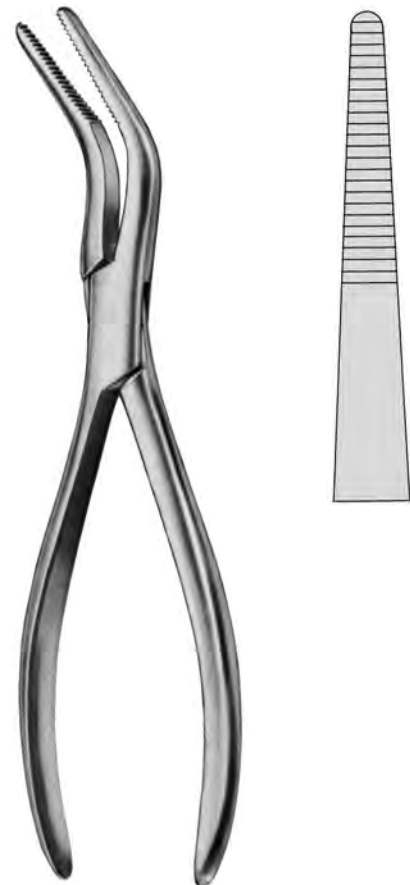

VAN BUREN
23.2110 23 cm



DINGMAN



23.2200
19 cm



DINGMAN modif.
23.2205
19 cm



SEMB
23.2210 19 cm

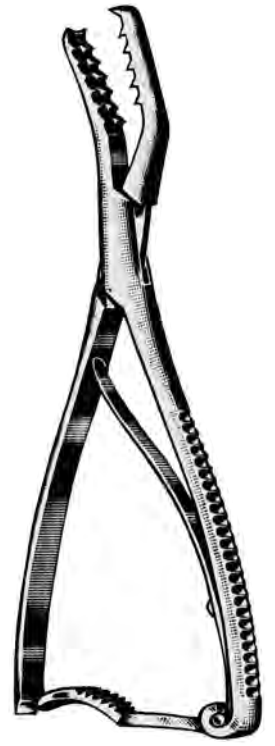

SEMB
23.2211 19 cm



FERGUSSON
23.2220 21 cm

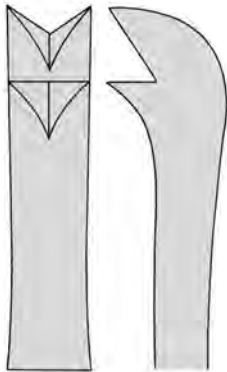

23.2224 20 cm



FARABEU
23.2232 23 cm
23.2234 26 cm

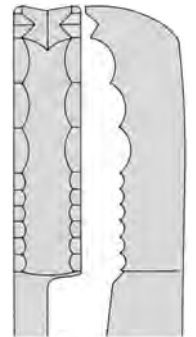

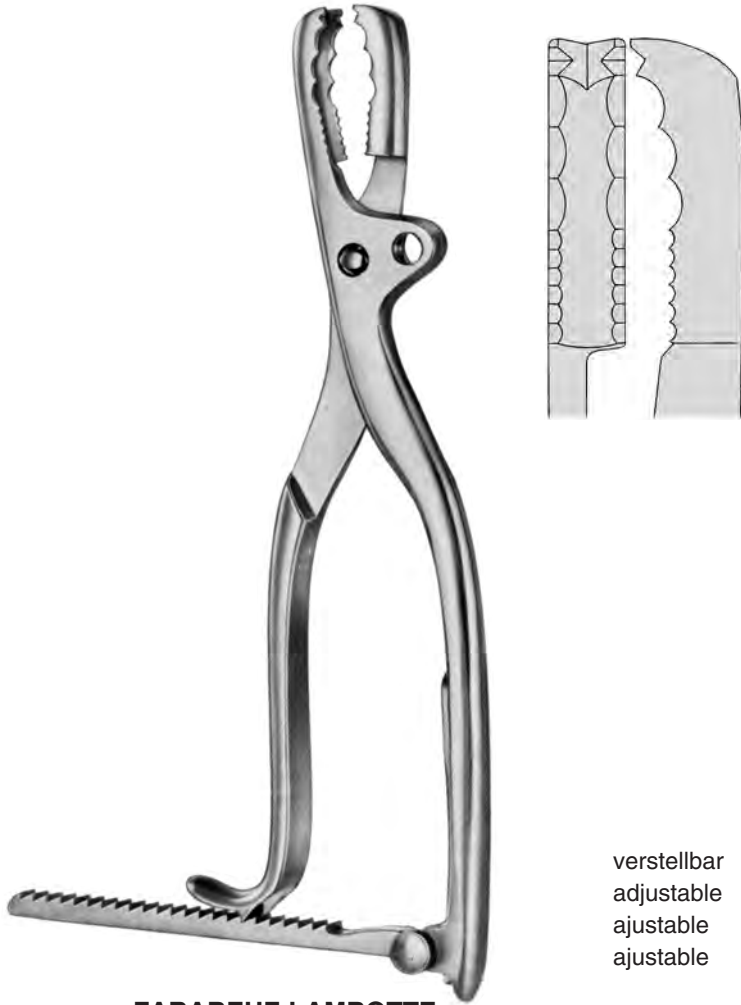

FARABEU-F-LAMBOTTE
 23.2235 26 cm

verstellbar
 adjustable
 ajustable
 ajustable



LANGENBECK
 23.2240 21 cm



KERN
 23.2250 14 cm
 23.2252 17 cm
 23.2254 21 cm



KERN
 23.2251 14 cm
 23.2253 17 cm
 23.2255 21 cm

verstellbar
 adjustable
 ajustable
 ajustable

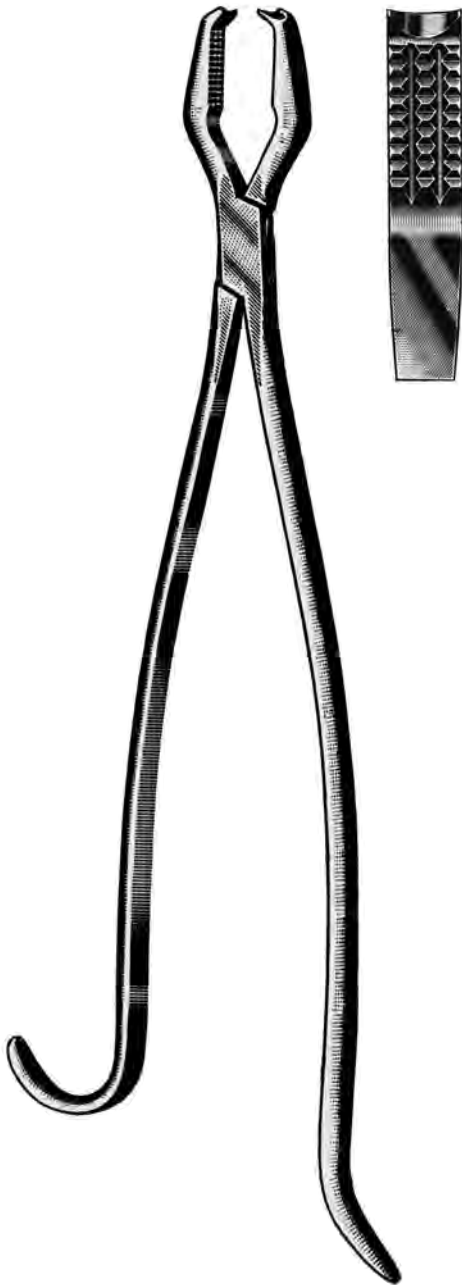

LANE
23.2260 33 cm
23.2262 45 cm



verstellbar
adjustable
ajustable
ajustable

LANE
23.2261 33 cm
23.2263 45 cm



LAMBOTTE
23.2270 22 cm
23.2271 26 cm
23.2272 30 cm

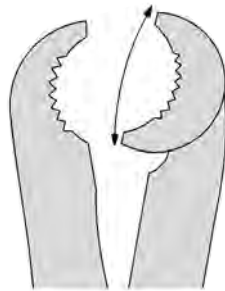

verstellbar
adjustable
ajustable
ajustable



LAMBOTTE
23.2274 26 cm





VERBRUGGE-BABY

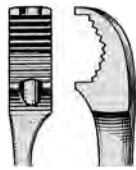

23.2280
17 cm

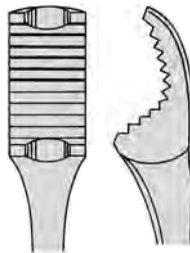

23.2282
25 cm

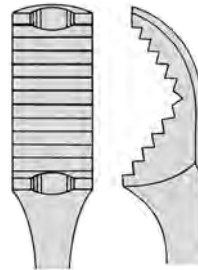

23.2284
26 cm

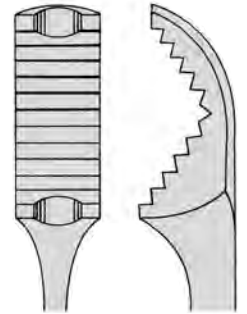

23.2286
27 cm



selbstzentrierend
self-centering
autocentrent
autocentrante



23.2290
15 cm / 9 mm



23.2292
19 cm / 9 mm



23.2294
27 cm / 14 mm

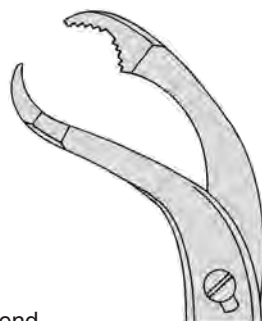

23.2296
28 cm / 18 mm



23.2298
28 cm / 22 mm



ULRICH

verstellbar
adjustable
ajustable
ajustable



23.2300 18 cm



23.2302 23 cm



23.2304 25 cm



23.2306 28 cm



ULRICH



23.2305 25 cm



23.2307 28 cm



LOWMAN
23.2490 12 cm 1x1
23.2492 18 cm 1x1
23.2494 20 cm 1x1



LOWMAN
23.2500 12 cm 1x2



LOWMAN
23.2502 18 cm 1x2
23.2504 20 cm 1x2
23.2506 22 cm 1x2



LOWMAN-HOGLUND
23.2510 12 cm
23.2512 18 cm



LOWMAN-HOGLUND
23.2520 19 cm
23.2522 22 cm

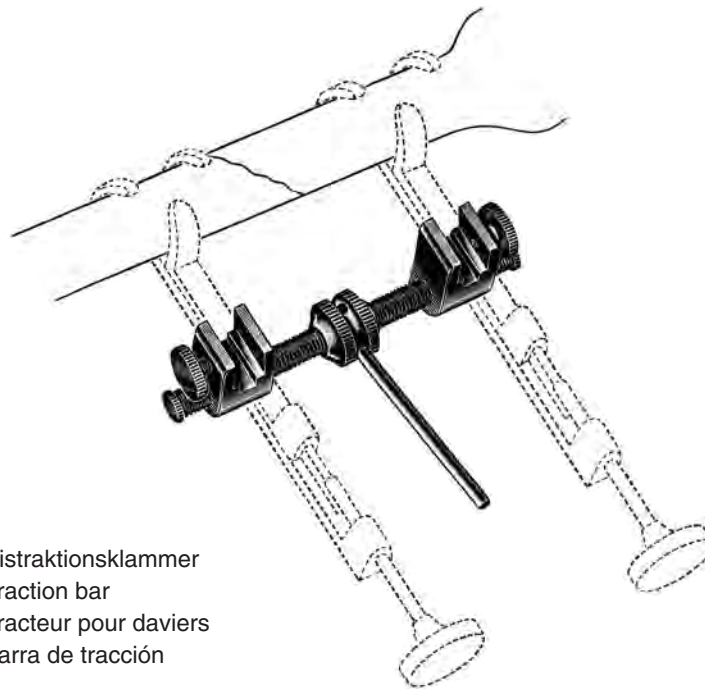

Distraktionsklammer
Traction bar
Tracteur pour daviers
Barra de tracción

GERSTER
23.2550



FRIEDMANN-MINI
23.2600 12 cm



FRIEDMANN
23.2601 14 cm



PEARSON
23.2602 14,5 cm



LUER
18 cm

23.2604

23.2605



LUER
15 cm



23.2603



23.2606

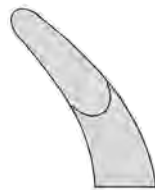

23.2607

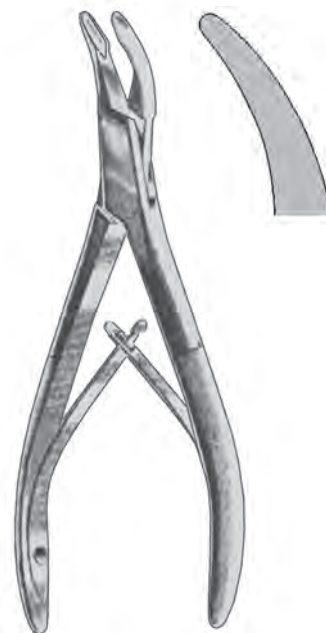

CICHERELLI
23.2609 16,5 cm



BEYER
23.2611 18 cm



LEMPERT
16 cm



23.2620

23.2621



LEMPERT
19 cm



23.2622

23.2623



STELLBRINK
17 cm

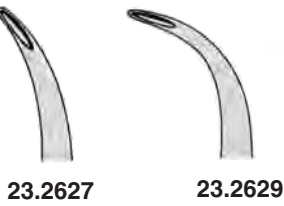

23.2627

23.2629



HAKANSSON
23.2633
16 cm



MEAD
23.2635
16 cm #1A



MEAD
23.2636
16 cm #2A

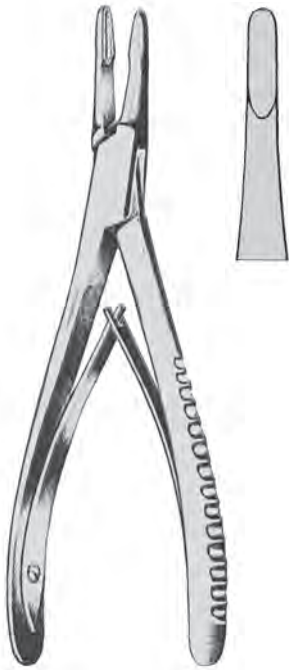

JANSEN
23.2640 18 cm



JANSEN
23.2641 18 cm



JANSEN
23.2643 18 cm



OLIVECRONA
23.2650 19,5 cm

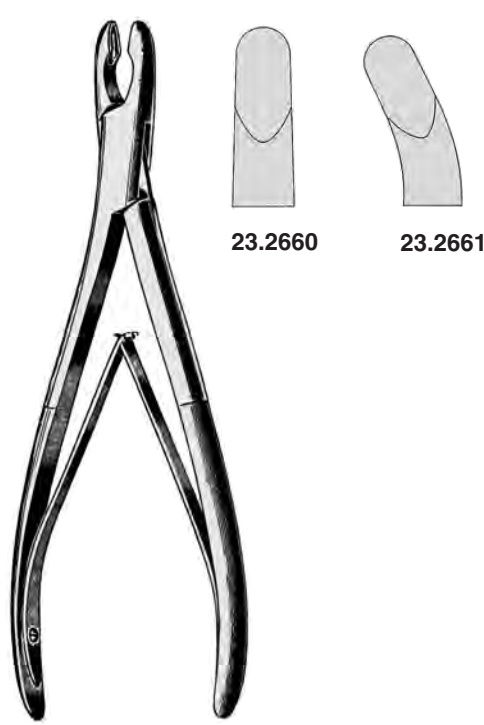

23.2660

23.2661

ADSON
20 cm

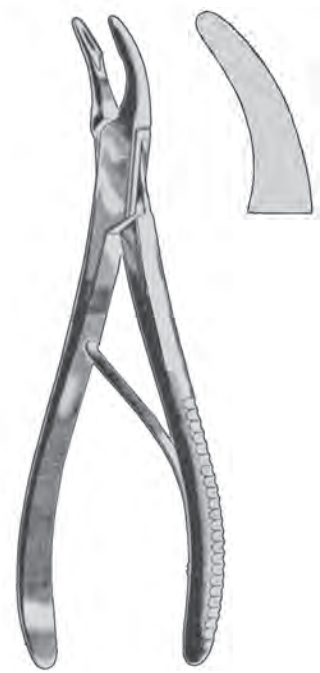

BANE
23.2665 18 cm



BACON
23.2667 20 cm



MARKWALDER
23.2670 20 cm



CLEVELAND
23.2680 14 cm #4



CLEVELAND
23.2682 17 cm #4A



BLUMENTHAL
23.2685 15,5 cm 30°



BLUMENTHAL
23.2687 15,5 cm 45°



BLUMENTHAL
23.2689 15,5 cm 90°



HARTMANN
23.2691 19 cm



BÖHLER
15 cm



23.2802
2 mm



23.2803
2 mm



23.2804
3 mm



23.2805
3 mm



BEYER
23.2831 18 cm



ZAUFAL-JANSEN
23.2833 18 cm



MAYFIELD
23.2835 18,5 cm



MARQUARDT
23.2837 20 cm



23.2840



23.2841

RUSKIN
18 cm



RUSKIN
23.2849 24 cm



STILLE-RUSKIN
23.2851 24 cm



23.2856



23.2857



23.2858

SMITH-PETERSEN
24 cm



23.2880

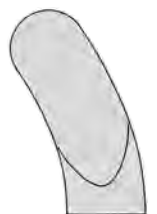

23.2881

STILLE-LUER
22 cm



23.2882 27 cm
23.2884 23 cm



23.2883 27 cm
23.2885 23 cm

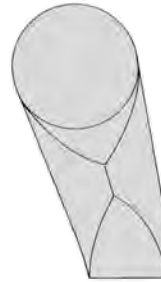

STILLE-LUER



SEMB
23.2887
23 cm



STILLE
23.2890
23 cm / 6 mm



FRYKHOLM
23.2893 24 cm



LEKSELL-STILLE
23 cm

23.2895
5 mm

23.2896
8 mm

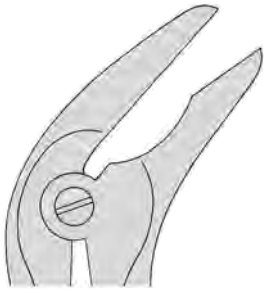

23.2902
2x10 mm



23.2903
3x10 mm



23.2904
4x10 mm



ECHLIN
23 cm

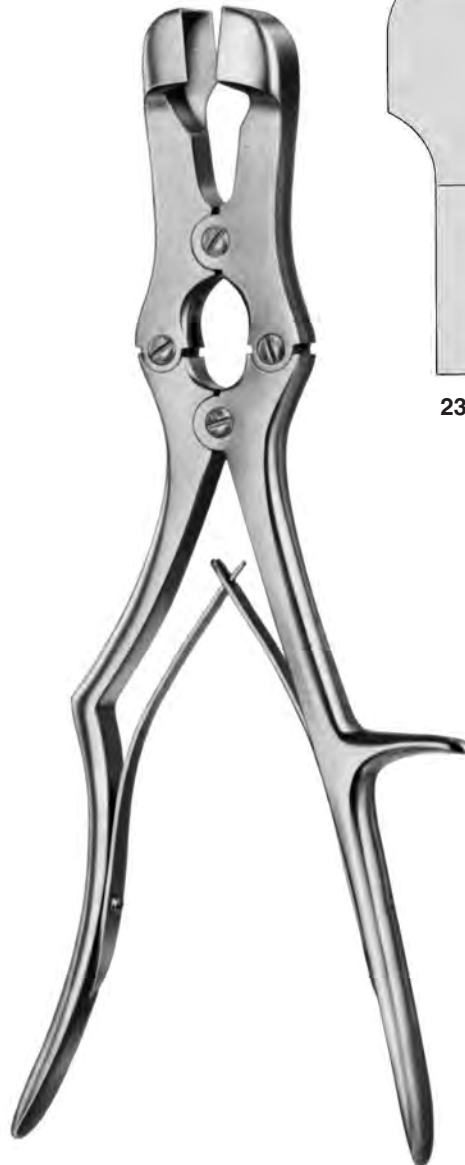

SAUERBRUCH
30 cm



23.2910

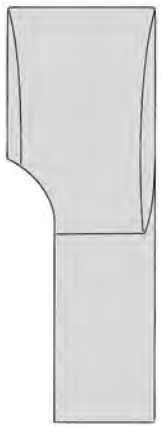

23.2912



COTTLE-KAZANJIAN
 23.3005 19 cm



LISTON
 23.3010 14 cm
 23.3012 17 cm
 23.3014 19 cm
 23.3016 22 cm



LISTON
 23.3011 14 cm
 23.3013 17 cm
 23.3015 19 cm
 23.3017 22 cm



LITTAUER-LISTON
 23.3020 15 cm



CLEVELAND
 23.3050 17 cm #5



CLEVELAND
 23.3052 15 cm #5S



CLEVELAND
 16 cm



23.3054
 # 6A



23.3056
 # 6



BOEHLER
23.3100 15 cm



BOEHLER
23.3101 15 cm



McINDOE
23.3111 17,5 cm



RUSKIN-LISTON
19 cm



23.3122

23.3123



STILLE-LISTON
27 cm



23.3150



23.3151

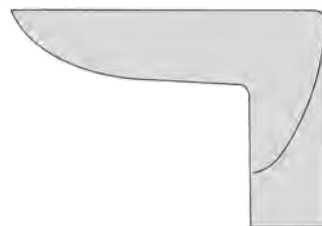

STILLE-HORSLEY
23.3161 27 cm



STILLE-HORSLEY
23.3162 27 cm 90°

geriefte Valven
Serrated blades
valves striées
valvas estriadas



COX
17.5210
12 cm

für Finger und Zehen
Finger- and Toe Retractor
pour doigts et orteils
para dedos

Bleihände
Lead hands
Mains operatoire de plomb
Manos de plomo

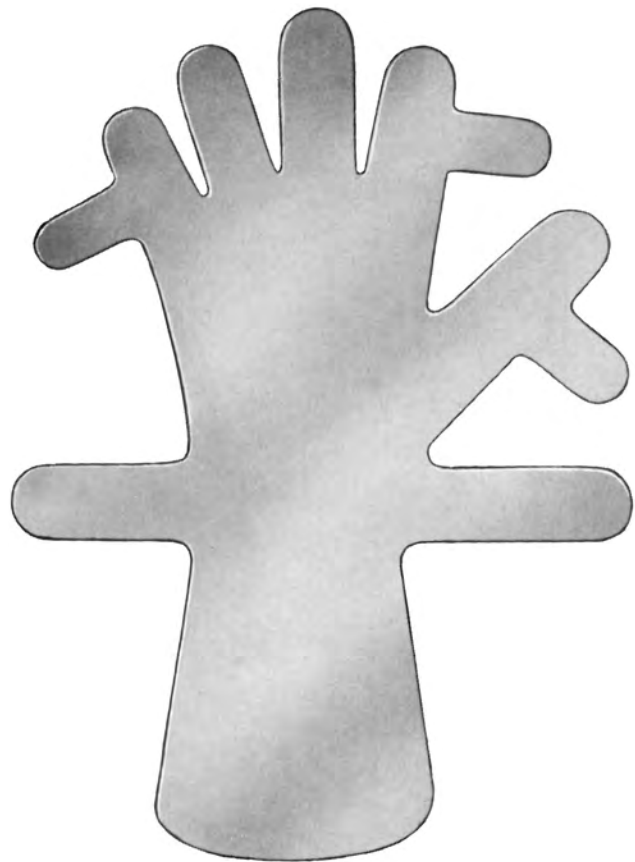

23.3290
Kinder
Child
Enfant
Ninos

23.3292
Erwachsene
Adult
Adulte
Adultos

Nagelbohrer komplett
 Nail Drill complete
 Perceuse à ongles, complète
 Taladro para uñas, completo



58.0309
 1 Satz Einzelbohrer
 Set of 3 drill points
 Jeu de 3 vrilles
 Juego de 3 trepanos

58.0300
 mit 3 Bohrern
 with 3 drill points
 avec 3 vrilles
 con 3 trepanos

Nagelausreißzange
 Nail Extracting Forceps
 Pince à extraction des ongles
 Pinza arranca-uñas



RADOLF
58.0320
 14 cm

Nagelspaltzange
 Nail Splitting Forceps
 Pince à ongles
 Pinza corta-uñas



ANVIL
58.0517
 14 cm

Fingerringsägen
 Finger Ring Saws
 Scies pour bagues
 Sierras para anillos



WALTON
58.0350
 16 cm



58.0360
 17 cm

Nagelspaltzschere
 Nail Splitting Scissors
 Ciseaux à fendre les ongles
 Tijera para hender las uñas

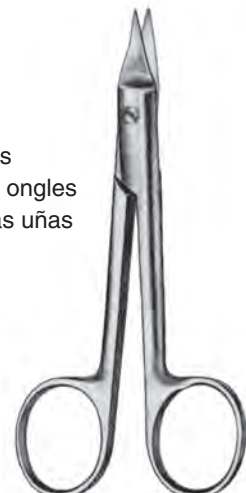

SYSTRUNK
58.0625
 13 cm

Sehnenfassinstrumente
 Tendon Seizing Instruments
 Pinces pour saisir les tendons
 Pinzas para coger tendones



CARROL
 23.3201 11 cm



BRAND

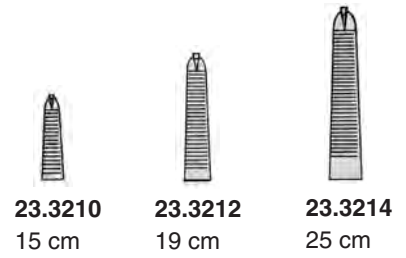

23.3210
 15 cm

23.3212
 19 cm

23.3214
 25 cm

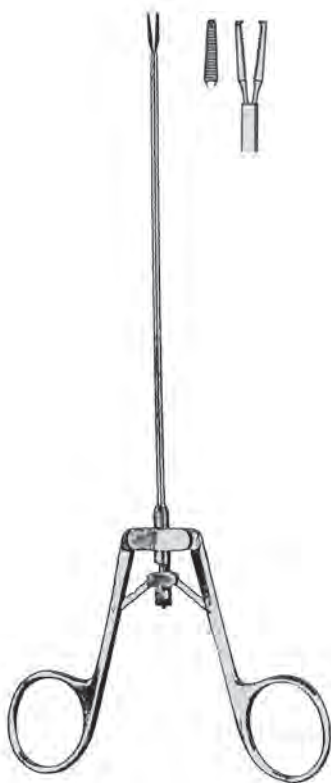

KLEINERT-KUTZ
 23.3216 20 cm



LARSEN
 10 cm



23.3222
 2 mm



23.3224
 4 mm

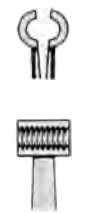

23.3223
 3 mm



23.3225
 5 mm

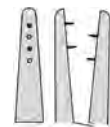

STEINMANN
 23.3230 13 cm



15 cm



23.3232



23.3233

Sehnenflechklemmen
Tendon Interlacing Forceps
Pincés pour entrelacer les tendons
Pinzas para entrelazar tendones

Sehenschäler
Tendon Stripper
Strippers à tendons
Mondador de tendones

Sehnenführer
Tendon Guide
Conducteur à tendons
Conductor de tendones



BUNNELL

-  **23.3242**
2 mm
-  **23.3243**
3 mm
-  **23.3244**
4 mm
-  **23.3245**
5 mm
-  **23.3246**
6 mm
-  **23.3247**
7 mm



BUNNELL
23.3250 23 cm

Extensionsbügel für Finger zur
Verwendung mit KIRSCHNER Drähten

Traction bows for fingers for use with
KIRSCHNER wires

Etriers de traction pour doigts avec
broches de KIRSCHNER

estribos para extensión de dedos para
agujas de KIRSCHNER

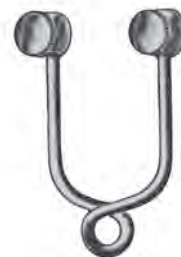

SCHWARZ
23.3260 60 mm
23.3262 75 mm



SCHWARZ
23.3264 160 mm

Wund- und Meniskushaken
Retractors for knee
Ecarteurs pour genou
Separadores para rodilla



SMILLIE
14 cm

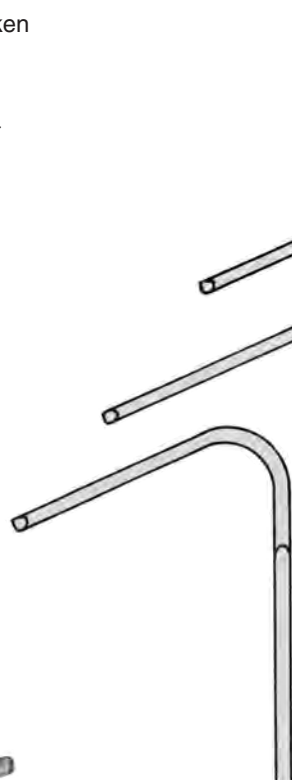

23.3301
#1

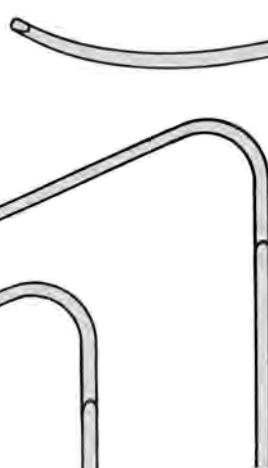

23.3302
#2

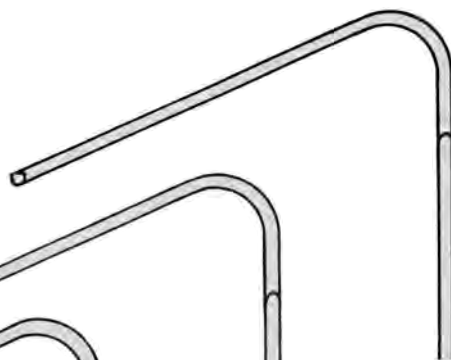

23.3303
#3



23.3304
#4



23.3305
#5



BLOUNT
23.3310 18 cm



38 x 9 mm

23.3312
21 cm

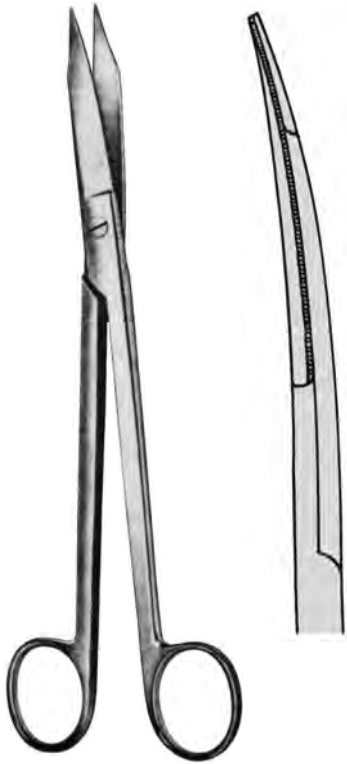

MARTIN
23.3320 20 cm



RESANO
23.3325 25 cm



MARTIN
23.3354 20 cm

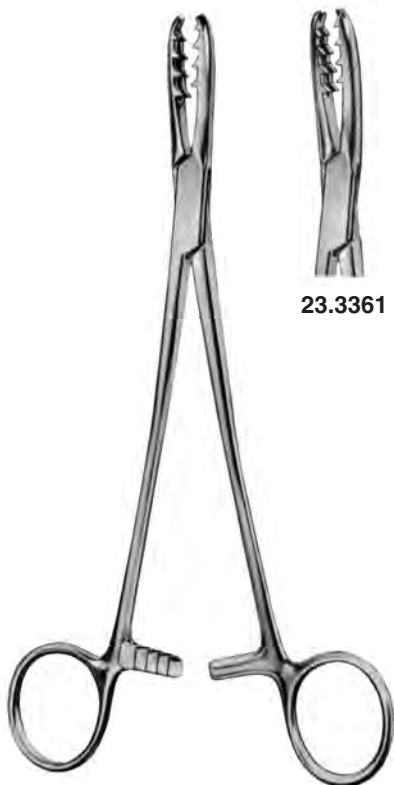

BIRCHER-GANSKE
23.3360 20 cm



BIRCHER-GANSKE
23.3363 20 cm

Meniskotome
 Meniscotomy Knives
 Meniscotomes
 Bisturios para meniscos



LOWE-BRECK
 23.3380 25 cm



DOWNING
 23.3381 25 cm



23.3383
 18 cm



23.3400



23.3402



SMILLIE
 17 cm



23.3396



23.3397



23.3398



NEFF
 22 cm



SALNIUS
23.3410
22 cm



SALNIUS
23.3412
22 cm



BIRCHER
23.3421
20 cm

Knochendraht, in Ringen à 10 m, weich
 Bone wire, in coils of 10 mtr. (33 ft.), soft
 Fil à cerclage, souple, en rouleaux de 10 m
 Hilo para huesos, blando, en rollos de 10 m



- 23.4002 10 m / 0,2 mm
- 23.4003 10 m / 0,3 mm
- 23.4004 10 m / 0,4 mm
- 23.4005 10 m / 0,5 mm
- 23.4006 10 m / 0,6 mm
- 23.4007 10 m / 0,7 mm
- 23.4008 10 m / 0,8 mm
- 23.4009 10 m / 0,9 mm
- 23.4010 10 m / 1,0 mm
- 23.4012 10 m / 1,2 mm
- 23.4015 10 m / 1,5 mm



LOUTE
 23.4050 21 cm

Drahtspanner
 Wire-Tighteners
 Tendeurs serre-fil
 Tensores sierra-hilo

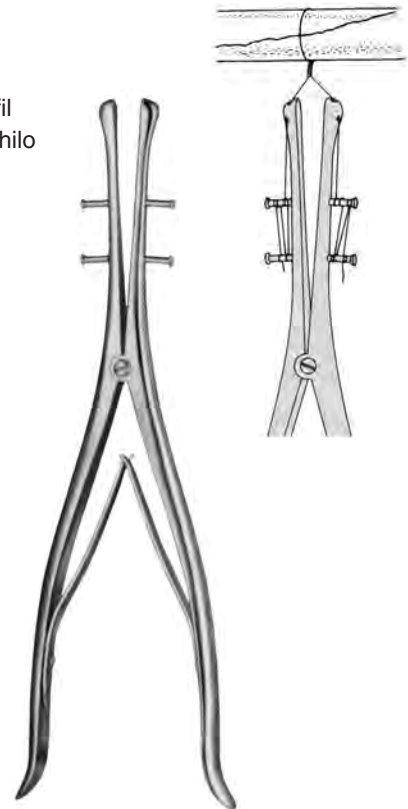

DEMEL
 23.4060 28 cm

Drahtumführungsadeln – Wire Guides – Aiguilles passe-fils – Agujas passa-hilos



DEMEL
 28 cm

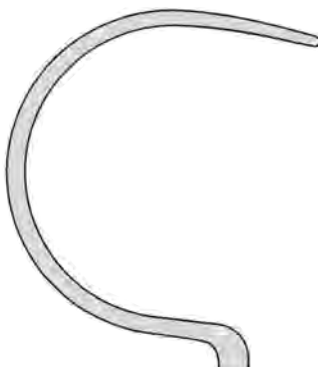

23.4070
 #1

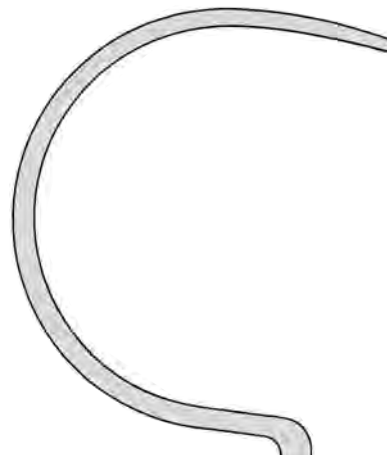

23.4072
 #2

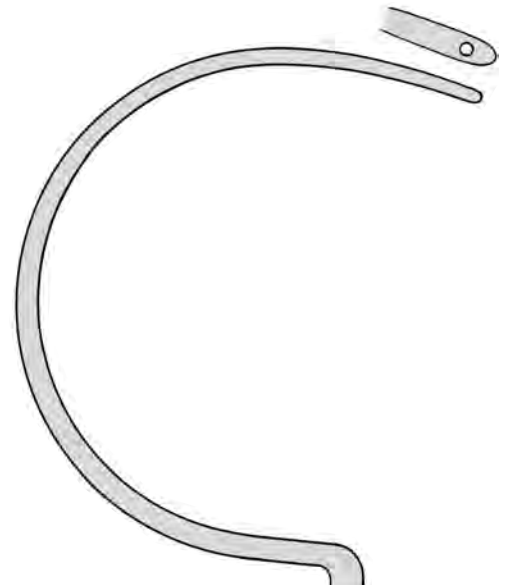

23.4074
 #3

Drahtumföhrungsnadeln / Wire Guides / Aiguilles passe-fils / Agujas passa-hilos

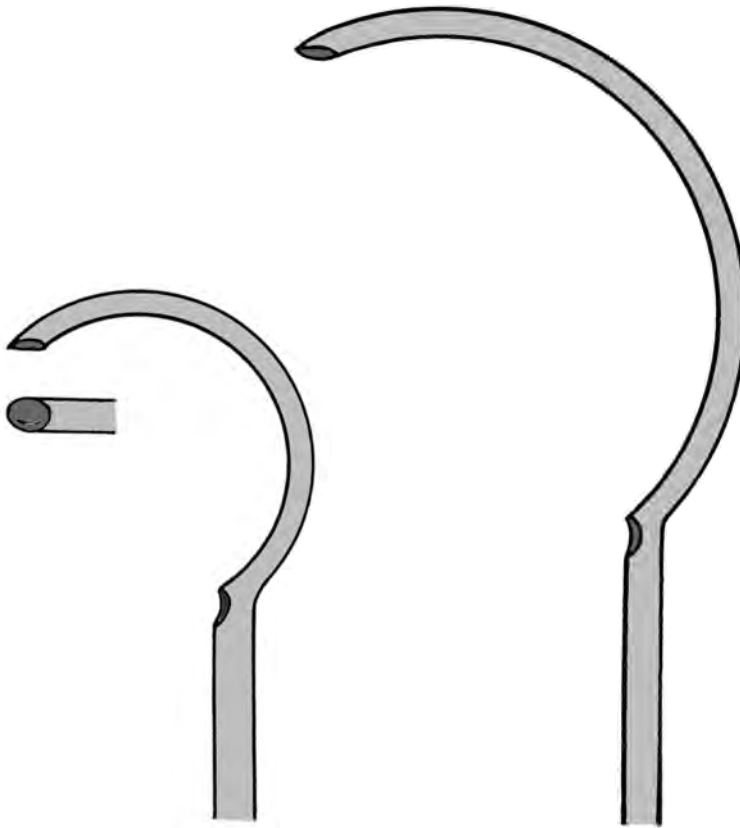

23.4080
24 cm

23.4082
27 cm



23.4085
22 cm



23.4130 14,5 cm
PROME(DUR)



23.4135 14,5 cm



23.4150 14 cm



DIAMOND
23.4160 16 cm
PROME(DUR)

für harten Draht bis Ø
 hard wire up to Ø
 fils durs jusqu'à Ø
 para duros hasta Ø

1,0

1,0

1,0

für weichen Draht bis Ø
 soft wire up to Ø
 fils moux jusqu'à Ø
 para blandos hasta Ø

1,5

1,5

1,5



23.4166 18 cm
PROME(DUR)



ZIEGLER
23.4170 18 cm
PROME(DUR)



ZIEGLER
23.4171 22 cm
PROME(DUR)



HARVEY
23.4172 23 cm
PROME(DUR)

1,5

1,7

1,8

2,2

2,0

2,0

2,5

3,0

Kopfschneider – Front Cutters – Pincas à couper frontales – Alicates de cortar frontal



23.4190 15 cm
PROME(DUR)



DIAMOND
23.4196 21,5 cm
PROME(DUR)



23.4270 25 cm
PROME(DUR)

23.4272 38 cm
PROME(DUR)

für harten Draht bis Ø
 hard wire up to Ø
 fils durs jusqu'à Ø
 para duros hasta Ø

1,5

2,5

4,0

4,5

für weichen Draht bis Ø
 soft wire up to Ø
 fils moux jusqu'à Ø
 para blandos hasta Ø

2,0

3,5



23.4290 56 cm
PROME(DUR)

23.4292 45 cm
PROME(DUR)

6,0

5,0



23.4205
 18 cm
 5 mm



23.4207
 18 cm
 7 mm



23.4210
 18 cm



23.4213
 18 cm
 2,5 mm
PROME(DUR)



23.4214
 18 cm
 3,5 mm
PROME(DUR)



23.4217
 18 cm
 7 mm
PROME(DUR)



MATHIEU
23.4218
 20 cm **PROME(DUR)**



RUBIO
23.4219
 13 cm **PROME(DUR)**



MAYO-HABERISSER

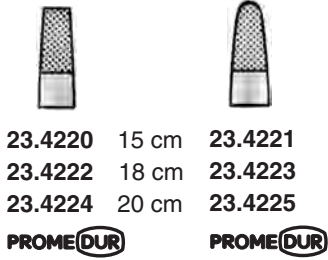

23.4220 15 cm
23.4222 18 cm
23.4224 20 cm

23.4221
23.4223
23.4225

PROME(DUR) PROME(DUR)



23.4230
17 cm



23.4232
17 cm

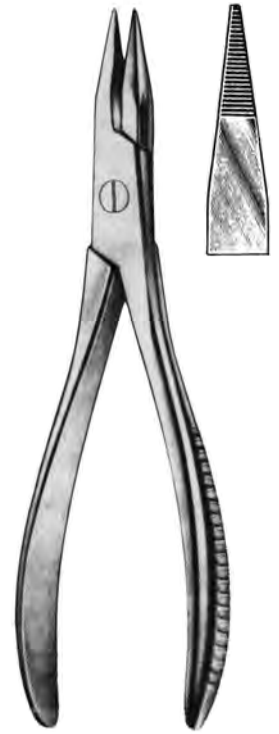

23.4235
19 cm

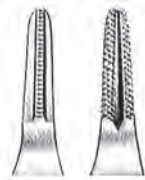

23.4236
13 cm

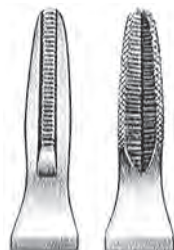

23.4238
18 cm



23.4239
17 cm PROME(DUR)



34.5120
15 cm



34.5124
15 cm



34.5122
15 cm



34.5126
18 cm

PROME(DUR)



23.4253
18 cm



23.4255
18 cm

für Draht bis 1,6 mm Ø
wire up to 1,6 mm Ø
fils jusqu'à 1,6 mm Ø
para hasta 1,6 mm Ø



23.4262
18 cm



23.4263
20 cm



23.4264
24 cm

Feststellzangen – Locking Pliers – Pincas auto-serrantes – Pinzas para hilos auto-cerrante

Spitzmaulzangen
Needle-nosed pliers
Pincès à bouts pointus
Pinzas con bocas agudas



23.4265
22 cm



23.4266
25 cm



23.4267
30 cm

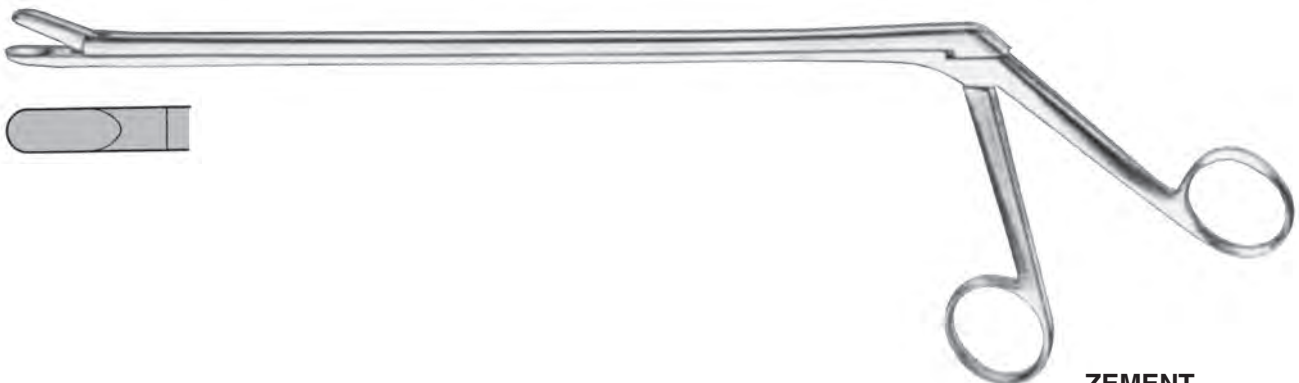

ZEMENT
23.2800
25 cm / 5x10 mm

Bohrdrahtspender
Wire-dispenser
Dispensateur pour broches
Distribuidor para taladros



L = cm	0,9 mm	1,0 mm	1,1 mm	1,2 mm	1,3 mm	1,4 mm	1,5 mm	1,6 mm	1,7 mm	1,8 mm	1,9 mm	2,0 mm	2,2 mm	2,5 mm
	Ø	Ø	Ø	Ø	Ø	Ø	Ø	Ø	Ø	Ø	Ø	Ø	Ø	Ø
18	23.4409	23.4410	23.4411	23.4412	23.4413	23.4414	23.4415	23.4416	23.4417	23.4418	23.4419	23.4420	23.4422	23.4425
32	23.4429	23.4430	23.4431	23.4432	23.4433	23.4434	23.4435	23.4436	23.4437	23.4438	23.4439	23.4440	23.4442	23.4445

	mm Ø	L = 6 cm	L = 12 cm	L = 14 cm	L = 16 cm	L = 31 cm	
 KIRSCHNER	Trokarspitze	0,6	23.4446				
	Trocar tip	0,7	23.4447	23.4467	23.4487	23.4507	
	Pointe trocar	0,8	23.4448	23.4468	23.4488	23.4508	
	Punta en forma de trocar	0,9	23.4449	23.4469	23.4489	23.4509	23.4539
		1,0	23.4450	23.4470	23.4490	23.4510	23.4540
		1,1	23.4451	23.4471	23.4491	23.4511	23.4541
		1,2	23.4452	23.4472	23.4492	23.4512	23.4542
		1,3	23.4453	23.4473	23.4493	23.4513	23.4543
		1,4	23.4454	23.4474	23.4494	23.4514	23.4544
		1,5	23.4455	23.4475	23.4495	23.4515	23.4545
		1,6	23.4456	23.4476	23.4496	23.4516	23.4546
		1,7	23.4457	23.4477	23.4497	23.4517	23.4547
		1,8	23.4458	23.4478	23.4498	23.4518	23.4548
	1,9	23.4459	23.4479	23.4499	23.4519	23.4549	
	2,0	23.4460	23.4480	23.4500	23.4520	23.4550	
	2,2	23.4462	23.4482	23.4502	23.4522	23.4552	
	2,5	23.4465	23.4485	23.4505	23.4525	23.4555	

	mm Ø	L = 31 cm
 KIRSCHNER	Lanzenspitze	0,9
	Lancet tip	1,0
	Pointe lancéolaire	1,1
		1,2
	Punta lanceolar	1,3
		1,4
		1,5
		1,6
		1,7
		1,8
		1,9
		2,0
		2,2
		2,5

weitere Ausführungen auf Anfrage

please ask us for additional models/combinations

d'autres modèles sur demande

pregunten por otros modelos

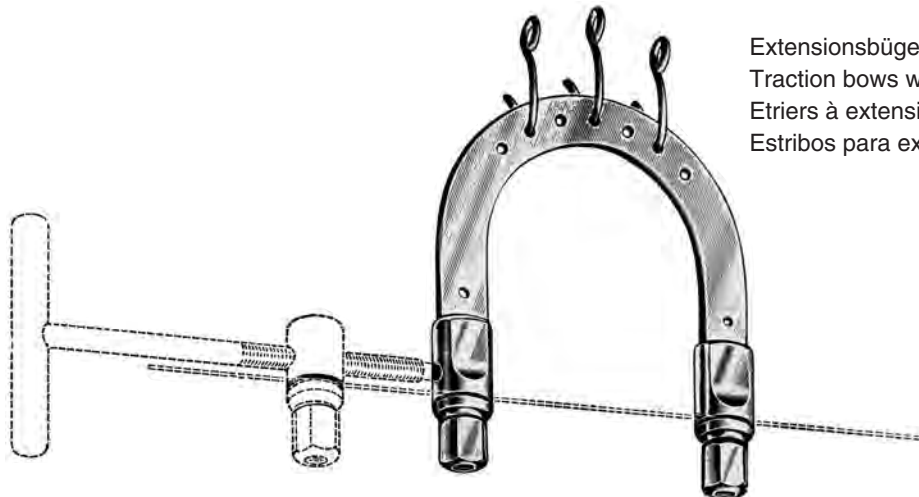

Extensionsbügel mit 3 Zughaken
Traction bows with 3 traction hooks
Etriers à extension avec 3 crochets de traction
Estribos para extensión con 3 ganchos de tracción



KIRSCHNER
23.4607 60 x 50 mm



Spannschlüssel
Wire tightener
Tendeur de broches
Tensor de alambres

KIRSCHNER
23.4608

- KIRSCHNER**
23.4600 200 x 155 mm
23.4601 155 x 155 mm
23.4602 135 x 130 mm
23.4603 120 x 120 mm
23.4604 105 x 105 mm
23.4605 95 x 110 mm
23.4606 95 x 70 mm

Fixierscheiben (Paar)
Fixation discs (pair)
Disques à fixation paire
Discos fijadores (par)



KIRSCHNER
23.4617



KIRSCHNER
23.4609

Spannschlüssel
Wrench
Clef plate
Llave de tuercas



23.4610 18 x 10 cm
23.4611 27 x 16 cm



KIRSCHNER
23.4614



KIRSCHNER
23.4615

Zughaken
Traction hooks
Crochet de traction
Ganchos de tracción



KIRSCHNER
23.4618

max. Öffnung
max. jaw opening
ouverture max.
apertura max.

130 mm
185 mm
220 mm

US-Mod. klein
US-Mod. gross
US-Mod. X-Gross



STEINMANN Nägel
STEINMANN pins
STEINMANN clous à os
STEINMANN chiodi per ossa

L = cm	
8	24.2840
10	24.2841
12	24.2842
14	24.2843
15	24.2844
16	24.2845
18	24.2846
20	24.2847
21	24.2848

STEINMANN
Ø 4 mm

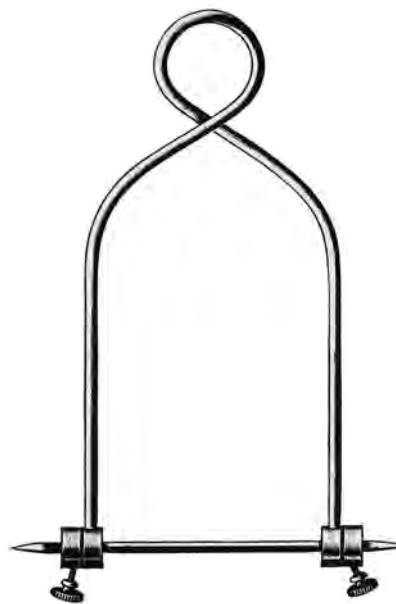

BOEHLER
24.2959 90 x 75 mm
24.2960 160 x 90 mm
24.2962 210 x 110 mm

Extensionsbügel zur Verwendung mit STEINMANN Nägeln
Traction bows for use with STEINMANN pins
Etriers de traction à utiliser avec clous de STEINMANN
Estribos para extensión para clavos de STEINMANN

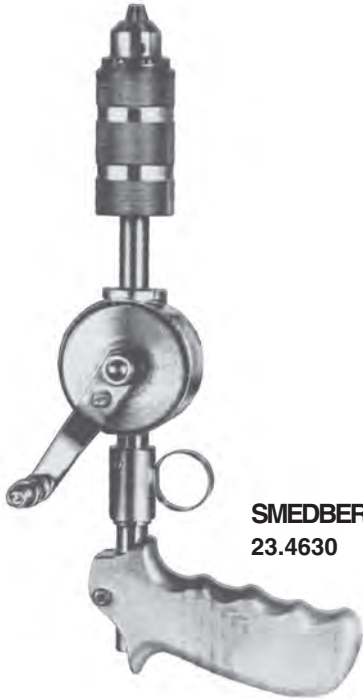

SMEDBERG
23.4630



23.4651

KIRSCHNER
23.4650



23.4661

KIRSCHNER
23.4660

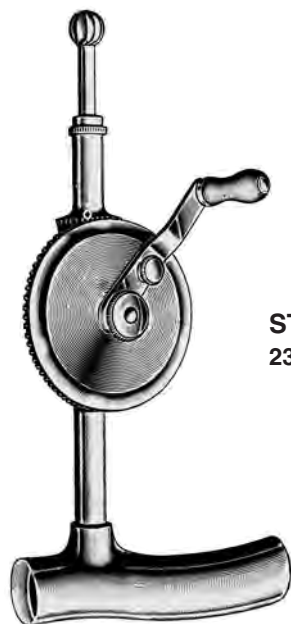

STILLE
23.4670



STILLE-SHERMAN
23.4675



MOORE
 23.4680



23.4685

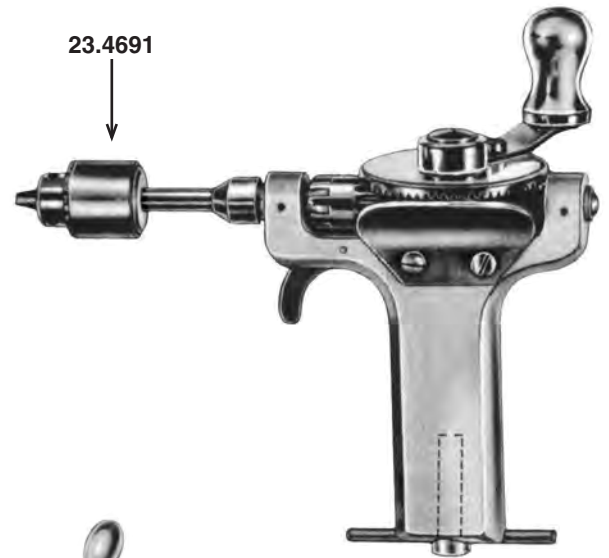

BUNNELL
 23.4690

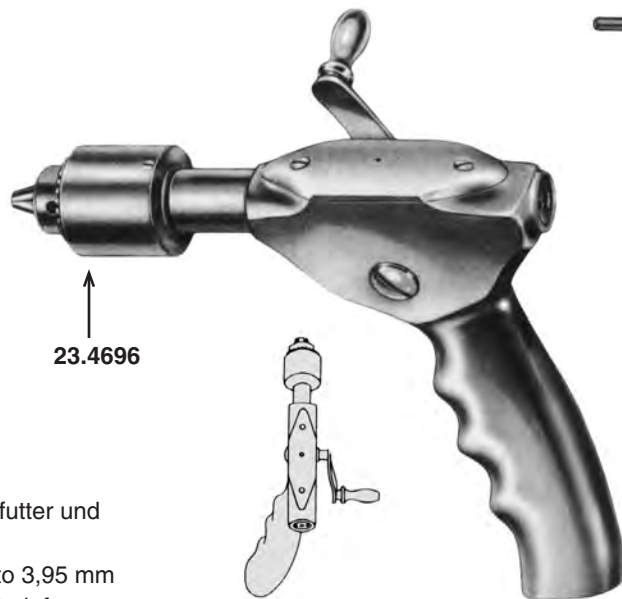

RALK
 23.4695

23.4696

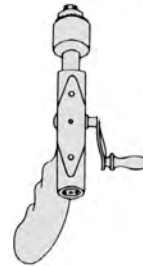

23.4697 14 cm
 Handgriff mit Dreibackenspannfutter und Schlüssel bis 3,95 mm
 Handle with chuck and key up to 3,95 mm
 Poignée en "T" avec mandrin et clef ouverture max. : 3,95 mm
 Perforador a mano con mandril y llave hasta 3,95 mm

23.4699
 Ersatzschlüssel
 Spare wrench
 Clef de rechange
 Llave de repuesto



23.4700 12 cm
 Handgriff mit Dreibackenspannfutter und Schlüssel bis 6,35 mm
 Handle with chuck and key up to 6,35 mm
 Poignée en "T" avec mandrin et clef ouverture max. : 6,35 mm
 Perforador a mano con mandril y llave hasta 6,35 mm

23.4701
 Ersatzschlüssel
 Spare wrench
 Clef de rechange
 Llave de repuesto



23.4702 16 cm / 6,35 mm



- 23.4770 1,0 mm
- 23.4772 1,5 mm
- 23.4774 2,0 mm
- 23.4776 2,5 mm
- 23.4777 2,7 mm
- 23.4778 3,0 mm
- 23.4779 3,2 mm
- 23.4780 3,5 mm
- 23.4781 4,0 mm
- 23.4782 4,5 mm
- 23.4783 5,0 mm



ADSON

23.4990 15 cm

Bohrerführungs- und Dura-Schutzzange
Drill guide and dura protecting forceps
Pince-guide mèche et protège dure-mère
Pinza-guia para taladros y para proteger la dura-madre

Reibahlen
Reamers
Pointes-carrées
Escariadores



23.4996 14 cm



23.4997 14 cm



PERTHES

23.4998 21,5 cm



24.0800
28 cm / 8 mm

Vorbohrer zum Öffnen der
Markhöhle für Unterschenkel
Reamer for medullary cavity
for the tibia
Perforateur initial pour clous
tibiaux
Punzon para la cavidad
medular para tibia



24.0802
36 cm / 10 mm

Aufreiber für Oberschenkel
Trochanteric reamer for femur
Alesoir pour le femur
Dilatador para femur



KÜNTSCHER
24.0810 460 / 3,0 mm
24.0811 600 / 3,5 mm
24.0812 600 / 4,0 mm
24.0813 600 / 5,0 mm

Führungsspieße für Nägel
Guide pins for nails
Mandrin conducteur pour
clous
Tallo-guias para clavos



24.0820
29 cm

Schlitzhammer
Slotted hammer
Maillet, fendu
Martillo con ranura

Vorschläger
 Nail driver
 Chasse-clou
 Impactor



KÜNTSCHNER
 24.0825
 20 cm

Vorschläger mit Schlitz
 Slotted nail driver
 Chasse-clou avec cale-
 guide
 Impactor con ranura



KÜNTSCHNER
 24.0827
 20 cm

Fertigschläger
 Nail impactor
 Impacteur
 Impactor final

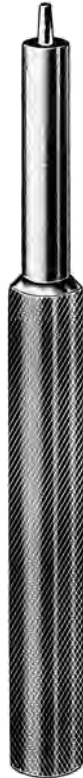

KÜNTSCHNER
 24.0828
 19 cm



KÜNTSCHNER
 24.0840



24.0841



24.0842



24.0843

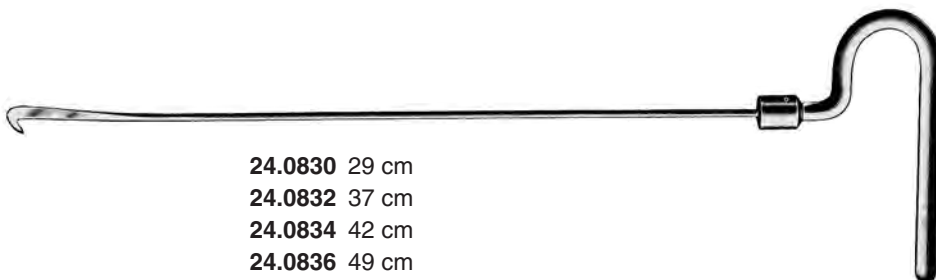

24.0830 29 cm
 24.0832 37 cm
 24.0834 42 cm
 24.0836 49 cm



24.0850
 Hautschutzplatte
 Skin protector
 Tôle pour protéger les tissus
 Protector de piel

Markraumbohrer / Medullary Canal Reamers /
 Alésoirs pour le forage du canal médullaire / Perforadores el canal medular

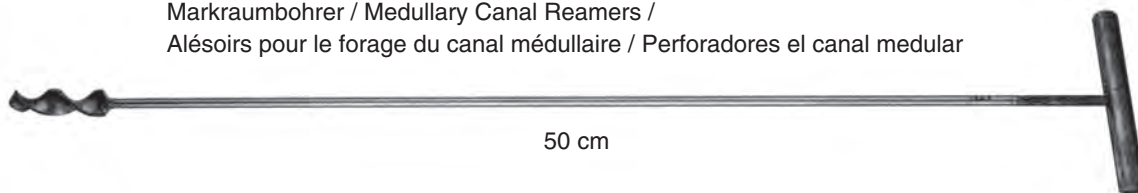

50 cm

Ø	6 mm	7 mm	8 mm	9 mm	10 mm	11 mm
	24.0886	24.0887	24.0888	24.0889	24.0890	24.0891
Ø	12 mm	13 mm	14 mm	15 mm	16 mm	
	24.0892	24.0893	24.0894	24.0895	24.0896	



Feststellzangen
 Locking pliers
 Pinces auto-serrantes
 Pinzas auto-cerrantes

24.0962 18 cm
24.0963 20 cm
24.0964 24 cm



24.0965 22 cm
24.0966 25 cm
24.0967 30 cm



Extraktionshämmer mit Feststellzangen
 Extraction Hammers with Locking Pliers
 Marteaux à extraction avec pinces auto-serrantes
 Martillos para extracción con pinzas auto-cerrantes

EXTRACTION-HAMMER

24.0950 35 cm / 400 g
24.0952 45 cm / 700 g

EXTRACTION SETS

24.0954 = (24.0950+24.0962)
24.0955 = (24.0950+24.0963)
24.0956 = (24.0952+24.0964)
24.0957 = (24.0950+24.0965)
24.0958 = (24.0950+24.0966)
24.0959 = (24.0952+24.0967)



24.1000 6,4 mm Ø, Satz, 9 Nägel,
Set, 9 pins
Jeu, 9 broches
Juego, 9 clavos

24.1020 4,8 mm Ø Satz, 9 Nägel,
Set, 9 pins
Jeu, 9 broches
Juego, 9 clavos

24.1040 3,2 mm Ø Satz, 13 Nägel,
Set, 13 pins
Jeu, 13 broches
Juego, 13 clavos

24.1060 2,4 mm Ø Satz, 13 Nägel,
Set, 13 pins
Jeu, 13 broches
Juego, 13 clavos

6,4 mm Ø

24.1001	250 mm
24.1002	265 mm
24.1003	280 mm
24.1004	295 mm
24.1005	315 mm
24.1006	335 mm
24.1007	355 mm
24.1008	375 mm
24.1009	390 mm
24.1010	410 mm
24.1011	430 mm

4,8 mm Ø

24.1021	205 mm
24.1022	220 mm
24.1023	240 mm
24.1024	255 mm
24.1025	280 mm
24.1026	295 mm
24.1027	315 mm
24.1028	335 mm
24.1029	355 mm

3,2 mm Ø

24.1041	100 mm
24.1042	115 mm
24.1043	125 mm
24.1044	140 mm
24.1045	150 mm
24.1046	165 mm
24.1047	180 mm
24.1048	190 mm
24.1049	205 mm
24.1050	215 mm
24.1051	235 mm
24.1052	240 mm
24.1053	255 mm

2,4 mm Ø

24.1061	25 mm
24.1062	30 mm
24.1063	40 mm
24.1064	45 mm
24.1065	50 mm
24.1066	60 mm
24.1067	65 mm
24.1068	70 mm
24.1069	75 mm
24.1070	85 mm
24.1071	90 mm
24.1072	95 mm
24.1073	100 mm



24.1075 6,4 mm
24.1076 4,8 mm
24.1077 3,2 mm
24.1078 2,4 mm
 Vorbohrer
 Reamers
 Alesoir pour avant-trou
 Perforador inicial

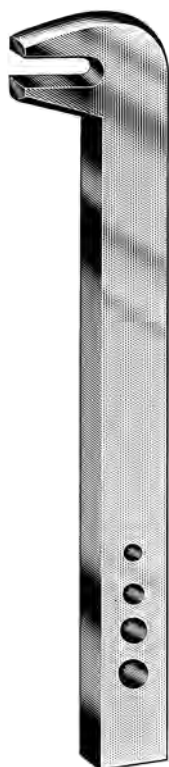

24.1079
 Biegehebel
 Bender for
 intramedullary pins
 Levier pour modeler
 les clous
 Palanca para plegar
 clavos

Ein- und Ausschlag-Instrumente
 Impactors - Extractors
 Impacteurs - Extracteurs
 Impactor - Extractores



24.1080
 6,4 mm



24.1081
 4,8 mm



24.1082
 3,2 mm



24.1083
 2,4 mm



24.1086
20 cm

Stabhaltezange
Rod Gripping Forceps
Pince à saisir les broches
Pinza para coger clavos



24.1094
30,5 cm

Bolzenschneider zum Abwickeln von Drähten,
Schrauben, Nägeln usw. bis 3 mm
Cutter for cutting wires, screws, pins, etc. up to
3 mm dia.
Coupe-boulons pour couper les broches, vis,
etc. jusqu'à 3 mm dia.
Corta-alambre para cortar agujas, tornillos,
etc. hasta 3 mm de dia.



LANE
24.1090
Knochen-Plattenbiegehebel für 4 mm u. 8 mm Platten
Bending Iron for standard plates 4 mm and 8 mm
Levier pour plaques standard de 4 mm et 8 mm
Elevador para plegar las placas de 4 mm y 8 mm



LEPINE
24.1092

Biegeinstrumente
Bending instrument
Instrument pour courber les broches
Instrument para doblar clavos



24.1093
Biege- und Schränkinstrument
Plate Bending Press
Presse pour modeler les plaques
Prensa para plegar las placas



24.1095
20 cm
Biegezange für gerade Platten bis 1,6 mm
Bending Pliers for straight plates up to 1,6 mm
Pince pour modeler pour plaques - 1,6 mm
Pinza para modelar las placas - 1,6 mm

24.1096
24 cm
Biegezange für gerade Platten bis 3,0 mm
Bending Pliers for straight plates up to 3,0 mm
Pince pour modeler pour plaques - 3,0 mm
Pinza para modelar las placas - 3,0 mm

Halbrohrplatten mit Rundlöchern
Semi-tubular plates with round holes
Plaques semi-tubulaires à trous ronds
Placas semitubulares con orificios redondo

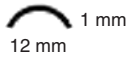

24.1200 - 24.1210

L = mm	Löcher / Holes	
	Trous / Orificios	
39	2	24.1200
55	3	24.1201
71	4	24.1202
87	5	24.1203
103	6	24.1204
119	7	24.1205
135	8	24.1206
151	9	24.1207
167	10	24.1208
183	11	24.1209
199	12	24.1210

Schmale Platten
Narrow plates
Plaques étroites
Placas estrechas



24.1242 - 24.1256

Gleitloch
Gliding holes
Trous à compression
Orificios para compresión

L = mm	Löcher / Holes		Gleitloch / Gliding holes	
	Trous / Orificios		Trous à compression / Orificios para compresión	
39	2		24.1242	
55	3		24.1243	
71	4		24.1244	
87	5		24.1245	
103	6		24.1246	
119	7		24.1247	
135	8		24.1248	
151	9		24.1249	
167	10		24.1250	
183	11		24.1251	
199	12		24.1252	
215	13		24.1253	
231	14		24.1254	
247	15		24.1255	
263	16		24.1256	

Breite Platten
 Broad plates
 Plaques larges
 placas anchas

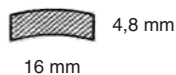

24.1285 - 24.1298

Gleitloch
 Gliding holes
 Trous à compression
 Orificios para compresión

L = mm	Löcher / Holes Trous / Orificios	Gleitloch / Gliding holes Trous à compression / Orificios para compresión
87	5	24.1285
103	6	24.1286
119	7	24.1287
135	8	24.1288
151	9	24.1289
167	10	24.1290
183	11	24.1291
199	12	24.1292
215	13	24.1293
231	14	24.1294
247	15	24.1295
263	16	24.1296
279	17	24.1297
295	18	24.1298

Mini-Fragment-Platten
Mini fragment plates
Plaques à fragments mini
Placas para fragmentos mini

Viertelrohrplatten
One-quarter tubular plates
Plaques d'un quart de tube
Placas de un cuarto de tubo



L = mm	Löcher / Holes Trous / Orificios	
23	3	24.1303
33	4	24.1304
41	5	24.1305
49	6	24.1306
57	7	24.1307
65	8	24.1308

Drittelrohrplatten
One-third tubular plates
Plaques d'un tiers de tube
Placas de un tercio de tubo



L = mm	Löcher / Holes Trous / Orificios	
25	2	24.1312
37	3	24.1313
49	4	24.1314
61	5	24.1315
73	6	24.1316
85	7	24.1317
97	8	24.1318
145	12	24.1322

Gerade Mini-Platten
Straight mini-plates
Mini-plaques droites
Mini-placas rectas



L = mm	Löcher / Holes Trous / Orificios	
17	3	24.1323
23	4	24.1324
29	5	24.1325
35	6	24.1326

Finger-Platten
Finger plates
Plaques à doigts
Placas para dedos



24.1331
L-förmig, links
L-shaped, left side
forme L, à gauche
forma L, a la izquierda



24.1332
L-förmig, rechts
L-shaped, right side
forme L, à droite
forma L, a la derecha



24.1333
schräg links
left side oblique
à gauche oblique
a la izquierda oblicua



24.1334
schräg rechts
right side oblique
à droite oblique
a la derecha oblicua



24.1341
T-förmig
T-shaped
forme T
forma T



24.1342
 15 x 1,2 mm

Mehrfragmentplatte
 Multi fragment plate
 Plaque à fragments multiples
 Placa para fragmentos múltiples

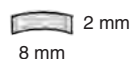

24.1402 - 24.1412

Kleinfragmentplatten
 Small fragment plates
 Plaques pour petits fragments
 Placas para fragmentos pequeños

L = mm	Löcher / Holes Trous / Orificios	
20	2	24.1402
36	4	24.1404
44	5	24.1405
52	6	24.1406
60	7	24.1407
68	8	24.1408
76	9	24.1409
84	10	24.1410
100	12	24.1412

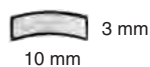

24.1422 - 24.1432

Finger-Platten
 Finger plates
 Plaques à doigts
 Placas para dedos

L = mm	Löcher / Holes Trous / Orificios	
25	2	24.1422
37	3	24.1423
49	4	24.1424
61	5	24.1425
73	6	24.1426
85	7	24.1427
97	8	24.1428
109	9	24.1429
121	10	24.1430
145	12	24.1432



24.1441
 L-förmig, links
 L-shaped, left side
 forme L, à gauche
 forma L, a la izquierda



24.1442
 L-förmig, rechts
 L-shaped, right side
 forme L, à droite
 forma L, a la derecha



24.1443
 schräg links
 left side oblique
 à gauche oblique
 a la izquierda oblicua



24.1444
 schräg rechts
 right side oblique
 à droite oblique
 a la derecha oblicua



24.1451
 T-förmig
 T-shaped
 forme T
 forma T

Winkelplatten
Angular plates
Plaques angulaires
Placas angulares

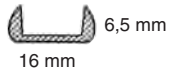
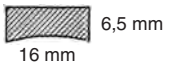

130°



Gleitloch / Gliding holes

Trous à compression / Orificios para compresión

KL	SL:			
	60 mm	104 mm	152 mm	200 mm
50 mm	24.1651			
60 mm	24.1652			
70 mm	24.1653	24.1673	24.1683	24.1693
75 mm	24.1654			
80 mm	24.1655	24.1675	24.1685	24.1695
85 mm	24.1656			
90 mm	24.1657	24.1677	24.1687	24.1697
95 mm	24.1658			
100 mm	24.1659			
105 mm	24.1660			
110 mm	24.1661			

Große Schrauben
 Large screws
 Vis grandes
 Tornillos grandes

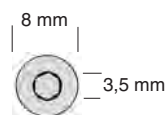
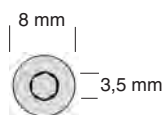

Corticalis- und Malleolarschrauben
 Corticalis and malleolar screws
 Vis corticales et malléolaires
 Tornillos corticales y maleolares



4,5 mm



4,5 mm

L = mm	DIN 58812 ISO 5835/1	DIN 58814 ISO 5835/1
14	24.2001	
16	24.2002	
18	24.2003	
20	24.2004	24.2030
22	24.2005	
24	24.2006	
25		24.2031
26	24.2007	
28	24.2008	
30	24.2009	24.2032
32	24.2010	
34	24.2011	
35		24.2033
36	24.2012	
38	24.2013	
40	24.2014	24.2034
42	24.2015	
44	24.2016	
45		24.2035
46	24.2017	
48	24.2018	
50	24.2019	24.2036
52	24.2020	
54		
55		24.2037
56	24.2022	
58	24.2023	
60	24.2024	24.2038
64	24.2026	
65		24.2039
70	24.2028	24.2040
80	24.2029	24.2041

Mutter
 Nut
 Ecrou
 Dado



24.2049
 11 mm

Große Schrauben
Large screws
Vis grandes
Tornillos grandes

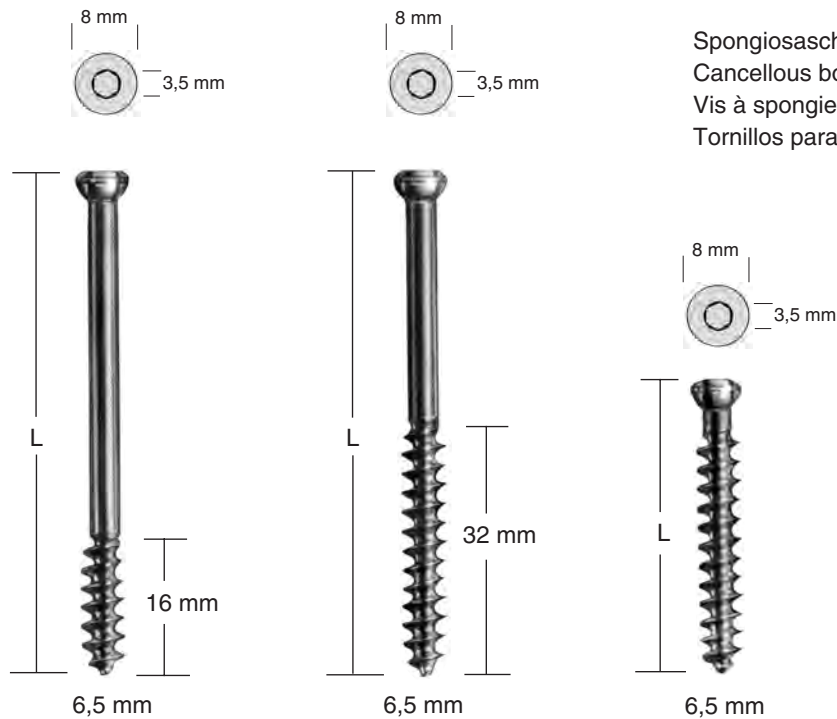

Spongiaschrauben
Cancellous bone screws
Vis à spongieuse
Tornillos para esponjosa

L = mm	DIN 58815 ISO 5835/1	DIN 58815 ISO 5835/1	
25			24.2090
30	24.2051		24.2091
35	24.2052		24.2092
40	24.2053		24.2093
45	24.2054	24.2073	24.2094
50	24.2055	24.2074	24.2095
55	24.2056	24.2075	24.2096
60	24.2057	24.2076	24.2097
65	24.2058	24.2077	24.2098
70	24.2059	24.2078	24.2099
75	24.2060	24.2079	24.2100
80	24.2061	24.2080	24.2101
85	24.2062	24.2081	24.2102
90	24.2063	24.2082	24.2103
95	24.2064	24.2083	24.2104
100	24.2065	24.2084	24.2105
105	24.2066	24.2085	24.2106
110	24.2067	24.2086	24.2107
115	24.2068		
120	24.2069		

Unterlegscheibe
Washer
Rondelle
Arandela



24.2109
13 mm

Knochenschrauben
 Bone screws
 Vis à os
 Tornillos para huesos

Corticalis

Spongiosa
 Cancellous

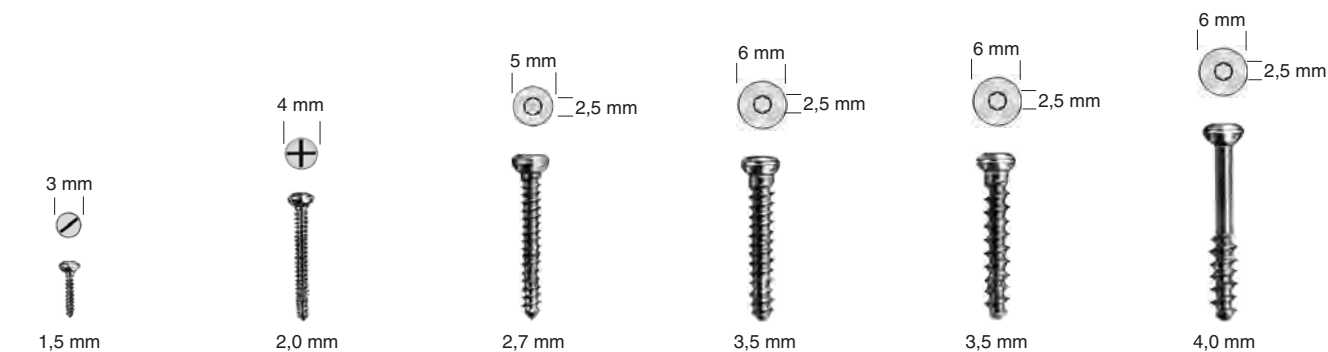

L = mm	DIN 58812 ISO 5835/1	DIN 58812 ISO 5835/1	DIN 58812 ISO 5835/1	DIN 58812 ISO 5835/1	DIN 58815 ISO 5835/1
6	24.2110	24.2130	24.2150		
7	24.2111				
8	24.2112	24.2132	24.2152		
9	24.2113				
10	24.2114	24.2134	24.2154	24.2174	24.2204
11	24.2115				
12	24.2116	24.2136	24.2156	24.2176	24.2206
14	24.2117	24.2137	24.2157	24.2177	24.2207
16	24.2118	24.2138	24.2158	24.2178	24.2208
18	24.2119	24.2139	24.2159	24.2179	24.2209
20	24.2120	24.2140	24.2160	24.2180	24.2210
22		24.2141	24.2161	24.2181	24.2211
24		24.2142	24.2162	24.2182	24.2212
26			24.2163	24.2183	24.2213
28			24.2164	24.2184	24.2214
30			24.2165	24.2185	24.2215
32			24.2166	24.2186	24.2216
34				24.2187	
35					24.2247
36				24.2188	24.2217
38				24.2192	
40				24.2189	24.2218
42				24.2193	
45				24.2190	24.2219
48				24.2194	
50				24.2191	24.2220
55					24.2221
60					24.2222

Unterlegscheibe
 Washer
 Rondelle
 Arandela



24.2251
 7 mm



LANE
 24.2252 23 cm

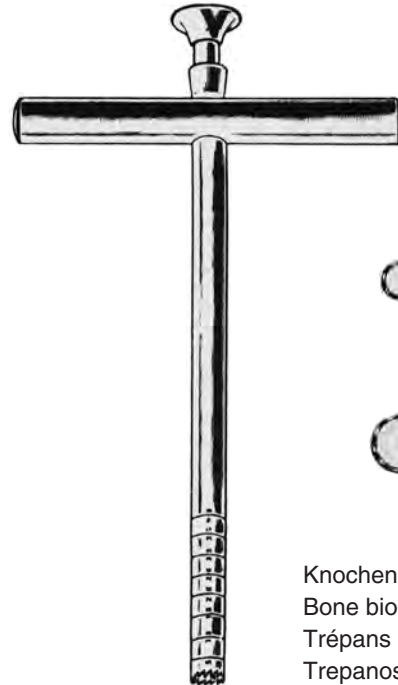

Ø 5 mm

Ø 8 mm

Knochenbiopsie-Instrumente
 Bone biopsy trephines
 Trépanos pour biopsie osseuse
 Trepanos para biopsia osea

24.2255 20 cm / Ø 5 mm

24.2256 20 cm / Ø 8 mm



LANE
 24.2258 18 cm



Gewindeschneider
 Gimlets
 Tarauds
 Tarauds

24.2262 14 cm / 2,7 mm

24.2264 16 cm / 3,5 mm

24.2267 18 cm / 4,5 mm

24.2268 22 cm / 6,5 mm



PHILLIPS
24.2270
25 cm

Schraubendreher
Screw drivers
Tournevis
Destornilladores



24.2271
17 cm



LANE
24.2272
25 cm



LANE
24.2273
25 cm



24.2274
20 cm / 1,5 mm
24.2275
25 cm / 2,5 mm
24.2276
25 cm / 3,5 mm



23.0990 15 cm
 Reinigungsinstrument
 Scaler
 Instrument pour nettoyer
 Instrumento para limpiar



24.2254 8 cm
 Schraubenhaltepinzette, selbthaltend
 Screwholding Forceps self-holding
 Pince-porte-vis autostatique
 Pinza porta-tornillos autostatica



24.3050 9 cm
 Griffstück für Gewindeschneider
 Tap Handle
 Poignée pour taraud
 Gira Macho



Schraubenmessgerät bis
 Screw depth gauge up to
 Appareil pour mesureur vis jusqu'à
 Medidor para tornillos hasta

24.3071	30 mm
24.3072	50 mm
24.3073	100 mm
24.3074	120 mm

NEUROCHIRURGIE

NEUROSURGERY

NEUROCHIRURGIE

NEUROCIRUGIA



ADSON
27.0056
21 cm / 4 mm
Charr. / Fr. 12



ADSON
27.0057
21 cm / 4 mm
Charr. / Fr. 12



27.0070
1,8 + 1,8 mm



27.0071
2,5 + 2,0 mm



27.0072
3,0 + 2,0 mm



FRAZIER
27.0066 10 cm / 2,0 mm
27.0067 10 cm / 2,5 mm
27.0068 10 cm / 3,0 mm



HOUSE
18 cm



HOUSE
27.0073 9 cm / 0,9 + 0,7 mm
27.0074 9 cm / 1,2 + 0,9 mm
27.0075 9 cm / 1,5 + 1,2 mm



FISCH
27.0076 9 cm / 1,8 + 1,8 mm
27.0077 9 cm / 2,5 + 2,0 mm
27.0078 9 cm / 3,0 + 2,0 mm
27.0079 9 cm / 4,5 + 2,0 mm



27.0094
 Ø 0,4 mm



27.0096
 Ø 0,6 mm



27.0098
 Ø 0,8 mm



WULLSTEIN

27.0090 Mikro-Absaugrohr komplett, bestehend aus:
 27.0091 Absaugrohr mit Luer-Bohrung
 27.0094 Mikro-Saugkanüle 0,4 mm
 27.0096 dito 0,6 mm
 27.0098 dito 0,8 mm

Micro-canule aspiratrice complète, comprenant de:
 27.0091 Tube à aspiration, embout Luer
 27.0094 Micro-canule 0,4 mm
 27.0096 dito 0,6 mm
 27.0098 dito 0,8 mm

Micro-suction tube, complete, consisting of:
 27.0091 Suction tube with Luer hub
 27.0094 Micro suction cannula 0,4 mm
 27.0096 ditto 0,6 mm
 27.0098 ditto 0,8 mm

Aspirador micro, complete, compuesto de:
 27.0091 Tubo de aspiración micro para cono Luer
 27.0094 Canula de aspiración micro 0,4 mm
 27.0096 idem 0,6 mm
 27.0098 idem 0,8 mm

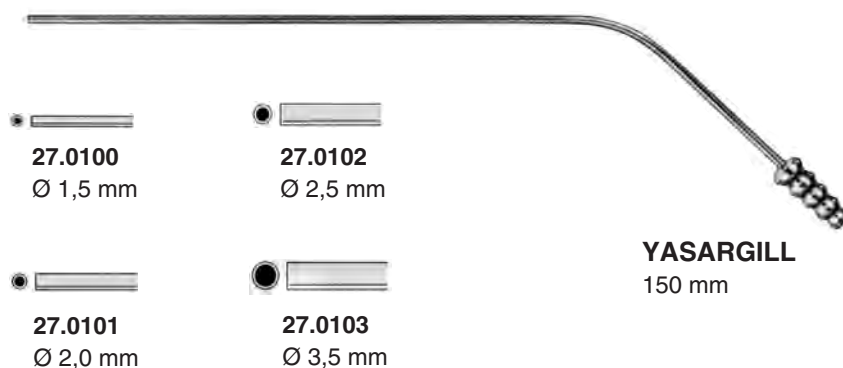

27.0100
 Ø 1,5 mm

27.0102
 Ø 2,5 mm

27.0101
 Ø 2,0 mm

27.0103
 Ø 3,5 mm

YASARGILL
 150 mm

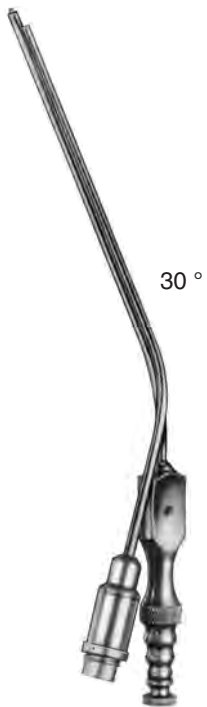

FRAZIER

mit Kaltlicht
with fiber optics
avec lumière froide
con luz fria

- 27.0152** 8 Charr. / Fr.
- 27.0154** 10 Charr. / Fr.
- 27.0156** 12 Charr. / Fr.



FRAZIER

- 27.0170** 6 Charr. / Fr.
- 27.0171** 7 Charr. / Fr.
- 27.0172** 8 Charr. / Fr.
- 27.0173** 9 Charr. / Fr.
- 27.0174** 10 Charr. / Fr.
- 27.0175** 11 Charr. / Fr.
- 27.0176** 12 Charr. / Fr.
- 27.0176E** 12 Charr. / Fr.
- 27.0179** 15 Charr. / Fr.

E = isoliert - insulated - isolé - con aislamiento



FERGUSON

- 27.0180** 6 Charr. / Fr.
- 27.0181** 7 Charr. / Fr.
- 27.0181E** 7 Charr. / Fr.
- 27.0182** 8 Charr. / Fr.
- 27.0183** 9 Charr. / Fr.
- 27.0183E** 9 Charr. / Fr.
- 27.0184** 10 Charr. / Fr.
- 27.0185** 11 Charr. / Fr.
- 27.0185E** 11 Charr. / Fr.
- 27.0186** 12 Charr. / Fr.
- 27.0187** 15 Charr. / Fr.



FRAZIER

- 27.0190** 6 Charr. / Fr.
- 27.0191** 7 Charr. / Fr.
- 27.0192** 8 Charr. / Fr.
- 27.0193** 9 Charr. / Fr.
- 27.0194** 10 Charr. / Fr.
- 27.0195** 11 Charr. / Fr.
- 27.0196** 12 Charr. / Fr.

E = isoliert - insulated - isolé - con aislamiento

27.0199

Reinigungsdraht für FRAZIER/FERGUSON
Replacement Stylet for FRAZIER/FERGUSON
Tige de rechange pour FRAZIER/FERGUSON
Alambre de recambio para FRAZIER/FERGUSON



HUDSON
27.0209



27.0202
9 mm Ø



27.0203
14 mm Ø



27.0204
16 mm Ø



27.0205
22 mm Ø



HUDSON
27.0200

Handbohrapparat mit Fräsern 27.0202 bis 27.0205 und Verlängerungsstück 27.0209
 Hand drill with 4 burrs 27.0202 - 27.0205 and extension piece 27.0209
 Vilebrequin a main avec Fraises 27.0202 - 27.0205 et rallonge 27.0209
 Perforador de mano, con 4 fresas 27.0202 - 27.0205 y pieza de prolongación 27.0209

27.0201

Bohrwinde / hand drill / Vilebrequin seul / Perforador de mano suelto



CUSHING
27.0206
14 mm Ø



McKENZIE
27.0207
14 mm Ø



D'ERRICO
27.0208
14 mm Ø



ADSON
27.0212
2 mm Ø

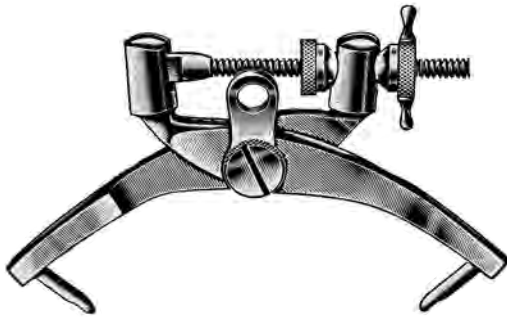

CRUTCHFIELD
27.0400 11 cm



CRUTCHFIELD
27.0402 13 cm



27.0408
3,5 mm Ø



27.0409
5 mm Ø



CRUTCHFIELD
27.0430

Schädelhalter für Halswirbelextension
for extension of the neck vertebrae
pour tractions cervicales
para la extensión de las vertebrae de cuello

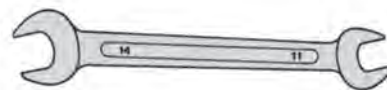

27.0438
11 / 14 mm
Schraubenschlüssel / wrench / clef / llave inglesa

27.0439
Ersatzdorn / Spare pin
Broches de rechange / Punta de repuesto suelta



CONE
27.0500
19 cm / 7 mm
27.0502
23 cm / 12 mm



DEVILBIS
27.0510
21 cm



DAHLGREN
27.0515
20 cm



GIGLI
27.0520
27.0521
Paar / pair / paire / par

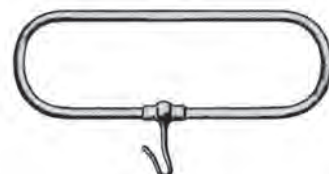

GIGLI
27.0525

Einführungsinstrument für Drahtsägen
 Conductor for wire saws
 Conducteur pour scies
 Conductor para sierras de hilo

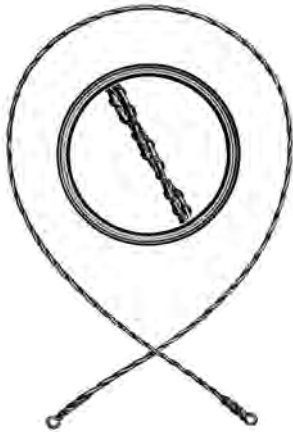

OLIVECRONA (GIGLI)

- 27.0530 30 cm
- 27.0531 40 cm
- 27.0532 50 cm
- 27.0533 60 cm
- 27.0534 70 cm



MARTEL

- 27.0540 33 cm
gerade / straight
droit / recta
- 27.0541 33 cm
gebogen / curved
courbe / curva



GALT

- 27.0600 13 mm Ø
- 27.0601 16 mm Ø
- 27.0602 19 mm Ø
- 27.0603 22 mm Ø
- 27.0604 25 mm Ø

Trephinen
 Trephines
 Tréphines
 Trepanos

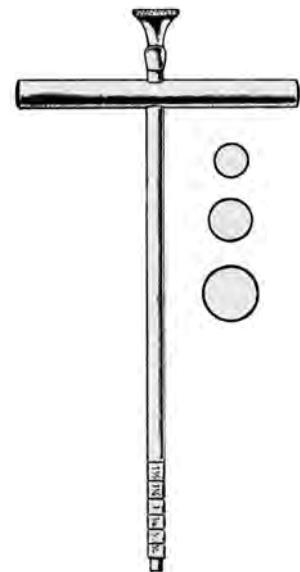

MICHELE

- 27.0610 5,0 mm Ø
- 27.0611 5,5 mm Ø
- 27.0612 8,0 mm Ø

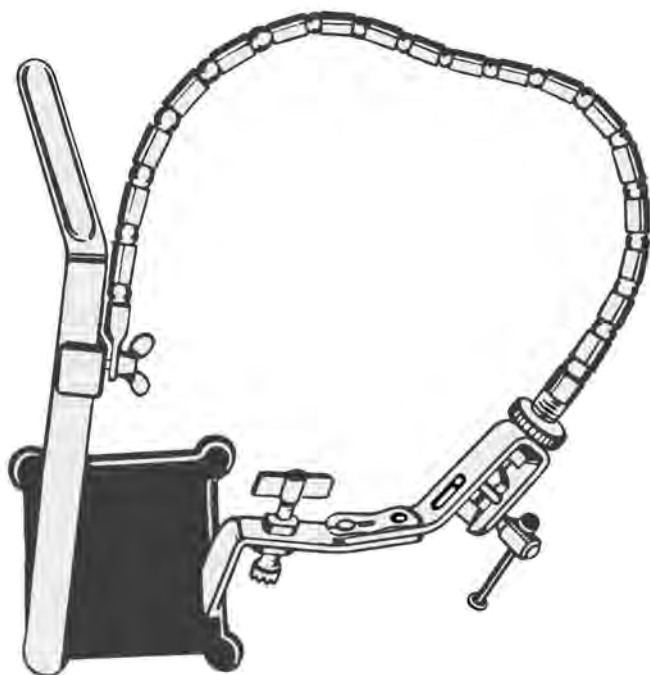

LEYLA

27.0700

Hirnspatelhalter, einfach bestehend aus:

27.0705 1 flexibler Spannarm

27.0706 1 Fixiervorrichtung

27.0709 1 Spatelhalterung

Retractor set, single, consisting of:

27.0705 1 flexible arm

27.0706 1 fixation base

27.0709 1 support for flat spatulas

Ecarteur simple, comprenant:

27.0705 1 bras tendeur flexible

27.0706 1 Étau crânien

27.0709 1 porte-instrument-plat

Separador singular, compuesto de:

27.0705 1 brazo flexible

27.0706 1 dispositivo a fijación

27.0709 1 porta-espátulas para espátulas planos

LEYLA

27.0701

Hirnspatelhalter, doppelt bestehend aus:

27.0705 2 flexible Spannarme

27.0707 1 Fixiervorrichtung

27.0709 2 Spatelhalterungen

Retractor set, double, consisting of:

27.0705 2 flexible arms

27.0707 1 fixation base

27.0709 2 supports for flat spatulas

Ecarteur double, comprenant:

27.0705 2 bras tendeur flexibles

27.0707 1 Étau crânien

27.0709 2 porte-instruments

Separador doble, compuesto de:

27.0705 2 brazos flexibles

27.0707 1 dispositivo a fijación

27.0709 2 porta-espátulas para espátulas planos

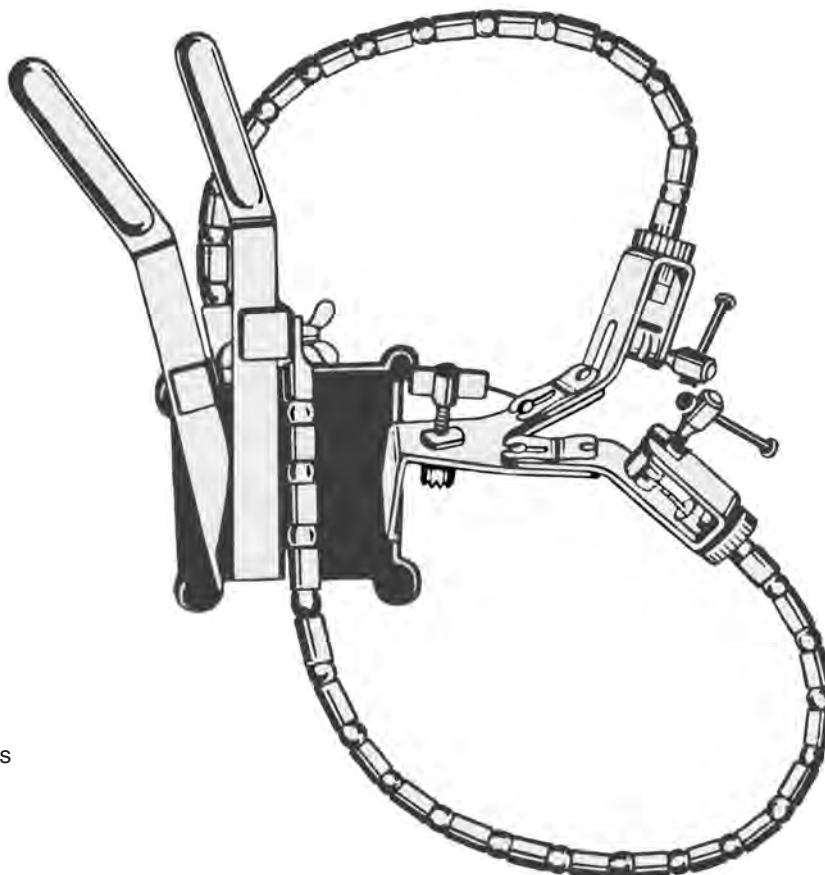

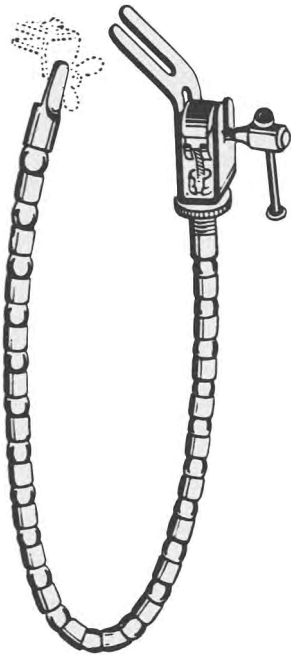

27.0705
Spannarm allein
Flexible arm only
Bras tendeur flexible seul
Brazo flexible



27.0706
Fixiervorrichtung für 1 Spannarm
Fixation base for 1 flexible arm
Étau crânien simple pour 1 bras flexible
Dispositivo a fijación para 1 brazo flexible



27.0707
Fixiervorrichtung für 2 Spannarme
Fixation base for 2 flexible arms
Étau crânien double, 2 bras tendeurs flexibles
Dispositivo a fijación doble para 2 brazo flexible



27.0708
Fixiervorrichtung zum
Festschrauben an Rohrteilen
Fixation base, for mounting
to round bars
Étau crânien, s'adaptant à la
table d'operation
Dispositivo a fijación para
mesas operatirias



27.0709
Flachspatelhalter
Support for flat
spatulas
Porte-spatule, pour
spatules plates
Porta-espátulas,
para espátulas
planos



27.0710
Spatelhalter für
Rundgriff-Instrumente
Support for round
spatulas
Porte-spatule, pour
instruments à manches
rondes
Porta-espátulas, para
espátulas con mangos
rondes

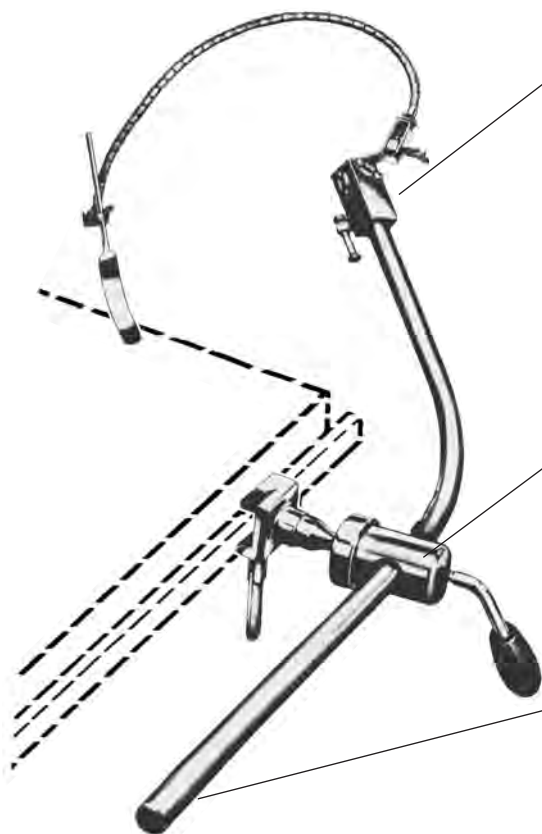

27.0712
Kupplungskopf, für
1 - 5 Spannarme
Coupling head, for
1 - 5 flexible arms
Tête porte-bras, pour
1 - 5 bras flexibles
Cabeza porta-brazos, para
1 - 5 brazos flexibles

27.0713
Kugelgelenkvorrichtung
Ball and socket joint
Rotule
Rotula

27.0711
Haltearm, starr
Holding rod, rigid
Potence, rigid
Brazo rigido

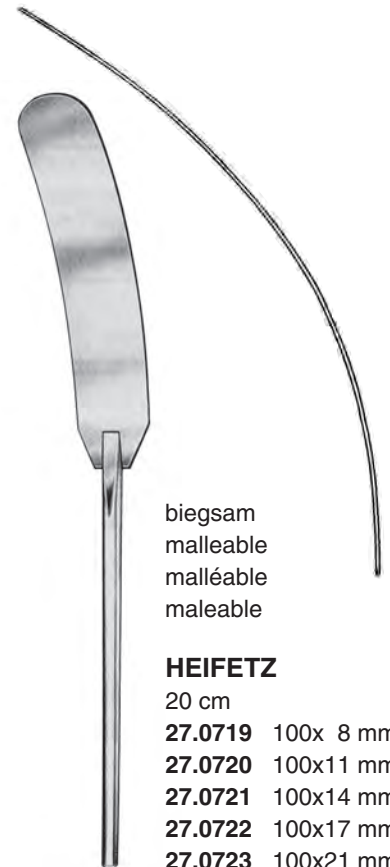

biegsam
malleable
malléable
maleable

HEIFETZ

20 cm

- 27.0719** 100x 8 mm
- 27.0720** 100x11 mm
- 27.0721** 100x14 mm
- 27.0722** 100x17 mm
- 27.0723** 100x21 mm

Chordotomie-Messer / Cordotomy Knives / Bistouris pour cordotomie / Bisturios para cordotomia



BUCY
 27.0791 17 cm



BUCY
 27.0792 17 cm



BUCY
 27.0793 17 cm

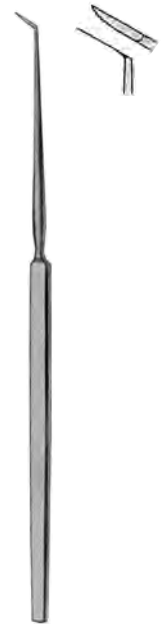

BUCY
 27.0794 17 cm

Unterbindungsnadel / Ligature Needle
 Aiguille à ligatures / Aguja para ligaduras

Elevatorien / Elevators / Elévateurs / Elevadores



27.0800



27.0801

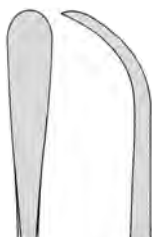

27.0802



27.0803

ADSON
 17 cm



HOEN-MARTIN



27.0810
 16 cm / 7 mm



27.0811
 19 cm / 15 mm

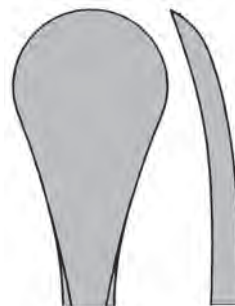

27.0812
 19 cm / 20 mm



ADSON
 27.0860
 23 cm



HORSELY
27.0870
19 cm



FRAZIER
27.0880
15 cm



HOEN
27.0890
15 cm 45°



HOEN
27.0891
15 cm 90°

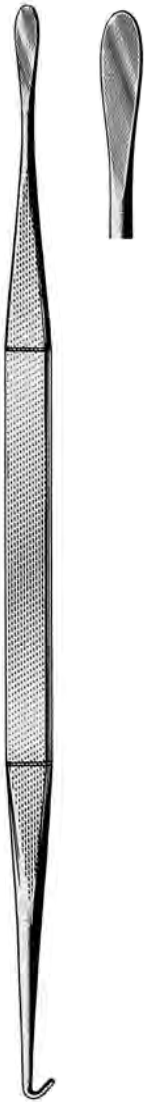

SMITHWICK
27.0900
29 cm



DAVIS
27.0910
24,5 cm



DAVIS
27.0912
19 cm



PENFIELD
27.0921
17,5 cm #1



PENFIELD
27.0922
19,5 cm #2



PENFIELD
27.0923
19,5 cm #3



PENFIELD
27.0924
21,5 cm #4



PENFIELD
27.0925
29 cm #5



SACHS
27.0930
21 cm



SACHS
27.0931
21 cm



MILLIGAN
27.0936
21 cm

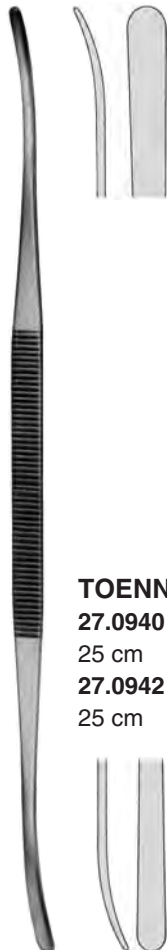

TOENNIS
27.0940 3,5 / 5 mm
25 cm
27.0942 4,5 / 6 mm
25 cm



OLIVECRONA
27.0950 2 / 3 mm
18 cm
27.0951 2 / 3 mm
24 cm



OLIVECRONA
27.0952 4 / 5 mm
18 cm
27.0953 4 / 5 mm
24 cm



HALLE
27.0960
20 cm



OLIVECRONA
konkav / concave
concave / cóncavas
18 cm
27.1000 7 x 9 mm
27.1001 11 x 13 mm
27.1002 15 x 18 mm
27.1003 18 x 22 mm

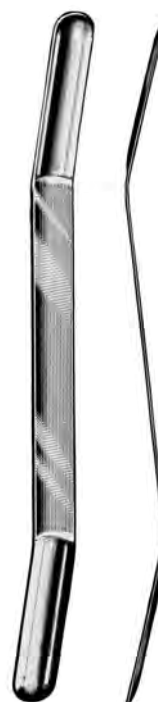

OLIVECRONA
konvex / convex
convexe / convexas
18 cm
27.1005 7 x 9 mm
27.1006 11 x 13 mm
27.1007 15 x 18 mm
27.1008 18 x 22 mm



CUSHING
27.1010
17 cm 8 x 10 mm
27.1012
20 cm 13 x 15 mm

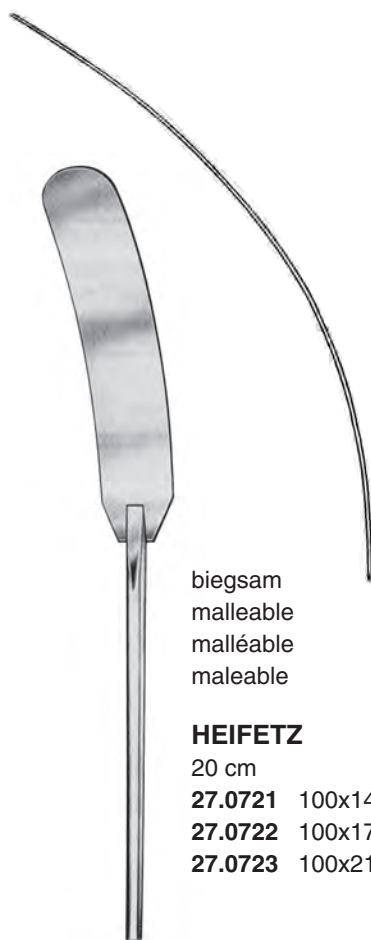

biegsam
malleable
malléable
maleable

HEIFETZ
20 cm
27.0721 100x14 mm
27.0722 100x17 mm
27.0723 100x21 mm



100 mm

biegsam
malleable
malléable
maleable

HEIFETZ
15 cm
27.1026 8 mm
27.1027 11 mm
27.1028 14 mm
27.1029 17 mm



“AACHEN”

20 cm

- 27.1041 7/ 8 mm
- 27.1042 10/11 mm
- 27.1043 13/14 mm
- 27.1044 16/17 mm
- 27.1045 19/20 mm
- 27.1046 22/25 mm



DAVIS

18 cm

- 27.1050 6,0 mm
- 27.1051 9,5 mm
- 27.1052 13,5 mm
- 27.1053 16,0 mm
- 27.1054 19,0 mm
- 27.1055 25,0 mm
- 27.1056 32,0 mm
- 27.1057 38,0 mm



SCOVILLE

20 cm

- 27.1060 10/13 mm
- 27.1061 16/19 mm

biegsam / malleable / malléable / maleable



27.1100



27.1101



27.1102

SCOVILLE
25 cm



TAYLOR
27.1150
75 x 30 mm
27.1152
100 x 30 mm



CLOWARD
27.1160
76 x 13 mm
27.1161
76 x 18 mm
27.1162
76 x 20 mm
27.1163
76 x 23 mm



27.1201
90°



27.1202
45°



CRILE
20 cm



HOEN
27.1206
22 cm



ADSON
27.1210 20 cm
 spitz / sharp
 pointu / agudo



ADSON
27.1211 20 cm
 stumpf / blunt
 mousses / romo



GRAHAM
27.1220
16,5 cm





SACHS
27.1222
18 cm



SMITHWICK
27.1226
17 cm



SMITHWICK
27.1228
21 cm



DANDY
27.1230
20 cm



DANDY
27.1231
20 cm



DANDY
27.1232
20 cm



CUSHING
27.1240
19 cm / 5 mm
27.1245
28 cm / 5 mm



CUSHING
27.1241
19 cm / 8 mm
27.1246
28 cm / 8 mm





WOODSON
 27.1296
 18 cm



LAHEY
 27.1305
 13 cm



FRAZIER



27.1310
 13 cm
 spitz
 sharp
 pointu
 agudo



27.1311
 13 cm
 stumpf
 blunt
 mousse
 romo



27.1312
 18 cm
 spitz
 sharp
 pointu
 agudo



27.1313
 18 cm
 stumpf
 blunt
 mousse
 romo



CUSHING
 27.1320
 14 cm



CUSHING
 27.1325
 14 cm



CLOWARD
 27.1330
 16,5 cm



SPEARE
 27.1335
 14 cm



TOENNIS
 27.1340
 15 cm



SCOVILLE
 27.1390
 23 cm / 8 mm



SCOVILLE
 27.1391
 23 cm / 8 mm



LOVE
 27.1400
 19 cm / 7 mm

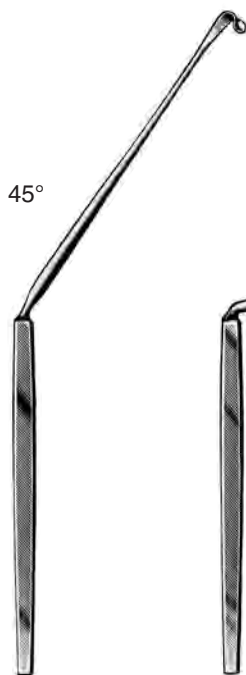

LOVE
 27.1402
 18 cm / 7 mm



LOVE
 27.1404
 11 cm / 7 mm



LOVE
 27.1406
 21 cm



SCOVILLE
27.1410
30,5 cm



SCOVILLE
27.1412
30,5 cm

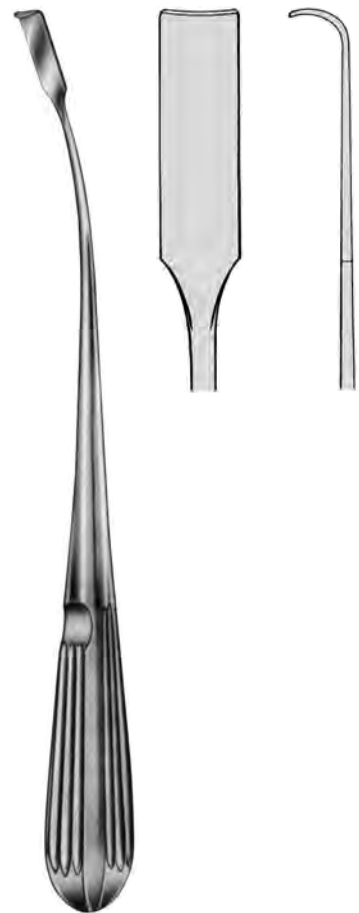

HOLSHER
27.1413
25 cm / 7 mm



CUSHING
27.1420
20 cm



D'ERRICO
27.1425
23 cm



OLDBERG
20 cm



27.1430



27.1431



27.1432



27.1433



CLOWARD

17.8000 17 cm
 mit 5 Valven
 with 5 blades
 avec 5 valves
 con 5 valvas

17.8001 17 cm
 ohne Valven
 without blades
 sans valves
 sin valvas



stumpf
 blunt
 mousse
 romo

- 17.8002** 40 mm
- 17.8003** 45 mm
- 17.8004** 50 mm
- 17.8005** 55 mm
- 17.8006** 60 mm

17.8007

Satz von 5 stumpfen Valven
 set of 5 blunt blades
 jeu à 5 valves mousses
 juego de 5 valvas romas



CLOWARD

17.8010 25 cm
 mit 5 Valven
 with 5 blades
 avec 5 valves
 con 5 valvas

17.8011 25 cm
 ohne Valven
 without blades
 sans valves
 sin valvas



spitz
 sharp
 pointu
 agudo

- 17.8012** 40 mm
- 17.8013** 45 mm
- 17.8014** 50 mm
- 17.8015** 55 mm
- 17.8016** 60 mm

17.8017

Satz von 5 spitzen Valven
 set of 5 sharp blades
 jeu à 5 valves pointues
 juego de 5 valvas agudas



17.8042 45 x 35 mm

17.8043 45 x 45 mm

spitz
 sharp
 pointu
 agudo



17.8044 25 x 35 mm

17.8045 25 x 45 mm

stumpf
 blunt
 mousse
 romo



17.8052

50 mm



17.8053

64 mm



HOEN

17.8040 27 cm

mit 4 Valven / with 4 blades (17.8042 - 17.8045)
 avec 4 valves / con 4 valvas

17.8041 27 cm

ohne Valven / without blades
 sans valves / sin valvas



CLOWARD-HOEN

17.8050 25 cm

mit je 2 Valven 17.8052 & 17.8053
 with 2 ea. blades 17.8052 & 17.8053
 avec 2 valves 17.8052 et 2 valves 17.8053
 con 2 valvas 17.8052 y 2 valvas 17.8053

17.8051 25 cm

ohne Valven / without blades / sans valves / sin valvas

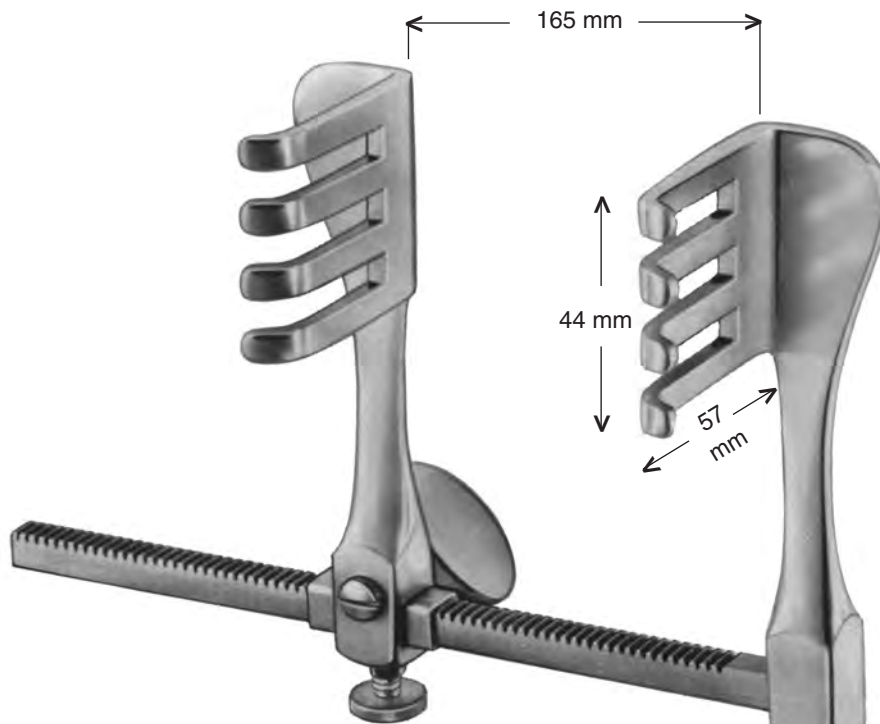

BADGLEY
17.8100

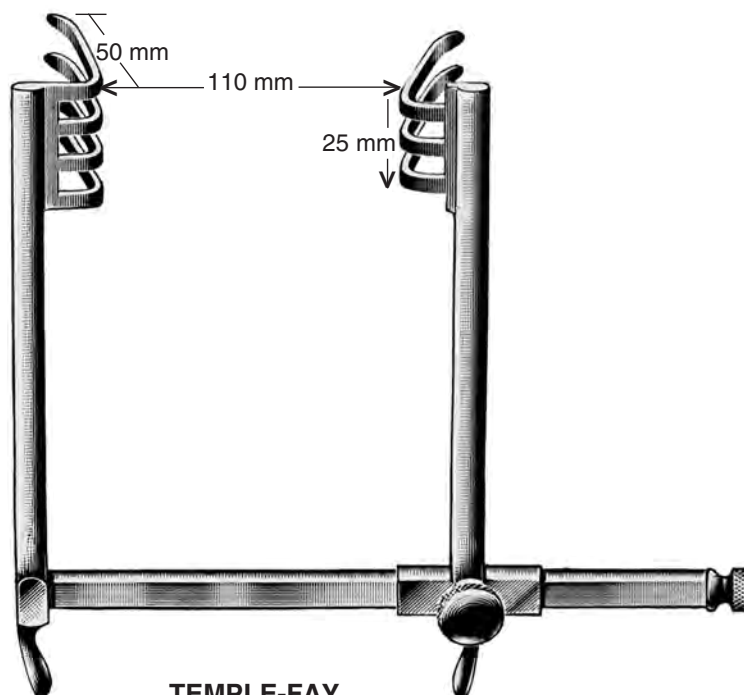

TEMPLE-FAY
17.8155



SCOVILLE

17.8160

Rahmen alleine
 Frame only
 cadre seul
 cuadro suelto

SCOVILLE

17.8161

bestehend aus: 17.8160 Rahmen, 17.8172 Haken, 17.8174 Valve
 consisting of: 17.8160 frame, 17.8172 hook, 17.8174 blade
 comprenant de: 17.8160 cadre, 17.8172 crochet, 17.8174 valve
 compuesto de: 17.8160 cuadro, 17.8172 gancho, 17.8174 valve



SCOVILLE

17.8170 50 mm
17.8171 75 mm

SCOVILLE

17.8172 50 mm
17.8173 75 mm



SCOVILLE-HAVERFIELD

17.8165

Rahmen alleine
 Frame only
 cadre seul
 cuadro suelto

SCOVILLE-HAVERFIELD

17.8164

bestehend aus: 17.8165 Rahmen, 17.8170 Haken, 17.8174 Valve

consisting of: 17.8165 frame, 17.8170 hook, 17.8174 blade

comprenant de: 17.8165 cadre, 17.8170 crochet, 17.8174 valve

compuesto de: 17.8165 cuadro, 17.8170 gancho, 17.8174 valve



SCOVILLE

17.8174 64 x 25 mm
17.8175 64 x 50 mm
17.8177 88 x 25 mm

SCOVILLE

17.8178 41 x 38 mm
17.8179 67 x 44 mm



TAYLOR

17.8181 48 x 51 mm

17.8182 64 x 50 mm

17.8183 80 x 57 mm



TAYLOR

17.8185 75 x 32 mm

17.8186 100 x 42 mm



HIBBS

17.8187 50 x 19 mm

17.8188 50 x 25 mm

17.8189 50 x 50 mm

17.8190 64 x 25 mm

17.8191 64 x 38 mm

17.8192 75 x 25 mm

17.8193 75 x 38 mm

17.8194 75 x 50 mm

17.8195 100 x 25 mm

17.8196 100 x 50 mm



MEYERDING

17.8201 50 x 25 mm

17.8203 75 x 25 mm

17.8205 90 x 50 mm



CLOWARD

27.1451

16 cm

Spreizweite	15 mm
opening	15 mm
écartement	15 mm
abertura	15 mm



CLOWARD

27.1455

13 cm

Spreizweite	20 mm
opening	20 mm
écartement	20 mm
abertura	20 mm

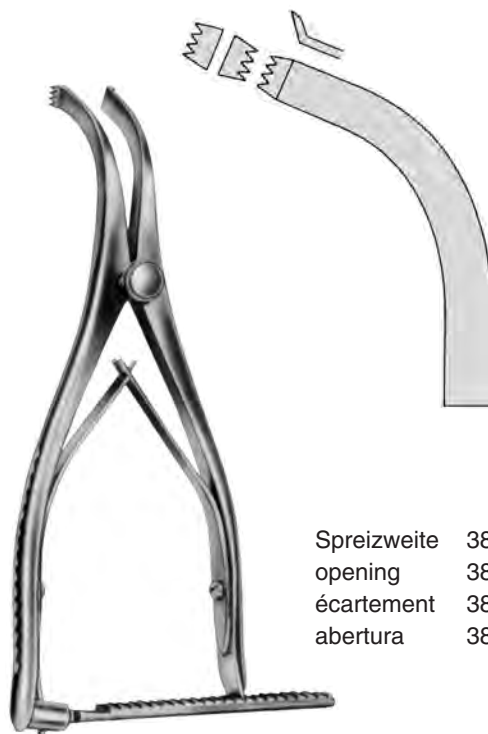

Spreizweite	38 mm
opening	38 mm
écartement	38 mm
abertura	38 mm

INGE-BABY

27.1460

17 cm



INGE

27.1465 27 cm / 9 mm

27.1466 27 cm / 12 mm

Spreizweite 50 mm
opening 50 mm
écartement 50 mm
abertura 50 mm

Ersatzvalve
Spare valve
Valve de rechange
Valva di ricambio



27.1485 40 x 12 mm

27.1486 50 x 12 mm

27.1487 65 x 12 mm



PRO-MED

27.1480

Laminectomiesperrer ALUMINIUM komplett mit je 2 Paar Valven (12 St.) 40, 50, und 65 mm tief und 12 mm breit

Laminectomy retractor, ALUMINIUM, complete with 2 ea. pairs of valves (12 pcs.) 40, 50, and 65 mm deep and 12 mm wide

Ecarteur pour laminectomie ALUMINIUM complet avec 6 pairs de valves (2 pairs de 40 x 12 mm)
(2 pairs de 50 x 12 mm)
(2 pairs de 65 x 12 mm)

Separador para laminectomia ALUMINIO completo con 6 pares de valvas (2 pares de 40 x 12 mm)
(2 pares de 50 x 12 mm)
(2 pares de 65 x 12 mm)

PRO-MED

27.1481

Laminectomiesperrer alleine
Laminectomy retractor only (without valves)
Ecarteur seul, sans valves
Separador suelto, sin valvas

mit dünner Fußplatte
 with thin footplate
 avec pied mince
 con lamina delgado

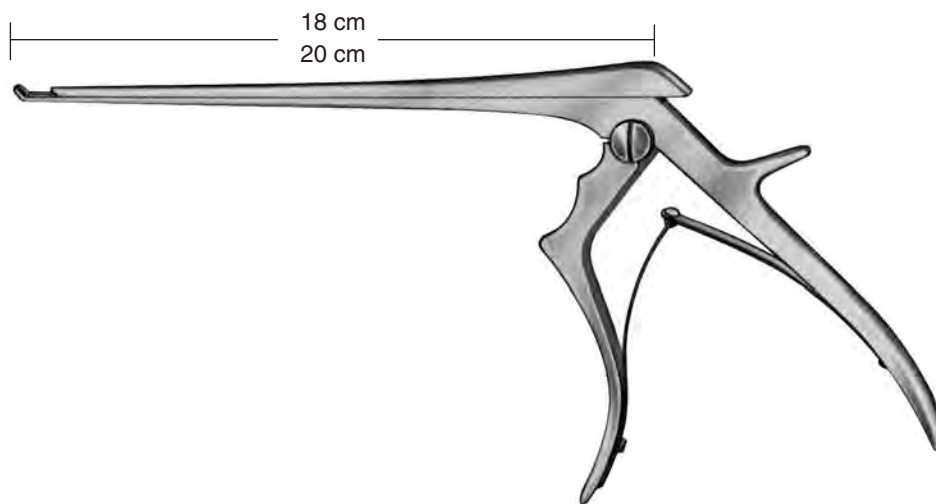

FERRIS-SMITH-KERRISON

		18 cm		20 cm
90°		27.1561	1 mm	27.1561-20
		27.1562	2 mm	27.1562-20
		27.1563	3 mm	27.1563-20
		27.1564	4 mm	27.1564-20
		27.1565	5 mm	27.1565-20
40°		27.1581	1 mm	27.1581-20
		27.1582	2 mm	27.1582-20
		27.1583	3 mm	27.1583-20
		27.1584	4 mm	27.1584-20
		27.1585	5 mm	27.1585-20

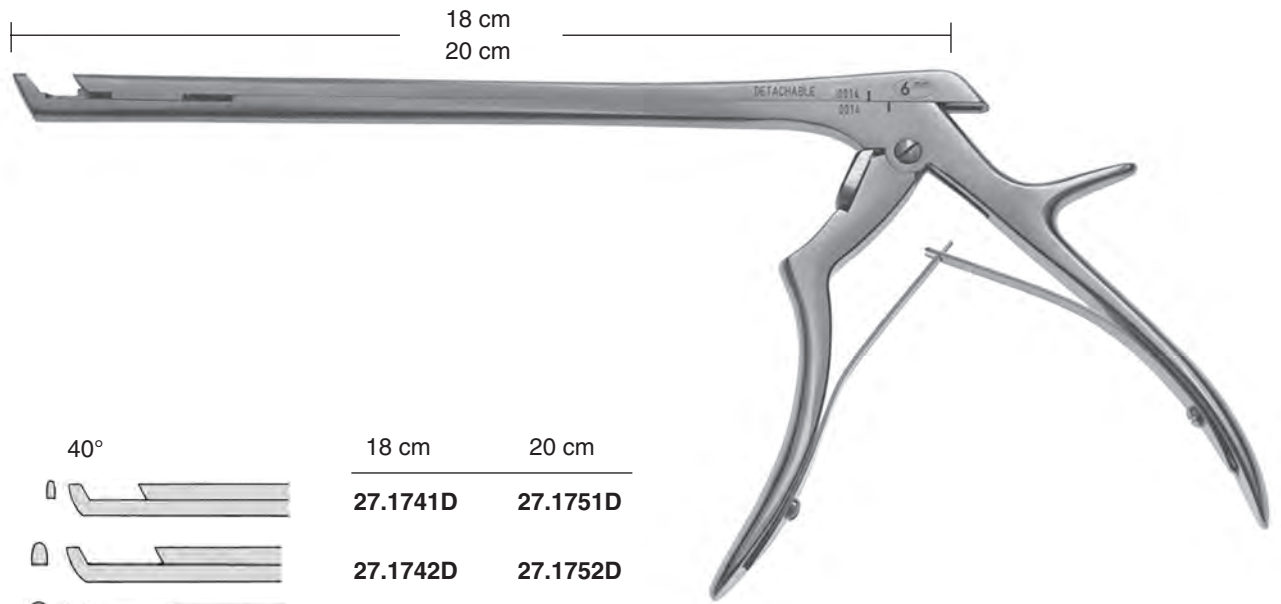

	40°	18 cm	20 cm
1 mm		27.1741D	27.1751D
2 mm		27.1742D	27.1752D
3 mm		27.1743D	27.1753D
4 mm		27.1744D	27.1754D
5 mm		27.1745D	27.1755D
6 mm		27.1746D	27.1756D



zerlegbar
 detachable
 démontable
 desmontable

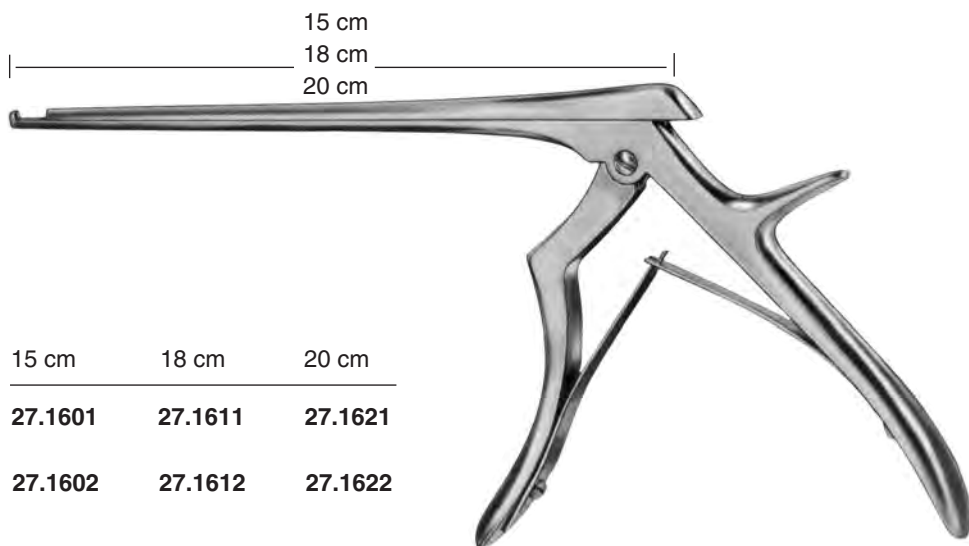

FERRIS-SMITH-KERRISON

	90°	15 cm	18 cm	20 cm
1 mm		27.1601	27.1611	27.1621
2 mm		27.1602	27.1612	27.1622
3 mm		27.1603	27.1613	27.1623
4 mm		27.1604	27.1614	27.1624
5 mm		27.1605	27.1615	27.1625
6 mm			27.1616	27.1626

	90°	15 cm	18 cm	20 cm
1 mm		27.1631	27.1641	27.1651
2 mm		27.1632	27.1642	27.1652
3 mm		27.1633	27.1643	27.1653
4 mm		27.1634	27.1644	27.1654
5 mm		27.1635	27.1645	27.1655
6 mm			27.1646	27.1656

	40°	15 cm	18 cm	20 cm
1 mm		27.1731	27.1741	27.1751
2 mm		27.1732	27.1742	27.1752
3 mm		27.1733	27.1743	27.1753
4 mm		27.1734	27.1744	27.1754
5 mm		27.1735	27.1745	27.1755
6 mm			27.1746	27.1756

mit **extralangem** Schaft
 with **extra long** shaft
 avec tige **extrêmement longue**
 con asta **extra longo**

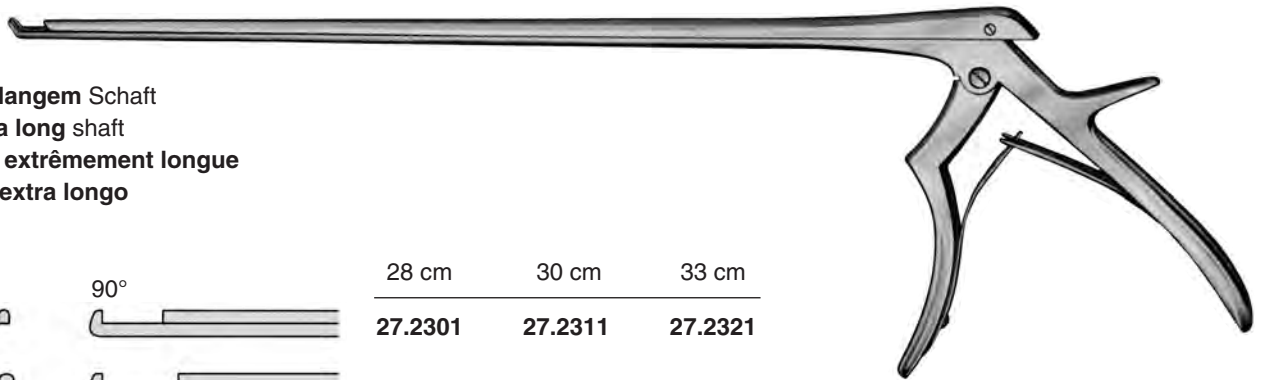

FERRIS-SMITH-KERRISON

		90°	28 cm	30 cm	33 cm
1 mm			27.2301	27.2311	27.2321
2 mm			27.2302	27.2312	27.2322
3 mm			27.2303	27.2313	27.2323
4 mm			27.2304	27.2314	27.2324
5 mm			27.2305	27.2315	27.2325
6 mm			27.2306	27.2316	27.2326

		90°	28 cm	30 cm	33 cm
1 mm			27.2331	27.2341	27.2351
2 mm			27.2332	27.2342	27.2352
3 mm			27.2333	27.2343	27.2353
4 mm			27.2334	27.2344	27.2354
5 mm			27.2335	27.2345	27.2355
6 mm			27.2336	27.2346	27.2356

		40°	28 cm	30 cm	33 cm
1 mm			27.2361	27.2371	27.2381
2 mm			27.2362	27.2372	27.2382
3 mm			27.2363	27.2373	27.2383
4 mm			27.2364	27.2374	27.2384
5 mm			27.2365	27.2375	27.2385
6 mm			27.2366	27.2376	27.2386

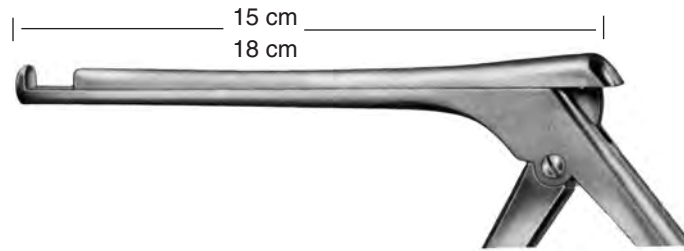

15 cm
18 cm

COLCLOUGH

	90°	15 cm	18 cm
3 mm		27.1803	27.1813
5 mm		27.1805	27.1815

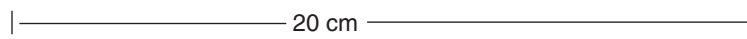

20 cm

COLCLOUGH
20 cm

	90°	20 cm
3 mm		27.1823
5 mm		27.1825

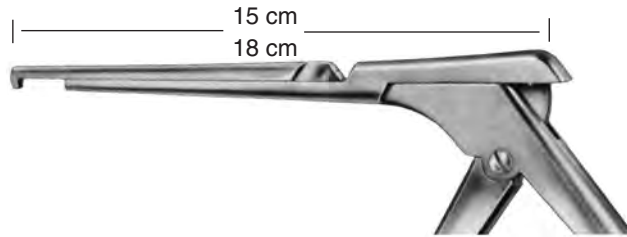

	90°	15 cm	18 cm	
3 mm		27.1833	27.1843	COLCLOUGH

5 mm		27.1835	27.1845	
------	--	---------	---------	--

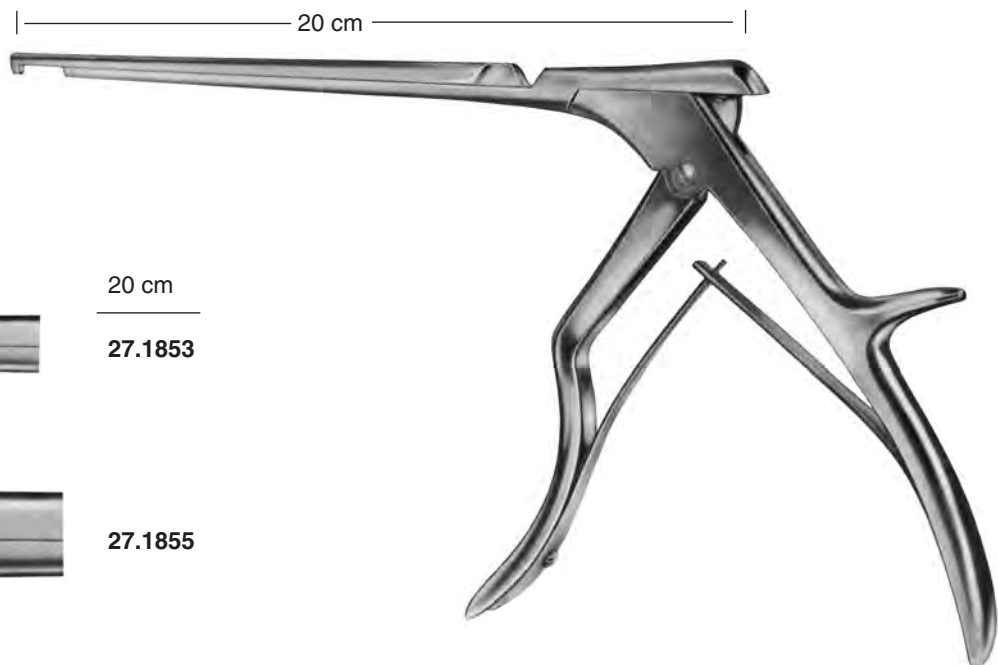

	90°	20 cm	
3 mm		27.1853	

5 mm		27.1855	
------	--	---------	--

COLCLOUGH

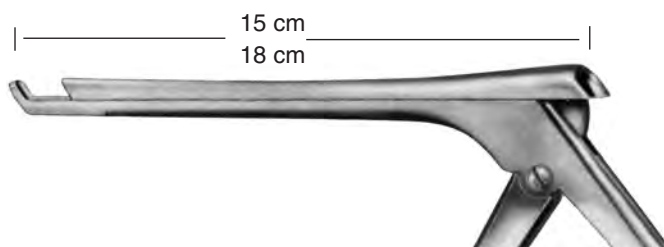

15 cm
18 cm



40°

3 mm

15 cm 18 cm

27.1863 27.1873

COLCLOUGH



5 mm

27.1865 27.1875

20 cm



40°

3 mm

20 cm

27.1883



5 mm

27.1885

COLCLOUGH
20 cm

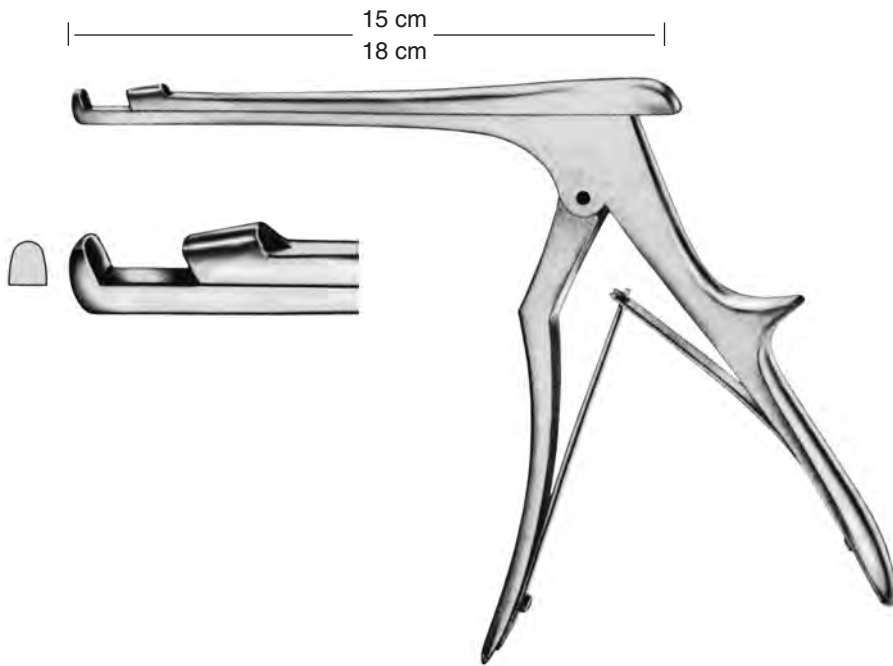

RANEY
 27.1950 15 cm / 6 mm
 27.1952 18 cm / 6 mm

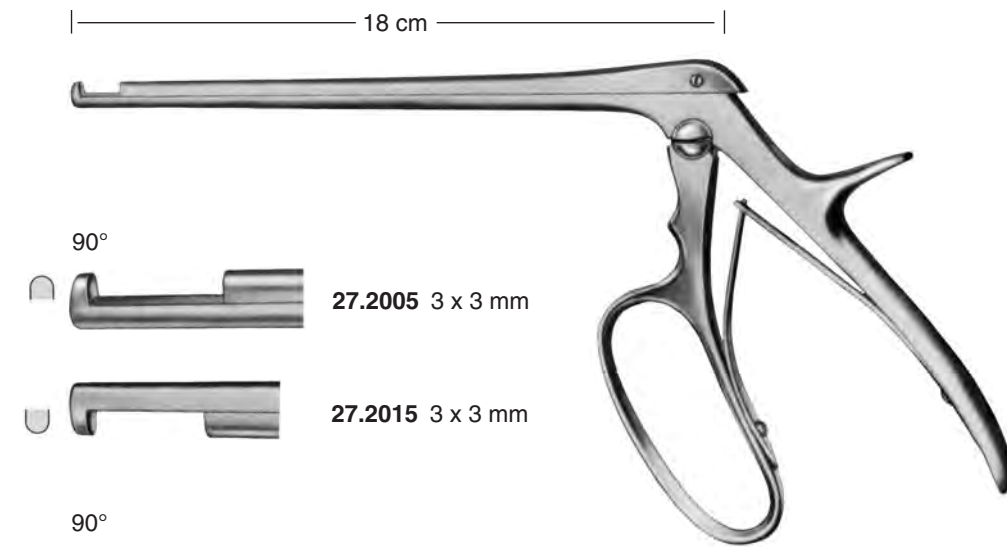

FERRIS-SMITH-KERRISON
 18 cm

90°
 27.2005 3 x 3 mm

27.2015 3 x 3 mm

90°
 27.2035 5 x 5 mm

27.2045 5 x 5 mm

40°
 27.2055 3 mm

27.2065 5 mm

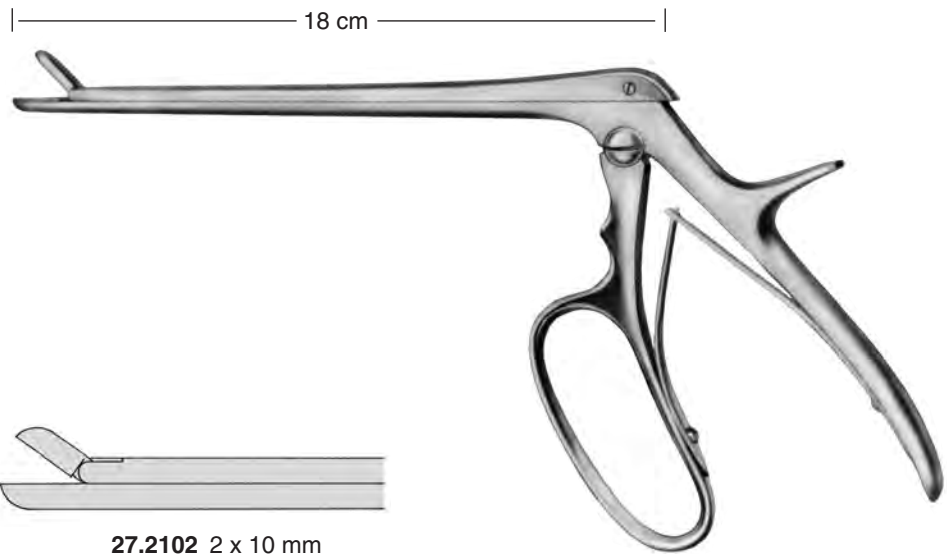

FERRIS-SMITH-CUSHING
18 cm



- 27.2102 2 x 10 mm
- 27.2103 3 x 10 mm
- 27.2104 4 x 10 mm
- 27.2106 6 x 10 mm



- 27.2112 2 x 10 mm
- 27.2113 3 x 10 mm
- 27.2114 4 x 10 mm
- 27.2115 5 x 10 mm
- 27.2116 6 x 10 mm

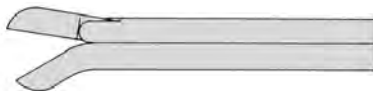

- 27.2122 2 x 10 mm
- 27.2123 3 x 10 mm
- 27.2124 4 x 10 mm

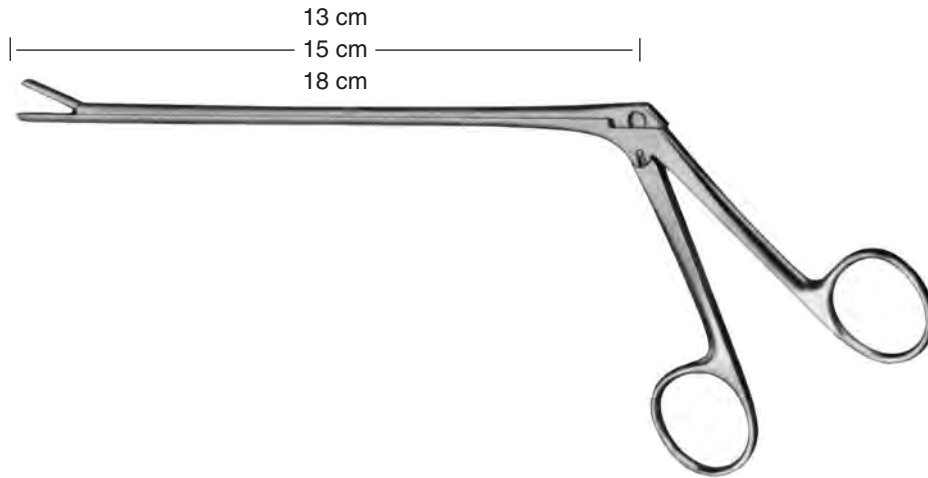

CUSHING
 2 mm

1

2

3



27.2149 13 cm
27.2150 15 cm
27.2155 18 cm

27.2151 15 cm
27.2156 18 cm

27.2152 15 cm
27.2157 18 cm

LOVE-GRUENWALD
 3 mm

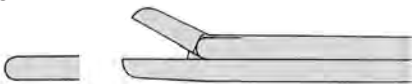

27.2159 13 cm
27.2160 15 cm
27.2165 18 cm

27.2163 13 cm
27.2161 15 cm
27.2166 18 cm

27.2164 13 cm
27.2162 15 cm
27.2167 18 cm

SPURLING
 4 mm



27.2169 13 cm
27.2170 15 cm
27.2175 18 cm

27.2171 15 cm
27.2176 18 cm

27.2172 15 cm
27.2177 18 cm



OLDBERG
25 cm
27.2180



SCHLESINGER
15 cm
27.2186 2 x 10 mm
27.2187 3 x 10 mm
27.2188 4 x 10 mm
27.2189 6 x 10 mm

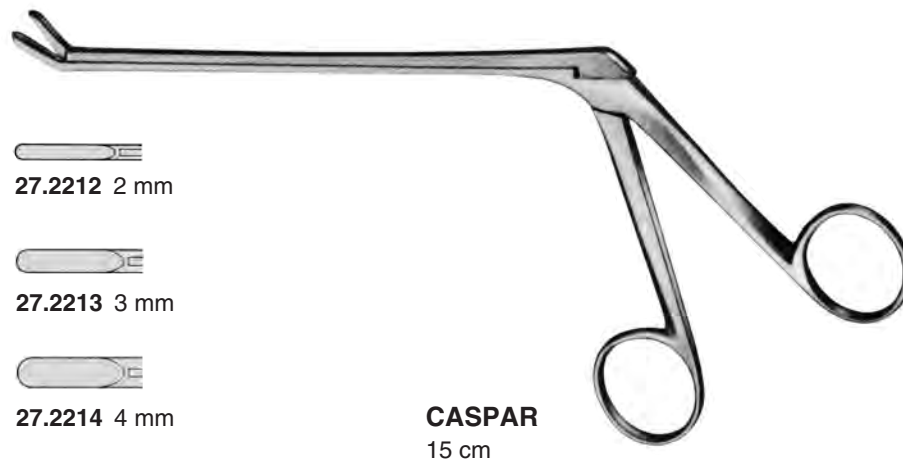
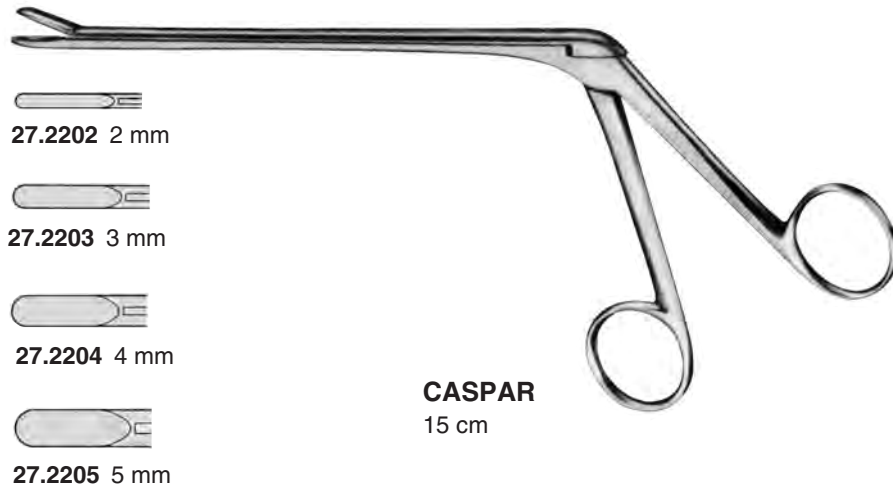



YASARGIL
27.2230 25 cm / 3,5 mm

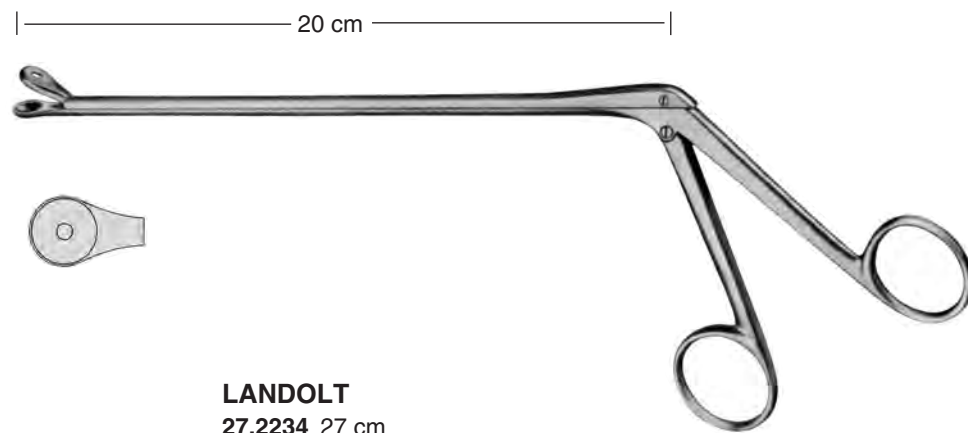

LANDOLT
27.2234 27 cm

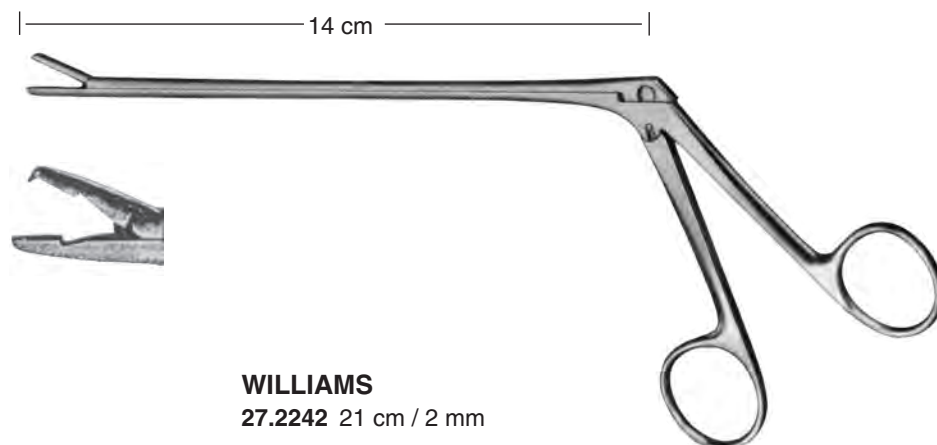

WILLIAMS
27.2242 21 cm / 2 mm

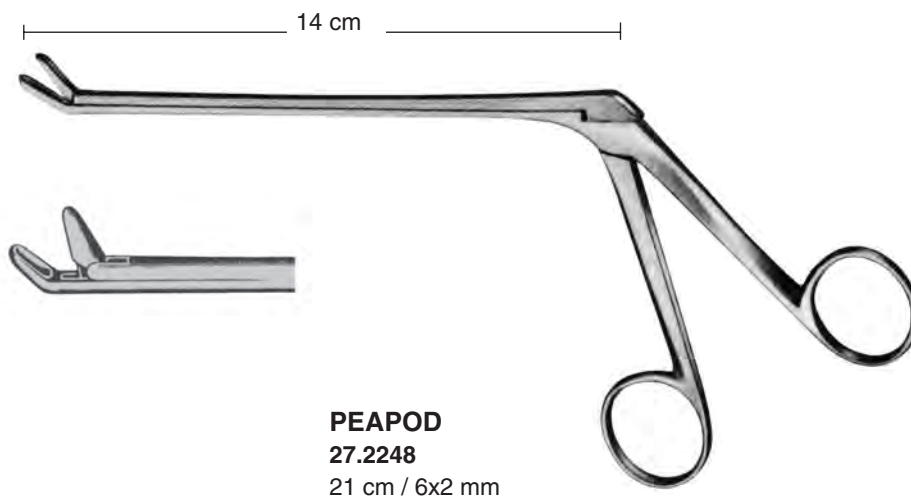
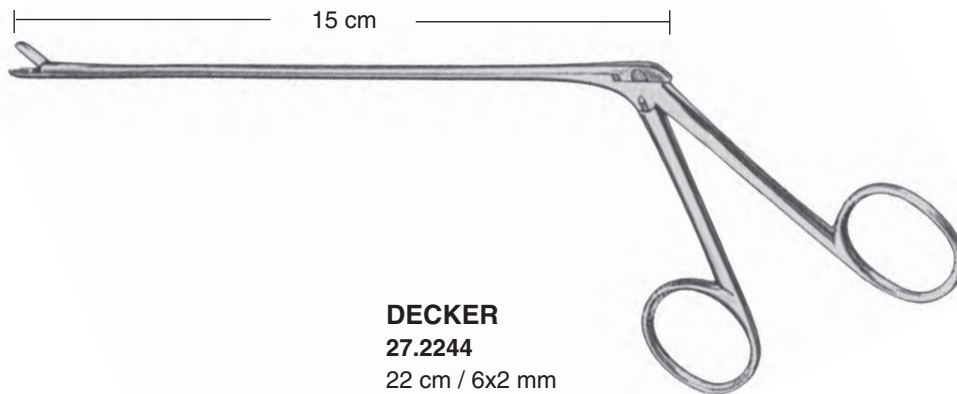

Hypophysenpinzetten
 Hypophyseal forceps
 Pincès à hypophyse
 Pinzas para hipofisis



ADSON
 27.2500 18,5 cm



HOEN
 27.2520 20cm

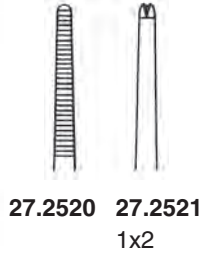

27.2520 27.2521
 1x2



ADSON
 27.2540 23 cm



ADSON
 27.2541 23 cm



ADSON
 27.2542 23 cm

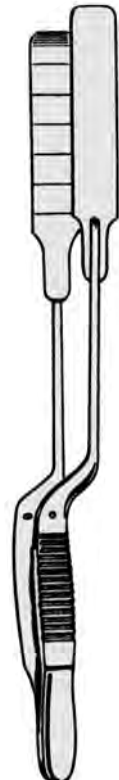

SCOVILLE
 27.2560 22 cm



27.2560
 10 mm



27.2562
 13 mm



McKENZIE
27.2701 15 cm
27.2703 19 cm

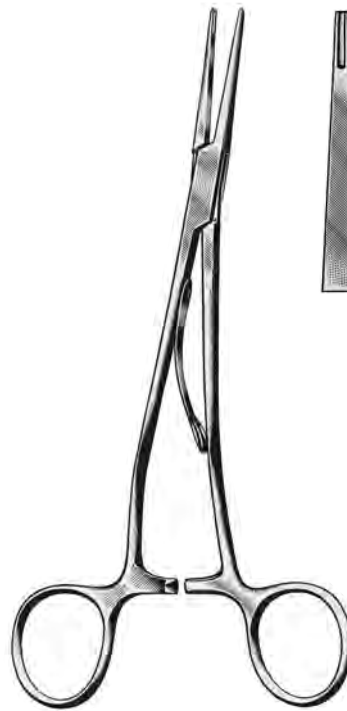

McKENZIE
27.2702 15 cm
27.2704 19 cm



SMITHWICK
27.2711 23 cm
27.2713 26 cm

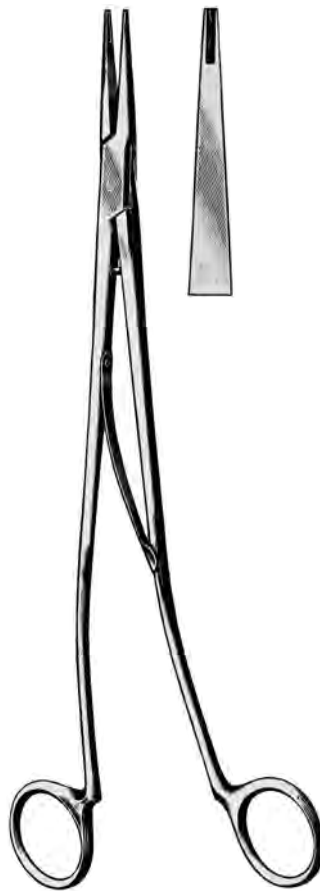

SWEET
27.2720 23 cm
27.2722 26 cm



OLIVECRONA-TOENNIS
27.2730 14 cm



McKENZIE

27.2740

100 Stück, Silber
 100 pieces, Silver
 100 pieces, argent
 100 piezas, plata

27.2742

100 Stück, Tantal
 100 pieces, Tantalum
 100 pieces, Tantale
 100 piezas, Tantalio



McKENZIE
27.2745



McKENZIE
27.2746



RANEY
27.2770 17 cm



RANEY
27.2780
 12 Stück / 12 pieces
 12 pieces / 12 piezas



Federhaken zur Galea-Fixation
 Spring hooks for galea fixation
 Crochets à molle pour fixer
 la galea
 Ganchos con muelle para la
 fijación de la galea

YASARGIL
27.2800
 31 cm / 7 mm Ø
27.2802
 41 cm / 9 mm Ø



CASPAR

17 cm

27.5000

Sperrer komplett mit 7 Valven 27.5021 - 27.5027

Retractor complete with 7 blades 27.5021 - 27.5027

Ecarteur complet avec 7 valves 27.5021 - 27.5027

Separador completo con 7 valvas 27.5021 - 27.5027

27.5001

Sperrer allein / retractor only

ecarteur seul / separador solamente

27.5021 40 mm



27.5022 45 mm



27.5023 50 mm



27.5024 55 mm



27.5025 60 mm



27.5026 65 mm



27.5027 70 mm



CASPAR



27.5030 45 mm



27.5033 60 mm



27.5031 50 mm



27.5034 65 mm



27.5032 55 mm



CASPAR

27.5050

Sperrer komplett mit 5 Valven 27.5072 - 27.5076
 Retractor complete with 5 blades 27.5072 - 27.5076
 Ecarteur complet avec 5 valves 27.5072 - 27.5076
 Separador completo con 5 valvas 27.5072 - 27.5076

27.5051

Sperrer allein / retractor only
 ecarteur seul / separador solamente



27.5062 38 mm



27.5063 58 mm



27.5071 32 x 22 mm
27.5072 37 x 22 mm
27.5073 43 x 22 mm
27.5074 47 x 22 mm
27.5075 52 x 22 mm
27.5076 57 x 22 mm
27.5077 62 x 22 mm
27.5078 67 x 22 mm



27.5081 32 x 37 mm
27.5082 37 x 37 mm
27.5083 43 x 37 mm
27.5084 47 x 37 mm
27.5085 52 x 37 mm
27.5086 57 x 37 mm
27.5087 62 x 37 mm
27.5088 67 x 37 mm



27.5091 32 x 52 mm
27.5092 37 x 52 mm
27.5093 43 x 52 mm
27.5094 47 x 52 mm
27.5095 52 x 52 mm
27.5096 57 x 52 mm
27.5097 62 x 52 mm
27.5098 67 x 52 mm



CASPAR

27.5100

Sperrer komplett mit 5 Valven 27.5183 - 27.5187
Retractor complete with 5 blades 27.5183 - 27.5187
Ecarteur complet avec 5 valves 27.5183 - 27.5187
Separador completo con 5 valvas 27.5183 - 27.5187

27.5101

Sperrer allein / retractor only
ecarteur seul / separador solamente



CASPAR

27.5110

Sperrer komplett mit 5 Valven 27.5183 - 27.5187
Retractor complete with 5 blades 27.5183 - 27.5187
Ecarteur complet avec 5 valves 27.5183 - 27.5187
Separador completo con 5 valvas 27.5183 - 27.5187

27.5111

Sperrer allein / retractor only
ecarteur seul / separador solamente



CASPAR

27.5183 45 x 23 mm
27.5184 50 x 23 mm
27.5185 55 x 23 mm
27.5186 60 x 23 mm
27.5187 65 x 23 mm



CASPAR

- 27.5132 40 x 23 mm
- 27.5133 45 x 23 mm
- 27.5134 50 x 23 mm
- 27.5135 55 x 23 mm
- 27.5136 60 x 23 mm

MEDIAL

CASPAR

27.5114

Sperrer komplett mit 5 Valven

27.5132 - 27.5136 & 27.5152 - 27.5156

Retractor complete with 5 blades

27.5132 - 27.5136 & 27.5152 - 27.5156

Ecarteur complet avec 5 valves

27.5132 - 27.5136 & 27.5152 - 27.5156

Separador completo con 5 valvas

27.5132 - 27.5136 & 27.5152 - 27.5156

27.5115

Sperrer allein / retractor only

ecarteur seul / separador solamente



CASPAR

27.5120

Sperrer komplett mit 5 Valven

27.5132 - 27.5136 & 27.5152 - 27.5156

Retractor complete with 5 blades

27.5132 - 27.5136 & 27.5152 - 27.5156

Ecarteur complet avec 5 valves

27.5132 - 27.5136 & 27.5152 - 27.5156

Separador completo con 5 valvas

27.5132 - 27.5136 & 27.5152 - 27.5156

27.5121

Sperrer allein / retractor only

ecarteur seul / separador solamente



CASPAR

27.5152 40 x 23 mm

27.5153 45 x 23 mm

27.5154 50 x 23 mm

27.5155 55 x 23 mm

27.5156 60 x 23 mm

LATERAL

Valven für CASPAR Sperrer
 Blades for CASPAR retractors
 Valves pour écarteurs CASPAR
 Valvas para separadores CASPAR



CASPAR TITANIUM

- 27.5122 40 x 25 mm
- 27.5123 45 x 25 mm
- 27.5124 50 x 25 mm
- 27.5125 55 x 25 mm
- 27.5126 60 x 25 mm

MEDIAL



CASPAR

- 27.5152 40 x 23 mm
- 27.5153 45 x 23 mm
- 27.5154 50 x 23 mm
- 27.5155 55 x 23 mm
- 27.5156 60 x 23 mm

LATERAL



CASPAR

- 27.5132 40 x 23 mm
- 27.5133 45 x 23 mm
- 27.5134 50 x 23 mm
- 27.5135 55 x 23 mm
- 27.5136 60 x 23 mm

MEDIAL



CASPAR

- 27.5164 50 x 25 mm
- 27.5166 60 x 25 mm



CASPAR TITANIUM

- 27.5142 40 x 25 mm
- 27.5143 45 x 25 mm
- 27.5144 50 x 25 mm
- 27.5145 55 x 25 mm
- 27.5146 60 x 25 mm

LATERAL



CASPAR

- 27.5183 45 x 23 mm
- 27.5184 50 x 23 mm
- 27.5185 55 x 23 mm
- 27.5186 60 x 23 mm
- 27.5187 65 x 23 mm



CASPAR

27.5199

Pinzette zum Blattwechsel
 Forceps for changing valves
 Pince pour changer les valves
 Pinza para cambiar valvas



CASPAR
 20 cm
 27.5220 55 x 14 mm
 27.5222 67 x 17 mm

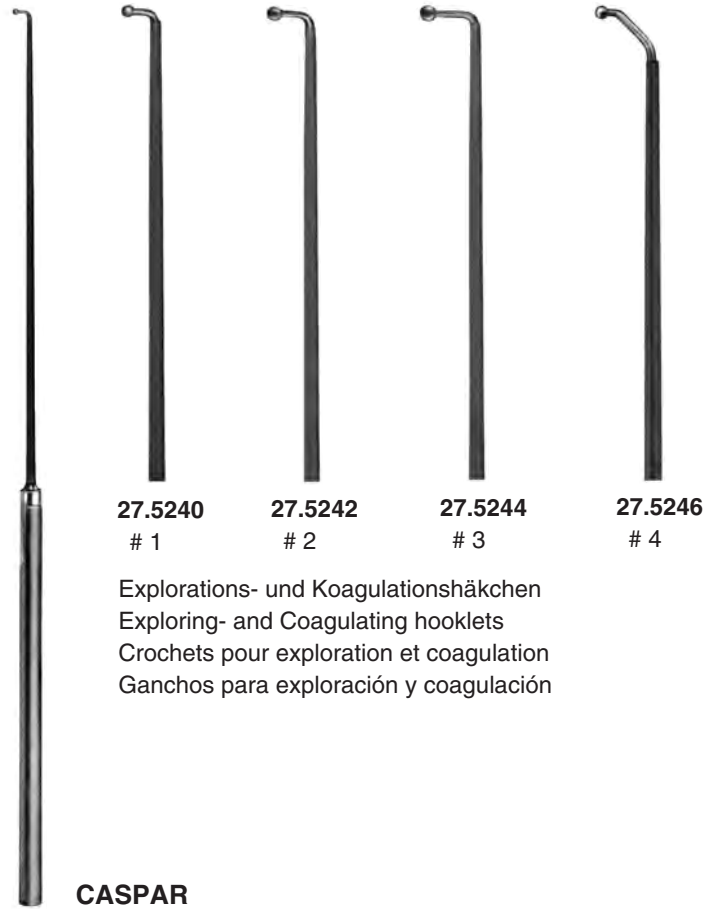

27.5240 # 1 27.5242 # 2 27.5244 # 3 27.5246 # 4

Explorations- und Koagulationshäkchen
 Exploring- and Coagulating hooklets
 Crochets pour exploration et coagulation
 Ganchos para exploración y coagulación

Raspatorien und Elevatorien / Raspatories and Elevators
 Rugines et Elevateurs / Périostotomos y Elevadores

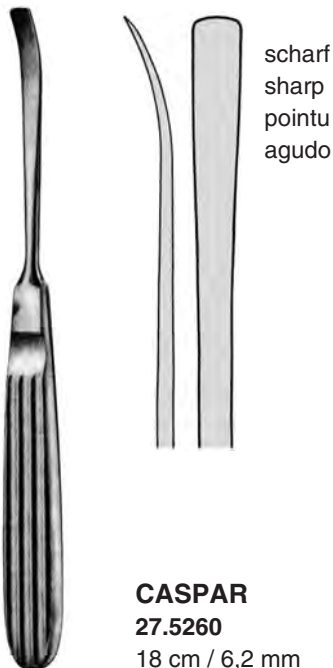

CASPAR
 27.5260
 18 cm / 6,2 mm

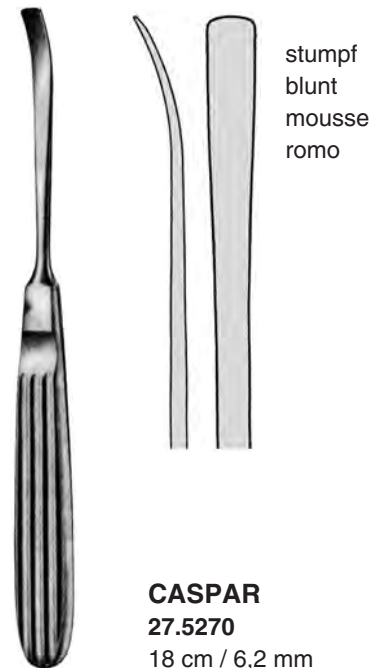

CASPAR
 27.5270
 18 cm / 6,2 mm



- 27.5401 45 mm
- 27.5402 50 mm
- 27.5403 55 mm
- 27.5404 60 mm
- 27.5405 65 mm



modifiziertes Model
 improved model
 modèle modifié
 modelo modificado

CASPAR
 27.5401 - 27.5405



CASPAR
 27.5420

Sperrer komplett mit 6 Valven 27.5430 - 27.5435
 Retractor complete with 6 blades 27.5430 - 27.5435
 Ecarteur complet avec 6 valves 27.5430 - 27.5435
 Separador completo con 6 valvas 27.5430 - 27.5435

27.5421

Sperrer allein / retractor only
 ecarteur seul / separador solamente

27.5430 35 mm



27.5431 40 mm



27.5432 45 mm



27.5433 50 mm



27.5434 55 mm



27.5435 60 mm



27.5436 65 mm



27.5437 75 mm



27.5438 85 mm





CASPAR

27.5440

Gegensperrer komplett mit 6 Valven
Counter-Retractor complete with 6 blades:
Ecarteur complet avec 6 valves:
Separador completo con 6 valvas:
27.5430 - 27.5435 (Seite 183 / page 183 /
page 183 / pagina 183)

27.5441

Sperrer allein
Retractor only
Ecarteur seul
Separador solamente



CASPAR

27.5500

Distraktor, von links komplett mit 27.5509 Bohrlehre rechts, 27.5520 Bohrer für
Distraktionsschrauben, 27.5536 (2) Bohrer 1,7mm Ø, 27.5550 Schraubenzieher

Vertebral Body Distractor, from left, complete with: 27.5509 Drill Guide, right;
27.5520 Drill for Distraction Screws, 27.5536 (2) Distraction screws,
27.5550 Screwdriver

Distracteur vertébral, de gauche, complet avec: 27.5509 Guide-mèche de
droite, 27.5520 mèche, 27.5536 (2) vis à distraction, 27.5550 Tourne-vis.

Distractor vertebral (derecha) completo con: 27.5509 guía para brocas,
27.5520 broca, 27.5536 (2) tornillos para distracción, 27.5550 destornillador.

27.5501

Distraktor alleine/Distractor only/Distracteur seul/Distractor suelto



Bohrlehre für
Drill guide for
Guide-mèche pour
Guia para brocas para
27.5500

27.5509



CASPAR
27.5510

Distraktor, von rechts komplett mit 27.5519 Bohrlehre links, 27.5520 Bohrer für
Distraktionsschrauben, 27.5536 (2) Bohrer 1,7mm Ø, 27.5550 Schraubenzieher

Vertebral Body Distractor, from right, complete with: 27.5519 Drill Guide, left;
27.5520 Drill for Distraction Screws, 27.5536 (2) Distraction screws, 27.5550
Screwdriver

Distracteur vertebraal, de droite, complet avec: 27.5519 Guide-mèche de gauche,
27.5520 mèche, 27.5536 (2) vis à distraction, 27.5550 Tourne-vis.

Distractor vertebraal (izquierda) completo con: 27.5519 guia para brocas, 27.5520
broca, 27.5536 (2) tornillos para distracción, 27.5550 destornillador.

27.5511

Distraktor alleine/Distractor only/Distracteur seul/Distractor suelto



27.5519

Bohrlehre für
Drill guide for
Guide-mèche pour
Guia para brocas para
27.5510



Bohrer
Drill
Mèche
Broca

CASPAR
27.5520
14,5 cm / 1,7 mm



Distraktionsschraube
Distraction screw
Vis à distraction
Tornillo para distracción

CASPAR
27.5534 14 mm
27.5536 16 mm
27.5538 18 mm



Schraubenzieher
Screwdriver
Tourne-vis
Destornillador

CASPAR
27.5550 20 cm



27.5561
1



27.5562
2

Längsband-Dissektoren
Vertebral body dissector
Dissecteurs vertébraux
Disecadores para cuerpos vertebrales

CASPAR
20,5 cm

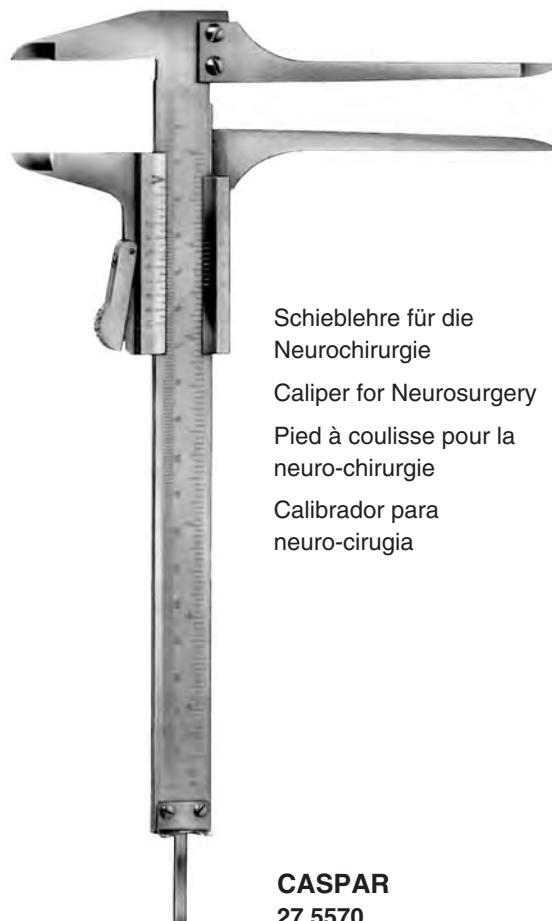

Schieblehre für die
Neurochirurgie
Caliper for Neurosurgery
Pied à coulisse pour la
neuro-chirurgie
Calibrador para
neuro-cirugia

CASPAR
27.5570



Halte- und Einschlaginstrument
 Bone graft holder and impactor
 Tendeur et impacteur
 Impactor

CASPAR
 27.5580
 21 cm



27.5593
 3 mm

27.5595
 5 mm

27.5598
 8 mm

Stößel
 Tampers
 hémostats
 hemostaticas

CASPAR
 20 cm



Knochenmarkschneider
 Graft cutter
 Pince coupante moelle
 Pinza para cortar médula

CASPAR
 27.5600
 22 cm

MIKROCHIRURGIE

MICROSURGERY

MICROCHIRURGIE

MICROCIRUGA

TITANIUM



10 cm



30.2000
0,8 mm



30.2001
0,8 mm



30.2003
0,8 mm



30.2009
0,8 mm



30.2000 T
0,8 mm



30.2001 T
0,8 mm



30.2003 T
0,8 mm

TITANIUM



10 cm



30.2004
0,5 mm



30.2005
0,5 mm



30.2007
0,5 mm

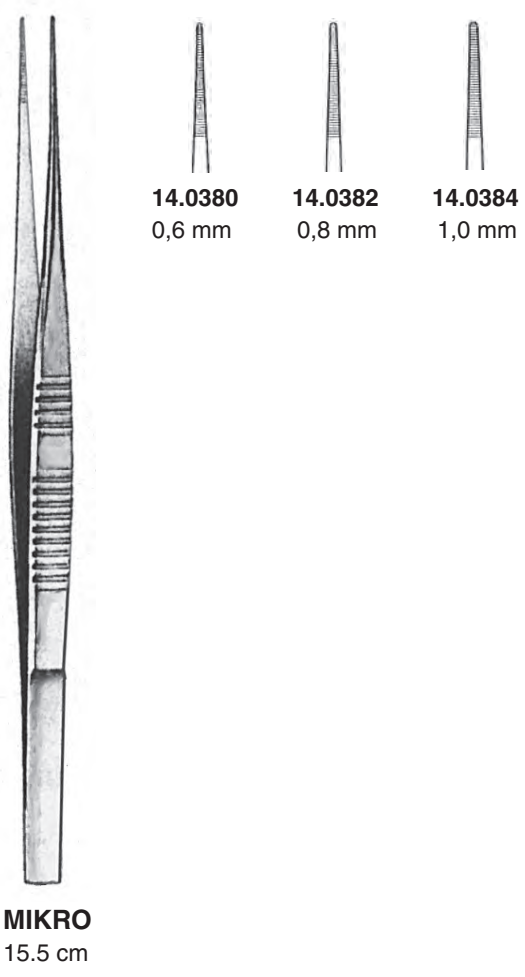
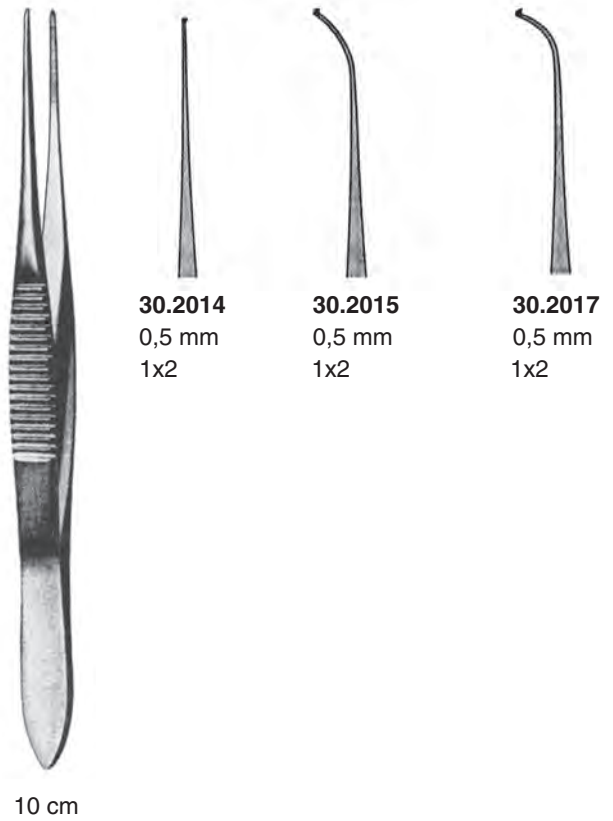
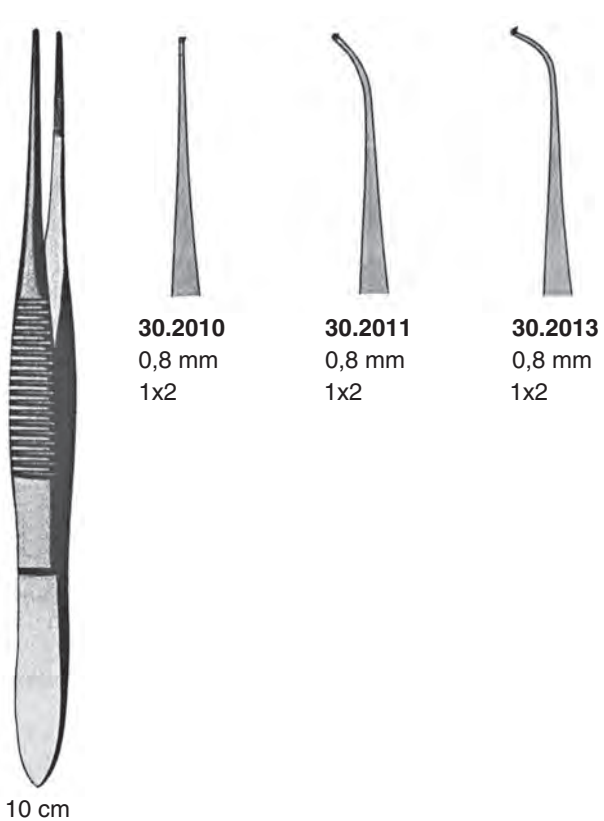



JACOBSEN-MICRO

28.0011 11 cm

28.0015 15 cm

28.0018 18 cm



JACOBSEN-ADSON

28.0030 12 cm



JACOBSEN-ADSON

28.0032 15 cm



12 cm / 8 mm



28.0080



28.0081



15 cm / 8 mm



28.0082



28.0083

Mikro-Knüpfpinzetten
Micro Suture Forceps
Micro Pincès à sutures
Micro pinzas para suturas



18 cm / 8 mm

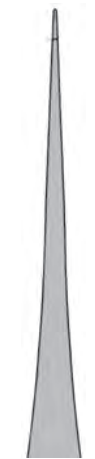

28.0084



28.0085



21 cm / 8 mm



28.0086



28.0087

Tumor- und Gewebefäßpinzetten
Tumor- and Tissue Grasping Forceps
Pincers pour saisir tumeurs et tissus
Pinzas para coger tejidos y tomores



HUNT
20 cm

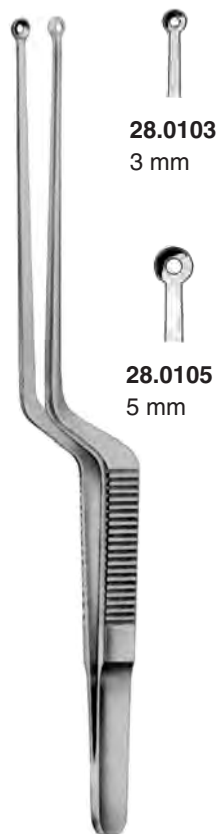

YASARGIL
22 cm
löffelförmig
spoon-shaped
forme de cuillère
forma cuchara

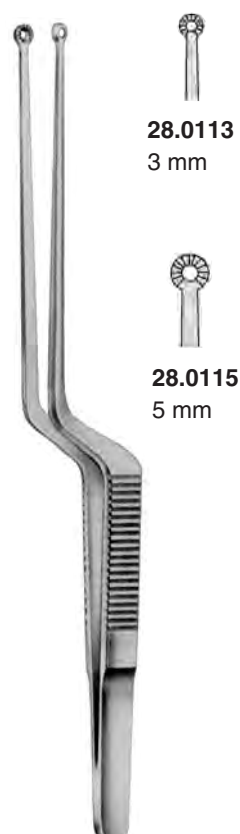

YASARGIL
22 cm
flach gezahnt
flat serrated
plat dentelé
plana dentada

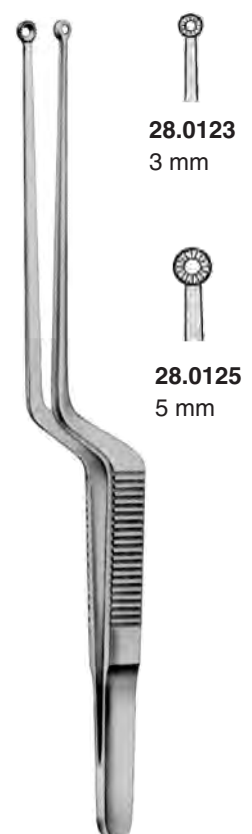

HEIFETZ
22 cm
kürettenförmig
curette-shaped
forme de curette dentelée
forma cureta, dentada



scharf
 sharp
 pointu
 agudo

28.0130 18.5 cm
28.0136 22.5 cm



stumpf
 blunt
 mousse
 romo

28.0132 18.5 cm
28.0138 22.5 cm



28.0200
 13 cm
 scharf
 sharp
 pointu
 agudo



28.0202
 13 cm
 stumpf
 blunt
 mousse
 romo













TITANIUM



Diamantbeschichtete Spitzen
Diamond coated tips
Avec bouts de diamant
Puntas con cascós de diamante















RHOTON

							
0,4mm							
15 cm	28.0220	28.0220SD	28.0220S		28.0221	28.0221SD	28.0221S
18 cm	28.0222	28.0222SD	28.0222S		28.0223	28.0223SD	28.0223S
21 cm	28.0224	28.0224SD	28.0224S		28.0225	28.0225SD	28.0225S
23 cm	28.0226	28.0226SD	28.0226S		28.0227	28.0227SD	28.0227S

TITANIUM

TITANIUM

							
0,8mm							
15 cm	28.0230	28.0230SD	28.0230S		28.0231	28.0231SD	28.0231S
18 cm	28.0232	28.0232SD	28.0232S		28.0233	28.0233SD	28.0233S
21 cm	28.0234	28.0234SD	28.0234S		28.0235	28.0235SD	28.0235S
23 cm	28.0236	28.0236SD	28.0236S		28.0237	28.0237SD	28.0237S

TITANIUM

TITANIUM







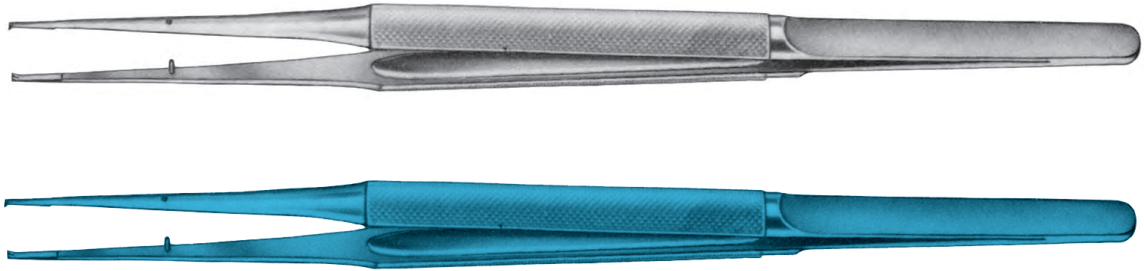

















TITANIUM



Diamantbeschichtete Spitzen
 Diamond coated tips
 Avec bouts de diamant
 Puntas con cascós de diamante



RHOTON

							
6 x 0,4mm				6 x 0,4 mm			
15 cm	28.0260	28.0260SD	28.0260S	15 cm	28.0261	28.0261SD	28.0261S
18 cm	28.0262	28.0262SD	28.0262S	18 cm	28.0263	28.0263SD	28.0263S
21 cm	28.0264	28.0264SD	28.0264S	21 cm	28.0265	28.0265SD	28.0265S
23 cm	28.0266	28.0266SD	28.0266S	23 cm	28.0267	28.0267SD	28.0267S
							
6 x 0,8mm				6 x 0,8 mm			
15 cm	28.0270	28.0270SD	28.0270S	15 cm	28.0271	28.0271SD	28.0271S
18 cm	28.0272	28.0272SD	28.0272S	18 cm	28.0273	28.0273SD	28.0273S
21 cm	28.0274	28.0274SD	28.0274S	21 cm	28.0275	28.0275SD	28.0275S
23 cm	28.0276	28.0276SD	28.0276S	23 cm	28.0277	28.0277SD	28.0277S
	TITANIUM				TITANIUM		

TITANIUM



Diamantbeschichtete Spitzen
 Diamond coated tips
 Avec bouts de diamant
 Puntas con cascos de diamante

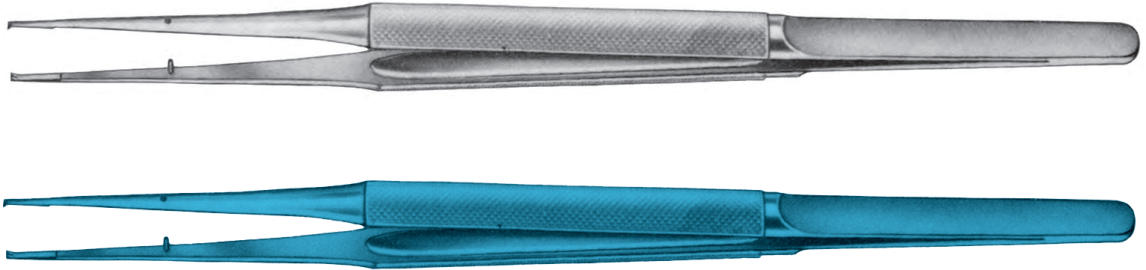

RHOTON

6 x 0,4mm				6 x 0,4 mm			
15 cm	28.0280	28.0280SD	28.0280S	15 cm	28.0281	28.0281SD	28.0281S
18 cm	28.0282	28.0282SD	28.0282S	18 cm	28.0283	28.0283SD	28.0283S
21 cm	28.0284	28.0284SD	28.0284S	21 cm	28.0285	28.0285SD	28.0285S
23 cm	28.0286	28.0286SD	28.0286S	23 cm	28.0287	28.0287SD	28.0287S

6 x 0,8mm				6 x 0,8 mm			
15 cm	28.0290	28.0290SD	28.0290S	15 cm	28.0291	28.0291SD	28.0291S
18 cm	28.0292	28.0292SD	28.0292S	18 cm	28.0293	28.0293SD	28.0293S
21 cm	28.0294	28.0294SD	28.0294S	21 cm	28.0295	28.0295SD	28.0295S
23 cm	28.0296	28.0296SD	28.0296S	23 cm	28.0297	28.0297SD	28.0297S

TITANIUM

TITANIUM













TITANIUM



Diamantbeschichtete Spitzen
 Diamond coated tips
 Avec bouts de diamant
 Puntas con cascós de diamante





RHOTON

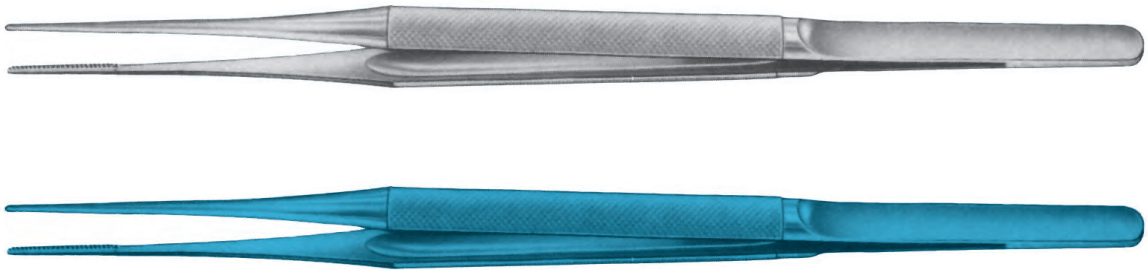

							
1 x 0,5mm				2 x 1,0 mm			
15 cm	28.0240	28.0240SD	28.0240S	15 cm	28.0250	28.0250SD	28.0250S
18 cm	28.0242	28.0242SD	28.0242S	18 cm	28.0252	28.0252SD	28.0252S
21 cm	28.0244	28.0244SD	28.0244S	21 cm	28.0254	28.0254SD	28.0254S
23 cm	28.0246	28.0246SD	28.0246S	23 cm	28.0256	28.0256SD	28.0256S
TITANIUM				TITANIUM			

TITANIUM



DEBAKEY

		
1,2 mm		
15 cm	28.0320	28.0320S
18 cm	28.0322	28.0322S
21 cm	28.0324	28.0324S
23 cm	28.0326	28.0326S
	TITANIUM	

		
1,8 mm		
15 cm	28.0330	28.0330S
18 cm	28.0332	28.0332S
21 cm	28.0334	28.0334S
23 cm	28.0336	28.0336S
	TITANIUM	



28.0600 16 cm
28.0602 18 cm
28.0604 20 cm
28.0606 22 cm
28.0608 24 cm

Spitzen 0,6 mm
 Tips 0,6 mm
 bout 0,6 mm
 punta 0,6 mm



28.0610 16 cm
28.0612 18 cm
28.0614 20 cm
28.0616 22 cm
28.0618 24 cm

Spitzen 0,9 mm
 Tips 0,9 mm
 bout 0,9 mm
 punta 0,9 mm



28.0622 18 cm

1 x 2 Zähne
 1 x 2 teeth
 1 x 2 dents
 1 x 2 dientes





Ø 3 mm 
YASARGIL
YASARGIL-SAMII
 28.0710 22 cm
 28.0700 24 cm

Ø 5 mm 
YASARGIL
YASARGIL-SAMII
 28.0712 22 cm
 28.0702 24 cm

Ø 7 mm 
YASARGIL-SAMII
 28.0704 24 cm

löffelförmig
 spoon-shaped
 en forme de cuillère
 forma cuchara

Ø 3 mm 
YASARGIL
 28.0714 22 cm
 gezahnt/serrated/
 dentelés/dentada

Ø 3 mm 
HEIFETZ
 28.0715 22 cm
 gezahnt/serrated/
 dentelés/dentada

Ø 5 mm 
HEIFETZ
 28.0717 22 cm
 kürettenförmig gezahnt
 curette-shaped serrated
 en forme de curette dentelés
 forma cureta dentada

Ø 5 mm 
YASARGIL
 28.0716 22 cm
 flach, gezahnt
 flat, serrated
 mors plats, dentelés
 boca plana, dentada

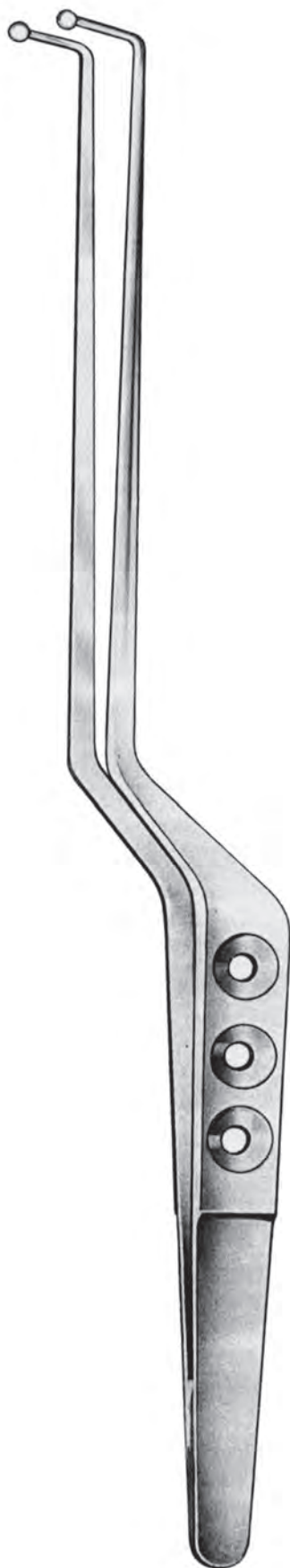

SAMII
23 cm

löffelförmig
spoon-shaped
en forme de cuillère
forma cuchara

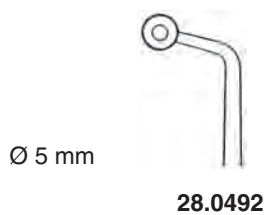
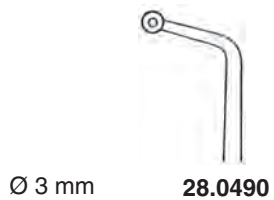



28.2110
15,5 cm

VANNAS-MIKRO



28.2111
15,5 cm

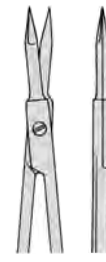

28.2112
18,5 cm

VANNAS-MIKRO



28.2113
18,5 cm



28.2114
23 cm

VANNAS-MIKRO



28.2115
23 cm



VANNAS-MIKRO



28.2100 12,5 cm / Ø 7 mm
gerade
straight
droit
recto

28.2101 12,5 cm / Ø 7 mm
gebogen
curved
courbe
curvo



VANNAS-MIKRO



28.2102
15 cm
Ø 8 mm
28.2104
18cm



28.2103
15 cm
Ø 8 mm
28.2105
18 cm



28.2122
15 cm / Ø 8 mm
gerade / straight /
droit / recto



28.2123
15 cm / Ø 8 mm
gebogen / curved /
courbe / curvo



28.2133
15 cm / Ø 8 mm
gebogen / curved /
courbe / curvo



28.2120
12,5 cm / Ø 7mm
gerade / straight
droit / recto



28.2121
12,5 cm / Ø 7 mm
gebogen / curved
courbe / curvo



28.2124
18 cm / Ø 8 mm
gerade / straight
droit / recto

28.2125
18 cm / Ø 8 mm
gebogen / curved
courbe / curvo



28.2150 (GYN)
18 cm / Ø 8 mm
gerade / straight
droit / recto

28.2151 (GYN)
18 cm / Ø 8 mm
gebogen / curved
courbe / curvo



28.2190 15 cm
gerade / straight
droit / recto

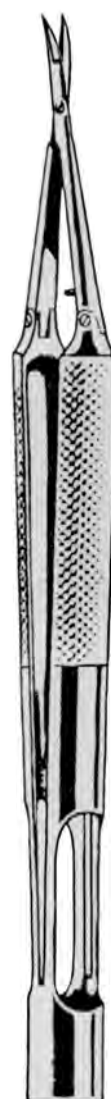

28.2191 15 cm
gebogen / curved
courbe / curvo



28.2200
18 cm 25°



28.2201
18 cm 45°



28.2202
18 cm 60°



28.2203
18 cm 90°



28.2204
18 cm 125°

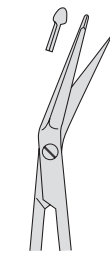

13.1110
18 cm 25°

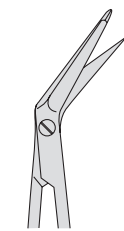

13.1111
18 cm 45°



13.1112
18 cm 60°

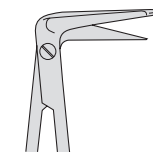

13.1113
18 cm 90°

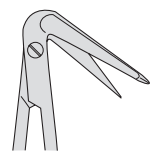

13.1114
18 cm 125°

ARTERIOTOMY



28.2220
16 cm



28.2221
16 cm



28.2222
19 cm



28.2223
19 cm



28.2225
19 cm

JACOBSON

JACOBSON



28.2230
16 cm



28.2231
16 cm

gezahnt
serrated
dentelées
dentada



28.2300
15,5 cm



28.2301
15,5 cm

MILLES

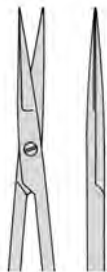

28.2310
18,5 cm

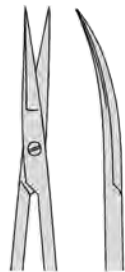

28.2311
18,5 cm

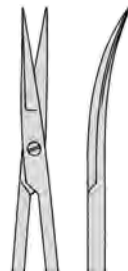

28.2313
18,5 cm



28.2315
18,5 cm



28.2350
23 cm



28.2351
23 cm

Venenschere
Vein Scissors
Ciseaux pour veines
Tijera para venas



BIEMER
28.2400
13 cm



18 cm

Koronarscheren
Coronary Artery Scissors
Ciseaux coronaire
Tijeras para arteria coronar



28.2480
25°



28.2481
45°



28.2482
60°



28.2483
90°



28.2484
125°



28.2490
25°



28.2491
45°



28.2492
60°



28.2493
90°



28.2494
125°

mit 1 geknöpften Blatt / 1 probe-pointed blade
avec 1 lame boutonée / con una punta botonada

TITANIUM



28.2501
18 cm 45°



28.2521
18 cm 45°



28.2550
15 cm / Ø 8 mm

28.2552
18 cm / Ø 8 mm



28.2551
15 cm / Ø 8 mm

28.2553
18 cm / Ø 8 mm



28.2600 16,5 cm
28.2602 20,0 cm



28.2601 16,5 cm
28.2603 20,0 cm



28.2605 20,0 cm



28.2608 20,0 cm



28.2609 20,0 cm



28.2620 22,5 cm



28.2623 22,5 cm



28.2624 22,5 cm

28.2622 22,5 cm

gezahnt
 serrated
 dentelées
 dentada



28.2628 22,5 cm

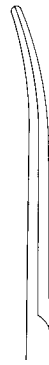

28.2629 22,5 cm



28.2640 22,5 cm



28.2641 22,5 cm

VANNAS



NAGEL

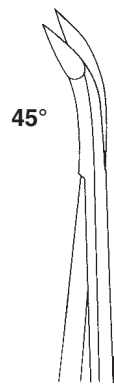

45°

28.2656 20,0 cm



45°

28.2657 20,0 cm

geknöpft
button-end
boutonnée
abotonada



125°

28.2659 20,0 cm



VANNAS
 28.2711 12 cm



28.2712 12 cm
28.2716 16 cm



28.2713 12 cm
28.2717 16 cm

MILLES
28.2720 16 cm
 gezahnt/serrated
 dentelés/dentadas

MILLES
28.2721 16 cm
 gezahnt/serrated
 dentelés/dentadas

YASARGIL
28.2722 18,5 cm

JACOBSON
28.2723 18,5 cm



VANNAS
28.2714 12 cm
28.2718 16 cm



VANNAS
28.2715 12 cm
28.2719 16 cm















POTTS-YASARGIL
28.2724 18,5 cm



BIEMER
28.2728 12 cm

Venenschere
 Vein Scissors
 Ciseaux pour veines
 Tijera para venas



	Mikro-Scheren micro-scissors micro-ciseaux micro-tijeras	Mikro-Scheren fein micro-scissors fine micro-ciseaux fins micro-tijeras fino
gerade straight droites recta	 28.4010	 28.4040
gerade horizontal straight horizontal coupant horizontal recta horizontal	 28.4012	 28.4042
aufgebogen curved up courbe vers le haut curva hacia arriba	 28.4013	 28.4043
aufgebogen horizontal curved up horizontal coupant horizontal, courbe sur le plat curva hacia arriba horizontal	 28.4015	 28.4045
nach rechts gebogen curved to right courbe à droit curva a la derecha	 28.4017	 28.4047
nach links gebogen curved to left courbe à gauche curva a la izquierda	 28.4019	 28.4049
gerade 8 mm straight 8 mm droites 8 mm recta 8 mm	 28.4020	



28.3130
12,5 cm / Ø 7 mm
gerade
straight
droit
recto

28.3131
12,5 cm / Ø 7 mm
gebogen
curved
courbe
curvo



28.3132
12,5 cm / Ø 7 mm
gerade mit Sperre
straight with lock
droit avec arrêt
recto con cierre

28.3133
12,5 cm / Ø 7 mm
gebogen mit Sperre
curved with lock
courbe avec arrêt
curvo con cierre



28.3140
15 cm / Ø 8 mm
gerade
straight
droit
recto

28.3150
18 cm / Ø 8mm
gerade
straight
droit
recto



28.3141
15 cm / Ø 8 mm
gebogen
curved
courbe
curvo

28.3151
18 cm / Ø 8 mm
gebogen
curved
courbe
curvo



28.3142
15 cm / Ø 8 mm
gerade mit Sperre
straight with lock
droit avec arrêt
recto con cierre

28.3152
18 cm / Ø 8 mm
gerade mit Sperre
straight with lock
droit avec arrêt
recto con cierre



28.3143
15 cm / Ø 8 mm
gebogen mit Sperre
curved with lock
courbe avec arrêt
curvo con cierre

28.3153
18 cm / Ø 8 mm
gebogen mit Sperre
curved with lock
courbe avec arrêt
curvo con cierre



21 cm

28.3154
gerade
straight
droit
recto

28.3155
gebogen
curved
courbe
curvo



23 cm

28.3156
gerade
straight
droit
recto

28.3157
gebogen
curved
courbe
curvo



15 cm

28.3242

gerade
straight
droit
recto

28.3243

gebogen
curved
courbe
curvo



18 cm

28.3252

gerade
straight
droit
recto

28.3253

gebogen
curved
courbe
curvo

PROMEDUR



21 cm

28.3254
gerade
straight
droit
recto

28.3255
gebogen
curved
courbe
curvo



23 cm

28.3256
gerade
straight
droit
recto

28.3257
gebogen
curved
courbe
curvo

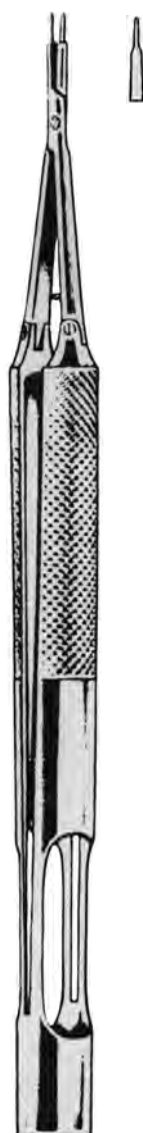

28.3300
15 cm

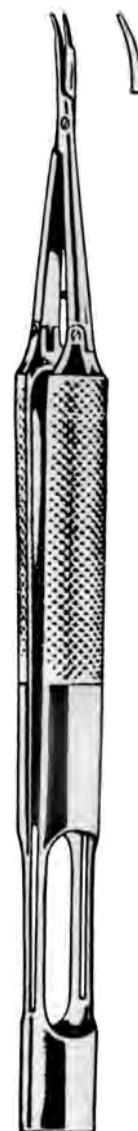

28.3301
15 cm

PROMEDUR



JACOBSON



28.3400
18,5 cm
28.3402
21 cm
28.3404
23 cm



JACOBSON



28.3406
18,5 cm
28.3408
21 cm



28.3450
23 cm



28.3451
23 cm

PROME(DUR)



Diamantbeschichtete Spitzen
Diamond coated tips
Avec bouts de diamant
Puntas con cascos de diamante



Maul 2 mm breit gerieft
Jaws 2 mm wide serrated
mors 2 mm, dentelées
boca 2 mm, dentadas

28.3662
18 cm / 10 mm

28.3664
21 cm / 10 mm

GREGORY



28.3662D
18 cm / 10 mm

28.3664D
21 cm / 10 mm

GREGORY



28.3100
15 cm



28.3101
15 cm



28.3102
15 cm



28.3103
15 cm

REILL







REILL

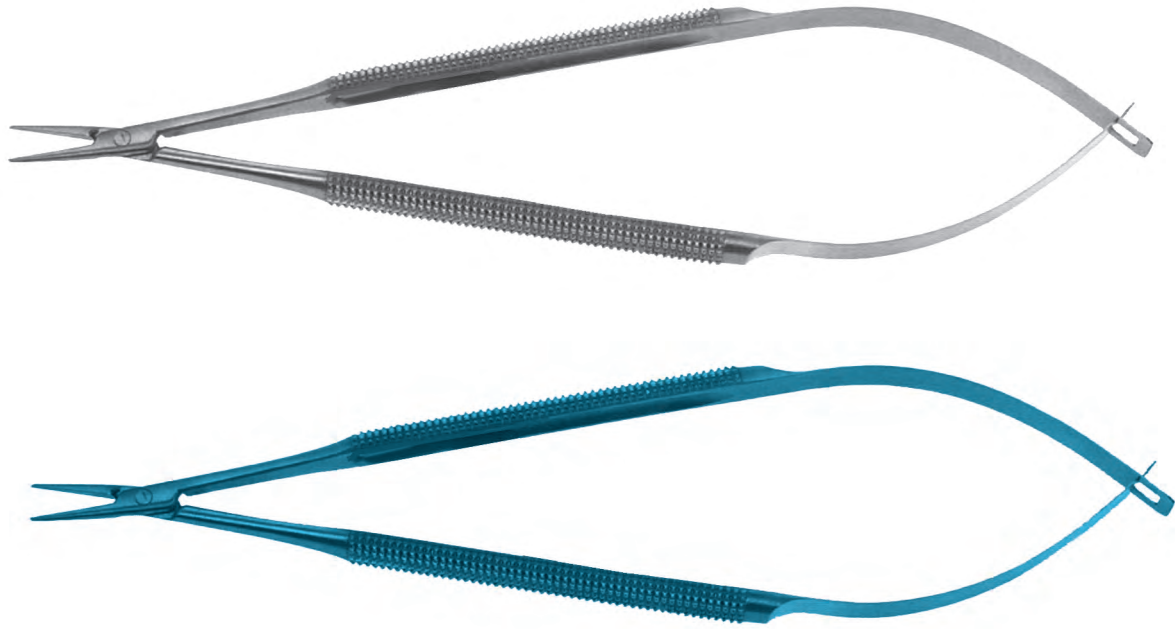





TITANIUM









Diamantbeschichtete Spitzen
 Diamond coated tips
 Avec bouts de diamant
 Puntas con cascós de diamante









			
0,4mm			
15 cm	28.3600	28.3600SD	28.3600S
18 cm	28.3602	28.3602SD	28.3602S
21 cm	28.3604	28.3604SD	28.3604S
23 cm	28.3606	28.3606SD	28.3606S

			
0,4mm			
15 cm	28.3601	28.3601SD	28.3601S
18 cm	28.3603	28.3603SD	28.3603S
21 cm	28.3605	28.3605SD	28.3605S
23 cm	28.3607	28.3607SD	28.3607S

			
0,8mm			
15 cm	28.3610	28.3610SD	28.3610S
18 cm	28.3612	28.3612SD	28.3612S
21 cm	28.3614	28.3614SD	28.3614S
23 cm	28.3616	28.3616SD	28.3616S

TITANIUM

			
0,8mm			
15 cm	28.3611	28.3611SD	28.3611S
18 cm	28.3613	28.3613SD	28.3613S
21 cm	28.3615	28.3615SD	28.3615S
23 cm	28.3617	28.3617SD	28.3617S

TITANIUM

TITANIUM



Diamantbeschichtete Spitzen
 Diamond coated tips
 Avec bouts de diamant
 Puntas con cascós de diamante

mit Sperre
 with lock
 avec arrêt
 con cierre

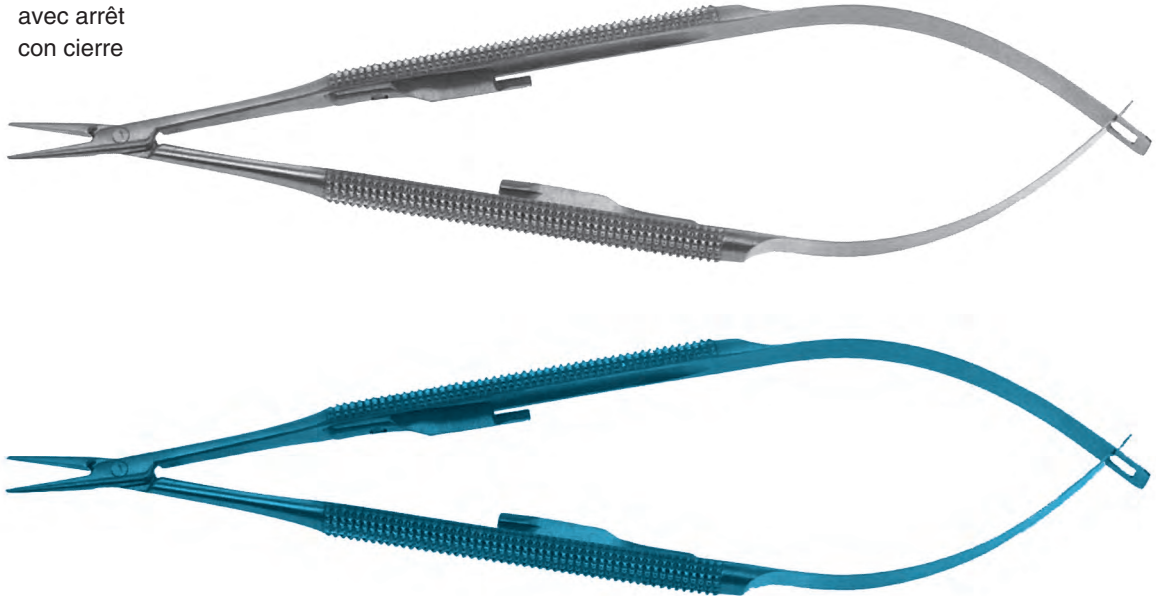

0,4mm			
15 cm	28.3630	28.3630SD	28.3630S
18 cm	28.3632	28.3632SD	28.3632S
21 cm	28.3634	28.3634SD	28.3634S
23 cm	28.3636	28.3636SD	28.3636S

0,4mm			
15 cm	28.3631	28.3631SD	28.3631S
18 cm	28.3633	28.3633SD	28.3633S
21 cm	28.3635	28.3635SD	28.3635S
23 cm	28.3637	28.3637SD	28.3637S

0,8mm			
15 cm	28.3640	28.3640SD	28.3640S
18 cm	28.3642	28.3642SD	28.3642S
21 cm	28.3644	28.3644SD	28.3644S
23 cm	28.3646	28.3646SD	28.3646S

0,8mm			
15 cm	28.3641	28.3641SD	28.3641S
18 cm	28.3643	28.3643SD	28.3643S
21 cm	28.3645	28.3645SD	28.3645S
23 cm	28.3647	28.3647SD	28.3647S

TITANIUM

TITANIUM

TITANIUM



Diamantbeschichtete Spitzen
Diamond coated tips
Avec bouts de diamant
Puntas con cascos de diamante

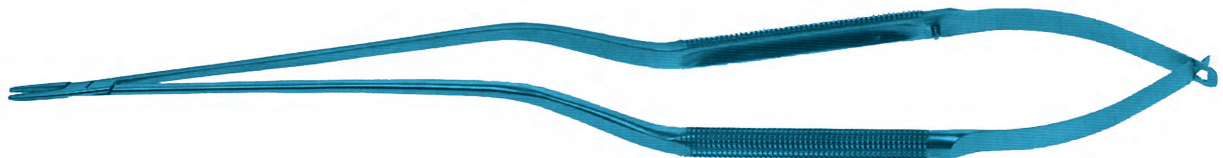

1 mm

21 cm



28.3700

TITANIUM



28.3700SD



28.3700S

1 mm

21 cm



28.3701

TITANIUM



28.3701SD



28.3701S

TITANIUM



Diamantbeschichtete Spitzen
Diamond coated tips
Avec bouts de diamant
Puntas con cascos de diamante

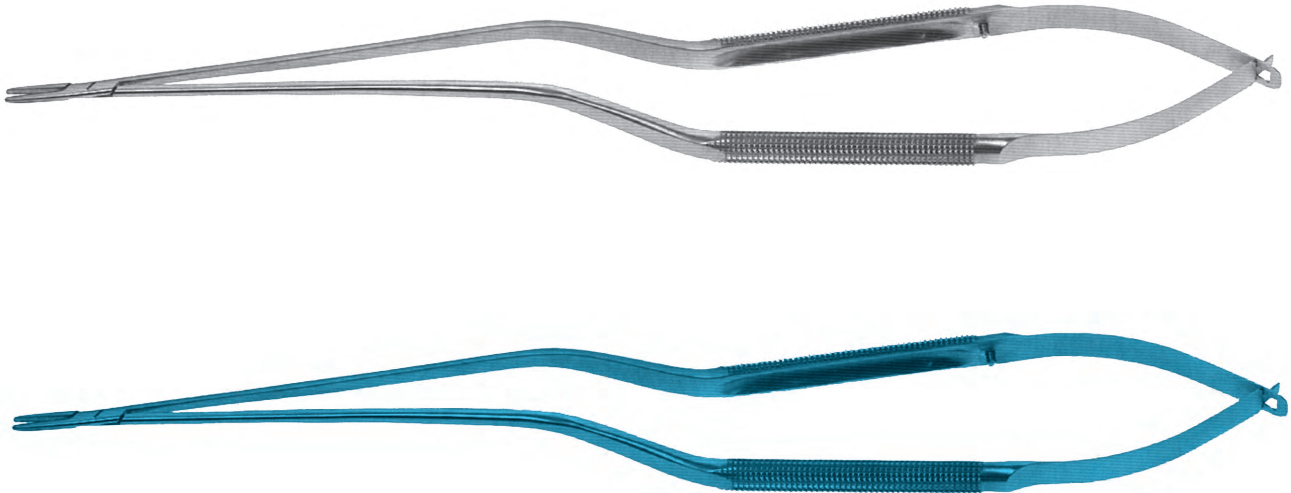

1 mm



28.3702

TITANIUM



28.3702SD



28.3702S

1 mm



28.3703

TITANIUM



28.3703SD



28.3703S

23 cm



28.3504 20,0 cm
28.3506 22,0 cm



28.3501 16,5 cm
28.3505 20,0 cm
28.3507 22,0 cm
28.3509 24,5 cm

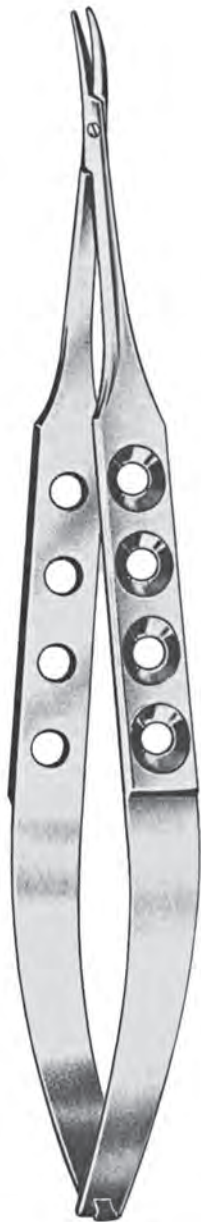

















28.3520 16,0 cm
28.3522 18,0 cm



28.3521 16,0 cm
28.3523 18,0 cm



gerade straight droit recto	 28.4100	 28.4105	 28.4110
aufgebogen curved up courbe vers le haut curva hacia arriba	 28.4101	 28.4106	 28.4111
nach rechts gebogen curved to right courbe à droit curva a la derecha	 28.4103	 28.4107	
nach links gebogen curved to left courbe à gauche curva a la izquierda	 28.4104	 28.4109	

gerade straight droit recto		
	28.4201 1,0 mm Ø	28.4241
	28.4202 1,5 mm Ø	
	28.4203 2,0 mm Ø	
aufgebogen curved up courbe vers le haut curva hacia arriba		
	28.4211 1,0 mm Ø	28.4242
	28.4212 1,5 mm Ø	
	28.4213 2,0 mm Ø	
nach rechts gebogen curved to right courbe à droit curva a la derecha		
	28.4221 1,0 mm Ø	28.4243
	28.4222 1,5 mm Ø	
	28.4223 2,0 mm Ø	
nach links gebogen curved to left courbe à gauche curva a la izquierda		
	28.4231 1,0 mm Ø	28.4244
	28.4232 1,5 mm Ø	
	28.4233 2,0 mm Ø	
	28.4234 2,5 mm Ø	

Mikro-Scheren
 micro-scissors
 micro-ciseaux
 micro-tijeras

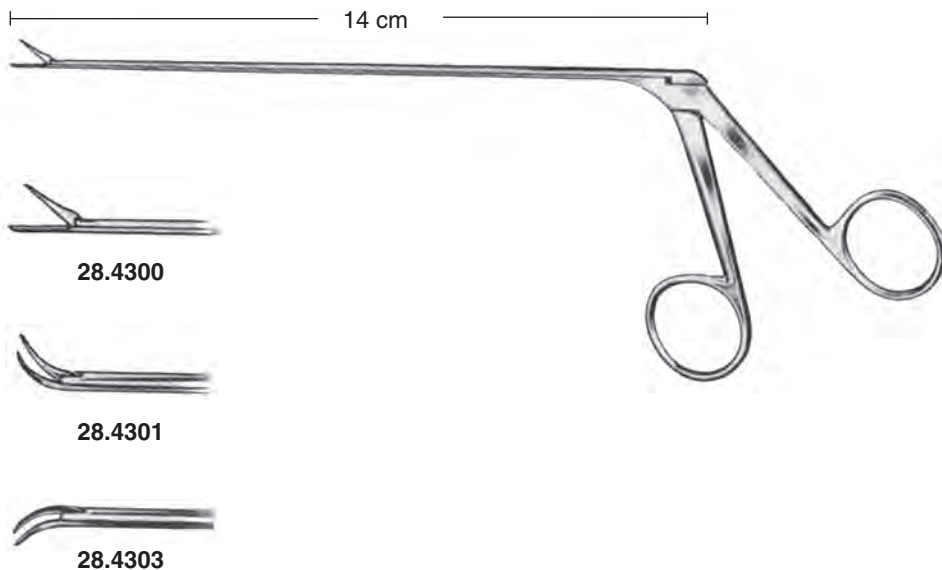

Mikro-Scheren
 micro-scissors
 micro-ciseaux
 micro-tijeras

Mikro Zängchen
 Micro forceps
 micro pince
 micro pinzas

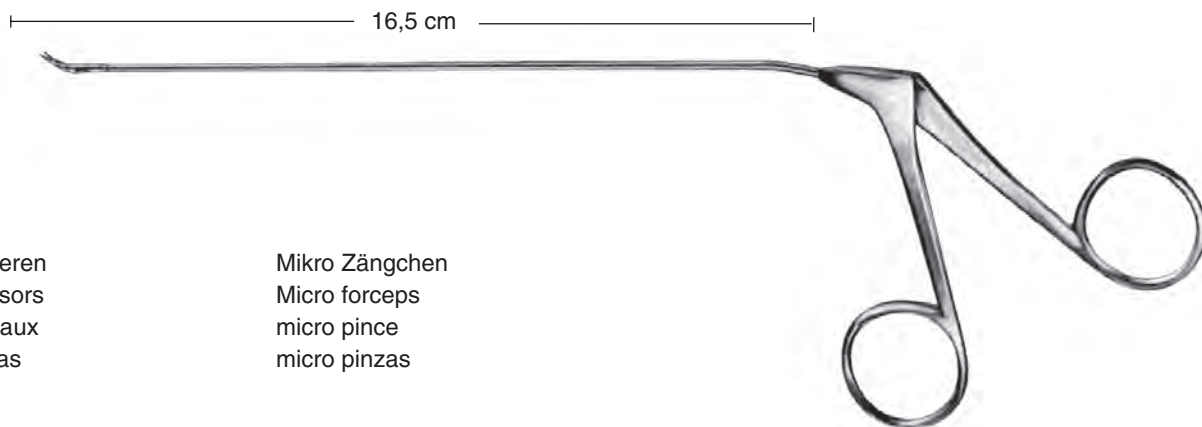

NICOLA
 28.4400



NICOLA
 28.4410



FAHLBUSCH
 28.4401



NICOLA
 28.4420
 2,5 mm

Dissektoren, Raspatorien, Sonden, Fadenführer
Dissectors, Raspatories, Probes, Ligature Guides
Rugines, Raspatoires, Sondes, Passes-fil
Disecadores, Raspadores, Sondas, Guías ligaduras



YASARGIL
28.6040
18, 5 cm
#1



28.6041
#2



28.6042
#3



28.6043
#4

Fadenführer
Ligature Guides
Guides à ligatures
Guías-ligaduras



RAY
28.6111
18 cm
4 mm / 45°

28.6114
45°

Hypophysenküretten, scharfe Löffel
Pituitary curettes, spoons
Curettes pour l'hypophyse
Curetas pituitarias



28.6116

28.6117



28.6118

NICOLA
21,5 cm



NICOLA
28.6119
21,5 cm



28.6131
4 mm

28.6132
6 mm

HARDY
26 cm

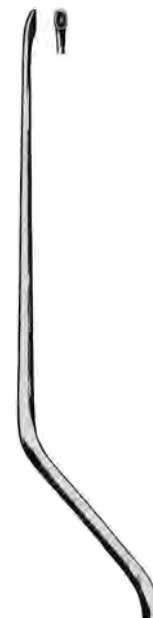

YASARGIL
28.6135
18,5 cm

Dissektoren, Raspatorien, Sonden, Fadenführer
Dissectors, Raspatories, Probes, Ligature Guides
Rugines, Raspatoires, Sondes, Passes-fil
Disecadores, Raspadores, Sondas, Guias ligaduras

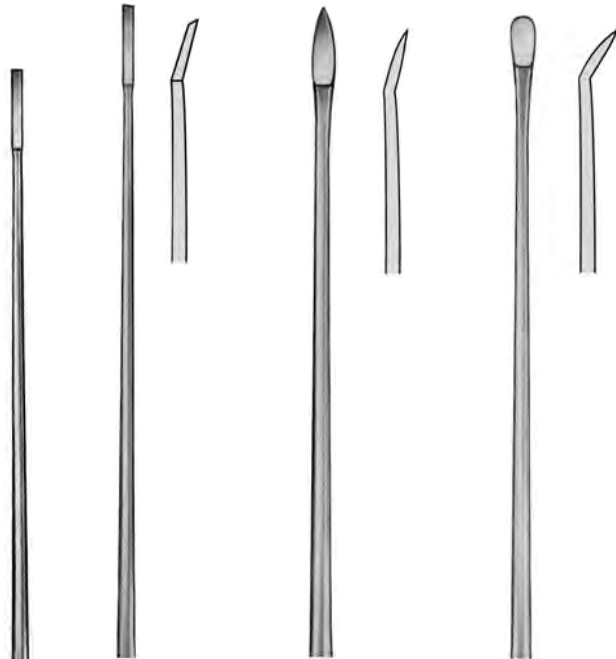

28.6001
1 mm

28.6002
2,5 mm

28.6003
4 mm

Gefäß-Dilatatoren
Vessel Dilators
Dilatateurs vasculaires
Dilatadores vasculares

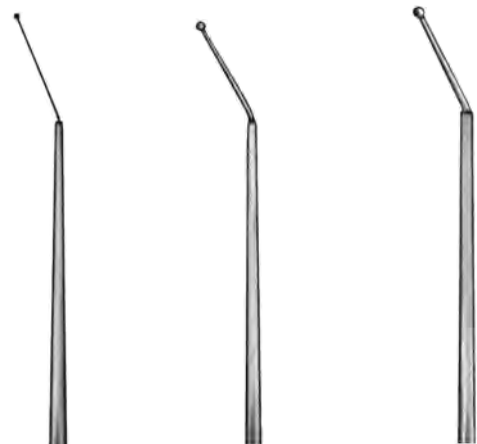

28.6007
12,5 cm
1,0 mm

28.6008
12,5 cm
1,5 mm

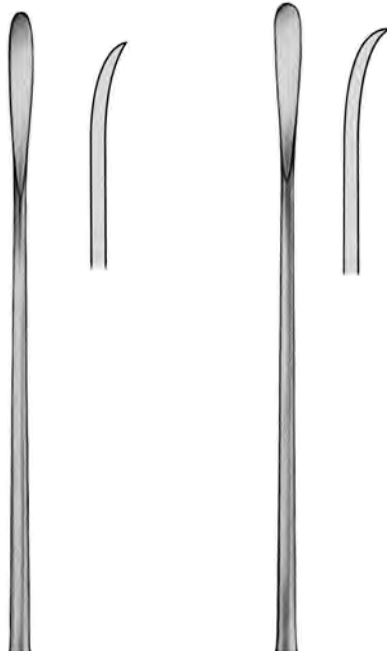

28.6004
2,5 mm

28.6005
3 mm

YASARGIL
18,5 cm

28.6006
12,5 cm
0,5 mm

Dissektoren, Raspatorien, Sonden, Fadenführer
 Dissectors, Raspatories, Probes, Ligature Guides
 Rugines, Raspatoires, Sondes, Passes-fil
 Disecadores, Raspadores, Sondas, Guias ligaduras

Gefäßspreizer
 Vesselspreader
 Separateur vasculaire
 Separador vascular



BIEMER
 28.6010
 16 cm



JACOBSON
 28.6011
 18,5 cm

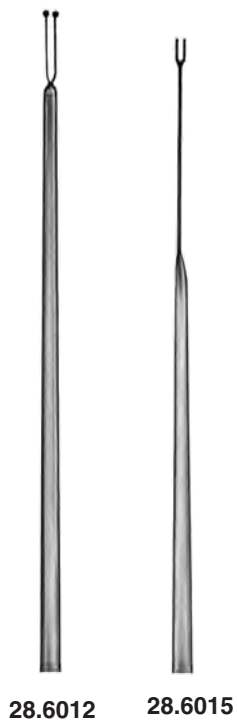

28.6012 28.6015



YASARGIL
 28.6020
 18,5 cm

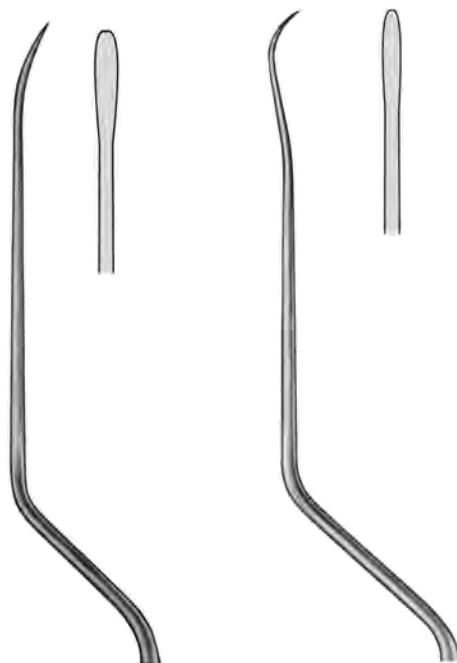

28.6020 28.6021



28.6022



HARDY
28.6138
24,5 cm

Enukleatoren, stumpf
Enucleators, blunt
Enucléateurs, mousse
Enucleadores, romo



28.6139



HARDY
28.6140 **28.6141**
Dissektoren, scharf
Dissectors, sharp
Dissecteurs, coupant
Disecadores, contante

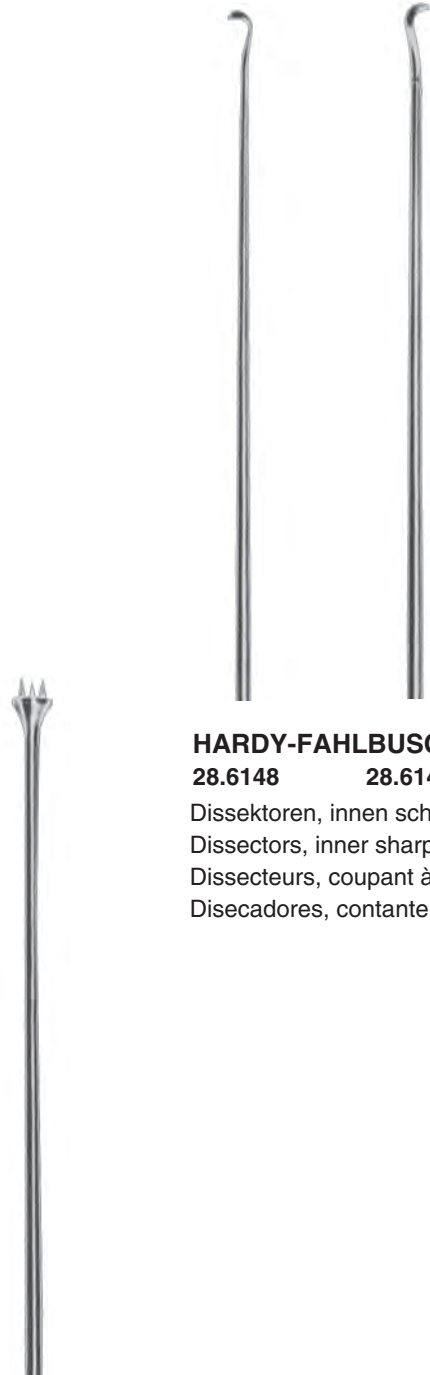

HARDY
28.6144

Implanttationsgabel
Implant Fork
Fourchette pour implants
Horquilla par implantar



HARDY-FAHLBUSCH
28.6148 **28.6149**
Dissektoren, innen scharf
Dissectors, inner sharp edge
Dissecteurs, coupant à l'interieur
Disecadores, contante en el interior



23 cm



28.6332
1 mm



28.6333
1,4 mm



28.6334
1,8 mm



CASPAR
28.6303
23 cm / 4,5 mm



CASPAR
28.6305
23 cm / 4,5 mm





CASPAR
28.6307
23 cm / 2 mm



CASPAR
28.6310
23 cm / 1 mm



CASPAR
28.6311
23 cm / 1 mm



CASPAR
28.6312
23 cm / 1 mm



JACOBSON
28.6300
18,5 cm

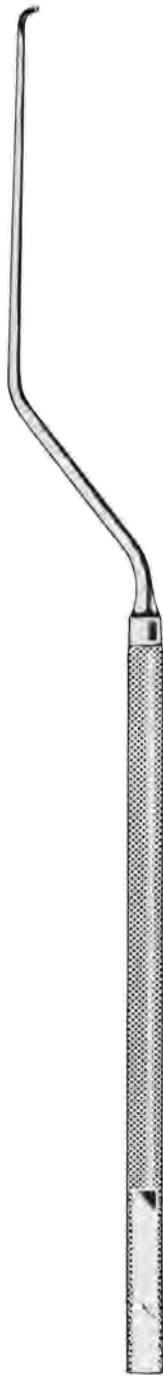

KOOS
18,5 cm



28.6351



28.6352



28.6353



28.6354

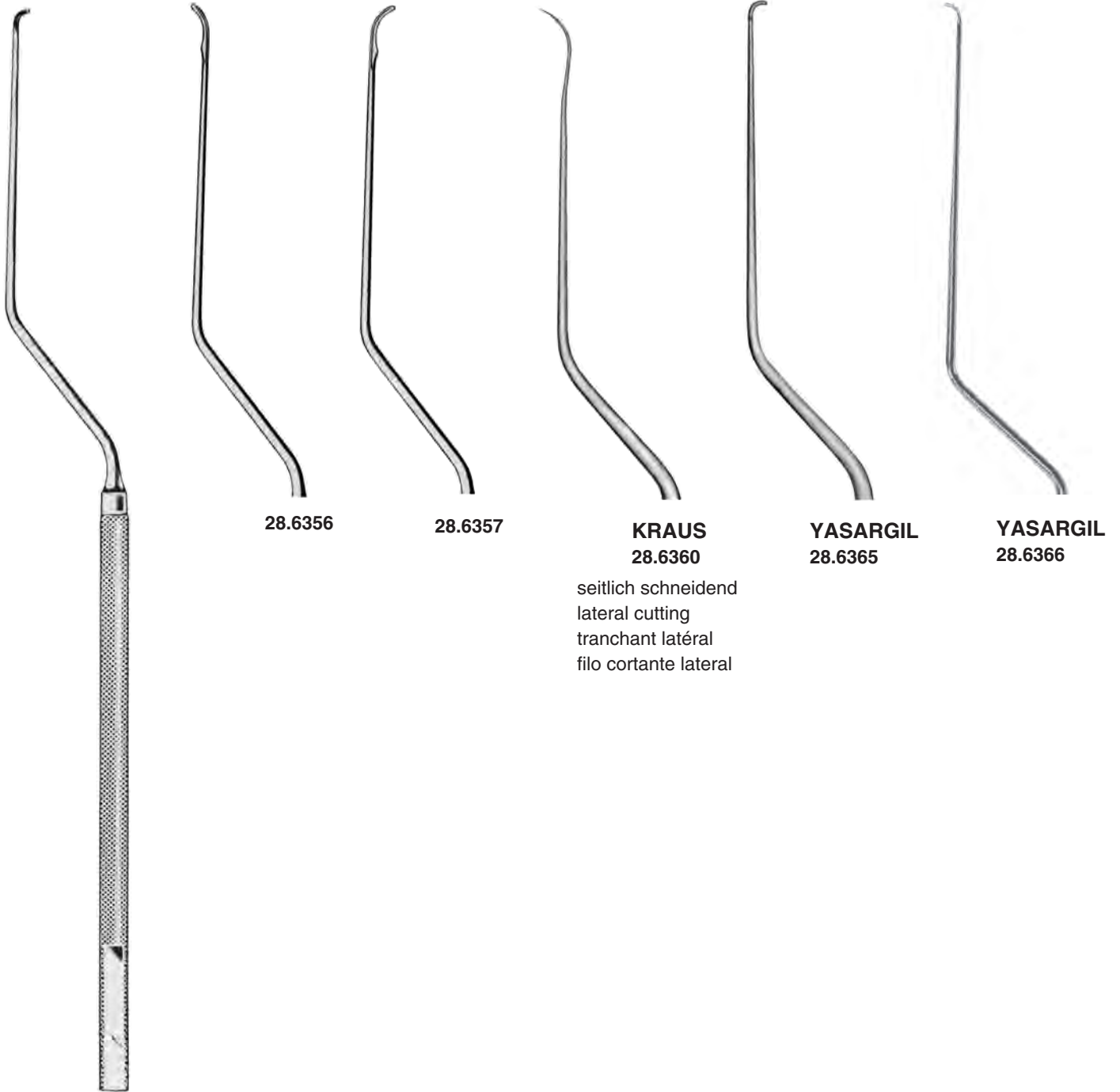

28.6356

28.6357

KRAUS
28.6360

seitlich schneidend
lateral cutting
tranchant latéral
filo cortante lateral

YASARGIL
28.6365

YASARGIL
28.6366

KOOS
18,5 cm

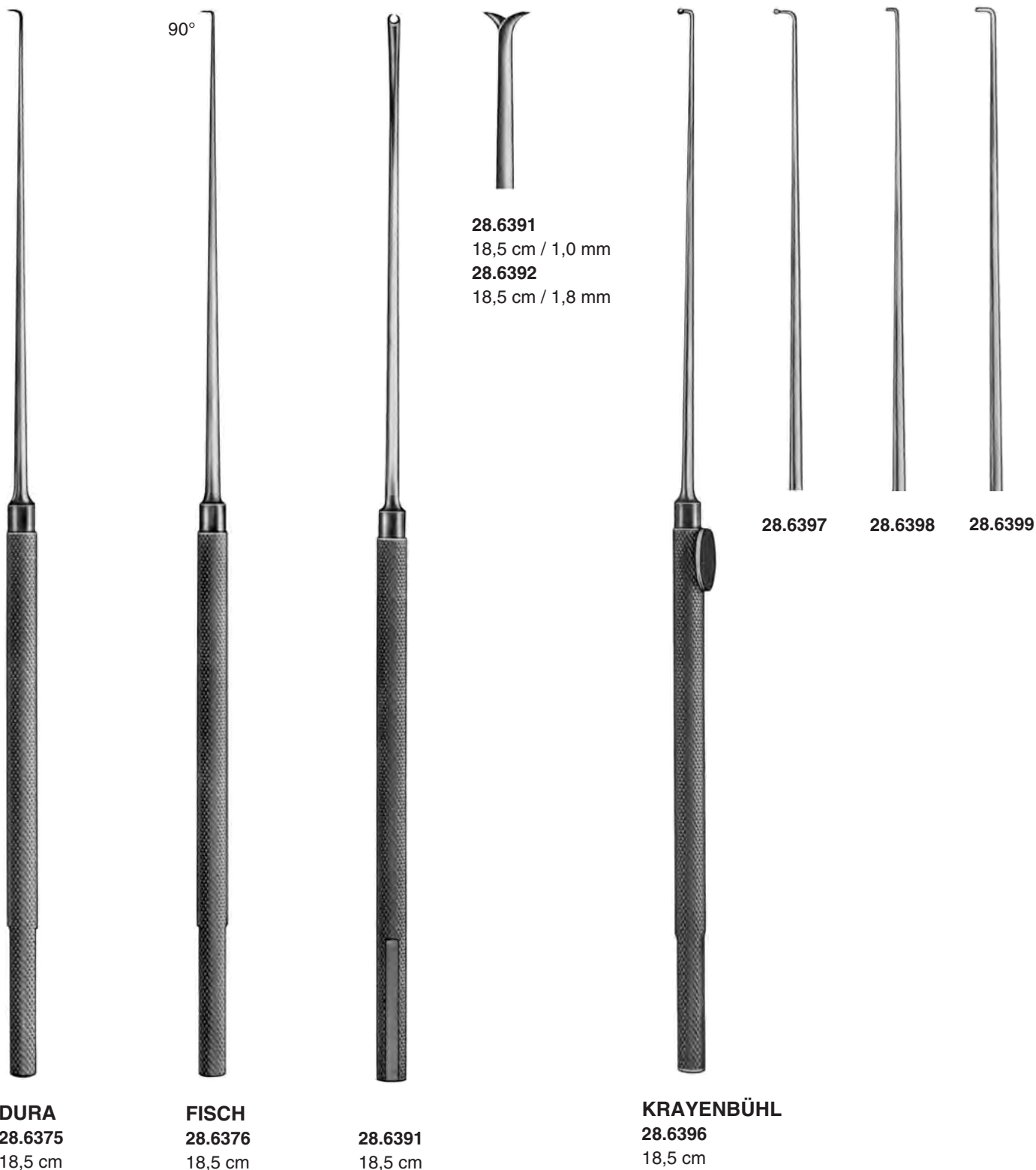



STANDARD
 PERMANENT
 TITANIUM



STANDARD
 PERMANENT
 IMPLANT STEEL



STANDARD
 TEMPORARY
 TITANIUM



STANDARD
 TEMPORARY
 IMPLANT STEEL

Schließkraft / Closing Force / Force de fermeture / fuerza de compresión

	permanent TITANIUM	permanent IMPL. STEEL	temporary TITANIUM	temporary IMPL. STEEL
	27.8740T 150 g	27.8750T 180 g	27.8240T 110 g	27.8240 110 g
	27.8750T 180 g	27.8760T 180 g	27.8250T 90 g	27.8250 90 g
	27.8760T 180 g	27.8780T 200 g	27.8260T 90 g	27.8260 90 g
	27.8780T 200 g	27.8792T 200 g	27.8280T 90 g	27.8280 90 g
	27.8792T 200 g	27.8790T 200 g	27.8292T 90 g	27.8292 90 g
	27.8790T 200 g		27.8290T 110 g	27.8290 110 g

STANDARD	6,2 mm	7,0 mm	7,8 mm	9,2 mm	10,6 mm	11,4 mm
Öffnung/opening Quverture / apertura						

27.8840T 200 g	27.8742T 150 g	27.8752T 180 g	27.8762T 180 g	27.8782T 200 g	27.8895T 200 g	27.8744T 150 g
27.8840 200 g	27.8742 150 g	27.8752 180 g	27.8762 180 g	27.8782 200 g	27.8895 200 g	27.8744 150 g
27.8340T 110 g	27.8242T 110 g	27.8252T 90 g	27.8262T 90 g	27.8282T 110 g	27.8395T 90 g	27.8244T 110 g
27.8340 110 g	27.8242 110 g	27.8252 90 g	27.8262 90 g	27.8282 110 g	27.8395 90 g	27.8244 110 g

13,3 mm	6,0 mm	6,8 mm	7,5 mm	8,7 mm	11,0 mm	5,5 mm

27.8754T 180 g	27.8764T 180 g	27.8784T 200 g	27.8896T 200 g	27.8823T 180 g	27.8824T 180 g	27.8825T 180 g
27.8754 180 g	27.8764 180 g	27.8784 200 g	27.8896 200 g	27.8823 180 g	27.8824 180 g	27.8825 180 g
27.8254T 110 g	27.8264T 110 g	27.8284T 110 g	27.8396T 90 g	27.8323T 110 g	27.8324T 110 g	27.8325T 110 g
27.8254 110 g	27.8264 110 g	27.8284 110 g	27.8396 90 g	27.8323 110 g	27.8324 110 g	27.8325 110 g

6,1 mm	6,5 mm	7,4 mm	9,9 mm	5,4 mm	5,8 mm	6,2 mm



**STANDARD
 PERMANENT
 TITANIUM**



**STANDARD
 PERMANENT
 IMPLANT STEEL**



**STANDARD
 TEMPORARY
 TITANIUM**



**STANDARD
 TEMPORARY
 IMPLANT STEEL**

Schließkraft / Closing Force / Force de fermeture / fuerza de compresión

	permanent TITANIUM	permanent IMPL. STEEL	temporary TITANIUM	temporary IMPL. STEEL
	27.8748T 200 g	27.8758T 200 g	27.8759T 200 g	27.8797T 180 g
	27.8748 200 g	27.8758 200 g	27.8759 200 g	27.8797 180 g
	27.8248T 90 g	27.8258T 90 g	27.8259T 90 g	27.8297T 90 g
	27.8248 90 g	27.8258 90 g	27.8259 90 g	27.8297 90 g
STANDARD				
Öffnung/opening Ouverture / apertura	7,9 mm	8,7 mm	10,2 mm	11,9 mm

	27.8613T 200 g	27.8623T 200 g	27.8763T 200 g	27.8819T 200 g	27.8820T 200 g	27.8822T 200 g	27.8850T 200 g
	27.8613 200 g	27.8623 200 g	27.8763 200 g	27.8819 200 g	27.8820 200 g	27.8822 200 g	27.8850 200 g
	27.8113T 110 g	27.8123T 110 g	27.8263T 110 g	27.8319T 130 g	27.8320T 130 g	27.8322T 130 g	27.8350T 130 g
	27.8113 110 g	27.8123 110 g	27.8263 110 g	27.8319 130 g	27.8320 130 g	27.8322 130 g	27.8350 130 g
	6,5 mm	7,8 mm	8,4 mm	5,6 mm	5,6 mm	5,6 mm	5,4 mm

	27.8851T 200 g	27.8830T 200 g	27.8832T 200 g	27.8833T 200 g	27.8746T 200 g	27.8761T 200 g	27.8747T 200 g
	27.8851 200 g	27.8830 200 g	27.8832 200 g	27.8833 200 g	27.8746 200 g	27.8761 200 g	27.8747 200 g
	27.8351T 130 g	27.8330T 90 g	27.8332T 90 g	27.8333T 90 g	27.8246T 90 g	27.8261T 90 g	27.8247T 90 g
	27.8351 130 g	27.8330 90 g	27.8332 90 g	27.8333 90 g	27.8246 90 g	27.8261 90 g	27.8247 90 g
	5,6 mm	7,2 mm	7,2 mm	8,2 mm	5,7 mm	8,0 mm	6,2 mm



**STANDARD
 PERMANENT
 TITANIUM**



**STANDARD
 PERMANENT
 IMPLANT STEEL**



**STANDARD
 TEMPORARY
 TITANIUM**



**STANDARD
 TEMPORARY
 IMPLANT STEEL**

Schließkraft / Closing Force / Force de fermeture / fuerza de compresión

	permanent TITANIUM	permanent IMPL. STEEL	temporary TITANIUM	temporary IMPL. STEEL	
	27.8897T 200 g	27.8770T 200 g	27.8270T 90 g	27.8270 90 g	
	27.8897 200 g	27.8770 200 g	27.8271T 90 g	27.8271 90 g	
	27.8397T 90 g	27.8270T 90 g	27.8271T 90 g	27.8271 90 g	
	27.8397 90 g	27.8270 90 g	27.8271 90 g	27.8271 90 g	
	27.8772T 200 g	27.8772T 200 g	27.8272T 90 g	27.8272 90 g	
	27.8773T 180 g	27.8773T 180 g	27.8273T 90 g	27.8273 90 g	
STANDARD					
Öffnung/opening Quverture / apertura	7,5 mm	8,0 mm	8,0 mm	8,0 mm	6,5 mm

	27.8597T 150 g	27.8598T 150 g	27.8599T 150 g	27.8600T 150 g	27.8610T 150 g	27.8620T 180 g
	27.8597 150 g	27.8598 150 g	27.8599 150 g	27.8600 150 g	27.8610 150 g	27.8620 180 g
	27.8097T 110 g	27.8098T 110 g	27.8099T 110 g	27.8100T 110 g	27.8110T 110 g	27.8120T 90 g
	27.8097 110 g	27.8098 110 g	27.8099 110 g	27.8100 110 g	27.8110 110 g	27.8120 90 g
	7,4 mm	7,4 mm	7,4 mm	7,4 mm	8,4 mm	9,6 mm

	27.8602T 150 g	27.8612T 150 g	27.8622T 180 g	27.8604T 200 g	27.8614T 200 g	27.8624T 180 g
	27.8602 150 g	27.8612 150 g	27.8622 180 g	27.8604 200 g	27.8614 200 g	27.8624 180 g
	27.8102T 110 g	27.8112T 110 g	27.8122T 110 g	27.8104T 110 g	27.8114T 110 g	27.8124T 110 g
	27.8102 110 g	27.8112 110 g	27.8122 110 g	27.8104 110 g	27.8114 110 g	27.8124 110 g
	5,8 mm	6,5 mm	7,2 mm	4,9 mm	4,9 mm	4,9 mm



**STANDARD
 PERMANENT
 TITANIUM**



**STANDARD
 PERMANENT
 IMPLANT STEEL**



**STANDARD
 TEMPORARY
 TITANIUM**



**STANDARD
 TEMPORARY
 IMPLANT STEEL**

Schließkraft / Closing Force / Force de fermeture / fuerza de compresión

permanent TITANIUM	27.8637T 150 g	27.8638T 150 g	27.8639T 150 g	27.8640T 150 g	27.8650T 150 g	27.8660T 180 g
permanent IMPL. STEEL	27.8637 150 g	27.8638 150 g	27.8639 150 g	27.8640 150 g	27.8650 150 g	27.8660 180 g
temporary TITANIUM	27.8137T 110 g	27.8138T 110 g	27.8139T 110 g	27.8140T 110 g	27.8150T 100 g	27.8160T 90 g
temporary IMPL. STEEL	27.8137 110 g	27.8138 110 g	27.8139 110 g	27.8140 110 g	27.8150 100 g	27.8160 90 g
STANDARD						
	Öffnung/opening Quverture / apertura	7,4 mm	7,4 mm	7,4 mm	7,9 mm	9,1 mm

27.8642T 150 g	27.8652T 150 g	27.8662T 180 g	27.8644T 150 g	27.8654T 150 g	27.8664T 180 g	27.8648T 150 g
27.8642 150 g	27.8652 150 g	27.8662 180 g	27.8644 150 g	27.8654 150 g	27.8664 180 g	27.8648 150 g
27.8142T 110 g	27.8152T 110 g	27.8162T 110 g	27.8144T 110 g	27.8154T 110 g	27.8164T 90 g	27.8148T 90 g
27.8142 110 g	27.8152 110 g	27.8162 110 g	27.8144 110 g	27.8154 110 g	27.8164 90 g	27.8148 90 g
6,5 mm	7,2 mm	7,8 mm	5,5 mm	5,5 mm	5,5 mm	7,9 mm

27.8658T 150 g	27.8668T 180 g
27.8658 150 g	27.8668 180 g
27.8158T 90 g	27.8168T 90 g
27.8158 90 g	27.8168 90 g
8,8 mm	10,0 mm



STANDARD
PERMANENT
TITANIUM



STANDARD
PERMANENT
IMPLANT STEEL



STANDARD
TEMPORARY
TITANIUM



STANDARD
TEMPORARY
IMPLANT STEEL

Schließkraft / Closing Force / Force de fermeture / fuerza de compresión

permanent TITANIUM	27.8774T 150 g	27.8775T 150 g	27.8776T 150 g	27.8777T 150 g	27.8778T 150 g	27.8779T 150 g
permanent IMPL. STEEL	27.8774 150 g	27.8775 150 g	27.8776 150 g	27.8777 150 g	27.8778 150 g	27.8779 150 g
temporary TITANIUM	27.8274T 110 g	27.8275T 110 g	27.8276T 110 g	27.8277T 110 g	27.8278T 110 g	27.8279T 110 g
temporary IMPL. STEEL	27.8274 110 g	27.8275 110 g	27.8276 110 g	27.8277 110 g	27.8278 110 g	27.8279 110 g
STANDARD						
	5,8 mm	5,8 mm	5,8 mm	5,8 mm	5,8 mm	5,8 mm
Offnung/opening Quverture / apertura						

27.8881T 150 g	27.8882T 150 g	27.8883T 150 g	27.8886T 150 g	27.8887T 150 g	27.8888T 150 g	27.8889T 150 g
27.8881 150 g	27.8882 150 g	27.8883 150 g	27.8886 150 g	27.8887 150 g	27.8888 150 g	27.8889 150 g
27.8381T 110 g	27.8382T 110 g	27.8383T 110 g	27.8386T 110 g	27.8387T 110 g	27.8388T 110 g	27.8389T 110 g
27.8381 110 g	27.8382 110 g	27.8383 110 g	27.8386 110 g	27.8387 110 g	27.8388 110 g	27.8389 110 g
7,0 mm	7,8 mm	8,8 mm	5,8 mm	6,2 mm	5,8 mm	6,2 mm

27.8891T 150 g	27.8892T 150 g	27.8893T 150 g	27.8894T 150 g
27.8891 150 g	27.8892 150 g	27.8893 150 g	27.8894 150 g
27.8391T 110 g	27.8392T 110 g	27.8393T 110 g	27.8394T 110 g
27.8391 110 g	27.8392 110 g	27.8393 110 g	27.8394 110 g
5,6 mm	5,6 mm	5,6 mm	5,6 mm



**MINI
 PERMANENT
 TITANIUM**



**MINI
 PERMANENT
 IMPLANT STEEL**



**MINI
 TEMPORARY
 TITANIUM**



**MINI
 TEMPORARY
 IMPLANT STEEL**

Schließkraft / Closing Force / Force de fermeture / fuerza de compresión

permanent TITANIUM	27.8680T 110 g	27.8690T 110 g	27.8700T 110 g	27.8710T 110 g	27.8720T 110 g	27.8682T 110 g
permanent IMPL. STEEL	27.8680 110 g	27.8690 110 g	27.8700 110 g	27.8710 110 g	27.8720 110 g	27.8682 110 g
temporary TITANIUM	27.8180T 90 g	27.8190T 70 g	27.8200T 90 g	27.8210T 70 g	27.8220T 70 g	27.8182T 90 g
temporary IMPL. STEEL	27.8180 90 g	27.8190 70 g	27.8200 90 g	27.8210 70 g	27.8220 70 g	27.8182 90 g
MINI						
Offnung/opening Quertura / apertura	3,3 mm	4,0 mm	3,3 mm	4,0 mm	4,6 mm	3,2 mm

27.8692T 110 g	27.8711T 110 g	27.8712T 110 g	27.8713T 110 g	27.8726T 110 g	27.8722T 110 g	27.8694T 110 g
27.8692 110 g	27.8711 110 g	27.8712 110 g	27.8713 110 g	27.8726 110 g	27.8722 110 g	27.8694 110 g
27.8192T 70 g	27.8211T 80 g	27.8212T 70 g	27.8213T 80 g	27.8226T 70 g	27.8222T 70 g	27.8194T 80 g
27.8192 70 g	27.8211 80 g	27.8212 70 g	27.8213 80 g	27.8226 70 g	27.8222 70 g	27.8194 80 g
3,8 mm	3,6 mm	3,8 mm	3,6 mm	4,0 mm	4,4 mm	3,6 mm

27.8714T 110 g	27.8724T 110 g	27.8716T 130 g	27.8717T 130 g	27.8727T 130 g	27.8728T 130 g	27.8806T 130 g
27.8714 110 g	27.8724 110 g	27.8716 130 g	27.8717 130 g	27.8727 130 g	27.8728 130 g	27.8806 130 g
27.8214T 80 g	27.8224T 70 g	27.8216T 70 g	27.8217T 70 g	27.8227T 70 g	27.8228T 70 g	27.8306T 70 g
27.8214 80 g	27.8224 70 g	27.8216 70 g	27.8217 70 g	27.8227 70 g	27.8228 70 g	27.8306 70 g
3,5 mm	4,0 mm	3,5 mm	6,0 mm	7,0 mm	5,7 mm	4,0 mm



**MINI
 PERMANENT
 TITANIUM**



**MINI
 PERMANENT
 IMPLANT STEEL**



**MINI
 TEMPORARY
 TITANIUM**



**MINI
 TEMPORARY
 IMPLANT STEEL**

Schließkraft / Closing Force / Force de fermeture / fuerza de compresión

permanent TITANIUM	27.8807T	130 g
permanent IMPL. STEEL	27.8807	130 g
temporary TITANIUM	27.8307T	70 g
temporary IMPL. STEEL	27.8307	70 g
MINI		
Öffnung/opening Quverture / apertura	4,0 mm	

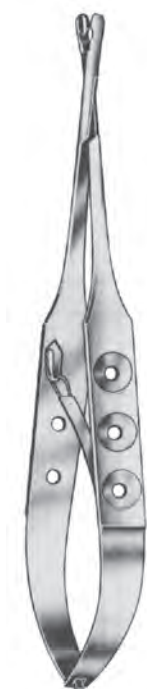

18 cm

	YASARGIL-MINI	YASARGIL-STANDARD
nicht drehbar non rotating non-pivotant non tornante	27.8548	27.8551
drehbar rotating pivotant tornante	27.8552	27.8553

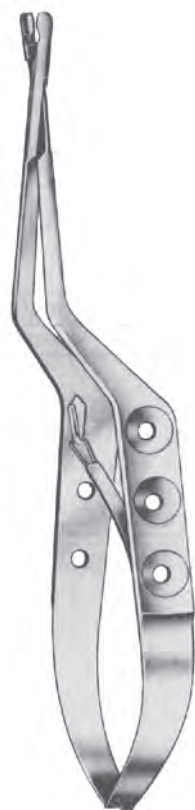

	YASARGIL-MINI		YASARGIL-STANDARD
nicht drehbar non rotating non-pivotant non tornante	27.8560	17 cm	27.8570
	27.8562	21 cm	27.8572
	27.8564	23 cm	27.8574
drehbar rotating pivotant tornante	27.8561	17 cm	27.8571
	27.8563	21 cm	27.8573
	27.8565	23 cm	27.8575

TITANIUM

nicht drehbar
 non rotating
 non-pivotant
 non tornante

drehbar
 rotating
 pivotant
 tornante

Für STANDARD Clips
 for STANDARD Clips
 pour Clips "STANDARD"
 para clips "STANDARD"



YASARGIL-STANDARD

19 cm
 21 cm
 23 cm

27.8001T
27.8002T
27.8003T

nicht abwinkelbar
 without articulation
 sans articulation
 sin articulación

27.8004T
27.8005T
27.8006T

19 cm
 21 cm
 23 cm

27.8011T
27.8012T
27.8013T

abwinkelbar
 with articulation
 avec articulation
 con articulación

27.8014T
27.8015T
27.8016T

Für MINI-Clips
 for MINI-Clips
 pour Clips "MINI"
 para clips "MINI"

19 cm
 21 cm
 23 cm

27.8021T
27.8022T
27.8023T

YASARGIL-MINI

nicht abwinkelbar
 without articulation
 sans articulation
 sin articulación

27.8024T
27.8025T
27.8026T

19 cm
 21 cm
 23 cm

27.8031T
27.8032T
27.8033T

abwinkelbar
 with articulation
 avec articulation
 con articulación

27.8034T
27.8035T
27.8036T



TITANIUM

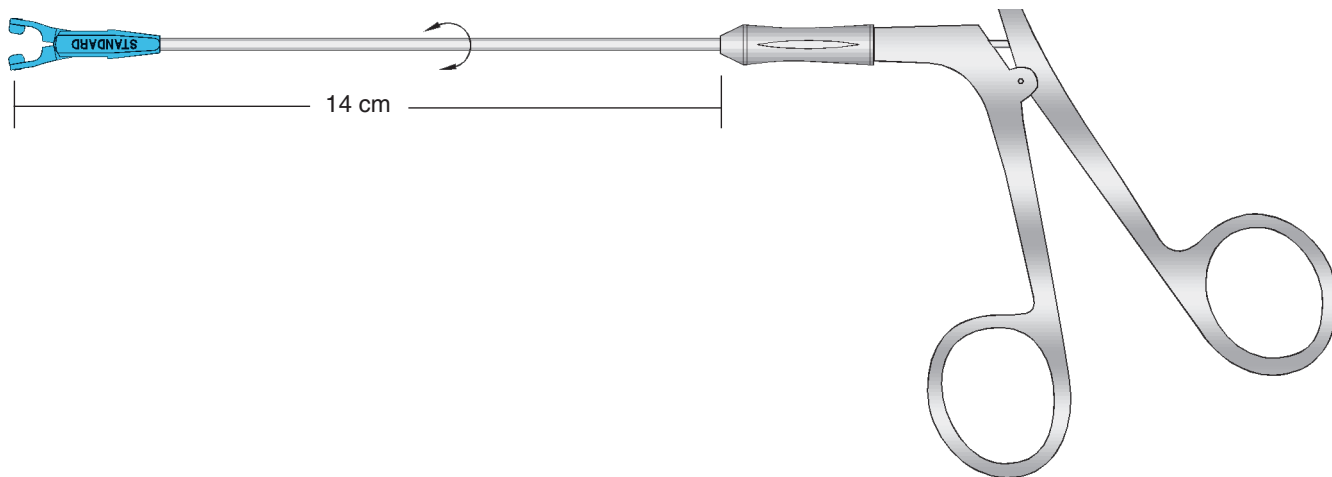

nicht drehbar
 non rotating
 non-pivotant
 non tornante

drehbar
 rotating
 pivotant
 tornante



YASARGIL-MINI

10 cm
 12 cm
 14 cm
 16 cm

27.8430T
27.8432T
27.8434T
27.8436T

27.8431T
27.8433T
27.8435T
27.8437T

YASARGIL-STANDARD

10 cm
 12 cm
 14 cm
 16 cm

27.8440T
27.8442T
27.8444T
27.8446T

27.8441T
27.8443T
27.8445T
27.8447T

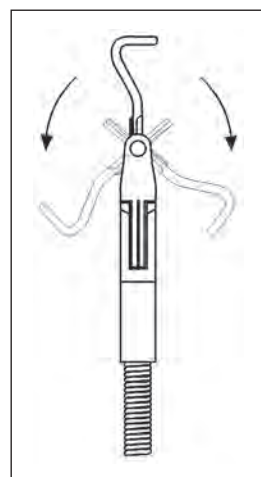

drehbar
 rotating
 pivotant
 tornante

TITANIUM

nicht drehbar
 non rotating
 non-pivotant
 non tornante



YASARGIL-MINI

10 cm
 12 cm
 14 cm

27.8400T
 27.8402T
 27.8404T

drehbar
 rotating
 pivotant
 tornante



27.8401T
 27.8403T
 27.8405T

YASARGIL-STANDARD

10 cm
 12 cm
 14 cm

27.8410T
 27.8412T
 27.8414T

27.8411T
 27.8413T
 27.8415T

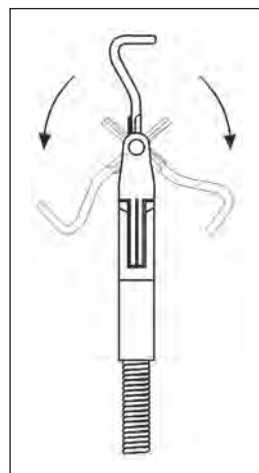

drehbar
 rotating
 pivotant
 tornante

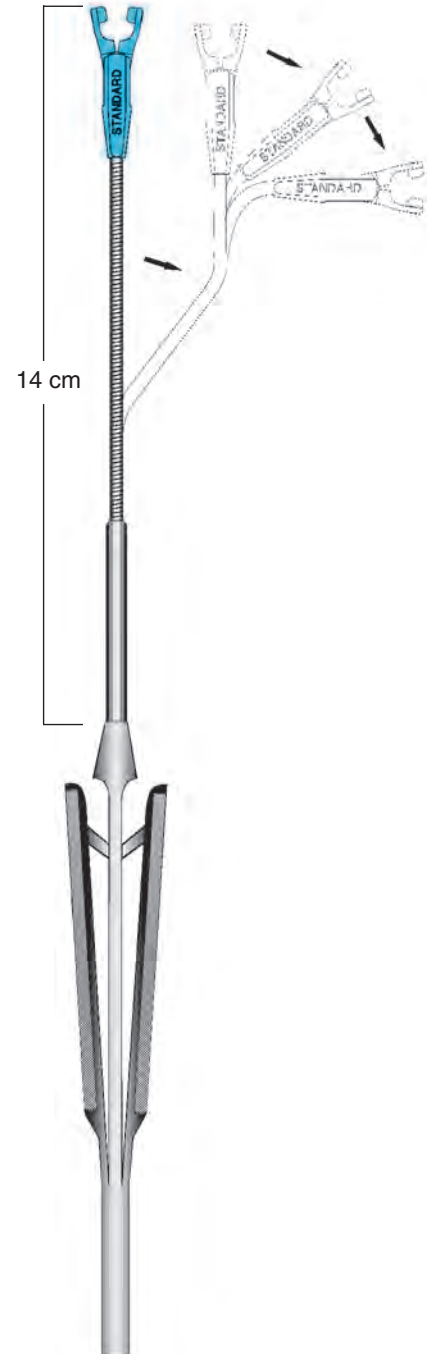

TITANIUM

nicht drehbar
 non rotating
 non-pivotant
 non tornante

drehbar
 rotating
 pivotant
 tornante



YASARGIL-MINI



- 10 cm **27.8490T**
- 12 cm **27.8492T**
- 14 cm **27.8494T**

- 10 cm **27.8491T**
- 12 cm **27.8493T**
- 14 cm **27.8495T**

YASARGIL-STANDARD

- 10 cm **27.8500T**
- 12 cm **27.8502T**
- 14 cm **27.8504T**

- 10 cm **27.8501T**
- 12 cm **27.8503T**
- 14 cm **27.8505T**

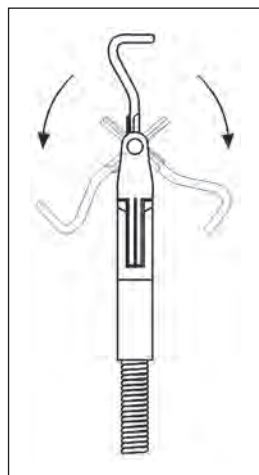
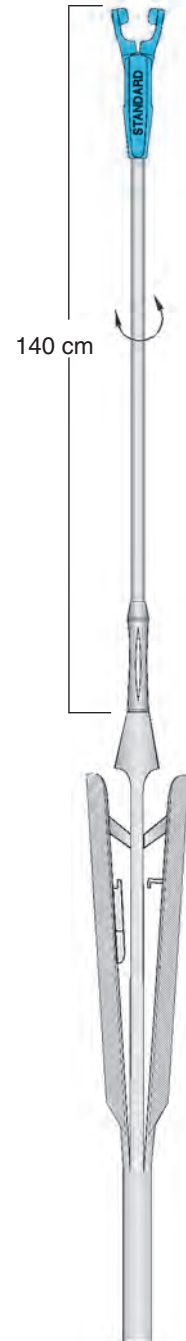

drehbar
 rotating
 pivotant
 tornante

27.8991

Kleines Clips-Set
Small Aneurysm-Clips Set
Boîte mineure de Clips pour Aneurysme
Caja menor de Clips para Aneurisma

bestehend aus / consisting of / composé de / compuesto de:

Kat.No./Cat.-No./ Ref. # / Núm.Ref.

1 x	27.8552	1 x	27.8744	
1 x	27.8572	1 x	27.8748	
1 x	27.8610	1 x	27.8750	
1 x	27.8613	1 x	27.8752	
1 x	27.8620	1 x	27.8754	
1 x	27.8622	1 x	27.8758	
1 x	27.8623	1 x	27.8760	
1 x	27.8640	1 x	27.8762	
1 x	27.8650	1 x	27.8764	
1 x	27.8710	1 x	27.8780	
1 x	27.8712	1 x	27.8782	
1 x	27.8714	1 x	27.8784	
1 x	27.8716	1 x	27.8806	
1 x	27.8720	1 x	27.8820	
1 x	27.8722	1 x	27.8552	Anlegezange / Applying Forceps
1 x	27.8724			Pince à appliquer / Pinza para poner
1 x	27.8728	1 x	27.8572	Anlegezange / Applying Forceps
1 x	27.8740			Pince à appliquer / Pinza para poner
1 x	27.8742	1 x	80.5001	CLIP Lager-u. Sterilisiertray
				Storage- and Sterilizing Container
				Boîte à stérilisation pour Clips
				Caja de esterilización des clips

27.8991T

Kleines Clips-Set TITAN
Small Aneurysm-Clips Set TITAN
Boîte mineure de Clips pour Aneurysme TITAN
Caja menor de Clips para Aneurisma TITAN

bestehend aus / consisting of / composé de / compuesto de:

Kat.No./Cat.-No./ Ref. # / Núm.Ref.

1 x	27.8610T	1 x	27.8754T	
1 x	27.8613T	1 x	27.8758T	
1 x	27.8620T	1 x	27.8760T	
1 x	27.8622T	1 x	27.8762T	
1 x	27.8623T	1 x	27.8763T	
1 x	27.8640T	1 x	27.8764T	
1 x	27.8650T	1 x	27.8780T	
1 x	27.8680T	1 x	27.8782T	
1 x	27.8710T	1 x	27.8784T	
1 x	27.8714T	1 x	27.8806T	
1 x	27.8716T	1 x	27.8820T	
1 x	27.8720T	1 x	27.8589T	
1 x	27.8722T	1 x	27.8577T	
1 x	27.8724T	1 x	27.8022T	Anlegezange / Applying Forceps
1 x	27.8728T			Pince à appliquer / Pinza para poner
1 x	27.8740T	1 x	27.8002T	Anlegezange / Applying Forceps
1 x	27.8742T			Pince à appliquer / Pinza para poner
1 x	27.8744T	1 x	80.5001	CLIP Lager-u. Sterilisiertray
1 x	27.8748T			Storage- and Sterilizing Container
1 x	27.8750T			Boîte à stérilisation pour Clips
1 x	27.8752T			Caja de esterilización des clips

27.8992

Großes Clips-Set
Large Aneurysm-Clips Set
Boîte majeure de Clips pour Aneurysme
Caja major de Clips para Aneurisma

bestehend aus / consisting of / composé de / compuesto de:

Kat.No./Cat.-No./ Ref. # / Núm.Ref.

2 x	27.8123	1 x	27.8722	
2 x	27.8242	1 x	27.8724	
2 x	27.8250	1 x	27.8728	
2 x	27.8252	1 x	27.8740	
2 x	27.8254	1 x	27.8742	
2 x	27.8260	1 x	27.8744	
2 x	27.8262	1 x	27.8748	
2 x	27.8282	1 x	27.8750	
2 x	27.8320	1 x	27.8752	
2 x	27.8387	1 x	27.8754	
1 x	27.8600	1 x	27.8758	
1 x	27.8602	1 x	27.8760	
1 x	27.8604	1 x	27.8762	
1 x	27.8610	1 x	27.8763	
2 x	27.8612	1 x	27.8764	
1 x	27.8613	1 x	27.8780	
1 x	27.8614	1 x	27.8782	
1 x	27.8620	1 x	27.8784	
1 x	27.8622	1 x	27.8806	
1 x	27.8623	1 x	27.8819	
1 x	27.8640	1 x	27.8820	
1 x	27.8650	1 x	27.8822	
1 x	27.8680	1 x	27.8552	Anlegezange / Applying Forceps
1 x	27.8690			Pince à appliquer / Pinza para poner
1 x	27.8692	1 x	27.8572	Anlegezange / Applying Forceps
1 x	27.8710			Pince à appliquer / Pinza para poner
1 x	27.8712	1 x	80.5002	CLIP Lager-u. Sterilisiertray
1 x	27.8714			Storage- and Sterilizing Container
1 x	27.8716			Boîte à stérilisation pour Clips
1 x	27.8720			Caja de esterilización des clips

27.8992T

Großes Clips-Set TITAN
Large Aneurysm-Clips Set TITAN
Boîte majeure de Clips pour Aneurysme TITAN
Caja major de Clips para Aneurisma TITAN

bestehend aus / consisting of / composé de / compuesto de:

Kat.No./Cat.-No./ Ref. # / Núm.Ref.

2 x	27.8123T	1 x	27.8720T	
2 x	27.8242T	1 x	27.8722T	
1 x	27.8250T	1 x	27.8724T	
2 x	27.8252T	1 x	27.8728T	
2 x	27.8254T	1 x	27.8740T	
2 x	27.8260T	1 x	27.8742T	
2 x	27.8262T	1 x	27.8744T	
2 x	27.8282T	1 x	27.8748T	
2 x	27.8320T	1 x	27.8750T	
2 x	27.8387T	1 x	27.8752T	
1 x	27.8593T	1 x	27.8754T	
1 x	27.8600T	1 x	27.8758T	
1 x	27.8602T	1 x	27.8760T	
1 x	27.8604T	1 x	27.8762T	
1 x	27.8610T	1 x	27.8763T	
2 x	27.8612T	1 x	27.8764T	
1 x	27.8613T	1 x	27.8780T	
1 x	27.8614T	1 x	27.8784T	
1 x	27.8620T	1 x	27.8806T	
1 x	27.8622T	1 x	27.8819T	
1 x	27.8623T	1 x	27.8820T	
1 x	27.8640T	1 x	27.8822T	
1 x	27.8650T	1 x	27.8002T	Anlegezange / Applying Forceps
1 x	27.8680T			Pince à appliquer / Pinza para poner
1 x	27.8690T	1 x	27.8026T	Anlegezange/ Applying Forceps
1 x	27.8692T			Pince à appliquer / Pinza para poner
1 x	27.8710T	1 x	80.5002	CLIP Lager-u. Sterilisiertray
1 x	27.8712T			Storage- and Sterilizing Container
1 x	27.8714T			Boîte à stérilisation pour Clips
1 x	27.8716T			Caja de esterilización des clips



80.5001

Lager- und Sterilisier-Container für 32 Clips, mit Deckel aus Kunststoff PPSU, dampfsterilisierbar bis 3 bar (143° C), 208x185x53 mm

Storage- and Sterilizing Container, plastic PPSU, sterilizeable up to 143°C/ 289°F, for 32 Clips, 208x185x53 mm

Boîte à stérilisation pour 32 Clips en plastique PPSU (stérilisable jusqu'à 143°C/289°F / 208x185x53 mm

Caja de esterilización de 32 Clips en plastica PPSU, esterilizable hasta 3 bar (143°C) / 208x185x53 mm

80.5002

Lager- und Sterilisier-Container für 54 Clips und Anlegezange, mit Deckel aus Kunststoff PPSU, dampfsterilisierbar bis 3 bar (143° C), 335x290x41 mm

Storage- and Sterilizing Container, plastic PPSU, sterilizeable up to 143°C/ 289°F, for 32 Clips and Applying Forceps, 335x290x41 mm

Boîte à stérilisation pour 32 Clips et pince à appliquer, en plastique PPSU, stérilisable jusqu'à 143°C/289°F / 335x290x41 mm

















Caja de esterilización de 32 Clips y pinza para poner en plastica PPSU, esterilizable hasta 3 bar (143°C) / 335x290x41 mm



Anlegepinzette für Mikro-Gefäßklemmen 40.9286 bis 40.9419
Applying forceps for micro vascular clamps 40.9286 to 40.9419
Pince à poser les micro-clamps vasculaires 40.9286 à 40.9419
Pinzas para aplicar micro-clamps vasculares 40.9286 a 40.9419

40.9071
mit Sperre
with ratchet
avec verrou
con cierre

40.9072
ohne Sperre
without ratchet
sans verrou
sin cierre



Gefäßgröße	Einzelklemmen (Paar)	Approximatoren ohne Rahmen, beweglich	Doppelklemmen mit Rahmen	Approximatoren mit Rahmen, beweglich
Vessel size	Single clamps (pair)	Approximators without frame, movable	Double clamps with frame	Approximators with frame, movable
Grandeur des vaisseaux	Clamps individuels (paire)	Approximateurs, sans cadre, mobiles	Clamps doubles avec cadre	Approximateurs, avec cadre, mobiles
Tamaño de vaso	Clamps individuales (par)	Aproximadores sin cuadro, móviles	Clamps dobles con cuadro	Aproximadores con cuadro, móviles
0,4-1,0 mm	 40.9396V 40.9397A	 40.9414V 40.9415A	 40.9402V 40.9403A	 40.9408V 40.9409A
0,6-1,5 mm	 40.9398V 40.9399A	 40.9416V 40.9417A	 40.9404V 40.9405A	 40.9410V 40.9411A
1,0-2,25 mm	 40.9400V 40.9401A	 40.9418V 40.9419A	 40.9406V 40.9407A	 40.9412V 40.9413A
1,5-3,5 mm	 40.9325V	 40.9326V		
2,0-5,0 mm	 40.9286V	 40.9287V		V= für Venen for veins pour des veines para venas A= für Arterien for arteries pour des artères para arterias



	Vergrößerung magnification grossissement aumento	Arbeitsabstand working distance distance de travail distancia de trabajo	Arbeitsfeld working field champ visuel campo de visión
28.7030 OCULUS Lupenbrille mit Stirnband OCULUS binocular loupe with headband OCULUS loupe binoculaire avec bandeau OCULUS lupa binocular con cinta	1,8X	370 mm	90 mm



	Vergrößerung magnification grossissement aumento	Arbeitsabstand working distance distance de travail distancia de trabajo	Arbeitsfeld working field champ visuel campo de visión
28.7050 OCULUS Lupenbrille mit Gestell OCULUS binocular loupe with frame OCULUS loupe binoculaire avec monture OCULUS lupa binocular con montura	1,8X	370 mm	90 mm

		Vergrößerung magnification grossissement aumento	Arbeitsabstand working distance distance de travail distancia de trabajo	Arbeitsfeld working field champ visuel campo de visión
 <p>28.7055 OCULUS Lupe allein OCULUS magnifying loupe only OCULUS loupe seule OCULUS lente de aumento suelte</p>		1,8X	370 mm	90 mm
 <p>28.7057 OCULUS Vorsatzobjektive 2,0X zur Montage an 1,8X OCULUS slip-on objectives to increase 1,8X to 2,0X OCULUS loupes additionesses de 1,8X à 2,0X OCULUS lentes adicionales de 1,8X a 2,0X</p>		2,0X	220 mm	50 mm
 <p>28.7058 OCULUS Vorsatzobjektive 2,5X zur Montage an 1,8X OCULUS slip-on objectives to increase 1,8X to 2,5X OCULUS loupes additionesses de 1,8X à 2,5X OCULUS lentes adicionales de 1,8X a 2,5X</p>		2,5X	180 mm	45 mm
<p>28.7059 OCULUS Etui alleine OCULUS case only OCULUS etui seule OCULUS estuche suelto</p>				

INHALTSVERZEICHNIS

A

AACHEN Hirnspateln	145
Absaugrohre	131-133
ACLAND Anlegepinzetten	261
ACLAND mod. Approximatoren	261
ACLAND mod. Doppelklemmen	261
ACLAND mod. Gefäßclips	261
ADSON anatonische Pinzetten	174
ADSON Dura-Schutzzange	111
ADSON Elevatoren	27,140
ADSON Hohlmeisselzangen	78
ADSON Hypophysen Pinzetten	174
ADSON Meißelraspator	140
ADSON Nervhäkchen	146
ADSON Raspatoren	140
ADSON Saugkanülen	131
ADSON Spiralbohrer	134
ADSON Unterbindungsnadel	140
ADSON Wundsperrer	18
ALEXANDER Flachmeißel	58
ALEXANDER Hohlmeißel	58
ALEXANDER Osteotome	58
Amputations-Retraktor	29
Amputationssägen	26
anatomische Pinzetten	174
Aneurysmen Clip Sets	259
Aneurysmen-Clips	247-253
Anlegepinzetten	261
Anlegezangen f. Silberklammern	175
Anlegezangen für YASARGIL Clips	254-258
ANVIL Nagelspaltzange	89
Approximatoren	261
Arachnoidea Messer	245
Arteriotomie-Scheren	210,213,216
AUFRANC-COBRA Knochenhebel	33

B

BACON Hohlmeisselzange	79
BADGLEY Laminektomiespreizer	155
Bandscheiben-Rongeur	170
Bandscheibenstanzen	173
BANE Hohlmeisselzange	78
BECKMANN-ADSON Wundsperrer	21
BECKMANN-EATON Wundsperrer	21
BECKMANN-WEITLANER Wundsperrer	20
BENNETT Knochenhebel	32
Bereitschafts-Box für Aneurysmen-Clips	260
BERGMANN Hammer	51
BEYER Hohlmeisselzangen	77,8
Biege- und Schränkinstrument für Platten	118
Biegehebel für Knochenplatten	118
Biegehebel für Marknägel	116
Biegezange für Platten	118
biegsame Spateln	145,201
BIEMER Gefäßspreizer	240
BIEMER Gefäßscheren	217
BIEMER Venenscheren	211
BIER Amputationssäge	26
BIRCHER Meniskotom	95
BIRCHER-GANSKE Meniskus- und Knorpelfaßzangen	93
Blattwechsel-Pinzette	181
Bleihände	88
BLOUNT Hüft- u. Knochenhebel	31
BLOUNT Knochenhebel/Kniewundhaken	16,92
BLUMENTHAL Hohlmeisselzangen	79
Blutstillungsmeißel	42
BÖHLER Extensionsbügel	108
BÖHLER Hohlmeisselzangen	80
BÖHLER Knochensplitterzangen	86
Bohrdrähte	106
Bohrdrahtspender	106

Seite

Bohrdrahtstützen	109
Bohrer	111,134,186
Bohrlehren	184,185
Bohrpfriem	112
Bolzenschneider	101
BRAND Sehnenfasszangen	90
BRUNS scharfe Löffel	45,47
BUCK-GRAMCKO Knochenhebel	29
BUCK-GRAMCKO Meissel	55
BUCKLEY Hohlmeissel	55
BUCKLEY Meissel	55
BUCY Chordotomie-Messer	140
BUNNELL Handbohrapparat	110
BUNNELL Sehnenabstreifer	91
BUSHE scharfe Löffel	48

C

CARROLL Sehnenfasszange	90
CASPAR Bohrer	186
CASPAR Bohrlehren	184,185
CASPAR Cervicalsperrer	180
CASPAR Distractionsschrauben	186
CASPAR Elevatorien	182
CASPAR Explorations-u.Koagulationshäkchen	182
CASPAR Gegensperrer	179,183,184
CASPAR Hakenvalven	178
CASPAR Halte/Einschlaginstrument	187
CASPAR Knochenmarkschneider	187
CASPAR Laminektomie Zangen	171
CASPAR Längsband-Dissektoren	186
CASPAR Mikro-Dissektoren	242,243
CASPAR Pinzette zum Blattwechsel	181
CASPAR Raspatorium	182
CASPAR Schraubendreher	186
CASPAR Spekula	177,183
CASPAR Sperrer (Spekulum)	178-180
CASPAR Spreizer	177
CASPAR Stössel	187
CASPAR Valve LATERAL	180,181
CASPAR Valve MEDIAL	180,181
CASPAR Valven	177-181
CASPAR Valven (Gegensperrer)	183
CASPAR Wirbelkörper Distraktor	184,185
CASPAR Wundhaken	15,182
Cerclagedraht	96
Cervicalsperrer	180
CHARRIERE Amputations Sägen	26
Chordotomie-Messer	140
CICHERELLI Hohlmeisselzange	76
CLEVELAND Hohlmeisselzangen	79
CLEVELAND Knochensplitterzangen	85
Clip Sets, Aneurysmen	259
Clips, Aneurysmen	247-253
CLOWARD Durahäkchen	149
CLOWARD Valven	153
CLOWARD Wirbelkörperpreizer	153,158
CLOWARD Wundhaken	146
CLOWARD-HOEN Valven	154
CLOWARD-HOEN Wirbelkörperpreizer	154
COBB Elevatoren	28
COBB Hohlmeißel	64
COBB Raspatorien	39
COLCLOUGH Rongeur	164-166
COLLIN Hammer	51
CONE Schädelzangen	136
Corticalis-Schrauben	124,126
COTTLE Hammer	51
COTTLE-KAZANJIAN Knochensplitterzange	85
COX Finger- und Zehenspreizer	17,88
CRILE Nervhäkchen	146
CRUTCHFIELD Schädelhalter	135
CRUTCHFIELD Vorbohrer	135
CUSHING Dekompressionshaken	152
CUSHING Durahäkchen	149

Seite

	Seite		Seite
CUSHING Flachbohrer	134	ESMARCH Stauschlauch	25
CUSHING Hakchen mit Messer	149	Etui fur OCULUS Lupe	262
CUSHING Hirnspateln	144	Explorations-u.Koagulationshakchen	182
CUSHING Laminektomiezangen	169	Extensionsbugel	91,107,108
CUSHING Nervhaken	147	Extraktionshaken	113
CUSHING Venenhaken	148	Extraktionshammer	114
		Extraktionszangen fur Drahte	103
		Extraktor	113
D		F	
DAHLGREN Schadelzangen	136	Fadenfuhrer	237
DANDY Nervhaken	147	Fadengabel	240
DARLING Wundspreizer	23	FAHBUSCH Mikro-Schere	236
DAUBENSPECK scharfe Loffel	45	FARABEUF Knochenhalte-zangen	69
DAVIS Elevator	141	FARABEUF Raspatorien	35
DAVIS Nerv-Separator/Spatel	141	FARABEUF-COLLIN Raspatorien	36
DAVIS Spateln biegsam	145	FARABEUF-LAMBOTTE Knochenhalte-zange	70
DEBAKEY Mikropinzetten	201	Federhaken m. Bulldogklemme	176
DECKER Bandscheibenstanzen	173	Federschere	210
Dekompressionshaken	152	Feilen, Knochen-	40
DEMEL Drahtspanninstrument	96	FERGUSON Saugkanulen	133
DEMEL Drahtumfuhrungsnadeln	96	FERGUSON Knochenhalte-zangen	69
D'ERRICO Bohrer	134	FERRIS-SMITH-CUSHING Laminektomie-zangen	168
D'ERRICO Nervwurzelhaken	152	FERRIS-SMITH-KERRISON Rongeur	160-163,167,168
DEVILBIS Schadelzangen	136	FERRIS-SMITH-KERRISON Rongeur, zerlegbar	161
DIAMANT-Kopfschneider	98	Fertigschlager	113
DINGMAN Knochenhalte-zangen	69	Feststellzange fur Ausziehhammer	114
Dissektoren	142,143	Feststellzangen	104
Dissektoren, Langsband	186	Finger- und Zehenspreizer	17,88
Dissektoren, Mikro	242,243	Fingerknochen-Halte-zange	67
Dissektoren, Mikro	241,242	Fingerplatten	122
Distractionsklammer	75	Fingerring-sage	89
Distractions-schrauben	186	Fingerring-sagezange	89
DOCKHORN Wundhaken	15	FISCH Hakchen	246
Doppelfeile	41	FISCH Spulkanulen	131
Doppelklemmen	261	Fixierscheiben f. Bohrdrahte	107
Doppelloffel	43,44	Flachbohrer	134
Doppelraspel	41	Flachmeiel	56,58,59,63
Doppelsonde	240	Flachzangen	103
DOWNING Meniskotom	94	Flachzangen parallel	104
DOYEN Rippen-Raspatorien	37	FOMON Doppelfeile	41
Draht, Cerclage	96	FOMON Doppelraspel	41
Drahtbiegezangen	102	FOMON Knochenraspel	41
Drahtfuhrungsnadeln	97	FRAZIER Dura-Elevator	141
Drahtkneifzangen	100	FRAZIER Durahakchen	149
Drahtsagen	137	FRAZIER Punktionskanulen	131
Drahtsagen Hakengriffe	136	FRAZIER Saugkanulen	133
Drahtschneidzangen	99	FRIEDMANN Hohlmeisselzange	76
Drahtspanner	96,103	FRIEDMANN-MINI Hohlmeisselzange	76
Drahtspanner	96	FRYKHOLM Hohlmeisselzange	83
Drahtspanninstrument	96	Fuhrungsspiesse	112
Drahtspannzangen	102,103		
Drahtumfuhrungsnadeln	96	G	
Drahtzangen	98-105	GALT Trephinen	137
Dreibackenspannfutter	110	Gefassclips	247-253,261
Drittelrohrplatten	121	Gefassdilatatoren	239
Dura Separator	141	Gefassmesser	240,244,245
Dura-Dissektoren	143	Gefassscheren	217
Dura-Elevatoren	141	Gefassspreizer	240
Durahakchen	147,149,246	Gegensperrerr	179,183,184
Dura-Messer	144	GELPI Wundsperrerr	24
Dura-Schutz-zange	111	GELPI-BABY Wundsperrerr	23
Dura-Separatoren	141,149	GELPI-MINI Wundsperrerr	23
		GELPI-SELETZ Wundsperrerr	24
E		GERSTER Distractionsklammer	75
ECHLIN Hohlmeisselzangen	84	GERZOG Hammer	51
Ein- und Ausschlaginstrumente	116	Gewebekralle	246
Einsatze f. Hammerkopf	50	Gewindeschneider	127
Einzelbohrer	89	GIGLI Drahtsagen	137
Elevatoren	27,28,140,141,182	GIGLI Hakengriff fur Drahtsagen	136
Ersatzbacken fur SOFTGRIP-Hammer	54	GIGLI Schlaufengriff	136
Ersatzdorn fur Schadelhalter	135	GRAEFE Mikropinzetten	190
Ersatzsageblatter	26,89	GRAHAM Nervhaken	146
Ersatzschlussel	110	GREEN Wundhaken	15
Ersatzventile	159		
ESMARCH Staubinde	25		

	Seite		Seite
GREGORY Nadelhalter	227	Hypophysen Pinzetten	174
Griffe für Drahtsägen	136	Hypophysenzange	172
Griffstück für Gewindeschneider 9 cm	129		
H		I	
HAJEK Hammer	50	Implantationsgabel	241
HAKANSSON Hohlmeisselzange	77	INGE Lamina Spreizer	159
Häkchen	246	INGE-BABY Lamina Spreizer	158
Häkchen mit Messer	149	ISRAEL Wundhaken	11
Haken für Küntschernägel	113		
Haken, Extraktion	113	J	
Haken, gabelförmig	113	JACKSON-BURROWS Wundsperrerr	24
Haken, Knochen	8	JACOBSON Doppelsonde	240
Haken, Venen	148	JACOBSON Fadengabel	240
Hakengriffe für Drahtsägen	136	JACOBSON Federschere	210
Hakenvulven	178	JACOBSON Gefäßmesser	244
Halbrohrplatten	119	JACOBSON Knopfsonde	240
HALLE Dura-Messer	144	JACOBSON Mikro-Scheren	210
HALLE scharfe Löffel	46	JACOBSON Nadelhalter	226
Halswirbelextension	135	JACOBSON Schere mit Profilgriff	217
Halte/Einschlaginstrument	187	JACOBSON-ADSON Pinzetten	192
Haltezange für kleine Knochenplatten	67	JACOBSON-Mikro Pinzetten	192
Haltezangen für Fingerknochen	67	JANSEN Doppellöffel	44
Hämmer	50-54	JANSEN Hohlmeisselzangen	78
Hammer mit auswechselbaren Backen	51	JANSEN Raspatorien	36
HAMMER mit auswechselbaren Kunststoffbacken	50		
Handbohrapparate	109-110,134	K	
Handbohrapparate	134	Kapselschere	93
Handbohrgerät mit Schlüssel	110	Kegelfräser	134
Handgriff mit Schlüssel	110	KERN Knochenhaltezaugen	70
HARDY Dissektoren	241	KEY Raspatorien	28
HARDY Implantationsgabel	241	Kirk Hammer	52
HARDY Küretten	238	KIRMISSION Raspatorium	35
HARDY-FAHLBUSCH Dissektoren	241	KIRSCHNER Bohrdrähte	106
HARTMANN Hohlmeisselzangen	79	KIRSCHNER Extensionsügel	107
HARVEY Drahtschneidezange	99	KIRSCHNER Handbohrapparat	109
HARVEY-JACKSON Wundsperrerr	22	KIRSCHNER Schraubenschlüssel	107
Haut- und Gewebeschutzplatte	113	KIRSCHNER Spannschlüssel	107
HEATH Hammer	53	KIRSCHNER Zughaken	107
Hebel, Knochen-	27,29,31	Klammer-Anlegezaugen f. Silberklammern	175
HEIFETZ Hirnspateln	139,144	Klammerhalter	176
HEIFETZ Ringpinzetten	203	Klammerzange	175,176
HEIFETZ Tumorfasspinzetten	195	KLEINERT-KUTZ Sehnenfaßzange	90
HIBBS Flachmeißel	63	Kleinfragmentplatten	121,122
HIBBS Hohlmeißel	63	Klemmen, Sehnenflecht-	91
HIBBS Osteotome	63	Knienelenk-Wundhaken	16,92
HIBBS Valven	157	Knochenbiopsie-Instrumente	127
Hirnspateln	139,144-145	Knochenfeilen	40
Hirnspatel-Pinzetten	174	Knochenhaken	9,32
HOEN Dura Separator	141	Knochenhalteklammern	75
HOEN Nervhaken	146	Knochenhaltezaugen	67-74
HOEN neurochirurgische Pinzetten	174	Knochenhebel	27,29-22
HOEN Valven	154	Knochenhebel/Kniewundhaken	15,92
HOEN Wirbelkörperpreizer	154	Knochenmarkschneider	187
HOEN-MARTIN Elevatorien	140	Knochenplatten	119-121
Hohlmeißel	55-56,58,60-66	Knochenplatten-Biegehebel	118
Hohlmeissel, Spongiosa-	66	Knochenraspeln	41
Hohlmeisselzange	66-84,167	Knochensplitterzaugen	85-87
HOHMANN Knochenhebel	29,30	Knopfhäkchen	246
HOHMANN-ALDINGER Knochenhebel	31	Knopfsonden	240
HOHMANN-MINI Knochenhebel	29	Knorpelschere	93
HOKE Osteotom	57	Knorpelzange	93
HOLSCHER Nervwurzelhaken	151	Knüpfpinzetten	194-195,198-199
HORSLEY Dura-Separator	141	KOCHER Wundhaken	8,12,14
HOUSE Spülkanülen	131	KOCHER-LANGENBECK Wundhaken	11
HUDSON Handbohrapparat	134	KOERTE Wundhaken	10
HUDSON Kegelfräser	134	Komprimeter	25
HUDSON Kugelfräser	134	KÖNIG Knochen-Hebel	27
Hüft- u. Knochenhebel	31	KÖNIG Raspator	35
Hüftgelenkhaken	13	KOOS Gefäßmesser	244,245
HUNT Tumorfasspinzette	195	Kopf- und Seitenschneider	99
HYLIN Raspatorium	36	Kopfhautklammern	176
Hypophysektomie-Küretten	238	Kopflupen	262-263
Hypophysektomie-Löffelzängchen	235	Kopfschneider	98-100
		Koronarscheren	212

	Seite		Seite
Kramponzange	98	MARTEL Umföhrungsinstrumente	137
KRAUS Gefässmesser	245	MARTIN Knorpelschere	93
KRAYENBÜHL Knopfhäkchen	246	MARTIN Knorpelzange	93
KRAYENBÜHL Nervhäkchen	246	MARTINI Doppellöffel	43
Kugelfräser	134	MARTINI Scharfe Löffel	43
Kunststoffbacken für Mead Hammer	51	MATHIEU-STIL Drahtspannzange	102
KÜNTSCHER Extraktor	113	MAYFIELD Hohlmeisselzange	80
KÜNTSCHER Führungsspieße	112	MAYO-HABERISSER Drahtspannzangen	103
KÜNTSCHER Vorschläger	113	McINDOE Knochensplitterzange	86
KÜNTSCHER Vorschläger mit Schlitz	113	McKENZIE Bohrer	134
Küretten, Hypophysektomie-	238	McKENZIE Klammer-Anlegezangen f. Silberklammern	175
Küretten, Mikro	238	McKENZIE Klammerhalter	176
		McKENZIE Klammern Silber	176
L		McKENZIE Klammern Tantal	176
LAHEY Durahäkchen	149	MEAD Hammer mit auswechselbaren Backen	51
LAMBERT-LOWMAN Knochenhalteklammer	75	MEAD Hohlmeisselzangen	77
LAMBOTTE Knochenhaken	32	Mehrfragmentplatten	122
LAMBOTTE Knochenhaltezangen	72	Meissel	55,56,56,59,61,63,,66
LAMBOTTE Osteotome	57	Meißelraspator	140
LAMBOTTE Raspatorien	36	Meniskotome	93-96
LAMBOTTE-MINI Osteotome	57	Meniskus- und Knorpelfaßzangen	93
Lamina Spreizer	158,159	Meniskushaken	16,92
Laminektomie Zangen	171	Meniskussmesser	93-96
Laminektomie-Sperrer	159	Messer, Chordotomie	140
Laminektomie-Spreizer	155,156	Messerhäkchen	149
Laminektomie-Zangen	160-173	MEYERDING Valven	157
Laminektomie-Zangen, zerlegbar	161	MEYERDING Wundhaken	16
LANDOLT Tumorfaßzange	172	MICHELE Trephinen	137
LANE Knochenhaltezangen	71	MIDDELDORPF Wundhaken	15
LANE Schraubendreher	128	MIKRO chirurgische Pinzetten	191
LANE Schraubenhaltezange	127	Mikro-Dissektoren	239,242,243
LANE-TRETHOWAN Knochenheber	33	MIKRO-FINO-Scheren	218
LANGENBECK Elevatoren	28	Mikro-Knüpfpinzetten	194-195,198-199
LANGENBECK Hüftgelenkhaken	13	Mikrolumbarzängchen	172
LANGENBECK Knochenhaltezange	67,70	Mikro-Nadelhalter	219,220,221,223,225,229-232
LANGENBECK Raspatorien	36	Mikro-Nadelhalter mit Profilgriff	233-234
LANGENBECK Stichsäge	26	Mikro-Nadelhalter PROMEDUR	223
LANGENBECK Wundhaken	13,14	Mikro-Nadelhalter TITAN	223,224,229-232
Längsband-Dissektoren	186	Mikro-Nadelhaltermit DIAMAND-Maul	227,229-232
LARSEN Sehnenfasspinzetten	90	Mikro-Pinzetten	190-194,196-204
LEKSELL-STILLE Hohlmeisselzangen	83	Mikro-Pinzetten mit Diamantbeschichtung	196
LEMPERT Hohlmeisselzangen	77	Mikro-Pinzetten mit Profilgriff	202-204
LEPINE Biegeinstrument	118	Mikro-Pinzetten, atraumatisch	201
LEWIN Knochenhaltezange	67	Mikro-Pinzetten, Titanium	190,197-201
LEXER Flachmeißel	59	Mikro-Raspatorien	239,240
LEXER Hohlmeißel	60,61	Mikro-Scheren	206-218,236
LEXER Osteotome	60,61	Mikro-Scheren mit Profilgriff	214-217
LEXER-MINI Hohlmeißel	60	Mikro-Scheren, Titanium	213
LEXER-MINI Osteotome	60	MIKRO-Zängchen	235
LEYLA Retraktor-System	138,139	MILLES I Mikroscheren	211,217
LISTON Knochensplitterzangen	85	MILLIGAN Dura-Dissektor	143
LITTAUER-LISTON Knochensplitterzangen	85	MILLIGAN Wundsperrer	19
Löffel, scharfe	45,47	Mini-Corticalis Schrauben	126
Löffel-Zängchen	235	MINI-HOHMANN Knochenheber	29
LOUTE Drahtspanner	96	MINI-Knochenplatten	121
LOVE Nervhaken	150	MINI-LEXER Hohlmeißel	60
LOVE-GRUENWALD Laminektomie-Zangen	169	MINI-LEXER Osteotome	60
LOWE-BRECK Meniskotom	94	MOLLISON Wundspreizer	19
LOWMAN Knochenhalteklammer	75	MOORE Bohrer-Satz	110
LOWMAN-HOGLUND Knochenhalteklammer	75	MOORE Handbohrapparat	110
LUCAE Hämmer	50	MURPHY Wundhaken	9
LUER Hohlmeisselzangen	76	MURPHY-LANE Luxationsheber	33
Luftpumpe mit Manometer	25		
Lupenbrillen	262-263	N	
Luxationsheber	33	Nadelhalter	219-234
		Nadelhalter mit Diamantbacken	227,228-232
M		Nadelhalter mit Profilgriff	233-234
Malleolarschrauben	124	Nadelhalter, Mikro	219-234
Manschetten für Komprimeter	25	Nadelhalter, PROMEDUR	223-224,226-227
Marknägel SMO	115	Nadelhalter, TITAN	229-231
Marknagel-Vorbohrer	116	NAGEL Mikro-Scheren	216
Markraumborher	114	Nagelausreisszange	89
MARKWALDER Rundmeisselzange	79	Nagelbohrer	89
MARQUARDT Hohlmeisselzangen	80	Nagelspaltschere	89

	Seite		Seite
NEFF Meniskotome	94	REILL Mikro-Nadelhalter	228
Nervhäkchen	146,246	REILL Repositionzange	67
Nervhaken	141,146,147,150	Reinigungsdraht für FRAZIER/FERGUSON	133
Nerv-Separator / Spatel	141	Reinigungsinstrument	42,129
Nervwurzelhaken	150-152	Repositionszangen	67,68,73
NICOLA Hypophysektomie-Küretten	238	RESANO Kapselschere	93
NICOLA Mikro-Scheren	236	RHOTON Knüpfpinzetten	197-198
NICOLA Mikro-Zängchenn	236	RHOTON Mikropinzetten	197
NICOLA Raspatorium	238	RHOTON Ringpinzetten	200
NORFOLK-NORWICH Wundsperrer	19	Ringpinzetten	200,203-204
O		Ringpinzetten mit Profilgriff	203-204
Oberschenkel-Vorbohrer	112	Rippen-Raspatorien	37,38
OCULUS Kopflupen	262-263	Rippenschere	87
OCULUS Lupenbrillen	262-263	RUBIO Drahtspannzange	102
OLDBERG Wundhaken	152	Rundmeisselzange	79
OLIVECRONA (GIGLI) Drahtsägen	137	RUSKIN Hohlmeisselzangen	81
OLIVECRONA Dissektoren	143	RUSKIN-LISTON Knochensplitterzangen	86
OLIVECRONA Hirnspateln	144	S	
OLIVECRONA Hohlmeisselzange	78	SACHS Dura-Dissektoren	143
OLIVECRONA-TOENNIS Klammerzange	175	SACHS Durahäkchen	147
OLLIER Wundhaken	10	SÄGEBLATT für Amputationssäge	26
OMBREDANNE Hammer	53	SÄGEBLATT für Fingerringsäge	89
Osteotom	55-58,60-63	Sägeblätter	26,89
P		SALENIUS Meniskotome	95
PARTSCH Flachmeißel	56	SAMII Ringpinzetten	204
PARTSCH Hammer	50	SATTERLEE Amputationssäge	26
PARTSCH Hohlmeißel	56	SAUERBRUCH Hohlmeisselzangen	84
PASSOW Blutstillungsmeißel	42	Saugkanülen	131-133
PEAPOD Laminektomiezüngchen	173	Saugrohre	132
PEARSON Hohlmeisselzange	76	Schlüssel f. Crutchfield	135
PENFIELD Dissektoren	142	SCALP-CONTOUR Wundsperrer	17
PERCY Amputations-Retraktor	26	Schädelhalter	135
PERKINS Wundspreizer	19	SCHÄDELHALTER für Halswirbelextension	135
PERTHES Reibahle	111	Schädelzangen	136
Phalangen-Hebel	27	scharfe Löffel	43-50,146,238
PHILLIPS Schraubendreher	128	SCHEDE scharfe Löffel	45
Pinzette zum Blattwechsel	181	Schere, Kapsel-	93
Pinzetten, atraumatisch	201	Schere, Knorpel	93
Pinzetten, Hirnspatel-	174	Schere, Nagelspalt-	146
Pinzetten, Knüpf-	194-195,198-199	Scheren, Arteriotomie-	210,213,216
Pinzetten, mikrochirurgisch	191	Scheren, -Koronar-	212
Pinzetten, mit Diamantbeschichtung	196	Scheren, Mikro-	206-218,236
Pinzetten, neurochirurgisch	174	SCHIEBLEHRE für Neurochirurgie	186
Pinzetten, Schraubenhalte-	129	Schlaufengriffe für Drahtsägen	136
Pinzetten, Sehnenfaß	90	SCHLESINGER Bandscheiben-Rongeur	170
Pinzetten, Titanium	190,197-201	Schlitzhammer	112
Pinzetten, Tumor- und Gewebefaß-	195,200,203-204	SCHNEIDER Raspator	36
Platten, Kleinfragment	121,122	SCHNEIDER-SAUERBRUCH Raspator	37
Plattenbiegezeugen	118	Schrauben, Corticalis-	124,126
PLESTER Wundsperrer	17	Schrauben, Corticalis-Mini	126
POTTS-YASARGIL Mikroschere	217	Schrauben, Knochen	124-129
Präparierscheren	214	Schrauben, Spongiosa-	125,126
Profilgriff-Mikroscheren	214-217	Schraubendreher	128,186
Profilgriff-Pinzetten	202-204	Schraubenhaltepinzette	129
Profilgriff-Ringpinzetten	203-204	Schraubenhaltezeuge	127
Punktionskanülen	131	Schraubenmessgeräte	129
PUTTI Knochenraspeln	41	Schraubenschlüssel	107
Q		SCHWARZ Extensionsbügel	91
QUERVAIN Elevator	28	SCOVILLE Haken	156
R		SCOVILLE Hemilaminektomie-Spreizer	156
RADOLF Nagelausreisszange	89	SCOVILLE Hirnspateln	145
RALK Handbohrapparat	110	SCOVILLE Hirnspatel-Pinzetten	174
RANEY Klammerzange	176	SCOVILLE Nervhaken	151
RANEY Kopfhautklammern	176	SCOVILLE Nervwurzelhaken	150
RANEY Rongeur	167	SCOVILLE scharfe Löffel	146
Raspatorien	28,35-38,140,182,238	SCOVILLE-HAVERFIELD Laminektomie-Spreizer	156
Raspatorien, Mikro-	238	SEBILEAU Elevator	27
Raspatorien, Rippen-	37	SEDILLOT Raspatorien	37
RAY Hypophysen-Küretten	237	Sehnenabstreifer	91
Reibahlen	111	Sehnenfasspinzetten	90
		Sehnenfasszangen	90
		Sehnenflechklemmen	91
		Seitenschneider	98

	Seite		Seite
SEMB Hohlmeisselzange	82	V	
SEMB Knochenhaltezangen	69	Valven	153,154,157,177-181
SEMB Rippenraspatorien	38	Valven, CLOWARD	153
Sequesterzangen	68	Valven, CLOWARD-HOEN	154
SETTER Repositionszangen	67	VAN BUREN Sequesterzange	68
SEWALL Raspatorium	35	VANNAS Mikroscheren	206,207,217
SIMON scharfe Löffel	46	Venenhaken	148
SMEDBERG Handbohrapparat	109	Venenscheren	217
SMILLIE Kniegelenk-Wundhaken	16,92	VERBRUGGE Knochenhaltezangen	73
SMILLIE Meniskusmeißel	94	VERBRUGGE-BABY Knochenhaltezange	73
SMILLIE Meniskussmesser	94	Viertelrohrplatten	121
SMITH-PETERSEN Hohlmeißel	62	VOLKMANN Doppel-Löffel	43
SMITH-PETERSEN Osteotome	62	VOLKMANN Knochenhaken	8
SMITH-PETERSEN Rongeur	81	VOLKMANN scharfe Löffel	44,49
SMITHWICK Anlegezangen	175	VOLKMANN Wundhaken	7,9
SMITHWICK Nervhaken	141,147	Vorböhrer	135
SOFTGRIP-Hämmer	54	Vorböhrer f. Marknägel	116
Spannschlüssel	107	Vorböhrer für Oberschenkel	112
Spateln	144,145,149,201	Vorböhrer für Schädelhalter	135
Spateln biegsam	145,201	Vorschläger	113
SPEARE Durahäkchen	149		
Spekula	177,183	W	
Sperrer (Spekulum)	178-180	WAGNER Raspatorien	38
Spinalhaken	146,157	WAGNER Hohlmeißel	65
Spiralbohrer	134	WALTON Phalangen-Hebel	27
Spitzmauszangen	105,114	Wangenhaken	14
Spitzmauszangen f. Ausziehhammer	114	WASSMUND Wundhaken	10
Spongiosa-Hohlmeissel	66	WEITLANER Wundsperrer	17,18
Spongiosa-Schrauben	125,126	WEITLANER-BABY Wundsperrer	17
SPRATT scharfe Löffel	43	WILLIAMS Microlumbarzängchen	172
Spreizer	131,177	WILLIGER Doppel-Löffel	44
Spülkanülen	131	WILLIGER Elevator	27
SPURLING Laminektomie-Zangen	169	WILLIGER Hammer	50
Stabhaltezange	117	WILLIGER Raspator	35
Staubbinde	25	WILLIGER scharfe Löffel	43
Stauschlauch	25	Winkelplatten	123
STEINMANN Nägel	108	Wirbelkörper Distraktor	184,185
STEINMANN Sehnenfasszange	90	Wirbelkörperpreizer	153,154,158
STELLBRINK Hohlmeisselzangen	77	WOODSON Dura-Separator	149
Stichsäge	26	WULLSTEIN Mikro-Absaugrohr	132
STILLE Flachmeißel	58	WULLSTEIN Mikro-Saugkanülen	132
STILLE Handbohrapparat	109	Wundhaken	7-16,92,146,152,182
STILLE Hohlmeißel	58	Wundhaken, Kniegelenk-	16,92
STILLE Hohlmeisselzangen	82	Wundsperrer	17-24
STILLE Osteotome	58		
STILLE-HORSLEY Knochensplitterzangen	87	Y	
STILLE-HORSLEY Rippenschere	87	YASARGIL Aneurysmen-Clips	247-253
STILLE-LISTON Knochensplitterzangen	86	YASARGIL Anlegezangen für Aneurysmenclips	254-258
STILLE-LUER Hohlmeisselzangen	82,82	YASARGIL Arachnoidea Messer	245
STILLE-RUSKIN Hohlmeisselzangen	81	YASARGIL Clips Bereitschafts-Box	260
STILLE-SHERMAN Handbohrapparat	109	YASARGIL Dissektoren	239
Stößel	42,187	YASARGIL Fadenführer	237
SWEET Anlegezangen	175	YASARGIL Federhaken m. Bulldogklemme	176
SYSTRUNK Nagelspaltschere	89	YASARGIL Hypophysenzange	172
		YASARGIL Mikro-Schere	217
T		YASARGIL Raspatorien	239
TAYLOR Spinalhaken	146,157	YASARGIL scharfe Löffel	238
TAYLOR Valven	157	YASARGIL Tumorzangen	195
TEMPLE-FAY Laminektomie-Spreizer	155	YASARGIL-MINI-Anlegezangen	255-258
THIESS Hammer	50		
TITAN-Mikropinzetten	191	Z	
TOENNIS Dissektoren	143	Zängchen, Hypophysektomie-	235
TOENNIS Durahäkchen	149	Zange, Knorpel-	93
Trephinen	137	ZAUFAL-JANSEN Hohlmeisselzange	80
Tumor- und Gewebefußpinzetten	195,200,203-204	Zehen- und Fingerspreizer	17,88
Tumorfaßzange	172	Zemententfernungszange	105
		zerlegbare Laminektomie-zangen	161
U		ZIEGLER Drahtschneidzangen	99
ULRICH Knochenhaltezangen	74	ZIELKE Hohlmeißel	61
Umführungsinstrumente	137	Zughaken	107
UNIVERSAL Kramponzange	98	ZUSATZLINSEN für Lupenbrillen	262
Unterbindungsnadel	140		
Unterlagscheiben	125,126		
USA Modell Scharfe Löffel	49		

ALPHABETICAL INDEX

A

AACHEN Brain Spatulas	145
Accessory lenses for binocular loupes	262
ACLAND Clip-Appling Forceps	261
ACLAND mod. Approximators	261
ACLAND mod. Twin-Clamps	261
ACLAND mod. Vessel Clamps	261
ADSON Aneurysme Needles	140
ADSON Bone Rongeurs	78
ADSON Dressing Forceps	174
ADSON Dura-Protecting Forceps	111
ADSON Hypophysectomy Forceps	174
ADSON Nerve Hooks	146
ADSON Periosteal Elevators	140
ADSON Retractors	18
ADSON Suction Tubes	131
ADSON Twist Drill	134
Air Pump with Manometer	25
ALDERDYCE Elevator	27
ALEXANDER Bone Chisels	58
ALEXANDER Gouges	58
ALEXANDER Osteotomes	58
Amputating Saws	26
Amputation Retractor	26
Aneurysm Clip-Sets	259
Aneurysme Needles	140
Angular Bone plates	123
ANVIL Nail Splitter	89
Applying Forceps for ACLAND Clips	261
Applying Forceps for YASARGIL Clips	254-258
Approximators	261
Arteriotomy-Scissors	210,213
AUFRANC Cobra Bonelevers	33
Automatic Wire Twisters	103
Awls, Reamer-	111

B

BACON Bone Rongeurs	79
BADGLEY Laminectomy Retractor	155
Bandages, Compression-	25
BANE Bone Rongeur	78
BECKMANN-ADSON Self-Retaining Retractors	21
BECKMANN-EATON Self-Retaining Retractors	21
BECKMANN-WEITLANER Self-Retaining Retractors	20
Bender for Intramedullary Pins	116
Bending Instruments	116,118
BENNET Bone Levers	32
BERGMANN Mallets	52
BEYER Bone Rongeurs	76,8
BIEMER Vein Scissors	211,217
BIEMER Vessel Scissors	217
BIEMER Vessel Spreader	240
BIER Amputating Saw	26
Binocular loupes	263-263
Biopsy Thephines	127
BIRCHER Meniscotome	95
BIRCHER-GANSKE Meniscus- and Cartilage Forceps	93
Blades	153-154
BLOUNT Bone Levers	31
BLOUNT Retractor for Knee	15,92
BLUMENTHAL Bone Rongeurs	79
BOEHLER Bone Cutting Forceps	86
BOEHLER Extension Bows	108
BOEHLER Rongeurs	80
Bone Biopsy Thephines	127
Bone Chisels	55,56,58-5961,63,66
Bone Clamps	75
Bone Curettes	43-50
Bone Cutting Forceps	85-87
Bone Drill with key	110
Bone Drills	109-111

Page

Bone Files	41-41
Bone Gouges	55,56,58-66
Bone Holding Forceps	67-75
Bone Hooks	9,32
Bone Lever	27,29,31-33
Bone Plate Wrench	118
Bone plates	119-123
Bone Rasps	149
Bone Rongeurs	76-85
Bone Screws	124-126
Bone Wire	96
Bonegraft Holder	187
Bonehooks	8,32
Bonelevers	33
Bows, Extension-	108
Brain Clips	176
Brain Retractors, self-retaining	138,139
Brain Spatulas	144-145
Brain-Spatula Forceps	174
BRAND Tendon-Seizing Forceps	90
BRUNS Bone Curettes	45,47
BUCK-GRAMCKO Bone Gouge	55
BUCK-GRAMCKO Bone Lever	29
BUCKLEY Bone Chisels	55
BUCKLEY Bone Gouges	55
BUCY Cordotomy Knives	140
BUNNELL Bone Drill	110
BUNNELL Tendon Passer	91
BUNNELL Tendon Strippers	91
BUSHE Bone Curettes	48
buttoned Hooks	246

C

Caliper for Neurosurgery	186
Cancellous Screws	126
Carriers, Ligature-	237
CARROLL Tendon-Seizing Forceps	90
Cartilage- and Meniscus Grasping Forceps.	93
Cartilage Forceps	93
Cartilage Scissors	93
Case for binocular loupes	262
CASPAR Blades	177,178,180,181,183
CASPAR Cervical Retractors	179-180
CASPAR Counter Retractors	179,183-184
CASPAR Distraction Screws	186
CASPAR Drill	186
CASPAR Drillguides	184,185
CASPAR Elevator	182
CASPAR Explorers	182
CASPAR Forceps for changing blade	181
CASPAR Graft Cutter	187
CASPAR Holder for bone grafts	187
CASPAR Laminectomy Retractors	177-181
CASPAR Laminectomy Rongeurs	171
CASPAR Micro Dissectors	242-243
CASPAR Raspatories	182
CASPAR Retractors	15,182
CASPAR Screwdriver	186
CASPAR Speculas	177,183
CASPAR Tampers	187
CASPAR Vertebral Body Dissectors	186
CASPAR Vertebral Body Distractors	184,185
Cement Removing Forceps	105
Cervical Retractors	179-180
Cervical traction tongs	135
CHARRIERE Amputating Saws	26
Chisels, Bone-	55,56,58-59,61,63,66
Chucks	110
CICHERELLI Bone Rongeur	76
Clamps, Bone-	75
CLEVELAND Bone Rongeurs	79
CLEVELAND Bonecutting Forceps	85
Clip Applying Forceps	175,254-258,261
Clip Racks	176

Page

	Page		Page
Clips, Aneurysm-	247-253	Dressing Forceps	174190,191
Clips, Brain-	176	Drillguides	184,185
Clips, Scalp	176	Drillpoints	135
CLOWARD Blades	153-154	Drills, Bone-	109-111,186
CLOWARD Dura Hook	149	Drills, Nail-	89
CLOWARD Lamina Spreaders	153,158	Drills, Twist-	111
CLOWARD Retractors	146,153	Drills, Wire	106
CLOWARD-HOEN Lamina Spreaders	154	DRIVER-EXTRACTOR	116
COBB Elevators	28	Dura Dissectors	143
COBB Raspatories	39	Dura Elevator	141
COBB Spinal Gouges	64	Dura Hooklet	246
COLCLOUGH Laminectomy Punches	164-166	Dura Hooks	146,149
COLLIN Mallet	51	Dura Separators	141
Compression Apparatus	25	Dura-Protecting Forceps	111
Compression Bandages	25		
Compression Plates	119	E	
COMPRIMETER Compression Apparatus	25	ECHLIN Bone Rongeurs	84
Conductors for Wire Saws	137	Elevator, Dura	141
CONE Skull Punches	136	Elevator-Dissector	141
Cordotomy Knives	140	Elevators	27-28,140,182
CORONARY Artery-Scissors	212	Elevators Bone-	28-28
Cortical Screws	124,126	Elevators, Neurosurgical-	140
COTTLE Mallet	51	Elevators, periosteal-	140
COTTLE-KAZANJIAN Bonecutting Forceps	85	End-Cutters	98-100
Counter Retractors	179,183-184	ESMARCH Compression Bandages	25
COX Finger- and Toe Retractor	17,88	Explorers	182
Cranial Rongeurs	134	Extension Bows	91,107,108
CRILE Nerve Hooks	146	Extraction Hammers	114
CRUTCHFIELD Drillpoints	135	Extraction Hooks	113
CRUTCHFIELD Traction Tongues	135	Extraction Pliers for wires	103
Cuffs for Comprimeter	25		
Curettes, Bone-	43-49	F	
Curettes, Disk-	146	FAHLBUSCH Micro-Scissors	236
Curettes, Pituitary-	238	FARABEUF Bone Holding Forceps	69
CUSHING Brain Spatulas	144	FARABEUF Raspatories	35
CUSHING Decompression Retractor	152	FARABEUF-COLLIN Raspatories	36
CUSHING Dura Hook-Knife	149	FARABEUF-LAMBOTTE Boneholding Forceps	70
CUSHING Dura Hooks	149	FERGUSON Suction Tubes	133
CUSHING Flat Trephine	134	FERGUSON Bone Holding Forceps	69
CUSHING Laminectomy Rongeurs	169	FERRIS-SMITH-CUSHING Laminectomy Punches	168
CUSHING Nerve Hooks	147,148	FERRIS-SMITH-KERRISON Laminectomy Punches	160-164,167
CUSHING Raspatories	39	Files, Bone-	40,41
Cutter, Graft-	187	Finger- and Toe Retractor	17,88
Cutters for wires	98-101,104,117	Finger Ring Saws	89
Cutters, Side- and End-	98	Fingerplates	122
		FISCH sharp Hook	246
D		FISCH Suction Tips	131
DAHLGREN Cranial Rongeur	136	Flat Nose Pliers	103
DANDY Nerve Hooks	147	FOMON Bone Files	41
DARLING Retractors	23	FOMON Bone Rasps	41
DAUBENSPECK Curettes	45	Forceps, Bone Cutting-	85-87
DAVIS Brain Spatulas	145	Forceps, Bone Holding-	67-74
DAVIS Elevator-Dissector	141	Forceps, Brain Spatula-	174
DAVIS Nerv-Separator	141	Forceps, Cartilage-	93
DEBAKEY-Micro Forceps	201	Forceps, Cement removing-	105
DECKER Rongeur	173	Forceps, Clip-Appling-	175,254-258,261
Decompression Retractor	152	Forceps, Dressing-	174
DEMEL Wire Guides	96	Forceps, Dura-proteting-	111
DEMEL Wire Tightening Forceps	96	Forceps, Hypophysectomy-	174
Depth Gauges	129	Forceps, Meniscus- and Cartilage-	93
D'ERRICO Nerve Root Retractor	152	Forceps, Micro-	190-204
D'ERRICO Perforator Drill	134	Forceps, Micro-, TITANIUM	190,197-111
DEVILBIS Cranial Rongeur	136	Forceps, Micro-; with DIAMOND Tips	197-200
DIAMOND End-Cutters	98	Forceps, Microlumbar-	172
Dilators, Vessel-	239	Forceps, Nail Extracting-	89
DINGMAN Bone Holding Forceps	69	Forceps, Repositioning-	67,68
Dismountable Laminectomy Punches	161	Forceps, Ring Tissue-	195,200,203-204
Dispensers, Wire-	106	Forceps, Rod Gripping	117
Dissecting-Scissors with profile handle	214-217	Forceps, screwholding-	127
Dissectors, Micro-	239-243	Forceps, Sequestrum-	68
Distraction Screws	186	Forceps, Suture-	194-195,198-199
DOCKHORN Retractors	15	Forceps, Tendon Interlacing-	91
DOWNING Menisctome	94	Forceps, Tendon-Seizing-	90
DOYEN Rib Raspatories	37	Forceps, Tumor-	195,200,203-204

	Page		Page
Forceps, Tumor- and Tissue-Grasping-	195,200,203-204	Hooks, Extraxtion-	113
Forceps, Tumor-Grasping-	172	Hooks, Nerv-	146-152
FRAZIER Dura Hooks	149	HORSLEY Dura Separator	141
FRAZIER Dural Elevator	141	HOUSE Suction Tips	131
FRAZIER Suction Tips	133	HUDSON Conical Burr	134
FRIEDMANN Bone Rongeur	76	HUDSON Hand Drill	134
FRIEDMANN-MINI Bone Rongeur	76	HUDSON Spherical Burrs	134
FRYKHOLM Bone Rongeur	83	HUNT Tumor Forceps	195
G		HYLIN Raspatories	36
GALT Trephines	137	Hypophysectomy Forceps	174
GELPI Retractors	24	I	
GELPI-BABY Retractors	23	Implant Fork	241
GELPI-MINI Retractors	23	INGE Lamina Spreaders	159
GELPI-SELETZ Retractors	24	INGE-BABY Lamina Spreader	158
GERSTER Traction Bar	75	Intramedullary Pins	115
GERZOG Hammer	51	ISRAEL Retractors	11
GIGLI (OLIVECRONA) Saw Wires	137	J	
GIGLI Handles for Wire Saw	136	JACKSON-BURROWS Retractor	24
Gimlets	127	JACOBSON buttoned Probes	240
Gouges, Bone-	55,56,58-66	JACOBSON Double Probe&Support	240
Gouges, Spinal-	64	JACOBSON Micro Forceps	192
Gouges, Spongiosa-	66	JACOBSON Micro Needleholders	226
GRAEFE Micro Forceps	190-191	JACOBSON Micro Scissors	210,217
GRAEFE Micro Forceps, TITANIUM	190	JACOBSON Suture Pusher	240
Graft Cutter	187	JACOBSON Vessel Knife	244
GRAHAM Nerve Hook	146	JACOBSON-ADSON Micro Forceps	192
GREEN Retractor	16	JANSEN Bone Rongeurs	78
GREGORY Needleholders	227	JANSEN Curettes	44
Guide Pins	112	JANSEN Raspatory	36
Guides, Wire-	96,97	K	
H		KERN Bone Holding Forceps	70
HAJEK Mallet	50	KEY Elevators	28
HAKANSSON Bone Rongeur	77	KIRK Hammer	52
HALLE Bone Curettes	46	KIRMISSION Raspatory	35
Hammers, Extraction-	114	KIRSCHNER Bone Drills	109
Hammers, orthopedic-	50-54	KIRSCHNER Extension Bows	107
Hammers, SOFTGRIP	54	KIRSCHNER Fixation Disks	107
Hand Drills	109-110,134	KIRSCHNER Traction Hooks	107
Handles with chuck	110	KIRSCHNER Wire Drills	106
HARDY Implant Fork	241	KIRSCHNER Wire Tightener	107
HARDY Micro Dissectors	241	KIRSCHNER Wrench	107
HARDY Pituitary Curettes	238	KLEINERT-KUTZ Tendon-Seizing Forceps	90
HARDY-FAHLBUSCH Micro-Dissectors	241	Knee Retractors	16,92
HARTMANN Bone Rongeur	79	Knives, Arachnoid-	245
HARVEY Wire-Cutter	99	Knives, Cordotomy-	140
HARVEY-JACKSON Retractor	22	Knives, Vessel-	244,245
HEATH Mallets	53	KOCHER Retractors	9,13,15
HEIFETZ Brain Spatulas	144	KOENIG Bone Elevators	27
HEIFETZ Ring Tissue Forceps	203	KOENIG Raspatory	35
HEIFETZ Tumor Forceps	195	KOERTE Retractors	10
Hemilaminectomy Spreaders	153-157	KOOS Vessel Knives	244,245
HEMOSTATS	42	KRAUS Vessel Knife	245
HIBBS Blades	157	KRAYENBÜHL buttoned Hooks	246
HIBBS Chisels	63	KRAYENBÜHL Nerve Hooks	246
HIBBS Gouges	63	KUENTSCHER Extractor	113
HIBBS Osteotomes	63	KUENTSCHER Guide Pins	112
Hip Retractors	13	KUENTSCHER Nail Drivers	113
HOEN Blades	154	KUENTSCHER Nail Impactor	113
HOEN Dura Separators	141	L	
HOEN Lamina Spreader	154	LAHEY Dura-Hook	149
HOEN Nerve Hook	146	LAMBERT-LOWMAN Bone Clamps	75
HOEN Neurosurgical Dressing forceps	174	LAMBOTTE Bone Holding Forceps	72
HOEN Neurosurgical Tissue Forceps	174	LAMBOTTE Bonehook	32
HOEN-MARTIN Elevators	140	LAMBOTTE Osteotomes	57
HOHMANN Bone Levers	29-30	LAMBOTTE Raspatories	36
HOHMANN-ALDINGER Bone Lever	31	LAMBOTTE-MINI Osteotomes	57
HOHMANN-MINI Bone Levers	29	Lamina Spreaders	158,159
HOKE Osteotomes	57	Laminectomy Punches	160-173
HOLSHER Nerve Hook	151	Laminectomy Punches, dismountable	161
Hooks for Küntscher Nails	113		
Hooks, Bone-	8,32		
Hooks, Dura-	149		

	Page		Page
Laminectomy Retractors	153-159	MICRO Forceps, Tumor- and Tissue-Grasping-	195,200,203-204
Laminectomy Rongeurs	160-173	MICRO Needleholders	219-234
LANDOLDT Tumor Grasping Forceps	172	MICRO Needleholders with "Prifile" handles	233-234
LANE Bone Holding Forceps	71	MICRO Needleholders with DIAMOND Tips	229-232
LANE Screwdrivers	128	MICRO Needleholders, PROMEDUR	223-224,226-227
LANE Screwholding Forceps	127	MICRO Needleholders, TITANIUM	229-232
LANE-TRETHOWAN Bone Lever	33	MICRO Scissors	206-218,236
LANGENBECK Bone Holding Forceps	70	MICRO Scissors (GYNECOLOGY)	206
LANGENBECK Elevators	28	MICRO Scissors with "Profile" handles	214-217
LANGENBECK Hip Retractors	14	MICRO Scissors, TITANIUM	213
LANGENBECK Metacarpal Saw	26	MICRO Tissue Forceps	191,199,202
LANGENBECK Raspatories	36	Microlumbar Forceps	172
LANGENBECK Retractors	13,14	MICRO-VANNAS Sissors	206
LARSEN Tendon Seizing Forceps	90	MIDDELDORPF Retractors	15
Lead Hands	88	MILLES Micro-Scissors	211,217
LEKSELL-STILLE Bone Rongeurs	83	MILLIGAN Dura Dissector	143
LEMPERT Bone Rongeurs	77	MILLIGAN Retractor	19
LEPINE Bending Instrument	118	MINI-Applying Forceps for YASARGIL Clips	254-258
Levers, Bone-	27-33	MINI-Bone-Plates	121
LEWIN Bone Holding Forceps	67	MINI-Cortical Screws	126
LEXER Chisels	59	MOLLISON Retractor	19
LEXER Gouges	60,61	MOORE Bone Drill	110
LEXER Osteotomes	60,61	MOORE Twist-Drill	110
LEXER-MINI Gouges	60	MULTIPLE Fragment Plate	122
LEXER-MINI Osteotomes	60	MURPHY Retractors	9
LEYLA Self Retaining Brain Retractors	138,139	MURPHY-LANE Bone Lever	33
Ligature Carriers	237		
LISTON Bone Cutting Forceps	85	N	
LITTAUER-LISTON Bone Cutting Forceps	85	NAGEL Micro-Scissors	216
Locking Pliers	104	Nail Drills	89
LOCKING Pliers for Extraction Hammer	114	Nail Drivers	113
Loupes, binocular	263-263	Nail Impactor	112
LOUTE Wire Twister	96	Nail Splitter	89
LOVE Nerve Hooks	150	Nail-Extracting Forceps	89
LOVE-GRUENWALD Laminectomy Rongeurs	169	Nailsplitting Scissors	89
LOWE-BRECK Meniscotomy Knife	94	Needle Nosed Pliers	105
LOWMAN Bone Clamps	75	Needle Nosed Pliers for Extraction Hammer	114
LOWMAN-HOGLUND Bone Clamps	75	Needleholders	219-234
LUCAE Mallets	50	NEFF Meniscotomes	94
LUER Bone Rongeurs	76	Nerve Hooks	146-152
		Nerve Root Hooks	150
M		Nerve Root Retractors	152
Malleolous Screws	124	Nerve Separator	141
Mallets	51-54	Neurosurgery-Caliper	186
MARKWALDER Bone Rongeur	79	Neurosurgical Elevators	182
MARQUARDT Bone Rongeur	80	NICOLA Micro Forceps	236
MARTEL Conductors	137	NICOLA Micro Scissors	236
MARTIN Cartilage Forceps	93	NICOLA Pituitary Curettes	238
MARTINI Curettes	43	NICOLA Raspatory	238
MATHIEU-STYLE Wire Twister	102	NORFOLK-NORWICH Retractor	19
MAYFIELD Bone Rongeur	80	Nut for screws	124
MAYO-HABERISSER Wire Twisters	103	NYLON Mallet Spare Disks	50
McINDOE Bone Cutting Forceps	86		
McKENZIE Brain Clips	176	O	
McKENZIE Clip Applying Forceps	175	OCULUS Loupes	263-263
McKENZIE Clip Racks	176	OLDBERG Laminectomy Rongeur	170
McKENZIE Perforator Drill	134	OLDBERG Retractors	152
MEAD Bone Rongeurs	77	OLIVECRONA (GIGLI) Saw Wires	137
MEAD Mallet	51	OLIVECRONA Bone Rongeur	78
Meniscotomes	94,95	OLIVECRONA Brain Spatulas	144
Meniscus- and Cartilage Forceps	93	OLIVECRONA Dura Dissectors	143
Metacarpal Saw	26	OLIVECRONA-TOENNIS Clip Applying Forceps	175
MEYERDING Blades	157	OLLIER Retractors	10
MEYERDING Retractors	16	OMBREDANNE Mallet	53
MICHELE Trephines	137	Osteotomes, Bone-	56-58,60-63
MICRO Dissecting Forceps	191,199,202		
MICRO Dissectors	239,240,242-243	P	
MICRO Dressing Forceps	191	PARTSCH Bone Chisels	56
MICRO Forceps	190-204,235	PARTSCH Bone Gouges	56
MICRO Forceps cup-shaped	235	PARTSCH Mallets	50
MICRO Forceps oval	235	PASSOW Homostat / Chisel	42
MICRO Forceps with "Profile" handles	202-204	PEAPOD Intervertebral Disc Rongeur	173
MICRO Forceps with DIAMOND Tips	197-200	PEARSON Bone Rongeur	76
MICRO Forceps, TITANIUM	190,197-111		

	Page		Page
PENFIELD Dissectors	142	Retractor for Fingers and Toes	17,88
Peplacement Stylet for FRAZIER/FERGUSON	133	Retractor, Amputation-	26
PERCY Amputation Retractor	26	Retractor, Decompression-	152
Perforator Drill	134	Retractors	7-16,146,148,150-152182
Periosteal Elevators	140	Retractors, Brain- self-retaining	138,139
PERKINS Self Retaining Retractors	19	Retractors, Cervical-	179-180
PERTHES Reamer Awl	111	Retractors, Counter-	179
Phalangeal Elevator	27	Retractors, Hip-	14
Phalangeal Forceps	67	Retractors, Knee-	7,11,14,15,92
PHILLIPS Screwdriver	128	Retractors, Laminectomy-	159,177-181
Picks, Tissue-	246	Retractors, Nerve Root-	152
Pin Cutters PROMEDUR	101	Retractors, Self-Retaining	17-24,88,137-138,153-156158-159
Pins	108	RHOTON Micro-Forceps	197-200
Pins, intramedullary-	115	RHOTON Ring-Tissue-Forceps	200
Pituitary Curettes	237,238	RHOTON Tying Forceps	198-199
Pituitary Curettes	237	Rib Raspatories	37
Plateholding Forceps 12 cm	67	Ring Tissue Forceps	195,200,203-204
Plates, Finger-	122	Rod Gripping Forceps	117
Plates, round	120	Rongeur, Pituitary-	172
Plates, semitubular	119	Rongeurs, Bone-	76-85
Plates, small fragments	121,122	Rongeurs, Cranial-	134
Plates, Tubular-	121	Rongeurs, Laminectomy-	160-173
PLESTER Retractors	17	Rongeurs, Laminectomy-, dismountable	161
Pliers for Extraction Hammer	114	Round Plates	120
Pliers, Bending-	118	RUBIO Wire Twister	102
Pliers, Extraction-	103	RUSH Pins	115
Pliers, Flat Nose-	103	RUSKIN Bone Rongeurs	81
Pliers, locking	104	RUSKIN-LISTON Bone Cutting Forceps	86
Pliers, locking for Extraction Hammer	114		
Pliers, needle-nosed	105	S	
Pliers, Wire-	98-104	SACHS Dura Dissectors	143
Pliers, Wire Bending-	102	SACHS Dura Hook	147
POTTS-YASARGIL Micro Scissors	217	SALENIUS Meniscotomes	95
Plates, angular	123	SAMII Ring Tissue Forceps	204
Plates, bone-	119-123	SATTERLEE Amputating Saw	26
Plates, broad	120	SAUERBRUCH Bone Rongeurs	84
Plates, compression	119-122	Saw Blades	26,89
Plates, Finger-	121,122	Saw, Metacarpal-	26
Plates, mini	121	Saws, Amputating-	26
Plates, multi fragment-	122	Saws, Finger Ring-	89
Plates, narrow	119	Scaler	42,129
Plates, one quarter-tubular	121	Scalp Clips	176
Plates, one-third tubular	121	SCALP-CONTOUR Retractors	17
Plates, Semi-tubular	119	SCHEDE Bone Curettes	45
Plates, small fragments	122	SCHLESINGER Cervical Rongeurs	170
Probes, microsurgical	240	SCHNEIDER Raspatory	36
PRO-MED Laminectomy-Retractors	159	SCHNEIDER-SAUERBRUCH Raspatory	37
Protector, Skin- and Tissue-	113	SCHWARZ Extension Bows	91
PUTTI Bone Rasps	41	Scissors, Arteriotomy-	210,213
		Scissors, Cartilage-	93
Q		Scissors, Coronary Artery-	212
QUERVAIN Elevator	28	Scissors, Micro-	206-218,236
		Scissors, Nailsplitting-	89
R		Scissors, Vein-	211
Racks for Silver Clips	176	Scissors, Vessel-	217
RADOLF Nail-Extracting Forceps	89	SCOVILLE Blades	156
RALK Bone Drill	110	SCOVILLE Brain Spatulas	145
RANEY Bone Rongeurs	167	SCOVILLE Brain-Spatula Forceps	174
RANEY Clip Appling Forceps	176	SCOVILLE Disc Curettes	146
RANEY Scalp Clips	176	SCOVILLE Hemilaminectomy Spreaders	156
Raspatories	34-39,182	SCOVILLE Nerve Hooks	151
Raspatories, Micro-	182	SCOVILLE Nerve Root Hooks	150
Raspatories, Rib-	37	SCOVILLE Retractor Hooks	156
Rasps, Bone-	149	SCOVILLE-HAVERFIELD Laminectomy Spreaders	156
RAY Pituitary Curettes	237	Screw depth gauges	129
Reamer Awls	111	Screwdrivers	128,186
Reamer for Femur	112	Screwholding Forceps	127
Reamer for Tibia	112	Screws, Cortical-	124,126
Reamers for Intramedullary Pins	116	Screws, Distraction-	186
Reamers, T-Handle	114	Screws, Malleolus-	124
REILL Micro Needleholders	228	Screws, Spongiosa-	125
REILL Reposition Forceps	67	SEBILÉAU Elevator	27
Reposition Forceps	67,68,73	SEDILLOT Raspatories	37
RESANO Cartilage Scissors	93	Self-Retaining Retractors	17-24

	Page		Page
SEMB Bone Holding Forceps	69	TOENNIS Dura Hooks	149
SEMB Bone Rongeur	82	Traction Bar	75
SEMB Raspatories	38	Traction Tongues	135
Semitubular Plates	119	Trephines	127,134,137
Sequestrum Forceps	68	Trephines, Biopsy-	127
Sets, Aneurysm Clips-	259	Trephines, Cervical-	137
SETTER Reposition Forceps	67,68	Tubes, Suction-	131-133
SEWALL Raspatory	35	Tubular Plates	121
SIDE-& END Cutter	99	Tumor Forceps	195,200,203-204
SIDE-Cutter	98	Tumor Grasping Forceps	172
SIMON Bone Curettes	46	Twin-Clamps	261
Skin- & Tissue-Protector	113	Twist Drills	111,134
Skull Punches	136	Twisters, Wire-	96,102,103
Slotted Hammer	112		
Small Fragment Plates	121,122	U	
SMEDBERG Bone Drill	109	ULRICH Bone Holding Forceps	74
SMILLIE Knee Retractors	16,92	UNIVERSAL Wire Cutting Pliers	98
SMILLIE Meniscotomes	94	USA Pattern Bone Curettes	49
SMITH-PETERSON Gouges	62		
SMITH-PETERSON Osteotomtes	62	V	
SMITH-PETERSON Rongeurs	81	VAN BUREN Sequestrum Forceps	68
SMITHWICK Clip Applying Forceps	175	VANNAS Micro Scissors	206,207,215,217
SMITHWICK Nerve Hooks	141,147	Vein Scissors	211
SOFTGRIP-Hammers	54	VERBRUGGE Bone Holding Forceps	73
Spare Blades for Amputating Saws	26	VERBRUGGE-BABY Bone Holding Forceps	73
Spare Pins for Crutchfield	135	Vertebral Body Dissectors	186
Spare Wrench	110	Vertebral Body Distractors	184
Spatulas, Brain-	144-145	Vessel Clamps	261
SPEARE Dural Hook	149	Vessel Dilators	239
Speculae, Neurosurgical-	177,183	Vessel Knives	244,245
Spinal Gouges	64	Vessel Scissors	217
Spongiosa Gouges	66	Vessel Spreader	240
Spongiosa Screws	125	VOLKMANN Bone Curettes	43,44,49
SPRATT Bone Curettes	43	VOLKMANN Bonehooks	8
Spreader, Vessel-	240	VOLKMANN Retractors	7, 9
Spreaders, Lamina-	153-159		
Spring Hooks with Bulldog Clamps	176	W	
SPURLING Lamaminectomy Rongeurs	169	WAGNER Osteotomes	65
STEINMANN Pins	108	WAGNER Raspatories	38
STELLBRINK Bone Rongeurs	77	WALTER Bone Gouges	59
STILLE Bone Chisels	58	WALTON Phalangeal Elevator	27
STILLE Bone Drill	109	Washers for screws	125,126
STILLE Bone Gouges	58	WASSMUND Retractor	10
STILLE Bone Osteotomes	58	WEITLANER Self Retaining Retractors	17-18
STILLE Bone Rongeur	82	WEITLANER-BABY Self Retaining Retractor	17
STILLE-HORSLEY Bone Cutting Forceps	87	WILLIAMS Microlumbar Forceps	172
STILLE-HORSLEY Rib Shears	87	WILLIGER Bone Curettes	43,44
STILLE-LISTON Bone Cutting Forceps	86	WILLIGER Elevators	27
STILLE-LUER Bone Rongeurs	81,82	WILLIGER Mallet	50
STILLE-RUSKIN Bone Rongeur	81	WILLIGER Raspatories	35
STILLE-SHERMAN Bone Drill	109	Wire Bending Pliers	102
Strippers, Tendon-	91	Wire Cutters	98-101,104,117
Suction Tubes	131-133	Wire Dispenser for Kirschner Wires	106
Suture Pusher	240	Wire Drill Guide	109
SWEET Clip Applying Forceps	175	Wire Drills	106
SYSTRUNK Nailsplitting Scissors	89	Wire Guides	96-97
		Wire Pliers	98-104
T		Wire Tightener	107
Tampers	187	Wire Tightening Forceps	96
Tap Handle (AO)	129	Wire Twisters	96,102,103
TAYLOR Blades	157	Wire Twisters automatic	103
TAYLOR Spinal Blades	157	Wire, Bone	96
TAYLOR Spinal Hooks	146	WOODSON Dura-Separator	149
TEMPLE-FAY Laminectomy-Spreader	155	Wrenches	107,118,135
Tendon Interlacing Forceps	91	WULLSTEIN Micro Suction Canulas	132
Tendon Passers	91		
Tendon Seizing Forceps	90	Y	
Tendon Strippers	91	YASARGIL Aneurysm Clips	247-253
THIESS Mallets	50	YASARGIL Aneurysm Clip-Sets	259
Three-Jaw-Chucks	110	YASARGIL Applying Forceps	254-258
Tips, Suction-	131-133	YASARGIL Arachnoid Knives	245
Tissue Picks	246	YASARGIL Clip-Applying Forceps	254-258
Toe- and Finger Retractor	17,88	YASARGIL Dissectors	239
TOENNIS Dissectors	143		

	Page
YASARGIL Ligature Carriers	237
YASARGIL Micro Curettes	238
YASARGIL Micro Scissors	217
YASARGIL Pituitary Rongeur	172
YASARGIL Raspatories	239,240
YASARGIL Spring Hooks with Bulldog Clamps	176
YASARGIL Tumor Forceps	195

Z

ZAUFAL-JANSEN Bone Rongeur	80
ZIEGLER Wire-Cutter	99
ZIELKE Bone Gouges	61

INDEX ALPHABÉTIQUE

A

AACHEN Spatules cérébrales	145
ACLAND mod. Approximateurs pour vaisseaux	261
ACLAND mod. Clamps double	261
ACLAND mod. Clamps micro-vasculaires	261
ACLAND mod. Clamps pour vaisseaux	261
ADSON Mèche	134
ADSON Aiguilles pour aneurysme	140
ADSON Canules aspiratrice	131
ADSON Crochets à nerfs	146
ADSON Ecarteurs autostatiques	18
ADSON Periostotomes	140
ADSON Pince à disséction en baionette	174
ADSON Pince pour l'hypophyse	174
ADSON Pince-Guide-Dura	111
ADSON Pincés-gouge	78
Agrafes	176
Aiguilles pour aneurysme	140
Aiguilles ventricularies	131
ALDERDYCE Elévateur/Dissecteur	27
ALENE (Pointe carrée)	111
Alènes	111
Alésoir pour fémur	112
Alésoirs pour avant-trou	116
Alésoirs pour le forage du canal médullaire	114
ALEXANDER Ciseaux-burin	58
ALEXANDER Gouges	58
ALEXANDER Osteotomes	58
Amputation, retracteur	26
Amputation, scies	26
ANVIL Pince à ongles	89
Appareil à compression	25
Appareils pour mesurer vis	129
Approximateurs, micro- pour vaisseaux	261
Artériotomie, Ciseaux-	210,212,213
Aspiration, Canules-	131-133
AUFRANC Cobra Leviers pour os	33

B

BACON Pince-gouge	79
BADGLEY Ecarteur pour laminectomie	155
Bandes à compression	25
BANE Pince-gouge	78
BECKMAN-EATON Ecarteur autostatiques	21
BECKMANN-ADSON Ecarteurs autostatiques	21
BECKMANN-WEITLANER Ecarteurs autostatiques	20
BENNET Leviers pour os	32
BERGMANN Maillets	51,52
BEYER Pincés-gouge	77,80
BIEMER Ciseaux pour veines	211,217
BIEMER Separateur vasculaire	240
BIER Scie à amputation	26
BIRCHER Meniscotome	95
BIRCHER-GANSKE Pincés pour cartilage	93
Bistouris pour cordotomie	140,144
BLOUNT Ecarteur pour ménisque	15,92
BLOUNT Leviers pour os	31
BLUMENTHAL Pincés-gouge	79
BOEHLER Etriers	108
BOEHLER Pincés coupante à os	86
BÖHLER Pincés-gouge	80
Boîtes recommandées de Clips YASARGIL	259
BRAND Pince à saisir tendons	90
Broches intramedullaires	115
Broches, Dispensateurs-	106
Broches, KIRSCHNER	106
BRUNS Curettes tranchantes	45,47
BUCK-GRAMCKO Gouges	55
BUCK-GRAMCKO Levier pour os	29
BUCKLEY Ciseaux-burin	55

Page

Page

BUCY Bistouris pour cordotomie	140
BUNNELL Conducteur-tendons	91
BUNNELL Perforateur à main	110
BUNNELL Rugines à gouttières	91
BUSHE Curettes tranchantes	48

C

Canules aspiratrice	131-133
CARROLL Pince à saisir tendons	90
Cartilage, Ciseaux-	93
Cartilage, Pincés-	93
CASPAR Contre-Ecarteurs et valves	183-184
CASPAR Couteau pour vaisseaux	242
CASPAR Crochets à exploration et coagulation	182
CASPAR Dissecteurs vertebraux	186
CASPAR Distracteurs vertebraux	184,185
CASPAR Ecarteurs	15,182
CASPAR Ecarteurs pour colonne vertebraux	178-181
CASPAR Ecarteurs pour la hypophysectomie	177
CASPAR Elevateur	182
CASPAR Guide-Mèche	184,185
CASPAR Hemostats	187
CASPAR Mèche	186
CASPAR Micro Dissecteurs	243
CASPAR Pince coupante moelle	187
CASPAR Pincés emporte-pièces	171
CASPAR Rugine	182
CASPAR Specula	177,183
CASPAR Specula pour la hypophysectomie	177
CASPAR Tendeur et impacteur	187
CASPAR Tourne-vis	186
CASPAR Valves	177
CASPAR Vis pour distraction	186
Cochet pour dure-mère	246
CHARRIERE Scies à amputation	26
CICHERELLI Pince-gouge	76
Ciseaux à artériotomie	210
Ciseaux à dissection	214
Ciseaux à fendre les ongles	89
Ciseaux boutonnées	210,212,213
Ciseaux coronaire	210,212,213
Ciseaux pour Artériotomie	210,212,213
Ciseaux pour la Microchirurgie	206-218,236
Ciseaux pour le cartilage	93
Ciseaux pour veines	211,217
Ciseaux, TITANIUM	213
Ciseaux-burin	56,58-59,61,63
Ciseaux-burin hémostiques	42
Clamps double, micro- pour vaisseaux	261
Clamps, micro- pour vaisseaux	261
Clé supplémentaire	110
CLEVELAND Pincés coupante à os	85
CLEVELAND Pincés-gouge	79
Clips pour aneurysme et vaisseaux	247-253
clous pour os	108
CLOWARD Ecarteurs	146
CLOWARD Crochet pour dure-mère	149
CLOWARD Ecarteurs pour colonne cervical	153
CLOWARD Ecarteurs pour corps vertebraux	158
CLOWARD Lames pour écarteurs	153
CLOWARD-HOEN Ecarteurs pour colonne cervical	154
CLOWARD-HOEN Lames pour écarteurs	154
COBB Elévateurs	28
COBB Gouges	64
COBB Rugines	39
COLCLOUGH Pincés emporte-pièces	164-166
COLLIN Maillets	51
Colonne cervical, Ecarteurs	156
Compression, appareil	25
Compression, bande	25
Compression, plaques-	119-123
Compression, tube	25
Conducteurs pour scies	137
Conducteur-tendons	91

	Page		Page
CONE Craniotomes	136	Ecarteur pour laminectomie	159
Corps vertébraux, Ecarteurs-	158	Ecarteurs	7-24,146,152,182
Côtes, Rugines-	37	Ecarteurs autofixants et accessoires	138
COTTLE Maillet	51	Ecarteurs autostatiques	17-24
COTTLE-KAZANJIAN Pince coupante à os	85	Ecarteurs pour colonne cervical	153-154
Coupe-boulons à couper les broches	117	Ecarteurs pour colonne vertébral	178-181
Couteaus à arachnoïdes	245	Ecarteurs pour corps vertébraux	158
Couteaus pour ménisque	94	Ecarteurs pour genou	16,92
Couteaus pour vaisseaux	242,244,245	Ecarteurs pour la hypophysectomie	177
COX Ecarteur pour doigts et orteils	17,88	Ecarteurs pour laminectomie	155-159
Craniotomes	136	Ecarteurs pour ménisque	16,92
craniotomie, etriers	135	Ecarteurs pour racines nerveuses	150,152
Craniotomie, fraises-	134	ECHLIN Pincés-gouge	84
Craniotomie, théphines-	137	Ecrou pour vis	124,125
Craniotomie, Vilebrequin-	134	Élévateurs	27-28,31,33,140
CRILE Crochet à nerfs	146	Élévateurs pour hanche	31
Crochets à exploration et coagulation	182	Élévateurs pour phalanges	27
Crochets à nerfs	141,146,147	ESMARCH Bande à compression	25
Crochets à nerfs et à vaisseaux	246	ESMARCH Garrot	25
Crochets à ressort avec Clamp	176	Etriers à extension	91,107,108
Crochets pour clous	113	Etriers pour traction crânienne	135
Crochets pour dure-mère	147,149	ETUI seulement pour loupes binoculaires	262
Crochets pour extraction des clous	113	Extension, Etriers	107,108
Crochets pour os	8	Extraction, crochets	113
Crochets, micro-	246		
CRUTCHFIELD Etriers pour traction crânienne	135	F	
Curettes	237,238	FAHLBUSCH Micro-Ciseaux	236
Curettes malleable	46	FARABEUF Daviers à os	69
Curettes pour hernie discal	146	FARABEUF Rugines	35
Curettes tranchantes	43-49	FARABEUF-COLLIN Rugines	36
CUSHING Crochets à nerfs	147,148,150,151	FARABEUF-LAMBOTTE Davier à os	70
CUSHING Crochets pour dure-mère	149	FERGUSON Canules aspiratrice	133
CUSHING Ecarteur pour décompression	152	FERGUSON Davier à os	69
CUSHING Pincés emporte-pièces	169	FERRIS-SMITH-CUSHING Pincés emporte-pièces	168
CUSHING Raspatoires	39	FERRIS-SMITH-KERRISON Pincés emporte-pièces	160-163,167
CUSHING Spatules cérébrales	144	Fils d'acier SMO	96
CUSHING Tréphine plat	134	FISCH Canules aspiratrice	131
		FISCH Crochet pour dure-mère	246
D		FOMON Râpes pour os	41
DAHLGREN Pince craniotome 20cm	136	Fraises pour Craniotomie	134
DANDY Crochets à nerfs	147	FRAZIER Aiguilles ventriculaires	131
DARLING Ecarteurs autostatiques	23	FRAZIER Canules aspiratrice	133
DAUBENSPECK Curettes tranchantes	45	FRAZIER Canules aspiratrice pour lumière froide	133
Daviers pour os	67,69-78	FRAZIER Crochets pour dure-mère	149
DAVIS Decolles dure-mère	141	FRAZIER Separateur pour dure-mère	141
DAVIS Spatules cérébrales	145	FRIEDMANN Pince-gouge	76
DEBAKEY-MICRO-Pincettes	201	FRIEDMANN-MINI Pince-gouge	76
DECKER Pince pour lames vertebrales	173	FRYKHOLM Pince-gouge	83
Decolles dure-mère	141,142		
DEMEL Guides-fil	96	G	
DEMEL Tendeur serre-fils	96	GALT Tréphines pour craniotomie	137
D'ERRICO Ecarteur pour racines nerveuses	152	Garrot pneumatique	25
D'ERRICO Mèche	134	GELPI Ecarteur autostatiques	24
Détartre et nettoyer, instruments-	42,149	GELPI-BABY Ecarteur autostatiques	23
DEVILBIS Pince craniotome 21cm	136	GELPI-MINI Ecarteur autostatiques	23
DIAMANT Pince coupe-broches	98	GELPI-SELETZ Ecarteur autostatiques	24
Dilatateurs vasculaires	239	Genou, Ecarteurs	15,92
DINGMAN Davier à os	69	GERSTER Davier	75
Dispensateurs-Broches	106	GERZOG Maillet	51
Dispositif à plier clous et plaques	118	GIGLI (Olivecrona) Scies à fils	137
Disques à rechanche pour Maillet MEAD	51	GIGLI Manches pour Scies à fils	136
Disques à rechange pour SOFTGRIP-Maillet	54	Gouges	55-56,58-66
Dissecteurs dure-mère	143	Gouges à spongieuse	66
Dissecteurs vertebraux	186	GRAEFE Pincés à dissection pour Microchirurgie	190-191
Dissecteurs, Micro-	239-240	GRAEFE Pincés à dissection pour Microchirurgie, TITANIUM	190
Distraction, Vis-	186	GRAHAM Crochet à nerfs	146
DOCKHORN Ecarteurs	15	GREEN Ecarteur	15
Doigts et ongles, instruments-	89	GREGORY Porte-Aiguilles	227
DOWNING Meniscotome	94	GUIDAGE telescopant pour broches	109
DOYEN Rugines pour côtes	37	Guides-broches	112
		Guides-fils	96,97,237
E		H	
Ecarteur pour décompression	152	HAJEK Maillet	50
Ecarteur pour doigts et orteils	17,88		

	Page		Page
HAKANSSON Pince-gouge	77	KIRSCHNER Disques de fixation	107
HALLE bistouri à dura-mère	144	KIRSCHNER Etriers à extension	107
HALLE Curettes tranchantes malleable	46	KIRSCHNER Etriers à traction Model USA	107
HARDY Curettes	238	KIRSCHNER Perforateurs à main	109
HARDY Porte Greffon	241	KIRSCHNER Tendeur avec ecrou	107
HARDY Rugines	241	KLEINERT-KUTZ Pince à saisir tendons	90
HARDY-FAHLBUSCH Dissecteurs	241	KOCHER Ecarteurs	8,12,14
HARTMANN Pince-gouge	79	KOENIG Elévateurs pour os	27
HARVEY Pince coupe-fils et broches	99	KOENIG Rugine 15,5 cm 5 mm	35
HARVEY-JACKSON Ecarteur autostatiques	22	KOERTE Ecarteurs	10
HEATH Maillet	53	KOOS Couteaus pour vaisseaux	244,245
HEIFETZ Micro-Pincettes	203	KRAUS Couteau pour vaisseaux	245
HEIFETZ Pincés à tumeurs	195	KRAYENBÜHL Crochets à nerfs et à vaisseaux	246
HEIFETZ Spatules cérébrale	139,144	KUENTSCHER Extracteur	113
Hémostats pour os	42	KUENTSCHER Guides-broches	112
HIBBS Ciseaux-burin	63	KUENTSCHER Impacteurs	113
HIBBS Gouges	63		
HIBBS Lames pour écarteurs	157	L	
HIBBS Osteotomes	63	LAHEY Crochet pour dure-mère	149
HOEN Crochet à nerfs	146	LAMBERT-LOWMAN Daviers	75
HOEN Ecarteurs pour colonne cervical	154	LAMBOTTE Davier à os	72
HOEN Lames pour écarteurs	154	LAMBOTTE Ecarteur pour os	32
HOEN Pince à dissèction en baionette	174	LAMBOTTE Osteotomes	57
HOEN Separateurs pour dure-mère	141	LAMBOTTE Rugines	36
HOEN-MARTIN Elevateurs	140	LAMBOTTE-MINI Osteotomes	57
HOHMANN Leviers pour os	29-30	Lames de rechange pour scies à amputation	26
HOHMANN-ALDINGER Levier pour os	31	Lames de rechange pour scies-bagues	89
HOHMANN-MINI Leviers pour os	29	Lames pour écarteurs CLOWARD	153
HOKE Osteotomes	57	Lames pour écarteurs HIBBS	157
HOLSHER Crochets à nerfs	151	Lames pour écarteurs HOEN et CLOWARD-HOEN	154
HORSLEY Separateur pour dure-mère	141	Lames pour écarteurs MEYERDING	157
HOUSE Canules aspiratrice	131	Lames pour écarteurs SCOVILLE	156
HUDSON Fraise conical	134	Lames pour écarteurs TAYLOR	157
HUDSON Fraise sphérique	134	Laminectomie, Ecarteurs	155-157,159
HUDSON Pièce rallonge	134	LANDOLDT Pince pour tumeurs	172
HUDSON Vilebrequin à main	134	LANE Davier à os	71
HUNT Pince à tumeurs	195	LANE Pince Portes-vis	127
HYLIN Rugines	36	LANE Tourne-vis	128
Hypophysectomie, Ecarteurs-	177	LANE-TRETHOWAN Levier pour os	33
Hypophysectomie, instruments-	234-246	LANGENBECK Davier à os	70
Hypophysectomie, Specula-	177	LANGENBECK Ecarteurs	13,14
		LANGENBECK Elévateurs	28
I		LANGENBECK Rugines	36
Impacteurs	113	LANGENBECK Scie à amputation	26
Impacteurs / Extracteurs	116	LARSEN Pincés à saisir tendons	90
INGE Ecarteurs pour corps vertébraux	159	LEKSELL-STILLE Pincés-gouge	83
INGE-BABY Ecarteurs pour corps vertébraux	159	LEMPERT Pincés-gouge	77
Instruments à doigts et ongles	89	LEPINE Dispositif à plier clous	118
Instruments à nettoyer et détartrer	42,129	Levier à luxations	33
Instruments pour Hypophysectomie	234-246	Levier à plier les plaques	118
ISRAEL Ecarteurs	11	Levier pour modeler les clous	116
		Leviers	27-33,116,118
J		Leviers pour os	27-33
JACKSON-BURROWS Ecarteur autostatique	24	LEWIN Davier	67
JACOBSON Couteau pour vaisseaux	244	LEXER Ciseaux-burin	59
JACOBSON fourche à fils	240	LEXER Gouges	60,61
JACOBSON Micro-Ciseaux	210,217	LEXER Osteotomes	60,61
JACOBSON Porte-aiguilles	226	LEYLA Ecarteurs autofixants et accessoires	138-139
JACOBSON Porte-aiguilles PROMEDUR	226	Limes à os	40-41
JACOBSON Sonde boutonée	240	LISTON Pincés coupante à os	85
JACOBSON-MICRO Pince à dissection	192	LITTAUER-LISTON Pince coupante à os	85
JANSEN Pincés-gouge	78	Loupes binoculaires	262-263
JANSEN Curettes double	44	LOUTE Tendeur serre-fil	96
JANSEN Rugine	36	LOVE Crochets à nerfs	150
		LOVE-GRUENWALD Pincés emporte-pièces	169
K		LOWE-BRECK Meniscotome	94
KERN Daviers à os	70	LOWMAN Daviers	75
KEY Elévateurs	28	LOWMAN-HOGLUND Daviers	75
KIRK Maillet	52	LUCAE Maillets	50
KIRMISSION Rugine	35	LUER Pincés-gouge	76
KIRSCHNER Broches	106		
KIRSCHNER Clef	107	M	
KIRSCHNER Crochets pour traction	107	MAILLET fendu	112
		Maillets	50-54

	Page		Page
Maillets "Softgrip"	54	OLIVERCONA-TOENNIS Pincés à poner les agrafes	175
Maillets avec manches en bois artificiel	53	OLLIER Ecarteurs	10
MAILLETS plastic	52	OMBREDANNE Maillet	53
Mains de plomb	88	Ongles et doigts, instruments-	89
Manches pour Scies à fils	136	Os, Ciseaux-burin	55,56,58-66
Manchettes pour appareil à compression	25	Os, Curettes tranchantes-	43-49
Mandrins avec poignée	110	Os, Daviers	67,69-78
Mandrins pour mâchoires	110	Os, Gouges	55-56,58-66
MARKWALDER Pince-gouge	79	Os, hémostats	42
MARQUARDT Pince-gouge	80	Os, Impacterus-	113
Marteaus à extraction avec pincés auto-serrantes	114	Os, Leviers	27-33
MARTEL Conducteurs pour scies	137	Os, Limes-	40-41
MARTIN Ciseaux pour le cartilage	93	Os, Maillets	50-54
MARTIN Pince pour le cartilage	93	Os, Mèches-	111
MARTINI Curettes double	43	Os, Osteotomes	55-58,60-63
MATHIEU Pince serre-fils	102	Os, Pincés à réduction	67,68,73
MAYFIELD Pince-gouge	80	Os, Pincés à sequestre	68
MAYO-HABERISSER Pincés serre-fils	103	Os, Pincés coupante	85-88
McINDOE Pincés coupante à os	86	Os, Pincés pour petits fragments	67
McKENZIE Agrafes	176	Os, Pincés pour phalanges	67
McKENZIE Mèche	134	Os, Pincés-couge	76-84
McKENZIE Pincés à poner les agrafes	175	Os, Râpes-	41
McKENZIE Portes-agrafas	176	Osteosynthèse	96-129
MEAD Pincés-gouge	77	Osteosynthèse, Plaques	119-123
MEAD Maillet	51	Osteotomes	55-58,60-63
Mèches pour Craniotomie	134		
Mèches pour os	111	P	
Meniscotomes	94-95	PARTSCH Ciseaux-burin	56
Menisque, couteaus	94	PARTSCH Gouges	56
Ménisque, Ecarteurs-	15,92	PARTSCH Maillets	50
MEYERDING Ecarteurs	16	PASSOW Ciseaux-burin hémostiques	42
MEYERDING Lames pour écarteurs	157	PEAPOD Pince à disques	173
MICHELE Tréphines pour craniotomie	137	PEARSON Pince-gouge .	76
Micro-Approximateurs pour vaisseaus	261	PENFIELD Decolles dure-mère	142
Microchirurgie, Instruments	189-263	PERCY Retracteur pour amputation	26
Micro-Ciseaux avec manche "Profil"	214-217	Perforateur à ongles	89
Micro-Ciseaux pour Gynecologie	208	Perforateur pour tibia	112
Micro-Ciseaux, TITANIUM	213	Perforateurs à main	109-110
Micro-Clamps double pour vaisseaus	261	Periostotomes	140
Micro-Clamps pour vaisseaus	261	Periostotomes	140
Micro-Dissecteurs	239,240,243	PERKINS Ecarteurs autostatiques	19
Micro-Instruments pour Hypophysectomie	235-246	PERTHES Alène	111
Micro-Pincés à dissequer	190-204	Petits fragments, Pincés-	67
Micro-Pincés pour Hypophysectomie	235	Phalanges, Pincés-	67
Micro-Porte-Aiguilles	219-234	PHILLIPS Tourne-Vis	128
Micro-Raspatoires	239	PIED A COULISSE pour neurochirurgie	186
Micro-Rugines	242	Pince à enlever ciment	105
MIDDELDORPF Ecarteurs	15	Pince à mors paralleles PROMEDUR	98
MILLESI Micro-ciseaux	211,217	Pince à poser les Clips ACLAND	261
MILLIGAN Dissecteur dure-mère	143	Pince à scier les bagues	89
MILLIGAN Ecarteur autostatiques	19	Pince à seizr les broches	117
Mini-plaques	121	Pince coupante à os	85-88
Mini-Vis Corticales	126	Pince coupante moelle	187
MOLLISON Ecarteur autostatiques	19	Pince coupante sur les côtes	98
MOORE Jeu de Meches à 3	110	Pince coupe-broches coupante frontal	100
MOORE Perforateur à main	110	Pince coupe-broches PROMEDUR	98-101
MURPHY Ecarteurs	9	Pince porte-vis autostatique	129
MURPHY-LANE Levier à luxations	33	Pince pour l'hypophyse	174
		Pincés à bout pointu	105
N		Pincés à courber plaques	118
NAGEL Micro-Ciseaux	216	Pincés à dissequer	190-204
NEFF Meniscotomes	94	Pincés à dissequer en baionette	174
Nettoyer et détartre, instruments-	42,149	Pincés à dissequer pour l'hypophyse	174
NICOLA Curettes	238	Pincés à dissequer, Micro-	190-204
NICOLA Micro-ciseaux	236	Pincés à dissequer, Micro- avec bouts de DIAMANT	197-200
NICOLA Raspatoire	238	Pincés à dissequer, Micro- avec manche "Profil"	202-204
NORFOLK-NORWICH Ecarteur autostatiques	19	Pincés à dissequer, non-traumatisants DEBAKEY	201
		Pincés à dissequer, TITANIUM	197-201
O		Pincés à fils, mors paralleles	104
OCULUS Loupes binoculaires	262-263	Pincés à réduction	67,68,73
OLDBERG Ecarteurs	152	Pincés à réduction	67,68,73
OLDBERG Pincés emporte-pièces	170	Pincés à sequestre	68
OLIVECRONA (GIGLI) Scies à fils	137	Pincés à sutures, Micro-	193-195,198-199
OLIVECRONA Dissecteurs dure-mère	143	Pincés coupe-broches	99-101
OLIVECRONA Pince-couge	78		
OLIVECRONA Spatules pour dure-mère	144		

	Page		Page
Pincés coup-fils	98-100,104	S	
Pincés emporte-pièces	160-173	SACHS Crochet pour dure-mère	147
Pincés emporte-pièces avec pied mince	160	SACHS Dissecteurs dure-mère	143
Pincés emporte-pièces démontable	161	SALENIUS Meniscotomes	95
Pincés Micro pour saisir tumeurs et tissus	195,200,203-204	SAMII Micro-Pincettes	204
Pincés plats	103,104	SATTERLEE Scie à amputation	26
Pincés porte-vis	127,129	SAUERBRUCH Pincés-gouge	84
Pincés pour broches à fixer	104	SCALP-CONTOUR Ecarteurs autostatiques	17
Pincés pour cartilage	93	SCHEDE Curettes tranchantes	45
Pincés pour entrelacer tendons	91	SCHLESINGER Pincés emporte-pièces	170
Pincés pour petits fragments	67	SCHNEIDER Rugine	36
Pincés pour phalanges	67	SCHNEIDER-SAUERBRUCH Rugine	37
Pincés pour poser les agrafes	175	SCHWARZ Etriers à extension	91
Pincés pour saisir tendons	90	Scie pour bagues	89
Pincés serre-fils	102,103	Scies à fils	136
Pincés serre-fils automatique	103	Scies pour amputation	26
Pincés tire-broches	102-104	SCOVILLE Crochets à nerfs	151
Pincés Tire-broches double-articulation	102	SCOVILLE Curettes pour hernie discal	146
Pincés tire-broches PROMEDUR	102	SCOVILLE Ecarteurs pour laminectomie	156
Pincés-craniotome	136	SCOVILLE Ecarteurs pour racines nerveuses	150
Pincés-gouge	76-84	SCOVILLE Lames pour écarteurs	156
Plaques à fragments multiples	122	SCOVILLE Pince pour l'hypophyse	174
Plaques à petits fragments	121-122	SCOVILLE Spatules cérébrales	145
Plaques angulaires	123	SCOVILLE-HAVERFIELD Ecarteur pour laminectomie	156
Plaques avec trous à compression	119-123	SEBILÉAU Elévateur	27
Plaques d'un quart de tube	121	SEDILLOT Raspatoires	37
Plaques d'un tiers de tube	121	SEMB Davier à os	69
Plaques étroites	119	SEMB Pince-gouge	82
Plaques large	120	SEMB Raspatoires	38
Plaques pour doigts	122	Séparateur pour dure-mère	141
Plaques semi-tubulaires	119	Séparateur vasculaire	240
Plaques-mini	121	Sequestre, Pincés-	68
PLESTER Ecarteurs	17	Serre-fils, Pincés-	103
Poignée pour taraud	129	SETTER Pincés à réduction	67
Pointes-carrés	111	SEWALL Rugine	35
Pompe à main et Manometre	25	SIMON Curette pour os	46
Porte-Aiguilles	219	SMEDBERG Perforateur à main	109
Porte-Aiguilles avec manche ""Profil"	220	SMILLIE Couteaus pour ménisque	94
Porte-Aiguilles DIAMANT	229-232	SMILLIE Ecarteurs pour ménisque	15,92
Porte-Aiguilles PROMEDUR	223-224,226-227	SMITH-PETERSON Ciseaux-burin	62
Porte-Aiguilles TITANIUM	229-232	SMITH-PETERSON Gouges	62
Portes-agrales pour Clips MCKENZIE	176	SMITH-PETERSON Pincés-gouge	81
POTTS-YASARGHIL Micro Ciseaux	217	SMITHWICK Crochets à nerfs	141,147
PUTTI Râpes à os	41	SMITHWICK Pincés à poser les agrafes	175
Q		SOFTGRIP-Maillets	54
QUERVAIN Levier	28	Sondes boutonées	239,240
R		Sondes, micro-	239,240
RADOLF Pince à ongles	89	Spatules cérébrale	139,144
RALK Perforateur à main	110	Spatules cérébrales	144,145
RANEY Agrafes hémostatiques pour cuir chevelu	176	Spatules pour dure-mère	144
RANEY Pincés à poser les agrafes	176	SPEARE Crochet pour dure-mère	149
RANEY Pincés emporte-pièces	167	Specula pour la hypophysectomie	177
Râpes à os	41	SPRATT Curettes tranchantes	43
Raspatoires	34-39,239	SPURLING Pincés emporte-pièces	169
Raspatoires, Micro-	239	STEINMANN clous pour os	108
RAY Curettes	237	STEINMANN Pince à saisir tendons	90
Rechange, lames pour scies	26	STELLBRINK Pincés-gouge	77
Réduction, Pincés-	67,68,73	STILLE Ciseaux-burin	58
REILL Micro Porte-aiguilles	228	STILLE Gouges	58
RESANO Ciseaux pour le cartilage	93	STILLE Osteotomes	58
Retracteur pour amputation	26	STILLE Perforateur à main	109
RHOTON Micro-pincettes	197-200	STILLE Pince-gouge	82
Rondelle pour vis	126	STILLE-HORSLEY Pincés coupante à os	87
RUBIO Pince serre-fils	102	STILLE-LISTON Pincés coupante à os	86
Rugines à gouttières	91	STILLE-LUER Pincés-gouge	81,82
Rugines pour côtes	37	STILLE-RUSKIN Pince-gouge	81
Rugines Raspatoires	34-39	STILLE-SHERMAN Perforateur à main	109
Rugines Raspatoires avec manches en bois artificiel	34,38,39	SWEET Pincés à poser les agrafes	175
Rugines, Micro-	242	SYSTRUNK Ciseaux à fendre les ongles	89
RUSKIN Pincés-gouge	81	T	
RUSKIN-LISTON Pincés coupante à os	86	Tarauds	127
		TAYLOR Ecarteurs	146
		TAYLOR Lames pour écarteurs	157

	Page		Page
TEMPLE-FAY Ecarteur pour laminectomie	155-157		
Tendeurs serre-fil	96,102,103		
Tendons, Conducteur	91		
Tendons, Pince à entrelacer-	91		
Tendons, Pince à saisir-	90		
Tendons, Rugines	91		
THIESS Maillets	50		
Tige de rechange pour Canules FRAZIER/FERGUSON	133		
TOENNIS Crochet pour dure-mère	149		
TOENNIS Dissecteurs dure-mère	143		
Tôle pour protéger les tissus	113		
Tourne-vis	128,186		
traction, crâniénne	135		
Trépan pour biopsie osseuse	127		
Tréphine plat	134		
Tréphines pour craniotomie	137		
U			
ULRICH Daviers à os	74		
UNIVERSAL Pince coupe-fils	98		
USA Modèle Curettes tranchantes	49		
V			
VAN BUREN Davier à os	68		
VANNAS-Micro Ciseaux	206,207		
VERBRUGGE Davier à os	73		
VERBRUGGE-BABY Davier à os	73		
Vilebrequin à main pour craniotomie	134		
Vis à spongieuse	125-126		
Vis corticales	124,126		
Vis malléolaires	124		
Vis pour distraction	186		
Vis-Mini corticales	126		
VOLKMANN Crochets pour os	8		
VOLKMANN Curettes tranchantes	43,44,49		
VOLKMANN Ecarteurs	7,9		
W			
WAGNER Osteotomes	65		
WAGNER Raspatoires	38		
WALTER Gouges	59		
WALTON Elévateur pour phalanges	27		
WASSMUND Ecarteur	10		
WEITLANER Ecarteurs autostatiques	17-18		
WEITLANER-BABY Ecarteur autostatiques	17		
WILLIAMS Pince microlumbar	172		
WILLIGER Curettes double	44		
WILLIGER Curettes tranchantes	43		
WILLIGER Elévateurs	27		
WILLIGER Maillet	50		
WILLIGER Rugines	35		
WOODSON Separateur pour dure-mère	149		
WULLSTEIN Micro Canules aspiratrice	132		
Y			
YASARGIL Boîtes recommandées	259		
YASARGIL Canules aspiratrice	132		
YASARGIL Clips pour aneurysme et vaisseaux	247-253,259		
YASARGIL Couteaus à arachnoïdes	245		
YASARGIL Crochets à ressort avec Clamp	176		
YASARGIL Curette tranchante	238		
YASARGIL Guides-fils	237		
YASARGIL Micro Dissecteurs	239,240		
YASARGIL Micro-Ciseaux	217		
YASARGIL Micro-Raspatoires	239		
YASARGIL Pince pour l'hypophyse	172		
YASARGIL Pincés à tumeurs	195		
YASARGIL Pincés pour appliquer les clips	254-258		
YASARGIL Pincés pour appliquer les clips TITANIUM	255-258		
YASARGIL Raspatoires	240		
		Z	
		ZAUFAL-JANSEN Pince-gouge	80
		ZIEGLER Pince coupe-fils PROMEDUR	99
		ZIELKE Gouges	61

INDICE ALFABÉTICO

A

AACHEN Espátulas cerebrales	145
ACLAND mod. Aproximadores	261
ACLAND mod. clamps doble	261
ACLAND mod. Clamps Micro-vasculares	261
ACLAND Pinzas para aplicar micro-clamps	261
ADSON Aguja para ligaduras	140
ADSON Broca	134
ADSON Ganchos para nervios	146
ADSON Periostótomos	140
ADSON Pinza-guia	111
ADSON Pinzas de disección para neurocirugia	174
ADSON Pinzas para hipófisis	174
ADSON Pinzas-gubia	78
ADSON Separadores autostaticas	18
ADSON Tubos de aspiración	131
Agujas alambres	106
Agujas pasa-hilos	96,97
Alambre / recambio para FRAZIER/FERGUSO	133
ALDERDYCE Disecador	27
ALEXANDER Cinceles	58
ALEXANDER Gubias	58
ALEXANDER Osteótomos	58
ALICATES para cortar alambre	98-101,104
ANVIL Pinza corta-unas	89
Arandelas para tornillos	125,126
Arteriotomia, tijeras- aspiración, cánulas	210,212,213 131-133
AUFRANC Cobra Elevadores para huesos	33

B

BACON Pinzas-gubia	79
BADGLEY Separador para laminectomia	155
BANE Pinzas-gubia	78
BECKMAN-EATON Separadores autostaticas	21
BECKMANN-ADSON Separadores autostaticas	21
BECKMANN-WEITLANER Separadores autostaticas	20
BENNET Legras y elevadores	32
BERGMANN Martillos	51,52
BEYER Pinzas-gubia	77,80
BIEMER Separador vascular	240
BIEMER Tijeras para venas	211,217
BIER Sierra para amputación	26
Biopsia osea, trepanos	127
BIRCHER Meniscotómos	95
BIRCHER-GANSKE Pinzas para menisco y cartilago	93
Bisturis para cordotomia	140
BLOUNT Elevadores para huesos	31
BLOUNT Separadores para meniscos	16,92
BLUMENTHAL Pinzas-gubia	79
BOEHLER Estribos para extensión	108
BOEHLER Pinzas cortantes para huesos	86
BOEHLER Pinzas-gubia	80
BRAND Pinzas para coger tendones	90
Brocas	110,111,134
BRUNS Cucharillas cortantes	45,57
BUCK-GRAMCKO Elevador para huesos	29
BUCK-GRAMCKO Gubias	55
BUCKLEY Cinceles	55
BUCKLEY Gubias	55
BUCY Bisturis para cordotomia	140
BUNNELL Perforador de mano	110
BUNNELL Sonda para tendones	91
BUNNELL Stripper para tendones	91
BUSHE Cucharillas cortantes	48

C

Cajas de esterilización para clips YASARGIL	260
Cajas de recomendación YASARGIL	259
CALIBRADOR para neuro-cirugia	186
Cánulas de aspiración	131-133

Página

Página

Cánulas ventricular	131
CARROLL Pinza para coger tendones	90
CASPAR Pinzas cortantes para laminectomia	172-173
CASPAR brocas	186
CASPAR Destornillador	186
CASPAR Disecadores vertebrales	186
CASPAR Distractores vertebral	184
CASPAR Elevadores	182
CASPAR Ganchos para exploración y coagulación	182
CASPAR Guias-brocas	184,185
CASPAR hemostáticos	187
CASPAR Impactor	187
CASPAR Micro Disecadores	242,243
CASPAR Periostótomos	182
CASPAR Pinza para cambiari valvas	181
CASPAR Pinza para cortar médula	187
CASPAR Separadores	15,182
CASPAR Separadores para columna vertebral	177-182,183-186
CASPAR Separadores para discectomia micro-lumbar	177
CASPAR Separadores-opuesto	183,184
CASPAR tornillos para distracción	186
CHARRIERE Sierra para amputación	26
CICHERELLI Pinzas-gubia	76
Cinceles	55-59,60,63
Clavos intramedulares	115
Clavos para huesos	108
CLEVELAND Pinzas-gubia	79
Clips para aneurisma y vasos	247-253
CLOWARD Separadores para nervios	146
CLOWARD Ganchos para dura-madre	149
CLOWARD Separadores para cuerpos vertebrales	153,158
CLOWARD-HOEN Separadores para cuerpos vertebrales	154
COBB Elevadores	28
COBB Gubias	64
COBB Periostótomos	39
COLCLOUGH Pinzas cortantes para laminectomia	164-166
Conductores para sierras de hilo	137
CONE Pinzas saca-bocado craneal	136
Corta-alambre	117
COTTLE Martillos	51
COTTLE-KAZANJIAN Pinzas cortantes para huesos	85
COX Separador para dedos	17,88
CRILE Ganchos para nervios	146
CRUTCHFIELD Perforadores	135
CRUTCHFIELD Pinzas de tracción craneal	135
Cucharilla cortante para Microcirugia	238
Cucharillas cortantes	43-49
Cucharillas para hernia	146
Cuchillos para arachnoide	245
Cuchillos para vasos	244,245
Curetas cortantes para Microcirugia	237,238
Curetas pituitarias	238
CUSHING Pinzas cortantes para laminectomia	169
CUSHING Espátulas cerebrales	144
CUSHING Gancho para decompresión	152
CUSHING Ganchos para dura-madre	149
CUSHING Ganchos para nervios	147-149
CUSHING Periostótomos	39
CUSHING Taladro	134

D

DAHLGREN Pinza saca-bocado craneal	136
DANDY Ganchos para nervios	147
DARLING Separadores autostaticas	23
DAUBENSPECK Cucharillas cortantes	45
DAVIS Disecadores para dura-madre	141
DAVIS Espátulas cerebrales	145
DEBAKEY-Micro-Pinzas de disección con bocas atraumáticas	201
DECKER Pinzas cortantes para laminectomia	173
DEMEL pasa-hilos	96
DEMEL Tensor cierra-hilos	96
D'ERRICO Ganchos para raiz de nervios	152
D'ERRICO Taladro	134
Descoladores de dura-madre	142-143

	Página		Página
Destornilladores	128,186	Gira macho	129
Destornilladores hexagonal	128	GRAEFE Micro-Pinzas de disección	190-191
DEVILBIS Pinza saca-bocaco craneal	136	GRAEFE Micro-Pinzas de disección, TITANIO	190
Dilatadores micro-vasculares	239	GRAHAM Ganchos para nervios	146
DINGMAN Pinza porte-huesos	69	GREEN Separador	15
Disecadores	27,35-39	GREGORY Micro porta-agujas DIAMANT	227
Disecadores para dura-madre	142-143	GREGORY Micro porta-agujas PROMEDUR	227
Distribuidores / taladros	106	Gubias	55,56,58-66
DOCKHORN Separadores	15	Gubias paraesponjosa	66
DOWNING Meniscotómos	94	Guías-ligaduras	237
DOYEN Periostótomos costales	37		
E			
ECHLIN Pinzas-gubia	84	H	
Elevador para plegar las placas	118	HAJEK Martillo	50
Elevadores para huesos	27-33	HAKANSSON Pinzas-gubia	77
Elevadores para laminectomia y heilaminectomia	182	HALLE bisturios para neurocirugia	144
Enucleadores para la Microcirugia	241	HALLE Cucharillas cortantes	46
Escariadores	111	HARDY Curetas pituitarias	238
ESMARCH Bandas-compresión	25	HARDY Eucleadores para la Microcirugia	241
ESMARCH Tubo-compresión	25	HARDY Porta-implantates	241
Espátulas cerebrales	139,144-146	HARDY-FAHLBUSCH Disecadores	241
Esterilización, cajas	260	HARTMANN Pinzas-gubia	79
Estribos para extensión	91,107,108	HARVEY Alicates para cortar alambre	99
ESTUCHE para lupas binoculares	262	HARVEY-JACKSON Separadores autostaticas	22
F			
FAHLBUSCH Micro tijeras	236	HEATH Martillos	53
Falanges, elevadores-	27	HEIFETZ Espátulas cerebrales	139,144
FARABEUF Periostótomos	35	HEIFETZ Pinzas de disección con mango "perfil"	203
FARABEUF Pinzas para huesos	69	HEIFETZ Pinzas para coger tejidos y tumores	195,203
FARABEUF-COLLIN Periostótomos	36	Hemostáticos	42,187
FARABEUF-LAMBOTTE Pinzas para huesos	70	HIBBS Cinceles	63
FERGUSON Cánulas de aspiración	133	HIBBS Gubias	63
FERGUSON Cánulas de aspiración con luz fria	133	HIBBS Osteótomos	63
FERGUSON Pinzas para huesos	69	Hilos para huesos SMO	96
FERRIS-SMITH-CUSHING Pinzas cortantes para laminectomia	168	HOEN Descoladores de dura-madre	141
FERRIS-SMITH-KERRISON Pinzas cortantes avec lamina delgado	160	HOEN Gancho para nervios	146
FERRIS-SMITH-KERRISON Pinzas cortantes desmontable	161	HOEN Pinzas de disección para neurocirugia	174
FERRIS-SMITH-KERRISON Pinzas cortantes para laminectomia	160-163,167	HOEN Separadores para cuerpos vertebrales	154
FISCH Cánulas de aspiración	131	HOEN-MARTINLegras-Periostótomos	140
FISCH Ganchitos muy finos	246	HOHMANN Elevadores para huesos	29
FOMON Escofinas	41	HOHMANN-ALDINGER Elevadores para huesos	31
FRAZIER Cánulas de aspiración	133	HOHMANN-MINI Elevadores para huesos	29
FRAZIER Cánulas de aspiración con luz fria	133	HOKE Osteótomos	57
FRAZIER Cánulas ventricular	131	HOLSHER Ganchos para nervios	151
FRAZIER Descoladores	141	HORSLEY Descolador de dura-madre	141
FRAZIER Ganchos para dura-madre	149	HOUSE Cánulas de aspiración	131
Fresas	134	HUDSON Fresas	134
FRIEDMANN Pinzas-gubia	76	HUDSON Perforador de mano	134
FRIEDMANN-MINI Pinzas-gubia	76	Huesos, elevadores	27-33
FRYKHOLM Pinzas-gubia	83	HUNT Pinzas para coger tejidos y tumores	195
G			
GALT Trepanos	137	HYLIN Periostótomos	36
Ganchitos muy finos	246		
Ganchitos para nervios y vasos	246	I	
Gancho para clavos grandes	113	Impactor-Extractor	116
Gancho para decompresión	152	INGE Separadores para cuerpos vertebrales	159
Gancho para pequenos clavos	113	INGE-BABY Separadores para cuerpos vertebrales	158
Ganchos con resorte y Clamp	176	Instrumentos para meniscos	93-95
Ganchos extractore clavos	113	Instrumentos para unas	88-91
Ganchos para dura-madre	147,246	ISRAEL Separadores	11
Ganchos para exploración y coagulación	182		
Ganchos para nervios	141,146-147,149-151	J	
Ganchos para raiz de nervios	150,152	JACKSON-BURROWS Separadores autostaticas	24
GELPI Separadores autostaticas	24	JACOBSON Cuchillos para vasos	244
GELPI-BABY Separadores autostaticas	23	JACOBSON Empujador de sutura	240
GELPI-MINI Separadores autostaticas	23	JACOBSON Micro porta-agujas	226
GELPI-SELETZ Separadores autostaticas	24	JACOBSON Micro porta-agujas PROMEDUR	226
GERSTER Barras de traccion	75	JACOBSON Micro tijeras	210
GERZOG Mazo de plomo	51	JACOBSON Micro tijeras con mango "perfil"	217
GIGLI (Olivecrona) Sierras de hilo	137	JACOBSON Micro-Pinzas de disección	192
GIGLI Mangos para sierras de hilo	136	JACOBSON Sondas abotonadas	240
		JACOBSON-ADSON Micro-Pinzas de disección	192
		JANSEN Cucharillas cortantes	44
		JANSEN Periostótomos	36
		JANSEN Pinzas-gubia	78

	Página		Página
K			
KERN Pinzas para huesos	70	MARTEL Conductores para Sierras de hilo	137
KEY Elevadores	28	Martillo con ranura	112
KIRK Martillo	52	Martillos	50-54
KIRMISSION Periostótomos	35	Martillos con mangos "SOFTGRIP"	54
KIRSCHNER Agujas	106	Martillos para extracción	114
KIRSCHNER Estribos para extensión	107	Martillos, tapas de Nylon	50
KIRSCHNER Perforador de mano	109	MARTIN Pinza para huesos	93
KIRSCHNER Tensor de alambres	107	MARTIN Tijera para cartilago	93
KLEINERT-KUTZ Pinza para coger tendones	90	MARTINI Cucharillas cortantes	43
KOCHER Separadores	8,12,14	MATHIEU Pinza cierra-hilos	102
KOENIG Elevadores para huesos	27	MAYO-HABERISSER Pinzas Cierra-hilos	103
KOENIG Periostótomos	35	McINDOE Pinzas cortantes para huesos	86
KOERTE Separadores	10	McKENZIE Grapas	176
KOMPRIMETER Torniquete pneumatica	25	McKENZIE Pinzas clipadoras	175
KOOS Cuchillos para vasos	244,245	McKENZIE Portas-grapas	176
KRAUS Cuchillos para vasos	245	McKENZIE Taladro	134
KRAYENBÜHL Ganchitos para nervios y vasos	246	MEAD Martillo	51
KUENTSCHER Extractor	113	MEAD Pinzas-gubia	77
KUENTSCHER Impactores	113	Medidores para tornillos	129
KUENTSCHER Tallo-guias	112	Meniscotómos	94-95
		MEYERDING Separadores	16
L		MICHELE Trepanos	137
LAHEY Ganchos para dura-madre	149	Micro Disecadores	242,243
LAMBERT-LOWMAN Pinzas para huesos	75	Micro pinzas con mango "LAPIZ"	235
LAMBOTTE Elevadores para huesos	32	Micro pinzas de disección	190-204
LAMBOTTE Osteótomos	57	Micro pinzas de disección	190-204
LAMBOTTE Periostótomos	36	Micro pinzas de disección con bocas atraumáticas	201
LAMBOTTE Pinzas para huesos	72	Micro pinzas de disección con cascos de DIAMANTE	197-200
LAMBOTTE-MINI Osteótomos	57	Micro pinzas de disección con mango "perfil"	202-204
LANDOLDT Pinza para tumores	172	Micro pinzas de disección, TITANIO	190,197-201
LANE Destornilladores	128	Micro pinzas de disección, TITANIO	197-201
LANE Pinza porta-tornillos	127	Micro pinzas para suturas	194-195,198-199
LANE Pinzas para huesos	71	Micro porta-agujas	219-234
LANE porta-tornillos	127	Micro porta-agujas "PROMEDUR"	223,224,226,227
LANE-TRETHOWAN Elevador para huesos	33	Micro porta-agujas con bocas de DIAMANTE	227,229-232
LANGENBECK Elevadores	28	Micro porta-agujas con mango "Perfil"	233-234
LANGENBECK Periostótomos	36	Micro tijeras	206-218,236
LANGENBECK Pinzas para huesos	70	Micro tijeras con mango "LAPIZ"	218
LANGENBECK Separadores	13,14	Micro tijeras con mango "perfil"	214-217
LANGENBECK Sierra para amputación	26	Micro tijeras para Ginecologia	208
LARSEN Pinzas para coger tendones	90	MICRO-VANNAS Tijeras	206,207
Legras-Periostótomos	140	MIDDELDORPF Separadores	15
LEKSELL-STILLE Pinzas-gubia	83	MILLESI Micro tijeras	211
LEMPERT Pinzas-gubia	77	MILLESI Micro tijeras con mango "perfil"	217
LEPINE Doblador de barra	118	MILLIGAN Disecadores para dura-madre	143
LEWIN Pinza para huesos	67	MILLIGAN Separadores autostaticas	19
LEXER Cinceles	59	MINI-Placas recta	121
LEXER Gubias	60,61	MINI-Tornillos corticales	126
LEXER Osteótomos	60,61	MOLLISON Separadores autostaticas	19
LEXER-MINI Gubias	60	MOORE Juego de taladros	110
LEXER-MINI Osteótomos	60	MOORE Perforador de mano	110
LEYLA Separadores automaticos para el cerebro	138-140	MURPHY Separadores	9
Limas para huesos	40	MURPHY-LANE Elevadores para huesos	33
Limpiador de sarro	42,129		
LISTON Pinzas cortantes para huesos	85	N	
LITTAUER-LISTON Pinzas cortantes para huesos	85	NAGEL Micro tijeras con mango "perfil"	216
Llave para modelar clavos y placas	118	NEFF Meniscotómos	94
LOUTE Tensor sierra-hilos	96	Neurocirugia, Instrumentos	130-188
LOVE Ganchos para nervios	150	NICOLA Curetas cortantes para Microcirugia	237
LOVE-GRUENWALDPinzas cortantes para laminectomia	169	NICOLA Micro pinza	236
LOWE-BRECK Meniscotómo	94	NICOLA Micro tijeras	236
LOWMAN Pinzas para huesos	75	NICOLA Raspatorio	238
LOWMAN-HOGLUND Pinzas para huesos	75	NORFOLK-NORWICH Separadores autostaticas	19
LUCAE Martillos	50		
LUER Pinzas-gubia	76	O	
Lupas binoculares	262,263	OCULUS Lupas binoculares	262,263
		OLDBERG Pinzas cortantes para laminectomia	170
M		OLDBERG Separadores para hipófis	152
Mangos para sierras de hilo	136	OLIVECRONA (GIGLI) Sierras de hilo	137
Manos de plomo	88	OLIVECRONA Disecadores para dura-madre	143
MARKWALDER Pinzas-gubia	79	OLIVECRONA Espátulas cerebrales	144
MARQUARDT Pinzas-gubia	80	OLIVECRONA Pinzas-gubia	78
		OLIVERCONA-TOENNIS Pinzas clipadoras	175
		OLLIER Separadores	10

	Página		Página
OMBREDANNE Martillo	53	Placas para huesos para fragmentos pequeñas	122
Osteótomos	56-58,59-62	Placas para huesos semitubular	119
P		PLESTER Separadores autostaticas	17
PALANCE para plegar clavos	116	Porta-agujas	219-234
PARTSCH Cinceles	56	Porta-grapas	176
PARTSCH Gubias	56	POTTS-YASARGHIL Micro tijeras con mango "perfil"	217
PARTSCH Martillos	50	Prensas manual para modelar placas	118
Pasa-hilos	96,97	Protector de piel	113
PASSOW Cincele (pisón) hemostatática	42	Punzon para cavidad medular	112
PEAPOD Pinzas cortantes para laminectomia	173	Punzon para femur	112
PEARSON Pinzas-gubia	76	Punzons con mango "T"	114
PENFIELD Disecadores para dura-madre	142	PUTTI Escofinas para huesos	41
PERCY Retractor para amputación	26	Q	
Perforadores de mano	109-110,134	QUERVAIN Separador	28
Perforadores inicial	116	R	
Periostótomos	34-39,140,182	RADOLF Pinza arranca-unas	89
PERKINS Separadores autostaticas	19	RALK Perforador de mano	110
PERTHES Escariador	111	RANEY Pinza para aplicar y quitar	176
PHILLIPS Destornillador	128	RANEY Pinzas cortantes para laminectomia	167
Pinza corta-unas	89	RANEY Pinzas hémostaticas para cuero cabelludo	176
Pinza microlumbar	172	REILL Micro porta-agujas	228
Pinza para coger clavos	117	REILL Pinzas para reducción	67
Pinza para coger falanges	67	RESANO Tijeras para cartilago	93
Pinza para cortar médula	187	Retractor para amputación	26
Pinza para quitar cemento	105	RHOTON Micro-Pinzas de disección	197-200
Pinza para tumores	172	RUBIO Pinza cierra-hilos	102
Pinza porta-tornillos	129	RUSKIN Pinzas-gubia	81
Pinzas arranca-unas	89	RUSKIN-LISTON Pinzas cortantes para huesos	86
Pinzas Cierra-hilos	102,103	S	
Pinzas cierre alambre	102	SACHS Ganchos para dura-madre	147,149
Pinzas clipadoras	175,254-258,261	SALENIUS Meniscotómos	95
Pinzas con boca agudo	105	SAMII Pinzas de disección con mango "perfil"	204
Pinzas con boca agudo para martillos / extacción	114	SATTERLEE Sierra para amputación	26
Pinzas con spatulascérebrales	174	SAUERBRUCH Pinzas-gubia	84
Pinzas cortantes para huesos	87-87	SCALP-CONTOUR Separadores autostaticas	17
Pinzas cortantes para laminectomia	160-173	SCHEDE Cucharillas cortantes	45
Pinzas cortar clavos	99-101	SCHLESINGERPinzas cortantes para laminectomia	170
Pinzas de disección con bocas atraumáticas	201	SCHNEIDER Periostótomo	36
Pinzas de disección con mango "perfil"	202-204	SCHNEIDER-SAUERBRUCH Periostótomo	37
Pinzas de disección para neurocirugia	174	SCHWARZ Estribos para extensión	91
Pinzas de tracción craneal	135	SCOVILLE Cucharillas para hernia	146
Pinzas para aplicar micro-clamps "ACLAND"	261	SCOVILLE Espátulas cerebrales	145
Pinzas para coger hilos y clavos	102	SCOVILLE Ganchos para nervios	151
Pinzas para coger tejidos y tumores	195,200,203-204	SCOVILLE Ganchos para raiz de nervios	150
Pinzas para coger tendones	90	SCOVILLE Pinzas con spatulascérebrales	174
Pinzas para cortar alambre	98-101,104	SCOVILLE Separador para laminectomia	156
Pinzas para cortar frontal	98,99,100	SCOVILLE-HAVERFIELD Separador para laminectomia	156
Pinzas para entrelazar tendones	91	SEBILÉAU Elevadores para huesos	27
Pinzas para falanges	67	SEDILLOT Periostótomos	37
Pinzas para fragmentos pequeños	67	SEMB Periostótomos	38
Pinzas para hilos	102,103,104	SEMB Pinzas para huesos	69
Pinzas para hilos para martillos / extacción	114	SEMB Pinzas-gubia	82
Pinzas para hipófisis	172,174	Separador para dedos	17,88
Pinzas para huesos	67-75	Separador vascular	240
Pinzas para menisco y cartilago	93	Separadores	7-24,182
Pinzas para poner les clips-aneurisma YASARGIL	254-258,259	Separadores automaticos para el cerebro	138-140
Pinzas para reducción	67,68,73	Separadores autostaticas	17-24
Pinzas para secuestro	68	Separadores espinales	146
Pinzas plano	103,104	Separadores para columna vertebral	177-181,183-186
Pinzas porta-placas	67	Separadores para cuerpos vertebrales	158-159
Pinzas porta-tornillos	127	Separadores para discectomia micro-lumbar	177
Pinzas saca-bocado craneal	136	Separadores para hipófisis	152
Pinzas tirar-hilos	103	Separadores para huesos	9,27-33
Pinzas-gubia	76-84	Separadores para laminectomia	154-157,159
Pisóns	42	Separadores para meniscos	15,92
PLACA para fragmentos múltiples	122	Separadores para nervios	146,148,150-152
Placas para dedos	121,122	Separadores para rodilla	16,92
Placas para huesos 1/3 tubular	121	SETTER Pinza para reducción	67,68
Placas para huesos 1/4 tubular	121	SEWALL Periostótomos	35
Placas para huesos anchas	120	Sierra para abrir anillos 17 cm	89
Placas para huesos angulares	123		
Placas para huesos estrechas	119		
Placas para huesos MINI	121		

	Página		Página
Sierra para anillos	89	VOLKMANN Cucharillas cortantes	43,44,49
Sierras de hilo	137	VOLKMANN Separadors	7,9
Sierras para amputación	26		
SIMON Cucharillas cortantes	46	W	
SMEDBERG Perforador de mano	109	WAGNER Osteótomos	65
SMILLIE Meniscotómos	94	WAGNER Periostótomos	38
SMILLIE Separadores para meniscos	16,92	WALTER Gubias	59
SMITH-PETERSON Cinceles	62	WALTON Elevadores para falanges	27
SMITH-PETERSON Gubias	62	WASSMUND Separador	10
SMITH-PETERSON Pinzas-gubia	81	WEITLANER Separadores autostaticas	17,18
SMITHWICK Ganchos para nervios	141,147	WEITLANER-BABY Separador 14 cm	17
SMITHWICK Pinzas clipadoras	175	WILLIAMS Pinza microlumbar	172
SOFTGRIP-Martillos	54	WILLIGER Cucharillas cortantes	43,44
SPEARE Ganchos para dura-madre	149	WILLIGER Elevadores	27
SPRATT Cucharillas cortantes	43	WILLIGER Martillo	50
SPURLING Pinzas cortantes para laminectomia	169	WILLIGER Periostótomos	35
STEINMANN Clavos para huesos	108	WOODSON Separator para dura-madre	149
STEINMANN Pinza para coger tendones	90	WULLSTEIN Micro Cánulas de aspiración	132
STELLBRINK Pinzas-gubia	77		
STILLE Cinceles	58	Y	
STILLE Gubias	58	YASARGIL Cajas de recomendación	259
STILLE Osteótomos	58	YASARGIL Cánulas de aspiración	132
STILLE Perforador de mano	109	YASARGIL Clips para aneurisma y vasos	247-253
STILLE Pinzas-gubia	82	YASARGIL Cucharilla cortante	238
STILLE-HORSLEY Pinzas cortantes para huesos	87	YASARGIL Cuchillos para arachnoide	245
STILLE-LISTON Pinzas cortantes para huesos	86	YASARGIL Disecadores	239,240
STILLE-LUER Pinzas-gubia	81,82	YASARGIL Ganchos con resorte y Clamp	176
STILLE-RUSKIN Pinzas-gubia	81	YASARGIL guías-ligaduras	237
STILLE-SHERMAN Perforador de mano	109	YASARGIL Micro tijeras con mango "perfil"	217
Stripper para tendones	91	YASARGIL Pinza para hipófisis	172
SWEET Pinzas clipadoras	175	YASARGIL Pinzas para coger tejidos y tumores	195,203
SYSTRUNK Tijeras corta-unsas	89	YASARGIL Pinzas para poner les clips-aneursisma	254-258,259
		Z	
T		ZIEGLER Alicates para cortar alambre	99
Taladros	134	ZIELKE Gubias	61
Taladros para unas	89		
Tallo-guias	112		
Tarauds	127		
TAYLOR Separadores espinales	146		
TEMPLE-FAY Separador para laminectomia	155		
Tendones, instrumentos	90-91		
Tensores cierra-hilos automaticas	103		
Tensores sierra-hilos	96		
THIES Martillo	50		
Tijeras corta-unsas	89		
Tijeras de disección mango "perfil"	214,215		
Tijeras para arteria coronar	212		
Tijeras para arteriotomia	210,212,213		
Tijeras para arteriotomia, TITANIO	213		
Tijeras para cartilago	93		
Tijeras para venas	211,217		
Tijeras, micro	206-218,236		
TOENNIS Disecadores para dura-madre	143		
TOENNIS Ganchos para dura-madre	149		
Tornillos para distracción	186		
Tornillos para huesos	124-126		
Torniquete pneumatica	25		
Trepanos para abertura craneana	137		
Trepanos para biopsia osea	127		
U			
ULRICH Pinzas para huesos	74		
Una doble	246		
Unas, instrumentos	88-91		
UNIVERSAL Alicates para cortar alambre	98		
USA Modelo Cucharillas cortantes	49		
V			
VAN BUREN Pinza para secuestro	68		
VANNAS Micro Tijeras	206,207		
VANNAS Micro tijeras con mango "perfil"	215,217		
VERBRUGGE Pinzas para huesos	73		
VERBRUGGE-BABY Pinzas para huesos	73		

NUMMERNVERZEICHNIS · NUMERICAL INDEX · INDEX DES NUMÈROS · INDICE NUMERIO

Kat.Nr. Cat.No. No. Réf. No. Ref.	Seite Page Page Página	Kat.Nr. Cat.No. No. Réf. No. Ref.	Seite Page Page Página	Kat.Nr. Cat.No. No. Réf. No. Ref.	Seite Page Page Página	Kat.Nr. Cat.No. No. Réf. No. Ref.	Seite Page Page Página
13.1110	210	17.0925	10	17.5306	18	17.8165	156
13.1111	210	17.0930	11	17.5307	18	17.8170	156
13.1112	210	17.0931	11	17.5308	18	17.8171	156
13.1113	210	17.0932	11	17.5309	18	17.8172	156
13.1114	210	17.0934	11	17.5320	18	17.8173	156
14.0380	191	17.1011	12	17.5321	18	17.8174	156
14.0382	191	17.1012	12	17.5340	19	17.8175	156
14.0384	191	17.1013	12	17.5406	19	17.8177	156
14.0780	191	17.1014	12	17.5410	19	17.8178	156
14.0782	191	17.1015	12	17.5446	19	17.8179	156
14.0784	191	17.1016	12	17.5447	19	17.8181	157
17.0721	7	17.1017	12	17.5600	20	17.8182	157
17.0722	7	17.1018	12	17.5601	20	17.8183	157
17.0723	7	17.1019	12	17.5602	20	17.8185	157
17.0724	7	17.1020	12	17.5603	20	17.8186	157
17.0726	7	17.1021	12	17.5604	20	17.8187	157
17.0728	7	17.1022	12	17.5605	20	17.8188	157
17.0731	7	17.1023	12	17.5606	20	17.8189	157
17.0732	7	17.1024	12	17.5607	20	17.8190	157
17.0733	7	17.1025	12	17.5620	21	17.8191	157
17.0734	7	17.1040	13	17.5635	21	17.8192	157
17.0736	7	17.1041	13	17.5636	21	17.8193	157
17.0738	7	17.1042	13	17.5637	21	17.8194	157
17.0741	7	17.1043	13	17.5638	21	17.8195	157
17.0742	7	17.1045	13	17.5640	22	17.8196	157
17.0743	7	17.1049	13	17.5670	23	17.8201	157
17.0744	7	17.1050	13	17.5672	23	17.8203	157
17.0746	7	17.1051	13	17.5899	23	17.8205	157
17.0748	7	17.1052	13	17.5900	23	22.0010	25
17.0751	8	17.1053	13	17.5901	24	22.0011	25
17.0752	8	17.1054	13	17.5907	24	22.0012	25
17.0753	8	17.1055	13	17.5908	24	22.0013	25
17.0754	8	17.1060	14	17.8000	153	22.0015	25
17.0756	8	17.1062	14	17.8001	153	22.0020	25
17.0758	8	17.1070	14	17.8002	153	22.0025	25
17.0761	8	17.1071	14	17.8003	153	22.0050	26
17.0762	8	17.1072	14	17.8004	153	22.0100	26
17.0763	8	17.1073	14	17.8005	153	22.0110	26
17.0764	8	17.1074	14	17.8006	153	22.0111	26
17.0766	8	17.1075	14	17.8007	153	22.0115	26
17.0768	8	17.1076	14	17.8010	153	22.0116	26
17.0771	8	17.1077	14	17.8011	153	22.0117	26
17.0772	8	17.1078	14	17.8012	153	22.0120	26
17.0773	8	17.1080	15	17.8013	153	22.0129	26
17.0774	8	17.1081	15	17.8014	153	22.0130	26
17.0776	8	17.1086	15	17.8015	153	22.0134	26
17.0778	8	17.1087	15	17.8016	153	22.0136	26
17.0780	9	17.1088	15	17.8017	153	22.0138	26
17.0781	9	17.1160	16	17.8040	154	23.0010	27
17.0784	9	17.1162	16	17.8041	154	23.0012	27
17.0822	9	17.1164	16	17.8042	154	23.0020	27
17.0823	9	17.5206	17	17.8043	154	23.0022	27
17.0824	9	17.5207	17	17.8044	154	23.0025	27
17.0826	9	17.5210	17,88	17.8045	154	23.0028	27
17.0832	9	17.5224	17	17.8050	154	23.0029	27
17.0833	9	17.5225	17	17.8051	154	23.0030	27
17.0834	9	17.5290	17	17.8052	154	23.0036	27
17.0836	9	17.5300	17	17.8053	154	23.0050	28
17.0900	10	17.5301	17	17.8100	155	23.0052	28
17.0910	10	17.5302	18	17.8155	155	23.0060	28
17.0912	10	17.5303	18	17.8160	156	23.0080	28
17.0920	10	17.5304	18	17.8161	156	23.0081	28
17.0922	10	17.5305	18	17.8164	156	23.0082	28

Kat.Nr. Cat.No. No. Réf. No. Ref.	Seite Page Page Página	Kat.Nr. Cat.No. No. Réf. No. Ref.	Seite Page Page Página	Kat.Nr. Cat.No. No. Réf. No. Ref.	Seite Page Page Página	Kat.Nr. Cat.No. No. Réf. No. Ref.	Seite Page Page Página
23.0090	28	23.0552	37	23.1031	43	23.1128	47
23.0091	28	23.0570	37	23.1032	43	23.1129	47
23.0092	28	23.0575	37	23.1036	44	23.1131	47
23.0093	28	23.0581	37	23.1037	44	23.1132	47
23.0094	28	23.0582	37	23.1040	44	23.1133	47
23.0095	28	23.0583	37	23.1041	44	23.1134	47
23.0199	29	23.0584	37	23.1042	44	23.1135	47
23.0200	29	23.0585	37	23.1050	44	23.1136	47
23.0201	29	23.0601	38	23.1051	44	23.1137	47
23.0202	29	23.0602	38	23.1052	44	23.1138	47
23.0203	29	23.0603	38	23.1053	44	23.1139	47
23.0204	29	23.0604	38	23.1054	44	23.1140	48
23.0205	29	23.0605	38	23.1055	44	23.1141	48
23.0210	30	23.0606	38	23.1056	44	23.1142	48
23.0212	30	23.0607	38	23.1057	44	23.1143	48
23.0214	30	23.0608	38	23.1058	44	23.1144	48
23.0220	30	23.0609	38	23.1059	44	23.1145	48
23.0225	31	23.0610	38	23.1060	45	23.1146	48
23.0245	31	23.0611	39	23.1061	45	23.1147	48
23.0246	31	23.0612	39	23.1062	45	23.1148	48
23.0250	31	23.0613	39	23.1063	45	23.1149	48
23.0255	32	23.0614	39	23.1064	45	23.1150	48
23.0320	32	23.0620	39	23.1065	45	23.1153	49
23.0321	32	23.0621	39	23.1066	45	23.1154	49
23.0330	33	23.0800	40	23.1067	45	23.1155	49
23.0350	33	23.0810	40	23.1068	45	23.1156	49
23.0360	33	23.0820	40	23.1069	45	23.1171	49
23.0361	33	23.0830	41	23.1071	45	23.1172	49
23.0362	33	23.0832	41	23.1072	45	23.1173	49
23.0363	33	23.0842	42	23.1073	45	23.1174	49
23.0417	34	23.0843	42	23.1074	45	23.1175	49
23.0418	34	23.0844	42	23.1075	45	23.1176	49
23.0419	34	23.0845	42	23.1076	45	23.1181	49
23.0421	34	23.0846	42	23.1077	45	23.1182	49
23.0423	34	23.0848	42	23.1089	45	23.1183	49
23.0424	34	23.0850	42	23.1090	45	23.1184	49
23.0425	34	23.0860	42	23.1091	45	23.1185	49
23.0426	34	23.0862	42	23.1092	45	23.1186	49
23.0500	35	23.0990	42,129	23.1094	46	23.1191	49
23.0502	35	23.1000	43	23.1095	46	23.1192	49
23.0505	35	23.1001	43	23.1096	46	23.1193	49
23.0506	35	23.1002	43	23.1104	46	23.1194	49
23.0508	35	23.1003	43	23.1105	46	23.1195	49
23.0510	35	23.1004	43	23.1106	46	23.1196	49
23.0515	35	23.1005	43	23.1107	46	23.1280	50
23.0516	35	23.1006	43	23.1108	46	23.1281	50
23.0517	35	23.1007	43	23.1109	46	23.1290	50
23.0519	35	23.1010	43	23.1111	47	23.1300	50
23.0520	35	23.1011	43	23.1112	47	23.1302	50
23.0521	35	23.1012	43	23.1113	47	23.1304	50
23.0522	36	23.1013	43	23.1114	47	23.1305	50
23.0523	36	23.1015	43	23.1115	47	23.1306	50
23.0525	36	23.1016	43	23.1116	47	23.1310	50
23.0527	36	23.1017	43	23.1117	47	23.1311	50
23.0529	36	23.1020	43	23.1118	47	23.1315	51
23.0530	36	23.1021	43	23.1119	47	23.1316	51
23.0531	36	23.1022	43	23.1121	47	23.1320	51
23.0536	36	23.1023	43	23.1122	47	23.1330	51
23.0540	36	23.1025	43	23.1123	47	23.1339	51
23.0542	36	23.1026	43	23.1124	47	23.1340	51
23.0544	36	23.1027	43	23.1125	47	23.1342	52
23.0546	36	23.1028	43	23.1126	47	23.1346	52
23.0548	36	23.1030	43	23.1127	47	23.1350	52

Kat.Nr. Cat.No. No. Réf. No. Ref.	Seite Page Page Página	Kat.Nr. Cat.No. No. Réf. No. Ref.	Seite Page Page Página	Kat.Nr. Cat.No. No. Réf. No. Ref.	Seite Page Page Página	Kat.Nr. Cat.No. No. Réf. No. Ref.	Seite Page Page Página
23.1360	52	23.1488	57	23.1578	58	23.1700	62
23.1362	52	23.1489	57	23.1579	58	23.1701	62
23.1371	53	23.1490	57	23.1580	58	23.1702	62
23.1372	53	23.1491	57	23.1581	58	23.1703	62
23.1380	53	23.1492	57	23.1582	58	23.1704	62
23.1385	53	23.1493	57	23.1583	58	23.1705	62
23.1386	53	23.1494	57	23.1584	58	23.1706	62
23.1390	54	23.1495	57	23.1588	58	23.1707	62
23.1391	54	23.1496	57	23.1589	58	23.1708	62
23.1392	54	23.1497	57	23.1590	58	23.1709	62
23.1398	54	23.1498	57	23.1591	58	23.1710	62
23.1399	54	23.1499	57	23.1592	58	23.1711	62
23.1410	56	23.1500	57	23.1593	58	23.1712	62
23.1411	56	23.1501	57	23.1594	58	23.1713	62
23.1412	56	23.1503	57	23.1595	58	23.1720	62
23.1413	56	23.1504	57	23.1596	58	23.1721	62
23.1414	56	23.1505	57	23.1598	58	23.1722	62
23.1415	56	23.1506	57	23.1599	58	23.1723	62
23.1416	56	23.1507	57	23.1600	58	23.1724	62
23.1420	56	23.1509	57	23.1604	58	23.1725	62
23.1421	56	23.1510	57	23.1605	58	23.1726	62
23.1422	56	23.1511	57	23.1606	58	23.1727	62
23.1423	56	23.1512	57	23.1607	58	23.1728	62
23.1424	56	23.1513	57	23.1608	58	23.1729	62
23.1425	56	23.1514	57	23.1609	58	23.1730	62
23.1426	56	23.1515	57	23.1615	59	23.1731	62
23.1440	56	23.1516	57	23.1617	59	23.1732	62
23.1441	56	23.1517	57	23.1620	59	23.1733	62
23.1442	56	23.1518	57	23.1621	59	23.1750	63
23.1443	56	23.1520	57	23.1623	60	23.1751	63
23.1444	56	23.1521	57	23.1624	60	23.1752	63
23.1445	56	23.1522	57	23.1625	60	23.1753	63
23.1446	56	23.1523	57	23.1626	60	23.1754	63
23.1450	56	23.1524	57	23.1630	60	23.1755	63
23.1451	56	23.1525	57	23.1631	60	23.1756	63
23.1452	56	23.1526	57	23.1632	60	23.1757	63
23.1453	56	23.1527	57	23.1633	60	23.1758	63
23.1454	56	23.1528	57	23.1634	60	23.1759	63
23.1455	56	23.1530	57	23.1640	60	23.1770	63
23.1456	56	23.1531	57	23.1641	60	23.1772	63
23.1458	56	23.1532	57	23.1642	60	23.1774	63
23.1459	56	23.1533	57	23.1643	60	23.1776	63
23.1460	56	23.1534	57	23.1644	60	23.1778	63
23.1461	56	23.1535	57	23.1650	61	23.1790	63
23.1462	56	23.1536	57	23.1651	61	23.1791	63
23.1463	56	23.1540	58	23.1652	61	23.1792	63
23.1464	56	23.1541	58	23.1653	61	23.1793	63
23.1468	56	23.1542	58	23.1654	61	23.1794	63
23.1469	56	23.1543	58	23.1655	61	23.1795	63
23.1470	56	23.1544	58	23.1660	61	23.1796	63
23.1471	56	23.1545	58	23.1661	61	23.1797	63
23.1472	56	23.1550	58	23.1662	61	23.1798	63
23.1473	56	23.1551	58	23.1663	61	23.1799	63
23.1474	56	23.1552	58	23.1664	61	23.1800	64
23.1478	56	23.1553	58	23.1665	61	23.1801	64
23.1479	56	23.1554	58	23.1671	61	23.1802	64
23.1480	56	23.1555	58	23.1673	61	23.1803	64
23.1481	56	23.1560	58	23.1680	61	23.1810	65
23.1482	56	23.1561	58	23.1681	61	23.1811	65
23.1483	56	23.1562	58	23.1682	61	23.1812	65
23.1484	56	23.1563	58	23.1683	61	23.1813	65
23.1486	57	23.1564	58	23.1684	61	23.1814	65
23.1487	57	23.1565	58	23.1685	61	23.1815	65

Kat.Nr. Cat.No. No. Réf. No. Ref.	Seite Page Page Página	Kat.Nr. Cat.No. No. Réf. No. Ref.	Seite Page Page Página	Kat.Nr. Cat.No. No. Réf. No. Ref.	Seite Page Page Página	Kat.Nr. Cat.No. No. Réf. No. Ref.	Seite Page Page Página
23.1820	66	23.2304	74	23.2856	81	23.3264	91
23.1821	66	23.2305	74	23.2857	81	23.3290	88
23.1822	66	23.2306	74	23.2858	81	23.3292	88
23.1823	66	23.2307	74	23.2880	81	23.3301	16,92
23.1824	66	23.2490	75	23.2881	81	23.3302	16,92
23.1825	66	23.2492	75	23.2882	82	23.3303	16,92
23.1902	55	23.2494	75	23.2883	82	23.3304	16,92
23.1903	55	23.2500	75	23.2884	82	23.3305	16,92
23.1904	55	23.2502	75	23.2885	82	23.3310	16,92
23.1912	55	23.2504	75	23.2887	82	23.3312	16,92
23.1913	55	23.2506	75	23.2890	82	23.3320	93
23.1914	55	23.2510	75	23.2893	83	23.3325	93
23.1930	55	23.2512	75	23.2895	83	23.3354	93
23.1931	55	23.2520	75	23.2896	83	23.3360	93
23.1933	55	23.2522	75	23.2902	84	23.3361	93
23.1935	55	23.2550	75	23.2903	84	23.3363	93
23.2001	67	23.2600	76	23.2904	84	23.3380	94
23.2002	67	23.2601	76	23.2910	84	23.3381	94
23.2004	67	23.2602	76	23.2912	84	23.3383	94
23.2005	67	23.2603	76	23.3005	85	23.3396	94
23.2010	67	23.2604	76	23.3010	85	23.3397	94
23.2040	67	23.2605	76	23.3011	85	23.3398	94
23.2042	68	23.2606	76	23.3012	85	23.3400	94
23.2044	68	23.2607	76	23.3013	85	23.3402	94
23.2050	68	23.2609	76	23.3014	85	23.3410	95
23.2100	68	23.2611	77	23.3015	85	23.3412	95
23.2101	68	23.2620	77	23.3016	85	23.3421	95
23.2110	68	23.2621	77	23.3017	85	23.4002	96
23.2200	69	23.2622	77	23.3020	85	23.4003	96
23.2205	69	23.2623	77	23.3050	85	23.4004	96
23.2210	69	23.2627	77	23.3052	85	23.4005	96
23.2211	69	23.2629	77	23.3054	85	23.4006	96
23.2220	69	23.2633	77	23.3056	85	23.4007	96
23.2224	69	23.2635	77	23.3100	86	23.4008	96
23.2232	69	23.2636	77	23.3101	86	23.4009	96
23.2234	69	23.2640	78	23.3111	86	23.4010	96
23.2235	70	23.2641	78	23.3122	86	23.4012	96
23.2240	70	23.2643	78	23.3123	86	23.4015	96
23.2250	70	23.2650	78	23.3150	86	23.4050	96
23.2251	70	23.2660	78	23.3151	86	23.4060	96
23.2252	70	23.2661	78	23.3161	87	23.4070	96
23.2253	70	23.2665	78	23.3162	87	23.4072	96
23.2254	70	23.2667	79	23.3201	90	23.4074	96
23.2255	70	23.2670	79	23.3210	90	23.4080	97
23.2260	71	23.2680	79	23.3212	90	23.4082	97
23.2261	71	23.2682	79	23.3214	90	23.4085	97
23.2262	71	23.2685	79	23.3216	90	23.4130	98
23.2263	71	23.2687	79	23.3222	90	23.4135	98
23.2270	72	23.2689	79	23.3223	90	23.4150	98
23.2271	72	23.2691	79	23.3224	90	23.4160	98
23.2272	72	23.2800	105	23.3225	90	23.4166	99
23.2274	72	23.2802	80	23.3230	90	23.4169	99
23.2280	73	23.2803	80	23.3232	91	23.4170	99
23.2282	73	23.2804	80	23.3233	91	23.4171	99
23.2284	73	23.2805	80	23.3242	91	23.4172	99
23.2286	73	23.2831	80	23.3243	91	23.4190	100
23.2290	73	23.2833	80	23.3244	91	23.4196	100
23.2292	73	23.2835	80	23.3245	91	23.4205	102
23.2294	73	23.2837	80	23.3246	91	23.4207	102
23.2296	73	23.2840	81	23.3247	91	23.4210	102
23.2298	73	23.2841	81	23.3250	91	23.4213	102
23.2300	74	23.2849	81	23.3260	91	23.4214	102
23.2302	74	23.2851	81	23.3262	91	23.4217	102

Kat.Nr. Cat.No. No. Réf. No. Ref.	Seite Page Page Página	Kat.Nr. Cat.No. No. Réf. No. Ref.	Seite Page Page Página	Kat.Nr. Cat.No. No. Réf. No. Ref.	Seite Page Page Página	Kat.Nr. Cat.No. No. Réf. No. Ref.	Seite Page Page Página
23.4218	102	23.4455	106	23.4544	106	23.4777	111
23.4219	102	23.4456	106	23.4545	106	23.4778	111
23.4220	103	23.4457	106	23.4546	106	23.4779	111
23.4221	103	23.4458	106	23.4547	106	23.4780	111
23.4222	103	23.4459	106	23.4548	106	23.4781	111
23.4223	103	23.4460	106	23.4549	106	23.4782	111
23.4224	103	23.4462	106	23.4550	106	23.4783	111
23.4225	103	23.4465	106	23.4552	106	23.4990	111
23.4230	103	23.4467	106	23.4555	106	23.4996	111
23.4232	103	23.4468	106	23.4569	106	23.4997	111
23.4235	103	23.4469	106	23.4570	106	23.4998	111
23.4236	103	23.4470	106	23.4571	106	24.0800	112
23.4238	103	23.4471	106	23.4572	106	24.0802	112
23.4239	103	23.4472	106	23.4573	106	24.0810	112
23.4253	104	23.4473	106	23.4574	106	24.0811	112
23.4255	104	23.4474	106	23.4575	106	24.0812	112
23.4262	104	23.4475	106	23.4576	106	24.0813	112
23.4263	104	23.4476	106	23.4577	106	24.0820	112
23.4264	104	23.4477	106	23.4578	106	24.0825	113
23.4265	105	23.4478	106	23.4579	106	24.0827	113
23.4266	105	23.4479	106	23.4580	106	24.0828	113
23.4267	105	23.4480	106	23.4582	106	24.0830	113
23.4270	100	23.4482	106	23.4585	106	24.0832	113
23.4272	100	23.4485	106	23.4600	107	24.0834	113
23.4290	101	23.4487	106	23.4601	107	24.0836	113
23.4292	101	23.4488	106	23.4602	107	24.0840	113
23.4409	106	23.4489	106	23.4603	107	24.0841	113
23.4410	106	23.4490	106	23.4604	107	24.0842	113
23.4411	106	23.4491	106	23.4605	107	24.0843	113
23.4412	106	23.4492	106	23.4606	107	24.0850	113
23.4413	106	23.4493	106	23.4607	107	24.0886	114
23.4414	106	23.4494	106	23.4608	107	24.0887	114
23.4415	106	23.4495	106	23.4609	107	24.0888	114
23.4416	106	23.4496	106	23.4610	107	24.0889	114
23.4417	106	23.4497	106	23.4611	107	24.0890	114
23.4418	106	23.4498	106	23.4614	107	24.0891	114
23.4419	106	23.4499	106	23.4615	107	24.0892	114
23.4420	106	23.4500	106	23.4617	107	24.0893	114
23.4422	106	23.4502	106	23.4618	107	24.0894	114
23.4425	106	23.4505	106	23.4619	107	24.0895	114
23.4429	106	23.4507	106	23.4620	107	24.0896	114
23.4430	106	23.4508	106	23.4630	109	24.0950	114
23.4431	106	23.4509	106	23.4650	109	24.0952	114
23.4432	106	23.4510	106	23.4651	109	24.0954	114
23.4433	106	23.4511	106	23.4660	109	24.0955	114
23.4434	106	23.4512	106	23.4661	109	24.0956	114
23.4435	106	23.4513	106	23.4670	109	24.0957	114
23.4436	106	23.4514	106	23.4675	109	24.0958	114
23.4437	106	23.4515	106	23.4680	110	24.0959	114
23.4438	106	23.4516	106	23.4685	110	24.0962	114
23.4439	106	23.4517	106	23.4690	110	24.0963	114
23.4440	106	23.4518	106	23.4691	110	24.0964	114
23.4442	106	23.4519	106	23.4695	110	24.0965	114
23.4445	106	23.4520	106	23.4696	110	24.0966	114
23.4446	106	23.4522	106	23.4697	110	24.0967	114
23.4447	106	23.4525	106	23.4699	110	24.1000	115
23.4448	106	23.4537	106	23.4700	110	24.1001	115
23.4449	106	23.4538	106	23.4701	110	24.1002	115
23.4450	106	23.4539	106	23.4702	110	24.1003	115
23.4451	106	23.4540	106	23.4770	111	24.1004	115
23.4452	106	23.4541	106	23.4772	111	24.1005	115
23.4453	106	23.4542	106	23.4774	111	24.1006	115
23.4454	106	23.4543	106	23.4776	111	24.1007	115

Kat.Nr. Cat.No. No. Réf. No. Ref.	Seite Page Page Página	Kat.Nr. Cat.No. No. Réf. No. Ref.	Seite Page Page Página	Kat.Nr. Cat.No. No. Réf. No. Ref.	Seite Page Page Página	Kat.Nr. Cat.No. No. Réf. No. Ref.	Seite Page Page Página
24.1008	115	24.1205	119	24.1406	122	24.2024	124
24.1009	115	24.1206	119	24.1407	122	24.2026	124
24.1010	115	24.1207	119	24.1408	122	24.2028	124
24.1011	115	24.1208	119	24.1409	122	24.2029	124
24.1020	115	24.1209	119	24.1410	122	24.2030	124
24.1021	115	24.1210	119	24.1412	122	24.2031	124
24.1022	115	24.1242	119	24.1422	122	24.2032	124
24.1023	115	24.1243	119	24.1423	122	24.2033	124
24.1024	115	24.1244	119	24.1424	122	24.2034	124
24.1025	115	24.1245	119	24.1425	122	24.2035	124
24.1026	115	24.1246	119	24.1426	122	24.2036	124
24.1027	115	24.1247	119	24.1427	122	24.2037	124
24.1028	115	24.1248	119	24.1428	122	24.2038	124
24.1029	115	24.1249	119	24.1429	122	24.2039	124
24.1040	115	24.1250	119	24.1430	122	24.2040	124
24.1041	115	24.1251	119	24.1432	122	24.2041	124
24.1042	115	24.1252	119	24.1441	122	24.2049	124
24.1043	115	24.1253	119	24.1442	122	24.2051	125
24.1044	115	24.1254	119	24.1443	122	24.2052	125
24.1045	115	24.1255	119	24.1444	122	24.2053	125
24.1046	115	24.1256	119	24.1451	122	24.2054	125
24.1047	115	24.1285	120	24.1651	123	24.2055	125
24.1048	115	24.1286	120	24.1652	123	24.2056	125
24.1049	115	24.1287	120	24.1653	123	24.2057	125
24.1050	115	24.1288	120	24.1654	123	24.2058	125
24.1051	115	24.1289	120	24.1655	123	24.2059	125
24.1052	115	24.1290	120	24.1656	123	24.2060	125
24.1053	115	24.1291	120	24.1657	123	24.2061	125
24.1060	115	24.1292	120	24.1658	123	24.2062	125
24.1061	115	24.1293	120	24.1659	123	24.2063	125
24.1062	115	24.1294	120	24.1660	123	24.2064	125
24.1063	115	24.1295	120	24.1661	123	24.2065	125
24.1064	115	24.1296	120	24.1673	123	24.2066	125
24.1065	115	24.1297	120	24.1675	123	24.2067	125
24.1066	115	24.1298	120	24.1677	123	24.2068	125
24.1067	115	24.1303	121	24.1683	123	24.2069	125
24.1068	115	24.1304	121	24.1685	123	24.2073	125
24.1069	115	24.1305	121	24.1687	123	24.2074	125
24.1070	115	24.1306	121	24.1693	123	24.2075	125
24.1071	115	24.1307	121	24.1695	123	24.2076	125
24.1072	115	24.1308	121	24.1697	123	24.2077	125
24.1073	115	24.1312	121	24.2001	124	24.2078	125
24.1075	116	24.1313	121	24.2002	124	24.2079	125
24.1076	116	24.1314	121	24.2003	124	24.2080	125
24.1077	116	24.1315	121	24.2004	124	24.2081	125
24.1078	116	24.1316	121	24.2005	124	24.2082	125
24.1079	116	24.1317	121	24.2006	124	24.2083	125
24.1080	116	24.1318	121	24.2007	124	24.2084	125
24.1081	116	24.1319	121	24.2008	124	24.2085	125
24.1082	116	24.1322	121	24.2009	124	24.2086	125
24.1083	116	24.1323	121	24.2010	124	24.2090	125
24.1086	117	24.1324	121	24.2011	124	24.2091	125
24.1090	118	24.1325	121	24.2012	124	24.2092	125
24.1092	118	24.1326	121	24.2013	124	24.2093	125
24.1093	118	24.1331	121	24.2014	124	24.2094	125
24.1094	117	24.1332	121	24.2015	124	24.2095	125
24.1095	118	24.1333	121	24.2016	124	24.2096	125
24.1096	118	24.1334	121	24.2017	124	24.2097	125
24.1200	119	24.1341	121	24.2018	124	24.2098	125
24.1201	119	24.1342	122	24.2019	124	24.2099	125
24.1202	119	24.1402	122	24.2020	124	24.2100	125
24.1203	119	24.1404	122	24.2022	124	24.2101	125
24.1204	119	24.1405	122	24.2023	124	24.2102	125

Kat.Nr. Cat.No. No. Réf. No. Ref.	Seite Page Page Página	Kat.Nr. Cat.No. No. Réf. No. Ref.	Seite Page Page Página	Kat.Nr. Cat.No. No. Réf. No. Ref.	Seite Page Page Página	Kat.Nr. Cat.No. No. Réf. No. Ref.	Seite Page Page Página
24.2103	125	24.2207	126	24.3073	129	27.0206	134
24.2104	125	24.2208	126	24.3074	129	27.0207	134
24.2105	125	24.2209	126	27.0056	131	27.0208	134
24.2106	125	24.2210	126	27.0057	131	27.0209	134
24.2107	125	24.2211	126	27.0066	131	27.0212	134
24.2109	125	24.2212	126	27.0067	131	27.0400	135
24.2110	126	24.2213	126	27.0068	131	27.0402	135
24.2111	126	24.2214	126	27.0070	131	27.0408	135
24.2112	126	24.2215	126	27.0071	131	27.0409	135
24.2113	126	24.2216	126	27.0072	131	27.0430	135
24.2114	126	24.2217	126	27.0073	131	27.0438	135
24.2115	126	24.2218	126	27.0074	131	27.0439	135
24.2116	126	24.2219	126	27.0075	131	27.0500	136
24.2117	126	24.2220	126	27.0076	131	27.0502	136
24.2118	126	24.2221	126	27.0077	131	27.0510	136
24.2119	126	24.2222	126	27.0078	131	27.0515	136
24.2120	126	24.2234	126	27.0079	131	27.0520	136
24.2130	126	24.2236	126	27.0090	132	27.0521	136
24.2132	126	24.2237	126	27.0091	132	27.0525	136
24.2134	126	24.2238	126	27.0094	132	27.0530	137
24.2136	126	24.2239	126	27.0096	132	27.0531	137
24.2137	126	24.2240	126	27.0098	132	27.0532	137
24.2138	126	24.2241	126	27.0100	132	27.0533	137
24.2139	126	24.2242	126	27.0101	132	27.0534	137
24.2140	126	24.2243	126	27.0102	132	27.0540	137
24.2141	126	24.2244	126	27.0103	132	27.0541	137
24.2142	126	24.2245	126	27.0152	133	27.0600	137
24.2150	126	24.2247	126	27.0154	133	27.0601	137
24.2152	126	24.2248	126	27.0156	133	27.0602	137
24.2154	126	24.2249	126	27.0170	133	27.0603	137
24.2156	126	24.2250	126	27.0171	133	27.0604	137
24.2157	126	24.2251	126	27.0172	133	27.0610	137
24.2158	126	24.2252	127	27.0173	133	27.0611	137
24.2159	126	24.2254	129	27.0174	133	27.0612	137
24.2160	126	24.2255	127	27.0175	133	27.0700	138
24.2161	126	24.2256	127	27.0176	133	27.0701	138
24.2162	126	24.2258	127	27.0176E	133	27.0705	138,139
24.2163	126	24.2262	127	27.0179	133	27.0706	138,139
24.2164	126	24.2264	127	27.0180	133	27.0707	139
24.2165	126	24.2267	127	27.0181	133	27.0708	139
24.2166	126	24.2268	127	27.0181E	133	27.0709	138,139
24.2174	126	24.2270	128	27.0182	133	27.0710	139
24.2176	126	24.2271	128	27.0183	133	27.0711	139
24.2177	126	24.2272	128	27.0183E	133	27.0712	139
24.2178	126	24.2273	128	27.0184	133	27.0713	139
24.2179	126	24.2274	128	27.0185	133	27.0721	139,144
24.2180	126	24.2275	128	27.0185E	133	27.0722	139,144
24.2181	126	24.2276	128	27.0186	133	27.0723	139,144
24.2182	126	24.2840	108	27.0187	133	27.0791	140
24.2183	126	24.2841	108	27.0190	133	27.0792	140
24.2184	126	24.2842	108	27.0191	133	27.0793	140
24.2185	126	24.2843	108	27.0192	133	27.0794	140
24.2186	126	24.2844	108	27.0193	133	27.0800	140
24.2187	126	24.2845	108	27.0194	133	27.0801	140
24.2188	126	24.2846	108	27.0195	133	27.0802	140
24.2189	126	24.2847	108	27.0196	133	27.0803	140
24.2190	126	24.2848	108	27.0199	133	27.0810	140
24.2191	126	24.2959	108	27.0200	134	27.0811	140
24.2192	126	24.2960	108	27.0201	134	27.0812	140
24.2193	126	24.2962	108	27.0202	134	27.0860	140
24.2194	126	24.3050	129	27.0203	134	27.0870	141
24.2204	126	24.3071	129	27.0204	134	27.0880	141
24.2206	126	24.3072	129	27.0205	134	27.0890	141

Kat.Nr. Cat.No. No. Réf. No. Ref.	Seite Page Page Página	Kat.Nr. Cat.No. No. Réf. No. Ref.	Seite Page Page Página	Kat.Nr. Cat.No. No. Réf. No. Ref.	Seite Page Page Página	Kat.Nr. Cat.No. No. Réf. No. Ref.	Seite Page Page Página
27.0891	141	27.1220	146	27.1563	160	27.1745	162
27.0900	141	27.1222	147	27.1563-20	160	27.1745D	161
27.0910	141	27.1226	147	27.1564	160	27.1746	162
27.0912	141	27.1228	147	27.1564-20	160	27.1746D	161
27.0921	142	27.1230	147	27.1565	160	27.1751	162
27.0922	142	27.1231	147	27.1565-20	160	27.1751D	161
27.0923	142	27.1232	147	27.1581	160	27.1752	162
27.0924	142	27.1240	147	27.1581-20	160	27.1752D	161
27.0925	142	27.1241	147	27.1582	160	27.1753	162
27.0930	143	27.1245	147	27.1582-20	160	27.1753D	161
27.0931	143	27.1246	147	27.1583	160	27.1754	162
27.0936	143	27.1250	148	27.1583-20	160	27.1754D	161
27.0940	143	27.1251	148	27.1584	160	27.1755	162
27.0942	143	27.1252	148	27.1584-20	160	27.1755D	161
27.0950	143	27.1253	148	27.1585	160	27.1756	162
27.0951	143	27.1254	148	27.1585-20	160	27.1756D	161
27.0952	143	27.1255	148	27.1601	162	27.1803	164
27.0953	143	27.1256	148	27.1602	162	27.1805	164
27.0960	144	27.1257	148	27.1603	162	27.1813	164
27.1000	144	27.1258	148	27.1604	162	27.1815	164
27.1001	144	27.1259	148	27.1605	162	27.1823	164
27.1002	144	27.1260	148	27.1611	162	27.1825	164
27.1003	144	27.1261	148	27.1612	162	27.1833	165
27.1005	144	27.1296	149	27.1613	162	27.1835	165
27.1006	144	27.1305	149	27.1614	162	27.1843	165
27.1007	144	27.1310	149	27.1615	162	27.1845	165
27.1008	144	27.1311	149	27.1616	162	27.1853	165
27.1010	144	27.1312	149	27.1621	162	27.1855	165
27.1012	144	27.1313	149	27.1622	162	27.1863	166
27.1026	144	27.1320	149	27.1623	162	27.1865	166
27.1027	144	27.1325	149	27.1624	162	27.1873	166
27.1028	144	27.1330	149	27.1625	162	27.1875	166
27.1029	144	27.1335	149	27.1626	162	27.1883	166
27.1041	145	27.1340	149	27.1631	162	27.1885	166
27.1042	145	27.1390	150	27.1632	162	27.1950	167
27.1043	145	27.1391	150	27.1633	162	27.1952	167
27.1044	145	27.1400	150	27.1634	162	27.2005	167
27.1045	145	27.1402	150	27.1635	162	27.2015	167
27.1046	145	27.1404	150	27.1641	162	27.2035	167
27.1050	145	27.1406	150	27.1642	162	27.2045	167
27.1051	145	27.1410	151	27.1643	162	27.2055	167
27.1052	145	27.1412	151	27.1644	162	27.2065	167
27.1053	145	27.1413	151	27.1645	162	27.2102	168
27.1054	145	27.1420	152	27.1646	162	27.2103	168
27.1055	145	27.1425	152	27.1651	162	27.2104	168
27.1056	145	27.1430	152	27.1652	162	27.2106	168
27.1057	145	27.1431	152	27.1653	162	27.2112	168
27.1060	145	27.1432	152	27.1654	162	27.2113	168
27.1061	145	27.1433	152	27.1655	162	27.2114	168
27.1100	146	27.1451	158	27.1656	162	27.2115	168
27.1101	146	27.1455	158	27.1731	162	27.2116	168
27.1102	146	27.1460	158	27.1732	162	27.2122	168
27.1150	146	27.1465	159	27.1733	162	27.2123	168
27.1152	146	27.1466	159	27.1734	162	27.2124	168
27.1160	146	27.1480	159	27.1735	162	27.2149	169
27.1161	146	27.1481	159	27.1741	162	27.2150	169
27.1162	146	27.1485	159	27.1741D	161	27.2151	169
27.1163	146	27.1486	159	27.1742	162	27.2152	169
27.1201	146	27.1487	159	27.1742D	161	27.2155	169
27.1202	146	27.1561	160	27.1743	162	27.2156	169
27.1206	146	27.1561-20	160	27.1743D	161	27.2157	169
27.1210	146	27.1562	160	27.1744	162	27.2159	169
27.1211	146	27.1562-20	160	27.1744D	161	27.2160	169

Kat.Nr. Cat.No. No. Réf. No. Ref.	Seite Page Page Página	Kat.Nr. Cat.No. No. Réf. No. Ref.	Seite Page Page Página	Kat.Nr. Cat.No. No. Réf. No. Ref.	Seite Page Page Página	Kat.Nr. Cat.No. No. Réf. No. Ref.	Seite Page Page Página
27.2161	169	27.2346	163	27.5034	177	27.5187	179,181
27.2162	169	27.2351	163	27.5050	178	27.5199	181
27.2163	169	27.2352	163	27.5051	178	27.5220	182
27.2164	169	27.2353	163	27.5062	178	27.5222	15,182
27.2165	169	27.2354	163	27.5063	178	27.5240	182
27.2166	169	27.2355	163	27.5071	178	27.5242	182
27.2167	169	27.2356	163	27.5072	178	27.5244	182
27.2169	169	27.2361	163	27.5073	178	27.5246	182
27.2170	169	27.2362	163	27.5074	178	27.5260	182
27.2171	169	27.2363	163	27.5075	178	27.5270	182
27.2172	169	27.2364	163	27.5076	178	27.5401	183
27.2175	169	27.2365	163	27.5077	178	27.5402	183
27.2176	169	27.2366	163	27.5078	178	27.5403	183
27.2177	169	27.2371	163	27.5081	178	27.5404	183
27.2180	170	27.2372	163	27.5082	178	27.5405	183
27.2186	170	27.2373	163	27.5083	178	27.5420	183
27.2187	170	27.2374	163	27.5084	178	27.5421	183
27.2188	170	27.2375	163	27.5085	178	27.5430	183
27.2189	170	27.2376	163	27.5086	178	27.5431	183
27.2202	171	27.2381	163	27.5087	178	27.5432	183
27.2203	171	27.2382	163	27.5088	178	27.5433	183
27.2204	171	27.2383	163	27.5091	178	27.5434	183
27.2205	171	27.2384	163	27.5092	178	27.5435	183
27.2212	171	27.2385	163	27.5093	178	27.5436	183
27.2213	171	27.2386	163	27.5094	178	27.5437	183
27.2214	171	27.2500	174	27.5095	178	27.5438	183
27.2222	171	27.2520	174	27.5096	178	27.5440	184
27.2223	171	27.2521	174	27.5097	178	27.5441	184
27.2224	171	27.2540	174	27.5098	178	27.5500	184
27.2230	172	27.2541	174	27.5100	179	27.5501	184
27.2234	172	27.2542	174	27.5101	179	27.5509	184
27.2242	172	27.2560	174	27.5110	179	27.5510	185
27.2244	173	27.2562	174	27.5111	179	27.5511	185
27.2248	173	27.2701	175	27.5114	180	27.5519	185
27.2301	163	27.2702	175	27.5115	180	27.5520	186
27.2302	163	27.2703	175	27.5120	180	27.5534	186
27.2303	163	27.2704	175	27.5121	180	27.5536	186
27.2304	163	27.2711	175	27.5122	181	27.5538	186
27.2305	163	27.2713	175	27.5123	181	27.5550	186
27.2306	163	27.2720	175	27.5124	181	27.5561	186
27.2311	163	27.2722	175	27.5125	181	27.5562	186
27.2312	163	27.2730	175	27.5126	181	27.5570	186
27.2313	163	27.2740	176	27.5132	180,181	27.5580	187
27.2314	163	27.2742	176	27.5133	180,181	27.5593	187
27.2315	163	27.2745	176	27.5134	180,181	27.5595	187
27.2316	163	27.2746	176	27.5135	180,181	27.5598	187
27.2321	163	27.2770	176	27.5136	180,181	27.5600	187
27.2322	163	27.2780	176	27.5142	181	27.8001T	255
27.2323	163	27.2800	176	27.5143	181	27.8002T	255
27.2324	163	27.2802	176	27.5144	181	27.8003T	255
27.2325	163	27.5000	177	27.5145	181	27.8004T	255
27.2326	163	27.5001	177	27.5146	181	27.8005T	255
27.2331	163	27.5021	177	27.5152	180,181	27.8006T	255
27.2332	163	27.5022	177	27.5153	180,181	27.8011T	255
27.2333	163	27.5023	177	27.5154	180,181	27.8012T	255
27.2334	163	27.5024	177	27.5155	180,181	27.8013T	255
27.2335	163	27.5025	177	27.5156	180,181	27.8014T	255
27.2336	163	27.5026	177	27.5164	181	27.8015T	255
27.2341	163	27.5027	177	27.5166	181	27.8016T	255
27.2342	163	27.5030	177	27.5183	179,181	27.8021T	255
27.2343	163	27.5031	177	27.5184	179,181	27.8022T	255
27.2344	163	27.5032	177	27.5185	179,181	27.8023T	255
27.2345	163	27.5033	177	27.5186	179,181	27.8024T	255

Kat.Nr. Cat.No. No. Réf. No. Ref.	Seite Page Page Página	Kat.Nr. Cat.No. No. Réf. No. Ref.	Seite Page Page Página	Kat.Nr. Cat.No. No. Réf. No. Ref.	Seite Page Page Página	Kat.Nr. Cat.No. No. Réf. No. Ref.	Seite Page Page Página
27.8025T	255	27.8164	250	27.8274	251	27.8388	251
27.8026T	255	27.8164T	250	27.8274T	251	27.8388T	251
27.8031T	255	27.8168	250	27.8275	251	27.8389	251
27.8032T	255	27.8168T	250	27.8275T	251	27.8389T	251
27.8033T	255	27.8180	252	27.8276	251	27.8391	251
27.8034T	255	27.8182	252	27.8276T	251	27.8391T	251
27.8035T	255	27.8190	252	27.8277	251	27.8392	251
27.8036T	255	27.8192	252	27.8277T	251	27.8392T	251
27.8097	249	27.8194	252	27.8278	251	27.8393	251
27.8097T	249	27.8200	252	27.8278T	251	27.8393T	251
27.8098	249	27.8210	252	27.8279	251	27.8394	251
27.8098T	249	27.8211	252	27.8279T	251	27.8394T	251
27.8099	249	27.8212	252	27.8280	247	27.8395	247
27.8099T	249	27.8213	252	27.8280T	247	27.8395T	247
27.8100	249	27.8214	252	27.8282	247	27.8396	247
27.8100T	249	27.8216	252	27.8282T	247	27.8396T	247
27.8102	249	27.8217	252	27.8284	247	27.8397	249
27.8102T	249	27.8220	252	27.8284T	247	27.8397T	249
27.8103	248	27.8222	252	27.8290	247	27.8400T	257
27.8103T	248	27.8224	252	27.8290T	247	27.8401T	257
27.8104	249	27.8226	252	27.8292	247	27.8402T	257
27.8104T	249	27.8227	252	27.8292T	247	27.8403T	257
27.8110	249	27.8228	252	27.8297	248	27.8404T	257
27.8112	249	27.8240	247	27.8297T	248	27.8405T	257
27.8112T	249	27.8240T	247	27.8298	248	27.8410T	257
27.8113	248	27.8242	247	27.8298T	248	27.8411T	257
27.8113T	248	27.8242T	247	27.8306	252	27.8412T	257
27.8114	249	27.8244	247	27.8307	253	27.8413T	257
27.8114T	249	27.8244T	247	27.8307T	253	27.8414T	257
27.8120	249	27.8246	248	27.8319	248	27.8415T	257
27.8120T	249	27.8246T	248	27.8319T	248	27.8430T	256
27.8122	249	27.8247	248	27.8320	248	27.8431T	256
27.8122T	249	27.8247T	248	27.8320T	248	27.8432T	256
27.8123	248	27.8248	248	27.8322	248	27.8433T	256
27.8123T	248	27.8248T	248	27.8322T	248	27.8434T	256
27.8124	249	27.8250	247	27.8323	247	27.8435T	256
27.8124T	249	27.8250T	247	27.8323T	247	27.8436T	256
27.8137	250	27.8252	247	27.8324	247	27.8437T	256
27.8137T	250	27.8252T	247	27.8324T	247	27.8440T	256
27.8138	250	27.8254	247	27.8325	247	27.8441T	256
27.8138T	250	27.8254T	247	27.8325T	247	27.8442T	256
27.8139	250	27.8258	248	27.8330	248	27.8443T	256
27.8139T	250	27.8258T	248	27.8330T	248	27.8444T	256
27.8140	250	27.8259	248	27.8332	248	27.8445T	256
27.8140T	250	27.8259T	248	27.8332T	248	27.8446T	256
27.8142	250	27.8260	247	27.8333	248	27.8447T	256
27.8142T	250	27.8260T	247	27.8333T	248	27.8490T	258
27.8144	250	27.8261	248	27.8340	247	27.8491T	258
27.8144T	250	27.8261T	248	27.8340T	247	27.8492T	258
27.8148	250	27.8262	247	27.8350	248	27.8493T	258
27.8148T	250	27.8262T	247	27.8350T	248	27.8494T	258
27.8150	250	27.8263	248	27.8351	248	27.8495T	258
27.8150T	250	27.8263T	248	27.8351T	248	27.8500T	258
27.8152	250	27.8264	247	27.8381	251	27.8501T	258
27.8152T	250	27.8264T	247	27.8381T	251	27.8502T	258
27.8154	250	27.8270	249	27.8382	251	27.8503T	258
27.8154T	250	27.8270T	249	27.8382T	251	27.8504T	258
27.8158	250	27.8271	249	27.8383	251	27.8505T	258
27.8158T	250	27.8271T	249	27.8383T	251	27.8548	254
27.8160	250	27.8272	249	27.8386	251	27.8551	254
27.8160T	250	27.8272T	249	27.8386T	251	27.8552	254
27.8162	250	27.8273	249	27.8387	251	27.8553	254
27.8162T	250	27.8273T	249	27.8387T	251	27.8560	254

Kat.Nr. Cat.No. No. Réf. No. Ref.	Seite Page Page Página	Kat.Nr. Cat.No. No. Réf. No. Ref.	Seite Page Page Página	Kat.Nr. Cat.No. No. Réf. No. Ref.	Seite Page Page Página	Kat.Nr. Cat.No. No. Réf. No. Ref.	Seite Page Page Página
27.8561	254	27.8682	252	27.8819	248	28.0136	196
27.8562	254	27.8690	252	27.8820	248	28.0138	196
27.8563	254	27.8692	252	27.8822	248	28.0200	196
27.8564	254	27.8694	252	27.8823	247	28.0202	196
27.8565	254	27.8700	252	27.8824	247	28.0220	197
27.8570	254	27.8710	252	27.8825	247	28.0220S	197
27.8571	254	27.8712	252	27.8830	248	28.0220SD	197
27.8572	254	27.8713	252	27.8832	248	28.0221	197
27.8573	254	27.8714	252	27.8833	248	28.0221S	197
27.8574	254	27.8716	252	27.8840	247	28.0221SD	197
27.8575	254	27.8717	252	27.8850	248	28.0222	197
27.8597	249	27.8720	252	27.8851	248	28.0222S	197
27.8597T	249	27.8722	252	27.8881	251	28.0222SD	197
27.8598	249	27.8724	252	27.8881T	251	28.0223	197
27.8598T	249	27.8726	252	27.8882	251	28.0223S	197
27.8599	249	27.8727	252	27.8882T	251	28.0223SD	197
27.8599T	249	27.8728	252	27.8883	251	28.0224	197
27.8600	249	27.8742	247	27.8883T	251	28.0224S	197
27.8600T	249	27.8742T	247	27.8886	251	28.0224SD	197
27.8602	249	27.8744	247	27.8886T	251	28.0225	197
27.8602T	249	27.8746	248	27.8887	251	28.0225S	197
27.8603	248	27.8747	248	27.8887T	251	28.0225SD	197
27.8604	249	27.8748	248	27.8888	251	28.0226	197
27.8604T	249	27.8750	247	27.8888T	251	28.0226S	197
27.8610	249	27.8752	247	27.8889	251	28.0226SD	197
27.8612	249	27.8754	247	27.8889T	251	28.0227	197
27.8612T	249	27.8758	248	27.8891	251	28.0227S	197
27.8613	248	27.8759	248	27.8891T	251	28.0227SD	197
27.8614	249	27.8760	247	27.8892	251	28.0230	197
27.8614T	249	27.8761	248	27.8892T	251	28.0230S	197
27.8620	249	27.8762	247	27.8893	251	28.0230SD	197
27.8620T	249	27.8763	248	27.8893T	251	28.0231	197
27.8622	249	27.8764	247	27.8894	251	28.0231S	197
27.8622T	249	27.8770	249	27.8894T	251	28.0231SD	197
27.8623	248	27.8770T	249	27.8895	247	28.0232	197
27.8624	249	27.8771	249	27.8896	247	28.0232S	197
27.8624T	249	27.8771T	249	27.8897	249	28.0232SD	197
27.8637	250	27.8772	249	27.8991	259	28.0233	197
27.8637T	250	27.8772T	249	27.8991T	259	28.0233S	197
27.8638	250	27.8773	249	27.8992	259	28.0233SD	197
27.8638T	250	27.8773T	249	27.8992T	259	28.0234	197
27.8639	250	27.8774	251	28.0011	192	28.0234S	197
27.8639T	250	27.8774T	251	28.0015	192	28.0234SD	197
27.8640	250	27.8775	251	28.0018	192	28.0235	197
27.8642	250	27.8775T	251	28.0030	192	28.0235S	197
27.8642T	250	27.8776	251	28.0032	192	28.0235SD	197
27.8644	250	27.8776T	251	28.0080	193	28.0236	197
27.8644T	250	27.8777	251	28.0081	193	28.0236S	197
27.8648	250	27.8777T	251	28.0082	193	28.0236SD	197
27.8648T	250	27.8778	251	28.0083	193	28.0237	197
27.8650	250	27.8778T	251	28.0084	194	28.0237S	197
27.8650T	250	27.8779	251	28.0085	194	28.0237SD	197
27.8652	250	27.8779T	251	28.0086	194	28.0240	200
27.8652T	250	27.8780	247	28.0087	194	28.0240S	200
27.8654	250	27.8782	247	28.0101	195	28.0240SD	200
27.8658	250	27.8784	247	28.0103	195	28.0242	200
27.8660	250	27.8790	247	28.0105	195	28.0242S	200
27.8660T	250	27.8792	247	28.0113	195	28.0242SD	200
27.8662	250	27.8797	248	28.0115	195	28.0244	200
27.8662T	250	27.8798	248	28.0123	195	28.0244S	200
27.8664	250	27.8806	252	28.0125	195	28.0244SD	200
27.8664T	250	27.8807	253	28.0130	196	28.0246	200
27.8680	252	27.8807T	253	28.0132	196	28.0246S	200

Kat.Nr. Cat.No. No. Réf. No. Ref.	Seite Page Page Página	Kat.Nr. Cat.No. No. Réf. No. Ref.	Seite Page Page Página	Kat.Nr. Cat.No. No. Réf. No. Ref.	Seite Page Page Página	Kat.Nr. Cat.No. No. Réf. No. Ref.	Seite Page Page Página
28.0246SD	200	28.0280SD	199	28.0491	204	28.2311	211
28.0250	200	28.0281	199	28.0492	204	28.2313	211
28.0250S	200	28.0281S	199	28.0495	204	28.2315	211
28.0250SD	200	28.0281SD	199	28.0496	204	28.2350	211
28.0252	200	28.0282	199	28.0497	204	28.2351	211
28.0252S	200	28.0282S	199	28.0600	202	28.2400	211
28.0252SD	200	28.0282SD	199	28.0602	202	28.2480	212
28.0254	200	28.0283	199	28.0604	202	28.2481	212
28.0254S	200	28.0283S	199	28.0606	202	28.2482	212
28.0254SD	200	28.0283SD	199	28.0608	202	28.2483	212
28.0256	200	28.0284	199	28.0610	202	28.2484	212
28.0256S	200	28.0284S	199	28.0612	202	28.2490	212
28.0256SD	200	28.0284SD	199	28.0614	202	28.2491	212
28.0260	198	28.0285	199	28.0616	202	28.2492	212
28.0260S	198	28.0285S	199	28.0618	202	28.2493	212
28.0260SD	198	28.0285SD	199	28.0622	202	28.2494	212
28.0261	198	28.0286	199	28.0700	203	28.2501	213
28.0261S	198	28.0286S	199	28.0702	203	28.2521	213
28.0261SD	198	28.0286SD	199	28.0704	203	28.2550	213
28.0262	198	28.0287	199	28.0710	203	28.2551	213
28.0262S	198	28.0287S	199	28.0712	203	28.2552	213
28.0262SD	198	28.0287SD	199	28.0714	203	28.2553	213
28.0263	198	28.0290	199	28.0715	203	28.2600	214
28.0263S	198	28.0290S	199	28.0716	203	28.2601	214
28.0263SD	198	28.0290SD	199	28.0717	203	28.2602	214
28.0264	198	28.0291	199	28.2100	207	28.2603	214
28.0264S	198	28.0291S	199	28.2101	207	28.2605	214
28.0264SD	198	28.0291SD	199	28.2102	207	28.2608	214
28.0265	198	28.0292	199	28.2103	207	28.2609	214
28.0265S	198	28.0292S	199	28.2104	207	28.2620	215
28.0265SD	198	28.0292SD	199	28.2105	207	28.2622	215
28.0266	198	28.0293	199	28.2110	206	28.2623	215
28.0266S	198	28.0293S	199	28.2111	206	28.2624	215
28.0266SD	198	28.0293SD	199	28.2112	206	28.2625	215
28.0267	198	28.0294	199	28.2113	206	28.2628	215
28.0267S	198	28.0294S	199	28.2114	206	28.2629	215
28.0267SD	198	28.0294SD	199	28.2115	206	28.2640	215
28.0270	198	28.0295	199	28.2120	208	28.2641	215
28.0270S	198	28.0295S	199	28.2121	208	28.2656	216
28.0270SD	198	28.0295SD	199	28.2122	208	28.2657	216
28.0271	198	28.0296	199	28.2123	208	28.2659	216
28.0271S	198	28.0296S	199	28.2124	208	28.2711	217
28.0271SD	198	28.0296SD	199	28.2125	208	28.2712	217
28.0272	198	28.0297	199	28.2133	208	28.2713	217
28.0272S	198	28.0297S	199	28.2150	208	28.2714	217
28.0272SD	198	28.0297SD	199	28.2151	208	28.2715	217
28.0273	198	28.0320	201	28.2190	209	28.2716	217
28.0273S	198	28.0320S	201	28.2191	209	28.2717	217
28.0273SD	198	28.0322	201	28.2200	210	28.2718	217
28.0274	198	28.0322S	201	28.2201	210	28.2719	217
28.0274S	198	28.0324	201	28.2202	210	28.2720	217
28.0274SD	198	28.0324S	201	28.2203	210	28.2721	217
28.0275	198	28.0326	201	28.2204	210	28.2722	217
28.0275S	198	28.0326S	201	28.2220	210	28.2723	217
28.0275SD	198	28.0330	201	28.2221	210	28.2724	217
28.0276	198	28.0330S	201	28.2222	210	28.2728	217
28.0276S	198	28.0332	201	28.2223	210	28.3100	228
28.0276SD	198	28.0332S	201	28.2225	210	28.3101	228
28.0277	198	28.0334	201	28.2230	211	28.3102	228
28.0277S	198	28.0334S	201	28.2231	211	28.3103	228
28.0277SD	198	28.0336	201	28.2300	211	28.3130	219
28.0280	199	28.0336S	201	28.2301	211	28.3131	219
28.0280S	199	28.0490	204	28.2310	211	28.3132	219

Kat.Nr. Cat.No. No. Réf. No. Ref.	Seite Page Page Página	Kat.Nr. Cat.No. No. Réf. No. Ref.	Seite Page Page Página	Kat.Nr. Cat.No. No. Réf. No. Ref.	Seite Page Page Página	Kat.Nr. Cat.No. No. Réf. No. Ref.	Seite Page Page Página
28.3133	219	28.3607SD	229	28.3644SD	230	28.4233	235
28.3140	220	28.3610	229	28.3645	230	28.4234	235
28.3141	220	28.3610S	229	28.3645S	230	28.4241	235
28.3142	221	28.3610SD	229	28.3645SD	230	28.4242	235
28.3143	221	28.3611	229	28.3646	230	28.4243	235
28.3150	220	28.3611S	229	28.3646S	230	28.4244	235
28.3151	220	28.3611SD	229	28.3646SD	230	28.4300	236
28.3152	221	28.3612	229	28.3647	230	28.4301	236
28.3153	221	28.3612S	229	28.3647S	230	28.4303	236
28.3154	222	28.3612SD	229	28.3647SD	230	28.4400	236
28.3155	222	28.3613	229	28.3662	227	28.4401	236
28.3156	222	28.3613S	229	28.3662D	227	28.4410	236
28.3157	222	28.3613SD	229	28.3664	227	28.4420	236
28.3242	223	28.3614	229	28.3664D	227	28.6001	239
28.3243	223	28.3614S	229	28.3700	231	28.6002	239
28.3252	223	28.3614SD	229	28.3700S	231	28.6003	239
28.3253	223	28.3615	229	28.3700SD	231	28.6004	239
28.3254	224	28.3615S	229	28.3701	231	28.6005	239
28.3255	224	28.3615SD	229	28.3701S	231	28.6006	239
28.3256	224	28.3616	229	28.3701SD	231	28.6007	239
28.3257	224	28.3616S	229	28.3702	232	28.6008	239
28.3300	225	28.3616SD	229	28.3702S	232	28.6010	240
28.3301	225	28.3617	229	28.3702SD	232	28.6011	240
28.3400	226	28.3617S	229	28.3703	232	28.6012	240
28.3402	226	28.3617SD	229	28.3703S	232	28.6015	240
28.3404	226	28.3630	230	28.3703SD	232	28.6020	240
28.3406	226	28.3630S	230	28.4010	218	28.6021	240
28.3408	226	28.3630SD	230	28.4012	218	28.6022	240
28.3450	226	28.3631	230	28.4013	218	28.6040	237
28.3451	226	28.3631S	230	28.4015	218	28.6041	237
28.3501	233	28.3631SD	230	28.4017	218	28.6042	237
28.3504	233	28.3632	230	28.4019	218	28.6043	237
28.3505	233	28.3632S	230	28.4020	218	28.6111	237
28.3506	233	28.3632SD	230	28.4040	218	28.6114	237
28.3507	233	28.3633	230	28.4042	218	28.6116	238
28.3509	233	28.3633S	230	28.4043	218	28.6117	238
28.3520	234	28.3633SD	230	28.4045	218	28.6118	238
28.3521	234	28.3634	230	28.4047	218	28.6119	238
28.3522	234	28.3634S	230	28.4049	218	28.6131	238
28.3523	234	28.3634SD	230	28.4100	235	28.6132	238
28.3600	229	28.3635	230	28.4101	235	28.6135	238
28.3600S	229	28.3635S	230	28.4103	235	28.6138	241
28.3600SD	229	28.3635SD	230	28.4104	235	28.6139	241
28.3601	229	28.3636	230	28.4105	235	28.6140	241
28.3601S	229	28.3636S	230	28.4106	235	28.6141	241
28.3601SD	229	28.3636SD	230	28.4107	235	28.6144	241
28.3602	229	28.3637	230	28.4109	235	28.6148	241
28.3602S	229	28.3637S	230	28.4110	235	28.6149	241
28.3602SD	229	28.3637SD	230	28.4111	235	28.6300	244
28.3603	229	28.3640	230	28.4201	235	28.6303	242
28.3603S	229	28.3640S	230	28.4202	235	28.6305	242
28.3603SD	229	28.3640SD	230	28.4203	235	28.6307	243
28.3604	229	28.3641	230	28.4204	235	28.6310	243
28.3604S	229	28.3641S	230	28.4211	235	28.6311	243
28.3604SD	229	28.3641SD	230	28.4212	235	28.6312	243
28.3605	229	28.3642	230	28.4213	235	28.6332	242
28.3605S	229	28.3642S	230	28.4214	235	28.6333	242
28.3605SD	229	28.3642SD	230	28.4221	235	28.6334	242
28.3606	229	28.3643	230	28.4222	235	28.6351	244
28.3606S	229	28.3643S	230	28.4223	235	28.6352	244
28.3606SD	229	28.3643SD	230	28.4224	235	28.6353	244
28.3607	229	28.3644	230	28.4231	235	28.6354	244
28.3607S	229	28.3644S	230	28.4232	235	28.6356	245

Kat.Nr. Cat.No. No. Réf. No. Ref.	Seite Page Page Página	Kat.Nr. Cat.No. No. Réf. No. Ref.	Seite Page Page Página	Kat.Nr. Cat.No. No. Réf. No. Ref.	Seite Page Page Página	Kat.Nr. Cat.No. No. Réf. No. Ref.	Seite Page Page Página
28.6357	245	40.9410V	261				
28.6360	245	40.9411A	261				
28.6365	245	40.9412V	261				
28.6366	245	40.9413A	261				
28.6375	246	40.9414V	261				
28.6376	246	40.9415A	261				
28.6391	246	40.9416V	261				
28.6392	246	40.9417A	261				
28.6396	246	40.9418V	261				
28.6397	246	40.9419A	261				
28.6398	246	58.0300	89				
28.6399	246	58.0309	89				
28.7030	262	58.0320	89				
28.7050	262	58.0350	89				
28.7055	262	58.0359	89				
28.7057	262	58.0360	89				
28.7058	262	58.0369	89				
28.7059	262	58.0517	89				
30.2000	190	58.0625	89				
30.2000T	190						
30.2001	190						
30.2001T	190						
30.2003	190						
30.2003T	190						
30.2004	190						
30.2005	190						
30.2007	190						
30.2009	190						
30.2010	191						
30.2011	191						
30.2013	191						
30.2014	191						
30.2015	191						
30.2017	191						
33.2224	41						
33.2225	41						
33.2226	41						
34.4020	15						
34.4022	15						
34.5120	103						
34.5122	103						
34.5124	103						
34.5126	103						
40.9071	261						
40.9072	261						
40.9286V	261						
40.9287V	261						
40.9325V	261						
40.9326V	261						
40.9396V	261						
40.9397A	261						
40.9398V	261						
40.9399A	261						
40.9400V	261						
40.9401A	261						
40.9402V	261						
40.9403A	261						
40.9404V	261						
40.9405A	261						
40.9406V	261						
40.9407A	261						
40.9408V	261						
40.9409A	261						

WA Distributor:

PHONE: 0423 178 332

FAX: 08- 9446 2637

EMAIL: info@sonitamedic.com.au

WEB: www.sonitamedic.com.au

POSTAL ADDRESS: P.O BOX 1289, Osborne Park Business Centre,
Osborne Park, WA 6916