

Edited by Oliver Kayser  
and Wim Quax

 WILEY-VCH

# Medicinal Plant Biotechnology

From Basic Research to Industrial Applications



## **Medicinal Plant Biotechnology**

*Edited by*

*Oliver Kayser and Wim J. Quax*

## 1807–2007 Knowledge for Generations

Each generation has its unique needs and aspirations. When Charles Wiley first opened his small printing shop in lower Manhattan in 1807, it was a generation of boundless potential searching for an identity. And we were there, helping to define a new American literary tradition. Over half a century later, in the midst of the Second Industrial Revolution, it was a generation focused on building the future. Once again, we were there, supplying the critical scientific, technical, and engineering knowledge that helped frame the world. Throughout the 20th Century, and into the new millennium, nations began to reach out beyond their own borders and a new international community was born. Wiley was there, expanding its operations around the world to enable a global exchange of ideas, opinions, and know-how.

For 200 years, Wiley has been an integral part of each generation's journey, enabling the flow of information and understanding necessary to meet their needs and fulfill their aspirations. Today, bold new technologies are changing the way we live and learn. Wiley will be there, providing you the must-have knowledge you need to imagine new worlds, new possibilities, and new opportunities.

Generations come and go, but you can always count on Wiley to provide you the knowledge you need, when and where you need it!



*William J. Pesce*  
President and Chief Executive Officer



*Peter Booth Wiley*  
Chairman of the Board

# Medicinal Plant Biotechnology

From Basic Research to Industrial Applications

Volume I

*Edited by*

*Oliver Kayser and Wim J. Quax*



WILEY-VCH Verlag GmbH & Co. KGaA



### **The Editors**

#### **Prof. Dr. Oliver Kayser**

Rijksuniversiteit Groningen  
Pharmaceutical Biology  
Antonius Deusinglaan 1  
9713 AV Groningen  
The Netherlands

#### **Prof. Dr. Wim J. Quax**

Rijksuniversiteit Groningen  
Pharmaceutical Biology  
Antonius Deusinglaan 1  
9713 AV Groningen  
The Netherlands

■ All books published by Wiley-VCH are carefully produced. Nevertheless, authors, editors, and publisher do not warrant the information contained in these books, including this book, to be free of errors. Readers are advised to keep in mind that statements, data, illustrations, procedural details or other items may inadvertently be inaccurate.

#### **Library of Congress Card No.: applied for**

#### **British Library Cataloguing-in-Publication Data**

A catalogue record for this book is available from the British Library.

#### **Bibliographic information published by the Deutsche Nationalbibliothek**

The Deutsche Nationalbibliothek lists this publication in the Deutsche Nationalbibliografie; detailed bibliographic data are available in the Internet at <http://dnb.d-nb.de>.

© 2007 WILEY-VCH Verlag GmbH & Co. KGaA, Weinheim

All rights reserved (including those of translation into other languages). No part of this book may be reproduced in any form – by photoprinting, microfilm, or any other means – nor transmitted or translated into a machine language without written permission from the publishers.

Registered names, trademarks, etc. used in this book, even when not specifically marked as such, are not to be considered unprotected by law.

**Composition** Detzner Fotosatz, Speyer

**Printing** betz-druck GmbH, Darmstadt

**Bookbinding** Litges & Dopf Buchbinderei GmbH, Heppenheim

**Cover** Adam Design, Weinheim

**Anniversary Logo Design** Richard Pacifico

Printed in the Federal Republic of Germany

Printed on acid-free paper

**ISBN:** 978-3-527-31443-0

## ***Related Titles***

Ahmad, I. / Aqil, F. / Owais, M. (eds.)

### **Modern Phytomedicine**

**Turning Medicinal Plants into Drugs**

2006. ISBN 3-527-31530-6 (Wiley-VCH, Weinheim)

Fischer, R., Schillberg, S. (eds.)

### **Molecular Farming**

**Plant-made Pharmaceuticals and Technical Proteins**

2004. ISBN 3-527-30786-9

Cullis, C. A.

### **Plant Genomics and Proteomics**

2004. ISBN 0-471-37314-1

Kayser, O., Müller, R. H. (eds.)

### **Pharmaceutical Biotechnology**

**Drug Discovery and Clinical Applications**

2004. ISBN 3-527-30554-8

Buchanan, B., Gruissem, W., Jones, R. L. (eds.)

### **Biochemistry & Molecular Biology of Plants**

2002. ISBN 0-943088-37-2

Dewick, P. M.

### **Medicinal Natural Products**

**A Biosynthetic Approach**

2002. ISBN 0-471-49640-5

## Contents

Preface XVII

Foreword XIX

List of Contributors XXIII

Color Plates XXIX

### Volume I

#### Part 1 Linking Plants, Genes, and Biotechnology 1

##### 1 The Engineering of Medicinal Plants: Prospects and Limitations of Medicinal Plant Biotechnology 3

*Matthys K. Julsing, Wim J. Quax, and Oliver Kayser*

- 1.1 Introduction 3
- 1.2 Genetic Transformation and Production of Transgenic Plants 5
- 1.3 Pathway Engineering and Combinatorial Biosynthesis 5
- 1.4 Bioprocessing 6
- 1.5 Plant Propagation 7
- 1.6 Bioanalytics and Metabolomics 7
- 1.7 Future Prospects 8
- References 8

##### 2 Metabolomics 9

*Young Hae Choi, Hye Kyong Kim, and Robert Verpoorte*

- 2.1 Introduction 9
- 2.2 Analytical Methods 11
  - 2.2.1 Chromatography 11
    - 2.2.1.1 Gas Chromatography (GC) 11
    - 2.2.1.2 High-Performance Liquid Chromatography (HPLC) 13
    - 2.2.1.3 Capillary Electrophoresis (CE) 14
    - 2.2.1.4 Thin-Layer Chromatography (TLC) 14

2.2.2	Spectroscopy	14
2.2.2.1	Mass Spectrometry (MS)	14
2.2.2.2	Nuclear Magnetic Resonance (NMR) Spectrometry	16
2.2.3	Identification of Metabolites	18
2.2.4	Sample Treatment	18
2.3	Data Handling	21
2.4	The General Set-Up of a Metabolomics Project	25
2.5	Applications	26
2.6	Conclusions	26
	References	27
<b>3</b>	<b>HPLC-NMR Techniques for Plant Extract Analysis</b>	<b>29</b>
	<i>Dan Stærk, Maja Lambert, and Jerzy W. Jaroszewski</i>	
3.1	Introduction	29
3.2	Hyphenation of Separation Techniques and Spectroscopic Methods	30
3.3	Direct HPLC-NMR Methods	32
3.3.1	Continuous-Flow HPLC-NMR	32
3.3.2	Stopped-Flow HPLC-NMR	33
3.3.3	Loop-Collection HPLC-NMR	36
3.4	Indirect HPLC-NMR Methods	36
3.4.1	HPLC-SPE-NMR	37
3.5	Cryogenically Cooled NMR Probes	41
3.6	Miniaturization	41
3.7	Conclusions	43
	References	43
<b>4</b>	<b>Plant-Associated Microorganisms (Endophytes) as a New Source of Bioactive Natural Products</b>	<b>49</b>
	<i>Gary Strobel</i>	
	Abstract	49
4.1	Introduction	49
4.2	Why Are There Needs for New Medicines?	50
4.3	Natural Products in Medicine	51
4.4	Endophytic Microbes	52
4.5	Rationale for Plant Selection	53
4.6	Endophytes and Biodiversity	55
4.7	Endophytes and Natural Products	56
4.7.1	Isolation, Preservation and Storage of Endophytic Cultures for Product Isolation	57
4.7.2	Some Examples of Bioactive Natural Products from Endophytes	57
4.7.2.1	Endophytic Fungal Products as Antibiotics	57
4.7.2.2	Endophytic Bacterial Products as Antibiotics	61
4.7.2.3	Endophytic Streptomycetes as Antibiotic Producers	62
4.7.2.4	Volatile Antibiotics from Endophytes	63

4.7.2.5	Antiviral Compounds from Endophytes	64
4.7.2.6	Endophytic Fungal Products as Anticancer Agents	65
4.7.2.7	Endophytic Fungal Products as Antioxidants	67
4.7.2.8	Endophytic Fungal Products as Immunosuppressive Compounds	68
4.8	Surprising Results from Molecular Biology Studies on <i>Pestalotiopsis microspora</i>	68
4.9	Concluding Statements	69
	Acknowledgments	70
	References	70
<b>5</b>	<b>DNA Profiling of Plants</b>	<b>73</b>
	<i>Hilde Nybom and Kurt Weising</i>	
5.1	Introduction	73
5.2	Methodology of Plant DNA Profiling	74
5.2.1	DNA Sequencing	75
5.2.2	Multilocus DNA Profiling	76
5.2.2.1	Hybridization-Based RFLP Fingerprinting	77
5.2.2.2	PCR with Arbitrary Primers	77
5.2.2.3	PCR with Microsatellite-Complementary Primers	77
5.2.2.4	AFLP Analysis	78
5.2.3	Locus-Specific Microsatellite DNA Markers	78
5.2.4	PCR-Based RFLP Analysis of Organellar and Nuclear Genomes	79
5.2.5	Other DNA Marker Methods	80
5.2.6	The Next Generation: SNPs and DNA Microarrays	80
5.3	Applications	81
5.3.1	Genotype Identification	81
5.3.1.1	Plant Species	81
5.3.1.2	Plant Cultivars and Accessions	83
5.3.1.3	<i>In-Vitro</i> -Propagated Plant Material	83
5.3.2	Genetic Diversity	84
5.3.2.1	Variation and Relatedness Among Cultivars and Accessions	84
5.3.2.2	Amount and Distribution of Variability in Wild-Growing Plants	85
5.3.2.3	Plant Systematics	86
5.3.3	Gene Tagging	87
5.4	Conclusions	88
	References	89
<b>6</b>	<b>Bioprospecting: The Search for Bioactive Lead Structures from Nature</b>	<b>97</b>
	<i>Michael Wink</i>	
	Abstract	97
6.1	Introduction	97
6.2	The Function of Secondary Metabolites	102
6.3	Modes of Action	103
6.3.1	Biomembranes	106

6.3.2	Proteins and Protein Conformation	107
6.3.3	DNA and RNA	112
6.4	The Utilization of Secondary Metabolites in Medicine	114
6.5	Conclusions	115
	Key references	115
<b>7</b>	<b>Biotechnological Approaches for the Production of some Promising Plant-Based Chemotherapeutics</b>	<b>117</b>
	<i>Ashish Baldi, V.S. Bisaria, and A.K. Srivastava</i>	
	Abstract	117
7.1	Introduction	118
7.2	Production by Plant Cell Cultures	124
7.3	Biotechnological Approaches for Production	125
7.3.1	Dedifferentiated Cultures	125
7.3.2	Differentiated Cultures	129
7.3.3	Optimization of Culture Media Composition and Culture Conditions	131
7.3.4	Immobilization	132
7.3.5	Feeding of Precursors	132
7.3.6	Elicitors	133
7.3.7	<i>In-Situ</i> Product Removal Strategies	135
7.3.8	Biotransformation Studies	136
7.3.9	Bioreactor and Scale-Up Studies	136
7.3.10	Biosynthetic Pathway Mapping and Metabolic Engineering	138
7.3.10.1	Biosynthesis of Podophyllotoxin	138
7.3.10.2	Biosynthesis of Paclitaxel	141
7.3.10.3	Biosynthesis of Camptothecin	143
7.4	Future Prospects	146
	References	147
<b>Part 2</b>	<b>Genetic Modifications, Transgenic Plants and Potential of Medicinal Plants in Genetechnology and Biotechnology</b>	<b>157</b>
<b>8</b>	<b><i>In-Vitro</i> Culturing Techniques of Medicinal Plants</b>	<b>159</b>
	<i>Wolfgang Kreis</i>	
8.1	Introduction	159
8.2	Basic Methods and Techniques	161
8.2.1	Seed Germination <i>In Vitro</i>	161
8.2.2	Embryo Culture	162
8.2.3	Callus Culture	162
8.2.4	Organogenesis	164
8.2.5	Haploid Technology	165
8.2.6	Somatic Embryogenesis	166
8.3	Protoplast Technology	167

8.3.1	Protoplasts	167
8.3.2	Somatic Hybridization	168
8.4	Special Techniques	169
8.4.1	Gene Transfer	169
8.4.2	Germplasm Storage	169
8.5	Permanent <i>In-Vitro</i> Cultures	170
8.5.1	Cell Suspension Culture	170
8.5.2	Root Culture	171
8.5.3	Shoot Culture	173
8.5.4	Bioreactors	174
8.6	Methods and Techniques Related to Secondary Metabolism	177
8.6.1	Inducing Variability	177
8.6.2	Selection	178
8.6.3	Biotransformation	178
8.6.4	Elicitation	179
8.6.5	Immobilization and Permeation	180
8.7	Conclusions	180
	References	181
<b>9</b>	<b>Biotechnological Methods for Selection of High-Yielding Cell Lines and Production of Secondary Metabolites in Medicinal Plants</b>	<b>187</b>
	<i>Donald P. Briskin</i>	
9.1	Introduction	187
9.2	Medicinal Plant Tissue Cultures and the <i>In-Vitro</i> Production of Phytomedicinal Secondary Metabolites	188
9.3	Factors Leading to Elevated Production of Secondary Metabolites in Medicinal Plant Cell Cultures	189
9.3.1	Cell Culture Media Components	189
9.3.2	Elicitors and Jasmonates	191
9.3.3	Exogenous Substances	192
9.3.4	Immobilization	193
9.3.5	Physical Stress	193
9.4	Enhancement of Secondary Metabolite Production through <i>Agrobacterium rhizogenes</i> Transformation	194
9.5	Metabolite Engineering of Medicinal Plants in Culture	195
9.6	Large-Scale Production of Medicinal Secondary Metabolites in Bioreactor Systems	197
9.7	Summary and Perspective	198
	References	199
<b>10</b>	<b>Impact of Whole-Genome and Expressed Sequence Tag Databases on the Study of Plant Secondary Metabolism</b>	<b>203</b>
	<i>Jillian M. Hagel, Jonathan E. Page, and Peter J. Facchini</i>	
10.1	Introduction	203
10.2	Whole-Genome Sequences	204

10.3	Expressed Sequence Tags	207
10.4	Terpenoids	209
10.5	Phenylpropanoids	215
10.6	Alkaloids	219
10.7	Conclusion	225
	Acknowledgments	225
	References	225
<b>11</b>	<b>Biotechnology of Solanaceae Alkaloids: A Model or an Industrial Perspective?</b>	<b>237</b>
	<i>Birgit Dräger</i>	
11.1	Culture Systems	239
11.1.1	The Early Days of Solanaceae Culture	239
11.1.2	Hairy Roots	240
11.1.3	Further Culture Systems	242
11.2	Alkaloid Production	244
11.2.1	Choice of the Best Culture System	244
11.2.2	Optimization Strategies	244
11.2.2.1	Large-Scale Culture, Light, and Aeration	245
11.2.2.2	Feeding of Alkaloid Precursors	246
11.2.2.3	Nutrient Medium Variation	246
11.2.2.4	Elicitation	247
11.3	Alkaloid Biosynthesis	251
11.3.1	Tropane Alkaloid Metabolites, Enzymes and Products	251
11.3.2	Putrescine N-methyltransferase (PMT)	252
11.3.3	Tropinone Reductases	253
11.3.4	Hyoscyamine-6 $\beta$ -Hydroxylase	254
11.4	Solanaceae Model Systems for Transformation and Overexpression	255
11.5	Conclusion and Future Aspects	257
11.5.1	More Genes and Enzymes	257
11.5.2	Compartmentation, Transport, and Excretion	258
	Acknowledgment	259
	References	259

## Volume II

<b>12</b>	<b>Plant Cell Cultures: Production of Biologically Important Secondary Metabolites from Medicinal Plants of Taiwan</b>	<b>267</b>
	<i>Mulabagal Vanisree and Hsin-Sheng Tsay</i>	
	Abstract	267
12.1	Introduction	267
12.2	Cell Culture Protocols for Biologically Important Secondary Metabolites	269



- 12.2.1 Production of Imperatorin from *Angelica dahurica* var. *formosana* 270
- 12.2.2 Production and Analysis of Corydaline and Tetrahydropalmatine from *Corydalis yanhusuo* 272
- 12.2.3 Identification of Alkyl Ferulates in Micropropagated Plants of *Dendrobium tosaense* MAKINO 273
- 12.2.4 Production of Diosgenin from *Dioscorea doryophora* by Cell Suspension Cultures 274
- 12.2.5 Establishment of *Gentiana davidii* var. *formosana* (Hayata) T. N. Ho Cell Suspension Cultures 275
- 12.2.6 Quantitative Analysis of Anthraquinones Emodin and Physcion formed in *In-Vitro*-Propagated Shoots and Plants of *Polygonum multiflorum* 276
- 12.2.7 Production of Cryptotanshinone from Callus Cultures of *Salvia miltiorrhiza* Bunge 278
- 12.2.8 Harpagoside Production in Micropropagated Plants of *Scrophularia yoshimurae* Yamazaki 279
- 12.2.9 Production of Anthocyanins in Callus Cultures of *Solanum melongena* 280
- 12.2.10 Taxol Synthesis in Cell Suspension Cultures of *Taxus mairei* 281
- 12.3 Conclusions and Future Perspectives 281
- References 282

### 13 Exploring and Accessing Plant Natural Product Biosynthesis in Engineered Microbial Hosts 287

*Erin K. Marasco and Claudia Schmidt-Dannert*

- 13.1 Introduction 287
- 13.2 Heterologous Expression of Plant Natural Product Genes and Pathways 288
- 13.3 Alkaloids 290
  - 13.3.1 Monoterpenoid Indole Alkaloids 290
  - 13.3.2 Benzoisoquinoline Alkaloids 293
- 13.4 Isoprenoids 296
  - 13.4.1 Sesquiterpenes and Diterpenes 297
  - 13.4.2 Taxol 299
  - 13.4.3 Artemisinin 301
  - 13.4.4 Carotenoids 302
- 13.5 Flavonoids 304
- 13.6 Conclusions 308
- References 309

### 14 Production of Therapeutic Antibodies in Plants 319

*Richard M. Twyman, Stefan Schillberg, and Rainer Fischer*

- 14.1 Introduction 319
- 14.2 The Evolution of Recombinant Antibody Technology 321
  - 14.2.1 The Importance of Recombinant Antibodies 321

14.2.2	Structure of Naturally Produced Antibodies	321
14.2.3	Antibody Derivatives	322
14.2.4	Humanized Antibodies	323
14.3	Production of Recombinant Antibodies in Plants	323
14.3.1	Traditional Expression Systems	323
14.3.2	The Advantages of Plants	324
14.3.3	Limitations that Need to be Addressed	325
14.4	Current Objectives in the Field	326
14.4.1	Economic Considerations	326
14.4.2	Choice of Plant Species and Platform for Antibody Production	327
14.4.3	Product Yields: Strategies to Enhance Transgene Expression and Protein Accumulation	330
14.4.4	Protein Folding, Assembly, and Glycosylation	332
14.4.5	Biosafety Concerns	333
14.5	Plant-Derived Antibodies in Clinical Trials	336
14.6	Regulatory Considerations	337
14.6.1	Downstream Processing	337
14.6.2	Regulation of Plant-Based Production	338
14.7	Summary	338
	References	339
<b>15</b>	<b>Glycosylation of Recombinant Proteins in Plants</b>	<b>345</b>
	<i>Gilbert Gorr and Friedrich Altmann</i>	
15.1	Introduction	345
15.2	A Word on Names	346
15.3	General Aspects of Glycosylation	346
15.3.1	Asn-Linked Oligosaccharides (N-Glycans)	346
15.3.2	Mucin-Type and Other O-Linked Glycans (O-Glycan)	352
15.3.3	Hydroxyproline-Linked Oligosaccharides (Hyp-O-Glycans)	352
15.4	Why Antibodies?	354
15.5	“Humanization” of N-Glycans in Plants	356
15.5.1	Authentic or Human-Like Glycosylation as the Benchmark	356
15.5.2	Towards a Humanized N-Glycosylation in Plants	359
15.5.3	Improving Antibodies by Glycoengineering	361
15.6	Trust is Good, Control is Better: A Structural Analysis	362
15.7	Conclusions and Outlook	365
	References	365
<b>16</b>	<b>Frontiers in Transgenic Medicinal Plants Research</b>	<b>375</b>
	<i>Ya’akov Tadmor and Efraim Lewinsohn</i>	
16.1	Introduction	375
16.1.1	Biosynthesis: Active Principles in Medicinal Plants	378
16.1.2	Identification of the Biosynthetic Pathways	379
16.2	Sources of Key Genes that Affect the Biosynthesis of Plant Natural Products	380

16.3	Genomic Approaches Applied to Medicinal Plants Research	383
16.4	Generation of Transgenic Medicinal Plants	385
16.5	Metabolically Engineered Medicinal Plants	387
16.5.1	Alkaloids	387
16.5.1.1	Amino Alkaloids	387
16.5.1.2	Terpenoid Indole Alkaloids	387
16.5.1.3	Tropane Alkaloids: Hyoscyamine and Scopolamine	388
16.5.1.4	Isoquinoline Alkaloids: Morphine, Codeine, and Thebaine	388
16.5.2	Metabolic Engineering of the Terpenoid Pathway	388
16.5.2.1	Monoterpenes	388
16.5.2.2	Sesquiterpenes	389
16.5.3	Cannabinoids	390
16.6	Conclusions	390
	References	391

### **Part 3 Plants as Drug Factories** 397

<b>17</b>	<b>Intellectual Property Protection of Plant Biotechnology</b>	399
	<i>Konrad Sechley and Clare Salisbury</i>	
17.1	Introduction	399
17.1.1	Utility Patents	400
17.1.2	Trade-Related Aspects of Intellectual Property Rights (TRIPS)	401
17.1.3	Plant Variety Protection	401
17.1.4	Genetic Resources	403
17.2	Protection of Plant Biotechnology in Europe	404
17.2.1	Patent Protection: European Patent Convention (EPC)	404
17.2.2	Biotechnology Directive	407
17.2.3	Ethics of Patenting Plant Biotechnology	408
17.3	North America	409
17.3.1	US Plant Patent	409
17.3.2	Utility Patents	410
17.3.2.1	USA	410
17.3.2.2	Canada	411
17.4	Conclusion	413
	References	414
<b>18</b>	<b>Breeding of Medicinal Plants</b>	417
	<i>Friedrich Pank</i>	
18.1	Introduction	417
18.2	Demands on MAP Cultivars	418
18.3	Specifics of MAP Breeding	419
18.4	Genetic Resources	420
18.5	Breeding Methods	420
18.5.1	Utilization of Available Natural Diversity	420

18.5.2	Generation of New Variability	421
18.5.2.1	Combination Breeding by Crossing	422
18.5.2.2	Hybrid Breeding	423
18.5.2.3	Synthetic Cultivars	425
18.5.2.4	Induced Mutation	426
18.5.2.5	Somaclonal Variation	426
18.5.2.6	Somatic Hybridization (Protoplast Fusion)	426
18.5.2.7	Molecular Gene Transfer	427
18.5.3	Selection	428
18.5.3.1	Positive and Negative Mass Selection	428
18.5.3.2	Recurrent Selection	429
18.5.3.3	Individual Selection with Progeny Testing	429
18.5.3.4	Breeding in Apomicts	430
18.5.3.5	Clonal Breeding	432
18.6	Improvement of Selection Response by Specific Techniques	433
18.6.1	Accelerating the Succession of Generations	433
18.6.2	Early Selection	437
18.6.3	Doubled Haploids	438
18.6.4	Determination of Characteristics	438
18.6.4.1	Markers	438
18.6.4.2	Rapid Analytical Methods	439
18.6.4.3	Spectrophotometric Color Measurement	441
18.6.4.4	Breeding for Resistance to Pests and Diseases	442
18.6.4.5	Bioassay	443
18.7	Outlook	444
	References	445

## 19 **Camptothecin Production in Cell Cultures of *Ophiorrhiza* Species** 451

*Takashi Asano, Hiroshi Sudo, Mami Yamazaki, and Kazuki Saito*

19.1	Introduction	451
19.2	Tissue Cultures	452
19.2.1	Establishment of Tissue Cultures	452
19.2.1.1	Aseptic Plants	453
19.2.1.2	Hairy Roots	454
19.2.2	Camptothecin Production and Metabolite Profiles	454
19.2.3	Excretion of Camptothecin into the Culture Medium	457
19.2.4	Camptothecin Production in Bioreactors	457
19.2.5	Regeneration of Transformed Plants from Hairy Roots	459
19.3	Camptothecin Biosynthesis Studies with <i>O. pumila</i> Hairy Root	460
19.3.1	Camptothecin Biosynthetic Genes	460
19.3.1.1	Strictosidine Synthase (OpSTR)	461
19.3.1.2	Tryptophan Decarboxylase (OpTDC)	462
19.3.1.3	NADPH:cytochrome P450 Reductase (OpCPR)	462
19.3.2	<i>In-Silico</i> and <i>In-Vitro</i> Tracer Study from [1- <sup>13</sup> C]glucose	462

19.4	Summary and Conclusions	462
	Acknowledgments	463
	References	464
<b>20</b>	<b>Plant Biochemistry and Biotechnology of Flavor Compounds and Essential Oils</b>	<b>469</b>
	<i>Dinesh A. Nagegowda and Natalia Dudareva</i>	
20.1	Introduction	469
20.2	Biosynthesis of Flavors/Essential Oils	471
20.2.1	Terpenoids	471
20.2.1.1	Monoterpenes	473
20.2.1.2	Sesquiterpenes	474
20.2.2	Phenylpropanoids	475
20.3	Regulation of Essential Oil Accumulation	477
20.4	Practical Applications	478
20.5	Metabolic Engineering	481
20.6	Conclusions	483
	Acknowledgments	483
	References	483
<b>21</b>	<b><i>Ginkgo biloba</i> and Production of Secondary Metabolites</b>	<b>493</b>
	<i>Christine Sohier and Didier Courtois</i>	
21.1	Introduction	493
21.1.1	The <i>Ginkgo biloba</i> Tree	494
21.1.2	Terpenes and Flavonoids	494
21.2	Biosynthesis and Accumulation of Ginkgolides and Bilobalide	496
21.2.1	Terpene Content and Localization of Biosynthesis	496
21.2.2	Biosynthetic Pathway	498
21.3	Biosynthesis of Flavonoids	500
21.3.1	Variations in Flavonoid Content	500
21.3.2	Flavonoid Metabolic Pathway	500
21.4	Selection of Plants for Terpene Content and Propagation	501
21.4.1	Selection	501
21.4.2	Techniques of Micropropagation	502
21.4.3	Somatic Embryogenesis	502
20.5	Tissue cultures	503
21.5.1	Terpene Biosynthesis and Accumulation	503
21.5.2	Flavonoids Biosynthesis and Accumulation	504
21.5.3	4'-O-Methylpyridoxine (Ginkgotoxin) Biosynthesis and Accumulation	505
21.5.4	Biotransformation	505
21.5.5	Cryopreservation of Plant Cell Materials	505
21.6	Genetic Transformation and Organ Cultures	506
21.7	Conclusions	506
	References	507

<b>22</b>	<b>Production of Paclitaxel in Plant Cell Cultures</b>	<b>515</b>
	<i>Homare Tabata</i>	
	Abstract	515
22.1	Introduction	515
22.2	Plant Cell Culture Technology for Paclitaxel Production	516
22.3	Paclitaxel Biosynthetic Pathway and Related Genes	517
22.4	Genetic Modification of Taxus Cells	522
22.5	Future Technology for the Production of Useful Compounds	523
	Acknowledgments	524
	References	524
<b>23</b>	<b>Biological Production of Artemisinin for Malaria Therapy</b>	<b>529</b>
	<i>Yan Zhao and Chunzhao Liu</i>	
23.1	Introduction	529
23.2	The Biosynthesis of Artemisinin	530
23.3	The Biological Production of Artemisinin	531
23.3.1	Artemisinin Production by Plants	531
23.3.2	Artemisinin Production by Microorganisms	535
23.3.3	Artemisinin Production in Bioreactors	536
23.3.3.1	Production of Artemisinin from <i>A. annua</i> L. Shoots in a Nutrient Mist Bioreactor	537
23.4	Outlook	539
	References	540
	<b>Subject Index</b>	<b>543</b>

## Preface

Medicinal plant biotechnology is a discipline that should be well known and accepted as a sub field under the umbrella of pharmaceutical biotechnology. However, to our surprise we could not identify any recent contribution dealing with medicinal plants and biotechnological techniques on a high comprehensive level that the subject would deserve today. We accepted this lack as a challenge to sort out the needs of the scientific community and to identify valuable topics that must be addressed in order to provide a narrow and well-defined picture of medicinal plant biotechnology.

We identified several experts in the fields of pharmaceutical biology, biotechnology, biochemistry and genetics who were willing to spend their precious time to share their knowledge with us. Many thanks here from the editors, as without the enthusiasm, efforts, and patience of these experts this book would not have been possible.

Biotechnology in general is a fast-moving area, and this development can be recognized in our field of pharmaceutical biotechnology. In this book we have focused on medicinal plants, and have attempted to structure the latest developments into three parts. In Part I, the actual status of medicinal pharmaceutical biotechnology and the cell as a producing unit are outlined. Here, the major questions are: How do medicinal plants and biotechnology fit together, and how must we understand the plant cell as a “biofactory” that can be used in an integrative drug discovery process? It should be mentioned that endophytes as plant-related microorganisms are discussed in Part I because of the upcoming interest in this new genetic and natural product source for the future. Today, although research into endophytes is very much in its early stages, the first reports on the possibilities to use them to produce formerly plant-originated compounds make this group of organisms interesting for both academia and industry.

Whilst academic and industrial needs are different, all authors were able to provide answers for these groups, both of which are confronted with new challenges such as metabolomics, high-throughput screening, and the application of the latest recombinant DNA technologies. Whether these techniques will be transferred successfully into industrial applications is not clear, but the authors in Part I provide an outlook into this exciting future of pharmaceutical biotechnology.

In Part II, we go a step further from the well-organized cell to the nanocosmos, with special focus on genetics and molecular biology. In this part of the book, strategies are discussed to accelerate the drug discovery process based on genetic techniques such as micropropagation, combinatorial biosynthesis, and expressed sequence tag databases. Considerable attention has been paid to optimize the production of natural products of pharmaceutical relevance in cell cultures, and how production can be scaled up in bioreactors. Combinatorial biosynthesis and ways to modify physiologic traits by constructing transgenic plants will provide an idea of future techniques in natural product production. Some of these products are in the later stages of development, and we hope that we might be able to read about them in the next updated edition of this book, in Part III.

Part III deals with the future directions of medicinal plant biotechnology and examines its practical applications in industry. Authors from industry provide insight into their own production facilities, and discuss the problems and limitations. Progress here has, however, been slower than with medical and other areas of research. Because plants are genetically and physiologically more complex than single-cell organisms such as bacteria and yeasts, the necessary technologies in industrial business are developing more slowly. However, exploring ways to use genetic modification better will definitely influence this area, and therefore we must accept that our attempt to structure the latest developments was only an *attempt*, and that medicinal plant biotechnology must be considered as a complex and integrative discipline.

Our special thanks go to Steffen Pauly and others of the Wiley-VCH publishing team for their professionalism, continuous encouragement and support, which we enjoyed not for the first time in our sustainable relationship.

Special thanks also to the families of both the editors and the authors for their patience and understanding why time was spent on this project, and why they had to tolerate extended periods of negligence. We are not so naïve to believe that dedicating this book to them will compensate the missed time, but it might be a start!

We have no doubt that this book is far from complete and that some areas of interest were not touched and will have to be discussed in the future, in updated editions. However, we are convinced that we were able to provide a good “primer” to start working in medicinal biotechnology and to show how exciting the combination of medicinal plants and biotechnology can be.

*Oliver Kayser*  
*Wim J. Quax*

*Groningen, September 2006*



## Foreword

It is a pleasure for me to write the foreword to this unusual and excellent book on the engineering of medicinal plants! This collection of relevant articles provides a comprehensive overview of the *status quo* of gene technology and plant biotechnology with medicinal plants. The focus is twofold. First, it not only presents a comprehensive overview on the use of medicinal plants in the pharmaceutical industry and their engineering to increase yields of small molecule drugs, but also highlights the challenges to patient and consumer acceptance that surround the use of these genetically modified plants as a source of extract preparation and manufacturing.

Second, the book deals with progress made to date in engineering plants as expression hosts used to produce biopharmaceuticals – that is, protein-based drugs for human use from genetically modified plants. This topic is of utmost importance, as biopharmaceuticals are currently the mainstay products of the biotechnology market and represent the fastest-growing and, in many ways, the most exciting sector within the pharmaceutical industry.

The term “biopharmaceutical” was coined during the 1980s, when a general consensus evolved that it represented a class of therapeutics produced by means of modern biotechnologies. The recombinant DNA technology of Cohen and Boyer enabled them, in 1978, to generate the first commercial product: human insulin expressed in *E. coli*. These efforts also led to the first biotech company: on October 14th, 1980 “Genentech” went public on New York Wall Street stock exchange. Fascination about this modern biopharmaceutical and the huge potential of the new biotechnology made the stock price jump from 35 to 89 US\$ in the first 20 minutes: by the evening of the same day, the market capitalization was 66 million US\$!

Since then, the market for biopharmaceuticals has steadily grown, and currently almost 150 biopharmaceuticals have gained approval for general human use (EU and USA). Over this period it became clear that production capacities for biopharmaceuticals with “conventional” bioreactors would be a bottleneck, and that worldwide fermentation capacities are limited. One exciting solution to these “capacity crunches” is the use of transgenic plants to produce biopharmaceuticals.

Basically this highly innovative, but relatively new approach, is the blending of *green biotechnology* (using genetically modified plants as expression hosts) and *red biotechnology* (the biotechnological production of pharmaceuticals).

The towering German writer and natural scientist Johann Wolfgang Goethe (1749–1832) was doing research on the blending of colors as published in his scientific treatise “*Farbenlehre*” and also the English scientist and mathematician Sir Isaac Newton (1642–1727) developed a tool for color mixing, the “*color wheel*”. Light can be split up into a spectrum by sending it through a prism, and everybody admires probably the most exciting atmospheric phenomenon: rainbows caused by refraction of sunlight in raindrops. In a rainbow we see the continuous range of spectral colors and the color theory is basically a convenient tool for predicting the results of simply mixing these colors. According to that, additive color mixing of red and green is yellow, and by blocking the sunlight, the shade of the color yellow is gold – a pot of gold at the end of the biotechnology rainbow. As a homage to these brilliant scientists I would call the blending of *green* and *red biotechnology* “*Golden Biotech*”.

One important example (although not a pharmaceutical overexpressed in a plant for isolating the drug), is Golden Rice: a transgenic rice with increased content of pro-vitamin A ( $\beta$ -carotene) – and thus its nutritional value. The name stems from its *real* golden color, and the shiny effect is due to the high  $\beta$ -carotene content. The inventors Peter Beyer and Ingo Potrykus † were awarded the prestigious *nature biotech award* early 2006, “for a potential solution to eliminate the largescale vitamin A deficiency existing among the poor in countries such as India and to fight against blindness (at the beginning of the 21st century, 124 million people were estimated to be affected by vitamin A deficiency, which is responsible for 2 million deaths, and 500,000 cases of irreversible blindness annually.)”

This book nicely describes different approaches of *pink biotechnology*, its application for plant expression systems, and their advantages and limitations, and concludes by considering some of the innovations and trends likely to influence the future of engineering of medicinal plants.

Plants are by far the most abundant and cost-effective renewable resource uniquely adapted to complex biochemical synthesis. The increasing cost of energy and chemical raw materials, combined with the environmental concerns associated with conventional pharmaceutical manufacturing, will make plants even more compatible in the future. With the words of Max Planck (1858–1947) “How far advanced Man’s scientific knowledge may be, when confronted with Nature’s immeasurable richness and capacity for constant renewal, he will be like a marveling child and must always be prepared for new surprises,” we will definitely discover more fascinating features of plant expression systems. But there is no need to wait: combining the advantages of some technologies that we have in hand by now could already lead to the ultimate plant expression system. This is what we should focus on, because, then, at the dawn of this new millennium, this would for the first time yield large-enough amounts of biopharmaceuticals to treat everybody on our planet!

An unusual feature of *Medicinal Plant Biotechnology* is that, for a book with so many facts, it is a delight to read. While easy to read, it is a guide to both, broad surveys and key papers, which are provided in convenient, but at the same time comprehensive reference lists.

I am convinced that the editors have done a great job in compiling a cutting-edge and comprehensive book on the current status of the use of medicinal plants, its genetically modifications and implications thereof. I wish this book a numerous and broad readership, and I encourage all readers to enjoy this collection of interesting contributions from scientists from academia and industry.

*Jörg Knäblein*

*Head Microbiological Chemistry, Schering AG  
Scientific Advisor and Board Member European Association of Pharma Biotech*

*Berlin, June 2006*

## List of Contributors

Friedrich Altmann  
Institute of Chemistry  
University of Natural Resources and  
Applied Life Sciences  
Muthgasse 18  
1190 Vienna  
Austria

Takashi Asano  
Graduate School of Pharmaceutical  
Sciences  
Chiba University  
Yayoi-cho 1-33, Inage-ku  
Chiba 263-8522  
Japan

Ashish Baldi  
Department of Biochemical  
Engineering and Biotechnology  
Indian Institute of Technology – Delhi  
Hauz Khas  
New Delhi 110016  
India

V.S. Bisaria  
Department of Biochemical  
Engineering and Biotechnology  
Indian Institute of Technology – Delhi  
Hauz Khas  
New Delhi 110016  
India

Donald P. Briskin  
Departments of Natural Resources and  
Plant Biology  
University of Illinois  
1101 West Peabody Drive  
Urbana, IL 61801  
USA

Young Hae Choi  
Department of Pharmacognosy  
Section Metabolomics, IBL  
Leiden University  
PO Box 9502  
2300 RA Leiden  
The Netherlands

Didier Courtois  
Centre R & D Nestlé Tours  
101, Avenue Gustave Eiffel  
37097 Tours cedex 2  
France

Birgit Dräger  
Institute of Pharmacy  
Martin-Luther University  
Halle-Wittenberg  
Hoher Weg 8  
06120 Halle/Saale  
Germany

Natalia Dudareva  
Department of Horticulture and  
Landscape Architecture  
Purdue University  
West Lafayette, IN 47907  
USA

Peter J. Facchini  
Department of Biological Sciences  
University of Calgary  
2500 University Drive N.W.  
Calgary, Alberta, T2N 1N4  
Canada

Rainer Fischer  
Fraunhofer Institute for Molecular  
Biology and Applied Ecology  
Forckenbckstr. 6  
52074 Aachen  
Germany

Gilbert Gorr  
greenovation Biotech GmbH  
Boetzing Str. 29 b  
79111 Freiburg  
Germany

Jillian M. Hagel  
Department of Biological Sciences  
University of Calgary  
2500 University Drive N.W.  
Calgary, Alberta, T2N 1N4  
Canada

Jerzy W. Jaroszewski  
Department of Medicinal Chemistry  
The Danish University of  
Pharmaceutical Sciences  
Universitetsparken 2  
2100 Copenhagen  
Denmark

Matthys K. Julsing  
Pharmaceutical Biology  
University of Groningen  
A. Deusinglaan 1  
9713 AV Groningen  
The Netherlands

Oliver Kayser  
Pharmaceutical Biology  
University of Groningen  
A. Deusinglaan 1  
9713 AV Groningen  
The Netherlands

Hye Kyong Kim  
Department of Pharmacognosy  
Section Metabolomics, IBL  
Leiden University  
PO Box 9502  
2300 RA Leiden  
The Netherlands

Wolfgang Kreis  
Institute for Biology  
Friedrich-Alexander University  
Erlangen-Nürnberg  
Staudtstr. 5  
91058 Erlangen  
Germany

Maja Lambert  
Department of Medicinal Chemistry  
The Danish University of  
Pharmaceutical Sciences  
Universitetsparken 2  
2100 Copenhagen  
Denmark

Efraim Lewinsohn  
Department of Vegetable Crops  
Newe Yaar Research Center  
Agricultural Research Organization  
30095 Ramat Yishay  
Israel

Chunzhao Liu  
National Key Laboratory of  
Biochemical Engineering  
Institute of Process Engineering  
Chinese Academy of Sciences  
1 Zhongguancun Bei-er-tiao  
Beijing 100080  
China

Erin Marasco  
Department of Biochemistry  
Molecular Biology and Biophysics  
University of Minnesota  
1479 Gortner Avenue  
St. Paul, MN 55108  
USA

Dinesh A. Nagegowda  
Department of Horticulture and  
Landscape Architecture  
Purdue University  
West Lafayette, IN 47907  
USA

Hilde Nybom-Balsgard  
Department of Crop Science  
Swedish University of Agricultural  
Sciences  
Fjälkestadvägen 459  
291 94 Kristianstad  
Sweden

Jonathan E. Page  
National Research Council of Canada  
Plant Biotechnology Institute  
110 Gymnasium Place  
Saskatoon, Saskatchewan, S7N 0W9  
Canada

Friedrich Pank  
Institute of Horticultural Crops  
Federal Centre of Breeding Research  
on Cultivated Plants  
Neuer Weg 22/23  
06484 Quedlinburg  
Germany

Wim J. Quax  
Pharmaceutical Biology  
University of Groningen  
A. Deusinglaan 1  
9713 AV Groningen  
The Netherlands

Kazuki Saito  
Graduate School of Pharmaceutical  
Sciences  
Chiba University  
Yayoi-cho 1-33, Inage-ku  
Chiba 263-8522  
Japan

Clare Salisbury  
Gowling Lafleur Henderson LLP  
Suite 2300, Four Bentall Center  
1055 Dunsmuir Street  
Vancouver BC V7X 1J1  
Canada

Stefan Schillberg  
Fraunhofer Institute for Molecular  
Biology and Applied Ecology  
Forckenbeckstr. 6  
52074 Aachen  
Germany

Claudia Schmidt-Dannert  
Department of Biochemistry  
Molecular Biology and Biophysics  
University of Minnesota  
1479 Gortner Avenue  
St. Paul, MN 55108  
USA

Konrad Sechley  
Gowling Lafleur Henderson LLP  
Suite 2300, Four Bentall Centre  
1055 Dunsmuir St.  
Vancouver, BC V7X 1J1  
Canada

Christine Sohier  
Institut Henri Beaufour –  
Groupe IPSEN  
c/o Centre R & D Nestlé Tours  
101, Avenue Gustave Eiffel  
37097 Tours cedex 2  
France

A.K. Srivastava  
Department of Biochemical  
Engineering and Biotechnology  
Indian Institute of Technology – Delhi  
Hauz Khas  
New Delhi 110016  
India

Dan Stærk  
Department of Medicinal Chemistry  
The Danish University of  
Pharmaceutical Sciences  
Universitetsparken 2  
2100 Copenhagen  
Denmark

Gary Strobel  
Department of Plant Sciences  
Montana State University  
Bozeman, MT 59717  
USA

Hiroshi Sudo  
Graduate School of Pharmaceutical  
Sciences  
Chiba University  
Yayoi-cho 1-33, Inage-ku  
Chiba 263-8522  
Japan

Homare Tabata  
Plnt Cell Culture R & D Center  
Hokkaido Mitsui Chemicals, Inc.  
1, Toyonuma, Sunagawa-shi  
Hokkaido 073-0138  
Japan

Ya'akov Tadmor  
Department of Vegetable Crops  
Newe Yaar Research Center  
Agricultural Research Organization  
PO Box 1021  
Ramat Yishay 30095  
Israel

Hsin-Sheng Tsay  
Institute of Biotechnology  
Chaoyang University of Technology,  
168, Gifong E. Road  
Wufong  
Taichung County 41349  
Taiwan

Richard M. Twyman  
Department of Biology  
University of York  
Heslington  
York, YO10 5HH  
United Kingdom

Mulabagal Vanisree  
Institute of Biotechnology  
Chaoyang University of Technology  
168, Jifong E. Road  
Wufong  
Taichung County 41349  
Taiwan

Robert Verpoorte  
Department of Pharmacognosy  
Section Metabolomics, IBL  
Leiden University  
PO Box 9502  
2300 RA Leiden  
The Netherlands

Kurt Weising  
Plant Molecular Systematics  
Institute of Biology  
University of Kassel  
34109 Kassel  
Germany

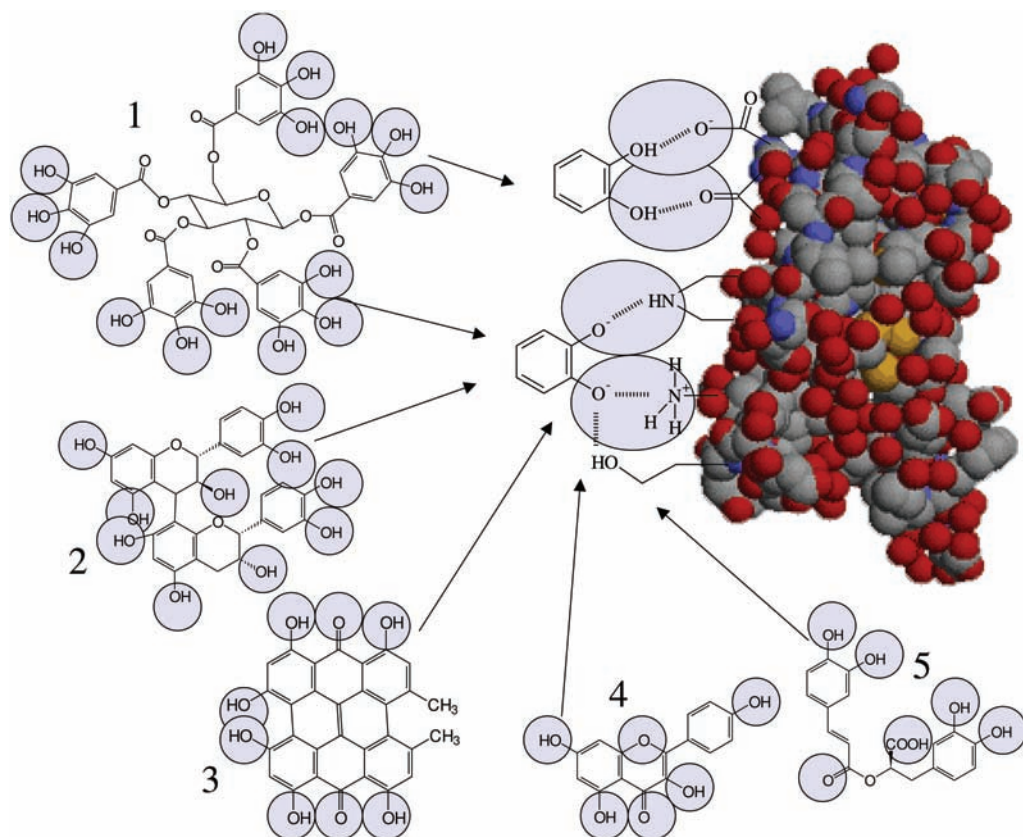
Michael Wink  
Institute of Pharmacy and Molecular  
Biotechnology (I)PMB)  
University of Heidelberg  
Im Neuenheimer Feld 364  
69120 Heidelberg  
Germany

Mami Yamazaki  
Graduate School of Pharmaceutical  
Sciences  
Chiba University  
Yayoi-cho 1-33, Inage-ku  
Chiba 263-8522  
Japan

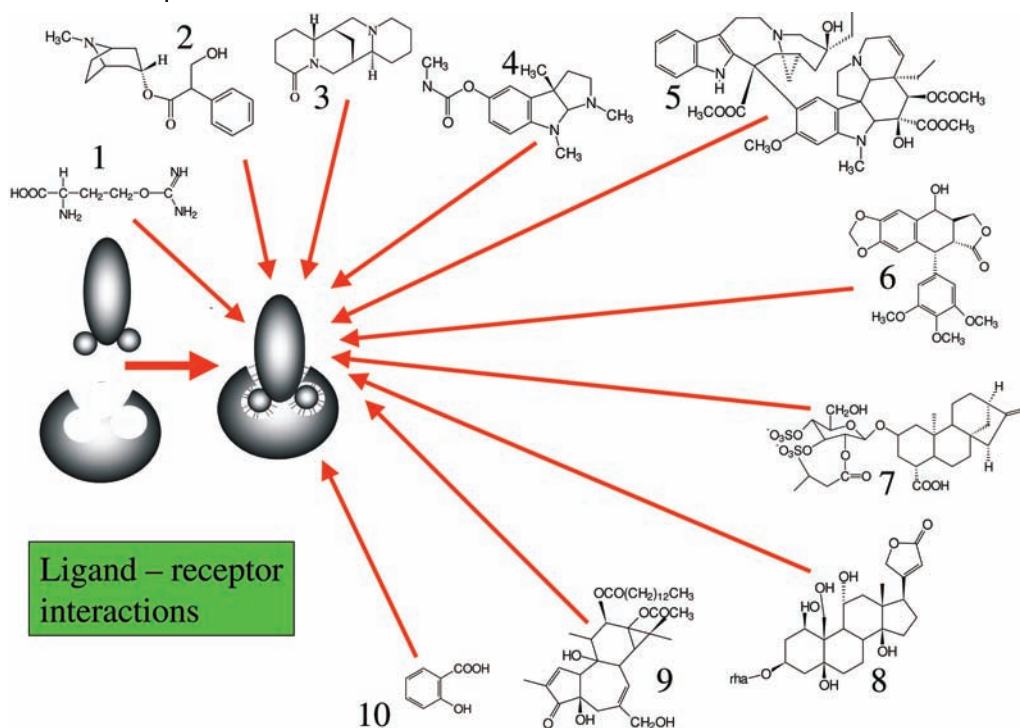
Yan Zhao  
National Key Laboratory of  
Biochemical Engineering  
Institute of Process Engineering  
Chinese Academy of Sciences  
1 Zhongguancun Bei-er-tiao  
Beijing 100080  
China



## Color Plates

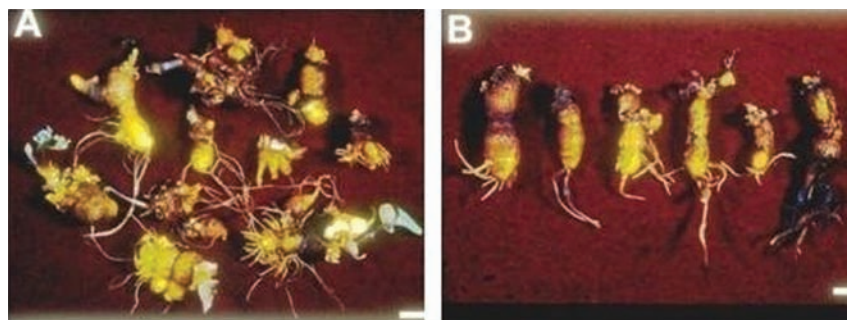


**Fig. 6.6** Noncovalent modifications of proteins by secondary metabolites. 1, Pentagalloylglucose (gallotannin). 2, Dimeric procyanidin B4 (catechol tannin). 3, Hypericine (dimeric anthraquinone). 4, Kaempferol (flavonoid). 5, Rosmarinic acid (phenylpropanoid).

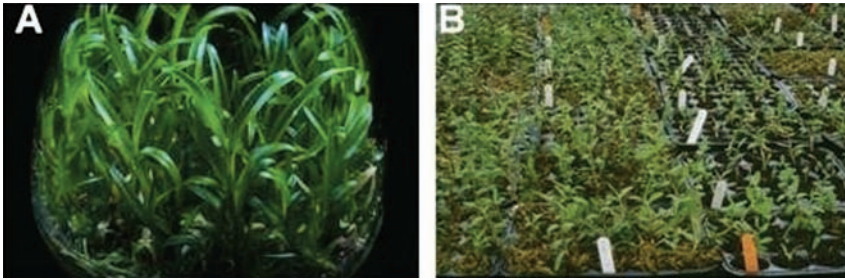


**Fig. 6.7** Specific interactions (ligand–receptor relationships) of secondary metabolites with proteins. 1, Canavanine (non-protein amino acid). 2, Hyoscyamine (tropane alkaloid). 3, Lupanine (quinolizidine alkaloid). 4, Phystostigmine (indole alkaloid). 5, Vinblastine (dimeric monoterpene indole alkaloid).

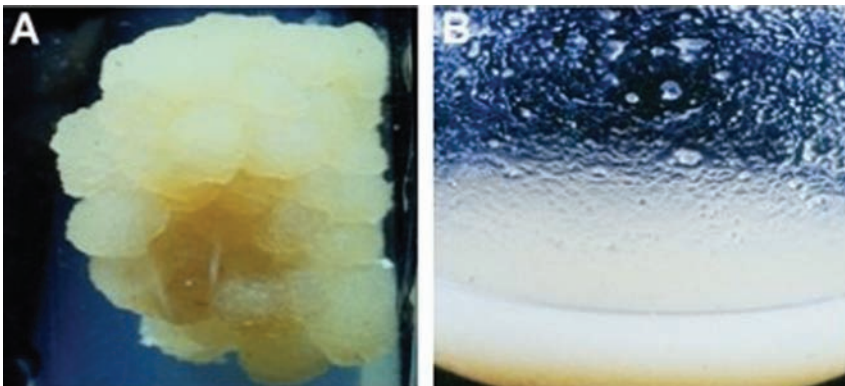
6, Podophyllotoxin (lignan). 7, Atractyloside (diterpenes). 8, Ouabain (cardiac glycoside). 9, 12-Tetradecanoyl-phorbol-13-acetate (TPA; phorbol ester). 10, Salicylic acid (phenolic acid).



**Fig. 12.1** Somatic embryo-derived tubers of *Corydalis yanhusuo* formed after 6 months of culture on: (A) half-strength MS medium supplemented with 0.1 mg L<sup>-1</sup> GA<sub>3</sub>; and (B) half-strength MS medium supplemented with 0.51 mg L<sup>-1</sup> paclobutrazol. (Scale bars: A = 9.17 mm; B = 6.31 mm.)



**Fig. 12.2** Asymbiotic seed germination and *ex-vitro* establishment of plants of *Dendrobium tosaense*. (A) Optimum seedling growth after 5 months on MS basal medium + 8% banana homogenate + 1.5% sucrose. (B) Hardened plants after 6 months in the greenhouse. (Scale bars: A = 0.82 cm; B = 6 cm.)



**Fig. 12.3** (A) Induction of *Gentiana* callus from stem segments cultured on MS basal medium with 3% sucrose,  $1 \text{ mg L}^{-1}$   $\alpha$ -naphthalene acetic acid (NAA), and  $0.2 \text{ mg L}^{-1}$  kinetin for 8 weeks. (B) Established suspension cultures from the stem-derived cells.



**Fig. 12.4** Induction and multiplication of multiple shoots in the nodal explants of *Polygonum multiflorum* Thunb. Nodal explants cultured for 6 weeks on MS basal medium with 3% sucrose, 1% Difco agar, without growth regulators. (A) With 0.2 ng L<sup>-1</sup>  $\alpha$ -naphthalene acetic acid (NAA); (B) 0.2 ng L<sup>-1</sup> NAA and 0.5 mg L<sup>-1</sup> benzyladenine (BA); (C) 0.2 ng L<sup>-1</sup> NAA and 1.0 mg L<sup>-1</sup> BA; (D) 0.2 ng L<sup>-1</sup> NAA and 2.0 mg L<sup>-1</sup> BA; (E) 0.2 ng L<sup>-1</sup> NAA and

4.0 mg L<sup>-1</sup> BA; (F) 0.2 ng L<sup>-1</sup> NAA and 8.0 mg L<sup>-1</sup> BA; (G) 0.5 ng L<sup>-1</sup> NAA and 2.0 mg L<sup>-1</sup> BA; (H) 1.0 ng L<sup>-1</sup> NAA and 2.0 mg L<sup>-1</sup> BA; (I) 2.0 ng L<sup>-1</sup> NAA and 2.0 mg L<sup>-1</sup> BA; (J) 4.0 ng L<sup>-1</sup> NAA and 2.0 mg L<sup>-1</sup> BA; (K) 8.0 ng L<sup>-1</sup> NAA and 2.0 mg L<sup>-1</sup> BA; (L) *in-vitro*-propagated plantlets transferred to autoclaved soil and grown under greenhouse conditions with high humidity, after 2 weeks (M) and after 3 months (N).



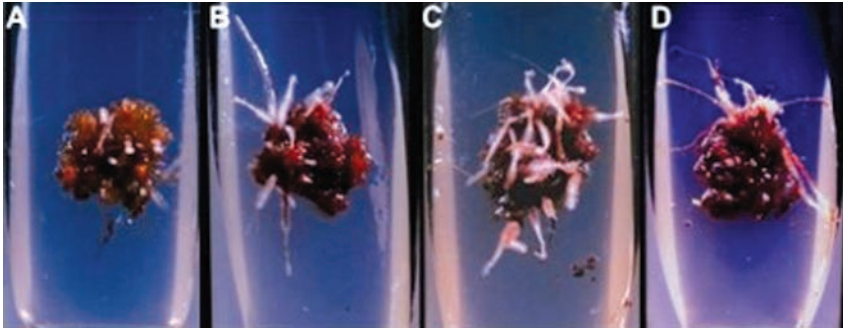


Fig. 12.5 *Salvia* callus grown on MS basal medium supplemented with  $0.2 \text{ mg L}^{-1}$  benzyladenine (BA) for periods of: (A) 8 days; (B) 16 days; (C) 24 days; and (D) 60 days.

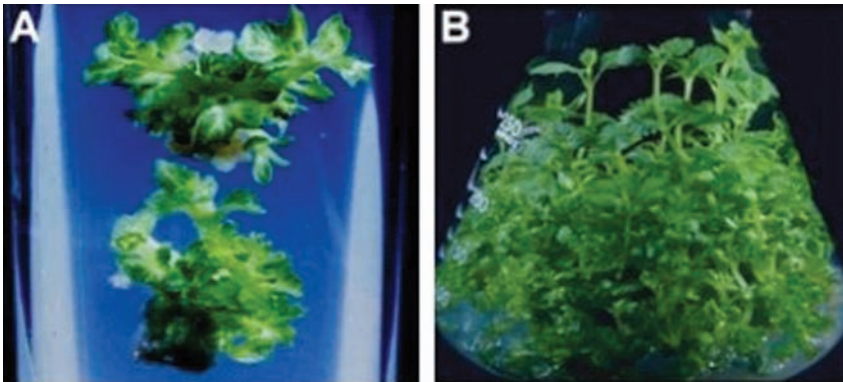


Fig. 12.6 (A) Induction of multiple shoots from the internode explants of *Scrophularia yoshimurae*. (B) Shoot proliferation from the node explants.

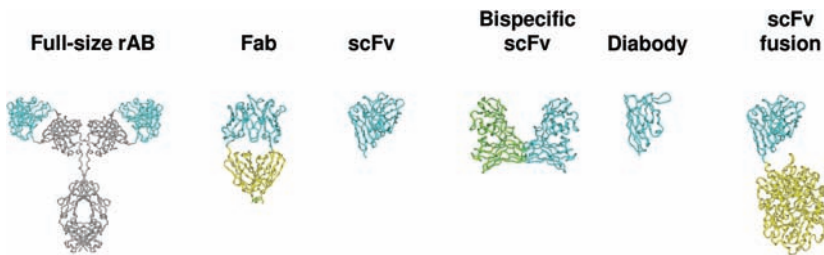
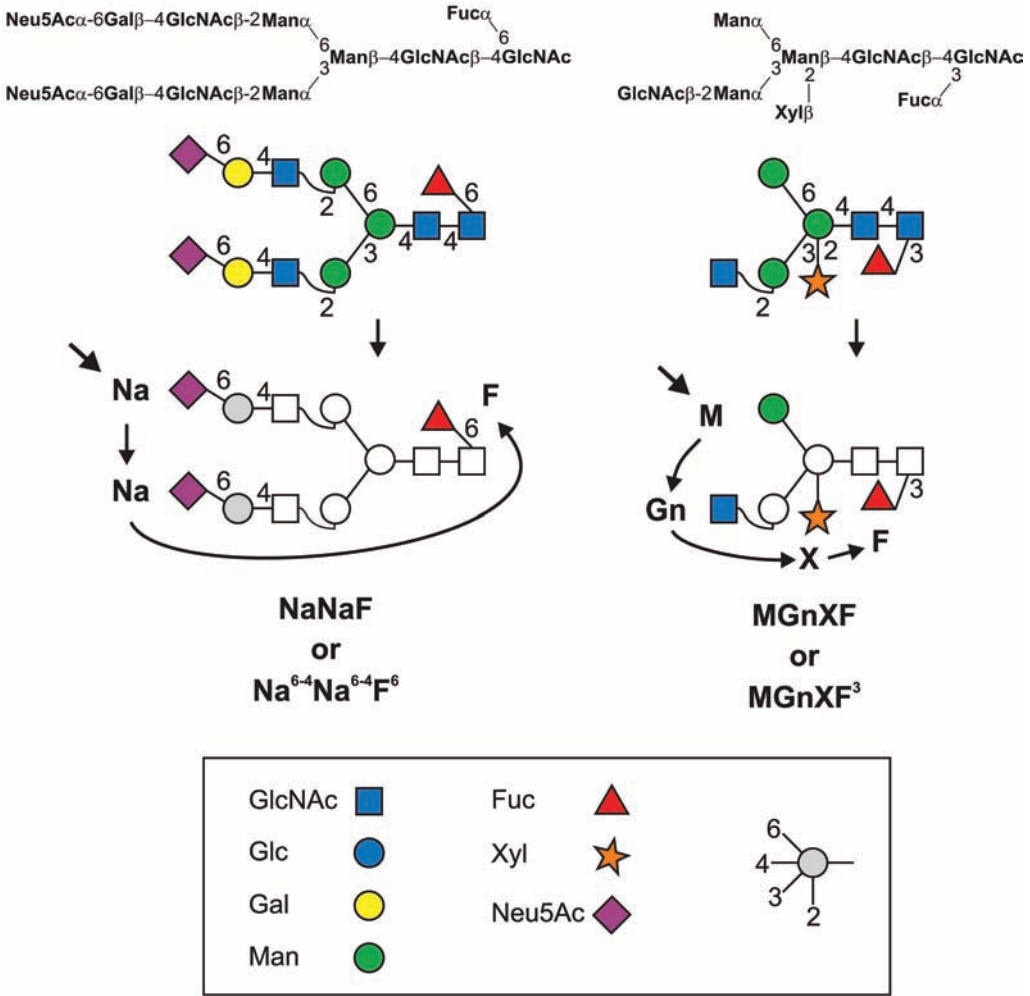
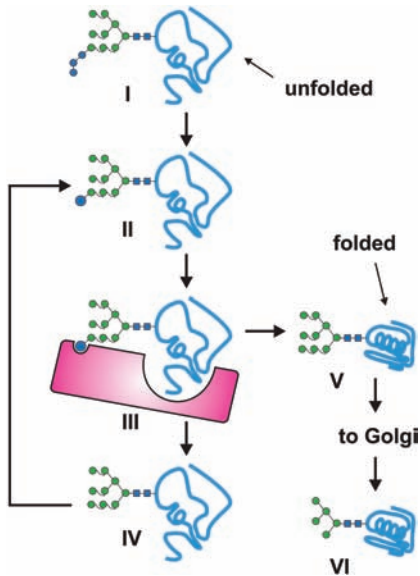


Fig. 14.1 Types of recombinant antibody expressed in plants. rAB = recombinant antibody; Fab = fragment antigen binding; scFv = single chain Fv fragment.

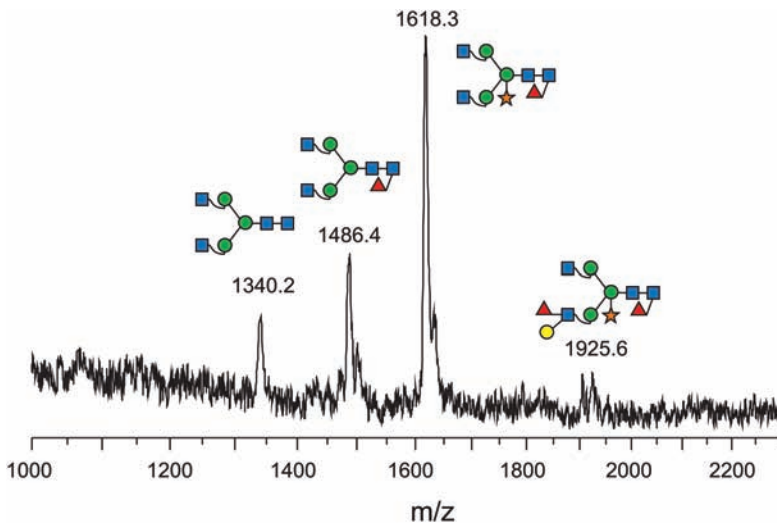


**Fig. 15.1** The “proglycan” nomenclature for N-glycans. The upper two structures depict typical mammalian and plant complex type N-glycans, respectively. In the lower drawing the non-terminal, invariable residues have been uncolored and the invariable linkages are omitted. The arrow in the upper left corner points at the residue with which the listing of

terminal sugars starts. Superscript numbers can be used to specify the linkage of sugars where alternative linkages are possible. In the case of sialylated complex type chains, the term  $\text{Na}^{5-4}$  (an abbreviation of  $\text{Na}^{\beta\text{-}5\text{-}4}$ ) means that Neu5Ac is linked  $\alpha\text{2,6}$  to a galactose which is itself in  $\beta\text{1,4}$ -linkage to the GlcNAc. (See also [www.proglycan.com](http://www.proglycan.com).)

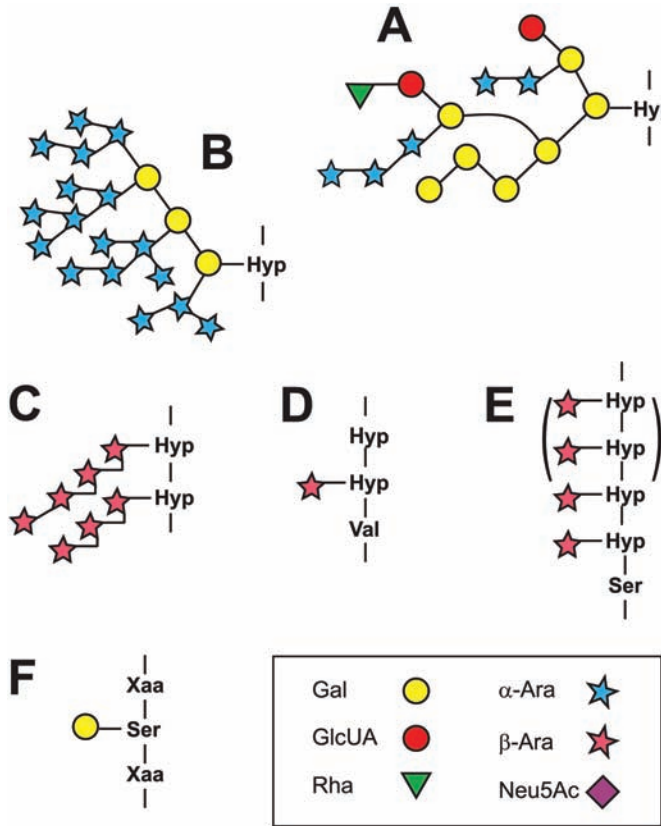


**Fig. 15.2** Folding assistance by glycosylation-dependent chaperones. The unfolded protein with a glucose residue at the non-reducing end (large blue circle) is bound and chaperoned by calnexin or calreticulin (Parodi, 1999; Helenius and Aebi, 2001). Glucosidase eventually removes this glucose residue. If the protein has still not succeeded in folding properly it is re-glycosylated by a folding-sensitive glucose-transferase. Only the correctly folded glycoprotein is allowed to proceed to the Golgi body.



**Fig. 15.4** Truly complex N-glycosylation on antibodies expressed in the moss *Physco mitrella patens*. MALDI-TOF analysis of N-glycans released from antibody expressed in a moss strain with unmodified plant-specific glycosylation. Remarkably, almost all structures are of the complex-type. While the antibody shown here still contained plant wild-type glycans with xylose and core- $\alpha$ 1,3-

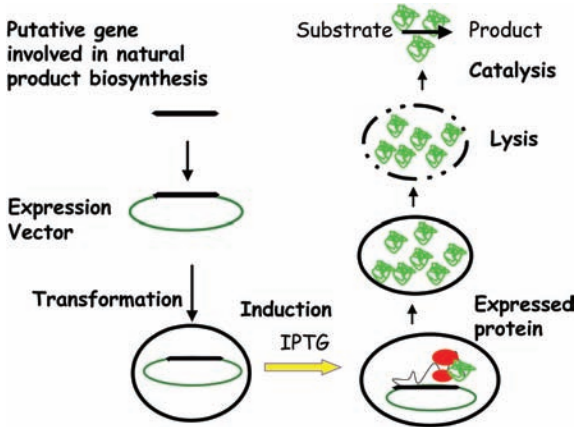
glucose residues, the production of proteins lacking these two immunogenic sugar residues has been successfully accomplished with double knock-out strains of *Physco mitrella patens* (Koprivova et al., 2004; Huether et al., 2005; Jost and Gorr, 2005; M. Schuster et al., unpublished results; A. Weise et al., unpublished results).



**Fig. 15.5** O-linked poly-, oligo- and mono-saccharides. Due to the bewildering structural heterogeneity of plant O-glycans, and to the difficulties of separating and analyzing these glycans, the figures must be taken as arbitrary selections from a large pool of related structures. Structure A depicts a (rather small) type II arabinogalactan polysaccharide with additional sugars such as rhamnose and glucuronic acid according to Tan et al. (2004). Structure B shows a type III arabinogalactan as found on a mugwort pollen allergen

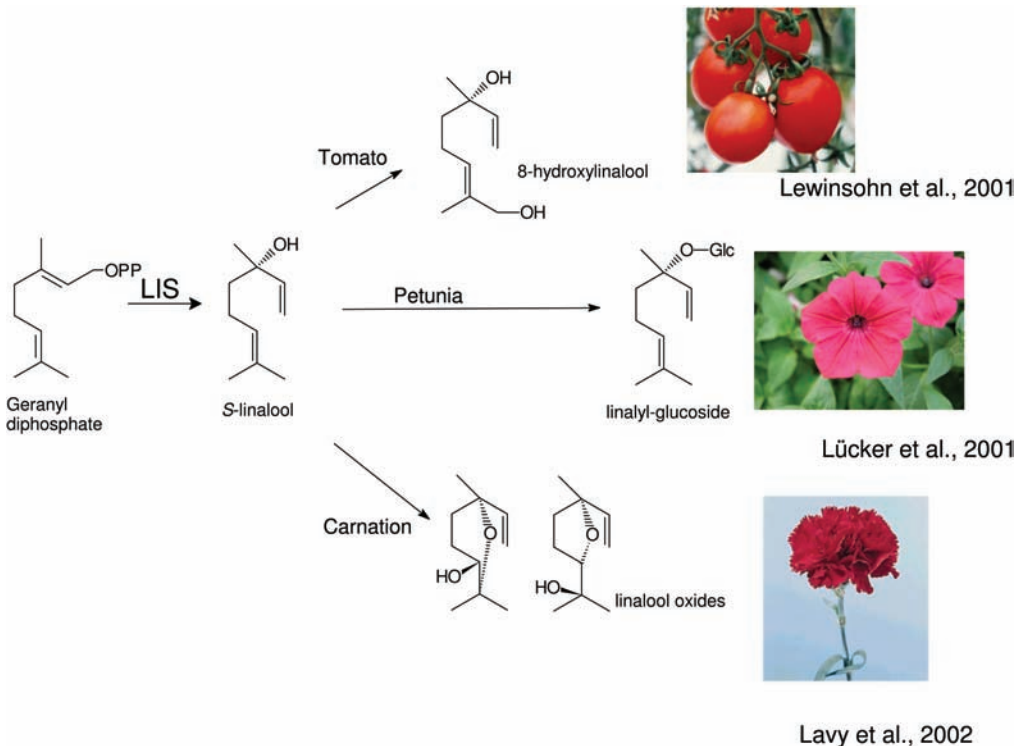
(Leonard et al., 2005). Structure C represents arabinan chains on adjacent Hyp residues (Ashford et al., 1982), while D and E show the mono-arabinose moieties found in timothy grass and mugwort pollen allergens (Wicklein et al., 2004; Leonard et al., 2005). Structure F finally depicts the Gal-Ser motif thought to occur in extensins and solanaceous lectins (Lampert et al., 1973; Ashford et al., 1982). Connecting lines between sugar symbols indicate the linkage as specified in Figure 15.1.





**Fig. 16.1** Functional expression of a gene involved in natural product biosynthesis. The gene is putatively identified by bioinformatic means, inserted into an expression vector. Bacteria are transformed with the above construct and induced to produce high levels

of active protein. The putative substrate is administered under conditions that favor catalysis, and conversion of the substrate to the expected products confirms the identity of the gene. IPTG, isopropyl- $\beta$ -D-thiogalactopyranoside.



**Fig. 16.2** Overexpression of the *Clarkia breweri* S-linalool synthase (LIS) in different plants and tissues results in the formation of different end products.

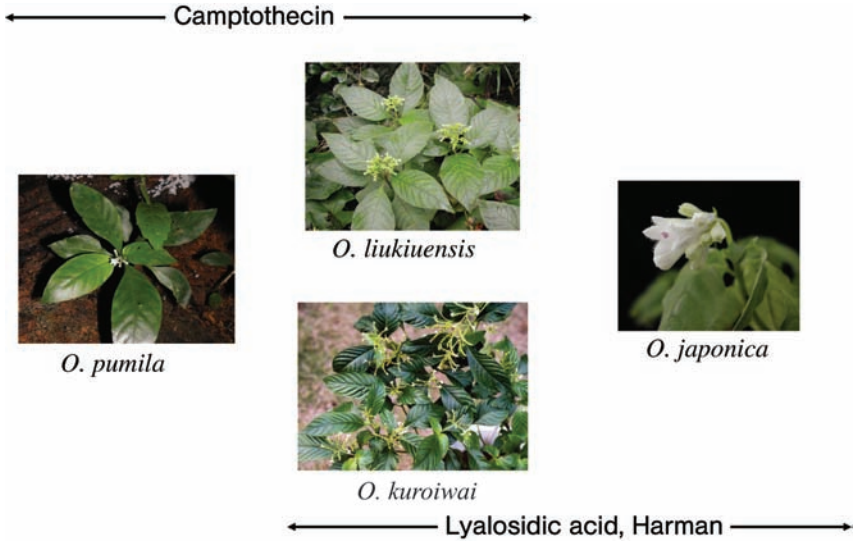


Fig. 19.2 The genus *Ophiorrhiza* species distributed in Japan.

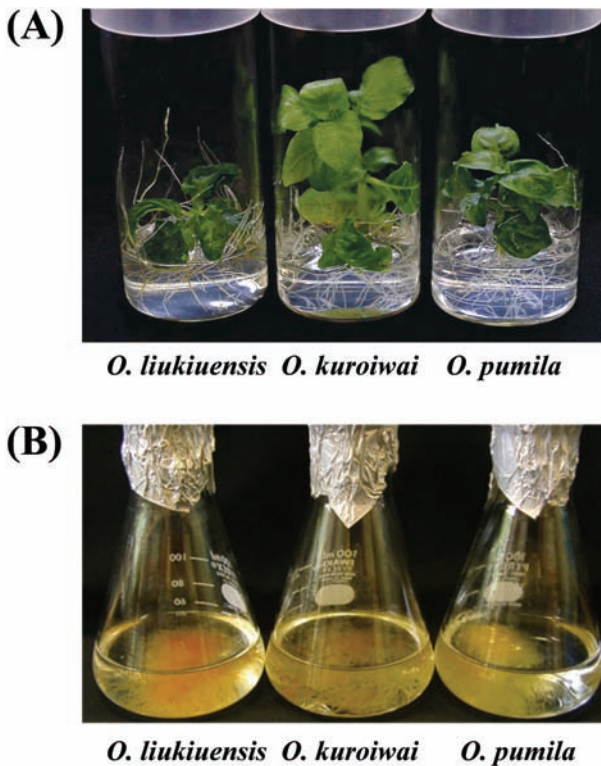
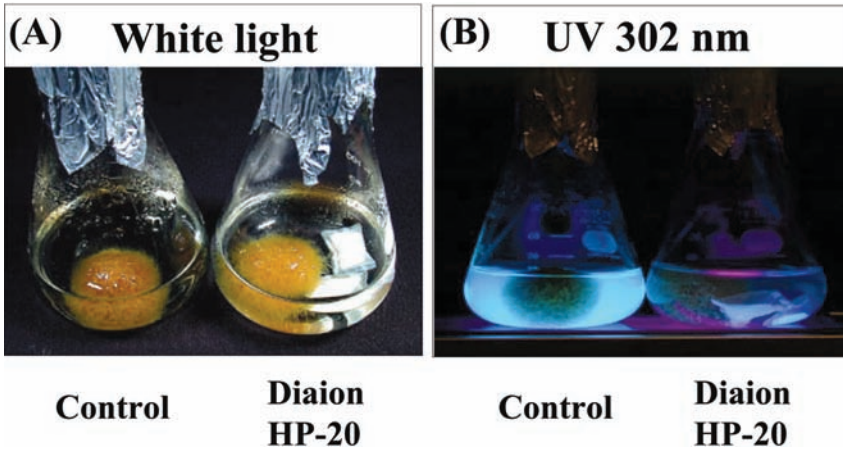
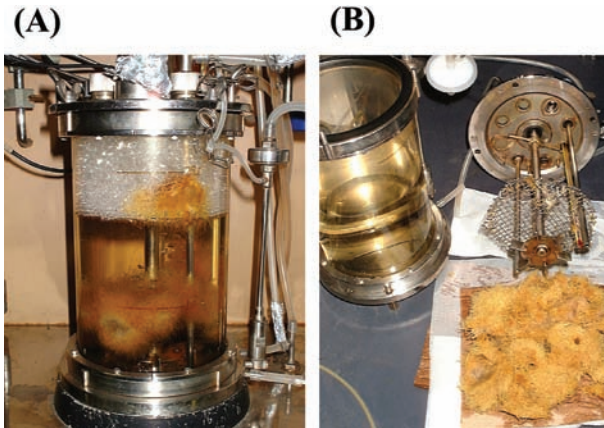


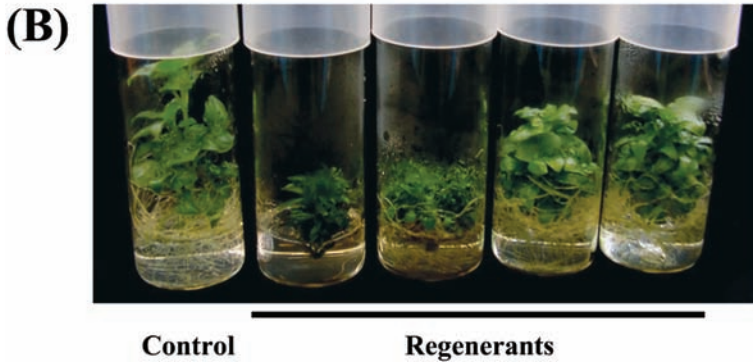
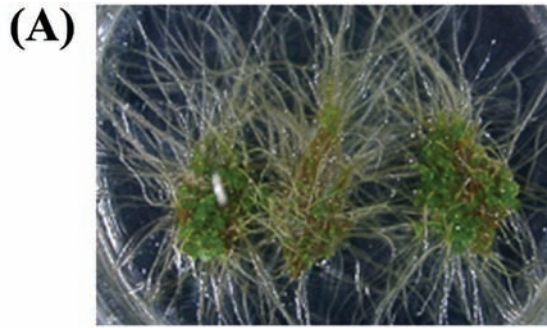
Fig. 19.3 Established tissue cultures of *Ophiorrhiza liukiensis*, *O. kuroiwai*, and *O. pumila*. (A) Aseptic plants cultured for five weeks on half-strength MS medium containing 1% sucrose and 0.2% gellan gum in test tubes. (B) Hairy roots cultured for four weeks in B5 liquid medium containing 2% sucrose. (Reproduced from [22], with permission.)



**Fig. 19.6** Excretion of camptothecin into the culture medium. Hairy roots cultured for four weeks in an Erlenmeyer flask were visualized under (A) white light and (B) ultraviolet light at 302 nm. The strong fluorescence under ultraviolet irradiation is due to camptothecin having been excreted into the medium.



**Fig. 19.7** (A) Hairy root growth of *O. pumila* in the 3-L bioreactor after eight weeks' culture. (B) Harvested hairy roots of *O. pumila* after culture.



**Fig. 19.8** Camptothecin content of transgenic regenerated plants from hairy roots. (A) Regeneration of transgenic *O. pumila* plants from hairy roots. Regenerated shoots emerged from hairy roots after five weeks of

culture under light conditions. (B) The shapes of regenerated plants cultured on half-strength MS medium containing 1% sucrose and 0.2% gellan gum in test tubes.



Fig. 21.1 *Ginkgo biloba* leaves.

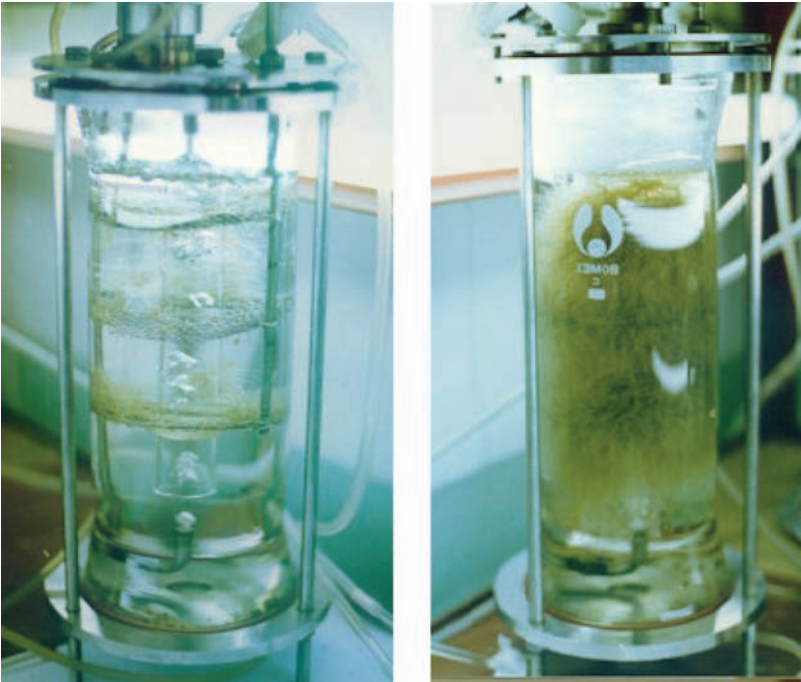


Fig. 23.3 A modified airlift bioreactor for artemisinin production from *A. annua* L. hairy root culture.





**Fig. 23.4** A nutrient mist bioreactor for artemisinin production from *A. annua* L. shoot cultures.

**Part 1**  
**Linking Plants, Genes, and Biotechnology**

## 1

## The Engineering of Medicinal Plants: Prospects and Limitations of Medicinal Plant Biotechnology

*Matthys K. Julsing, Wim J. Quax, and Oliver Kayser*

## 1.1

### Introduction

The use of medicinal plants is increasing worldwide. According to the World Health Organization (WHO), approximately 80% of the world's population currently uses herbal medicines directly as teas, decocts or extracts with easily accessible liquids such as water, milk, or alcohol [1]. Although modern synthetic drugs are mostly used in developed countries, the use of herbal drugs in the western world is well accepted, and a continuously high demand for plant material and extracted natural products can be observed. The top 10 ranked plants that have received greatest interest in the USA and Europe over the past 30 years, and account for over 50% of the over-the-counter (OTC) market, are listed in Table 1.1 [2]. It should be noted that these plants are only partly of interest for biotechnology and

**Table 1.1** Top ten ranked medicinal plants medicinal herbs most commonly used in the United States and Europe.

<i>Species</i>	<i>Use</i>
<i>Hypericum perforatum</i>	Anxiety, depression, insomnia
<i>Echinacea purpurea</i>	Immune stimulation
<i>Ginkgo biloba</i>	Dementia, Alzheimer's disease, tinnitus
<i>Sabal serrulata</i>	Benign prostatic hyperplasia
<i>Tanacetum parthenium</i>	Migraine prophylaxis
<i>Allium sativum</i>	Lipid-lowering, antithrombotic, fibrinolytic, anti-hypertensive, anti-atherosclerotic
<i>Zingiber officinalis</i>	Antiemetic
<i>Panax ginseng</i>	Tonic, performance enhancer, "adaptogen", mood enhancer
<i>Valeriana officinalis</i>	Sedative, hypnotic, anxiolytic
<i>Ephedra distachya</i>	Asthma, rhinitis, common cold, weight loss; enhancer of athletic performance



genetic modification, and today approaches of medicinal plant biotechnology focus more on distinct natural products and biosynthetic pathways. The main reason for this is that genetically modified plants as a source for extract preparations and for manufactured pharmaceuticals available in the pharmacy are not accepted by patients and consumers. Because of a gaining popularity for phytotherapy, and the wishful thought that products obtained from Nature are safe, patients do not consider genetically modified plants as a part of this philosophy. Hence, the approaches of medicinal plant biotechnology currently focus more on distinct natural products and biosynthetic pathways.

It is not only plants that are of great interest to the pharmaceutical industry, but also defined natural products. This situation is supported by the fact that some 25% of all drugs dispensed during the 1970s in the USA contained compounds obtained from higher plants [3]. Moreover, 11% of the 252 drugs considered to be basic and essential by the WHO are isolated and used directly from plant sources [4]. In addition, approximately 40% of pharmaceutical lead compounds for the synthetic drugs used today are derived from natural sources. It is due to this renewed interest in the use of plant sources in drug discovery that in this book we have included Chapter 6, which highlights the prospects and potential of plant-based natural products.

Today, only 10% of all medicinal plant species used are cultivated, with by far the larger majority being obtained from wild collections. Harvesting from the wild may, however, become problematic, as was seen in the case of *Podophyllum* and *Taxus* species, for *Piper methysticum*, for *Cimicifuga racemosa* and for *Arctostaphylos uva-ursa*, whereby both loss of genetic diversity and habitat destruction occurred. It is also not well known that conventional plant breeding methods are of major importance in medicinal plant biotechnology, due to improving agronomic and medicinal traits – a point which is discussed in Chapter 18. Thus, the domestic cultivation of medicinal plants is a well-accepted way in which to produce plant material. Moreover, such an approach also helps to overcome other problems inherent in herbal extracts, such as the standardization of extracts, variability of the plant material, minimization of toxic constituents and contaminations, increasing the content of the desired constituents, and breeding according to internationally accepted Good Agricultural Practise (GAP) guidelines. *Hypericum perforatum* and *Gingko biloba* are two examples of top-selling plants which have been cultivated for many years by European and American phytocompanies, and consequently are not greatly threatened by wild harvesting.

From this background the question arises as to whether there is a need for biotechnology and gene technology for medicinal plants. From its narrow definition, biotechnology does not focus on medicinal plants, and therefore it should be accepted in a broader sense. With regard to medicinal plants, biotechnology could be described as a method for enhancing the formation and accumulation of desirable natural products, with possible product modification in medicinal plants. Micropropagation, cell and hairy root culture as well as gene technology are all important techniques for plant propagation, but these are mostly used to improve the production and yield of desired natural products. Two well-described examples of this are

artemisinin and paclitaxel, both of which are available in plants, albeit in only small quantities. As a consequence, not only are both natural products expensive, but *Taxus* species in the Himalaya region are also endangered due to unsustainable cutting and collection [5]. In an attempt to overcome these problems for both drugs, intensive research is being carried out worldwide, including combinatorial biosynthesis (see Chapter 13), or improved bioprocessing in bioreactors for both artemisinin (see Chapter 23) and paclitaxel (see Chapter 22).

The application of biotechnological techniques to medicinal plants has received considerable interest, especially when the final product is defined, purified, and natural. The manipulation of medicinal plants is well known and accepted both by scientists and consumers, if the pathways and product yield can be optimized to create precursors for semisyntheses (e.g., baccatin-III to paclitaxel), food components (e.g., vitamins), pesticide resistance (e.g., *Atropa belladonna* [6,7]), and cellular storage conditions, as shown for *Mentha* × *piperita* with enhanced resistance against fungal attack and abiotic stress [8].

## 1.2

### Genetic Transformation and Production of Transgenic Plants

The use of biotechnological tools in medicinal plant science is very limited as compared to other crops. However, in recent years the engineering of agronomic traits in medicinal plants led to interesting developments for genetic transformation, both *in vivo* and *in vitro*. Genetic transformation with bacterial vector systems has been widely used for several medicinal plants, including *Artemisia annua*, *Taxus* sp., *Papaver somniferum*, *Ginkgo biloba* (Chapter 21), and *Camptotheca acuminata* (Chapter 7), and species from the Solanaceae (Chapter 11), as reviewed in several chapters. Efficient gene vector systems are intensively discussed in Chapter 8, while the production of high-value phytochemicals is reviewed in Chapter 9.

The commercialization of many genetically engineered plants and plant products is currently being actively pursued by biotechnology and seed companies, and many genetically engineered plants are presently field-tested to determine their potential for commercialization. It remains an open question, however, as to which role transgenic medicinal plants will have in the future. Do we accept medicinal plants in the genomic era only as a source of chemicals, and should they acquire a new role as a genetic source or host for heterologous genes? An opportunity to discuss this question arises in Chapter 14, where the subject is plantibodies, while some answers – as well as further questions – are provided in Chapter 16.

## 1.3

### Pathway Engineering and Combinatorial Biosynthesis

Increasing the production of pharmacologically attractive natural products represents one of the main targets for the genetic manipulation of medicinal plants. An in-

creasing number of natural products are being biosynthesized in low quantities, with known examples being artemisinin, paclitaxel, podophyllotoxin, and *Vinca*-alkaloids. The use of genetically modified plant cell cultures, such as hairy root cultures for Solanaceae (see Chapter 11) or for artemisinin (see Chapter 23), offers a rational approach to allow the overexpression of genes encoding biosynthetic enzymes, and to overcome the rate-limiting steps of the biosynthesis.

Combinatorial biosynthesis is a new tool in the generation of novel natural products, as well as for the production of rare and expensive natural products, and is explained and illustrated in detail in Chapter 13. The basic concept of combinatorial biosynthesis is to combine metabolic pathways in different organisms at the genetic level. Combinatorial biosynthesis is discussed for important classes of natural products, including alkaloids (vinblastine, vincristine), terpenoids (artemisinin, paclitaxel), and flavonoids. The main problem with combinatorial biosynthesis, however, is that most biosynthetic pathways are still poorly understood at the genetic level, with relatively few genes involved in regulation and biosynthesis in plants having been sequenced and functionally elucidated. Therefore, no complete biosynthetic pathway has been completely transferred to a heterologous host. Although today, for economic reasons, crops are at the focus of this new technology, in the future these new genomic approaches will be expanded, in both range and precision, to the area of medicinal plants and the development of secondary pathways of metabolism.

#### 1.4

#### **Bioprocessing**

Although plant breeding and cultivation is widely accepted (for a review, see Chapter 18), the lack of consistency in the levels of bioactive chemicals in herbal medicines has been a crucial point, and variations in secondary metabolite production will certainly contribute to this problem. Plant tissue culture growth of medicinal plants can also be scaled-up using continuous culture systems such as “bioreactors”, which would allow the automated, high-level isolation of medicinal secondary products. In this book, three chapters outline the possibilities and limitations of today’s bioprocessing techniques with regard to the latest applications. These are made on a general basis in Chapters 7 and 15, and more specifically for the production of paclitaxel and artemisinin in Chapters 22 and 23, respectively. The biochemistry, enzymology and physiology of medicinal plant biotechnology, in addition to bioreactor design and the application of proteomics and genomics, represent other areas to be understood. For example, various points in a given metabolic pathway can be controlled simultaneously, either by overexpression and/or suppression of selected enzymes, or through the use of transcriptional regulators to control endogenous genes. Thus, multipoint metabolic engineering offers a new perspective for improving the production of plant-based chemotherapeutics, and this topic is discussed extensively in Chapter 7.

## 1.5

### Plant Propagation

Biotechnological tools are important in order to select, multiply and conserve the critical genotypes of medicinal plants. In this book, plant tissue culture techniques are discussed in Chapters 8 and 12 as integrated approaches for the production of standardized quality phytochemicals, through the mass production of consistent plant material for physiological characterization, and the analysis of active ingredients. Micropropagation is the practice of rapidly multiplying stock plant material to produce large numbers of progeny plants by using modern plant tissue culture methods. Protocols for the cloning of some medicinal plants such as *Catharanthus roseus* (Apocynaceae), *Chlorophytum borivilianum* (Liliaceae), *Datura metel* (Solanaceae), and *Bacopa monnieri* (Scrophulariaceae) have been developed and are discussed in part in Chapters 9, 11 and 19. The integrated approaches of plant culture systems will provide the basis for the future development of novel, safe, effective, and high-quality products for consumers.

## 1.6

### Bioanalytics and Metabolomics

Despite recent advances in biotechnology, combinatorial biochemistry, and high-throughput screening, natural products from plants continue to serve as a major source of new chemical entities for pharmaceutical research. Although these new biotechnological approaches have allowed the creation of new and, in part, semi-natural products, the new innovative discipline of metabolomics will clearly open the door to explore thousands of plants and their constituents. What can be expected of metabolomics, and whether this new discipline will keep its promise, remains a matter of dispute, and is discussed in Chapter 2.

Recently developed analytical techniques are capable of identifying and structurally elucidating major constituents in a single plant, or assessing a single biological activity in *in-vitro* assays in parallel. Consequently, the potential of even relatively thoroughly investigated plants must be regarded as still largely unexplored. In order to overcome this problem and to accelerate the discovery process of mapping, the chemical diversity of plants is therefore of utmost importance, and this can only be achieved if new spectroscopic and genetic methods for the rapid dereplication of natural products from plant extracts is developed. Highlights of the latest LC-NMR techniques of spectroscopic analysis are discussed in Chapter 3, while genetically based techniques for DNA profiling of medicinal plants are reviewed in Chapter 5.

## 1.7

**Future Prospects**

The commercial viability of biotechnology and gene technology in medicinal plant research is strongly influenced by the common perception of both, the plant and biotechnology. As outlined above, genetically modified medicinal plants lose their “natural” status, and are considered – erroneously – by the public as unsafe and dangerous. The crop industry learned its lesson following the rejection in Europe of genetically modified crops that were introduced into the food chain. Clearly, companies producing herbal compounds would face the same problems in obtaining permission to conduct farm-scale trials, to document the safety of the final product, and to overcome the in-principle resistance of the consumer as a strong and perhaps immovable barrier [9].

Within an open scientific environment, the discovery and development of botanical therapeutics and medicinal plant biotechnology must be accepted, as its expansion is very unlikely to cease. It is difficult to predict the future for medicinal plants, but it is likely that herbal drugs, isolated natural products and recombinant low- and high-molecular weight products will hold at least the same significance. Plants, as a renewable source with low energy consumption that can offer complex biochemical syntheses, will be even more compatible in the future. Although the real potential of plants remains unexplored, we hope that with this book we can perhaps at least “scratch the surface” slightly to provide a better understanding of medicinal plant biotechnology, as well as its possibilities and limitations.

**References**

- 1 Farnsworth, N.R. The role of ethnopharmacology in drug development. *Ciba Foundation Symposium* **1990**, *154*, 2–11; discussion 11–21.
- 2 Farnsworth, N. Screening plants for new medicines. In: Wilson, E. (Ed.), *Biodiversity*. National Academy Press, **1988**, pp. 83–97.
- 3 Farnsworth, N.R., Morris, R.W. Higher plants – the sleeping giant of drug development. *Am. J. Pharm. Sci. Support Public Health* **1976**, *148*(2), 46–52.
- 4 Rates, S. Plants as sources of drugs. *Toxicon* **2001**, *39*, 603–613.
- 5 Rikhari, H., et al. The effect of disturbance levels, forest types and associations on the regeneration of *Taxus baccata*: Lessons from the Central Himalayo. *Curr. Sci.* **2000**, 79–88.
- 6 Saito, K. [Molecular genetics and bio-technology in medicinal plants: studies by transgenic plants]. *Yakugaku Zasshi* **1994**, *114*(1), 1–20.
- 7 Saito, K. Transgenic herbicide-resistant *Atropa belladonna* using an Ri binary vector and inheritance to the transgenic trait. *Plant Cell Rep.* **1992**, *21*, 563–568.
- 8 Veronese, P., et al. Bioengineering mint crop improvement. *Plant Cell Tissue Organ Cult.* **2001**, *64*, 133–144.
- 9 Canter, P.H., Thomas, H., Ernst, E. Bringing medicinal plants into cultivation: opportunities and challenges for biotechnology. *Trends Biotechnol.* **2005**, *23*(4), 180–185.

## 2

# Metabolomics

*Young Hae Choi, Hye Kyong Kim, and Robert Verpoorte*

### 2.1

#### Introduction

With the sequence of the genome of several organisms having been determined, and the speed of sequencing other genomes increasing, the emphasis of genomics is now moving towards investigations of genome function. Today, the question of the function of every single gene remains unanswered. To solve this problem it may be possible to knock out or silence every gene, but in many cases this would result in a non-viable organism. It may also be possible to examine expression patterns and to compare these with the phenotype under conditions in which the genes are expressed. In all cases, characterization of the phenotype is the key to understanding the function of the gene(s) of interest. Phenotype characterization can be achieved by means of morphological observation, or by using chemical and biochemical approaches. Biochemical characterization is achieved by proteomics, while chemical characterization is covered by metabolomics (Fiehn et al., 2000a; Schwab, 2003; Sumner et al., 2003).

Metabolomics is the youngest of the so-called “omics” methods, and ultimately concerns the analysis of all metabolites in an organism. To achieve this, a number of diverse approaches can be used (Fig. 2.1):

- *Metabolomics* aims at measuring all metabolites in an organism, both qualitatively and quantitatively. In studies of human or mammalian pathogenesis involving the analysis of materials such as urine and serum, this is referred to as *metabonomics*.
- *Metabolic profiling* aims at measuring a selected group of metabolites in an organism.
- *Metabolic fingerprinting* aims at measuring a “fingerprint” of the metabolite(s) in an organism, but without identifying all of the compounds present.

The major differences between these approaches are in the choice of whether to identify (all) compounds qualitatively and quantitatively in an organism, or to determine differences in metabolite content, followed by the identification of differ-

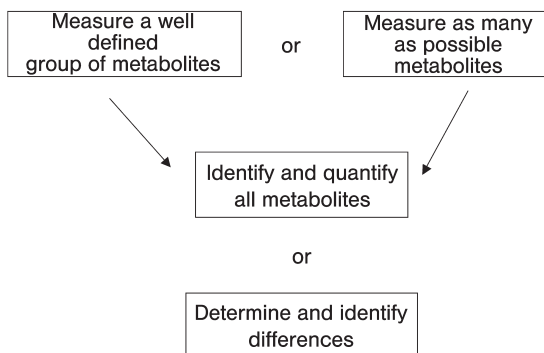


Fig. 2.1 Possible approaches to metabolomic analysis.

ent compounds. When examining a single compound or a well-defined group of compounds, this is considered to constitute a “targeted” approach.

Proteomics provides a view of the proteins present in an organism, by means of a suitable separation method. Two-dimensional (2D) gel electrophoresis is the most widely used (Jacobs et al., 2000), and from the patterns of the gel separation conclusions can be drawn on the overexpressed proteins under certain conditions. Subsequently, the proteins that seem of interest are hydrolyzed into peptides to determine their molecular weight and amino acid sequence, using mass spectrometry. When these sequences are resolved, the available large public databases can be screened for homologous peptides and/or genes and, based on homology with known peptides, a function of a protein may be proposed. Further proof is required, however, by using (bio-)chemical studies. Unfortunately, when investigating an organism in the absence of any information with regard to its genome sequence, many unknown peptides will be encountered, and this may require the encoding gene to be cloned, in order to determine its function. This will be an elaborate task, and consequently in non-sequenced organisms it might be possible to follow another strategy, by directly linking the transcriptomics (mRNA patterns) with the metabolomics data.

Hence, metabolomics is an important tool in functional genomics. In addition to this basic scientific approach, metabolomics has been applied to a wide array of other fields. For example, it is an important tool for the chemotaxonomy of botanicals, or for studying the equivalence of genetically modified and wild-type organisms, especially in the case of plants. Metabolomics also represents a major diagnostic tool, for example in the analysis of urinary metabolites using nuclear magnetic resonance (NMR) spectrometry in order to diagnose disease. Today, in drug development, metabolomics is used as a major means of detecting the toxicity of novel compounds on the kidney and liver, and more recently has attracted much attention from systems biology approaches to drug development. The different aspects of metabolomics will be discussed in detail in the following sections.

## 2.2 Analytical Methods

The ultimate goal of metabolomics is to measure all of the metabolites in an organism. However, the first question to be asked is how many metabolites are present in an organism? Although the answer is not known, it is possible to make an estimation, and it is commonly regarded that in any single organism there will be about the same number of metabolites as there are genes. Not all genes are involved in metabolism, but this is compensated for by a number of proteins being able to catalyze several reactions. Consequently, in a single plant approximately 30 000 low molecular-weight compounds should be present. To date, the best-studied plant is most likely tobacco, the number of identified compounds in tobacco leaves numbering approximately 3000. Within an organism, the metabolites represent a broad range of polarities and quantities, with some being highly labile. Hence, the aim of analyzing all of these compounds both qualitatively and quantitatively in a single operation is unrealistic, and cannot be achieved by any single analytical method, as each method has specific limitations.

In the case of metabolomics, the analytical tools available can be allocated to three major groups:

- Chromatographic methods: thin-layer chromatography (TLC), gas chromatography (GC), GC-mass spectrometry (MS), high-performance liquid chromatography (HPLC), HPLC-photodiode array (PDA) detector, HPLC-MS, and capillary electrophoresis (CE).
- Mass spectrometry, including MS and coupled MS-MS.
- NMR spectrometry.

### 2.2.1 Chromatography

Chromatographic methods have the advantage of sensitivity and specificity as they can be combined with selective detectors (MS for GC, and photodiode array detection, MS and NMR in case of HPLC) (Table 2.1).

#### 2.2.1.1 Gas Chromatography (GC)

Although GC requires that compounds be volatile, many are neither volatile nor thermostable, and therefore require derivatization (e.g., acetylation, methylation, trimethylsilylation) prior to GC-analysis. This is an elaborate procedure which is also poorly reproducible for many compounds. The major advantage of GC is the large number of compounds that can be separated in a single analysis, and the large dynamic range (i.e., a rather broad range of quantities can be measured). Coupling GC with MS renders the method highly selective (e.g., with selective ion monitoring). Although MS detection is very sensitive, each compound has a different sensitivity, and consequently calibration curves are required for every com-



**Table 2.1** Description of chromatographic methods used in metabolomics.

<b>Methods</b>	<b>Target metabolites</b>	<b>Sample preparation</b>	<b>Reproducibility</b>	<b>Resolution</b>	<b>Detector</b>
TLC	General	Simple	Low	Low	UV, MS, color reagents
GC	Nonpolar (low molecular)	Elaborate derivatization	Medium	High	FID, TCD, NPD, MS
HPLC	Polar (chromophore)	Elaborate	Medium	Medium	UV, RI, MS, ELSD, fluorescence, NMR
CE	Ionic	–	Medium	High	UV, MS

ELSD, evaporative light-scattering detector; FID, flame ionization detector; NPD, nitrogen-phosphorus detector; RI, refractive index detector; TCD, thermal conductivity detector.

pound if absolute amounts of all metabolites are to be determined. GC-(MS) has proven successful in the analysis of the *Arabidopsis* metabolome, whereby over 1000 compounds were detected, about half of which were identified. GC-MS has been used for more than 40 years for targeted approaches, and consequently extensive databases of MS data in combination with GC-retention time data exist (e.g., NIST, AMDIS). These targeted approaches may relate to terpenoids (essential oils, steroids) and fatty acids (a field now also known as “lipidomics”). The main drawbacks of GC analysis is that the sample preparation methods are quite elaborate, and the average time required for a single analysis is over 1 h. Thus, high-throughput analyses are only feasible by using many GC instruments in parallel. A possible standard protocol for GC-MS analysis was developed by the Max Plank Institute of Molecular Plant Physiology (<http://www.mpimp-golm.mpg.de/mms-library/details-e.html>) (see Box 2.1).

**Box 2.1** Derivatization method for GC-MS metabolomics  
(<http://www.mpimp-golm.mpg.de/mms-library/details-e.html>)

- Add 80  $\mu\text{L}$  methoxyamine hydrochloride in pyridine (20  $\text{mg mL}^{-1}$ ) to dried sample extract for protection of carbonyl moieties and react at 30 °C for 90 min.
- Afterwards add 80  $\mu\text{L}$  *N*-methyl-*N*-trimethylsilyl-trifluoroacetamide (MSTFA) for TMS derivatization and react at 37 °C for 120 min.
- GC column; SPB 50 (polysiloxane column coated with 50% methyl and 50% phenyl groups, 30  $\text{m} \times 0.25 \text{ mm}$ )
- Injection temperature 230 °C
- Interface temperature 250 °C
- Ion source temperature 200 °C
- Helium flow rate 1.0  $\text{mL min}^{-1}$
- Oven temperature; after a 5-min solvent delay time at 70 °C, oven temperature increased at 5 °C  $\text{min}^{-1}$  to 310 °C, 1 min isocratic, cool to 70 °C followed by an additional 5-min delay.

### 2.2.1.2 High-Performance Liquid Chromatography (HPLC)

HPLC is the other widely used separation method for the analysis of metabolites, and can be used for both targeted and non-targeted approaches. Most often, HPLC is combined with a PDA detector, which allows recording of the ultraviolet (UV) spectra of all compounds, thus adding selectivity to the system. Unfortunately, many metabolites have no UV-absorption (e.g., many primary metabolites such as sugars, amino acids, compounds involved in tricarboxylic acid cycle, lipids, and terpenoids). However, by combining HPLC with MS these compounds can be identified, simultaneously adding further selectivity to the system. The sensitivity of HPLC-MS varies for all compounds, with sugars notably difficult to detect. For all HPLC-applications, quantitative analysis can only be achieved by creating calibration curves for each individual compound.

One important limitation of HPLC lies in the polarity window of the method. Typically, a metabolome will contain not only very nonpolar compounds that are insoluble in water and alcohols, but also highly polar compounds. Consequently, in order to cover the complete metabolome, several different systems must be employed. The number of compounds that can be separated in a gradient HPLC-system is between 100 and 200, though when combined with MS this number increases considerably, as overlapping peaks of different molecular weights can be observed as separate compounds in the MS.

As with all chromatographic methods, a major problem for HPLC is the reproducibility of separations. This occurs for several reasons, including small differences in parameters such as temperature and solvent quality, while matrix effects of the complex sample extract may influence the retention behavior of the compounds. In addition to possible small differences in batches between columns of the same manufacturer, the quality of the separation column will gradually deteriorate during prolonged use. Finally, novel columns are being introduced continuously to the market, replacing previous versions. Consequently, separations performed some years ago can no longer be reproduced, and this leads to major problems of analysis time when characterizing an organism's metabolome. Clearly, as metabolomics require methods that can be used internationally by research workers over many years, it is essential that public metabolomic databases (similar to those available for proteins and genes) are developed, and this requires long-term reproducibility of the analytical data. In this regard, several commercial alignment programs (e.g., LineUP™; Infometrix Inc., Bothell, WA, USA; [www.infometrix.com](http://www.infometrix.com)) and MetAlign (Plant Research International, Wageningen, The Netherlands; [www.pri.wur.nl](http://www.pri.wur.nl)), as well as "home-made" programs (e.g., Nielsen et al., 1998; Chen et al., 2003; Duran et al., 2003), have been designed to overcome such problems of reproducibility. However, although these programs may correct for day-to-day variations, they cannot overcome the problem of altered selectivity when column materials are produced in a different manner, or are modified ("improved"). For the analysis of a large number of compounds over a broad polarity range, a gradient program will typically take 30–60 min, though with novel equipment, using smaller-particle columns, this may be reduced to between 5 and 20 min. Hence, high-throughput analysis is not really feasible.

### 2.2.1.3 Capillary Electrophoresis (CE)

CE, which has also been applied to the analysis of metabolomes, has a very high resolution power, particularly for ionic compounds, when compared to other chromatographic methods. Moreover, its direct coupling to MS further contributes to the selectivity and provides a sensitive detection method. However, it is inherently limited to ionic compounds such as alkaloids, amino acids, or organic acids (Ishii et al., 2005).

### 2.2.1.4 Thin-Layer Chromatography (TLC)

TLC has a large potential to detect diverse group of compounds using a wide array of detection methods, including UV and coloring reagents. Although high-performance thin-layer chromatography (HPTLC) has a higher efficiency, the low resolution and reproducibility remain the limiting factors in its use for metabolomics. For metabolic fingerprinting, TLC has been used for more than 45 years in the quality control of botanicals.

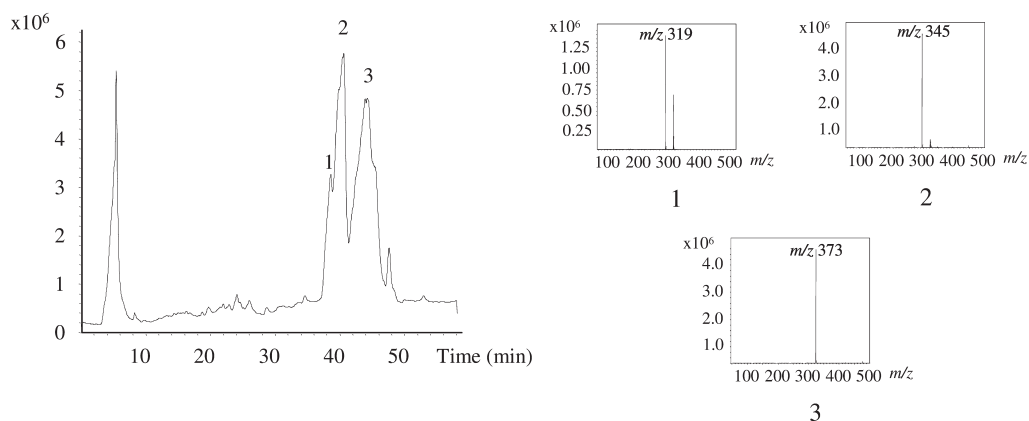
## 2.2.2

### Spectroscopy

#### 2.2.2.1 Mass Spectrometry (MS)

MS detects the molecular ion of a compound after ionization and, if desired, also the fragmentation of that molecular ion. MS analysis in metabolomics uses separation of the compounds based on their molecular weight. By using high-resolution MS, compounds with different elemental formula but similar mass can be separated. Assuming that the molecular weights of the metabolites which together form the metabolome are in the range of about 50 to 2000, MS can separate about 2000 compounds. In complex mixtures, individual compounds will be detected on the basis of their molecular weight, but clearly there will be an extensive overlap of compounds with the same molecular weight. However, by using tandem MS-MS, greater selectivity can be obtained through the specific fragmentation of each compound. An example of an HPLC-MS analysis of a plant extract (*Ginkgo biloba*) is shown in Figure 2.2 (Choi et al., 2002).

MS is a very selective – and also possibly the most sensitive – method for metabolome analysis. However, the problems of reproducibility and quantitation are, as with chromatographic methods, the major constraints. Because of the different types of mass spectrometer available, the many possible variations in operating parameters, and also effects of the matrix on ionization, reproducibility is a major problem. Moreover, the efficiency of ionization of different compounds varies enormously, and may depend upon the presence of other compounds. Thus, quantitative analysis requires calibration curves for all compounds. Because MS spectrometry is a rapid process, a large number of samples can be analyzed per time unit (up to ca. 10 samples per hour). High-throughput analysis is thus feasible by means of MS. The most frequently used ionization methods of MS used in metabolomics are listed in Table 2.2.



**Fig. 2.2** Total ion current chromatogram of *Ginkgo biloba* extracts obtained with acetone:water (1:1) and the mass spectra of the major ginkgolic acids (1, 2, and 3) (Choi et al., 2002).

**Table 2.2** Ionization methods in MS spectrometry used for metabolomics.<sup>a</sup>

<b>Methods</b>	<b>Target metabolites [MW range]</b>	<b>Possible chromatographic methods connected</b>	<b>Advantages</b>	<b>Disadvantages</b>	
EI	Nonpolar (<500 MW)	GC	Identification using fragmentation	Low sensitivity of molecular weight of polar metabolites	
API	ESI	Polar (<100 000 MW)	HPLC, CE	High sensitivity of molecular weight of polar metabolites	Limitation of polarity of metabolites
API	APCI	Medium polar (<1000 MW)	HPLC	Detection of metabolites soluble in nonpolar solvents	Limitation of MW of metabolites
MALDI	Polar (<100 000 MW)	HPLC	Detection of peptides and proteins	Lower sensitivity of low molecular weight metabolites	

<sup>a</sup> Resolution varies depending on separators (e.g., quadrupole, ion trap, time of flight).

APCI, Atmospheric chemical ionization; API, Atmospheric ionization;

EI, Electron impact; ESI, Electrospray ionization;

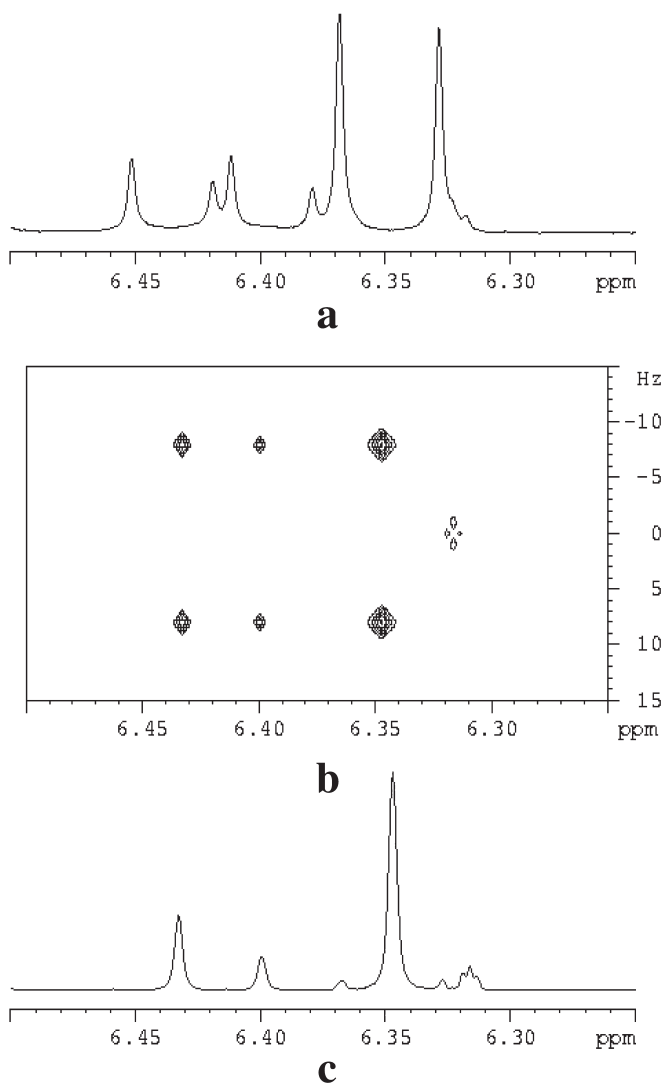
MALDI, Matrix-assisted laser desorption.

#### 2.2.2.2 Nuclear Magnetic Resonance (NMR) Spectrometry

NMR spectrometry is a physical measurement of the resonance of magnetic nuclei such as  $^1\text{H}$  and  $^{13}\text{C}$  in a strong magnetic field. Because of small local differences in the magnetic field in a molecule, each proton and carbon will show a different resonance, resulting in a highly specific spectrum for each compound. Such a spectrum is highly reproducible, and in  $^1\text{H}$  NMR the intensity of a signal of a proton is directly correlated with the molar concentration – that is, all compounds in a mixture can be compared, without the need for a calibration curve. One single internal standard can be used to make the quantitative analysis of all compounds in a mixture. Thus, both in terms of reproducibility and quantitation,  $^1\text{H}$  NMR spectrometry has a major advantage over chromatographic methods and MS. Many previous reports (see also Chapter 3) have shown that the specific characteristics of NMR make it an excellent tool for a macroscopic, non-targeted analysis of the total metabolome (Ward et al., 2003; Choi et al., 2004a,b,c, 2005, 2006; Hendrawati et al., 2006; Khatib et al., 2006; Yang et al., 2006).

The main disadvantage of NMR is that it is less sensitive than the other methods mentioned. Typically, the amount of material needed for an NMR analysis is about 50 mg biomass (dry weight), though in practice this is similar to what is required for the other methods. For NMR the complete extract is needed for non-destructive analysis, after which the sample can be kept for further analysis. In contrast, in other methods only part of the extract is used for the analysis, though this is destructive and requires back-up material for future use. The sensitivity of NMR can be improved by increasing the measuring time, and also by improving the spectrometer (e.g., cryo- or coldprobe), and this has been achieved in recent years. In NMR a higher field strength of the magnet improves sensitivity, and also influences the spectrum of a compound; the stronger the field the better the separation of the signals, and second-order spectra become first-order. This may hamper direct comparison of spectra recorded at different field strengths, but the problem can be resolved by using two-dimensional (2D)-NMR spectrometry. A 2D-J-resolved spectrum shows in the second dimension the coupling constants of each proton signal as a set of signals at the chemical shift of the proton. By projection of these signals onto the chemical shift axis, all proton signals become singlets (Hendrawati et al., 2006; Khatib et al., 2006; Yang et al., 2006). An example of an application of projected J-resolved spectra to the tobacco metabolome analysis (Choi et al., 2006) is shown in Figure 2.3. In this way the resolution is improved, but more importantly the projected spectrum is independent of the field strength, which makes this a constant characteristic suitable for long-term inclusion into a public database. The disadvantage of this approach is that signals can no longer be compared quantitatively, although relative comparison for one compound in different mixtures is still possible.

An advantage of NMR spectroscopy is that the time required to record a  $^1\text{H}$  NMR spectrum is quite short (depending on the equipment and concentration of the sample, a  $^1\text{H}$  NMR spectrum can be obtained within 10 min), which makes high-throughput analysis an option. As NMR spectra are recorded in solution, there is a limitation to the polarity range that can be covered using this technique. At least two different solvents are needed to cover the nonpolar and polar compounds. In



**Fig. 2.3** (a)  $^1\text{H}$  NMR, (b) 2-D-J-resolved, and (c) projected 1-D-J-resolved spectrum of healthy *Nicotiana tabacum* leaves in the range of  $\delta$  6.25– $\delta$  6.50, showing the signals of isomeric chlorogenic acids (Choi et al., 2006).

order to cover the diverse polarity of metabolites, a two-phase extraction method using a mixture of chloroform, methanol and water has been applied to plant metabolomics (Choi et al., 2004a,b,c, 2005). In order to reduce preparation time, a simple direct extraction method using deuterated NMR solvents has been developed for sample preparation (Choi et al., 2006; Hendrawati et al., 2006; Khatib et al., 2006; Yang et al., 2006).

NMR results obtained using correct sample preparation allow a direct comparison of all compounds present. The data obtained also have all the desired characteristics needed for inclusion into a public database on metabolomic data.

### 2.2.3

#### Identification of Metabolites

One problem in metabolomic studies of new organisms is the identification of all metabolites. Many can easily be recognized by comparison with databases of well-known primary metabolites occurring in most living cells. However, particularly in chemically advanced organisms such as plants, secondary metabolism is very well developed and produces a wide variety of species-specific compounds. Retention behavior in chromatography, UV spectra and mass spectra are useful to identify well-known compounds, but in the case of rare or novel compounds further structure elucidation is necessary.

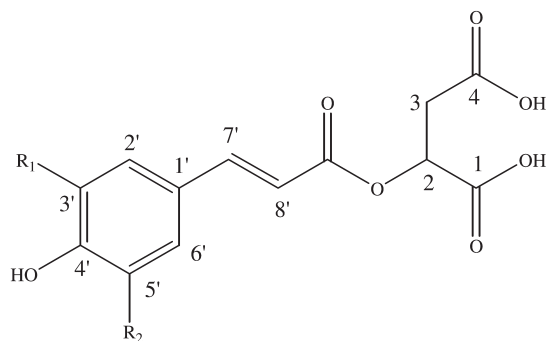
NMR-spectrometry is by far the most powerful tool for structure elucidation. For  $^1\text{H}$  NMR spectra, only small amounts of material are needed, and direct coupling with liquid chromatography (LC) provides good spectra that can help to determine the structure. For more complex compounds, however,  $^{13}\text{C}$  NMR spectra and various 2D-NMR spectra are needed to establish the carbon skeleton of the molecule and determine the positions of the protons. This requires larger amounts of material, which can be obtained by preparative chromatography, or repeated analytical chromatography and collection of the peak(s) of interest, for example on a solid-phase extraction column(s) (LC-SPE-NMR). In crude extracts using NMR-metabolomics, much information can be acquired by applying various 2D-NMR spectroscopic methods such as correlated spectroscopy (COSY, to reveal proton–proton couplings), 2D-J-resolved spectra (to show the coupling constants of various proton signals), heteronuclear multiple quantum coherence (HMQC, to determine direct proton–carbon couplings), and heteronuclear multiple bond coherence (HMBC, to determine long-range proton–carbon couplings). These methods can in fact also be used as a metabolomics tool as they allow more compounds to be quantified. An example of the identification of metabolites in *Brassica rapa* leaves using 2D-NMR spectrum is shown in Figure 2.4 (Liang et al., 2006).

### 2.2.4

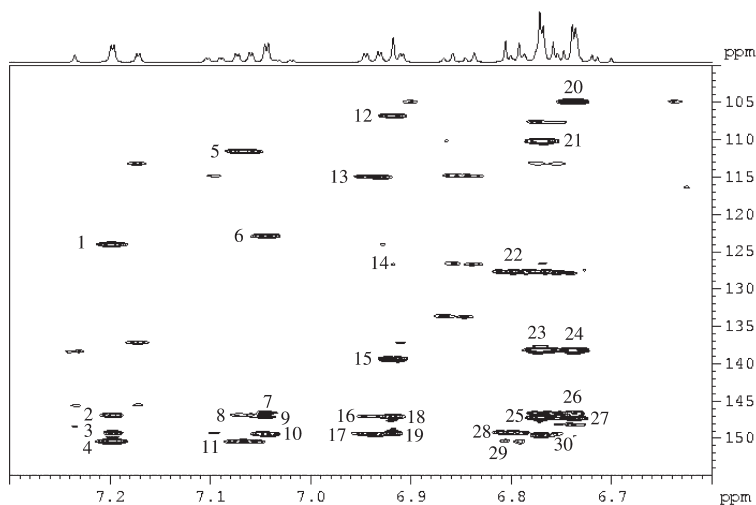
#### Sample Treatment

A key step in the analysis of a metabolome is the sample preparation. This includes all steps from harvesting, extracting and sample purification prior to the actual analysis. Each of these steps must be optimized and validated for a reliable reproducible analysis.

The first step is to collect the material which, in order to avoid any (bio)chemical change in the material, should be frozen immediately after harvesting. In plants, for example, immediately after harvesting a defense reaction will occur in the cells, which includes the hydrolysis of glycosides and oxidation of phenolics that subsequently bind to cell walls.



- $R_1 = \text{OCH}_3, R_2 = \text{OH}$ , 5-hydroxyferuloyl malate (1)  
 $R_1 = \text{OH}, R_2 = \text{H}$ , caffeoyl malate (2)  
 $R_1 = \text{H}, R_2 = \text{H}$ , coumaroyl malate (3)  
 $R_1 = \text{OCH}_3, R_2 = \text{H}$ , feruloyl malate (4)  
 $R_1 = \text{OCH}_3, R_2 = \text{OCH}_3$ , sinapoyl malate (5)



**Fig. 2.4** Heteronuclear multiple bond coherence (HMBC) spectrum of aromatic moiety of phenylpropanoids of *Brassica rapa* leaves in the range of  $\delta$  6.60– $\delta$  7.30 of  $^1\text{H}$  and  $\delta$  100– $\delta$  150 of  $^{13}\text{C}$ , showing the long-range C–H couplings. 1: H-2'/C-6' of compound 4. 2: H-2'/C-7' of compound 4. 3: H-2'/C-3' of compound 4. 4: H-2'/C-4' of compound 4. 5: H-6'/C-2' of compound 4. 6: H-2'/C-6' of compound 2. 7: H-2'/C-3' of compound 2. 8: H-6'/C-7' of compound 4. 9: H-2'/C-7' of compound 2. 10: H-2'/C-4' of compound 2. 11: H-6'/C-4' of compound 4. 12: H-2' and 6'/C-2' and 6' of compound 5. 13: H-6'/C-2'

of compound 2. 14: H-2' and 6'/C-1' of compound 5. 15: H-2' and 6'/C-4' of compound 5. 16: H-6'/C-7' of compound 2. 17: H-6'/C-4' of compound 2. 18: H-2' and 6'/C-7' of compound 5. 19: H-2' and 6'/C-3' and 5' of compound 5. 20: H-6'/C-2' of compound 1. 21: H-2'/C-6' of compound 1. 22: H-5'/C-1' of compound 4. 23: H-2'/C-4' of compound 1. 24: H-6'/C-4' of compound 1. 25: H-2'/C-7' of compound 1. 26: H-6'/C-5' of compound 1. 27: H-6'/C-7' of compound 1. 28: H-5'/C-3' of compound 4. 29: H-5'/C-4' of compound 4. 30: H-2'/C-3' of compound 1 (Liang et al., 2006).



The next step is to grind the material to liberate the metabolites from the cells. Cells of microorganisms can be destroyed by using a French press, but plant material containing lignified cells requires mechanical grinding. During the extraction, (bio)chemical reactions may occur in the material, resulting in changes in the metabolome. This can be avoided by drying the material before extraction (either by heat or freeze-drying), keeping the material at low temperature, or grinding in the presence of a solvent that denatures enzymes which could convert the metabolites. Denaturation can also be achieved by a brief microwave treatment.

To extract the metabolites, a broad spectrum of solvents can be used. Nonpolar solvents (e.g., hydrocarbons), medium-polar solvents (e.g., ethyl acetate, diethyl ether, chloroform, dichloromethane), and polar solvents (e.g., methanol, ethanol, water), and any combination of these solvents can be used. Each group will extract a different type of metabolite(s); some metabolites will completely dissolve in a certain solvent, but others only partly. pH is also a factor that affects the profile of metabolites extracted; for example, alkaloids are soluble in nonpolar solvents at high pH, and in aqueous solvents at low pH. A two-phase solvent system consisting of chloroform:methanol:water (2 : 1 : 1) has been used to extract both polar and nonpolar compounds in a single extraction (Choi et al., 2004a,b,c, 2005) (see Box 2.2).

This method was also applied to metabolic analysis for plant cell culture materials after washing the materials with deionized water (Suhartono et al., 2005), while a modified method with addition of  $\text{NH}_4\text{OH}$  was used for benzylamine alkaloids (Kim et al., 2005).

This two-phase extraction method was found to be problematic, however, when handling large numbers of samples because of the long processing time. Hence, a simple direct extraction method was developed for sample preparation, using deuterated NMR solvents (Choi et al., 2006; Hendrawati et al., 2006; Khatib et al., 2006; Yang et al., 2006) (see Box 2.3).

For the metabolic profiling of *Strychnos* species (Frédérich et al., 2004), methanol- $d_4$  containing trifluoroacetic acid was used, with the analysis focusing on the indole alkaloids.

For chromatographic analytical methods, the sample must be dissolved in a solvent that is suitable for injection into the GC or HPLC system. For HPLC, the solvent must be closely related to the eluent of the HPLC-separation system. For GC analysis, derivatization is required, and several different methods have been re-

**Box 2.2** Two-phase extraction method for NMR analysis (Choi et al., 2004a,b,c, 2005).

- Add 2 mL chloroform, 1 mL methanol, and 1 mL water to 50–100 mg plant material.
- Ultrasonicate for 5 min, then centrifuge at 3000 rpm (1300 g) for 20 min at 4°C.
- Take upper phase of methanol-water fraction and lower phase of chloroform-methanol fraction.
- Evaporate both fractions using rotary evaporator and add 1 mL chloroform- $d$  to chloroform-methanol fraction and 1 mL of methanol- $d_4$  and  $\text{H}_2\text{O}-d_2$  ( $\text{KH}_2\text{PO}_4$  buffer, pH 6.0) to methanol-water fraction for NMR measurements.

**Box 2.3** Single-solvent extraction method for NMR metabolomics (Choi et al., 2006; Hendrawati et al., 2006; Khatib et al., 2006; Yang et al., 2006).

- Add 0.75 mL methanol- $d_4$  and 0.75 mL  $H_2O-d_2$  ( $KH_2PO_4$  buffer, pH 6.0) to 50–100 mg plant material.
- Vortex for 1 min.
- Ultrasonicate for 10 min.
- Centrifuge at 13 000 rpm (11 000 g) for 10 min at room temperature.
- Transfer 800  $\mu$ L of supernatant to NMR tube.

ported for this purpose (Fiehn et al, 2000b; Roessner et al., 2000). In the case of NMR, direct measurement in aqueous systems is possible (e.g., direct analysis of urine by NMR spectrometry), though better results are obtained using deuterated solvents. These solvents can be used for the primary extraction of the material, which is a simple and rapid method suited to high-throughput metabolome analysis. For MS analysis, different approaches can be used, for example injection of the dissolved extract or applying the extract on a sample probe introduced into the mass spectrometer.

When working with solvents it is essential to be aware of the risks of artifact formation (e.g., transesterifications, reactions with solvents, or reactions with contaminations in solvents). One should also be aware of the presence of different additives (e.g., 1% ethanol in chloroform, antioxidants in ethers) (Svendsen and Verpoorte, 1983) or contaminants (e.g., phthalates from plastics, detergents from dishwashers in glassware) (Middleditch, 1989).

As no single solvent is capable of extracting all metabolites, different extraction methods must be used to analyze all of the metabolites produced by an organism. In order to analyze the minor compounds in a metabolome, further fractionation steps might be included, either in the form of liquid-liquid extractions, solid-phase extraction, or perhaps fractionation by preparative column chromatography or centrifugal partitioning chromatography.

Whichever method is chosen, a thorough validation is always required, from harvesting to final analysis, to include intra-day and day-to-day variability of the procedure. This should result in a robust, reproducible method preferably suited to high-throughput metabolome analysis.

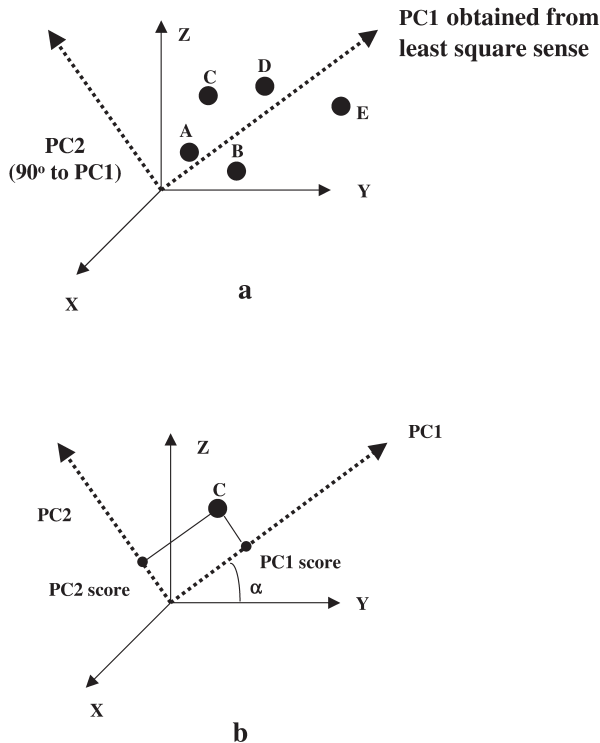
## 2.3

### Data Handling

The next stage in the process is to handle the large number of data sets obtained from the many samples that have been analyzed under different conditions. The analytical output must be identified and quantified, and chemometric methods such as multivariate data analysis have been shown to be excellent tools for this

purpose. These methods allow comparisons to be made of complex spectra or chromatograms, and patterns of co-occurring compounds, or clear differences between samples, to be identified. Among the methods of multivariate data analysis, principal component analysis (PCA) – which basically is a data reduction technique – is one of the most popular (Massart et al., 1988; Eriksson et al., 2001).

A simple example of PCA is shown in Figure 2.5, where five samples (e.g., plants or mammals) are compared with each other using three variables (retention time of chromatographic methods,  $m/z$  of mass spectrometry, and chemical shift of NMR spectrometry). For this matrix, a space containing three variables can be constructed, with each variable representing one co-ordinate axis. All samples are placed in the variable space based on the intensity of each variable. After plotting on the space, the best approximating line (in the least squares sense) can be constructed. Each sample may be projected on this approximating line to obtain principal component 1 (PC1). The original three values are then finally reduced to one value. If PC1 is insufficient to reveal the variation of samples, a second PC2 can be calculated orthogonal to the first PC. In the same way, other PCs may be ob-

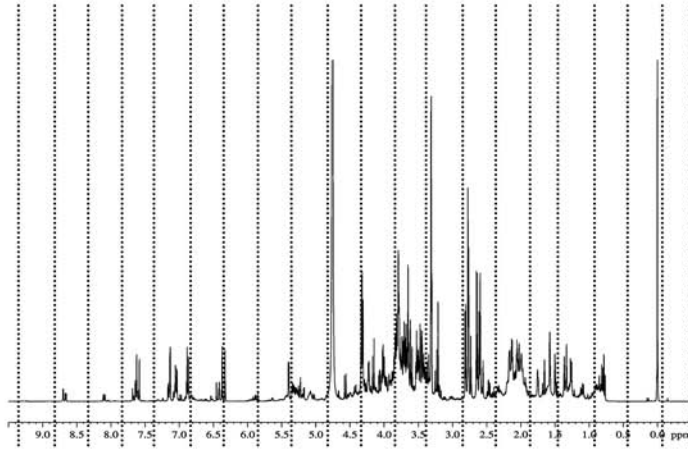


**Fig. 2.5** Simple example of principal component analysis. (a) Drawing PC1 and PC2 for five samples. (b) Obtaining PC scores of sample C and calculation of loading of variable Y. A, B, C, D, and E are samples; X, Y, and Z are variables.  $\alpha$  is the angle between PC1 and variable Y.

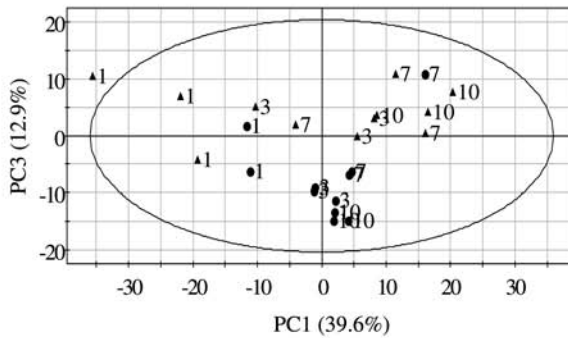
tained. Usually, the first three PCs are sufficient to determine the variation or grouping of samples. The plot containing the PC scores of each sample is called the “score plot”.

The next step is to identify the variables responsible for the separation of samples in the PCA score plot, and how these are correlated. This can be achieved with the loading plot. First, the cosine of the angle between the direction of a PC and each original variable is calculated. If the cosine value is close to 1 ( $0^\circ$ , overlap with each other), the PC is largely influenced by the original value. PCA can be carried out using commercial software such as AMIX-TOOLS<sup>®</sup> (Bruker Biospin GmbH, Rheinstetten, Germany; [www.bruker-biospin.de](http://www.bruker-biospin.de)), Matlab<sup>®</sup> with statistics toolbox (MathWorks Inc., Natick, MA, USA; [www.mathworks.com](http://www.mathworks.com)), Minitab<sup>®</sup> (Minitab Inc., State College, PA, USA; [www.minitab.com](http://www.minitab.com)), Pirouette (Infometrix Inc., Bothell, WA, USA; [www.infometrix.com](http://www.infometrix.com)), SIMCA-P (Umetrics, Umeå, Sweden; [www.umetrics.com](http://www.umetrics.com)), SPSS<sup>®</sup> (SPSS Inc., Chicago, IL, USA; [www.spss.com](http://www.spss.com)), or Unscrambler<sup>®</sup> (CAMO Software Inc., Woodbridge, NJ, USA; [www.camo.com](http://www.camo.com)). For data processing, scaling of the raw data is required before the PCA is carried out. Generally, a centered method provides better results than a unit-variance method for handling spectroscopic data because it can reduce unexpected artifacts from the signal noise. However, minor signals cannot be given the same significance as major signals. To avoid this problem of the centered scaling method, an alternative Pareto scaling has become more common (Eriksson et al., 2001).

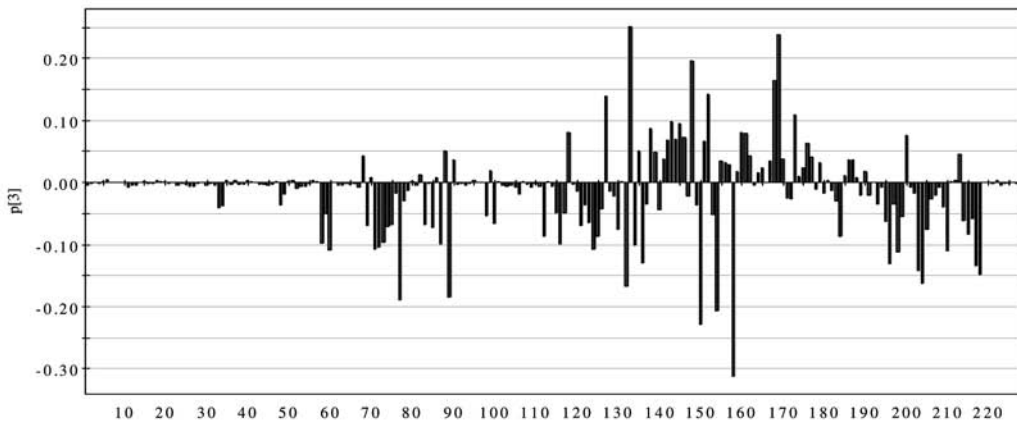
A practical example of multivariate data analysis of metabolomic data is shown in Figure 2.6, in which tobacco leaves infected with tobacco mosaic virus (TMV) are compared with corresponding leaves from healthy plants using NMR spectra (Choi et al., 2006). First, all measured NMR spectra were integrated. For an unbiased approach the spectrum is bucketed, yielding small segments (buckets or bins) for the whole  $^1\text{H}$ -chemical shift range ( $\delta$  0.4– $\delta$  10.0), the signal(s) intensity in each bucket (e.g., of 0.02 or 0.04 ppm width) is measured (Fig. 2.6a). This bucketing is carried out with commercial software such as AMIX-TOOLS<sup>®</sup> (Bruker Biospin GmbH, Rheinstetten, Germany; [www.bruker-biospin.de](http://www.bruker-biospin.de)) or ACD NMR Manager (Advance Chemistry Development, Toronto, Ontario, Canada; [www.acd-labs.com](http://www.acd-labs.com)) for NMR data, and MassLynx (Waters, Milford, MA, USA; [www.waters.com](http://www.waters.com)) for MS data. The bucketing is a crucial step for further PCA. Using such software it is possible to bucket not only in a fixed range but also in a more advanced flexible range after sorting splitting signals in the NMR spectrum. The bucketed data are further analyzed by PCA. A score plot clearly shows the similarities and variances of samples based on the metabolomic data (Fig. 2.6b). The influence of each metabolite signal is identified by the loading plot of PCA (Fig. 2.6c). In this case, infected and healthy tobacco leaves are clearly separated by PC3, which shows a higher score for the infected leaves. Therefore, positive signals in the PC3 loading plot are more abundant in the infected leaves, whereas negative signals are lower than the healthy leaves. After sorting the signals based on contribution value (loading) for separation, they are assigned to the signals in the raw  $^1\text{H}$  NMR and/or 2D-NMR spectra. If necessary, the compound is further identified after chromatographic separation.



a



b



c

**Fig. 2.6** (a) Data bucketing of NMR spectra; (b) score plot; and (c) loading plot of principal component analysis of healthy and infected *Nicotiana tabacum* leaves by tobacco mosaic virus (TMV). ●; lower leaves of healthy

plants, ▲; local-infected leaves of TMV-infected plants. The ellipse represents the Hotelling T2 with 95% confidence in score plots. Numberings on the plot are the dates after infection (Choi et al., 2006).

Clearly, in order to make metabolomics a globally used tool, standardization of the methods is required, and a generally accepted format for the data is required. For transcriptomics data such a format has been defined by the Microarray Gene Expressing Data (MGED) Society (<http://www.mged.org>). Standards for Minimum Information About a Microarray Experiment (<http://www.mged.org/Workgroups/MIAME/miame.html>; see also Brazma et al., 2001) have been defined through an international initiative. The research community has embraced this standard, and many major journals now require compliance with MIAME for any new submission (Anonymous, 2002). Whilst for metabolomics data the discussion is ongoing, it might be difficult to achieve a standard that will be accepted worldwide. For example, all efforts during the past 40 years to arrive at a standardized database for mass spectra have been unsuccessful. Here, a major problem is – and will continue to be – the variability in the data, due to the different MS methods applied. It is likely that NMR-spectra will in time become the simplest data for a globally accepted public database, particularly as the original dataset of the spectra can be stored and later translated into any desirable format. Whilst chromatograms with unknown peaks will be more difficult to store, treated chromatographic data resulting in tables of identified compounds and relative intensities can be produced; however, full quantitative data for all compounds are much more difficult to produce.

## 2.4

### The General Set-Up of a Metabolomics Project

The first step in a metabolomics project is to define the problem to be studied. Based on that, a choice must be made as to which analytical methods are most appropriate to answer the question. It may be necessary even to combine different methods, especially when both major and minor compounds are of importance. This includes deciding whether to use a targeted approach only on certain groups of metabolites, or a non-targeted approach in which as many metabolites as possible can be analyzed. For both approaches, the next decision is whether to identify and quantify all of the compounds observed, or to focus only on those compounds that clearly show different levels under the different experimental conditions.

To facilitate this choice, preliminary experiments are required to identify the degree of variability in the planned experiments. When the methods have been selected, the next step is qualitative, to analyze a series of representative samples, to identify as many compounds as possible by comparison with known databases, and to determine the experimental (e.g., sample preparation, extraction method, analytical method) and biological variability for one genotype (e.g., diurnal variations, developmental stage, external conditions). Once this dataset has been established, the next step is to measure the organism under different experimental conditions, to determine variations by statistical means (e.g., multivariate analysis), and to combine these data with other data such as transcriptomics. The strength of multivariate analysis lies in the fact that any type of data can be used for the analy-

sis, including physiological (e.g., blood pressure) and morphological data, as the original data are dimensionless.

## 2.5

### Applications

Besides applications in functional genomics, the metabolomic approach has become very useful in studies of genetically modified organisms, notably to identify possible differences from the wild-type organism. The use of metabolic profiles has also been used for the quality control of food and medicinal plants. Likewise, when identifying new leads for drug development from natural sources, the metabolomics approach would be of great value for the rapid identification of known active compounds. Finally, the use of metabolomics might also be envisaged for studying the activity of medicinal plants. The measurement of pharmacological activity in a living organism (be it a cell culture, an animal, or a patient) of extracts with different compositions may allow the identification of a compound – or indeed a combination of compounds – that correlate with such activity. In this way, pro-drugs or synergism might also be recognized, in addition to new modes of drug action and drug targets.

Clearly, this systems biology approach will represent a major challenge over the next few years for the study of medicinal plants. Moreover, metabolomics represents a totally new approach to drug discovery that should replace the single compound–single target concept that for many years has been the paradigm of drug development, but which is producing fewer novel medicines each year.

## 2.6

### Conclusions

The analysis of the full metabolome of an organism requires a combination of analytical methods, since no single technique can cover the vast range of spectra of the compounds present. Moreover, these methods must be robust and very reproducible, since large quantities of data will be needed if metabolomics is to be applied to areas such as functional genomics or systems biology. The techniques employed are mature chromatographic methods such as GC-MS and HPLC, or physical approaches such as mass spectrometry and NMR, all of which have long histories in the analysis of natural products. Ultimately, the data produced will require powerful biostatistical methods for their analysis, and multivariate approaches and neural networks are being developed for this purpose.

Today, despite no international conventions existing for data storage and presentation relating to the metabolomics approach, a variety of international databases for MS and NMR contain the spectra of very many pure compounds. Whilst public databases with metabolome profiles do not yet exist, there is clear need for their future development in the advancement of metabolomics.

## References

- Anonymous. Microarray standards at last. *Nature* **2002**, 419, 323.
- Brazma, A., Hingamp, P., Quackenbush, J., Sherlock, G., Spellman, P., Stoeckert, C., Aach, J., Ansorge, W., Ball, C.A., Causton, H.C., Gaasterland, T., Glenisson, P., Holstege, F.C., Kim, I.F., Markowitz, V., Matese, J.C., Parkinson, H., Robinson, A., Sarkans, U., Schulze-Kremer, S., Stewart, J., Taylor, R., Vilo, J., Vingron, M. Minimum information about a microarray experiment (MIAME)-toward standards for microarray data. *Nat. Genet.* **2001**, 29, 365–371.
- Chen, F., Duran, A.L., Blount, J.W., Sumner, L.W., Dixon, R.A. Profiling phenolic metabolites in transgenic alfalfa modified in lignin biosynthesis. *Phytochemistry* **2003**, 64, 1013–1021.
- Choi, Y.H., Yoo, K.-P. Kim, J. Supercritical fluid extraction of bilobalide and ginkgolides from *Ginkgo biloba* leaves using a mixture of CO<sub>2</sub>, methanol, and water. *Chromatographia* **2002**, 56, 753–757.
- Choi, H.-K., Choi, Y.H., Verberne, M., Lefeber, A.W.M., Erkelens, C., Verpoorte, R. Metabolic fingerprinting of wild type and transgenic tobacco plants by <sup>1</sup>H NMR and multivariate analysis technique. *Phytochemistry* **2004a**, 65, 857–864.
- Choi, Y.H., Kim, H.K., Hazekamp, A., Erkelens, C., Lefeber, A.W.M., Verpoorte, R. Metabolomic differentiation of *Cannabis sativa* cultivars using <sup>1</sup>H NMR spectroscopy and principal component analysis. *J. Nat. Prod.* **2004b**, 67, 953–957.
- Choi, Y.H., Tapias, E.C., Kim, H.K., Lefeber, A.W.M., Erkelens, C., Verhoeven, J.T.J., Brzin, J., Zel, J., Verpoorte, R. Metabolic discrimination of *Catharanthus roseus* leaves infected by phytoplasma using <sup>1</sup>H-NMR spectroscopy and multivariate data analysis. *Plant Physiol.* **2004c**, 135, 2398–2410.
- Choi, Y.H., Sertic, S., Kim, H.K., Wilson, E.G., Michopoulou, F., Lefeber, A.W.M., Erkelens, C., Kricun, S.D.P., Verpoorte, R. Classification of *Ilex* species based on metabolomic fingerprinting using NMR and multivariate data analysis. *J. Agric. Food Chem.* **2005**, 53, 1237–1245.
- Choi, Y.H., Kim, H.K., Linthorst, H.J.M., Hollander, J.G., Lefeber, A.W.M., Erkelens, C., Nuzillard, J.-M., Verpoorte, R. NMR metabolomics to revisit the tobacco mosaic virus infection in *Nicotiana tabacum* leaves. *J. Nat. Prod.* **2006**, 69, 742–748.
- Duran, A.L., Yang, J., Wang L., Sumner, L.W. Metabolomics spectral formatting, alignment and conversion tools (MSFACTs). *Bioinformatics* **2003**, 19, 2283–2293.
- Eriksson, L., Johansson, E., Kettaneh-Wold, N., Wold, S. *Multi-and megavariable data analysis*. Umetrics, Umeå, Sweden, **2001**.
- Fiehn, O., Kopka, J., Dormann, P., Altmann, T., Trethewey, R.N., Willmitzer, L. Metabolite profiling for plant functional genomics. *Nat. Biotechnol.* **2000a**, 18, 1157–1161.
- Fiehn, O., Kopka, J., Trethewey, R.N., Willmitzer, L. Identification of uncommon plant metabolites based on calculation of elemental compositions using gas chromatography and quadrupole mass spectrometry. *Anal. Chem.* **2000b**, 72, 3573–3580.
- Frédérich, M., Choi, Y.H., Angenot, L., Harnischfeger, G., Lefeber, A.W.M., Verpoorte, R. Metabolomic analysis of *Strychnos nux-vomica*, *icaja* and *ignatii* extracts by <sup>1</sup>H nuclear magnetic resonance spectrometry and multivariate analysis techniques. *Phytochemistry* **2004**, 65, 1993–2001.
- Hendrawati, O., Yao, Q., Kim, H.K., Linthorst, H.J.M., Erkelens, C., Lefeber, A.W.M., Choi, Y.H., Verpoorte, R. Metabolic differentiation of *Arabidopsis* treated with methyl jasmonate using nuclear magnetic resonance spectroscopy. *Plant Sci.* **2006** (in press).
- Ishii, N., Soga T., Nishioka T., Tomita M. Metabolome analysis and metabolic simulation. *Metabolomics* **2005**, 1, 29–37.
- Jacobs, D.I., Van der Heijden, R., Verpoorte, R. Proteomics in plant biotechnology and secondary metabolism research. *Phytochem. Anal.* **2000**, 11, 277–287.
- Khatib, A., Wilson, E.G., Kim, H.K., Lefeber, A.W.M., Erkelens, C., Choi, Y.H., Verpoorte, R. Application of two



- dimensional J-resolved nuclear magnetic resonance spectrum to differentiation of beer. *Anal. Chim. Acta* **2006**, 559, 264–270.
- Kim, H.K., Choi, Y.H., Erkelens, C., Lefeber, A.W.M., Verpoorte, R. Metabolic fingerprinting of *Ephedra* species using  $^1\text{H-NMR}$  spectroscopy and principal component analysis. *Chem. Pharm. Bull.* **2005**, 53, 105–109.
- Liang, Y.-S., Kim, H.K., Lefeber, A.W.M., Erkelens, C., Choi, Y.H., Verpoorte, R. Identification of phenylpropanoids in *Brassica rapa* leaves treated with methyl jasmonate using two-dimensional nuclear magnetic resonance spectroscopy. *J. Chromatogr. A* **2006**, 1112, 148–155.
- Massart, D.L., Vandeginste, B.G.M., Deming, S.N., Michotte, Y., Kauffman, L. *Chemometrics: A Textbook*. Elsevier, New York, **1988**.
- Middleditch, B.S. *Analytical artifacts*. Elsevier, Amsterdam, The Netherlands, **1989**.
- Nielsen, N.-P.V., Carstensen, J.M., Smedsgaard, J. Aligning of single and multiple wavelength chromatographic profiles for chemometric data analysis using correlation optimised warping. *J. Chromatogr. A* **1998**, 805, 17–35.
- Roessner, U., Wagner, C., Kopka, J., Trethewey, R.N., Willmitzer, L. Simultaneous analysis of metabolites in potato tuber by gas chromatography-mass spectrometry. *Plant J.* **2000**, 23, 131–142.
- Schwab, W. Metabolome diversity: too few genes, too many metabolites? *Phytochemistry* **2003**, 62, 837–850.
- Suhartono, L., Van Iren, F., De Winter, W., Roytrakul, S., Choi, Y.H., Verpoorte, R. Metabolic comparison of cryopreserved and normal cells from *Tabernaemontana divaricata* suspension cultures. *Plant Cell Tiss. Org. Cult.* **2005**, 83, 59–66.
- Svendsen, A.B., Verpoorte, R. *Chromatography of alkaloids part A: thin-layer chromatography*. Elsevier, Amsterdam, The Netherlands, **1983**, pp. 51–50.
- Sumner, L.W., Mendes, P., Dixon, R.A. Plant metabolomics: large-scale phytochemistry in the functional genomics era. *Phytochemistry* **2003**, 62, 817–836.
- Ward, J., Harris C., Lewis, J., Beale, M.H. Assessment of  $^1\text{H NMR}$  spectroscopy and multivariate analysis as a technique for metabolite fingerprinting of *Arabidopsis thaliana*. *Phytochemistry* **2003**, 62, 949–958.
- Yang, S.Y., Kim, H.K., Lefeber, A.W.M., Erkelens, C., Angelova, N., Choi, Y.H., Verpoorte, R. Application of two-dimensional nuclear magnetic resonance spectroscopy to quality control of ginseng commercial products. *Planta Med.* **2006**, 72, 364–369.

### 3

## HPLC-NMR Techniques for Plant Extract Analysis

*Dan Stærk, Maja Lambert, and Jerzy W. Jaroszewski*

### 3.1

#### Introduction

Mankind has relied on medicinal plants since time immemorial. Written records about the use of medicinal plants include the Chinese Pen Tsao, or The Great Herbal, compiled by Shen Nung who lived around 3000 BC, the Ebers Papyrus, the earliest record of Egyptian medicine from 1600 BC, the Hindu holy books, the Vedas, dated from before 1000 BC (some of them much older), and *De Materia Medica* by Dioscorides from 78 AD. Despite recent advances in biotechnology, synthetic combinatorial chemistry, and high-throughput screening, natural products from plants continue to serve as a major source of new chemical entities for pharmaceutical research [1, 2]. Although chemists and pharmacologists have explored many thousands of plants, most investigations have been restricted to the structural characterization of a few major constituents or to the assessment of a single biological activity *in vitro*. Therefore, the potential of even relatively thoroughly investigated plants must ironically be regarded as still largely unexplored. In addition, although the total number of plant species on the Earth and their extinction rate remain the matter of debate [3], it is clear that chemical and pharmacological knowledge exists about only a small percentage of the total number of species. The disappearance of many biotopes rich in endemism means that many of as-yet unexplored plants will never be investigated. An acceleration of the process of mapping the chemical diversity of plants is therefore of utmost importance. This can only be achieved if new methods for the rapid dereplication of natural products from plant extracts – preferably methods that are more sensitive than those available today – are developed.

Most studies on secondary metabolites from plants are related to a biological activity that is based on traditional use, or has been observed through screening programs using *in-vitro* bioassays [4–7]. The traditional process of isolating and characterizing bioactive natural products is a very time-consuming process. In addition, only a single or a few biological activities can be monitored during a bioactivity-guided isolation process, leading to the risk of overlooking potentially impor-

tant activities. The absence of structural information about the active constituents until the isolation procedure has been completed leads to the risk of isolating already known or otherwise trivial compounds. For these reasons, there is a need for tools providing full or partial information about the structure of extract constituents as early as possible in the fractionation process. The targeted isolation of natural products, guided by the novelty of their chemical structures and followed by screening of pure compound libraries (which can, in principle, be done for a large variety of bioactivities), is thus an attractive alternative to the traditional bioactivity-guided isolation approach [8, 9].

Finally, modern biotechnology creates the possibility of accessing the chemical diversity of natural products and of translating genetic diversity of organisms into an expanded chemical space of small molecules [10, 11] through other approaches than screening and isolation. Thus, transgenic plants, studies on regulation of metabolic networks, engineering of biosynthetic pathways, and metabolomics/metabonomics [12–15] create the need for high-throughput phytochemistry and research tools providing system-wide chemical data. Given the unsurpassed structure–identification capabilities of NMR spectroscopy and the current ability of this spectroscopic technique to operate at the microgram and submicrogram levels, hyphenation of separation methods with NMR is of particular interest for modern natural products research.

### 3.2

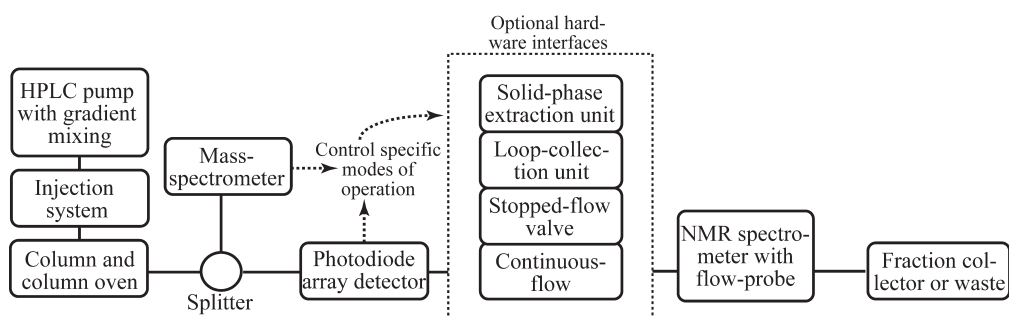
#### Hyphenation of Separation Techniques and Spectroscopic Methods

The coupling of two or more analytical techniques into one integrated technique is usually indicated by use of a hyphen, as in gas chromatography-mass spectrometry (GC-MS). The hyphenation of high-performance liquid chromatography (HPLC) with different detection techniques that provide some structural information has contributed considerably to the progress in natural products research over the past few decades. The HPLC detectors can be categorized into those giving a single quantitative response, such as single-wavelength ultraviolet detectors (HPLC-UV), fluorescence detectors (HPLC-fluorescence), and evaporative light-scattering detectors (HPLC-ELS), and those giving a series of spectra at small time-intervals throughout the chromatographic run. While the former category only gives peak-information about the eluting compounds, the latter can provide valuable structural information. The last category includes hyphenation of HPLC with photodiode array detection (HPLC-PDA or HPLC-DAD) [16], with mass spectrometry (HPLC-MS and HPLC-MS<sup>n</sup>) [17], with circular dichroism (HPLC-CD) [18], and with infrared spectroscopy (HPLC-IR) [19]. However, none of these spectroscopic methods allows rigorous structure elucidation. Many previously characterized natural products may be identified using spectral databases, but overall the spectral information obtained from these techniques is insufficient. This contrasts the detailed spectral information obtained from nuclear magnetic resonance (NMR). NMR spectroscopy has the advantage of being a nonselective and nondestructive tech-

nique that will detect all hydrogen-containing compounds (for  $^1\text{H}$  NMR spectroscopy) present above the detection limit. In addition, full structural assignment including relative stereochemistry is available through two-dimensional (2D) experiments, and carbon data are available through heteronuclear  $^1\text{H}$ - $^{13}\text{C}$  correlation experiments.

The initial hyphenation of HPLC and NMR was carried out with iron magnets during the late 1970s and early 1980s [20–26]. The more recent development of superconducting shielded magnets with higher field strengths has improved the sensitivity and allowed positioning of the HPLC systems close to the magnet. A modern HPLC-NMR system consists of a shielded superconducting magnet (at present typically 400–600 MHz proton frequencies) and a supplementary mass spectrometer coupled directly to the HPLC system, as shown schematically in Figure 3.1. The computer-controlled HPLC system consists typically of a pump capable of delivering a nonpulsating binary or less frequent ternary solvent gradient, an automated injection system, and a column oven to improve reproducibility of the chromatographic run. The eluate is split usually in a 1:19 ratio, with the higher proportion directed to a PDA detector and then the NMR flow-cell through small inner-diameter capillaries. The lower proportion is directed to the more sensitive but also destructive MS detector. The UV- and MS signals are detected by the hyphenation software, and these signals trigger further events according to the pre-programmed system operation mode.

In contrast to traditional NMR operation, where NMR tubes are situated in a rotating spinner to increase effective field homogeneity, the flow-cell is designed as a nonrotating vertical glass tube with radiofrequency (RF) coils attached directly to the middle of the glass tube, and both ends connected to HPLC capillaries [27]. Most applications are performed with “inverse configuration” flow-probes, where the RF coil tuned and matched to the  $^1\text{H}$  NMR frequency is fixed directly to the glass tube, and the second coil, tuned and matched typically to the  $^{13}\text{C}$  NMR frequency, is placed outside the latter. However, normal configuration flow-probes –



**Fig. 3.1** Schematic representation of a typical, hyphenated NMR system. The HPLC column eluate is split in a 1:19 ratio and analyzed in parallel by the mass spectrometer and by the photodiode array detector, and the NMR spectrometer, respectively. Various optional hardware interfaces are used for different HPLC-NMR modes, as illustrated by the dashed box.

that is, with the  $^{13}\text{C}$  coil placed inside and closer to the sample for increased sensitivity of  $^{13}\text{C}$  detection – are also available. It should also be pointed out, that the active volume of NMR flow-cells (30, 60, 120, and 200  $\mu\text{L}$  in current use) account for only one-half of the total cell volume. Thus, because of free diffusion of the analyte within the cell, only one-half of the analyte present in the flow-cell will actually contribute to the NMR signal.

### 3.3

#### Direct HPLC-NMR Methods

There are two fundamentally different ways of hyphenating HPLC and NMR spectroscopy: direct hyphenation, which involves the acquisition of NMR data with the analyte dissolved in the HPLC mobile phase (i.e., with the column effluent), and indirect hyphenation, where the NMR spectra are acquired after the analyte has been isolated from the mobile phase [28, 29].

The direct HPLC-NMR methods use NMR spectrometers similarly to the use of other HPLC detectors, but with adaptations necessary in order to accommodate the lower sensitivity of NMR. A major problem with direct HPLC-NMR methods is related to a limited dynamic range of the analogue-to-digital converter of NMR spectrometers. HPLC is preferably performed with standard nondeuterated solvents, which means that signals from compounds present in low concentrations (milli- or submillimolar) should be detected in the presence of much stronger signals from the solvent (e.g., pure water corresponds to 55 M  $\text{H}_2\text{O}$ ). The problem can be partly solved by using deuterated solvents for HPLC, but for most solvents other than  $\text{D}_2\text{O}$  the price is too high for routine applications. In addition, the use of  $\text{D}_2\text{O}$  can complicate mass spectra of compounds containing exchangeable hydrogens, and can also possibly affect the separation via isotope effects. For these reasons it is important to apply techniques that can suppress multiple solvent signals, including suppression of solvent resonances that change position under gradient conditions. For 1D spectra, this can be achieved by a 1D NOESY pulse sequence with pre-saturation of solvent signals during relaxation delay and mixing time [30]. Another possibility is the WET pulse sequence (water suppression enhanced through  $T_1$  effects) [31] that applies a series of variable tip-angle, solvent-selective RF pulses, followed by dephasing field-gradient pulses. The WET pulse sequence is easily combined with standard 2D NMR experiments to give excellent solvent suppression.

#### 3.3.1

##### Continuous-Flow HPLC-NMR

The continuous-flow HPLC-NMR mode is the simplest mode of operation, and it does not require any hardware interfaces other than a capillary connection to the NMR flow-probe (Fig. 3.1).  $^1\text{H}$  NMR spectra are acquired continuously during the entire HPLC separation, and the data are saved as a pseudo 2D NMR dataset with the  $^1\text{H}$  NMR spectral window along one axis and the separation time along the oth-

er axis. Because of the limited residence time of the analytes in the NMR flow-cell, it is necessary to make a compromise between the signal-to-noise (S/N) ratio of the NMR data (the number of scans for each 1D dataset), and the resolution along the HPLC separation axis (the total number of spectra). These numbers are inherently inversely proportional. Early studies on the relation between the flow rate, flow-cell volume, and acquisition time have been performed [32–34] in order to optimize continuous-flow HPLC-NMR experiments. Today, most applications of continuous-flow HPLC-NMR to natural products are performed on reversed-phase  $C_{18}$  columns ranging between 4 and 8 mm i.d., at flow rates of 0.3 to 1.2 mL min<sup>-1</sup>, adding 16 to 64 scans per spectrum, and using flow-cells with detection volumes of 60 to 120  $\mu$ L [18, 35–46]. This results in typical analysis times ranging from 20 min to a few hours, although experiments with a reduced flow rate of 0.15 mL min<sup>-1</sup> and 256 scans per spectrum, resulting in analysis times exceeding 12 h, have been reported [47].

The main advantage of continuous-flow HPLC-NMR is its simplicity, although the technique is less sensitive than other HPLC-NMR modes discussed below. This is mostly because of the limited residence time of the analytes in the flow-cell, but also because the volume of most HPLC peaks exceeds the volume of the NMR flow-cell, thereby placing much of the analyte outside the cell during data acquisition. The detection limit of the secoiridoid swertiamarin (MW 374 Da) was shown to be 20  $\mu$ g in the continuous-flow mode after separation at a flow rate of 1 mL min<sup>-1</sup>, using a 60- $\mu$ L flow-probe, a spectrometer operating at 500 MHz, and acquiring 16 scans for each spectrum [48]. A detection limit of 24  $\mu$ g was found for a minor constituent (MW 568 Da) of an artificial mixture of carotenoids eluted with a flow rate of 0.3 mL min<sup>-1</sup>, using a 120- $\mu$ L flow-probe operating at 600 MHz, and acquiring 128 scans for each spectrum [46].

For the analysis of crude extracts by continuous-flow HPLC-NMR, the amount injected onto the column is typically well above 1 mg (depending on the complexity of the mixture and the loading capacity of the column), but for partly purified fractions good spectra can be acquired with smaller amounts. One example is a study employing combined use of HPLC-MS and continuous-flow HPLC-NMR to a partially purified extract of *Vernonia fastigiata* [49]. Separation of 700  $\mu$ g of the extract was performed on a  $C_{18}$  column eluted with a water-acetonitrile gradient or with a water-methanol gradient. This provided two sets of spectra with no overlap of regions affected by solvent suppression, and allowed rapid identification of nine sesquiterpene lactones. Because the continuous-flow HPLC-NMR mode is independent of other peak-selection methods, it is normally used in initial studies of the major components of plant extracts, followed by HPLC-NMR investigations under static conditions.

### 3.3.2

#### Stopped-Flow HPLC-NMR

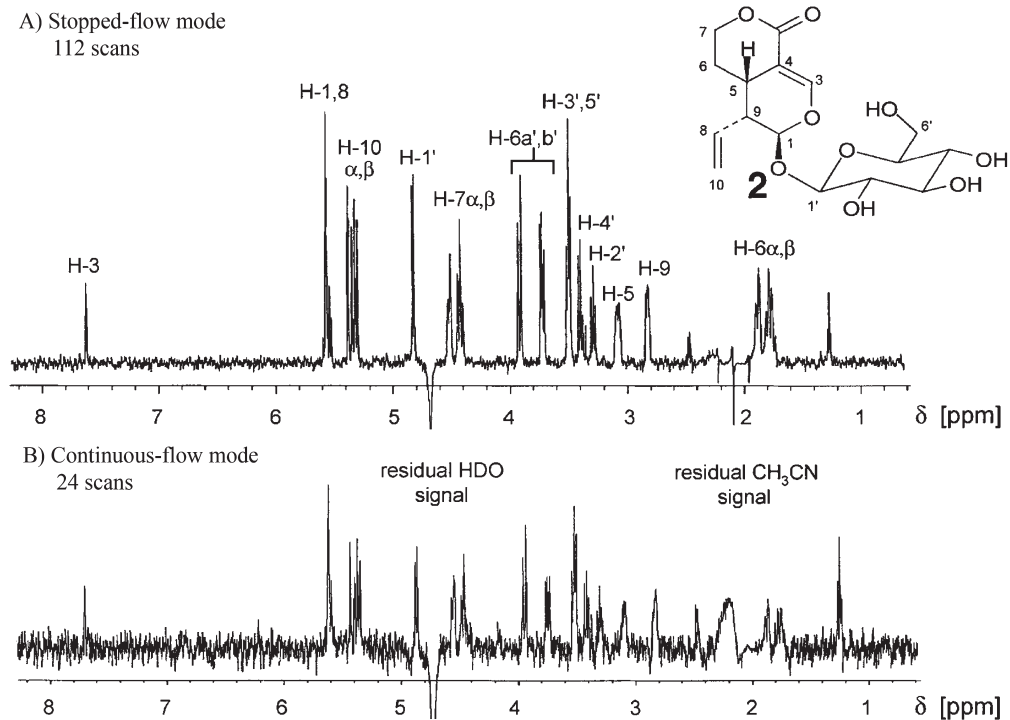
HPLC-NMR systems can be operated in the stopped-flow mode, which gives the time needed to acquire 1D spectra with increased S/N ratio compared to those ob-

tained in continuous-flow mode or, if necessary, to perform 2D NMR experiments needed for full structure elucidation of extract constituents. As the name implies, the flow is stopped when the analyte of interest enters the flow-cell. The compounds of interest for stopped-flow acquisition are usually detected using an upstream PDA-detector or MS, and either threshold limits in UV- and/or mass TIC chromatograms, selective ion chromatograms, or daughter ions from MS/MS, are used to trigger the stopped-flow valve for exact positioning of the analyte in the flow-cell (see Fig. 3.1). All operations are carefully timed and automated by hyphenation software that controls both the HPLC system, including the PDA detector and stopped-flow valve, the mass spectrometer, and the NMR data acquisition. The stopped-flow mode allows careful optimization of shims, and especially the solvent suppression benefits from improved field homogeneity. Tuning, matching, and pulse calibration can also be more carefully optimized under static conditions. This, combined with prolonged data accumulation times, provides the possibility of acquiring spectra with reasonable S/N ratio for compounds other than the major constituents. Prolonged periods with stopped flow may cause diffusion-mediated band broadening on the HPLC column, and therefore repeated stops and restarts of the flow may lead to unacceptable loss of sensitivity. This problem can be solved by using separate chromatographic runs for each analyte of interest, but for most applications related to natural products, where extracts contain many different compounds and chromatographic runs exceed 30 min, this is not an attractive solution.

The stopped-flow HPLC-NMR mode has been used for investigations of constituents of *Hypericum perforatum* extract [50], where UV and MS data were used to trigger stopped-flow measurements. A single pre-purification step by solid-phase extraction allowed acquisition of good quality  $^1\text{H}$  NMR spectra of minor constituents at the level of 0.1%.

Another study [51] used the continuous-flow mode for initial investigation of dichloromethane extract of *Swertia calycina*, followed by stopped-flow  $^1\text{H}$  NMR and 2D WETCOSY experiments for more reliable structural characterization of one of the extract constituents, sweroside. A comparison of the  $^1\text{H}$  NMR spectrum obtained from continuous-flow and from stopped-flow HPLC-NMR is shown in Figure 3.2. Several other applications of the stopped-flow HPLC-NMR mode, including use of COSY, TOCSY, NOESY, ROESY, and HSQC experiments, have been reported [37, 46, 52].

Another important application of stopped-flow HPLC-NMR is the determination of absolute configuration of secondary alcohols by the Mosher method [53–55]. The traditional way of analyzing Mosher's esters involves the formation of several milligrams of each diastereomer and subsequent preparative-scale isolation for NMR data acquisition in tubes. In the HPLC-NMR approach, only a few micrograms of the secondary alcohol are necessary. Formation of the esters is performed in HPLC vials, and the reaction mixture is analyzed by stopped-flow HPLC-NMR immediately after ester formation is complete. Thus, the reduced volume and increased sensitivity of the NMR flow-probe makes it possible to establish the absolute stereochemistry of natural products at a very low concentration level.



**Fig. 3.2** Comparison of stopped-flow mode (A) and continuous-flow mode (B) HPLC-NMR spectra of sweroside from the crude extract of *Swertia calycina*. Crude extract (1 mg) was injected onto a  $150 \times 3.9$  mm i.d.  $\text{C}_{18}$  column eluted with a linear gradient of

acetonitrile in water at a flow-rate of  $1 \text{ mL min}^{-1}$ . Spectra were acquired at 500 MHz using a  $60 \mu\text{L}$  inverse detection flow-probe. (Reproduced with permission from [51]; Copyright John Wiley & Sons, Ltd.)

Partly overlapping peaks can be investigated with the time-slice mode of operation. In this mode, the flow is stopped at short intervals during the peak elution, acquiring a series of  $^1\text{H}$  NMR spectra under stopped-flow conditions. The method is essentially stopped-flow performed at regular intervals, and as such it requires the stopped-flow valve. Upstream UV or MS detectors can be used to control time-slicing of selected HPLC peaks, or time-slicing can be applied to the entire chromatogram, in order not to overlook compounds that do not respond to these detectors. One example of the latter method is analysis of beer [56].

For compounds with MW around 500 Da, the detection limit in stopped-flow experiments at the  $^1\text{H}$  observation frequency of 600 MHz is about 100 ng [57]. The acquisition of 2D  $^1\text{H}$ - $^1\text{H}$  data with 1  $\mu\text{g}$  can be performed in a few hours, whereas overnight acquisition of 2D  $^1\text{H}$ - $^{13}\text{C}$  correlation data requires approximately 20  $\mu\text{g}$  of material [48].



## 3.3.3

**Loop-Collection HPLC-NMR**

The loop-collection mode makes use of a so-called peak sampling unit (see Fig. 3.1). The system contains 12 or 36 capillary loops, each of which can be made a part of the HPLC eluent transfer path through the use of automated valves, triggered by a detector signal threshold. This makes it possible to collect 12 or 36 compounds in individual loops without stopping the chromatographic run, thereby removing diffusion problems associated with stopped-flow HPLC-NMR. Once chromatography is completed, the loop content is transferred to the NMR flow-cell through connecting capillaries. At this post-chromatographic stage, the loop-collection unit can be regarded as an autosampler for the NMR system, and both short- and long-term NMR experiments can be conducted independently from the chromatographic separation. Another advantage of the loop-collection mode compared to the stopped-flow mode is that an additional washing step of the NMR flow-cell can be introduced between each transfer of the analyte, thereby avoiding any sample carryover.

Loop-collection HPLC-NMR has proven to be a valuable method in the field of natural products research [58, 59]. One example is a study employing HPLC-NMR-MS/MS for identification of quercetin and phloretin glycosides in apple peel extract [58]. Several closely eluting peaks, as determined by UV- and TIC MS-traces, were observed in the chromatogram. Threshold levels in UV spectra as well as detection of masses corresponding to quercetin ( $m/z$  302) and phloretin ( $m/z$  274) in MS/MS experiments, were used to trigger loop collection. This study successfully identified nine quercetin and phloretin glycosides in varying amounts using 1D TOCSY spectra. The 1D  $^1\text{H}$  NMR spectra for the least-abundant component, rutin, which was present in an amount of approximately 4  $\mu\text{g}$ , was obtained in 1.5 h.

The loop-collection method suffers from the same restrictions, with respect to sensitivity and solvent suppression, as the stopped-flow method. In principle, 2D  $^1\text{H}$ - $^1\text{H}$  and inverse  $^1\text{H}$ - $^{13}\text{C}$  correlation spectra can be obtained, but this requires a high analyte concentration in the chromatographic elution band, a requirement inherent to the use of direct-type HPLC-NMR methods. The limit of detection is thus, in principle, the same as for stopped-flow HPLC-NMR.

## 3.4

**Indirect HPLC-NMR Methods**

The only indirect HPLC-NMR method developed to date is the HPLC-SPE-NMR technique. Here, separation of the analyte from the HPLC mobile phase is achieved by means of solid-phase extraction [29]. Indirect NMR hyphenation is therefore, in fact, an automated, on-line, microscale version of traditional procedures involving “preparative” isolation of mixture components by chromatography, followed by their examination using NMR tubes.

One major disadvantage of direct HPLC-NMR methods is the relative incompatibility between standard HPLC solvents and NMR spectroscopy. This problem is

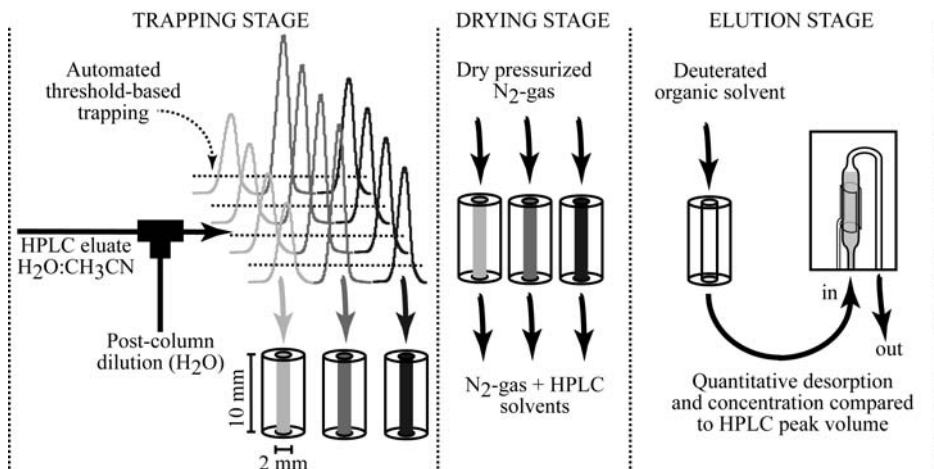
only partly solved with modern solvent peak-suppression techniques, because analyte resonances under or close to the suppressed peak are also affected. The limited detectability due to limited loading capacity of the columns is another disadvantage, which is further amplified by the fact that the separated analytes are often distributed in peak elution volumes that are much larger than the active volume of the NMR flow-cell. In addition, the HPLC solvent gradients typically used in continuous-flow experiments create problems with changing magnetic susceptibility and field homogeneity as well as shifts of analyte resonances, thereby complicating identification based on reference chemical shift values found in literature or in spectral databases. The newly developed hyphenation of HPLC and NMR intervened by an automated solid-phase extraction unit (HPLC-SPE-NMR) circumvents many of the problems listed above, while still working as a fully integrated and automated technique.

#### 3.4.1

##### **HPLC-SPE-NMR**

Solid-phase extraction has previously been used for on-line concentration of samples before chromatographic separation and NMR analysis – that is, as the SPE-HPLC-NMR technique [60]. However, the loading capacity of the HPLC column is still a factor limiting NMR performance of this method. Solid-phase extraction has also been used for off-line analyte isolation from HPLC fractions prior to traditional NMR analysis [61]. Another more recent approach used off-line preparative-scale HPLC followed by on-line SPE-NMR [62,63]. The first reported on-line HPLC-SPE-NMR coupling [64] employed post-column dilution of effluent from of a reversed-phase column with D<sub>2</sub>O to facilitate analyte trapping on a C<sub>18</sub> guard column. The guard column was subsequently back-flushed with CD<sub>3</sub>CN in order to desorb the analyte and transfer it into the NMR flow-cell in a narrow elution band. This study showed an increment in the S/N ratio of 1.5 to 2.3 compared to stopped-flow HPLC-NMR. Modern, commercially available HPLC-SPE-NMR systems include an on-line and fully automated solid-phase extraction unit (see Fig. 3.1). In this setup, a PDA detector and/or MS are used to trigger the SPE trapping of analytes similarly to triggering containment of the analyte band in the loop-storage mode.

The principle of operation of the HPLC-SPE-NMR system is shown schematically in Figure 3.3. In the trapping stage, the HPLC eluate is diluted with water to decrease the eluting power. The analytes of interest are then individually adsorbed (trapped) on small cartridges, each containing a suitable SPE material equilibrated with water, via automated valve switching. In the drying stage, pressurized nitrogen gas is used to dry the cartridges, thereby avoiding the appearance of signals from nondeuterated HPLC and post-column dilution solvents in the NMR spectra. SPE cartridges are stored in a nitrogen atmosphere to avoid contamination and to reduce the risk of analyte oxidation. Trapped analytes are transferred to the NMR flow-cell in the elution stage, where dried cartridges are flushed with a deuterated organic solvent.



**Fig. 3.3** The principle of the HPLC-SPE-NMR experiment. Trapping stage: post-column dilution with water allows repeated adsorption of the same analyte on the same cartridge in successive chromatographic runs, thereby increasing the analyte amount. Drying

stage: nondeuterated HPLC solvents are removed by drying with pressurized nitrogen gas. Elution stage: the analyte is desorbed from the SPE cartridge material with a deuterated solvent and transferred to the NMR flow-cell.

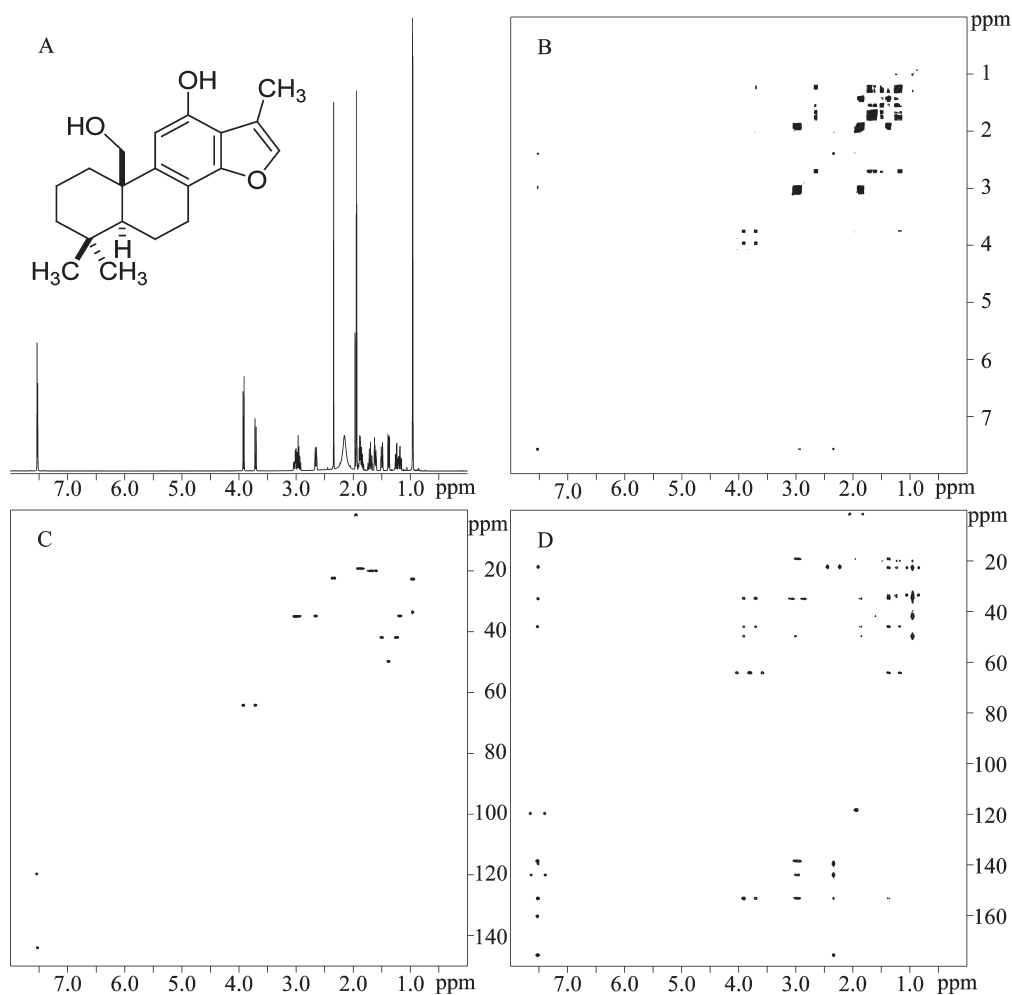
There are several advantages of the HPLC-SPE-NMR mode compared to the direct HPLC-NMR methods [29]. First, because of the SPE trapping step and cartridge drying, there are much fewer restrictions on the choice of HPLC mobile phases. Methods developed for optimal resolution, including those employing multicomponent solvent mixtures and buffers, can therefore be directly applied to the HPLC-SPE-NMR experiments. The only restriction is that the properties of the analyte must be such that it is adsorbed onto the SPE cartridge under actual post-column dilution conditions. The SPE separation of the analyte from the HPLC mobile phase implies that transfer from the SPE cartridge to the NMR flow-cell can be performed with deuterated organic solvents. The amount that must be used for the transfer is the volume of the flow-probe plus the volume of the connecting capillaries. This is typically of the order of a few hundred microliters per sample, and therefore the use of high-quality deuterated organic solvents is affordable for routine use. The use of pure deuterated solvents means that solvent suppression is either unnecessary or much easier to perform than in direct HPLC-NMR methods. As mentioned earlier, the reproducibility of chemical shift values associated with the use of pure deuterated organic solvents is important in terms of comparisons of observed chemical shift values. Further, the sensitivity of the HPLC-SPE-NMR experiment is no longer decreasing with increasing peak broadening, as long as adsorption of the analyte onto the SPE material is effective. Thus, if the analyte from the entire HPLC-peak volume is adsorbed onto the SPE cartridge material, it will be transferred to the NMR flow-cell with the same amount of deuterated solvents, regardless of the original peak elution volume. The SPE cartridges typically used

with standard-bore HPLC columns are  $10 \times 2$  mm i.d., which corresponds to an elution bandwidth volume of  $30 \mu\text{L}$ . This volume is clearly much smaller than typical HPLC peak volumes, and therefore the analytes are concentrated in the NMR flow-cell. In order to achieve full sensitivity, a probe with the cell volume that matches the SPE elution volume should be used. Finally, a very important advantage of the HPLC-SPE-NMR technique is the ability to perform multiple trapping, where the same analyte is trapped on the same cartridge in successive chromatographic runs. This may increase the amount of analyte adsorbed on the cartridges very substantially, leading to an increase in the S/N ratio in the resulting NMR spectra, provided that there is no breakthrough of the analyte after repeated trapings and that the desorption from the SPE cartridge is quantitative.

The first application of a fully integrated on-line HPLC-SPE-NMR-MS system in natural products research was a study on the constituents of Greek oregano [65]. The system used in this work corresponds to that shown in Figure 3.1, with a 600-MHz NMR spectrometer and a  $20\text{-}\mu\text{L}$  cryogenic flow-probe. These studies showed that it is possible to acquire 1D  $^1\text{H}$  and 2D homo- and heteronuclear data without solvent suppression, and that directly detected  $^{13}\text{C}$  1D spectra of a low molecular-weight natural product can be obtained within a reasonable time. In fact, all 1D and 2D experiments of the major component of the extract were performed in less than 1 h. The combined use of UV and MS as well as 1D and 2D NMR data led to the identification of five flavonoids, a phenolic acid, and a monoterpene. These results illustrate the sensitivity gain obtained by concentration of the HPLC peak on the SPE cartridge, further improved by the use of a cryogenic flow-probe (see Section 3.5). Another example of the benefit of increased S/N ratios due to multiple trapping and the possibility of acquiring spectra without solvent suppression is shown in Figure 3.4. Thus, possible suppression artifacts can be avoided and exchangeable protons can be observed in spectra acquired in aprotic solvents.

Other reports describe the use of the HPLC-SPE-NMR technique for the rapid identification of lignans from *Phyllanthus urinaria* [66], iridoid glycosides from *Harpagophytum procumbens* [67], cardiac glycosides from *Kanahia laniflora* [68], phenols, lignans, flavonoids, and secoiridoids from olive oil [69], and isoflavonoids from *Smirnowia iranica* [70]. The HPLC-SPE-NMR system has been further connected to a radical-scavenging detection system in order to perform simultaneous structure identification and radical-scavenging activity assessment of extract components [71,72]. In one instance, the detection of radical-scavenging activity was performed in a separate chromatographic run [71], whilst in another the radical-scavenging detection unit was connected in parallel to the DAD and SPE unit by means of a flow splitter (i.e., as MS in Fig. 3.1), which allowed simultaneous operation [72].

In a recent HPLC-SPE-NMR study of *Croton membranaceus* extract, the improvement of S/N ratio in the NMR spectra by multiple trapping was investigated for two SPE materials [73]. For the major extract constituent scopoletin, the use of a poly(divinylbenzene)-based material led to a linear increase of up to  $100 \mu\text{g}$  of scopoletin, whereas the use of a  $\text{C}_{18}$ -based SPE-cartridge material allowed a linear accumulation of only up to  $20 \mu\text{g}$  per cartridge. On the other hand, the  $\text{C}_{18}$  material



**Fig. 3.4** (A) 600 MHz 1D  $^1\text{H}$  NMR, (B) COSY, (C) HSQC, and (D) HMBC spectra acquired using the HPLC-SPE-NMR mode. The spectra allow full structural assignment including  $^{13}\text{C}$  resonances of a diterpene from the crude root extract of a lamiaaceous plant. Crude extract (1.5 mg) was injected onto a  $150 \times 4.6$  mm i.d.  $\text{C}_{18}$  column eluted with a linear gradient of acetonitrile in water at a

flow rate of  $0.8 \text{ mL min}^{-1}$ . Post-column dilution with water at  $0.8 \text{ mL min}^{-1}$  and six repeated trappings on a  $10 \times 2$  mm i.d. SPE cartridge was followed by 30-min drying with pressurized  $\text{N}_2$ -gas and elution with acetonitrile- $d_3$ . The spectra were acquired using a  $30 \mu\text{L}$  inverse-detection flow-probe. All spectra were acquired without solvent suppression (unpublished results).

allowed linear accumulation of an isoflavonoid in up to seven repeated trappings [70]. One study reported a correlation between trapping efficiency and polarity in a series of compounds in an artificial mixture [74], whereas another demonstrated complex trapping relationships for a series of iridoid glycosides [67]. Therefore, the

choice of SPE material and the post-column dilution ratio as well as the solvent used for cartridge elution should be considered on a case-to-case basis.

### 3.5

#### Cryogenically Cooled NMR Probes

Most of the noise observed in NMR spectra is thermal electronic noise created by the resistance of the receiver coil [75], and thus significant reduction of the noise level can be achieved by cryogenic cooling. In theory, the noise level upon cooling of the transceiver from room temperature to boiling liquid helium temperature will drop by a factor of 22 [76]. However, current technical implementations offer an improvement in S/N ratio by a factor of about 4 (for nonresistive samples) in comparison to spectra acquired with the same samples using room-temperature probes. This is mainly due to the loss of the filling factor (ratio between sample volume and coil detection volume), since the sample must be maintained at room temperature and appropriate insulation space must be left between the sample and the cold transceiver. Modern commercial cryogenic probes use recirculating, cold helium gas rather than liquid helium to cool the transceiver coil to about 20 K. Pre-amplifiers are enclosed in the same Dewar system and are cooled to about 80 K [77]. A significant advance is the recent development of convertible cryogenic probes that allow change between conventional NMR tubes and flow-cell inserts, which enables use of a single cryogenic probe for various applications and saves probe cool-down and warm-up time.

The first, and still the most popular, area of application of cryogenic flow-probes is in pharmaceutical analysis and drug metabolism [77]. As mentioned earlier, the combined advantage of the cryogenic probe and HPLC-SPE-NMR was demonstrated in the study of Greek oregano extract [65], and further proliferation of the cryogenic flow-probe technology in the field of natural products research is expected.

### 3.6

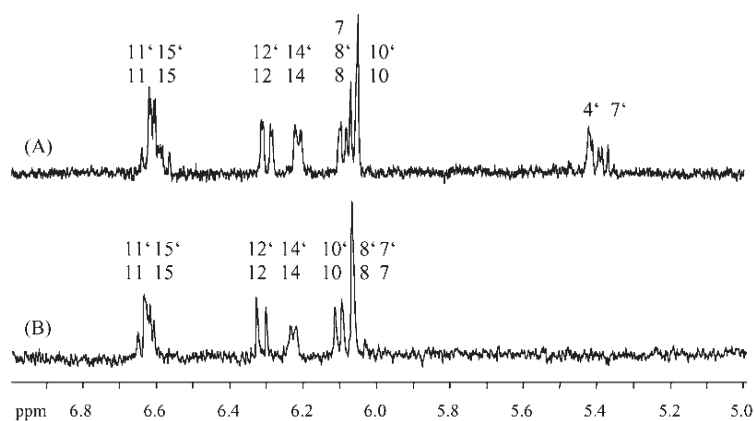
#### Miniaturization

There are at least three main reasons for the development of miniaturized NMR probes and their hyphenation with separation techniques. First, many samples for which NMR analyses are required are limited in size; this applies especially to samples of biological origin. Second, the mass-sensitivity (sensitivity per mass unit) increases with decreased dimensions of the NMR transceiver coils [75,78]. Third, miniaturized separation techniques usually work with higher concentrations of the analyte in the chromatographic bands, as the analyte concentration is typically inversely proportional to the square of the column diameter. This results in an increased analyte-to-solvent ratio for a given amount of injected material, making solvent suppression easier. Moreover, low solvent consumption in capillary LC separations allows the use of fully deuterated eluents.

Traditional NMR flow-cells are constructed with vertical cavities (tubes) placed along the main magnetic field of a superconducting magnet with a vertical bore. Since the NMR experiments involve the creation and detection of transverse magnetization, the magnet geometry necessitates the use of saddle-type (Helmholtz) transceiver coils. While the above-mentioned miniaturization benefits apply for the saddle-type coils [79], miniaturization enables use of solenoidal design with cell axes perpendicular to the magnet bore. For a given coil volume, solenoidal coils perform about three times better than the saddle-type coils [75]. For commercial capillary NMR probes, which have total cell volumes of 5 or 10  $\mu\text{L}$ , the mass sensitivity is five- to six-fold higher than for conventional probes. This is roughly equivalent to a cryogenically cooled probe with a 3-mm sample tube.

To date, most published reports employing capillary probes with solenoidal microcoils use direct analyte injection [80–83]. However, several studies combining capillary NMR probes with capillary HPLC separation of natural products have been published [84, 85]. An example is shown in Figure 3.5.

Capillary NMR probes with solenoidal microcoils are capable of detecting low-nanogram quantities of analytes ( $^1\text{H}$  detection), and the methodology is adaptable for high-throughput applications, both for pressure-driven and electro-driven separations [86–91]. The small size of the microcoils makes construction of probes with multiple cells feasible [92–94]. Moreover, since these probes contain a single transceiver coil, there is no sensitivity loss for direct  $^{13}\text{C}$  detection related to filling-factor differences that are typical for inverse-detection dual-coil probes. However, hundreds of micrograms are still required to obtain  $^{13}\text{C}$  NMR spectra in a reasonably short time [81, 87, 95], and these amounts are not easily achievable in the capillary HPLC mode.



**Fig. 3.5**  $^1\text{H}$  NMR spectra obtained from a mixture of carotenoid standards using a stopped-flow capillary HPLC-NMR system (15 cm  $\times$  250  $\mu\text{m}$   $\text{C}_{30}$  column) with acetone- $d_6$ :  $\text{D}_2\text{O}$  gradient separation (5  $\mu\text{L min}^{-1}$ ,

5  $\mu\text{L}$  capillary NMR probe with detection volume of 1.5  $\mu\text{L}$ , 500-nL column injection volume). (A) 50 ng of *E*-lutein; (B) 50 ng of *E*-zeaxanthin. (Reproduced with permission from [85]; Copyright Elsevier.)

## 3.7

## Conclusions

Of the two novel and maturing techniques in the area of NMR hyphenation, HPLC-SPE-NMR and stopped-flow capillary HPLC-NMR offer the highest sensitivity improvements, and are the most promising solutions. Both techniques have advantages and disadvantages. While the latter method exhibits the highest mass-sensitivity and is well suited for mass-limited samples and possibly for high-throughput applications, the higher absolute analyte amounts available through HPLC-SPE-NMR are advantageous when no severe limitations to the sample size exist. Moreover, at least in the drug discovery context, the HPLC-NMR experiment will often be an introductory experiment prior to compound isolation, with the aim of performing biological tests. Thus, standard-bore HPLC columns used for HPLC-NMR can be immediately used to isolate sufficient amounts of material for bioassays, whereas capillary HPLC-NMR must be regarded as a purely analytical tool. Moreover, the use of cryogenic probes in the case of HPLC-SPE-NMR matches the mass-sensitivity advantage of microcoils, which have yet to be combined with the cryogenic technology. The combination of HPLC-SPE-NMR with microcoil probe design and with cryogenic technology will provide further sensitivity advancement, at least for compounds compatible with solid-phase extraction, a property which is fulfilled by the majority of secondary plant metabolites. Thus, it can be concluded that NMR hyphenation offers flexibility, robustness, and sensitivity that are appropriate for a wide range of applications related to medicinal plants.

## References

References marked \* are special of interest; those marked \*\* are general papers of considerable interest

- 1 \*\*Cragg, G.M., Newmann, D.J., Snader, K.M. Natural products in drug discovery and development. *J. Nat. Prod.* **1997**, *60*, 52–60. [Useful review of the role of natural products in drug discovery.]
- 2 \*\*Newmann, D.J., Cragg, G.M., Snader, K.M. Natural products as sources of new drugs over the period 1981–2002. *J. Nat. Prod.* **2003**, *66*, 1022–1037. [Useful review of the role of natural products in drug discovery.]
- 3 Pitman, N.C.A., Jørgensen, P.M. Estimating the size of the world's threatened flora. *Science* **2002**, *298*, 989.
- 4 Chadwick, D.J., Marsh, J. *Ethnobotany and the Search for New Drugs*. John Wiley & Sons, Chichester, **1994**.
- 5 Iwu, M.M., Wootton, J.C. *Ethnomedicine and Drug Discovery*. Elsevier, Amsterdam, **2002**.
- 6 Polya, G. *Biochemical Targets of Plant Bioactive Compounds*. Taylor and Francis, London, **2003**.
- 7 Zhang, L., Demain, A.L. *Natural Products – Drug Discovery and Therapeutic Medicine*. Humana Press, Totowa, **2005**.
- 8 \*\* Bindseil, K.U., Jakupovic, J., Wolf, S.D., Lavayre, J., Leboul, J., van der Pyl, D. Pure compound libraries: a new perspective for natural product based drug discovery. *Drug Discov. Today* **2001**, *4*, 206–220. [An important review of pure compound libraries based on natural products.]
- 9 \*\* Koehn, F.E., Carter, G.T. The evolving role of natural products in drug discovery. *Nature Rev. Drug Discov.* **2005**, *4*, 206–220. [An important review of the renewed interest of natural products in drug discovery.]



- 10 Larsson, J., Gottfries, J., Bohlin, L., Backlund, A. Expanding the ChemGPS chemical space with natural products. *J. Nat. Prod.* **2005**, *68*, 985–991.
- 11 Feher, M., Jonathan, M., Schmidt, J.M. Property distributions: differences between drugs, natural products, and molecules from combinatorial chemistry. *J. Chem. Inf. Comput. Sci.* **2003**, *43*, 218–227.
- 12 Romeo, J.T., Dixon, R.A. (Eds.), *Phytochemistry in the Genomics and Post-Genomics Eras*. Pergamon, Amsterdam, **2002**.
- 13 Sumner, L.W., Mendes, P., Dixon, R.A. Plant metabolomics: large-scale phytochemistry in the functional genomics era. *Phytochemistry* **2003**, *62*, 817–836.
- 14 Zhang, W., Franco, C., Curtin, C., Conn, S. To stretch the boundary of secondary metabolite production in plant cell-based bioprocessing: anthocyanin as a case study. *J. Biomed. Biotechnol.* **2004**, *5*, 264–271.
- 15 Sweetlove, L.J., Fernie, A.R. Regulation of metabolic networks: understanding metabolic complexity in the systems biology era. *New Phytologist* **2005**, *168*, 9–24.
- 16 Huber, L., George, S.A. *Diode Array Detection in HPLC*. Marcel Dekker, New York, **1993**.
- 17 Niessen, W.M.A. *Liquid Chromatography-Mass Spectrometry*, 2nd edn. Marcel Dekker, New York, **1999**.
- 18 Bringmann, G., Messer, K., Wohlfarth, M., Kraus, J., Dumbuya, K., Rückert, M. HPLC-CD on-line coupling in combination with HPLC-NMR and HPLC-MS/MS for the determination of the full absolute stereostructure of new metabolites in plant extracts. *Anal. Chem.* **1999**, *71*, 2678–2686.
- 19 Somsen, G.W., Gooijer, C., Brinkmann, U.A.Th. Liquid chromatography-Fourier-transform infrared spectrometry. *J. Chromatogr. A* **1999**, *856*, 213–243.
- 20 Watanabe, N., Niki, E. Direct-coupling of FT-NMR to high-performance liquid chromatography. *Proc. Jpn. Acad. Ser. B* **1978**, *54*, 194–199.
- 21 Bayer, E., Albert, K., Nieder, M., Grom, E., Keller, T. On-line coupling of high-performance liquid chromatography and nuclear magnetic resonance. *J. Chromatogr.* **1979**, *186*, 497–507.
- 22 Haw, J.F., Glass, T.E., Hausler, D.W., Dorn, H.C. Direct coupling of a liquid chromatograph to a continuous flow hydrogen nuclear magnetic resonance detector for analysis of petroleum and synthetic fuels. *Anal. Chem.* **1980**, *52*, 1135–1140.
- 23 Bayer, E., Albert, K., Nieder, M., Grom, E., An, Z. Examples of application of direct HPLC-NMR-coupling with high resolution. *Fresenius Z. Anal. Chem.* **1980**, *304*, 111–116.
- 24 Buddrus, J., Herzog, H. Coupling of HPLC and NMR. 1. Analysis of flowing liquid-chromatographic fractions by proton magnetic resonance. *Org. Magn. Res.* **1980**, *13*, 153–155.
- 25 Haw, J.F., Glass, T.E., Dorn, H.C. Continuous flow high field nuclear magnetic resonance detector for liquid chromatographic analysis of fuel samples. *Anal. Chem.* **1981**, *53*, 2327–2332.
- 26 Bayer, E., Albert, K., Nieder, M., Grom, E., Wolff, G., Rindlisbacher, M. On-line coupling of liquid chromatography and high-field nuclear magnetic resonance spectrometry. *Anal. Chem.* **1982**, *54*, 1747–1750.
- 27 Albert, K. On-line use of NMR detection in separation chemistry. *J. Chromatogr. A* **1995**, *703*, 123–147.
- 28 \*\* Jaroszewski, J.W. Hyphenated NMR methods in natural products research, part 1: direct hyphenation. *Planta Med.* **2005**, *71*, 691–700. [A comprehensive review of direct HPLC-NMR methods in natural products research.]
- 29 \*\* Jaroszewski, J.W. Hyphenated NMR methods in natural products research, part 2: HPLC-SPE-NMR and other new trends in NMR hyphenation. *Planta Med.* **2005**, *71*, 795–802. [A comprehensive review of HPLC-SPE-NMR methods in natural products research.]
- 30 Nicholson, J.K., Foxal, P.J.D., Spraul, M., Farrant, R.D., Linton, J.C. 750 MHz  $^1\text{H}$  and  $^1\text{H}$ - $^{13}\text{C}$  NMR spectroscopy of human blood plasma. *Anal. Chem.* **1995**, *67*, 793–811.
- 31 Smallcombe, S.H., Patt, S.L., Keifer, P.A. WET solvent suppression and its applications to LC NMR and high-resolution

- NMR spectroscopy. *J. Magn. Reson. Ser. A* **1995**, *117*, 295–303.
- 32 Albert, K., Nieder, M., Bayer, E., Spraul, M. Continuous-flow nuclear magnetic resonance. *J. Chromatogr.* **1985**, *346*, 17–24.
- 33 Griffiths, L. Optimization of NMR and HPLC conditions for LC-NMR. *Anal. Chem.* **1995**, *67*, 4091–4095.
- 34 Griffiths, L. Optimization of liquid chromatography-NMR spectroscopy. *Magn. Reson. Chem.* **1997**, *35*, 257–261.
- 35 Bringmann, G., Rückert, M., Messer, K., Schupp, O., Louis, A.M. Acetogenic isoquinoline alkaloids CXXI. Use of on-line high-performance liquid chromatography-nuclear magnetic resonance spectrometry coupling in phytochemical screening studies: rapid identification of metabolites in *Dioncophyllum thollonii*. *J. Chromatogr. A* **1999**, *837*, 267–272.
- 36 Bringmann, G., Günthe, C., Schlauer, J., Rückert, M. HPLC-NMR on-line coupling including the ROESY technique: direct characterization of naphthylisoquinoline alkaloids in crude plant extracts. *Anal. Chem.* **1998**, *70*, 2805–2811.
- 37 \* Garo, E., Wolfender, J.-L., Hostettmann, K. Prenylated flavanones from *Monotes engleri*: on-line structure elucidation by LC/UV/NMR. *Helv. Chim. Acta* **1998**, *81*, 754–763. [An illustrative example of stopped-flow HPLC-NMR.]
- 38 Cavin, A., Potterat, O., Wolfender, J.-L., Hostettmann, K., Dyatmyko, W. Use of on-flow LC/<sup>1</sup>H NMR for the study of an antioxidant fraction from *Orophea enneandra* and isolation of a polyacetylene, lignane, and a tocopherol derivative. *J. Nat. Prod.* **1998**, *61*, 1497–1501.
- 39 Ioset, J.-R., Wolfender, J.-L., Marston, A., Gupta, M.P., Hostettmann, K. Identification of two isomeric meroterpenoid naphthoquinones from *Cordia linnæi* by liquid chromatography-mass spectrometry and liquid chromatography-nuclear magnetic resonance spectroscopy. *Phytochem. Anal.* **1999**, *10*, 137–142.
- 40 Wolfender, J.-L., Verotta, L., Belvisi, L., Fuzzati, N., Hostettmann, K. Structural investigation of isomeric oxidised forms of hyperforin by HPLC-NMR and HPLC-MS<sup>n</sup>. *Phytochem. Anal.* **2003**, *14*, 290–297.
- 41 Waridel, P., Wolfender, J.-L., Lachavanne, J.-B., Hostettmann, K. Identification of the polar constituents of *Potamogeton* species by HPLC-UV with post-column derivatization, HPLC-MS<sup>n</sup> and HPLC-NMR, and isolation of a new *ent*-labdane diglycoside. *Phytochemistry* **2004**, *65*, 2401–2410.
- 42 Gavidia, I., Seitz, H.U., Pérez-Bermúdez, P., Vogler, B. LC-NMR applied to the characterisation of cardiac glycosides from three micropropagated *Isoplexis* species. *Phytochem. Anal.* **2002**, *13*, 266–271.
- 43 Setzer, W.N., Vogler, B., Bates, R.B., Schmidt, J.M., Dicus, C.W., Nakkiew, P., Haber, W.A. HPLC-NMR/HPLC-MS analysis of the bark extract of *Stauranthus perforatus*. *Phytochem. Anal.* **2003**, *14*, 54–59.
- 44 Renukappa, T., Roos, G., Klaiber, I., Vogler, B., Kraus, W. Application of high-performance liquid chromatography coupled to nuclear magnetic resonance spectrometry, mass spectrometry, and bioassay for the determination of active saponins from *Bacopa monniera* Wettst. *J. Chromatogr. A* **1999**, *847*, 109–116.
- 45 Pusecker, K., Albert, K., Bayer, E. Investigation of hop bitter acids by coupling of high-performance liquid chromatography to nuclear magnetic resonance spectroscopy. *J. Chrom. A* **1999**, *836*, 245–252.
- 46 \* Dachtler, M., Glaser, T., Kohler, K., Albert, K. Combined HPLC-MS and HPLC-NMR on-line coupling for the separation and determination of lutein and zeaxanthin stereoisomers in spinach and in retina. *Anal. Chem.* **2001**, *73*, 667–674. [An illustrative example of stopped-flow HPLC-NMR.]
- 47 Waridel, P., Wolfender, J.-L., Lachavanne, J.-B., Hostettmann, K. *Ent*-labdane glycosides from the aquatic plant *Potamogeton lucens* and analytical evaluation of the lipophilic extract constituent of various *Potamogeton* species. *Phytochemistry* **2004**, *65*, 945–954.
- 48 Wolfender, J.-L., Ndjoko, K., Hostettmann, K. The potential of LC-NMR in phytochemical analysis. *Phytochem. Anal.* **2001**, *12*, 2–22.

- 49 Vogler, B., Klaiber, I., Roos, G., Walter, C.U., Holler, W., Sandor, P., Kraus, W. Combination of LC-MS and LC-NMR as a tool for the structure determination of natural products. *J. Nat. Prod.* **1998**, *61*, 175–178.
- 50 \* Hansen, S.H., Jensen, A.G., Cornett, C., Bjørnsdottir, I., Taylor, S., Wright, B., Wilson, I.D. High-performance liquid chromatography on-line coupled to high-field NMR and mass spectrometry for structure elucidation of constituents of *Hypericum perforatum* L. *Anal. Chem.* **1999**, *71*, 5235–5241. [An illustrative example of stopped-flow HPLC-NMR.]
- 51 \* Wolfender, J.-L., Rodriguez, S., Hostettmann, K., Hiller, W. Liquid chromatography/ultra violet/mass spectrometric and liquid chromatography/nuclear magnetic resonance spectroscopic analysis of crude extracts of gentianaceae species. *Phytochem. Anal.* **1997**, *8*, 97–104. [An illustrative example of stopped-flow HPLC-NMR.]
- 52 \* Bringmann, G., Wohlfarth, M., Rischer, H., Schlauer, J., Brun, R. Extract screening by HPLC coupled to MS-MS, NMR, and CD: a dimeric and three monomeric naphthylisoquinoline alkaloids from *Ancistrocladus griffithii*. *Phytochemistry* **2002**, *61*, 195–204. [An illustrative example of stopped-flow HPLC-NMR.]
- 53 \* Queiroz, E.F., Wolfender, J.-L., Raelison, G., Hostettmann, K. Determination of the absolute configuration of 6-alkylated  $\alpha$ -pyrones from *Ravensara crassifolia* by LC-NMR. *Phytochem. Anal.* **2003**, *14*, 34–39. [An illustrative example of stopped-flow HPLC-NMR.]
- 54 \* Guilet, D., Guntern, A., Ioset, J.-R., Queiroz, E.F., Ndjoko, K., Foggin, C.M., Hostettmann, K. Absolute configuration of a tetrahydrophenanthrene from *Heliotropium ovalifolium* by LC-NMR of its Mosher esters. *J. Nat. Prod.* **2003**, *66*, 17–20. [An illustrative example of stopped-flow HPLC-NMR.]
- 55 \* Seco, J.M., Tseng, L.-H., Godejohann, M., Quinoa, E., Riguera, R. Simultaneous enantioresolution and assignment of absolute configuration of secondary alcohols by directly coupled HPLC-NMR of 9-AMA esters. *Tetrahedron Asymm.* **2002**, *13*, 2149–2153. [An illustrative example of stopped-flow HPLC-NMR.]
- 56 \* Gil, A.M., Duarte, I.F., Godejohann, M., Braumann, U., Maraschin, M., Spraul, M. Characterization of the aromatic composition of some liquid foods by nuclear magnetic resonance and mass spectrometric detection. *Anal. Chim. Acta* **2003**, *488*, 35–51. [An illustrative example of time-sliced HPLC-NMR.]
- 57 Corcoran, O., Spraul, M. LC-NMR-MS in drug discovery. *Drug Discov. Today* **2003**, *8*, 624–631.
- 58 \* Lommen, A., Godejohann, M., Venema, D.P., Hollman, P.C.H., Spraul, M. Application of directly coupled HPLC-NMR-MS to the identification and confirmation of quercetin glycosides and phloretin glycosides in apple peel. *Anal. Chem.* **2000**, *72*, 1793–1797. [An illustrative example of loop-collection HPLC-NMR.]
- 59 Tseng, L.H., Braumann, U., Godejohann, M., Lee, S.S., Albert, K. Structure identification of aporphine alkaloids by on-line coupling of HPLC-NMR with loop storage. *J. Chin. Chem. Soc.* **2000**, *47*, 1231–1236.
- 60 deKoning, J.A., Hogenboom, A.C., Lacker, T., Albert, K., Brinkmann, U.A.Th. On-line trace enrichment in hyphenated liquid chromatography-nuclear magnetic resonance spectroscopy. *J. Chromatogr. A* **1998**, *813*, 55–61.
- 61 Wilcox, C.D., Phelan, R.M. The use of solid-phase extraction columns to effect simple offline LC/MS, LC/NMR, and LC/FTIR. *J. Chromatogr. Sci.* **1986**, *24*, 130–133.
- 62 Nyberg, N.T., Baumann, H., Kenne, L. Application of solid-phase extraction coupled to an NMR flow-probe in the analysis of HPLC fractions. *Magn. Reson. Chem.* **2001**, *39*, 236–240.
- 63 Nyberg, N.T., Baumann, H., Kenne, L. Solid-phase extraction NMR studies of chromatographic fractions of saponins from *Quillaja saponaria*. *Anal. Chem.* **2003**, *75*, 268–274.
- 64 \*\* Griffiths, L., Horton, R. Optimization of LC-NMR III – Increased signal-to-noise ratio through column trapping. *Magn. Reson. Chem.* **1998**, *36*, 104–109. [The work presented represents a milestone in development of the HPLC-SPE-NMR method.]

- 65 \* Exarchou, V., Goodejohann, M., van Beek, T.A., Gerotheranassis, I.P., Vervoort, J. LC-UV-solid-phase extraction-NMR-MS combined with a cryogenic flow probe and its application to the identification of compounds present in Greek oregano. *Anal. Chem.* **2003**, *75*, 6288–6294. [An illustrative example of application of the HPLC-SPE-NMR method.]
- 66 \* Wang, C.-Y., Lee, S.-S. Analysis and identification of lignans in *Phyllanthus urinaria* by HPLC-SPE-NMR. *Phytochem. Anal.* **2005**, *16*, 120–126. [An illustrative example of application of the HPLC-SPE-NMR method.]
- 67 \* Seger, C., Godejohann, M., Tseng, L.H., Spraul, M., Girtler, A., Sturm, S., Stuppner, H. LC-DAD-MS/SPE-NMR hyphenation. A tool for the analysis of pharmaceutically used plant extracts: Identification of isobaric iridoid glycoside regiomers from *Harpagophytum procumbens*. *Anal. Chem.* **2005**, *77*, 878–885. [An illustrative example of application of the HPLC-SPE-NMR method.]
- 68 \* Clarkson, C., Stærk, D., Hansen, S.H., Jaroszewski, J.W. Hyphenation of solid-phase extraction with liquid chromatography and nuclear magnetic resonance: application of HPLC-DAD-SPE-NMR to identification of constituents of *Kanahia laniflora*. *Anal. Chem.* **2005**, *77*, 3547–3553. [An illustrative example of application of the HPLC-SPE-NMR method.]
- 69 \* Christophoridou, S., Dais, P., Tseng, L.-H., Spraul, M. Separation and identification of phenolic compounds in olive oil by coupling high-performance liquid chromatography with postcolumn solid-phase extraction to nuclear magnetic resonance spectroscopy (LC-SPE-NMR). *J. Agric. Food Chem.* **2005**, *53*, 4667–4679. [An illustrative example of application of the HPLC-SPE-NMR method.]
- 70 \* Lambert, M., Stærk, D., Hansen, S.H., Sairafianpour, M., Jaroszewski, J.W. Rapid extract dereplication using HPLC-SPE-NMR: Analysis of isoflavanoids from *Smirnowia iranica*. *J. Nat. Prod.* **2005**, *68*, 1500–1509. [An illustrative example of application of the HPLC-SPE-NMR method.]
- 71 \* Miliauskas, G., van Beek, T.A., de Ward, P., Venskutonis, R.P., Sudhölter, E.J.R. Identification of radical scavenging compounds in *Rhaponticum carthamoides* by means of LC-DAD-SPE-NMR. *J. Nat. Prod.* **2005**, *68*, 168–172. [An illustrative example of application of the HPLC-SPE-NMR method.]
- 72 \* Pukalskas, A., van Beek, T.A., de Ward, P. Development of a triple hyphenated HPLC-radical scavenging detection-DAD-SPE-NMR system for the rapid identification of antioxidants in complex plant extracts. *J. Chrom. A* **2005**, *1074*, 81–88. [An illustrative example of application of the HPLC-SPE-NMR method.]
- 73 Lambert, M., Stærk, D., Hansen, S.H., Jaroszewski, J.W. HPLC-SPE-NMR hyphenation in natural products research: optimization of analysis of *Croton membranaceus* extract. *Magn. Reson. Chem.* **2005**, *43*, 771–775.
- 74 \* Sandvoss, M., Bardsley, B., Beck, T.L., Lee-Smith, E., North, S.E., Moore, P.J., Edwards, A.J., Smith, R.J. HPLC-SPE-NMR in pharmaceutical development: capabilities and applications. *Magn. Reson. Chem.* **2005**, *43*, 762–770. [An illustrative example of application of the HPLC-SPE-NMR method.]
- 75 \*\* Hoult, D.I., Richards, R.E. Signal-to-noise ratio of nuclear magnetic resonance experiment. *J. Magn. Reson.* **1976**, *24*, 71–85. [Seminal account of factors affecting sensitivity of NMR detection.]
- 76 Styles, P., Soffe, N.F., Scott, C.A., Cragg, D.A., Row, F., White, D.J., White, P.C.J. A high-resolution NMR probe in which the coil and preamplifier are cooled with liquid helium. *J. Magn. Reson.* **1984**, *60*, 397–404.
- 77 \*\* Kovacs, H., Moskau, D., Spraul, M. Cryogenically cooled probes – a leap in NMR technology. *Progr. Nucl. Magn. Reson. Spectr.* **2005**, *46*, 131–155. [A review of theory and applications of cryogenic probe technology.]
- 78 Peck, T.L., Magin, R.L., Lauterbur, P.C. Design and analysis of microcoils for NMR spectroscopy. *J. Magn. Reson. B* **1995**, *108*, 114–124.
- 79 Schlotterbeck, G., Ross, A., Hochstrasser, R., Senn, H., Kühn, T., Marek, D., Schett, O. High-resolution capillary tube NMR.

- A miniaturized 5- $\mu$ L high-sensitivity TXI probe for mass-limited samples, off-line LC NMR, and HT NMR. *Anal. Chem.* **2002**, *74*, 4464–4471.
- 80** Hu, J.-F., Yoo, H.-D., Williams, C.T., Garo, E., Cremin, P.A., Zeng, L., Vervoort, H.C., Lee, C.M., Hart, S.M., Goering, M.G., O'Neil-Johnson, M., Eldridge, G.R. Miniaturization of the structure elucidation of novel natural products – two trace antibacterial acylated caprylic alcohol glycosides from *Arctostaphylos pumila*. *Planta Med.* **2005**, *71*, 176–180.
- 81** Hu, J.-F., Garo, E., Yoo, H.-D., Cremin, P.A., Zeng, L., Goering, M.G., O'Neil-Johnson, M., Eldridge, G.R. Application of capillary-scale NMR for the structure determination of phytochemicals. *Phytochem. Anal.* **2005**, *16*, 127–133.
- 82** Yoo, H.-D., Cremin, P.A., Zeng, L., Garo, E., Williams, C.T., Lee, C.M., Goering, M.G., O'Neil-Johnson, M., Eldridge, G.R., Hu, J.-F. Suaveolindole, a new mass-limited antibacterial indolosesquiterpene from *Greenwayodendron suaveolens* obtained via high-throughput natural products chemistry methods. *J. Nat. Prod.* **2005**, *68*, 122–124.
- 83** Hu, J.-F., Garo, E., Yoo, H.-D., Cremin, P.A., Goering, M.G., O'Neil-Johnson, M., Eldridge, G.R. Cyclolignans from *Scyphocephalum ochocoa* via high-throughput natural product chemistry methods. *Phytochemistry* **2005**, *66*, 1077–1082.
- 84** \* Xiao, H.B., Krucker, M., Putzbach, K., Albert, K. Capillary liquid chromatography-microcoil  $^1\text{H}$  nuclear magnetic resonance spectroscopy and liquid chromatography-ion trap mass spectrometry for on-line structure elucidation of isoflavones in *Radix astragali*. *J. Chromatogr. A* **2005**, *1067*, 135–143. [An illustrative example of application of capillary HPLC-NMR.]
- 85** \* Putzbach, K., Krucker, M., Grynbaum, M.D., Hentschel, P., Webb, A.G., Albert, K. Hyphenation of capillary high-performance liquid chromatography to microcoil magnetic resonance spectroscopy – determination of various carotenoides in a small-sized spinach samples. *J. Pharm. Biomed. Anal.* **2005**, *38*, 910–917. [An illustrative example of application of capillary HPLC-NMR.]
- 86** Olson, D.L., Peck, T.L., Webb, A.G., Magin, R.L., Sweedler, J.V. High-resolution microcoil  $^1\text{H}$  NMR for mass-limited, nanoliter-volume samples. *Science* **1995**, *270*, 1967–1970.
- 87** Olson, D.L., Norcross, J.A., O'Neil-Johnson, M., Molitor, P.F., Detlefsen, D.J., Wilson, A.G., Peck, T.L. Microflow NMR: concepts and capabilities. *Anal. Chem.* **2004**, *76*, 2966–2974.
- 88** Bailey, N.J.C., Marshall, I.R. Development of ultrahigh-throughput NMR spectroscopic analysis utilizing capillary flow NMR technology. *Anal. Chem.* **2005**, *77*, 3947–3953.
- 89** Jansma, A., Chuan, T., Albrecht, R.W., Olson, D.L., Peck, T.L., Geierstanger, B.H. Automated microflow NMR: routine analysis of five-microliter samples. *Anal. Chem.* **2005**, *77*, 6509–6515.
- 90** Webb, A.G. Nuclear magnetic resonance coupled microseparations. *Magn. Reson. Chem.* **2005**, *43*, 688–696.
- 91** \*\* Webb, A.G. Microcoil nuclear magnetic resonance spectroscopy. *J. Pharm. Biomed. Anal.* **2005**, *38*, 892–903. [A review of capillary probes with solenoidal microcoils.]
- 92** Wang, H., Ciobanu, L., Webb, A. Reduced data acquisition time in multi-dimensional NMR spectroscopy using multiple-coil probes. *J. Magn. Reson.* **2005**, *173*, 134–139.
- 93** Wang, H., Ciobanu, L., Edison, A.S., Webb, A.G. An eight-coil high-frequency probehead design for high-throughput nuclear magnetic resonance spectroscopy. *J. Magn. Reson.* **2004**, *170*, 206–212.
- 94** Jayawickrama, D.A., Sweedler, J.V. Dual microcoil NMR probe coupled to cyclic ce for continuous separation and analyte isolation. *Anal. Chem.* **2004**, *76*, 4894–4900.
- 95** Kaerner, A., Smittka, T., Unpublished results.

## 4

# Plant-Associated Microorganisms (Endophytes) as a New Source of Bioactive Natural Products

Gary Strobel

### Abstract

Endophytic microorganisms are to be found in virtually every higher plant. These organisms reside in the living tissues of the host plant, and do so in a variety of relationships ranging from symbiotic to pathogenic. Endophytes may contribute to their host plant by producing a plethora of substances that provide protection and survival value to the plant. Ultimately, these compounds, once isolated and characterized, may also have potential for use in modern medicine. Novel antibiotics, antimycotics, immunosuppressants, and anticancer compounds are only a few examples of what has been found after the isolation and culturing of individual endophytes, followed by purification and characterization of some of their natural products. The potential for the discovery of new drugs that may be effective candidates for treating newly developing diseases in humans is vast.

### 4.1

#### Introduction

The need for new and useful compounds to provide assistance and relief in all aspects of the human condition is ever-growing. Drug resistance in bacteria, the appearance of new life-threatening viruses, the recurrent problems of diseases in persons with organ transplants, and the tremendous increase in the incidence of fungal infections in the world's population all underscore our inadequacy to cope with these medical problems. Environmental degradation, loss of biodiversity, and spoilage of land and water also add to problems facing mankind, and each of these in turn can have health-related consequences.

Endophytes – microorganisms that reside in the tissues of living plants – are relatively unstudied as potential sources of novel natural products for use in modern medicine. However, some of the most extensive and comprehensive investigations on natural products produced by endophytes have been carried out on the *Neotyphodium* sp. found on grasses [1]. Alkaloids synthesized by this fungus in its grass

hosts have been implicated in fescue toxicosis in rangeland animals [1]. The chemistry and biology of this and other grass endophytes have been reviewed elsewhere [2]. Unfortunately, the fact that these studies are so comprehensive may lead to the conclusion that endophytes only produce toxic compounds in their respective hosts, and that they hold no promise for any medicinal applications whatsoever [2]. This is simply not the case, and as endophytes have been increasingly examined from a plethora of sources an overwhelming number have been found to produce natural products with promising potential for medicinal applications. This is especially true when the higher plants that live in the world's rainforests are examined for endophytes, and their secondary products are tested against bacterial and fungal pathogens of mankind.

Among the approximately 300 000 higher plant species that exist on the Earth, each individual plant of the billions that exist is most likely a host to one or more endophytes (G. Strobel, unpublished results). Only a handful of these plants (grass species) have ever been completely studied relative to their endophytic biology [2]. Consequently, the opportunity to identify new and interesting endophytic microorganisms among the myriads of plants in different settings and ecosystems is vast. The aim of this chapter is to provide some insight into the occurrence of these microorganisms in Nature, to identify the products that they make, and how some of these organisms are beginning to show some potential for human use. The majority of the chapter discusses the rationale for study, the methods used, and details examples of a number of endophytes isolated and studied in the author's laboratory over the course of many years. However, the chapter also includes some specific examples illustrating the work of others in this emerging field of bioprospecting the microbes of the world's rainforests.

## 4.2

### Why Are There Needs for New Medicines?

Today, there is a general call for new antibiotics, and chemotherapeutic agents that are highly effective and possess low toxicity. This search is driven by the development of resistance in infectious microorganisms (e.g., *Staphylococcus*, *Mycobacterium*, *Streptococcus*) to existing drugs, and by the menacing presence of naturally resistant organisms. The ingress to the human population of new disease-causing agents such as AIDS, Ebola virus and SARS requires the discovery and development of new drugs to combat them. Not only do diseases such as AIDS require drugs that target them specifically, but new therapies are also needed for the treatment of ancillary infections that arise a consequence of a weakened immune system. Furthermore, others who are immunocompromised (e.g., cancer and organ transplant patients) are at risk of infection by opportunistic pathogens, such as *Aspergillus*, *Cryptococcus*, and *Candida*, that normally are not major problems in the human population. In addition, more drugs are needed to efficiently treat parasitic protozoan and nematodal infections such as malaria, leishmaniasis, trypanomiasis, and filariasis. Perhaps surprisingly, malaria alone claims more lives each year



than any other single infectious agent, with the exception of AIDS and tuberculosis (TB) [3]. However, it is the enteric diseases that claim more lives each year than any other disease complex, and unfortunately the large majority of those dying are children [3].

Novel natural products, and the organisms that create them, offer major opportunities for innovation in drug discovery. Exciting possibilities exist for those who are willing to venture into the wild and unexplored territories of the world to experience the excitement and thrill of engaging in the discovery of endophytes, their biology, and potential usefulness.

### 4.3

#### Natural Products in Medicine

Even with untold centuries of human experience behind us and a movement into a modern era of chemistry and automation, it remains evident that natural product-based compounds have had an immense impact on modern medicine. For instance, about 40% of currently available prescription drugs are based such compounds, while between 1981 and 2002 well over 50% of the new chemical products registered by the Food and Drug Administration as anticancer, antimigraine and antihypertensive agents were either natural products or derivatives thereof [4]. Furthermore, between 1989 and 1995, excluding biologics, some 60% of all drug approvals and pre-new drug applications were made for products of natural origin [5]. Likewise, between 1983 and 1994 over 60% of all approved and pre-NDA stage cancer drugs were of natural origin, as were 78% of all newly approved antibacterial agents [6]. Many other examples abound that illustrate the value and importance of natural products from plants and microorganisms in modern civilizations. One modern example of a natural product that has made an enormous impact on medicine is that of taxol [7–9].

More recently, however, natural product research efforts have lost favor with many major drug companies, who now prefer to employ a combinatorial chemistry approach that involves the automated synthesis of structurally related small molecules. In addition, many drug companies have developed interests in making products that have a larger potential profit base than anti-infectious drugs. These synthetic compounds may provide social benefits, relieve allergenic responses, reduce the pain of arthritis, or even sooth the stomach. Strangely, it appears that this loss of interest in natural products is not only an economically driven decision but can also be attributed to the enormous effort and expense required to identify a biological source, to isolate an active natural product, to decipher its structure, and then to begin the long road to product development. It is now also apparent that combinatorial chemistry and other synthetic chemistry methodology, which revolves around certain basic chemical structures, serves as a never-ending supply of products to feed the screening robots of the drug industry. Today, within many large pharmaceutical companies, the progress of professionals is based primarily upon the numbers of compounds that can be produced and sent to the screening



machines. However, this approach tends to work against the numerous steps needed even to find one compound in natural product discovery. It is important to emphasize at this point that the primary purpose of combinatorial chemistry should be to complement and assist the efforts of natural product drug discovery and development, and not to supersede it [5]. For this reason, a few larger companies have retained an interest in natural products chemistry. In fact, the natural product often serves as a lead molecule, the activity of which can be enhanced by manipulation through combinatorial and synthetic chemistry. Traditionally, natural products have been the “pathfinder” compounds, with an untold diversity of chemical structures unparalleled by even the largest combinatorial libraries.

#### 4.4

#### **Endophytic Microbes**

It may also be true that a reduction in interest for natural products used in drug development has occurred as a result of people growing weary of dealing with the traditional sources of bioactive compounds, including plants from temperate zones and microbes from a plethora of soil samples gathered in different parts of the world by armies of collectors. In other words, why continue to do the same thing when robots, combinatorial chemistry, and molecular biology have arrived on the scene? Furthermore, the logic and rationale for the time and effort spent on drug discovery using a target- and site-directed approach has been overwhelming.

While combinatorial synthesis produces compounds at random, secondary metabolites – defined as low molecular-weight compounds not required for growth in pure culture – are produced as an adaptation for specific functions in nature [10]. Shutz points out that certain microbial metabolites seem to be characteristic of certain biotopes, both on an environmental as well as organismal level [11]. Accordingly, it appears that the search for novel secondary metabolites should center on organisms that inhabit unique biotopes. Thus, it behooves the investigator to carefully study and select the biological source before proceeding, rather than to take a totally random approach in selecting the source material. Careful study also indicates that organisms and their biotopes that are subjected to constant metabolic and environmental interactions should produce even more secondary metabolites [11]. Endophytes are microbes that inhabit such biotopes, namely higher plants, which is why they are currently considered as a wellspring of novel secondary metabolites offering the potential for exploitation of their medical benefits [12].

In addition, it also is extremely helpful for the investigator interested in exploiting endophytes to have access to – or to have some expertise in – microbial taxonomy, and this includes modern molecular techniques involving sequence analyses of 16S and 18S rDNA. Currently, endophytes are viewed as an outstanding source of bioactive natural products because there are so many of them occupying literally millions of unique biological niches (higher plants), and growing in so many unusual environments. Thus, it would appear that a myriad of biotypical factors associated with plants can be important in the selection of a plant for study. It may be

the case that these factors govern which microbes are present in the plant, as well as the biological activity of the products associated with these organisms.

What are endophytes? Bacon et al. [2] provided an inclusive and widely accepted definition of endophytes as: “*Microbes that colonize living, internal tissues of plants without causing any immediate, overt negative effects*”. While the symptomless nature of endophyte occupation in plant tissue has prompted focus on symbiotic or mutualistic relationships between endophytes and their hosts, the observed biodiversity of endophytes suggests they can also be aggressive saprophytes or opportunistic pathogens. Both fungi and bacteria are the most common microbes existing as endophytes. It would seem that other microbial forms most certainly exist in plants as endophytes such as mycoplasmas, rickettsia and archbacteria, but as yet evidence for their existence has been presented. In fact, it may be the case that the majority of microbes existing in plants are not culturable with common laboratory techniques, which makes their presence and role in plants even more intriguing. Although the most frequently isolated endophytes are the fungi [13], at the outset it is important to realize that the vast majority of plants have not been studied for any endophytic association. Thus, enormous opportunities exist for the recovery of novel fungal forms, including genera, biotypes, as well as species in the myriad of plants yet to be studied. Hawksworth and Rossman [14] have estimated there may be as many as one million different fungal species, yet only about 100 000 have been described to date. As more evidence accumulates, however, estimates keep rising as to the actual number of fungal species. For instance, Dreyfuss and Chapela [15] estimate there may be at least one million species of endophytic fungi alone. It seems clear that endophytes are a rich and reliable source of genetic diversity, and may represent many previously undescribed species. Finally, in our experience, novel microbes (as defined at the morphological and or molecular levels) often have associated with them, novel natural products. This fact alone helps to eliminate the problems of dereplication in compound discovery

## 4.5

### Rationale for Plant Selection

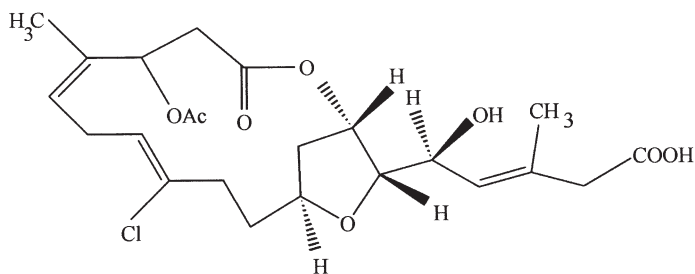
It is important to understand that the methods and rationale used seem to provide the best opportunities to isolate novel endophytic microorganisms at the genus, species, or biotype levels. Since the number of plant species in the world is so great, creative and imaginative strategies must be used to quickly narrow the search for endophytes displaying bioactivity [16].

A specific rationale for the collection of each plant for endophyte isolation and natural product discovery is used. Several hypotheses govern this plant selection strategy, as follows:

1. Plants from unique environmental settings, especially those with an unusual biology, and possessing novel strategies for survival, are seriously considered for study.

2. Plants that have an ethnobotanical history (used by indigenous peoples) and are related to the specific uses or applications of interest are selected for study. These plants are chosen either by direct contact with local peoples, or via local literature. Ultimately, it may be learned that the healing powers of the botanical source may in fact not be related to the natural products of the plant, but rather to the endophyte inhabiting the plant.
3. Plants that are endemic, having an unusual longevity, or have occupied a certain ancient land mass, such as Gondwanaland, are also more likely to lodge endophytes with active natural products than other plants.
4. Plants growing in areas of great biodiversity, it follows, also have the prospect of housing endophytes with great biodiversity.

Just as plants from a distinct environmental setting are considered to be a promising source of novel endophytes and their compounds, so too are plants with an unconventional biology. For example, an aquatic plant, *Rhyncholacis penicillata*, was collected from a river system in southwest Venezuela where the harsh aquatic environment subjected the plant to constant beating by virtue of rushing waters, debris, and tumbling rocks and pebbles [17]. These environmental insults created many portals through which common phytopathogenic oomycetes could enter the plant. Still, the plant population appeared to be healthy, possibly due to protection from an endophytic product. This was the environmental biological clue used to pick this plant for a comprehensive study of its endophytes. Eventually, an unusual and potent antifungal strain of *Serratia marcescens*, living both as an epiphyte and an endophyte, was recovered from *R. penicillata*. This bacterium produces oocydin A, a novel antioomycetous compound, having the properties of a chlorinated macrocyclic lactone (Fig. 4.1) [17]. It is conceivable that the production of oocydin A by *S. marcescens* is directly related to the endophyte's relationship with its higher plant host. Currently, oocydin A is being considered for agriculture use to control the ever-threatening presence of oomycetous fungi such as *Pythium* spp. and *Phytophthora* spp. Oocydin A also has activity against a number of rapidly dividing cancer cell lines [17].



**Fig. 4.1** Oocydin A, a chlorinated macrocyclic lactone isolated and characterized from a strain of *Serratia marcescens*, obtained from *Rhyncholacis penicillata* (stereochemistry unknown).

Plants with an ethnobotanical history, as mentioned above, also are likely candidates for study since the medical uses for which the plant was selected may relate more to its population of endophytes than to the plant biochemistry itself. For example, a sample of the snakevine, *Kennedia nigricans*, from the Northern Territory of Australia, was selected for study since its sap has traditionally been used as bush medicine. In fact, this area was selected for plant sampling since it has been home to the world's longest standing human civilization, the Australian Aborigines. The snakevine is harvested, crushed and heated in an aqueous brew by local Aborigines in southwest Arnhemland to treat cuts, wounds and infections. As it turned out, the plant contains an entire suite of streptomycetes [18]. One in particular has unique partial 16S rDNA sequences when compared to those in GenBank. The organism was designated *Streptomyces* NRRL 30562 [19]. It produces a series of actinomycins including actinomycins D, Xo<sub>β</sub>, and X<sub>2</sub> among others (U.F. Castillo and G.A. Strobel, unpublished results). Furthermore, it produces broad-spectrum novel peptide antibiotics termed "munumbicins", that are discussed below. It seems likely that some of the healing properties in plants, as discovered by indigenous peoples, might be facilitated by compounds produced by one or more specific plant-associated endophytes as well as the plant products themselves. This appears to be an excellent example illustrating this point.

In addition, it is worth noting that some plants generating bioactive natural products have associated endophytes that produce the same natural products. Such is the case with taxol, a highly functionalized diterpenoid and famed anticancer agent that is found in *Taxus brevifolia* and other yew species (*Taxus* spp.) [8]. In 1993, a novel taxol-producing fungus, *Taxomyces andreanae*, was isolated and characterized from the yew, *Taxus brevifolia* [20].

#### 4.6

#### Endophytes and Biodiversity

Among the myriad of ecosystems on Earth, those having the greatest general biodiversity of life seem to be those that also have the greatest number and most diverse endophytes. Tropical and temperate rainforests are the most biologically diverse terrestrial ecosystems. The most threatened of these spots cover only 1.44% of the land's surface, yet they harbor over 60% of the world's terrestrial biodiversity [16]. In addition, each of the 20 to 25 areas identified as supporting the world's greatest biodiversity also support unusually high levels of plant endemism [16]. As such, one would expect, with high plant endemism, that there also should exist specific endophytes which may have evolved with the endemic plant species. Biological diversity implies chemical diversity because of the constant chemical innovation required to survive in ecosystems where the evolutionary race to survive is most active. Tropical rainforests are a remarkable example of this type of environment, because competition is great, resources are limited, and selection pressure is at its peak. This gives rise to a high probability that rainforests are a source of novel molecular structures and biologically active compounds [21].

Bills et al. described a metabolic distinction between tropical and temperate endophytes through statistical data which compared the number of bioactive natural products isolated from endophytes of tropical regions to the number of those isolated from endophytes of temperate origin [22]. Not only did these authors find that tropical endophytes provided more active natural products than temperate endophytes, but they also noted that a significantly higher number of tropical endophytes produced a larger number of active secondary metabolites than did fungi from other substrata. This observation suggests the importance of the host plant as well as the ecosystem in influencing the general metabolism of endophytic microbes.

#### 4.7

#### Endophytes and Natural Products

Tan and Zou believe the reason why some endophytes produce certain phytochemicals, originally characteristic of the host, might be related to a genetic recombination of the endophyte with the host that occurred in evolutionary time [12]. This is a concept that was originally proposed as a mechanism to explain why *T. andreanae* might be producing taxol [23]. Thus, if endophytes can produce the same rare and important bioactive compounds as their host plants, this would not only reduce the need to harvest slow-growing and possibly rare plants, but also help to preserve the world's ever-diminishing biodiversity. Furthermore, it is recognized that a microbial source of a high-value product may be easier and more economic to produce effectively, thereby reducing its market price.

All aspects of the biology and interrelatedness of endophytes with their respective hosts is a vastly underinvestigated and exciting field [24–27]. Thus, more background information on a given plant species and its microorganismal biology would be exceedingly helpful in directing the search for bioactive products. Presently, no one is quite certain of the role of endophytes in nature and what appears to be their relationship to various host plant species. While some endophytic fungi appear to be ubiquitous (e.g., *Fusarium* spp., *Pestalotiopsis* spp., and *Xylaria* spp.), one cannot state definitively that endophytes are truly host-specific or even systemic within plants, any more than assume that their associations are chance encounters. Frequently, many endophytes of the same species are isolated from the same plant, and only one or a few biotypes of a given fungus will produce a highly biologically active compound in culture [28]. A great deal of uncertainty also exists between what an endophyte produces in culture and what it may produce in nature. It does seem possible that the production of certain bioactive compounds by the endophyte *in situ* may facilitate the domination of its biological niche within the plant, or even provide protection to the plant from harmful invading pathogens. Furthermore, little information exists relative to the biochemistry and physiology of the interactions of the endophyte with its host plant. It would seem that many factors changing in the host as related to the season, and other factors including age, environment, and location may influence the biology of the endo-

phyte. Indeed, further research at the molecular level must be conducted in the field to study endophyte interactions and ecology. All of these interactions are probably chemically mediated for some purpose in Nature. An ecological awareness of the role these organisms play in nature will provide the best clues for targeting particular types of endophytic bioactivity with the greatest potential for bio-prospecting.

#### 4.7.1

##### **Isolation, Preservation and Storage of Endophytic Cultures for Product Isolation**

Detailed techniques for the isolation of microbial endophytes are outlined in a number of reviews and technical articles [17–20, 24–27]. If endophytes are being obtained from plants growing in polar regions, the dry tropics, or some temperate areas of the world, one can expect to acquire from none to only one or two endophytic cultures per plant sample (0.5–10.0) centimeter limb piece. However, from the wet tropics this number may rise to 20 to 30 or even more microbes per plant piece.

Given limited fermentation capabilities, it becomes necessary to preserve freshly isolated microbes for work in the future. Generally, preservation in an aqueous 15% glycerol solution at  $-70^{\circ}\text{C}$  is an exceedingly good procedure for saving cultures until work on them can proceed at a later date [24–27]. It is also critical to label and store cultures for patent and publication purposes.

#### 4.7.2

##### **Some Examples of Bioactive Natural Products from Endophytes**

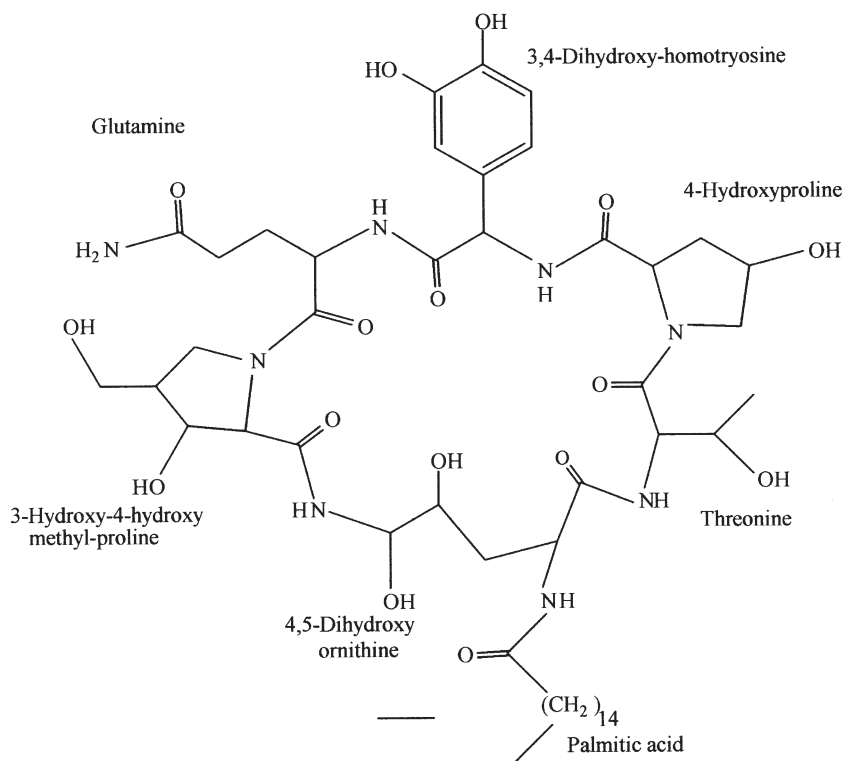
The following section illustrates some examples of natural products obtained from endophytic microbes, and their potential in the pharmaceutical and agrochemical arenas. Although many of the examples are taken from our studies, this review is by no means inclusive of all natural product investigations in endophytes.

##### **4.7.2.1 Endophytic Fungal Products as Antibiotics**

Fungi are the most commonly isolated endophytic microbes, usually appearing as fine filaments growing from the plant material on the agar surface. Generally, the most commonly isolated fungi are in the group *Fungi Imperfecti* or *Deuteromycetes*. Basically, they produce asexual spores in or on various fruiting structures. Also, it is quite common to isolate endophytes that are producing no fruiting structures whatsoever, such as *Mycelia Sterilia*. Quite commonly, endophytes do produce secondary metabolites when placed in culture. However, the temperature, the composition of the medium and the degree of aeration will affect the amount and types of compounds produced by an endophytic fungus. On occasion, endophytic fungi produce antibiotics. Natural products from endophytic fungi have been observed to inhibit or kill a wide variety of harmful microorganisms including, but not limited to phytopathogens, as well as bacteria, fungi, viruses, and protozoans that af-

fect humans and animals. Some examples of bioactive products from endophytic fungi are described in the following sections.

*Cryptosporiopsis* cf. *quercina* is the imperfect stage of *Pezizula cinnamomea*, a fungus commonly associated with hardwood species in Europe. It was isolated as an endophyte from *Tripterigeum wilfordii*, a medicinal plant native to Eurasia [29]. On Petri plates, *C. quercina* demonstrates excellent antifungal activity against some important human fungal pathogens, including *Candida albicans* and *Trichophyton* spp. A unique peptide antimycotic, termed cryptocandin, was isolated and characterized from *C. quercina* [29]; this compound contains a number of peculiar hydroxylated amino acids and a novel amino acid, 3-hydroxy-4-hydroxy methyl proline (Fig. 4.2). The bioactive compound is related to the known antimycotics, the echinocandins, and the pneumocandins [30]. As is generally true, not one but several bioactive and related compounds are produced by an endophytic microbe. Thus, other antifungal agents related to cryptocandin are also produced by *C. cf. quercina*. Cryptocandin is also active against a number of plant pathogenic fungi, including *Sclerotinia sclerotiorum* and *Botrytis cinerea*. Cryptocandin and its related



**Fig. 4.2** Cryptocandin A, an antifungal lipopeptide obtained from the endophytic fungus, *Cryptosporiopsis* cf. *quercina*. (No stereochemistry is intended.)

compounds are currently being considered for use against a number of fungi causing diseases of the skin and nails.

Cryptocin, a unique tetramic acid, is also produced by *C. quercina* (see above) (Fig. 4.3) [31]. This unusual compound possesses potent activity against *Pyricularia oryzae*, the causal organism of rice blast, one of the worst plant diseases in the world, as well as a number of other plant pathogenic fungi [31]. The compound was generally ineffective against a general array of human pathogenic fungi. Nevertheless, with minimum inhibitory concentrations (MICs) against *P. oryzae* at  $0.39 \mu\text{g mL}^{-1}$ , this compound is being examined as a natural chemical control agent for rice blast and is being used as a model to synthesize other antifungal compounds.

As mentioned earlier, *P. microspora* is a common rainforest endophyte [24–26]. It transpires that enormous biochemical diversity does exist in this endophytic fungus, and many secondary metabolites are produced by various strains of this widely dispersed organism. One such secondary metabolite is ambuic acid, an antifungal agent, which has been recently described from several isolates of *P. microspora* found as representative isolates in many of the world's rainforests (Fig. 4.4) [32]. This compound, and another endophyte product, terrein, have been used as models to develop new solid-state NMR tensor methods to assist in the characterization of the molecular stereochemistry of organic molecules. The rationale and methods used and developed for this novel method of chemical characterization are discussed elsewhere [33,34].

A strain of *P. microspora* was also isolated from the endangered tree *Torreya taxifolia*, and produces several compounds having antifungal activity; these include pestalocide, an aromatic  $\beta$ -glucoside, and two pyrones – pestalopyrone and hydroxypestalopyrone [35]. These products also possess phytotoxic properties. Other newly isolated secondary products obtained from *P. microspora* (endophytic on *Taxus brevifolia*) include two new caryophyllene sesquiterpenes – pestalotiopsins A and B [36]. Additional new sesquiterpenes produced by this fungus are 2- $\alpha$ -hydroxydimenol and a highly functionalized humulane [37, 38]. Variation in the amount

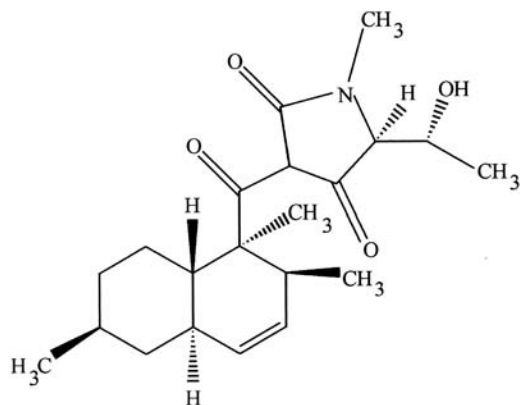
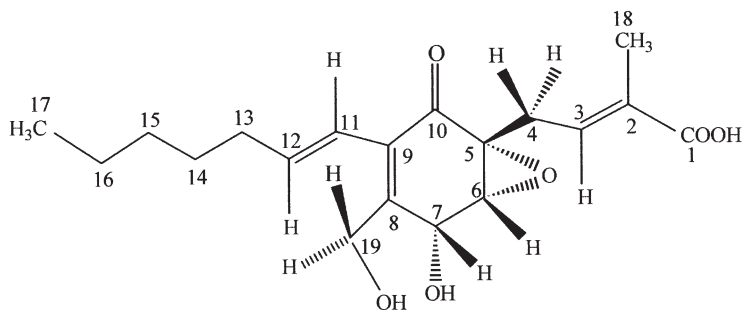


Fig. 4.3 Cryptocin, a tetramic acid antifungal compound found in *Cryptosporiopsis cf. quercina*





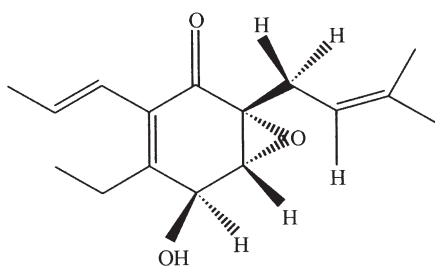
**Fig. 4.4** Ambuic acid, a highly functionalized cyclohexenone produced by a number of isolates of *Pestalotiopsis microspora* found in rainforests around the world. This compound possesses antifungal activity and has been used as a model compound for the development of solid-state NMR methods for the structural determination of natural products.

and types of products found in this fungus depends on both the cultural conditions as well as the original plant source from which it was isolated.

*Pestalotiopsis jesteri* is a newly described endophytic fungal species from the Sepik river area of Papua New Guinea. This fungus produces jesterone and hydroxyjesterone, both of which exhibit antifungal activity against a variety of plant pathogenic fungi [39]. These compounds are highly functionalized cyclohexenone epoxides. Jesterone, subsequently, has been prepared by organic synthesis with complete retention of biological activity (Fig. 4.5) [40]. Jesterone is one of only a few products from endophytic microbes in which total synthesis of a bioactive product has been successfully accomplished.

Phomopsichalasin, a metabolite from an endophytic *Phomopsis* sp., represents the first cytochalasin-type compound with a three-ring system replacing the cytochalasin macrolide ring. This metabolite exhibits antibacterial activity in disk diffusion assays (at a concentration of 4  $\mu\text{g}$  per disk) against *Bacillus subtilis*, *Salmonella gallinarum*, and *Staphylococcus aureus*. It also displays a moderate activity against the yeast *Candida tropicalis* [41].

An endophytic *Fusarium* sp. from the plant, *Selaginella pallescens*, collected in the Guanacaste Conservation Area of Costa Rica, was screened for antifungal activity. A new pentaketide antifungal agent, CR377, was isolated from the culture broth of

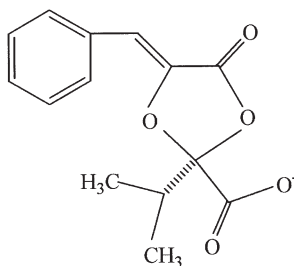


**Fig. 4.5** Jesterone, a cyclohexenone epoxide from *Pestalotiopsis jesteri* has antioomycete activity.

the fungus and showed potent activity against *Candida albicans* in agar diffusion assays [42].

Colletotric acid, a metabolite of *Colletotrichum gloeosporioides*, an endophytic fungus isolated from *Artemisia mongolica*, displays antibacterial activity against bacteria as well as against the fungus, *Helminthosporium sativum* [43]. Another *Colletotrichum* sp., isolated from *Artemisia annua*, produces bioactive metabolites that also showed antimicrobial activity. *A. annua* is a traditional Chinese herb that is well recognized for its synthesis of artemisinin (an antimalarial drug) and its ability to inhabit many geographically different areas. The *Colletotrichum* sp. found in *A. annua* not only produced metabolites with activity against human pathogenic fungi and bacteria, but also metabolites that were fungistatic to plant pathogenic fungi [44].

A novel antibacterial agent, guignardic acid, was isolated from the endophytic fungus *Guignardia* sp. Interestingly, the organism was obtained from the medicinal plant, *Spondias mombin* of the tropical plant family Anacardiaceae found in Brazil. The compound was isolated by UV-guided fractionation of the fermentation products of this fungus. The compound is the first member of a novel class of natural compounds containing a dioxolanone moiety formed by the fusion of 2-oxo-3-phenylpropanoic acid and 3-methyl-2-oxobutanoic acid, which are products of the oxidative deamination of phenylalanine and valine, respectively (Fig. 4.6). The structure was determined by classical spectroscopic methods and confirmed by organic synthesis [45].



**Fig. 4.6** Guignardic acid from *Guignardia* sp. obtained from *Spondias mombin*, an Anacardiaceae plant in Brazil.

#### 4.7.2.2 Endophytic Bacterial Products as Antibiotics

Only a limited number of bacterial species are known to be associated with plants, with one of the most common genus encountered being *Pseudomonas* spp. *Pseudomonas* spp. have representative biotypes and species that are epiphytic, endophytic, and pathogenic. They have been reported from every continent, including the Antarctic. Some of these species produce phytotoxic compounds as well as antibiotics. The ecomycins are produced by *Pseudomonas viridiflava* [46]; this bacterium is generally associated with the leaves of many grass species, and is located on and within the tissues [46]. The ecomycins represent a family of novel lipopeptides, and have masses of 1153 Da and 1181 Da, respectively. Besides common amino acids such as alanine, serine, threonine, and glycine, some unusual amino acids are incorporated into the structure of the ecomycins, including homoserine and  $\beta$ -hy-

droxyaspartic acid [46]. The ecomycins are active against such human pathogenic fungi as *Cryptococcus neoformans* and *Candida albicans*.

The pseudomycins produced by a plant-associated pseudomonad are another group of antifungal peptides [47, 48]. The pseudomycins are active against a variety of plant and human pathogenic fungi, including *Candida albicans*, *Cryptococcus neoformans*, and a variety of plant pathogenic fungi including *Ceratocystis ulmi* (the Dutch Elm disease pathogen) and *Mycosphaerella fijiensis* (the causal agent of Black Sigatoka disease in bananas). The pseudomycins are cyclic depsipeptides formed by acylation of the OH-group of the N-terminal serine with the terminal carboxyl group of L-chlorothreonine. Variety in this family of compounds is imparted via N-acetylation by one of a series of fatty acids including 3,4-dihydroxydecanoate, 3-hydroxytetradecanoate, and others [48]. The pseudomycins contain several nontraditional amino acids, including L-chlorothreonine, L-hydroxyaspartic acid, and both D- and L-diaminobutyric acid. The molecules are candidates for use in human medicine, especially when structural modification by chemical synthesis has successfully removed any mammalian toxicity [49].

#### 4.7.2.3 Endophytic Streptomycetes as Antibiotic Producers

*Streptomyces* spp. are filamentous bacteria that belong to the group Actinomycetales and live in widely diverse ecological settings. Generally, this group is Gram-positive, has a high G+C content, and does not have an organized nucleus. To date, actinomycetes have been the world's greatest source of natural antibiotics [50]. In fact, just one genus – *Streptomyces* sp. – is the source of 80% of these compounds. The majority of the antibiotic producers are known from soil sources, and until recently it was not realized that these organisms can exist as endophytes. One of the first endophytic *Streptomyces* spp. isolated was that from *Lolium perenne*, a grass species [51]. This isolate produces a diketopiperazine that is only weakly antibiotic and has been designated methylalbonoursin [51]. Other streptomycetes with activities against plant pathogens have been isolated from a number of plant species in Japan and are being considered a biocontrol agents [52].

By using the ethnobotanical approach to plant selection, the snakevine plant, *Kennedia nigricans*, was chosen as a possible source of endophytic microbes, because of its long-held traditional use by Australian Aborigines to treat cuts and open wounds with resultant reduction in infection and rapid healing. This plant was collected near the Aboriginal Community of Manyallaluk in Northern Territory, Australia, and consistently produced an endophytic actinomycete designated *Streptomyces* NRRL 30562 [19]. The organism was not found in several tree species supporting the vine, which suggested a host-selective or specific association of the endophyte with a specific plant genus. This streptomycete produces a family of extremely potent peptide antibiotics, and it may be the case that these compounds not only protect the plant from fungal and bacterial infections but also have unknowingly served the Aborigines as a source of bush medicine.

The novel antibiotics produced by *Streptomyces* NRRL 30562, called munumbicins E-4 and E-5, possess widely differing biological activities, depending on the

target organism (U.F. Castillo et al., unpublished results). These compounds appear to be related to the actinomycins that are also produced by NRRL 30562 and previously termed munumbicins A–D [19]. The munumbicins are effective against a wide range of fungal pathogens of plants and certain Gram-negative and Gram-positive bacteria. The masses of these compounds are 1315 Da and 1431 Da, respectively, and they are currently being more completely chemically characterized.

Another endophytic *Streptomyces* sp. (NRRL 30566), from a fern-leaved grevillea (*Grevillea pteridifolia*) tree growing in the Northern Territory of Australia, produces, in culture, novel antibiotics called kakadumycins that are related to the echinomycins [53]. Each of these antibiotics contains alanine, serine, and an unknown amino acid. Kakadumycin A has wide-spectrum antibiotic activity, especially against Gram-positive bacteria, and it generally displays better bioactivity than echinomycin. For instance, against *B. anthracis* strains, kakadumycin A has MICs of 0.2–0.3  $\mu\text{g mL}^{-1}$ , in contrast to echinomycin at 1.0–1.2  $\mu\text{g mL}^{-1}$ . Both echinomycin and kakadumycin A have impressive activity against *P. falciparum* with LD<sub>50</sub>s in the range of 7 to 10  $\text{ng mL}^{-1}$  [53]. Kakadumycin A and echinomycin are related by virtue of their very similar structures (amino acid content and quinoxaline rings), but differ slightly with respect to their elemental compositions, aspects of their spectral qualities, chromatographic retention times, and biological activities [53].

Echinomycin and kakadumycin A were both studied as macromolecular synthesis inhibitors, with control substances such as ciprofloxacin, rifampin, chloramphenicol and vancomycin used as standards with well-established modes of action. Tests were carried out for DNA, RNA, protein, and cell-wall synthesis inhibition activities, respectively. Kakadumycin A significantly inhibited the RNA synthesis rate in *B. subtilis* [53], and also substantially inhibited protein synthesis and cell wall synthesis, but the effect was lower on DNA synthesis. Kakadumycin A shares a very similar inhibitory profile with echinomycin in four macromolecular synthesis assays. Kakadumycin A preferentially inhibits RNA synthesis, and may have the same mode of action as echinomycin, which inhibits RNA synthesis by binding to a DNA template [53]. This is yet another example of an endophytic actinomycete having promising antibiotic properties.

More recently, endophytic streptomycetes have been discovered in an area of the world claimed to be one of the most biologically diverse – the upper Amazon of Peru. The inner tissues of the Follow Me Vine, *Monstera* sp. commonly yields a verticillated streptomycete with outstanding inhibitory activities against pythiaceae fungi as well as the malarial parasite *Plasmodium falciparum*. The bioactive component is a mixture of lipopeptides and named coronamycin [54].

#### 4.7.2.4 Volatile Antibiotics from Endophytes

*Muscodor albus* is a newly described endophytic fungus obtained from small limbs of *Cinnamomum zeylanicum* (cinnamon tree) [55]. This xylariaceae (nonspore-producing) fungus effectively inhibits and kills certain other fungi and bacteria by producing a mixture of volatile compounds [56]. The majority of these compounds have been identified by GC-MS, synthesized or acquired, and then ultimately for-

mulated into an artificial mixture. This mixture not only mimics the antibiotic effects of the volatile compounds produced by the fungus, but also was used to confirm the identity of the majority of the volatiles emitted by this organism [56]. Each of the five classes of volatile compounds produced by the fungus had some microbial effects against the test fungi and bacteria, but none was lethal. Collectively, however, they acted synergistically to cause death in a broad range of plant and human pathogenic fungi and bacteria. The most effective class of inhibitory compounds was the esters, of which isoamyl acetate was the most biologically active, though in order to be lethal it must be combined with other volatiles [56]. The composition of the medium on which *M. albus* grows dramatically influences the type of volatile compounds produced [57]. The ecological implications and potential practical benefits of the “mycofumigation” effects of *M. albus* are very promising, given the fact that soil fumigation using methyl bromide will soon be illegal in the United States. Methyl bromide is not only a hazard to human health, but it has been implicated in causing destruction of the ozone layer. The potential use of mycofumigation to treat soil, seeds, and plants will soon be a reality. The artificial mixture of volatile compounds may also have value in treating seeds, fruits and plant parts in storage and while being transported. In addition, *M. albus* is already in a limited market for the treatment of human wastes. Its gases have both inhibitory and lethal effects on fecal-inhabiting organisms such as *Escherichia coli* and *Vibrio cholera*.

Using *M. albus* as a screening tool, it has now been possible to isolate other endophytic fungi producing volatile antibiotics. The newly described *M. roseus* was twice obtained from tree species found in the Northern Territory of Australia. This fungus is equally effective as *M. albus* in causing inhibition and death of test microbes in the laboratory [58]. Other interesting *M. albus* isolates have been obtained from several plant species growing in the Northern Territory and the jungles of the Tesso Nilo area of Sumatra, Indonesia [59,60].

In addition, for the first time, a nonmuscodor species (*Gliocladium* sp.) was discovered as a volatile antibiotic producer. The volatile components of this organism are totally different than those of either *M. albus* or *M. roseus*. In fact, the most abundant volatile inhibitor is [8]-annulene, formerly used as a rocket fuel and discovered for the first time as a natural product. However, the bioactivity of the volatiles of this *Gliocladium* sp. is not as good or comprehensive as that of the *Muscodor* spp. [61].

#### 4.7.2.5 Antiviral Compounds from Endophytes

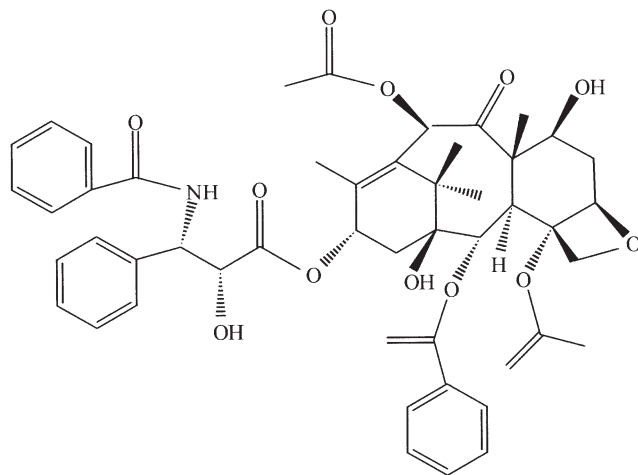
Another fascinating use of products from endophytic fungi is the inhibition of viruses. Two novel human cytomegalovirus (hCMV) protease inhibitors, cytonic acids A and B, have been isolated from solid-state fermentation of the endophytic fungus *Cytospora* sp. Their structures as were elucidated as *p*-tridepsides isomers by MS and NMR methods [62]. It is apparent that the potential for the discovery of compounds having antiviral activity from endophytes is in its infancy. The fact, however, that some compounds have been found already is promising. The main

limitation to compound discovery to date is probably related to an absence of common antiviral screening systems in most compound discovery programs.

#### 4.7.2.6 Endophytic Fungal Products as Anticancer Agents

Taxol and some of its derivatives represent the first major group of anticancer agents to be produced by endophytes (Fig. 4.7). Taxol, a highly functionalized diterpenoid, is found in each of the world's yew (*Taxus*) species, but was originally isolated from *Taxus brevifolia* [8]. The original target diseases for this compound were ovarian and breast cancers, but now it also is used to treat a number of other human tissue-proliferating diseases. The presence of taxol in yew species prompted the study of their endophytes. By the early 1990s, however, no endophytic fungi had been isolated from any of the world's representative yew species. After several years of effort, a novel taxol-producing endophytic fungus, *Taxomyces andreanae*, was discovered in *Taxus brevifolia* [20]. The most critical line of evidence for the presence of taxol in the culture fluids of this fungus was the electrospray mass spectrum of the putative taxol isolated from *T. andreanae*. In electrospray mass spectroscopy, taxol usually gives two peaks, one at mass 854 which is  $M+H^+$ , and the other at 876 which is  $M+Na^+$ . Fungal taxol had an identical mass spectrum to authentic taxol [23]. Subsequent  $^{14}C$ -labeling studies showed the presence of fungal-derived taxol in the culture medium [23]. These early studies set the stage for a more comprehensive examination of the ability of other *Taxus* species and many other plants to yield endophytes producing taxol.

Some of the most commonly found endophytes of the world's yews and many other plants are *Pestalotiopsis* spp. [24–27]. One of the most frequently isolated en-



**Fig. 4.7** Taxol, the world's first billion-dollar anticancer drug is produced by many endophytic fungi. It too, possesses outstanding antioomycete activity.

dophytic species is *Pestalotiopsis microspora* [24]. An examination of the endophytes of *Taxus wallichiana* yielded *P. microspora*, and a preliminary monoclonal antibody test indicated that it might produce taxol (30). After preparative thin-layer chromatography (TLC), a compound was isolated and shown by spectroscopic techniques to be taxol. Labeled ( $^{14}\text{C}$ ) taxol was produced by this organism when it was administered several  $^{14}\text{C}$  precursors [63]. Furthermore, several other *P. microspora* isolates were obtained from a bald cypress tree in South Carolina and also shown to produce taxol [28]. This was the first indication that endophytes residing in plants other than *Taxus* spp. were producing taxol. Therefore, a specific search was conducted for taxol-producing endophytes on continents not known for any indigenous *Taxus* spp. This included investigating the prospects that taxol-producing endophytes exist in South America and Australia. From the extremely rare (and previously thought extinct) Wollemi Pine (*Wollemia nobilis*), *Pestalotiopsis guepini* was isolated which was shown to produce taxol [64]. Also, quite surprisingly, a rubiaceous plant, *Maguireothamnus speciosus*, yielded a novel fungus, *Seimatoantlerium tepuiense*, that produces taxol. This endemic plant grows on the top of the tepuis in the Venezuelan-Guyana border in southwest Venezuela [65]. Fungal taxol production was also noted in *Periconia* sp. and *Seimatoantlerium nepalense*, another novel endophytic fungal species [66, 67]. Simply, it appears that the distribution of those fungi producing taxol is worldwide, and not confined to the endophytes of yews. The ecological and physiological explanation for the wide distribution of taxol-producing fungi seems to be related to the fact that taxol is a fungicide, and that the most sensitive organisms to it are plant pathogens such as *Pythium* spp. and *Phytophthora* spp. [68]. These pythiaceous organisms are some of the world's most important plant pathogens, and are strong competitors with endophytic fungi for niches within plants. In fact, their sensitivity to taxol is based on their interaction with tubulin in an identical manner as in rapidly dividing human cancer cells [9, 68]. Thus, bona fide endophytes may be producing taxol and related taxanes to protect their respective host plant from degradation and disease caused by these pathogens.

Other investigators have also made observations on taxol production by endophytes, including the discovery of taxol production by *Tubercularia* sp. isolated from the Chinese yew (*Taxus mairei*) in the Fujian province of southeastern mainland China [69]. At least three endophytes of *Taxus wallichiana* produce taxol, including *Sporormia minima* and *Trichothecium* sp. [70]. Using HPLC and ESIMS, taxol has been discovered in *Corylus avellana* cv. Gasaway [71]. Several fungal endophytes of this plant (filbert) produce taxol in culture [71]. It is important to note, however, that taxol production by all endophytes in culture is in the range of sub-microgram to micrograms per liter. Also, commonly, the fungi will attenuate taxol production in culture, with some possibility for recovery, if certain activator compounds are added to the medium [66]. Efforts are being made to determine the feasibility of making microbial taxol a commercial possibility; the greatest prospect for this may be the discovery of endophytes that produce large quantities of one or more taxanes that could then be used as platforms for the organic synthesis of taxol or one of its anticancer relatives.

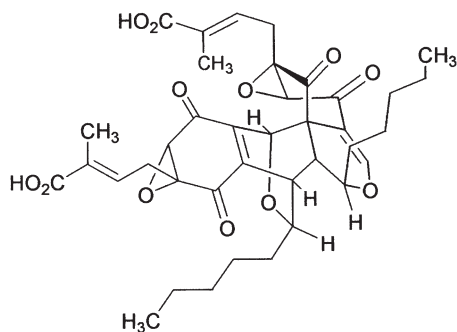


Fig. 4.8 Torreyanic acid, an anticancer compound, from *Pestalotiopsis microspora*

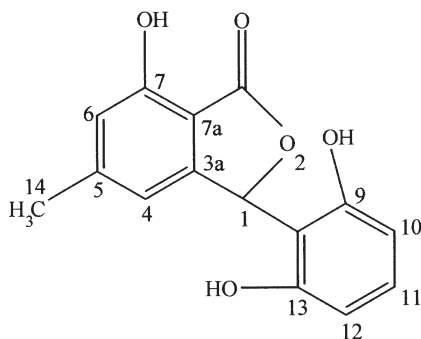
Torreyanic acid, a selectively cytotoxic quinone dimer and potential anticancer agent, was isolated from a *P. microspora* strain (Fig. 4.8). This strain was originally obtained as an endophyte associated with the endangered tree *Torreya taxifolia* (Florida torrey), as mentioned above [72]. Torreyanic acid was tested in several cancer cell lines, where it demonstrated five- to ten-fold more potent cytotoxicity in cell lines sensitive to protein kinase C agonists; cell death was caused by apoptosis. Recently, torreyanic acid was successfully synthesized by application of a biomimetic oxidation/dimerization cascade [73].

Alkaloids are also commonly found in endophytic fungi. Such fungal genera as xylaria, phoma, hypoxylon, and chalara are representative producers of a relatively large group of substances known as the cytochalasins, of which over 20 are now known. Many of these compounds possess antitumor and antibiotic activities, but because of their cellular toxicity they have not been developed into pharmaceuticals. Three novel cytochalasins have recently been reported from *Rhinocladiella* sp. as an endophyte on *Tripterygium wilfordii*. These compounds have antitumor activity and have been identified as 22-oxa-[12]-cytochalasins [74]. Thus, it is not uncommon to find one or more cytochalasins in endophytic fungi, and this provides an example of the fact that redundancy in discovery does occur, making dereplication an issue even for these under investigated sources.

#### 4.7.2.7 Endophytic Fungal Products as Antioxidants

Two compounds, pestacin and isopestacin, have been obtained from culture fluids of *Pestalotiopsis microspora*, an endophyte isolated from a combretaceous plant, *Terminalia morobensis*, growing in the Sepik River drainage system of Papua New Guinea [75,76]. Both pestacin and isopestacin display antimicrobial as well as antioxidant activity. Isopestacin was attributed with antioxidant activity based on its structural similarity to the flavonoids (Fig. 4.9). Electron spin resonance spectroscopy measurements confirmed this antioxidant activity; the compound is able to scavenge superoxide and hydroxyl free radicals in solution [75]. Pestacin was later described from the same culture fluid, occurring naturally as a racemic mixture and also possessing potent antioxidant activity [76]. The antioxidant activity of pestacin arises primarily via cleavage of an unusually reactive C–H bond and to a less-





**Fig. 4.9** Isopestacin, an antioxidant produced by an endophytic *Pestalotiopsis microspora* strain, isolated from *Terminalia morobensis* growing on the north coast of Papua New Guinea.

er extent, through O–H abstraction [76]. The antioxidant activity of pestacin is at least one order of magnitude more potent than that of trolox, a vitamin E derivative [76].

#### 4.7.2.8 Endophytic Fungal Products as Immunosuppressive Compounds

Immunosuppressive drugs are used today to prevent allograft rejection in transplant patients, and in future could be used to treat autoimmune diseases such as rheumatoid arthritis and insulin-dependent diabetes. The endophytic fungus, *Fusarium subglutinans*, isolated from *T. wilfordii*, produces the immunosuppressive, but noncytotoxic diterpene pyrones subglutinols A and B [77]. Subglutinol A and B are equipotent in the mixed lymphocyte reaction (MLR) assay and thymocyte proliferation (TP) assay, with an  $IC_{50}$  of 0.1  $\mu$ M. In the same assay systems, the famed immunosuppressant drug, cyclosporine A (also a fungal metabolite), was roughly as potent in the MLR assay, but  $10^4$ -fold more potent in the TP assay. Nonetheless, the lack of toxicity associated with subglutinols A and B suggests that they should be explored in greater detail as potential immunosuppressants [77].

## 4.8

### Surprising Results from Molecular Biology Studies on *Pestalotiopsis microspora*

Of some compelling interest is an explanation as to how the genes for taxol production may have been acquired by *P. microspora* [78]. Although the complete answer to this question is not at hand, some other relevant genetic studies have been performed on this organism. *Pestalotiopsis microspora* Ne 32 is one of the most easily genetically transformable fungi that has been studied to date. The *in-vivo* addition of telomeric repeats to foreign DNA generates extrachromosomal DNAs in this fungus [78]. Repeats of the telomeric sequence 5'-TTAGGG-3' were appended to nontelomeric transforming DNA termini. The new DNAs, carrying foreign genes and the telomeric repeats, replicated independently of the chromosome and expressed the information carried by the foreign genes. The addition of telomeric repeats to foreign DNA is unusual among fungi. This finding may have important

implications in the biology of *P. microspora* Ne 32 as it explains at least one mechanism as to how new DNA can be captured by this organism and eventually expressed and replicated. Such a mechanism may begin to explain how the enormous biochemical variation may have arisen in this fungus [28]. These initial studies also represent a framework to aid in the understanding of how this fungus might adapt itself to the environment of its plant hosts, and suggests that the uptake of plant DNA into its own genome may occur. In addition, the telomeric repeats have the same sequence as human telomeres, which points to the possibility that *P. microspora* might serve as a means to make artificial human chromosomes, a totally unexpected result.

## 4.9

### Concluding Statements

Endophytes are a poorly investigated group of microorganisms that represent an abundant and dependable source of bioactive and chemically novel compounds with potential for exploitation in a wide variety of medical applications. The mechanisms through which endophytes exist and respond to their surroundings must be better understood in order to be more predictive about which higher plants to seek, study, and employ in isolating their microfloral components. This may facilitate the natural product discovery process.

Although investigations into the utilization of this vast resource of poorly understood microorganisms has only just begun, it is already clear that the enormous potential for organism, product, and utilitarian discovery in this field holds exciting promise. This is evidenced by the discovery of a wide range of products, and microorganisms that present potential, as mentioned above. It is important for all involved in these studies to realize the importance of acquiring the necessary permits from governmental, local, and other sources to pick, and transport plant materials (especially from abroad) from which endophytes are eventually to be isolated. In addition to this aspect of the work is the added activity of producing the necessary agreements and financial sharing arrangements with indigenous peoples or governments in case a product does develop an income stream.

Certainly, one of the major problems facing the future of endophyte biology and natural product discovery is the rapidly diminishing rainforests which hold the greatest possible resource for acquiring novel microorganisms and their products. The total land mass of the world that currently supports rainforests is about equal to the area of the United States [16]. Each year, an area the size of Vermont or greater is lost to clearing, harvesting, fire, agricultural development, mining, or other human oriented activities [16]. Presently, it is estimated that only a small fraction (10–20%) of what were the original rainforests existing 1000–2000 years ago, are currently present on the Earth [16]. The advent of major negative pressures on them from these human-related activities appears to be eliminating entire mega-life forms at an alarming rate. Few have ever expressed information or opinions about what is happening to the potential loss of microbial diversity as entire plant

species disappear. It can only be guessed that this loss is also happening, perhaps with the same frequency as the loss of mega life forms, especially since certain microorganisms may have developed unique specific symbiotic relationships with their plant hosts. Thus, when a plant species disappears, so too does its entire suite of associated endophytes and consequently all of the capabilities that they might possess to make natural products with medicinal potential. Multi-step processes are needed now to secure information and life forms before they continue to be lost. Areas of the planet that represent unique places housing biodiversity need immediate preservation. Countries must establish information bases of their biodiversity and, at the same time, begin to create national collections of microorganisms that live in these areas. Endophytes are just one example of a life form source that holds enormous promise to impact many aspects of human existence. The problem of the loss of biodiversity should be one of concern to the entire world.

### Acknowledgments

The author thanks Dr. Gene Ford and Dr. David Ezra for helpful discussions. He also expresses his appreciation to the NSF, USDA, NIH, The BARD Foundation of Israel, The R&C Board of the State of Montana and the Montana Agricultural Experiment Station for providing financial support for some of the studies reviewed in this chapter.

### References

- Lane, G.A., Christensen, M.J., Miles, C.O. Coevolution of fungal endophytes with grasses: the significance of secondary metabolites. In: Bacon, C.W., White, J.F. (Eds.), *Microbial Endophytes*. Marcel Dekker, Inc., New York, 2000.
- Bacon, C., White, J.F. *Microbial Endophytes*. Marcel Dekker, Inc., New York, 2000.
- NIAID Global Health Research Plan for HIV/AIDS, Malaria and Tuberculosis. U.S. Department of Health and Human Services, Bethesda, MD, 2001.
- Newman, D.J., Cragg, G.M., Snader, K.M. *J. Nat. Prod.* 2003, 66, 1022–1037.
- Grabley, S., Thiericke, R.. The impact of natural products on drug discovery. In: Grabley, S., Thiericke, R. (Eds.), *Drug Discovery from Nature*. Springer-Verlag, Berlin, 1999, pp. 3–33.
- Concepcion, G.P., Lazaro, J.E., Hyde, K.D. Screening for bioactive novel compounds. In: Pointing, S.B., Hyde, K.D. (Eds.), *Bio-exploitation of Filamentous Fungi*. Fungal Diversity Press, Hong Kong, 2001, pp. 93–130.
- Suffness, M. (Ed.), *Taxol®: Science and Applications*. CRC Press, Boca Raton, 1995.
- Wani, M.C., Taylor, H.L., Wall, M.E., Goggon, P., McPhai, A.T. *J. Am. Chem. Soc.* 1971, 93, 2325–2327.
- Rowinsky, E.K., Cazanave, L.A., Donehower, F.C. *J. Natl. Cancer Inst.* 1990, 82, 1247–1259.
- Demain, A.L. *Science* 1981, 214, 987–994.
- Schutz, B.. In: *Bioactive Fungal Metabolites – Impact and Exploitation*. British Mycological Society, International Symposium Proceedings, Swansea, University of Wales, UK, 2001, p. 20.
- Tan, R.X., Zou, W.X. *Nat. Prod. Rep.* 2000, 18, 448–459.
- Redlin, S.C., Carris, L.M. (Eds.), *Endophytic Fungi in Grasses and Woody Plants*. APS Press, St. Paul, 1996.

- 14 Hawksworth, D.C., Rossman, A.Y. *Phytopathology* **1987**, *87*, 888–891.
- 15 Dreyfuss, M.M., Chapela, I.H. Potential of fungi in the discovery of novel, low-molecular weight pharmaceuticals. In: Gullo, V.P. (Ed.), *The Discovery of Natural Products with Therapeutic Potential*. Butterworth-Heinemann, Boston, **1994**, pp. 49–80
- 16 Mittermeier, R.A., Myers, N., Gil, P.R., Mittermeier, C.G. *Hotspots: Earth's Biologically Richest and Most Endangered Ecoregions*. CEMEX Conservation International, Washington DC, **1999**.
- 17 Strobel, G.A., Li, J.Y., Sugawara, F., Koshino, H., Harper, J., Hess, W.M. *Microbiology* **1999**, *145*, 3557–3564.
- 18 Castillo, U.F., Giles, S., Browne, L., Strobel, G.A., Hess, W.M., Hanks, J., Reay, D. *Scanning Microscopy* **27**, 305–311.
- 19 Castillo, U.F., Strobel, G.A., Ford, E.J., Hess, W.M., Porter, H., Jensen, J.B., Albert, H., Robison, R., Condron, M.A., Teplow, D.B., Stevens, D., Yaver, D. *Microbiology* **2002**, *148*, 2675–2685.
- 20 Strobel, G.A., Stierle, A., Stierle, D., Hess, W.M. *Mycotaxon* **1993**, *47*, 71–78.
- 21 Redell, P., Gordon, V. Lessons from nature: can ecology provide new leads in the search for novel bioactive chemicals from rainforests? In: Wrigley, S.K., Hayes, M.A., Thomas, R., Chrystal, E.J.T., Nicholson, N. (Eds.), *Biodiversity: New Leads for Pharmaceutical and Agrochemical Industries*. The Royal Society of Chemistry, Cambridge, UK, **2000**, pp. 205–212.
- 22 Bills, G., Dombrowski, A., Pelaez, F., Polishook, J. Recent and future discoveries of pharmacologically active metabolites from tropical fungi. In: Watling, R., Frankland, J.C., Ainsworth, A.M., Issac, S., Robison, C.H., Eda, Z. (Eds.), *Tropical Mycology: Micromycetes*. CABI Publishing, New York, **2002**, Vol. 2, pp. 165–194.
- 23 Stierle, A., Strobel, G.A., Stierle, D. *Science* **1993**, *260*, 214–216.
- 24 Strobel, G.A. *Can. J. Plant Pathol.* **2002**, *24*, 14–20.
- 25 Strobel, G.A. *Crit. Rev. Biotechnol.* **2002**, *22*, 315–333.
- 26 Strobel, G.A., Daisy, B. *Microbiol. Molec. Biol. Rev.* **2003**, *67*, 491–502.
- 27 Strobel, G.A., Daisy, B., Castillo, U.F., Harper, J. *J. Nat. Prod.* **2004**, *67*, 257–268.
- 28 Li, J.Y., Strobel, G.A., Sidhu, R., Hess, W.M., Ford, E. *Microbiology* **1996**, *142*, 2223–2226.
- 29 Strobel, G.A., Miller, R.V., Miller, C., Condron, M., Teplow, D.B., Hess, W.M. *Microbiology* **1999**, *145*, 1919–1926.
- 30 Walsh, T.A. Inhibitors of  $\beta$ -glucan synthesis. In: Sutcliffe, J.A., Georgopapadakou, N.H. (Eds.), *Emerging Targets in Antibacterial and Antifungal Chemotherapy*. Chapman & Hall, London, **1992**, pp. 349–373.
- 31 Li, J.Y., Strobel, G.A., Harper, J.K., Lobkovsky, E., Clardy, J. *Org. Lett.* **2000**, *2*, 767–770.
- 32 Li, J.Y., Harper, J.K., Grant, D.M., Tombe, B.O., Bashyal, B., Hess, W.M., Strobel, G.A. *Phytochemistry* **2001**, *56*, 463–468.
- 33 Harper, J.K., Mulgrew, A.E., Li, J.Y., Barich, D.H., Strobel, G.A., Grant, D.M. *J. Am. Chem. Soc.* **2001**, *123*, 9837–9842.
- 34 Harper, J.K., Arif, A.M., Li, J.Y., Strobel, G.A., Grant, D.M. *Acta Crystallogr.* **2000**, *C56*, e570.
- 35 Lee, J.C., Yang, X., Schwartz, M., Strobel, G.A., Clardy, J. *Chem. Biol.* **1995**, *2*, 721–727.
- 36 Pulici, M., Sugawara, F., Koshino, H., Uzawa, J., Yoshida, S., Lobkovsky, E., Clardy, J. *J. Org. Chem.* **1996**, *61*, 2122–2124.
- 37 Pulici, M., Sugawara, F., Koshino, H., Uzawa, J., Yoshida, S., Lobkovsky, E., Clardy, J. *J. Nat. Prod.* **1996**, *59*, 47–48.
- 38 Pulici, M., Sugawara, F., Koshino, H., Uzawa, J., Yoshida, S., Lobkovsky, E., Clardy, J. *J. Chem. Res.* **1996**, 378–379.
- 39 Li, J.Y., Strobel, G.A. Jesterone and hydroxy-jesterone antioomycete cyclohexenone epoxides from the endophytic fungus, *Pestalotiopsis jesteri*. *Phytochemistry* **2001**, *57*, 261–265.
- 40 Hu, Y., Chaomin, L., Kulkarni, B., Strobel, G.A., Lobkovsky, E., Torczynski, R., Porco, J. *Org. Lett.* **2001**, *3*, 1649–1652.
- 41 Horn, W.S., Simmonds, M.S., Schwartz, R.E., Blaney, W.M. *Tetrahedron* **1995**, *14*, 3969–3978.
- 42 Brady, S.F., Clardy, J. *J. Nat. Prod.* **2000**, *63*, 1447–1448.
- 43 Zou, W.X., Meng, J.C., Lu, H., Chen, G.X., Shi, G.X., Zhang, T.Y., Tan, R.X. *J. Nat. Prod.* **2000**, *63*, 1529–1530.
- 44 Lu, H., Zou, W.X., Meng, J.C., Hu, J., Tan, R.X. *Plant Sci.* **2000**, *151*, 67–73.

- 45 Rodriguez-Heerklotz, K.F., Drandarov, K., Heerklotz, J., Hesse, M., Werner, C. *Helv. Chim. Acta.* **2001**, *84*, 3766–3772.
- 46 Miller, R.V., Miller, C.M., Garton-Kinney, D., Redgrave, G.B., Sears, J., Condrón, M., Teplow, D., Strobel, G.A. *J. Appl. Microbiol.* **1998**, *84*, 937–944.
- 47 Harrison, L., Teplow, D., Rinaldi, M., Strobel, G.A. *J. Gen. Microbiol.* **1991**, *137*, 2857–2865.
- 48 Ballio, A., Bossa, F., DiGioglio, P., Ferranti, P.P., Paci, M., Pucci, P., Scaloni, A., Segre, A., Strobel, G.A. *FEBS Lett.* **1994**, *355*, 96–100.
- 49 Zhang, Y.Z., Sun, X., Zechner, D., Sachs, B., Current, W., Gidda, J., Rodriguez, M., Chen, S.H. *Bioorg. Med. Chem.* **2001**, *11*, 903–907.
- 50 Keiser, T., Bibb, M.J., Buttner, M.J., Charter, K.F., Hopwood, D.A. *Practical Streptomyces Genetics*. The John Innes Foundation, Norwich, **2000**.
- 51 Guerny, K.A., Mantle, P.G. *J. Nat. Prod.* **1993**, *56*, 1194–1199.
- 52 Kunoh, H.J. *Gen. Plant Pathol.* **2002**, *68*, 249–252.
- 53 Castillo, U., Harper, J.K., Strobel, G.A., Sears, J., Alesi, K., Ford, E., Lin, J., Hunter, M., Maranta, M., Ge, H., Yaver, D., Jensen, J.B., Porter, H., Robison, R., Millar, D., Hess, W.M., Condrón, M., Teplow, D. *FEMS Lett.* **2003**, *224*, 183–190.
- 54 Ezra, D., Castillo, U., Strobel, G.A., Hess, W.M., Porter, H., Jensen, J., Condrón, M., Teplow, D., Sears, J., Maranta, M., Hunter, M., Weber, B., Yaver, D. *Microbiology* **2004**, *150*, 785–793.
- 55 Worapong, J., Strobel, G.A., Ford, E.J., Li, J.Y., Baird, G., Hess, W.M. *Mycotaxon* **2001**, *79*, 67–79.
- 56 Strobel, G.A., Dirksie, E., Sears, J., Markworth, C. *Microbiology* **2001**, *147*, 2943–2950.
- 57 Ezra, D., Strobel, G.A. *Plant Sci.* **2003**, *65*, 1229–1238.
- 58 Worapong, J., Strobel, G.A., Daisy, B., Castillo, U., Baird, G., Hess, W.M. *Muscador roseus anna*. nov.: an endophyte from *Grevillea pteridifolia*. *Mycotaxon* **2002**, *81*, 463–475.
- 59 Ezra, D., Hess, W.M., Strobel, G.A. *Microbiology* **2004**, *150*, 4023–4031.
- 60 Atmosukarto, I., Castillo, U., Hess, W.M., Sears, J., Strobel, G.A. *Plant Sci.* **1998**, *169*, 854–861.
- 61 Stinson, M., Ezra, D., Strobel, G.A. *Plant Sci.* **2003**, *165*, 913–922.
- 62 Guo, B., Dai, J., Ng, S., Huang, Y., Leong, C., Ong, W., Carte, B.K. *J. Nat. Prod.* **2000**, *63*, 602–604.
- 63 Strobel, G., Yang, X., Sears, J., Kramer, R., Sidhu, R.S., Hess, W.M. *Microbiology* **1996**, *142*, 435–440.
- 64 Strobel, G.A., Hess, W.M., Li, J.Y., Ford, E., Sears, J., Sidhu, R.S., Summerell, B. *Aust. J. Bot.* **1997**, *45*, 1073–1082.
- 65 Strobel, G.A., Ford, E., Li, J.Y., Sears, J., Sidhu, R., Hess, W.M. *System. Appl. Microbiol.* **1999**, *22*, 426–433.
- 66 Li, J.Y., Sidhu, R.S., Ford, E., Hess, W.M., Strobel, G.A. *J. Ind. Microbiol.* **1998**, *20*, 259–264.
- 67 Bashyal, B., Li, J.Y., Strobel, G.A., Hess, W.M. *Mycotaxon* **1999**, *72*, 33–42.
- 68 Young, D.H., Michelotti, E.J., Sivendell, C.S., Krauss, N.E. *Experientia* **1992**, *48*, 882–885.
- 69 Wang, J., Li, G., Lu, H., Zheng, Z., Huang, Y., Su, W. *FEMS Microbiol. Lett.* **2000**, *193*, 249–253.
- 70 Shrestha, K., Strobel, G.A., Prakash, S., Gewali, M. *Planta Med.* **2001**, *67*, 374–376.
- 71 Hoffman, A., Khan, W., Worapong, J., Strobel, G., Griffin, D., Arbogast, B., Borofsky, D., Boone, R.B., Ning, L., Zheng, P., Daley, L. *Spectroscopy* **1998**, *13*, 22–32.
- 72 Lee, J.C., Strobel, G.A., Lobkovsky, E., Clardy, J.C. *J. Org. Chem.* **1996**, *61*, 3232–3233.
- 73 Li, C., Johnson, R.P., Porco, J.A. *J. Am. Chem. Soc.* **2003**, *125*, 5059–5106.
- 74 Wagenaar, M., Corwin, J., Strobel, G.A., Clardy, J. *J. Nat. Prod.* **2000**, *63*, 1692–1695.
- 75 Strobel, G.A., Ford, E., Worapong, J., Harper, J.K., Arif, A.M., Grant, D., Fung, P.C.W., Chan, K. *Phytochemistry* **2002**, *60*, 179–183.
- 76 Harper, J.K., Ford, E.J., Strobel, G.A., Arif, A., Grant, D.M., Porco, J., Tomer, D.P., O'Neill, K. *Tetrahedron* **2003**, *59*, 2471–2476.
- 77 Lee, J., Lobkovsky, E., Pliam, N.B., Strobel, G.A., Clardy, J. *J. Org. Chem.* **1995**, *60*, 7076–7077.
- 78 Long, D.E., Smidmanský, E.D., Archer, A.J., Strobel, G.A. *Fungal Gen. Biol.* **1998**, *24*, 335–344.

## 5

### DNA Profiling of Plants

Hilde Nybom and Kurt Weising

#### 5.1

##### Introduction

Mistaken or willful adulteration of medicinal plant material can be a major problem in a wide range of situations. These include, for example, the production of traditional Chinese medicine prescriptions that often consist of a complex mixture of ingredients, or the manufacture of certain herbal products, that are regarded as dietary supplements in Western countries and therefore not subjected to stringent safety controls. The problem is perhaps best exemplified by the major medicinal crop ginseng. Cultivated common ginseng *Panax ginseng* C. A. Mey. fetches only about 10–20% of the value accorded to American ginseng *Panax quinquefolius* L., and is therefore often marketed under the more “expensive” name [1]. Even worse, completely unrelated and/or even poisonous species from various genera with similar-looking roots (e.g., *Bletilla*, *Curcuma*, *Gynura*, *Mirabilis* and *Phytolacca*) are sometimes also marketed as ginseng.

In medicinal plant production, quality control is usually attempted at two different levels: (i) taxonomic authentication of the source material; and (ii) correct prediction and standardization of the concentration of active phytochemicals. These issues are closely interrelated, as many medicinally important species and species complexes are quite heterogeneous, with differences in both composition and concentration of phytochemical substances [2]. For example, the use of field-collected material from *Achillea millefolium* as a drug is problematic because of the heterogeneous distribution of medicinally important azulenes, flavonoids and essential oils among closely related species that are difficult to distinguish in the field [3]. In order to avoid undesirable variability in the efficacy of the commercial products, not only the correct species assignment but also the unambiguous discrimination among intraspecific breeding lines, strains, cultivars or accessions is of utmost importance.

Traditionally, the identification of medicinal plants has been based on the evaluation of phenotypic characteristics such as morphology, smell, taste, color, texture, and size. These characteristics however have certain limitations, including: (i) in-

sufficient variation among the samples; (ii) subjectivity in the analysis; (iii) plasticity of the character, which could be due to the influence of the environment and management practice; and (iv) ability to be scored only at certain stages of the plant development (e.g., during flowering and/or fruiting) which may not coincide with the commercially important stage or organ (e.g., roots in ginseng production). More recently, traditional means of plant identification have been complemented by advanced analytical methods of phytochemistry such as high-pressure liquid chromatography (HPLC) and mass spectrometry (MS), as well as by molecular biology. Among these novel techniques, molecular markers based on DNA sequence variation have become increasingly important for the identification and authentication of medicinal plants and for the estimation of genetic diversity in these crops (see also the review by Shaw et al. [4]).

In this chapter, we shall shortly describe some of the most commonly used DNA methods for identifying plant material and for analyzing plant genetic diversity and relatedness. We also list a number of recent studies that illustrate the potential application ranges of plant DNA profiling in the characterization of medicinally important plants. This survey is necessarily brief, but for more comprehensive descriptions of the theory and methodology underlying DNA markers, experimental protocols, strategies of data evaluation, and more applications, the reader is referred to the monographic treatments presented by Henry [5], Avise [6] and Weising et al. [7].

## 5.2

### Methodology of Plant DNA Profiling

An obvious first step of most DNA profiling methods is the isolation of genomic DNA from the sample of interest. Different profiling techniques require different levels of purity of the DNA preparation. For example, high-quality DNA (and also quantity!) samples are needed for DNA fingerprinting based on restriction fragment length polymorphism (RFLP; see Section 5.2.2.1) and amplified fragment length polymorphism (AFLP; see Section 5.2.2.4), as well as for all other methods that involve the initial treatment of genomic DNA with restriction enzymes. These enzymes are sensitive to small amounts of impurities, and total or partial inhibition of their activity will result in irreproducible banding patterns. On the other hand, even highly degraded and/or contaminated preparations obtained from so-called “quick and dirty” methods of DNA isolation, may still give interpretable results when analyzed by direct DNA sequencing (see Section 5.2.1) or microsatellite markers (see Section 5.2.3).

Fresh leaves are the standard starting material for plant DNA isolation, but numerous other sources have been successfully used. These include flower petals [8], pollen grains [9], seeds [10], roots [11], rhizomes [12], tubers [13] and even dried wood [14, 15]. Samples that cannot be processed immediately should preferably be preserved by either freezing at  $-20^{\circ}\text{C}$  (or lower), freeze-drying, treatment with certain chemicals [16], or quick-drying in silica gel [17].



There are many factors that potentially interfere with the successful isolation of DNA from plant tissues. For example, endogenous nucleases may be activated during the isolation procedure, resulting in DNA degradation. Also, polysaccharides, polyphenols, latex, essential oils and other secondary compounds (which are common ingredients of medicinal plants; see [18]) may be co-isolated and cause damage to DNA and/or inhibit subsequent enzymatic reactions. Numerous strategies have been proposed to remove such impurities, including ultracentrifugation, preparative gel electrophoresis, affinity chromatography, and many more [7]. DNA preparations from forensic samples, herbarium specimens or processed plant products are particularly problematic, because they are often degraded, chemically modified, and/or contaminated by foreign DNA and by substances inhibitory to the polymerase chain reaction (PCR). Such specimens usually require special treatments [19, 20].

As an example, a DNA isolation protocol for market samples of dry tea leaves was presented by Singh and Ahuja [21]. Relatively intact DNA was obtained, but PCR was only successful when the leaves were preincubated in water and re-dried before DNA extraction. This procedure removed much of the brown color, and presumably also part of the secondary products that otherwise interfered with DNA amplification. Post-brewed tea samples, however, yielded heavily degraded DNA, which was unsuitable for PCR [21].

Because of the factors listed above, plant DNA isolation efficiencies vary from species to species, and from tissue to tissue. Accordingly, a huge number of plant DNA isolation protocols have been published. These methods differ in many respects, including the disruption of tissues and cells, the composition of extraction buffers, and in the way that DNA is purified from other cell ingredients. A number of common principles allow the distinction of certain “families” of methods. Perhaps most commonly used is the so-called cetyltrimethylammonium bromide (CTAB) strategy initially developed by Murray and Thompson [22], of which more than 100 variants have since been published. More recently, commercial plant DNA isolation kits and automated extraction have gained increasing attention and importance, but these are also more costly than the traditional techniques.

A comprehensive description and discussion of the wide variety of plant DNA extraction procedures was provided by Weising et al. [7]. Specific protocols have been designed for various medicinally important plant species, including *Achillea millefolium* (milfoil; [23]), *Allium sativum* (garlic; [18]), *Artemisia annua* [18, 24]; *Catharanthus roseus* [18], *Curcuma longa* (turmeric; [12]), *Eleutherococcus senticosus* (Siberian ginseng; [23]), *Mentha arvensis* [18], *Papaver somniferum* (opium poppy; [25]), *Taxus wallichiana* (yew; [18]), and *Zingiber officinale* (ginger; [12]).

### 5.2.1

#### DNA Sequencing

Determining the DNA sequence of one or more defined genomic regions is the most obvious strategy to obtain genotypic data from any organism. Having been somewhat tedious in the past, the collection of DNA sequence data for genotyping purposes has been facilitated considerably by methodological and computational



improvements, as well as by the availability of commercial sequencing services. The invention of the PCR by Mullis and colleagues (reviewed in [26]) has been a key step in this development. The PCR is an enzymatic method that allows the exponential *in-vitro* multiplication (or “amplification”) of any DNA sequence of interest, as defined by a pair of flanking primers that serve as starting points for a thermostable DNA polymerase. Typically, PCR products from the DNA region of interest are sequenced directly on an automated, fluorescence-based sequencing machine. Mutational differences are then detected by vertical alignment of the DNA sequences obtained from orthologous regions of all organisms to be compared.

Several issues should be considered when choosing a suitable DNA region for sequence analysis. First, the region should exhibit an adequate level of variation for solving the problem under investigation. For example, housekeeping genes tend to be highly conserved, whereas microsatellites (see Sections 5.2.2.3 and 5.2.3) are hypervariable. Second, the mode of inheritance of the targeted piece of DNA may have to be taken into account (inheritance is typically uniparental for organellar DNA and biparental for nuclear DNA). Finally, sequence data from flanking regions should be available for PCR primer design. Often, so-called universal primer pairs are used to generate the sequencing template. These are designed to bind to conserved DNA sequence motifs within genes, and are therefore transferable across species, genera and even families. Well-known examples are the so-called internal transcribed spacer (ITS) primers that bind to the conserved coding region of the nuclear 18S and 26S ribosomal RNA (rRNA) genes and amplify the often polymorphic internal transcribed spacer (ITS) region [27]. Sets of universal primers are also available for organellar DNAs (see Section 5.2.4). In medicinal plants, sequence data of the ITS or other ribosomal RNA gene regions have frequently been applied for species identification [28–31] (see Section 5.3.1.1).

## 5.2.2

### Multilocus DNA Profiling

The techniques summarized in this section share a number of common characteristics. First, a more or less complex banding pattern of DNA fragments is generated that can serve as a type of bar code (“DNA fingerprint”). Depending on the technique used and the organisms investigated, this bar code can be specific to, for example, an individual, a clone, a population, or even a species. Second, it is generally possible to generate this bar code without previous DNA sequence information. Most multilocus methods are therefore universally applicable to all organisms, whether prokaryotic or eukaryotic. Third, the DNA fragments underlying the bar code presumably reflect a more or less random sample of the whole genome (unlike DNA sequencing, where only one or few genomic loci are analyzed). Fourth, individual bands within a pattern are mostly biallelic and can only be scored as present or absent. It is usually not possible to assign individual DNA fragments to a particular genomic locus, allelic states cannot be determined, and homo- and heterozygotes cannot be distinguished. Multilocus markers must therefore be treated as dominant, which reduces their potential for in-depth genetic analyses.

### 5.2.2.1 Hybridization-Based RFLP Fingerprinting

Based on Southern blot analysis with radioactive hybridization probes and the RFLP technique, the so-called “DNA fingerprinting” methodology was first introduced to plant genome analysis during the late 1980s (reviewed in [32]). With this method, it became possible for the first time ever to distinguish directly between closely related plant genotypes at the DNA level, using only a single analysis. Hybridization-based DNA fingerprinting has been used in many early studies on medicinal plants, for example for the identification of micropropagated *Achillea* clones [3]. The technique is highly reproducible and reliable, but involves many experimental steps and requires microgram quantities of DNA. This latter issue is of particular relevance for medicinal samples, where often only small amounts of material are available for examination. Today, hybridization-based fingerprinting is rarely used, mainly because virtually all subsequently developed methods benefit from the advantages of the PCR.

### 5.2.2.2 PCR with Arbitrary Primers

The introduction of PCR-based molecular marker methods during the early 1990s constituted a new milestone in the field of DNA fingerprinting; two methods using single primers with arbitrary sequence were published in 1990 [33, 34]), and a third method in 1991 [35]. Numerous variants followed (for a review, see [7]). These usually short, arbitrary primers were shown to generate anonymous PCR amplicons from genomic DNA, resulting in polymorphic banding patterns after gel electrophoresis and staining.

The RAPD (random amplified polymorphic DNA) approach developed by Williams et al. [34] has become the most popular variant of this “prototype” of PCR-based DNA profiling, mainly because of its technical simplicity. On the negative side, the reproducibility of RAPD banding patterns turned out to be relatively poor, especially when results were compared among laboratories [36]. The value of RAPD (and related) markers for genotype identification and genetic relatedness studies has therefore been controversial. Nevertheless, literally thousands of RAPD investigations on hundreds of species have been published during the past 15 years, also including medicinally important plant species from various genera (e.g., *Artemisia* [37], *Achillea* [3], *Echinacea* [38], and *Panax* [30, 39, 40]).

### 5.2.2.3 PCR with Microsatellite-Complementary Primers

Another variant of multilocus PCR markers was proposed a few years later, and was variously coined inter-simple sequence PCR (ISSR; [41]), single-primer amplification reactions (SPAR; [42]) or microsatellite-primed PCR (MP-PCR; [43, 44]). The primers employed in this strategy were designed to anneal at the 5'- or 3'-ends of so-called microsatellite DNA motifs, also known as simple sequence repeats (SSRs). Microsatellites consist of tracts of short (1–5 bp) direct DNA repeats, which are present at tens of thousands of sites in all eukaryotic and many prokaryotic genomes examined to date (for reviews, see [7, 45]; see also Section 5.2.3). The copy

number of the tandemly repeated motifs within a microsatellite is often highly variable, resulting in frequent size polymorphisms.

If two inversely oriented microsatellites are located close enough to each other on opposite strands of the DNA, primer binding results in the amplification of the inter-repeat region. The use of so-called 5'-anchored primers ensures that part of the polymorphic repeat itself is included in the product, enhancing the chance of size variation [41, 46]. Like RAPDs, MP-PCR bands are separated by gel electrophoresis and visualized by staining, fluorescence, or radioactivity. The method appears to be under-utilized in medicinal plants, but has proven useful for studying genetic variation in the endangered tropical tree *Hagenia abyssinica* [47].

#### 5.2.2.4 AFLP Analysis

A further new method, known as AFLP analysis, which incorporated elements of both RFLP and RAPD, was also developed during the mid-1990s [48, 49]. Although technically more demanding than RAPDs, AFLP analysis produced very high numbers of polymorphic bands in a single experiment. The procedure involves several steps. In the first step, genomic DNA is digested with restriction enzymes (usually a combination of two enzymes is used, one with a six-base and one with a four-base recognition sequence), and short adapters of a defined sequence are ligated to both ends of the resulting DNA fragments. A subset of these fragments is then amplified by PCR with a specially designed pair of primers. The 5'-portion of such an AFLP primer is complementary to the adapter sequence, whereas its 3'-end extends for one or a few, arbitrarily chosen, so-called "selective" nucleotides into the restriction fragment. Because exact matching of the 3'-end of a primer is required for successful PCR, only those fragments are amplified whose outmost nucleotides are able to base-pair with the selective nucleotide(s) of the primer(s). Statistically, this is the case for 1/16 of all restriction fragments if both primers carry a single base extension, but only for 1/4096 of all fragments if both primers carry a three-base extension. PCR products are eventually separated on polyacrylamide gels, and are visualized by radioisotopic labeling, fluorescence, or silver staining.

The complexity of an AFLP banding pattern can be adapted to organisms of different genome size by choosing appropriate numbers of selective nucleotides. For eukaryotic genomes, PCR is usually performed in two successive steps, with +1 selective nucleotide in the first PCR (so-called preamplification), and +3 in the second PCR. This procedure typically results in about 50 to 100 bands which are relatively easy to evaluate. Examples of the use of AFLPs for investigating medicinal plants include, among many others, the authentication of American ginseng, *Panax quinquefolius* [1], and the prediction of phytochemical contents in *Echinacea* [2].

#### 5.2.3

##### Locus-Specific Microsatellite DNA Markers

Another popular DNA marker method is based on PCR with primers that are complementary to the DNA sequences *flanking* microsatellites, rather than binding to

the repeats themselves (which is the case in MP-PCR; see Section 5.2.2.3). As a consequence of the variable number of tandem repeats within a microsatellite, the products amplified by such primer pairs often exhibit considerable length differences among individuals or populations of the same species. Microsatellite analysis, which was first introduced for plants in 1992 [50], produces locus-specific, multiallelic, easy-to-use, codominantly inherited bands with high levels of polymorphism and reproducibility. The resulting markers are excellent tools for genotype identification, population genetics, genetic mapping and gene tagging. Moreover, microsatellite data are easily managed and compared in databases, several marker loci can be analyzed simultaneously by multiplexing fluorescence-labeled primer panels [51, 52], reasonably well-interpretable results are obtained even with degraded DNA (when neither RAPDs nor AFLPs perform well), and the species-specificity of the markers reduces the sensitivity to contamination by foreign DNA.

Their species-specificity is also a major drawback of microsatellite markers. Contrary to the generic multilocus profiling approaches described in Section 5.2.2, *a priori* sequence information is needed for primer design, and the development of species-specific primer pairs can be costly and time-consuming (for reviews, see [53, 54]). Public databases have become an increasingly important source for microsatellite sequences, and database mining has become a valuable alternative to genomic cloning in many species. Furthermore, microsatellite-flanking primer sequences are often conserved in congeneric species, or occasionally, even in other genera (reviewed in [7]). Marker transferability is usually best for trinucleotide repeats that are often located in gene coding regions. Expressed sequence tag (EST) databases are increasingly used for “fishing” well-conserved microsatellite markers, as has been demonstrated, for example, in cereals [55, 56].

One potential problem for some applications is the fact that mutation rates can be very high, especially for dinucleotide repeat loci. Microsatellite markers are therefore not recommended at or above the species level. To date, only a few studies have appeared on the application of microsatellite DNA in medicinal plants [57, 58], but this is likely to increase in the near future.

#### 5.2.4

#### **PCR-Based RFLP Analysis of Organellar and Nuclear Genomes**

Whereas the above-mentioned DNA marker methods focus on nuclear DNA, it may sometimes be more feasible to study the organellar genomes. A series of universal PCR primers have been developed, which allow the amplification of chloroplast and mitochondrial DNA introns and intergenic spacers in a wide array of plant species [59–61]. PCR products amplified with organelle-specific primer pairs are either sequenced directly (see Section 5.2.1), or digested with restriction enzymes in an approach known as PCR-RFLP. The lack of genetic recombination of the chloroplast genome allows the combination of polymorphisms observed at several loci to form a so-called haplotype. PCR-based RFLP analysis can also be applied to nuclear DNA, as exemplified in the CAPS (cleaved amplified polymorphic sequences) approach [62].

## 5.2.5

**Other DNA Marker Methods**

During the past decade, a plethora of additional, mostly PCR-based DNA marker methods have been developed, none of which has become as popular as RAPDs, MP-PCR, AFLPs and microsatellites. The PCR primers employed in these more exotic methods are targeted at a wide range of genomic DNA motifs, including pathogen resistance genes, intron-exon splice junctions, transposons, minisatellites, and many others. The diversity of methods has been further enhanced by various combinations of existing methods, as exemplified by SAMPL (selective amplification of polymorphic microsatellite loci [63]), which combines AFLP- and microsatellite-specific primers, and by S-SAP (sequence-specific amplification polymorphism [64]), which combines AFLP- and retrotransposon-specific primers (for a comprehensive survey on these techniques see [7]).

## 5.2.6

**The Next Generation: SNPs and DNA Microarrays**

The analysis of single nucleotide polymorphisms (SNPs) represents a relatively recent addition to the spectrum of plant DNA profiling methods (reviewed in [65–67]). The term “SNP” refers to a single base pair position in the DNA, at which different sequence alternatives exist at notable frequencies in a population or species. In principle, a SNP locus can have two to four alleles, but biallelic polymorphisms usually prevail. Because SNPs are caused by base substitutions, mutation rates at each individual marker locus are relatively low. Nevertheless, even closely related genotypes are discriminated by thousands of SNPs distributed throughout the genome. The average density of SNPs depends on the species and genomic region investigated. In the few plant species examined in detail to date, about one SNP was found per 200–500 bp [67].

Establishing SNP-based genomic profiling for a plant species of interest involves: (i) the discovery of a sufficient number of SNPs in the respective genomes; and (ii) the development of a suitable assay. For model organisms and major crops, database mining is a promising strategy for discovering SNPs *in silico* [68]. However, few database data are yet available for medicinal plant species, and SNPs will therefore have to be discovered experimentally. This can be done in a variety of ways, perhaps most economically by single-stranded conformation polymorphism (SSCP) analysis of PCR products (reviewed in [69]). A good option is also to convert other types of markers into SNPs, as has been demonstrated for AFLP products [70].

Many strategies have been developed for SNP detection, ranging from direct sequencing or SSCP analysis on the trivial side of the spectrum, to high-throughput allele-specific PCR, ligation or oligonucleotide hybridization methods on the more elaborate side (for reviews, see [71, 72]). “SNPology” is a rapidly expanding field, and new techniques and modifications of existing techniques are developed at

high rates. SNP assays become most time-efficient in conjunction with DNA microarray technology, where multiple SNP-carrying DNA oligonucleotides are assembled and analyzed simultaneously on a small silicon chip (for recent reviews, see [73, 74]).

In plants, SNP markers are already well-established in the model organism *Arabidopsis thaliana* [e.g., 75] and in major crops such as the cereals [e.g., 68, 76]. However, SNPs are not yet in common practice in medicinal plants. The need to develop specific SNP-based marker systems for each species of interest is a major obstacle, and is certainly the main reason why generic markers such as RAPDs and AFLPs are still preferred. Nevertheless, chip-based DNA profiling of Chinese medicinal plant DNA has already been performed [77–79] (for details, see Section 5.3.1.1). Moreover, an electrochemistry-based approach was suggested by Lee and Hsing [80], who used a 16-base DNA oligonucleotide immobilized on an electrode surface for hybridization detection of PCR-amplified target DNA molecules. With this hand-held device, it was possible to discriminate between two Chinese herbal species of *Fritillaria* [80].

## 5.3 Applications

### 5.3.1

#### Genotype Identification

Most of us are aware of the importance of individual-specific human DNA fingerprints in, for example, forensics. For medicinal plant material, identification issues usually focus on species (or other taxonomic units) or accessions but, occasionally, also on individual genotypes when, for example, suspected of somaclonal variation after *in-vitro* propagation.

##### 5.3.1.1 Plant Species

Unambiguous identification of a given plant species by DNA sequencing is relatively easy and straightforward when the target species is sufficiently distinct from all other relevant taxa. Proper identification is considerably more ambiguous when closely related species are compared. For example, Ngan et al. [81] attempted to discriminate the roots of six *Panax* species from each other and from two common adulterants, *Mirabilis jalapa* and *Phytolacca acinosa*, by DNA sequence analysis of the 5.8S rRNA gene. High levels of sequence homology (ca. 99%) were shared among the six *Panax* species, but also between *Panax* and the two adulterants (96–97%). Instead, better discrimination was achieved by sequencing the two internal transcribed spacers (ITS1 and ITS2) surrounding this gene. Whereas ITS sequence homology among the various *Panax* species was still high (93–99%), it fell to less than 62% when these were compared with the two putative adulterants from

other genera. The few ITS sequence differences between the closely related species *P. ginseng* and *P. quinquefolius* were utilized in developing an RFLP-based discrimination protocol; even as little as 10% contamination of *P. ginseng* in the *P. quinquefolius* sample could be detected in this way. High levels of sequence homology among *Panax* species were also reported for the nuclear 18S rRNA gene and the *matK* gene, although minor intraspecific polymorphism was noted in *P. notoginseng* [28]. In contrast, the 5S rRNA genes were relatively divergent (76–97% sequence homology among *Panax* species [30]), though with such sequences there is an increased risk of confounding intraspecific variability.

Species identification and discrimination may be less reliable when DNA profiling methods are used instead of DNA sequencing. Because most of the commonly used DNA marker methods reveal considerable amounts of intraspecific polymorphism, so-called “species-specific” or even “species-diagnostic” marker bands may not necessarily hold up for the whole species. This is especially true when such claims are based on the analysis of a few samples only (as with studies on *Echinacea* [38] and *Panax* species [40]). Considerable intraspecific diversity was reported in a study of *P. ginseng* and *P. quinquefolius*, based on RAPD and allozymes [82]. The same two species were also analyzed using AFLP on a set of samples obtained from several different farms in China and Korea, and in Canada and the USA, respectively [1]. The latter species was shown to contain more variation between localities (similar index values for pairwise comparisons: 0.64–0.96) than the former (0.88–0.99). One AFLP band detected only in *P. ginseng* was excised from the polyacrylamide gel, and then cloned and sequenced. It proved to contain a minisatellite region (eight repeats of 22 nucleotides). When used as a single PCR primer, the minisatellite motif produced a profile discriminatory for the two *Panax* species [1].

Sequencing of the nuclear ITS1-5.8S-ITS2 rRNA gene region was successfully used to differentiate among 16 species in the orchid genus *Dendrobium*, and also between the orchids (some of which are used for the Chinese medicine “herba dendrobii” or “shihu”) and some commonly used adulterants such as *Pholidota* [29]. In this study, species authentication was facilitated by low levels of intra-specific ITS variation. More recently, this ITS sequencing information was used to develop a glass slide-based oligonucleotide DNA microarray, where target sequences were labeled with a fluorescent dye, and the presence of hybridized target sequence was detected with a confocal laser scanner [79]. This microarray produced distinctive signals for the five *Dendrobium* species traditionally recognized as having medicinal value, and it was able specifically to detect the presence of *D. nobile* material in a medicinal formulation containing nine different herbal components.

A DNA microarray approach for species identification was also taken by Carles et al. [78]. These authors designed a silicon chip that could differentiate among a set of 20 common and toxic plant species currently used in traditional Chinese medicine. The probes immobilized on the chip were based on 5S rRNA gene sequences or, in two cases, on the sequence of a leucine-specific transfer RNA (tRNA) gene. Even the closely related species pair *Datura innoxia* and *D. metel* (Solanaceae) could be distinguished, in spite of differing by only two nucleotides.



### 5.3.1.2 Plant Cultivars and Accessions

Successful discrimination among cultivars or accessions depends, to a large extent, on the means of propagation, as well as the mating system of the crop species under study. All plants belonging to a particular cultivar of a vegetatively propagated crop are expected to share identical DNA fingerprints, except for rare mutations – so-called “sports”. The identification of cultivar-specific band patterns is fairly easy when the cultivar itself is homogeneous, as demonstrated by a RAPD study in *Panax ginseng* [83]. One RAPD band was found that could identify a selected elite strain, Kaishusan, from other strains. By sequencing this band, primers for a more easily used locus-specific marker (see Section 5.4) were developed.

In most cases, DNA markers are unable to detect any difference between a sport and its original cultivar [e.g., 84]. This is because: (i) only a very small portion of the genome is sampled, even when a large number of markers are employed; and (ii) changes in phenotype are often a consequence of chimerism, caused by a mutation in only one of the three meristematic cell layers that differentiate into the various plant tissues [85]. However, there are also exceptions. Although garlic (*Allium sativum*) has been propagated vegetatively since time immemorial, a surprisingly high number of quite different genotypes were encountered by analysis with AFLP, RAPD and isozyme markers [86]. Possibly many of the clones have existed for a very long time and therefore acquired numerous mutations, although occasional influx from sexual forms may also have occurred.

In sexually propagated crops, considerable levels of genetic variability usually persist also *within* cultivars or accessions. Pooling (or bulking) of samples is sometimes undertaken for generating cultivar-specific DNA profiles, especially in out-crossing crops. For soybean *Glycine max*, Diwan and Cregan [87] suggested that analyses should be based on bulks of 30 to 50 plants. Alternatively, several plants from each cultivar can be analyzed individually, and intra- and intercultivar variability are then partitioned statistically, for example by an analysis of molecular variance (AMOVA) [88].

The choice of profiling method should take the type of plant into consideration as well as the total number of samples to be examined. For small tests with only a few simultaneously analyzed samples, reproducibility and documentation may be less important, and any method providing sufficiently variable markers would be acceptable. Numerous studies in this direction have been carried out using multi-locus methods such as AFLP and RAPD profiling. For example, six commercial cultivars of thyme (*Thymus vulgaris* L.), all belonging to the thymol chemotype, were successfully differentiated using RAPD markers, and could be divided into two major groups [89]. The same two groups were retrieved in a multivariate analysis based on their oil content profiles, as determined by gas chromatography.

### 5.3.1.3 In-Vitro-Propagated Plant Material

Tissue culture techniques often produce regenerants that differ from their parental phenotype, a phenomenon termed “somaclonal variability”. As with sports,



such variation is rarely detectable with DNA markers. Thus, somatic embryogenesis induced in callus tissues of *Panax notoginseng* resulted in plantlets that could not be differentiated even with a large set of RAPD primers [39]. Similarly, no variation in RAPD banding patterns was encountered among first-regeneration cycle somaclones of *Hypericum perforatum*, whereas three out of 51 somaclones obtained from the second cycle differed by a single band [90].

### 5.3.2

#### Genetic Diversity

In many situations, it is necessary to estimate the amount of genetic diversity in the plant material from which samples are taken for authentication. Markers based on slowly evolving DNA sequences are adequate for the analysis of historical events on longer timescales, whereas markers derived from fast-evolving sequences are more suitable for analyzing recently diverged populations. For highly diverse entities – for example, populations or accessions in cross-pollinating and variable species – a larger number of samples may need to be taken, or a higher number of markers analyzed for each sample.

##### 5.3.2.1 Variation and Relatedness Among Cultivars and Accessions

Inter-cultivar relationships can be studied at different scales. Sometimes, the only objective is to assign the most likely parents from a selection of candidates, whereas in other cases the intention is to reveal relationships across the whole set of cultivars or accessions available for the study. In the search for *Artemisia annua* plants with increased levels of artemisinin production, screening of genetic diversity was undertaken in a ten-year-old introduced population in India [37]. Since no less than 97 out of 101 RAPD markers were polymorphic, high levels of variation obviously occurs in this population, suggesting that genetic improvement for phytochemical traits should be possible.

As may be expected from its rarity in nature, very low levels of genetic diversity were encountered within and among accessions of the “living fossil” *Ginkgo biloba* introduced from China and now grown in eastern USA [91]. Thus, no variation at all was detected by a PCR-RFLP analysis of chloroplast DNA (see Section 5.2.4), and only five out of 99 RAPD fragments turned out to be polymorphic. One of the fragments was turned into a probe and used for hybridization with Southern-blotted RAPD gels to allow a more accurate analysis. Using the excised RAPD band directly as a probe yielded multibanded (but different) patterns in all the screened samples. When the probe was first purified, hybridization revealed a corresponding band only in those samples that appeared to have the band also with the initial analysis [91].

In a study on *Cannabis sativa*, Gilmore et al. [57] demonstrated the potential of microsatellite analysis for forensic investigations. According to an AMOVA, 25% of the total genetic variation existed between accessions, and 6% between the two major *Cannabis sativa* groups used for fiber and drug production, respectively.

These results showed that microsatellite DNA fingerprinting may aid in determining agronomic type, geographic origin and production locality of these clonally propagated drug crops. It was, however, not possible to find any consistency between the patterns of relatedness among the different accessions on the one hand, and their contents of tetrahydrocannabinol on the other hand.

#### 5.3.2.2 Amount and Distribution of Variability in Wild-Growing Plants

Information concerning the amount and geographic distribution of intraspecific genetic variation can be important when harvesting plant tissue in the wild for medicinal drug production, but even more when setting up programs for genetic improvement of the crop itself. Both dominantly (e.g., AFLP and RAPD) and codominantly inherited markers (e.g., microsatellites) have frequently been used to study population structure. The overall patterns concerning the extent and partitioning of genetic variability appear to be quite similar regardless of marker type, provided that the numbers of analyzed markers are sufficiently high [92]. The general picture arising from large data compilations is that long-lived, outcrossing and late successional species retain most of their variation *within* populations, whereas annual, self-pollinating and early successional species allocate more variation *among* populations [92].

In order to evaluate genetic variability in the rapidly decreasing *Valeriana wallrothii* (a member of the medicinally important *V. officinalis* species complex) in Italy, eight populations were studied with AFLP and chloroplast microsatellite markers [93]. AFLP data were highly informative, and demonstrated pronounced population differentiation in spite of the outcrossing breeding behavior of the species, as well as strong effects of grazing and agriculture. By contrast, only one of six chloroplast loci was polymorphic, with two alleles. The amount and geographic partitioning of genetic variation have been determined in many other medicinal plants, such as foxglove (*Digitalis obscura*) studied with RAPD [94], drum-stick tree (*Moringa oleifera*) studied with AFLP [95]), endod (*Phytolacca dodecandra*) studied with AFLP and RAPD [96], neem tree (*Azadirachta indica*) studied with AFLP and SAMPL [97], and tea tree (*Melaleuca alternifolia*) studied with microsatellite markers [98]. Wide ranges of genetic variability and its spatial distribution were observed, in spite of all these species being outcrossing and rather widely distributed.

Some plant species are able to form large clones, due to vegetative propagation and/or apomixis – that is, seed set without prior fertilization. Because all members of a clone are genetically identical, the type of marker used for differentiation among clones is largely irrelevant provided that the discriminatory power is sufficiently high. Thus, apomictically and sexually derived offspring in the facultative apomict *Hypericum perforatum* could be discriminated by RAPD profiling [99] as well as by AFLPs and RFLP fingerprinting [100].

DNA fingerprinting is an important instrument for the characterization of germplasm; that is, the total genetic diversity present in the world for a certain crop, encompassing old and newly bred cultivars, landraces and related wild species. DNA markers have also provided valuable data for the identification of suit-

able material for *in-situ* preservation, the establishment of *ex-situ* gene banks and core collections with maximum diversity [101, 102], and for the detection of undesirable duplicates in germplasm collections [86, 103]. If drug production is based mainly on wild-collected material of rare plant species, conservation issues may become very important, as has been discussed in the frame of a RAPD study of variability and gene flow in the African tree *Prunus africana* [104], and for domesticated and wild species of Asian *Panax* studied with ITS sequencing and AFLP [105].

### 5.3.2.3 Plant Systematics

Knowledge concerning phylogenetic relationships (species origination) and phenetic patterns (present-day similarity among species) can help to develop methods for discrimination among species, as well as provide information about which species may constitute the most promising sources of certain biochemical compounds. Many phylogenetic studies have been based on DNA sequencing data, especially of cpDNA and nuclear ribosomal RNA genes and spacers [e.g., 27]. Sequencing the ITS region was, for example, undertaken in a worldwide collected set of 50 *Hypericum* taxa [31]. Three strongly supported monophyletic clades plus several secondary monophyletic groupings were revealed. The medicinally important *H. perforatum* could be distinguished from all other analyzed species. Another *Hypericum* study made use of PCR-RFLP with universal chloroplast DNA primers [106]. Polymorphism was found between three of the six taxa collected in Croatia, but not among three subspecies of *H. perforatum*.

In another cpDNA-CAPS study, all 15 recognized taxa in the genus *Hippophae* were analyzed [107]. Two parsimony analyses were carried out; one based on PCR-RFLP of cpDNA, and one based on a combined data set (cpDNA plus morphological traits). The results of both analyses were congruent with each other, with those of a previous RAPD study, and in part also with some earlier taxonomic classifications. A PCR-RFLP study of five amplified cpDNA fragments was performed with 13 populations of the genus *Panax* in Nepal and China [108]. Distinct groupings were obtained, suggesting that most of the subspecies treated under *P. pseudoginseng* are quite different from each other and from subsp. *pseudoginseng* itself, and should be given species rank.

Multilocus DNA profiles are often exploited for systematic analyses of closely related species, where neither ITS nor cpDNA sequencing reveal sufficient polymorphism [109]. *Echinacea* is a genus with very restricted polymorphism in the ITS1, ITS2 and 5.8S regions [110], and may therefore be more suited to multilocus marker approaches. Kim et al. [111] initiated an AFLP study comprising 39 plants from 12 *Echinacea* taxa. Two species were represented by two populations each, the others by a single population. A neighbor-joining phenogram based on approximately 1000 polymorphic AFLP fragments demonstrated the existence of two major clades, with *E. pupurea* in the smaller clade together with *E. sanguinea* and *E. simulata*.

Potential problems with the use of dominant markers for phylogenetic reconstruction are mainly caused by the (usually unproven) assumptions that all DNA

fragments within a pattern represent independent characters, and that fragments of equal length are homologous with each other (see also two recent reviews by Bussell et al. [112] and Koopman [113]). In general, homology is quite high when closely related taxa are compared, but drops sharply with increasing phylogenetic distance. Thus, Mechanda et al. [114] analyzed co-migrating AFLP fragments from several *Echinacea* species by DNA sequencing. Whereas pairwise sequence identities for an AFLP band that was monomorphic among all taxa ranged from ~76% to 99% *within* a species, it fell to an average of ~58% *among* species. Still lower sequence identities were observed for a polymorphic band that was present in 48 of 79 taxa. Nevertheless, the existence of a sizeable phylogenetic signal has been demonstrated in many AFLP-based data sets, and various methods to quantify the existence of phylogenetic information and to evaluate the support of internal branches in the resulting trees are available [113].

### 5.3.3

#### Gene Tagging

The breeding of medicinal plant crop plants has the potential to enhance both yield and quality of the ultimate product. In this context, one of the most important applications of molecular markers is the establishment of a genetic linkage between a trait of interest and an easy-to-detect marker. These markers can then be exploited for so-called marker-assisted selection, a strategy that allows the detection of and selection for specific traits that would otherwise require time-consuming and/or costly analyses. Such a character is sex in dioecious plants, which may not be determined until the plants are old enough to flower for the first time. For example, a sex-linked RAPD marker was developed and subsequently shown to occur in all the male plants of sea buckthorn *Hippophae rhamnoides* while lacking in all the female plants of the same seedling family [115]. Another well-known dioecious plant of medicinal interest is *Cannabis sativa*, for which RAPD analysis has also proved useful for developing male-specific markers [116].

The construction of genetic linkage maps is one of the most prominent applications of DNA markers [117]. Such maps are, in their turn, very useful for elucidating the genetic basis of complex traits, and for localization and cloning of genes. Genetic linkage maps based on various types of molecular markers have also been constructed for plants of medicinal relevance, such as garlic and Pacific yew (*Taxus brevifolia*). In the latter, 41 of a total of 102 RAPD bands were distributed into 17 linkage groups [118]. In garlic, SNPs, SSRs and RAPDs were used to define nine linkage groups, one of which also included a locus for male fertility [119]. In another garlic project, 216 and 143 AFLP markers, respectively, were mapped in two segregating populations obtained by selfing [120]. In addition, gene-specific markers for alliinase, chitinase, sucrose 1-fructosyltransferase and chalcone synthase could be placed on these maps.

In a different gene tagging approach, directed at the establishment of markers for multiple-gene inherited traits, Baum et al. [2] screened 52 *Echinacea purpurea* plants (both cultivated and wild) with a total of 232 AFLP markers. These same

plants were also subjected to HPLC analysis of two bioactive phytochemicals, cichoric acid and “tetraene”. Regression analysis and canonical correlation analysis were used to explore the relationships between DNA bands and chemical contents. Thus, a set of 22 DNA bands were found, which can be used in the future for predicting the phytochemical profile of individual plants.

#### 5.4

#### Conclusions

The rapidity with which large numbers of samples can be processed and the ubiquitous applicability to all organisms without previous sequence information has made PCR-based multilocus profiling methods highly popular for many applications, including the authentication of medicinal plants. However, these methods have their drawbacks. An important issue is the often limited reproducibility, especially in the case of RAPDs [36]. MP-PCR analyses can be performed at higher stringency and were therefore initially claimed to be more reliable than RAPDs [43], but this view has been challenged in later investigations [44]. Among multilocus markers, reproducibility appears to be best for AFLP [121] which is also regarded as the method of choice when high numbers of bands and maximum discriminatory potential are desired. Reproducibility can also be increased by converting individual DNA fragments of particular diagnostic importance into locus-specific SCAR markers (sequence characterized amplified regions [83, 122, 123]). This is done by sequencing the gel-purified fragment, followed by designing a locus-specific PCR primer pair.

Data sets produced by DNA sequencing are usually more reliable, as are locus-specific methods such as microsatellites and SNPs. Because these methods are also less sensitive to contamination and DNA degradation, they should actually be preferred over multilocus profiling, be it RAPD or AFLP. Unfortunately, DNA sequencing is not sufficiently sensitive for many applications, and the development of microsatellites and SNPs is both expensive and time-consuming. However, the actual assays are quite cheap for both types of markers, and the costs of microsatellite analysis can be further reduced by establishing multiplexed “genotype identification sets” [51, 52]. A few recent reports have already demonstrated that microarray-based DNA profiling of herbal plant material is feasible, also in conjunction with portable microdevices [77–79]. It is safe to assume that SNP profiling will become more cost-effective by the availability of large, standardized DNA chips that allow the simultaneous analysis of hundreds of genotypes. The importance of multiplexed microsatellites and SNP profiling for medicinal plant authentication is therefore likely to increase in the near future.

## References

- 1 Ha, W.Y., Shaw, P.C., Liu, J., Yau, F.C.F., Wang, J. Authentication of *Panax ginseng* and *Panax quinquefolius* using amplified fragment length polymorphism (AFLP) and directed amplification with micro-satellite region DNA (DAMD). *J. Agric. Food Chem.* **2002**, *50*, 1871–1875. [Application of two types of DNA markers, AFLP and DAMD, in an important crop.]
- 2 Baum, B.R., Mechanda, S., Livesey, J.F., Binns, S.E., Arnason, J.T. Predicting quantitative phytochemical markers in single *Echinacea* plants or clones from their DNA fingerprints. *Phytochemistry* **2001**, *56*, 543–549. [Application of AFLP, and analysis of linkage between DNA markers and phytochemical contents.]
- 3 Wallner, E., Weising, K., Rompf, R., Kahl, G., Kopp, B. Oligonucleotide fingerprinting and RAPD analysis of *Achillea* species: characterization and long-term monitoring of micropropagated clones. *Plant Cell Rep.* **1996**, *15*, 647–652.
- 4 Shaw, P.C., Ngan, F.N., But, P.P.H., Wang, J. Authentication of Chinese medicinal materials by DNA technology. *J. Food Drug Anal.* **1997**, *5*, 273–283. [Informative review paper about DNA-based identification of traditional Chinese medicinal plants.]
- 5 Henry, R.J. (Ed.), *Plant Genotyping: The DNA Fingerprinting of Plants*. CAB International Publishing, Wallingford, **2001**. [Multi-authored book covering various DNA marker techniques (including SNPs) and their applications in plants.]
- 6 Avise, J.C. *Molecular Markers, Natural History, and Evolution*. Second edition. Sinauer Associates, Sunderland, **2004**. [Survey of theoretical and practical aspects of DNA marker techniques.]
- 7 Weising, K., Nybom, H., Wolff, K., Kahl, G. *DNA Fingerprinting in Plants: Principles, Methods and Applications*. CRC Press, **2005**. [In-depth descriptions of DNA-based marker methodology, data analyses and applications.]
- 8 Lin, J.-Z., Ritland, K. Flower petals allow simpler and better isolation of DNA for plant RAPD analyses. *Plant Mol. Biol. Rep.* **1995**, *13*, 210–213.
- 9 Simel, E.J., Saidak, L.R., Tuskan, G.A. Method for extracting genomic DNA from non-germinated gymnosperm and angiosperm pollen. *BioTechniques* **1997**, *22*, 390–394.
- 10 Kang, H.W., Cho, Y.G., Yoon, U.H., Eun, M.Y. A rapid DNA extraction method for RFLP and PCR analysis from a single dry seed. *Plant Mol. Biol. Rep.* **1998**, *16*, 90(1–9).
- 11 Kumar, A., Pushpangadan, P., Mehrotra, S. Extraction of high-molecular-weight DNA from dry root tissue of *Berberis lycium* suitable for RAPD. *Plant Mol. Biol. Rep.* **2003**, *21*, 309a–309d.
- 12 Syamkumar, S., Lowarence, B., Sasikumar, B. Isolation and amplification of DNA from rhizomes of turmeric and ginger. *Plant Mol. Biol. Rep.* **2003**, *21*, 171a–171e.
- 13 Wulff, E.G., Torres, S., Vigil, E.G. Protocol for DNA extraction from potato tubers. *Plant Mol. Biol. Rep.* **2002**, *20*, 187a–187e.
- 14 Deguilloux, M.F., Pemonge, M.H., Petit, R.J. Novel perspectives in wood certification and forensics: dry wood as a source of DNA. *Proc. R. Soc. Lond. B* **2002**, *269*, 1039–1046.
- 15 Reynolds, M.M., Williams, C.G. Extracting DNA from submerged pine wood. *Genome* **2004**, *47*, 994–997.
- 16 Rogstad, S.H. Saturated NaCl-CTAB solution as a means of field preservation of leaves for DNA analyses. *Taxon* **1992**, *41*, 701–708.
- 17 Chase, M.W., Hills, H.H. Silica gel: an ideal material for field preservation of leaf samples for DNA studies. *Taxon* **1991**, *40*, 215–220.
- 18 Khanuja, S.P.S., Shasany, A.K., Darokar, M.P., Kumar, S. Rapid isolation of DNA from dry and fresh samples of plants producing large amounts of secondary metabolites and essential oils. *Plant Mol. Biol. Rep.* **1999**, *17*, 74(1-7).
- 19 Savolainen, V., Cuénoud, P., Spichiger, R., Martinez, M.D., Crèvecoeur, M., Manen, J.-F. The use of herbarium specimens in DNA phylogenetics:

- evaluation and improvement. *Plant Syst. Evol.* **1995**, *197*, 87–98.
- 20 Biss, P., Freeland, J., Silvertown, J., McConway, K., Lutman, P. Successful amplification of rice chloroplast microsatellites from century-old grass samples from the park grass experiment. *Plant Mol. Biol. Rep.* **2003**, *21*, 249–257.
  - 21 Singh, B.M., Ahuja, P.S. Isolation and PCR amplification of genomic DNA from market samples of dry tea. *Plant Mol. Biol. Rep.* **1999**, *17*, 171–178.
  - 22 Murray, M.G., Thompson, W.F. Rapid isolation of high molecular weight plant DNA. *Nucleic Acids Res.* **1980**, *8*, 4321–4325.
  - 23 Pirttilä, A.M., Hirsikorpi, M., Kämäräinen, T., Jaakola, L., Hohtola, A. DNA isolation methods for medicinal and aromatic plants. *Plant Mol. Biol. Rep.* **2001**, *19*, 273a–273f.
  - 24 Sangwan, N.S., Sangwan, R.S., Kumar, S. Isolation of genomic DNA from the antimalarial plant *Artemisia annua*. *Plant Mol. Biol. Rep.* **1998**, *16*, 365(18).
  - 25 Sangwan, R.S., Yadav, U., Sangwan, N.S. Isolation of genomic DNA from defatted oil seed residue of opium poppy (*Papaver somniferum*). *Plant Mol. Biol. Rep.* **2000**, *18*, 265–270.
  - 26 Mullis, K.B., Ferré, F., Gibbs, R.A. (Eds.), *The Polymerase Chain Reaction*. Birkhäuser, Basel, **1994**.
  - 27 Baldwin, B.G., Sanderson, M.J., Porter, J.M., Wojciechowski, M.F., Campbell, C.S., Donoghue, M.J. The ITS region of nuclear ribosomal DNA: a valuable source of evidence on angiosperm phylogeny. *Ann. Missouri Bot. Gard.* **1995**, *82*, 247–277.
  - 28 Fushimi, H., Komatsu, K., Namba, T., Isobe, M. Genetic heterogeneity of ribosomal RNA gene and *matK* gene in *Panax notoginseng*. *Planta Med.* **2000**, *66*, 659–661.
  - 29 Lau, D.T.W., Shaw, P.C., Wang, J., But, P.P.H. Authentication of medicinal *Dendrobium* species by the internal transcribed spacer of ribosomal DNA. *Planta Med.* **2001**, *67*, 456–460. [Good example of the application of DNA sequencing for species authentication.]
  - 30 Cui, X.M., Lo, C.K., Yip, K.L., Dong, T.T.X., Tsim, K.W.K. Authentication of *Panax notoginseng* by 5S-rRNA spacer domain and random amplified polymorphic DNA (RAPD) analysis. *Planta Med.* **2003**, *69*, 584–586.
  - 31 Crockett, S.L., Douglas, A.W., Scheffler, B.E., Khan, I.A. Genetic profiling of *Hypericum* (St. John's Wort) species by nuclear ribosomal ITS sequence analysis. *Planta Med.* **2004**, *70*, 929–935. [Interesting example of the application of DNA sequencing in a medicinal plant.]
  - 32 Weising, K., Kahl, G. Hybridization-based microsatellite fingerprinting of plants and fungi. In: Caetano-Anollés, G., Gresshoff, P.M. (Eds.), *DNA Markers: Protocols, Applications, and Overviews*. Wiley-VCH, New York, **1998**, pp. 27–54.
  - 33 Welsh, J., McClelland, M. Fingerprinting genomes using PCR with arbitrary primers. *Nucleic Acids Res.* **1990**, *18*, 7213–7218.
  - 34 Williams, J.G.K., Kubelik, A.R., Livak, K.J., Rafalski, J.A., Tingey, S.V. DNA polymorphisms amplified by arbitrary primers are useful as genetic markers. *Nucleic Acids Res.* **1990**, *18*, 6231–6235.
  - 35 Caetano-Anollés, G., Bassam, B.J., Gresshoff, P.M. High resolution DNA amplification fingerprinting using very short arbitrary oligonucleotide primers. *Bio/Technology* **1991**, *9*, 553–557.
  - 36 Penner, G.A., Bush, A., Wise, R., Kim, W., Domier, L., Kasha, K., Laroche, A., Scoles, G., Molnar, S.J., Fedak, G. Reproducibility of random amplified polymorphic DNA (RAPD) analysis among laboratories. *PCR Methods and Applications* **1993**, *2*, 341–345.
  - 37 Sangwan, R.S., Sangwan, N.S., Jain, D.C., Kumar, S., Ranade, S.A. RAPD profile based genetic characterization of chemotypic variants of *Artemisia annua* L. *Biochem. Molec. Biol. Int.* **1999**, *47*, 935–944. [Application of RAPD, and analysis of the relationship between markers and the chemical contents of the plant material.]
  - 38 Nieri, P., Adinolfi, B., Morelli, I., Breschi, M.C., Simoni, G., Martinotti, E. Genetic characterization of the three medicinal *Echinacea* species using RAPD analysis. *Planta Med.* **2003**, *69*, 685–686.
  - 39 Shoyama, Y., Zhu, X.X., Nakai, R., Shiraiishi, S., Kohda, H. Micropropaga-



- tion of *Panax notoginseng* by somatic embryogenesis and RAPD analysis of regenerated plantlets. *Plant Cell Rep.* **1997**, *16*, 450–453.
- 40 Shim, Y.-H., Choi, J.-H., Park, C.-D., Lim, C.-J., Cho, J.-H., Kim, H.-J. Molecular differentiation of *Panax* species by RAPD analysis. *Arch. Pharm. Res.* **2003**, *26*, 601–605.
- 41 Zietkiewicz, E., Rafalski, A., Labuda, D. Genome fingerprinting by simple sequence repeat (SSR)-anchored polymerase chain reaction amplification. *Genomics* **1994**, *20*, 176–183.
- 42 Gupta, M., Chyi, Y.-S., Romero-Severson, J., Owen, J.L. Amplification of DNA markers from evolutionary diverse genomes using single primers of simple-sequence repeats. *Theoret. Appl. Genet.* **1994**, *89*, 998–1006.
- 43 Meyer, W., Mitchell, T.G., Freedman, E.Z., Vilgalys, R. Hybridization probes for conventional DNA fingerprinting used as single primers in the polymerase chain reaction to distinguish strains of *Cryptococcus neoformans*. *J. Clin. Microbiol.* **1993**, *31*, 2274–2280.
- 44 Weising, K., Atkinson, R.G., Gardner, R.C. Genomic fingerprinting by microsatellite-primed PCR: a critical evaluation. *PCR Methods and Applications* **1995**, *4*, 249–255.
- 45 Goldstein, D.B., Schlötterer, C. (Eds.), *Microsatellites: Evolution and Applications*. Oxford University Press, Oxford, UK, **1999**.
- 46 Fisher, P., Gardner, R.C., Richardson, T.E. Single locus microsatellites isolated using 5' anchored PCR. *Nucleic Acids Res.* **1996**, *24*, 4369–4371.
- 47 Feyissa, T., Nybom, H., Bartish, I., Welander, M. Analysis of genetic diversity in the endangered tropical tree species *Hagenia abyssinica* using ISSR markers. *Genet. Res. Crop Evol.* (in press).
- 48 Zabeau, M., Vos, P. Selective restriction fragment amplification: a general method for DNA fingerprinting. *European Patent Application EP 0534858*, **1993**.
- 49 Vos, P., Hogers, R., Bleeker, M., Reijans, M., Van de Lee, T., Hornes, M., Frijters, A., Pot, J., Peleman, J., Kuiper, M., Zabeau, M. AFLP: a new technique for DNA fingerprinting. *Nucleic Acids Res.* **1995**, *23*, 4407–4414.
- 50 Akkaya, M.S., Bhagwat, A.A., Cregan, P.B. Length polymorphisms of simple sequence repeat DNA in soybean. *Genetics* **1992**, *132*, 1131–1139.
- 51 Macaulay, M., Ramsay, L., Powell, W., Waugh, R. A representative, highly informative “genotyping set” of barley SSRs. *Theoret. Appl. Genet.* **2001**, *102*, 801–809.
- 52 Tang, S., Kishore, V.K., Knapp, S.J. PCR-multiplexes for a genome-wide framework of simple sequence repeat marker loci in cultivated sunflower. *Theoret. Appl. Genet.* **2003**, *107*, 6–19.
- 53 Zane, L., Bargelloni, L., Patarnello, T. Strategies for microsatellite isolation: a review. *Mol. Ecol.* **2002**, *11*, 1–16.
- 54 Squirrell, J., Hollingsworth, P.M., Woodhead, M., Russell, J., Lowe, A.J., Gibby, M., Powell, W. How much effort is required to isolate nuclear microsatellites from plants? *Mol. Ecol.* **2003**, *12*, 1339–1348.
- 55 Holton, T.A., Christopher, J.T., McClure, L., Harker, N., Henry, R.J. Identification and mapping of polymorphic SSR markers from expressed gene sequences of barley and wheat. *Mol. Breed.* **2002**, *9*, 63–71.
- 56 Yu, J.-K., Dake, T.M., Singh, S., Benscher, D., Li, W., Gill, B., Sorrells, M.E. Development and mapping of EST-derived simple sequence repeat markers for hexaploid wheat. *Genome* **2004**, *47*, 805–818.
- 57 Gilmore, S., Peakall, R., Robertson, J. Short tandem repeat (STR) DNA markers are hypervariable and informative in *Cannabis sativa*: implications for forensic investigations. *Forens. Sci. Int.* **2003**, *131*, 65–74. [Application of microsatellite DNA markers, and an analysis of the relationship between these markers and chemical contents in the plant material.]
- 58 Shokeen, B., Sethy, N.K., Choudhary, S., Bhatia, S. Development of STMS markers from the medicinal plant Madagascar periwinkle [*Catharanthus roseus* (L.) G. Don]. *Mol. Ecol. Notes* **2005**, *5*, 818–820.



- 59 Demesure, B., Sozi, N., Petit, R.J. A set of universal primers for amplification of polymorphic non-coding regions of mitochondrial and chloroplast DNA in plants. *Mol. Ecol.* **1995**, *4*, 129–131.
- 60 Dumolin-Lapègue, S., Pemonge, M.-H., Petit, R.J. An enlarged set of consensus primers for the study of organelle DNA in plants. *Mol. Ecol.* **1997**, *6*, 393–397.
- 61 Duminił, J., Pemonge, M.-H., Petit, R.J. A set of 35 consensus primer pairs amplifying genes and introns of plant mitochondrial DNA. *Mol. Ecol. Notes* **2002**, *2*, 428–430.
- 62 Konieczny, A., Ausubel, F.M. A procedure for mapping *Arabidopsis* mutations using co-dominant ecotype-specific PCR-based markers. *Plant J.* **1993**, *4*, 403–410.
- 63 Witsenboer, H., Vogel, J., Michelmore, R.W. Identification, genetic localization, and allelic diversity of selectively amplified microsatellite polymorphic loci in lettuce and wild relatives (*Lactuca* spp.). *Genome* **1997**, *40*, 923–936.
- 64 Waugh, R., McLean, K., Flavell, A.J., Pearce, S.R., Kumar, A., Thomas, B.B.T., Powell, W. Genetic distribution of *Bare-1*-like retrotransposable elements in the barley genome revealed by sequence-specific amplification polymorphisms (S-SAP). *Mol. Gen. Genet.* **1997**, *253*, 687–694.
- 65 Gupta, P.K., Roy, J.K., Prasad, M. Single nucleotide polymorphisms: a new paradigm for molecular marker technology and DNA polymorphism detection with emphasis on their use in plants. *Curr. Sci.* **2001**, *80*, 524–535.
- 66 Brumfield, R.T., Beerli, P., Nickerson, D.A., Edwards, S.V. The utility of single nucleotide polymorphisms in inferences of population history. *Trends Ecol. Evol.* **2003**, *18*, 249–256.
- 67 Bhatramaki, D., Rafalski, A. Discovery and application of single nucleotide polymorphism markers in plants. In: Henry, R.J. (Ed.), *Plant Genotyping: The DNA Fingerprinting of Plants*. CABI Publishing, Wallingford, **2001**, pp. 179–192.
- 68 Somers, D.J., Kirkpatrick, R., Moniwa, M., Walsh, A. Mining single-nucleotide polymorphisms from hexaploid wheat ESTs. *Genome* **2003**, *49*, 431–437.
- 69 Sunnucks, P., Wilson, A.C.C., Beheregaray, L.B., Zenger, K., French, J., Taylor, A.C. SSCP is not so difficult: the application and utility of single-stranded conformation polymorphism in evolutionary biology and molecular ecology. *Mol. Ecol.* **2000**, *9*, 1699–1710.
- 70 Bensch, S., Akesson, S., Irwin, D.E. The use of AFLPs to find an informative SNP: genetic differences across a migratory divide in willow warblers. *Mol. Ecol.* **2002**, *11*, 2359–2366.
- 71 Kwok, P.-Y. Methods for genotyping single nucleotide polymorphisms. *Annu. Rev. Genomics Hum. Genet.* **2001**, *2*, 235–258.
- 72 Syvanen, A.C. Genotyping single nucleotide polymorphisms. *Nature Rev. Genet.* **2001**, *2*, 930–942.
- 73 Schena, M. *Microarray Analysis*. Wiley-Liss, Inc., USA, **2003**.
- 74 Mantripragada, K.K., Buckley, P.G., de Stahl, T.D., Dumanski, J.P. Genomic microarrays in the spotlight. *Trends Genet.* **2004**, *20*, 87–94.
- 75 Schmid, K.J., Sørensen, T.R., Stracke, R., Törjek, O., Altmann, T., Mitchell-Olds, T., Weissshaar, B. Large-scale identification and analysis of genome wide single-nucleotide polymorphisms for mapping in *Arabidopsis thaliana*. *Genome Res.* **2003**, *13*, 1250–1257.
- 76 Nasu, S., Suzuki, J., Ohta, R., Hasegawa, K., Yui, R., Kitazawa, N., Monna, L., Minobe, Y. Search for and analysis of single nucleotide polymorphisms (SNPs) in rice (*Oryza sativa*, *Oryza rufipogon*) and establishment of SNP markers. *DNA Res.* **2002**, *9*, 163–171.
- 77 Carles, M., Lee, T., Moganti, S., Lenigk, R., Tsim, K.W.K., Ip, N.Y., Hsing, I.-M., Sucher, N.J. Chips and Qi: microcomponent-based analysis in traditional Chinese medicine. *Fresenius J. Anal. Chem.* **2001**, *371*, 190–194. [One of the first studies demonstrating the applicability of DNA microarray technology for DNA sequence-based identification of medicinal plants.]
- 78 Carles, M., Cheung, M.K.L., Moganti, S., Dong, T.T.X., Tsim, K.W., Ip, N.Y.,

- Sucher, N.J. A DNA microarray for the authentication of toxic traditional Chinese medicinal plants. *Planta Med.* **2005**, *71*, 580–584. [Application of silicon chip-based DNA microarray analysis.]
- 79 Zhang, Y.B., Wang, J., Wang, Z.T., But, P.P.H., Shaw, P.C. DNA microarray for identification of the herb of *Dendrobium* species from Chinese medicinal formulations. *Planta Med.* **2003**, *69*, 1172–1174.
- 80 Lee, T.M.H., Hsing, I.-M. Sequence-specific electrochemical detection of asymmetric PCR amplicons of traditional Chinese medicinal plant DNA. *Anal. Chem.* **2002**, *74*, 5057–5062. [Development of a hand-held device for SNP-based discrimination of plant material.]
- 81 Ngan, F., Shaw, P., But, P., Wang, J. Molecular authentication of *Panax* species. *Phytochemistry* **1999**, *50*, 787–791. [Application of 5.8 S rDNA sequencing for root discrimination.]
- 82 Artyukova, E.V., Kozyrenko, M.M., Koren, O.G., Muzarok, T.I., Reunova, G.D., Zhuravlev, Y.N. RAPD and allozyme analysis of genetic diversity in *Panax ginseng* C.A. Meyer and *P. quinquefolius* L. *Russian J. Genet.* **2004**, *40*, 178–185.
- 83 Tochika-Komatsu, Y., Asaka, I., Ii, I. A random amplified polymorphic DNA (RAPD) primer to assist the identification of a selected strain, Aizu K-111 of *Panax ginseng* and the sequence amplified. *Biol. Pharmaceut. Bull.* **2001**, *24*, 1210–1213.
- 84 Debener, T., Janakiram, T., Mattiesch, L. Sports and seedlings of rose varieties analysed with molecular markers. *Plant Breed.* **2000**, *119*, 71–74.
- 85 Franks, T., Botta, R., Thomas, M.R. Chimerism in grapevines: implications for cultivar identity, ancestry and genetic improvement. *Theoret. Appl. Genet.* **2002**, *104*, 192–199.
- 86 Ipek, M., Ipek, A., Simon, P.W. Comparison of AFLPs, RAPDs, and isozymes for diversity assessment of garlic and detection of putative duplicates in germplasm collections. *J. Am. Soc. Hort. Sci.* **2003**, *128*, 246–252. [Analysis of genetic identity determined with different kinds of molecular markers.]
- 87 Diwan, B., Cregan, P.B. Automated sizing of fluorescent-labeled simple sequence repeat (SSR) markers to assay genetic variation in soybean. *Theoret. Appl. Genet.* **1997**, *95*, 723–733.
- 88 Excoffier, L., Smouse, P.E., Quattro, J.M. Analysis of molecular variance inferred from metric distances among DNA haplotypes: applications to human mitochondrial DNA restriction data. *Genetics* **1992**, *131*, 479–491.
- 89 Echeverrgeray, S., Agostini, G., Atti-Sefini, L., Paroul, N., Pauletti, G.F., dos Santos, A.C.A. Correlation between the chemical and genetic relationships among commercial thyme cultivars. *J. Agric. Food Chem.* **2001**, *49*, 4220–4223. [Application of RAPD, and analysis of the relationship between DNA markers and oil content in the plant material.]
- 90 Haluskova, J., Kosuth, J. RAPD analysis of somaclonal and natural DNA variation in *Hypericum perforatum* L. *Acta Biol. Cracov Ser. Botanica.* **2003**, *45*, 101–104.
- 91 Kuddus, R.H., Kuddus, N.N., Dvorchik, I. DNA polymorphism in the living fossil *Ginkgo biloba* from the eastern United States. *Genome* **2002**, *45*, 8–12. [Application of RAPD, as well as the utilisation of a gel-excised DNA band for probing.]
- 92 Nybom, H. Comparison of different nuclear DNA markers for estimating intraspecific genetic diversity in plants. *Mol. Ecol.* **2004**, *13*, 1143–1155. [Compilation and analysis of population genetic studies carried out using various DNA marker methods, comparison of dominantly and codominantly inherited marker methods.]
- 93 Grassi, F., Imazio, S., Gomasasca, S., Citterio, S., Aina, R., Sgorbati, S., Sala, F., Patrignani, G., Labra, M. Population structure and genetic variation within *Valeriana wallrothii* Kreyer in relation to different ecological locations. *Plant Sci.* **2004**, *166*, 1437–1441. [Application of AFLP and chloroplast DNA microsatellite markers.]
- 94 Nebauer, S.G., del Castillo-Agudo, L., Segura, J. RAPD variation within and among natural populations of out-

- crossing willow-leaved foxglove (*Digitalis obscura* L.). *Theoret. Appl. Genet.* **1999**, *98*, 985–994.
- 95 Muluvi, G.M., Sprent, J.I., Soranzo, N., Provan, J., Odee, D., Folkard, G., McNicol, J.W., Powell, W. Amplified fragment length polymorphism (AFLP) analysis of genetic variation in *Moringa oleifera* Lam. *Mol. Ecol.* **1999**, *8*, 463–470.
- 96 Semagn, K., Bjørnstad, A., Stedje, B. Genetic diversity and differentiation in Ethiopian populations of *Phytolacca dodecandra* as revealed by AFLP and RAPD analyses. *Genet. Crop Res. Evol.* **2003**, *50*, 649–661.
- 97 Singh, A., Chaudhary, A., Srivastava, P.S., Lakshmikumaran, M. Comparison of AFLP and SAMPL markers for assessment of intra-population genetic variation in *Azadirachta indica* A. Juss. *Plant Sci.* **2002**, *162*, 17–25.
- 98 Rossetto, M., Slade, R.W., Baverstock, P.R., Henry, R.J., Lee, L.S. Microsatellite variation and assessment of genetic structure in tea tree (*Melaleuca alternifolia* – Myrtaceae). *Mol. Ecol.* **1999**, *8*, 633–643.
- 99 Arnholdt-Schmitt, B. RAPD analysis: a method to investigate aspects of the reproductive biology of *Hypericum perforatum* L. *Theoret. Appl. Genet.* **2000**, *100*, 906–911.
- 100 Mayo, G.M., Langridge, P. Modes of reproduction in Australian populations of *Hypericum perforatum* L. (St. John's wort) revealed by DNA fingerprinting and cytological methods. *Genome* **2003**, *46*, 573–579.
- 101 Hu, J., Zhu, J., Xu, H.M. Methods of constructing core collections by stepwise clustering with three sampling strategies based on genotypic values of crops. *Theoret. Appl. Genet.* **2000**, *101*, 264–268.
- 102 Garkava-Gustavsson, L., Persson, H.A., Nybom, H., Rumpunen, K., Gustavsson, B.A., Bartish, I.V. RAPD-based analysis of genetic diversity and selection of lingonberry (*Vaccinium vitis-idaea* L.) material for *ex situ* conservation. *Genet. Res. Crop Evol.* **2005**, *52*, 723–735.
- 103 Zhang, D.P., Huaman, Z., Rodriguez, F., Rossel, G., Ghislain, M. Identifying duplicates in sweet potato (*Ipomoea batatas* (L.) Lam) cultivars using RAPD. *Acta Hort.* **2001**, *546*, 535–541.
- 104 Dawson, I.K., Powell, W. Genetic variation in the Afromontane tree *Prunus africana*, an endangered medicinal species. *Mol. Ecol.* **1999**, *8*, 151–156.
- 105 Zhou, S.L., Xiong, G.M., Li, Z.Y., Wen, J. Loss of genetic diversity of domesticated *Panax notoginseng* F H Chen as evidenced by ITS sequence and AFLP polymorphism: a comparative study with *P. stipuleatus* H T Tsai et K M Feng. *J. Integrat. Plant Biol.* **2005**, *47*, 107–115.
- 106 Pilepic, K.H. Analysis of chloroplast DNA variability among some *Hypericum* species in Croatia. *Periodicum Biologorum* **2002**, *104*, 457–462.
- 107 Bartish, I.V., Jeppsson, N., Swenson, U., Nybom, H. Phylogeny of *Hippophae* (Elaeagnaceae) inferred from parsimony analysis of chloroplast DNA and morphology. *Syst. Bot.* **2002**, *27*, 41–54.
- 108 Yoo, K.O., Malla, K.J., Wen, J. Chloroplast DNA variation of *Panax* (Araliaceae) in Nepal and its taxonomic implications. *Brittonia* **2001**, *53*, 447–453.
- 109 Després, L., Gielly, L., Redoutet, B., Taberlet, P. Using AFLP to resolve phylogenetic relationships in a morphologically diversified plant species complex when nuclear and chloroplast sequences fail to reveal variability. *Mol. Phylogenet. Evol.* **2003**, *27*, 85–196.
- 110 Urbatsch, L.E., Baldwin, B.G., Donoghue, M.J. Phylogeny of the coneflowers and relatives (Heliantheae: Asteraceae) based on nuclear rDNA internal transcribed spacer (ITS) sequences and chloroplast DNA restriction site data. *Syst. Bot.* **2000**, *25*, 539–565.
- 111 Kim, D.-H., Heber, D., Still, D.W. Genetic diversity of *Echinacea* species based upon amplified fragment length polymorphism markers. *Genome* **2004**, *47*, 102–111.
- 112 Bussell, J.D., Waycott, M., Chappill, J.A. Arbitrarily amplified DNA markers as characters for phylogenetic inference. *Perspect. Plant Ecol. Evol. Syst.* **2005**, *7*, 3–26.
- 113 Koopman, W.J.M. Phylogenetic signal in AFLP data sets. *Syst. Biol.* **2005**, *54*, 197–217.

- 114 Mechanda, S.M., Baum, B.R., Johnson, D.A., Arnason, J.T. Sequence assessment of comigrating AFLP bands in *Echinacea* – implications for comparative biological studies. *Genome* **2004**, *47*, 15–25.
- 115 Persson, H.A., Nybom, H. Genetic sex determination and RAPD marker segregation in the dioecious species sea buckthorn (*Hippophae rhamnoides*). *Hereditas* **1998**, *129*, 45–51.
- 116 Mandolino, G., Carboni, A., Bagatta, M., Moliterni, V.M.C., Ranalli, P. Occurrence and frequency of putatively Y chromosome linked DNA markers of *Cannabis sativa* L. *Euphytica* **2002**, *126*, 211–218.
- 117 Meksem, K., Kahl, G. *The Handbook of Genome Mapping*. Wiley-VCH, USA, **2004**.
- 118 Göcmen, B., Jermstad, K.D., Neale, D.B., Kaya, Z. Development of random amplified polymorphic DNA markers for genetic mapping of Pacific yew (*Taxus brevifolia*). *Can. J. Forest Res.* **1996**, *26*, 497–503.
- 119 Zewdie, Y., Havey, M.J., Prince, J.P., Jenderek, M.M. The first genetic linkages among expressed regions in the garlic genome. *J. Am. Soc. Hort. Sci.* **2005**, *130*, 569–574. [Genetic mapping with different types of DNA markers and identification of a locus for male fertility.]
- 120 Ipek, M., Ipek, A., Almquist, S.G., Simon, P.W. Demonstration of linkage and development of the first low-density genetic map of garlic, based on AFLP markers. *Theoret. Appl. Genet.* **2005**, *110*, 228–236. [Genetic mapping with both DNA markers (AFLP) and genes for chemical contents.]
- 121 Hansen, M., Kraft, T., Christansson, M., Nilsson, N.O. Evaluation of AFLP in *Beta*. *Theoret. Appl. Genet.* **1999**, *98*, 845–852.
- 122 Paran, I., Michelmore, R.W. Development of reliable PCR-based markers linked to downy mildew resistance genes in lettuce. *Theoret. Appl. Genet.* **1993**, *85*, 985–993.
- 123 Xu, M., Huaracha, E., Korban, S.S. Development of sequence-characterized amplified regions (SCARs) from amplified fragment length polymorphism (AFLP) markers tightly linked to the *Vf* gene in apple. *Genome* **2001**, *44*, 63–70.

## 6

# Bioprospecting: The Search for Bioactive Lead Structures from Nature

*Michael Wink*

### Abstract

As a consequence of the Human Genome Project and further research in functional genomics and proteomics, many genes have been identified that are connected with health disorders and illnesses. Several of the products of these genes (i.e., proteins) have become new targets for the development of novel therapeutics. As a consequence, the demand for bioactive compounds from Nature or synthesis is increasing. Plants, bacteria, fungi and sessile marine organisms produce a wide variety of secondary metabolites that have been selected during evolution as defense substances against herbivores, predators or infective microbes and viruses, or as signal compounds. These secondary compounds have attracted great interest for drug development as they may represent lead structures for new or already existing drug targets. In this chapter, the biological and evolutionary background of secondary metabolites (mainly from plants) is discussed, and examples of known interactions of secondary metabolites with interesting molecular targets are described.

### 6.1

#### Introduction

Biomedicine and molecular biotechnology have made much progress during the past 10 years, with the sequencing of the human genome being one of the major achievements. Moreover, with the aid of functional genomics, proteomics and bioinformatics, the next step will be the identification of the genes, proteins, and their respective functions. Because of alternative splicing the number of proteins by far exceeds the number of genes (25 000) in humans; thus, the task to determine all protein functions and the potential cross-talk between individual proteins will be vast. Nonetheless, it is important that these data are understood in order to treat health disorders and diseases. As a consequence of these ongoing studies, a number of new targets have already been defined that are being used to develop new drugs, and more targets will undoubtedly emerge in the near future (Fig. 6.1). Two

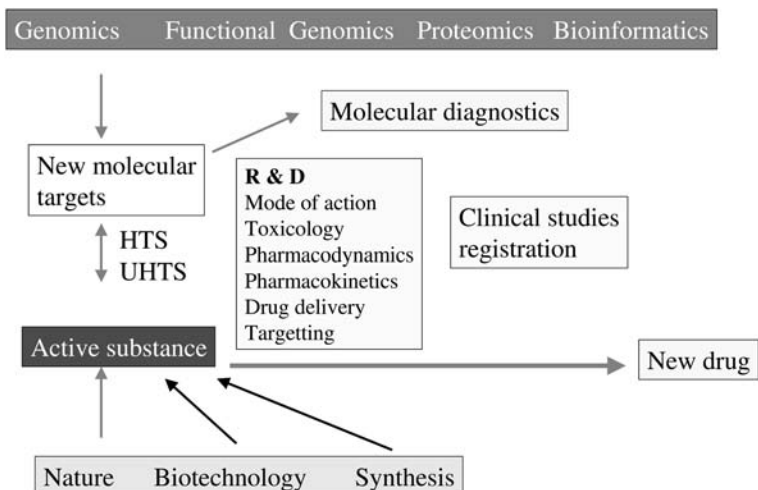


Fig. 6.1 The importance of bioactive compounds from Nature in drug development.

other technological advances that have changed the area of drug development during the past 20 years are those of automated high-throughput screening (HTS) and ultra-high-throughput screening (UHTS). By using HTS and UHTS, it is possible to screen up to one million compounds at one target, within one week.

This technology allows the screening of large substance libraries which consist of synthetic compounds, made by traditional or combinatorial synthesis, in addition to substance libraries from biotechnology and Nature. Nature produces an extreme diversity of bioactive compounds that, to date, have been exploited only to a minor degree. However, many of our medicinal drugs still derive from Nature either directly (e.g., many antibiotics, or the anticancer drugs paclitaxel, vinblastine, camptothecin or podophyllotoxin) or indirectly, in that they had served as lead compounds for the development of synthetic compounds with improved qualities. The search for new compounds from Nature – often referred to as “panning for biological gold” – is an active research field. Moreover, bioprospecting will become increasingly important in the future as large substance libraries with enriched drug candidates are required for screening at new molecular targets presently under development. Many natural products that have been shaped and selected during evolution provide a rich source of powerful drugs and lead structures, and these will be discussed in this chapter (Swain, 1977; Wink, 1988, 1993; Rosenthal and Berenbaum, 1991/1992; Harborne, 1993; Roberts and Wink, 1998; Seigler, 1998).

One typical feature of plants, fungi, sessile animals (especially from marine environments) and of bacteria is the production and accumulation of secondary metabolites that, in most cases, have a molecular weight of less than 1000 Dalton (Da). To date, more than 50 000 secondary metabolite structures have been determined using NMR, mass spectrometry (MS) and X-ray analysis, though only a small proportion of relevant organisms have been studied in some depth so far. Therefore, it is very likely that the actual number of secondary metabolites that exists in Nature is far in excess of 100 000. It is possible to distinguish between nitrogen (N)-

containing and N-free secondary metabolites; an overview of known classes and numbers of secondary metabolite structures is provided in Table 6.1, while the occurrences of secondary metabolites in the main groups of producers are detailed in Table 6.2. Although some groups of secondary metabolites are often defined by their bioactivities (e.g., antibiotics), they may also be grouped according to their

**Table 6.1** Structural types of secondary metabolites and known structures.

<i>Class</i>	<i>No. of structures</i>
<i>With nitrogen</i>	
Alkaloids	21 000
Non-protein amino acids (NPAA)	700
Amines	100
Cyanogenic glycosides	60
Glucosinolates	100
Alkamides	150
Lectins, peptides	800
<i>Without nitrogen</i>	
Monoterpenes (incl. iridoids)	2500
Sesquiterpenes	5 000
Diterpenes	2 500
Triterpenes, steroids, saponins	5 000
Tetraterpenes	500
Phenylpropanoids, coumarins, lignans	2 000
Flavonoids, tannins	4 000
Polyacetylenes, fatty acids, waxes	1 500
Polyketides (anthraquinones)	750
Carbohydrates	200

**Table 6.2** Occurrence of secondary metabolites in bacteria, plants, fungi, and animals.

<i>Producer</i>	<i>Type of secondary metabolite</i>
Blue-green algae (Cyanobacteria)	Polyketides (aplysiatoxin, brevetoxin B, dinophysistoxin-1), alkaloids (lyngbyatoxin, anatoxin-a)
Bacteria	“Antibiotics”: polyketides, alkaloids, terpenoids, phenylpropanoids, peptides
Algae	Polyphenols, terpenoids, polysaccharides
Dinoflagellates (Dinophyceae)	Paralytic shellfish poisoning; alkaloids (saxitoxin, gonyautoxin); ciguatoxin
Lichen	Anthraquinones; polyphenols, phenylpropanoids
Plants (angiosperms, gymnosperms)	Alkaloids, amines, glucosinolates, cyanogenic glycosides, cyanolipids, glucosinolates, non-protein amino acids, terpenoids, saponins, phenylpropanoids, tannins, lignans, anthraquinones, fatty acids, polyines, phloroglucinols, alkylphenols, lectins

Table 6.2 Continued

<i>Producer</i>	<i>Type of secondary metabolite</i>
Fungi (Basidiomycetes)	Organic acids, alkaloids and peptides (hydrazine derivatives, amatoxines, bufotonin, ibotenic acid, muscarine, phallotoxins, psilocine, psilocybin, virotoxin), non-protein amino acids, cyanogenic glycosides, phenolics, sesquiterpenes, triterpenes
Molds (Deuteromycetes)	Mycotoxins (aflatoxins, phenolics, furanocoumarins, citrinin, citreoviridin, cytochalasin, <i>Penicillium</i> toxins, trichothecens, anthraquinones, ergot alkaloids, <i>Fusarium</i> toxins, <i>Aspergillus</i> toxins, ochratoxins, patulin, penitrem A, rugosin, rubratoxins, zearalenone)
<i>Animals</i>	
Sponges (Porifera)	Terpenoids, sesquiterpenes, diterpenes, steroids, alkaloids, halogenated secondary metabolites, histamine derivatives
Corals, jelly fish (Cnidaria)	Toxic polypeptides in nematocysts (cytolysines; hemolysines; neurotoxins; physalioxin; esterase, hyaluronidase, proteases)
Sea anemones (Anthozoa)	Toxic polypeptides in nematocysts (neurotoxins)
Worms (Nermertini)	Alkaloids (anabaseine; nereistoxin)
Scorpions (Scorpiones)	Toxic polypeptides (neurotoxins: $\alpha$ -, $\beta$ -, $\gamma$ -toxin; phospholipase A, hyaluronidase)
Spiders (Araneae)	Polyamines (argiotoxin, argiopin, NSTX, ISTX), polypeptides (robustoxin, latrotoxin, sphingomyelinase D)
Scolopender (Chilopoda)	Toxic peptides, neurotransmitters (histamine, serotonin)
Insects (Insecta)	secondary metabolites acquired from host plants (alkaloids: pyrrolizidine alkaloids, quinolizidine alkaloids, aconitine, cardiac glycosides, cyanogenic glycosides, phorbol esters); quinones, terpenoids; toxic polypeptides (phospholipase A <sub>2</sub> , hyaluronidase, hemolysins, melittin, apamin, wasp kinins, neurotransmitters (histamine), pyridine and piperidine alkaloids (solenopsine), iridoids (dolichodial), sesquiterpenes, diterpenes, cantharidin)
Cone shells (Mollusca)	Toxic polypeptides, conotoxins; saxitoxin, gonyautoxin in <i>Turbo</i> and <i>Tectus</i> species
Octopus (Cephalopoda)	Toxic polypeptides (hyaluronidase; cephalotoxin, eledoisin); tetrodotoxin, neurotransmitters (serotonin, tyramine, octopamine, noradrenaline)
Starfish (Asteroidea)	Toxic polypeptides (phospholipase A <sub>2</sub> ), steroid saponins
Sea urchin (Echinoidea)	Toxic polypeptides, amines
Sea cucumber (Holothuroidea)	Steroidal saponins (holothurin A,B)
Stingray (Chondrichthyes)	Toxic polypeptides (phosphodiesterase)
Bony fish (Osteichthyes) (weever, scorpion, fire fish)	Toxic polypeptides, neurotransmitters (serotonin, acetylcholine), alkaloids (pahutoxin)



Table 6.2 Continued

<i>Producer</i>	<i>Type of secondary metabolite</i>
Puffer fish, mollusks, amphibia	Marine bacteria produce toxins, that accumulate in the food chain: tetrodotoxin, palytoxin
Toads, salamanders, frogs (Amphibia)	Alkaloids (bufonin, samandarine, tetrodotoxin, batrachotoxin, pumiliotoxin, histrionicotoxin), bufadienolides (bufotoxin)
Gila monster (Reptilia)	Toxic polypeptides (hyaluronidase, kallikrein, gilatoxin)
Snakes (Reptilia)	Toxic polypeptides (neurotoxins: neurotoxic phospholipase A <sub>2</sub> , $\alpha$ -neurotoxins, choline esterase-inhibiting proteins; enzymes: hyaluronidase, phosphatases, phospholipase A <sub>2</sub> , proteases, oxidases)

structural types (as in this chapter). Whereas primary metabolites are present in all species, secondary metabolites occur in varying mixtures that differ between species and systematic units. Secondary metabolites are not essential for primary or energy metabolism but, as discussed below, they are important for the ecological fitness and survival of the organisms that produce them (Balandrin et al., 1985; Harborne, 1993; Wink, 1988, 1999a,b; Seigler, 1998).

Secondary metabolites are produced in specific pathways that involve substrate-specific biosynthetic enzymes (Luckner, 1990; Dewick, 2002). The sites of synthesis may differ between types of compounds and between species. Some compounds can be produced by all tissues, whereas most others are produced in a tissue- or even cell-specific fashion. It is likely that the corresponding genes are regulated by specific transcription factors similar to the situation of other genes that are differentially regulated. The site of synthesis is not necessarily the site of accumulation in plants. Indeed, several compounds have been shown to be transported within a plant either via the phloem or the xylem. Whereas hydrophilic compounds (e.g., alkaloids, amino acids, glucosinolates, cyanogenic glycosides, flavonoids, tannins and other polyphenols, carbohydrates and saponins) are stored in the vacuole, lipophilic secondary metabolites (e.g., many terpenoids) are sequestered in resin ducts, laticifers or in special (usually dead) cells, such as oil cells, trichomes, or in the cuticle. Often, epidermal cells, the initial role of which is to ward off enemies, are especially rich in secondary metabolites. In animals, secondary metabolites are often stored in special glandular structures commonly present in skin tissues.

It is a typical feature of secondary metabolites that many are stored at relatively high levels in sink tissues that are often important for the survival and reproduction of a plant, such as the flowers, seeds, seedlings, or the bark of perennial plants. Several secondary metabolites are not the end products of metabolism but can be recycled in plants. For example, nitrogen-containing secondary metabolites such as alkaloids, nonprotein amino acids (NPAA) or lectins are often accumulated as toxic nitrogen-storage compounds in the seeds of legumes in which nitrogen is remobilized during germination and seedling growth (Harborne, 1993; Wink, 1988, 1999a,b; Roberts and Wink, 1998).

## 6.2

## The Function of Secondary Metabolites

Plants, fungi, sessile animals and bacteria cannot run away when attacked by herbivores or predators; neither do they have an immune system against invading bacteria, fungi, or viruses. Consequently, plants and other sessile organisms (e.g., marine animals) (see Table 6.2) have developed biologically active secondary metabolites during evolution that help them to defend themselves against predators (insects, mollusks, vertebrates), microbes, viruses, and other competing plants (Fig. 6.2). In order to be effective, secondary metabolites must be present at the correct site, time, and concentration. The biosynthesis of several secondary metabolites is constitutive, whereas in many plants it can be induced and enhanced by biological stress conditions, such as wounding or infection. This activation can be biochemical, for example through the hydrolysis of glycosides that are stored as “prodrugs” (Table 6.3) or via the activation of genes responsible for the synthesis, transport or storage of secondary metabolites. Signal transduction pathways that lead to gene activation in plants include those leading to jasmonic acid or salicylic acid that have been found to trigger defense reactions in plants (Harborne, 1993; Wink, 1988, 1999a,b).

Plants also use secondary metabolites (such as volatile essential oils and colored flavonoids or tetraterpenes) to attract insects for pollination or other animals for seed dispersion. In this case, secondary metabolites serve as *signal compounds*. Animals that store toxic secondary metabolites often advertise this property by warning colors (that are themselves secondary metabolites); this is termed *aposematism*.

In addition, some secondary metabolites concomitantly carry out physiological functions; for example alkaloids, NPAA, and peptides (lectins, protease inhibitors)

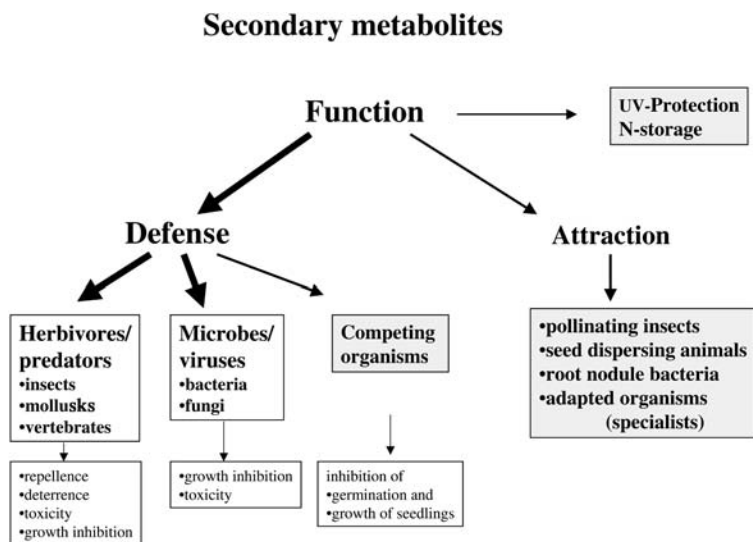


Fig. 6.2 Functions of secondary metabolites in plants.

**Table 6.3** Typical “prodrugs” present in plants that are activated by wounding or infection.

<i>Secondary metabolite of undamaged tissue</i>	<i>Active metabolite</i>
Cyanogenic glycoside	HCN
Glucosinolate	isothiocyanate
Alliin	allicin
Coumaroylglycoside	coumarin
Arbutin	quinone
Salicin, methylsalicylate	saligenin, salicylic acid
Gein	eugenol
Bi-desmosidic saponins	mono-desmosidic saponins
Cycasin	methylazoxymethanol (MAM)
Ranunculin	protoanemonine

can serve as mobile and toxic nitrogen transport and storage compounds, while phenolics (e.g., flavonoids) can function as UV-protectants (Harborne, 1993; Wink, 1988, 1999a,b). In addition to chemical defense, a number of plants and marine animals use mechanical and morphological features for protection, including thorns, spikes, glandular and stinging hairs (often filled with noxious chemicals), or they may develop a barely penetrable bark (especially woody perennials) or armor (carapace).

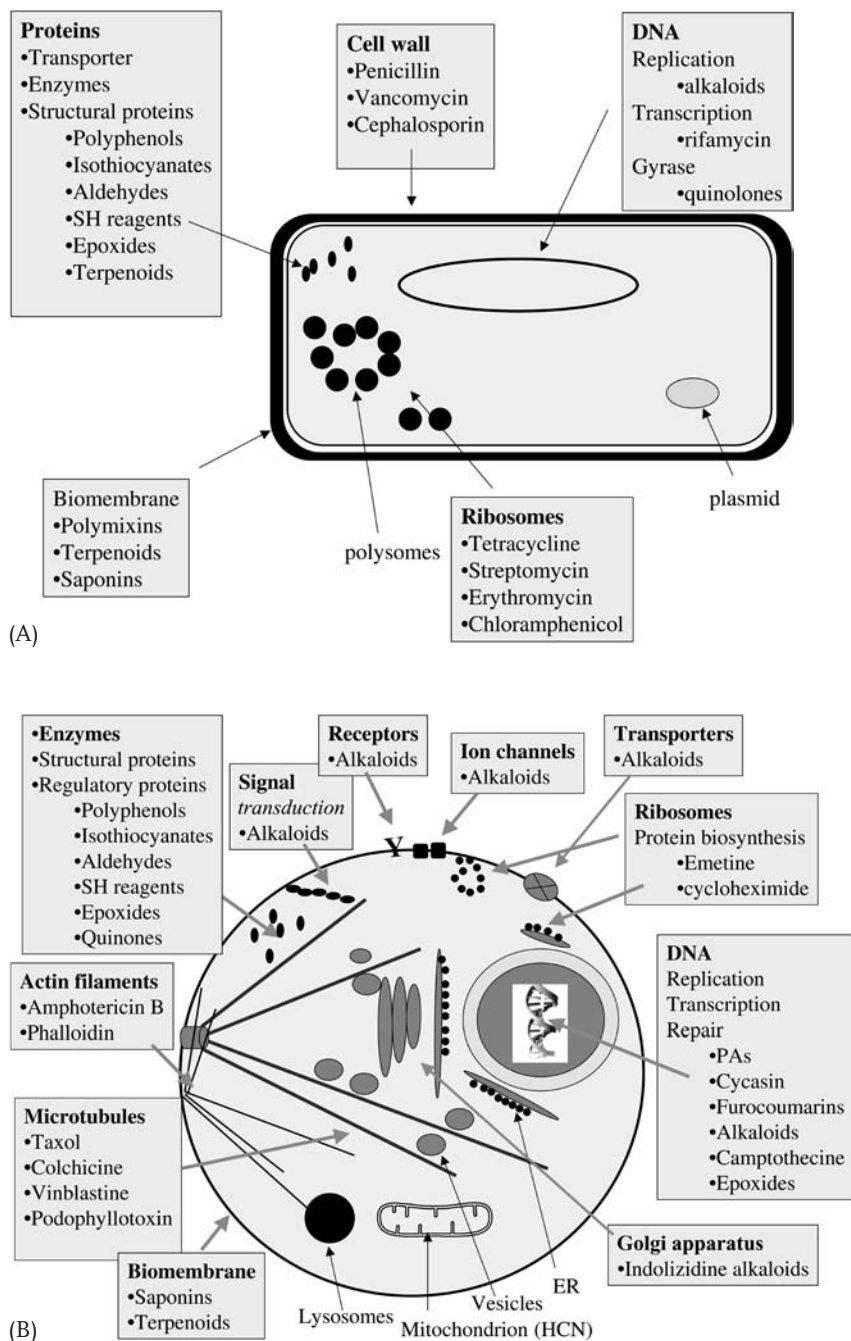
The defense strategy usually works against generalist attackers, but often not against specialists that have adapted to their host plants or prey and their defense chemicals. A diverse collection of adaptations has already been detected and described (Harborne, 1993; Wink, 1988, 1999a,b). In general, it was observed that mono- and oligophagous insects can tolerate the defense chemicals of their particular host plants, but are susceptible to those of nonhost species.

The observed multiple functions of secondary metabolites are typical and do not contradict the main role of many secondary metabolites as *chemical defense* and *signal compounds*. If a costly trait can serve multiple functions (maintenance of the biochemical machinery to produce and store secondary metabolites is energetically costly; Wink, 1999a), it is more likely that it is maintained by natural selection as it provides a selective advantage for its carrier.

### 6.3

#### Modes of Action

In order to fulfill the role of defense substances against herbivores, predators and microbes, secondary metabolites must be able to interfere with molecular targets in the organs, tissues and cells of these organisms. The major types of molecular targets in prokaryotes and eukaryotes that are relevant in this context are listed in Table 6.4; these include biomembranes, proteins, and nucleic acids (DNA and RNA) (Wink 1993, 1999b, 2000, 2005; Teuscher and Lindequist, 1994; Roberts and Wink, 1998) (Fig. 6.3).



**Fig. 6.3** Major molecular targets of cells. (A) Bacterial cells; (B) animal cells. ER: endoplasmic reticulum.

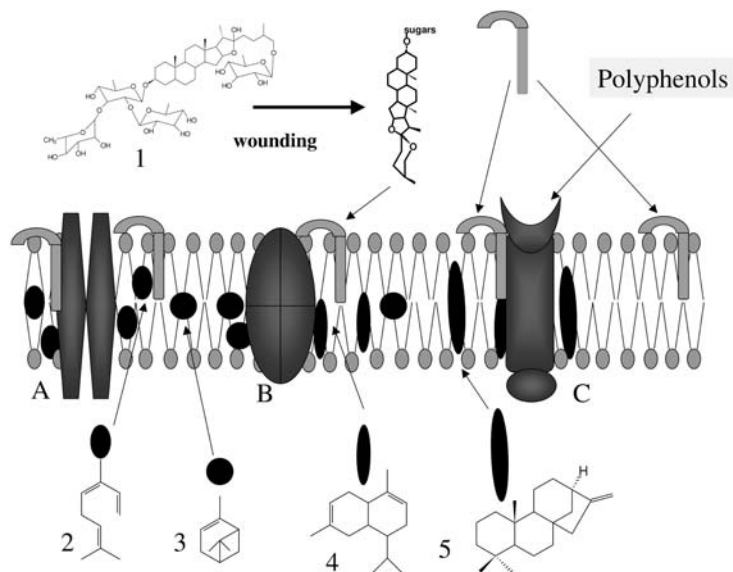
**Table 6.4** Interaction of secondary metabolites with molecular targets.

<b>Target</b>	<b>Activity</b>	<b>Secondary metabolites (examples)</b>
Unselective targets		
Biomembrane	Membrane disruption	Saponins
	Disturbance of membrane fluidity	Small lipophilic secondary metabolites
	Inhibition of membrane proteins (change of protein conformation)	Small lipophilic secondary metabolites
Proteins		
Nonselective interactions	Noncovalent bonding (change of conformation)	Polyphenols such as phenylpropanoids, flavonoids, catechins, tannins, lignans, quinones, anthraquinones, some isoquinoline alkaloids
	Covalent bonding (change of conformation)	Isothiocyanates sesquiterpene lactones, allicin, protoanemonine, furanocoumarins, iridoids (aldehydes), secondary metabolites with aldehydes, secondary metabolites with exocyclic CH <sub>2</sub> group, secondary metabolites with epoxide group
Specific interaction	Inhibition of enzymes	HCN from cyanogens, many structural mimics
	Modulation of regulatory proteins	Phorbol esters, caffeine
	Inhibition of ion pumps	Cardiac glycosides
	Inhibition of microtubule formation	Vinblastine, colchicines, podophyllotoxin, paclitaxel
	Inhibition of protein biosynthesis	Emetine, cycloheximide
	Inhibition of transporters	Non-protein amino acids
	Modulation of hormone receptors	Genistein, many other isoflavonoids
	Modulation of neuroreceptors	Nicotine, many alkaloids, conotoxins, nereistoxin, argiotoxin, argiopin
	Modulation of ion channels	Aconitine, many alkaloids; conotoxins, tetrodotoxin, saxitoxin, gonyautoxin, ciguatoxin, palytoxin
	Modulation of transcription factors	Cyclopamine, hormone mimics
DNA	Covalent modifications (point mutations)	Pyrrrolizidine alkaloids, aristolochic acids, furanocoumarins, secondary metabolites with epoxy groups
	Intercalation (frameshift mutations)	Planar, aromatic and lipophilic secondary metabolites, sanguinarine, berberine, emetine, quinine, furanocoumarins, anthraquinones
	Inhibition of DNA topoisomerase I	Camptothecin
	Inhibition of transcription	Actinomycin D

## 6.3.1

**Biomembranes**

*Biomembranes* surround all living cells, and function as a permeation barrier. The barrier prevents polar molecules from leaking out of the cell, and unwanted molecules from entering the cell. Several secondary metabolites exist in Nature that interfere with membrane permeability (see Table 6.4). The most infamous of these are the saponins, which occur widely in the plant kingdom but less commonly in animals; mono-desmosidic saponins (see Table 6.3) are *amphiphilic* and function basically as detergents that can solubilize biomembranes. With their lipophilic moiety, they anchor in the lipophilic membrane bilayer, whereas the hydrophilic sugar moiety remains outside and interacts with other glycoproteins or glycolipids (Fig. 6.4). As a result, pores are generated in the membrane which causes it to leak. This effect can be easily demonstrated with red blood cells since, if saponins are present hemolysis occurs, and hemoglobin is able to flow out of the cell. Other lipophilic secondary metabolites, such as mono-, sesqui- and diterpenes, can also disturb membrane fluidity at higher concentrations. These compounds are able to interact with the lipophilic inner core of biomembranes represented by phospholipids and cholesterol (Fig. 6.4). This type of membrane disturbance is unselective, and therefore secondary metabolites with such properties are toxic to bacterial, fungal, and animal cells. Some may also affect viral membranes.



**Fig. 6.4** Interactions of secondary metabolites with biomembranes and membrane proteins. 1, A steroidal saponin; sarsaparilloside. 2, Ocimene (linear monoterpene). 3, Alpha-pinene (bicyclic monoterpene). 4, Cadinene (sesquiterpene). 5, Phyllocladene (diterpene). A: ion channel; B: transporter; C: membrane receptor.

Biomembranes harbor a wide set of *membrane proteins*, including ion channels, transporters for nutrients and intermediates, receptors, and proteins of signal transduction and the cytoskeleton. These proteins can only function correctly if their structure is in the correct conformation. Membrane proteins with transmembrane domains are stabilized by the surrounding lipids. Hence, if lipophilic secondary metabolites are dissolved in the biomembrane they disturb the close interaction between the membrane lipids and proteins, changing the protein conformation (Table 6.4; Fig. 6.4), and a loss of function is the usual consequence. This mode of action is demonstrated by anesthetics, which are small, lipophilic compounds that inactivate ion channels and neuroreceptors, and thus block signal transduction. Several of the small terpenoids can react in a comparable manner; plants with essential oils are often used in medicine as carminative drugs (i.e., a drug that relieves intestinal spasms). In this respect it is possible that secondary metabolites inactivate ion-channels and receptors, leading to the relaxation of smooth muscles in the intestinal tissues.

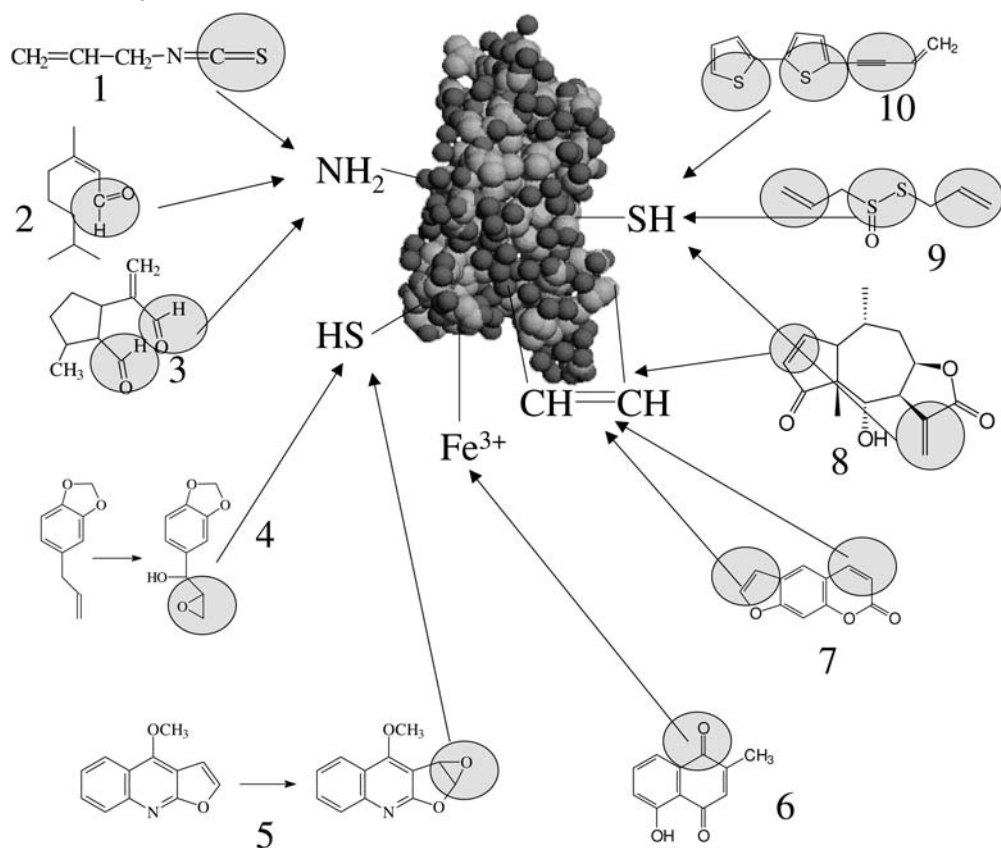
### 6.3.2

#### Proteins and Protein Conformation

*Proteins* have multiple functions in a cell, ranging from catalytic enzymes, transporters, ion channels, receptors, microtubules, histones to regulatory proteins (e.g., signal molecules, transcription factors). Proteins can only function correctly if they have the correct shape and conformation. Conformational changes also alter the protein's properties and can prevent effective protein–protein cross-talk that is vital for intracellular communication. Protein activities are often regulated by phosphorylation or dephosphorylation, with the addition or subtraction of such a bulky group inducing a conformational change. It is likely that most secondary metabolites found in Nature interact with proteins in one way or another. Most secondary metabolites interfere with proteins in an *unselective* manner – that is, they affect any protein that they encounter (Fig. 6.5). Such unselective interactions can be subdivided into those that involve *noncovalent* bonding and those with *covalent* bond formation.

A major class of secondary metabolites, the *polyphenols*, includes structures such as phenylpropanoids, flavonoids, catechins, tannins, lignans, quinones, anthraquinones, and several alkaloids with one or several phenolic hydroxyl groups (Table 6.4; Fig. 6.5). The phenolic hydroxyl groups can partly dissociate under physiological conditions resulting in  $\text{-O}^-$  ions (phenolates). The polyphenols have in common that they can interact with proteins by forming hydrogen bonds and ionic bonds with electronegative atoms of the peptide bond or the positively charged side chains of basic amino acids (lysine, histidine, arginine), respectively. A single noncovalent bond is quite weak, but because several such bonds are formed concomitantly when a polyphenols encounters a protein a change in protein conformation is likely to occur that commonly leads to protein inactivation.

However, the formation of *covalent bonds* also occurs (Fig. 6.6). Several types of secondary metabolites carry reactive functional groups that can bind to amino and

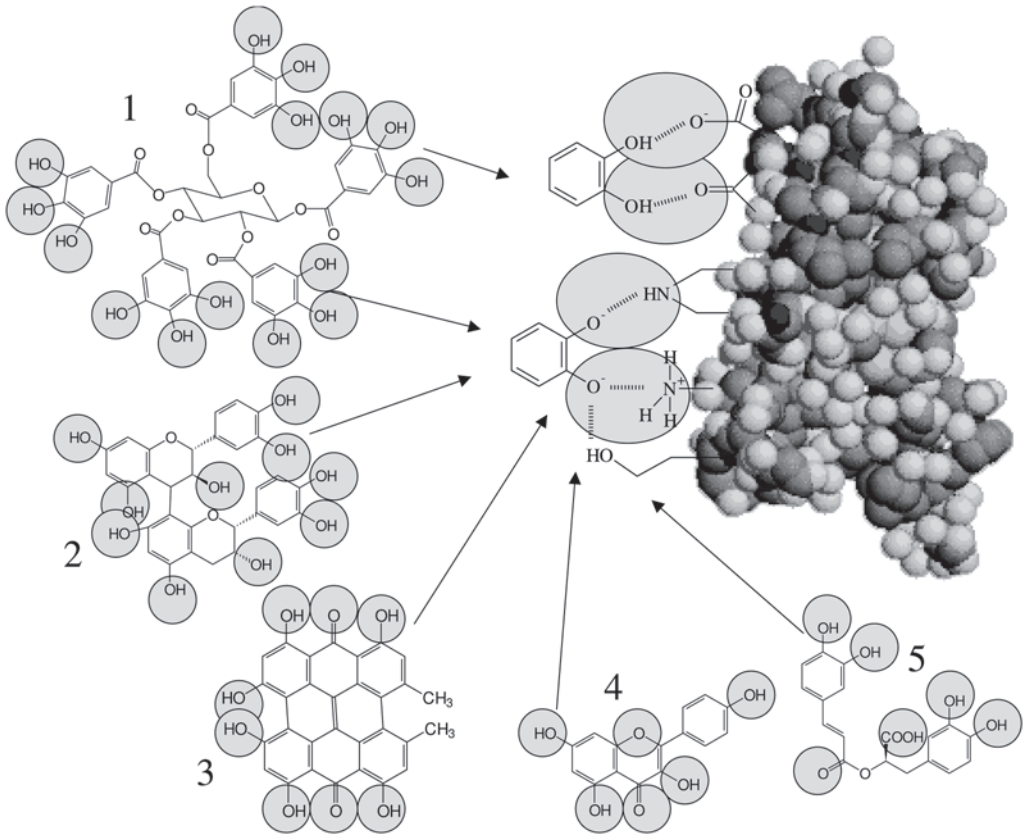


**Fig. 6.5** Covalent modifications of proteins by secondary metabolites. 1. Allylisothiocyanate (mustard oil). 2. Citral (linear monoterpene). 3. Iridoid with opened lactol ring. 4. Safrole (phenylpropanoid).

5. Dictaminine (furoquinoline alkaloid). 6. Plumbagin (naphthoquinone). 7. Psoralen (furocoumarin). 8. Helenaline (sesquiterpene lactone). 9. Allicin (SH-reagent). 10. 5-(3-butenyl-1-ynyl)-2,2-bithienyl (BBT; polyine).

-SH groups or to double bonds in proteins. This covalent modification also leads to a conformational change and thus loss of activity. Secondary metabolites with reactive functional groups that are able to undergo electrophilic or nucleophilic substitutions are represented by isothiocyanates, allicin, protoanemonin, iridoid aldehydes, furanocoumarins, valepotriates, sesquiterpene lactones and secondary metabolites with active aldehydes, epoxide or terminal and/or exocyclic methylene groups (Table 6.4; Fig. 6.6). In several instances the reactive metabolites are not natively present in plants, but they can be converted to active metabolites either by the wounding process (releasing metabolizing enzymes) inside the producing organism or in the body of a herbivore/predator (after biotransformation in intestine or liver).





**Fig. 6.6** Noncovalent modifications of proteins by secondary metabolites. 1, Pentagalloylglucose (gallotannin). 2, Dimeric procyanidin B4 (catechol tannin). 3, Hypericine (dimeric anthraquinone). 4, Kaempferol (flavonoid). 5, Rosmarinic acid (phenylpropanoid). Note: A color version of this figure is available in the color plate section.

In addition to the unselective interactions (broadband activities), several secondary metabolites are known to modulate protein activities in a specific manner in that they can bind as a ligand to the active site of a receptor or enzyme; this binding has been termed “induced fit”. In this case, the structure of a given secondary metabolite is often a mimic of an endogenous ligand. Well-studied examples include several alkaloids that are structural analogues of neurotransmitters; for example, nicotine and hyoscyamine are mimics of acetylcholine, with nicotine binding to nicotinic acetylcholine receptors or hyoscyamine to muscarinic acetylcholine receptors. The various steps in neuronal signaling and signal transduction provide central targets that are affected by several amines and alkaloids (Table 6.4). The targets may be the neuroreceptor itself. Agonists mimic the function of a neurotrans-

mitter (acetylcholine, dopamine, noradrenaline, adrenaline, serotonin, GABA, glutamate, glycine, endorphins, peptides) by binding to its receptor and causing the normal response. Antagonists (often called “blockers”) also bind to the receptor but act as an inhibitor of the natural ligand by competing for binding sites on the receptor, thereby blocking the physiological response. Further targets are voltage-gated  $\text{Na}^+$ ,  $\text{K}^+$  and  $\text{Ca}^{2+}$  channels and the enzymes, which deactivate neurotransmitters after they have bound to a receptor, such as acetylcholine esterase, monoamine oxidase and catechol-*O*-methyltransferase. Also relevant are transport processes, which are important for the uptake and release of neurotransmitters in the presynapse or synaptic vesicles.  $\text{Na}^+$ ,  $\text{K}^+$ , and  $\text{Ca}^{2+}$ -ATPases, which restore the ion gradients, must also be considered in this category. Furthermore, the modulation of key enzymes of signal pathways, including adenylyl cyclase (making cAMP), phosphodiesterase (inactivating cAMP or cGMP), phospholipase C (releasing inositol phosphates such as  $\text{IP}_3$  and diacylglycerol (DAG) and several protein kinases, such as protein kinase C or tyrosine kinase (activating other regulatory proteins or ion channels) are important steps for which inhibitors from nature are known (see Table 6.3).

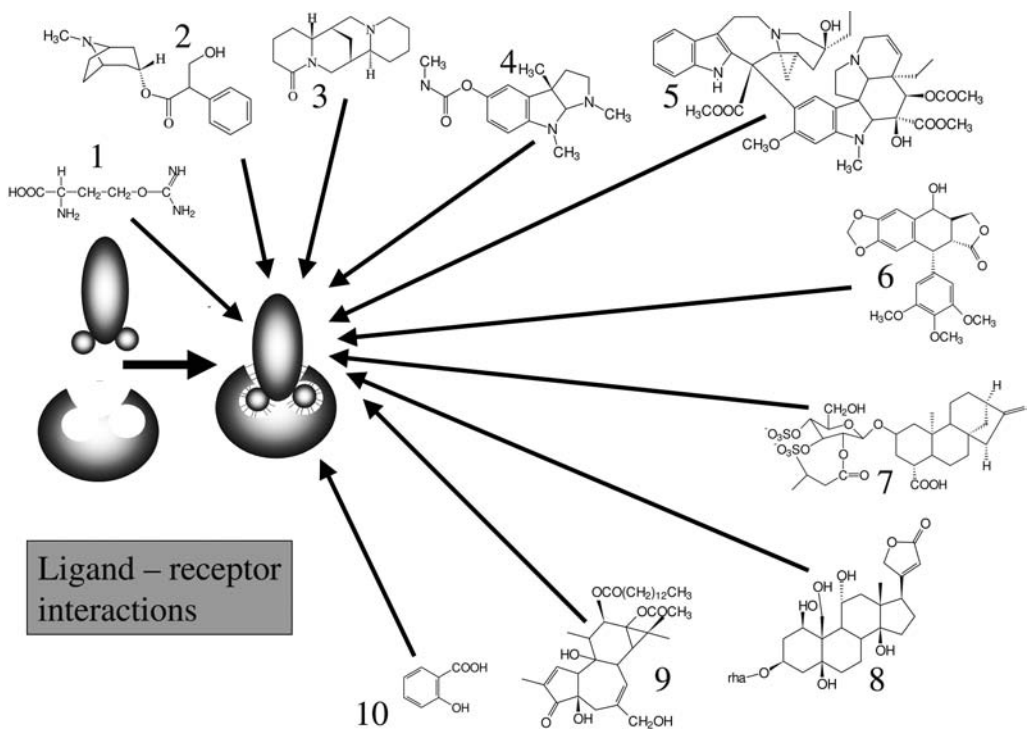
Another example of a more specific inhibitor is that of HCN released from cyanogenic glycosides common secondary metabolites in plants and some invertebrates. HCN is highly toxic for animals or microorganisms due to its inhibition of enzymes of the respiratory chain (i.e., cytochrome oxidase) and subsequent blockade of essential ATP production. HCN also binds to other enzymes containing heavy metal ions. In the case of emergency – that is, when plants are wounded by herbivores or other organisms – the cellular compartmentation breaks down and vacuolar cyanogenic glycosides come into contact with an active  $\beta$ -glucosidase of broad specificity, which hydrolyzes them to yield 2-hydroxynitrile (cyanohydrine). 2-Hydroxynitrile is further cleaved into the corresponding aldehyde or ketone and HCN by a hydroxynitrile lyase.

A number of diterpenes are infamous for their toxic properties (cytotoxicity, inflammation), such as phorbol esters of Euphorbiaceae and Thymelaeaceae (Fig. 6.7). These diterpenes specifically activate protein kinase C, which is an important key regulatory protein in animal cells. Another diterpene, forskolin, acts as a potent activator of adenylyl cyclase. Paclitaxel (Taxol<sup>®</sup>) is another diterpene that can be isolated from several yew species (including the north American *Taxus brevifolia* and the European *Taxus baccata*). Paclitaxel stabilizes microtubules and thus blocks cell division in the late  $G_2$  phase; because of these properties, paclitaxel has been used for almost 10 years with great success in the chemotherapy of various tumors. Microtubule formation is a specific target for the alkaloids vinblastine (from *Catharanthus roseus*), colchicine (*Colchicum autumnale*) or the lignan podophyllo-toxin (from *Podophyllum* and several *Linum* species) (Fig. 6.7).

One special case of steroidal saponins is that of cardiac glycosides that inhibit  $\text{Na}^+$ ,  $\text{K}^+$ -ATPase, one of the most important targets in animal cells responsible for the maintenance of  $\text{Na}^+$  and  $\text{K}^+$  gradients. Cardiac glycosides can be divided into two classes:

- *Cardenolides* have been found in Scrophulariaceae (*Digitalis*), Apocynaceae (*Apocynum*, *Nerium*, *Strophanthus*, *Thevetia*), Asclepiadaceae (*Periploca*, *Xysmalobium*), Brassicaceae (*Erysimum*, *Cheiranthus*), Celastraceae (*Euonymus*), Convolvulariaceae (*Convallaria*) and Ranunculaceae (*Adonis*).
- *Bufadienolides* occur in Crassulaceae (*Kalanchoe*), Hyacinthaceae (*Urginea*) and Ranunculaceae (*Helleborus*).

Another example of specific protein inhibition can be found in the class of NPAA that often occur as anti-nutrients or anti-metabolites in many plants (e.g., in Fabaceae). Many NPAA mimic protein amino acids, and quite often can be considered to be their structural analogues that may interfere with the metabolism of a herbivore. For example, in ribosomal protein biosynthesis NPAA can be accepted in place of the normal amino acid, leading to defective proteins. NPAA may compet-



**Fig. 6.7** Specific interactions (ligand-receptor relationships) of secondary metabolites with proteins. 1, Canavanine (non-protein amino acid). 2, Hyoscyamine (tropane alkaloid). 3, Lupanine (quinolizidine alkaloid). 4, Physostigmine (indole alkaloid). 5, Vinblastine (dimeric monoterpene indole alkaloid).

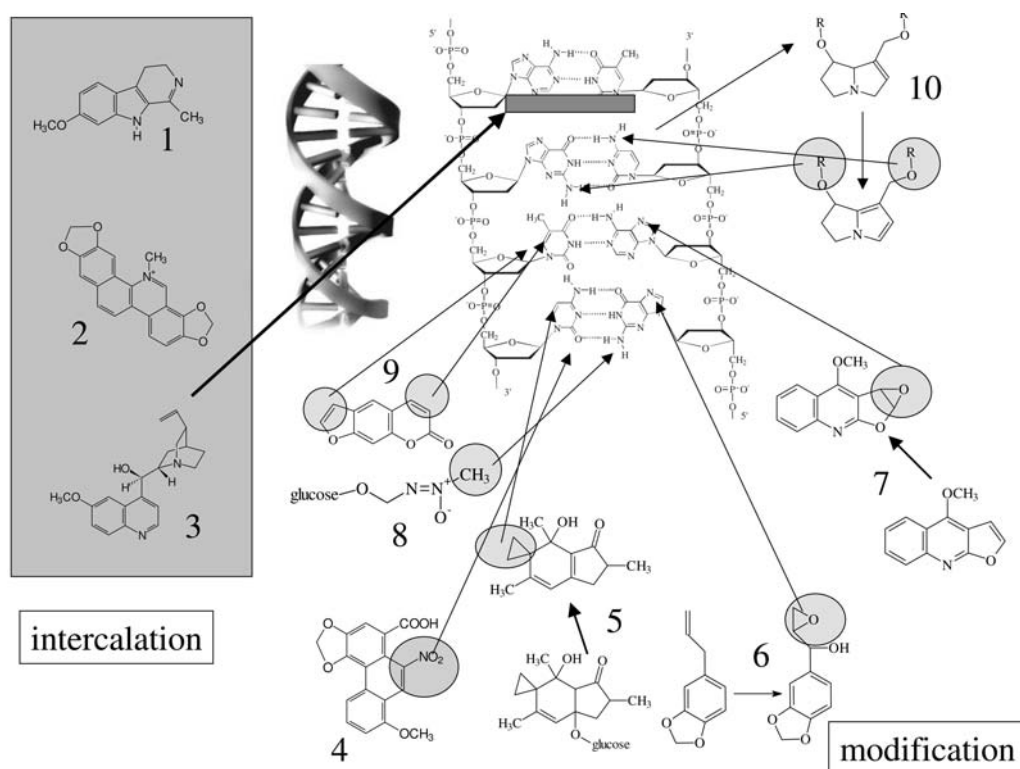
6, Podophyllotoxin (lignan). 7, Atractyloside (diterpenes). 8, Ouabain (cardiac glycoside). 9, 12-Tetradecanoyl-phorbol-13-acetate (TPA; phorbol ester). 10, Salicylic acid (phenolic acid). Note: A color version of this figure is available in the color plate section.

itively inhibit uptake systems (transporters) for amino acids; they may also inhibit amino acid biosynthesis by substrate competition or by mimicking end product-mediated feedback inhibition of earlier key enzymes in the pathway.

### 6.3.3

#### DNA and RNA

DNA is an important target in all organisms, as are the enzymes involved with DNA replication, DNA repair, DNA-topoisomerase and transcription. The translation of messenger RNA (mRNA) into protein in ribosomes is also a basic target that is present in all cells. Inhibitors of these systems are often active against a wide range of organisms, such as bacteria, fungi, and animal cells. The DNA itself can be modified by compounds with reactive groups, such as epoxides (Fig. 6.8). Infamous in this respect are the pyrrolizidine alkaloids, aristolochic acid, cycasin, fu-



**Fig. 6.8** Interactions of secondary metabolites with nucleic acids and corresponding proteins. 1, Harmaline (beta-carboline alkaloid). 2, Sanguinarine (protoberberine alkaloid). 3, Quinine (quinoline alkaloid). 4, Aristolochic acid.

- 5, Ptaquiloside (sesquiterpene).
- 6, Safrole (phenylpropanoid).
- 7, Dictamine (furoquinoline alkaloid).
- 8, Cycasin (azoxyglycoside).
- 9, Psoralen (furocoumarin).
- 10, Pyrrolizidine alkaloid.

ranocoumarins and secondary metabolites with epoxy groups (often produced in the liver). Covalent modifications can lead to point mutations and deletion of single bases or several bases if the converted bases are not exchanged by repair enzymes. Other secondary metabolites with aromatic rings and lipophilic properties intercalate DNA, which can lead to frameshift mutations (Fig. 6.8). Intercalating alkaloids include emetine, sanguinarine, berberine, quinine,  $\beta$ -carboline and furoquinoline alkaloids (Wink and Schimmer, 1999). Furocoumarins combine DNA alkylation with intercalation. Furocoumarins can intercalate DNA and, upon illumination with UV light, can form cross-links not only with DNA bases but also with proteins; they are therefore mutagenic and possibly carcinogenic. These compounds are abundant in Apiaceae (content up to 4%), but are also present in certain genera of the Fabaceae and Rutaceae.

Because frameshift mutations and nonsynonymous base exchanges in protein-coding genes alter the amino acid sequence in proteins, such mutations are usually deleterious for the corresponding cell. If they occur in germline cells, such as oocytes and sperm cells, even the next generation is negatively influenced either through malformations or protein malfunctions responsible for certain types of inheritable health disorders or illnesses.

Interference with DNA, protein biosynthesis and related enzymes can induce complex chain reactions in cells. Among these reactions is that of *apoptosis*, which leads to programmed cell death and is clearly an important process. Several alkaloids, flavonoids, allicin, saponins and cardiac glycosides have been shown to induce apoptosis in primary and tumor cell lines (Wink, 2006).

In summary, structures of allelochemicals appear to have been shaped during evolution in such a way that they can mimic the structures of endogenous substrates, hormones, neurotransmitters or other ligands; this process can be termed “evolutionary molecular modeling”. Other metabolites intercalate or modify DNA, inhibit DNA and RNA related enzymes, protein biosynthesis, other metabolic enzymes and functional proteins, or they disturb membrane stability and membrane proteins in a less specific manner.

In general, we find a series of related compounds in a given organism; often, a few major metabolites and several minor components are present, which differ in the position of their chemical groups. The metabolic profile usually varies between plant organs, within developmental periods, and sometimes even diurnally. Marked differences can also usually be seen between individuals of a single population, and even more so between members of different populations. Even small changes in chemistry can serve as the base for a new pharmacological activity. It is evident that secondary metabolites are often multifunctional compounds, and most secondary metabolites carry more than one pharmacologically active chemical group (pharmacophor). In addition, secondary metabolites usually occur in complex mixtures of various types. In consequence, as the secondary metabolites present in a given plant or animal always affect several molecular targets, it is likely that several targets are modulated concomitantly in herbivores/predators or microbes and last – but not least – in patients treated with plant-based medicines.

## 6.4

### The Utilization of Secondary Metabolites in Medicine

Since the early days of mankind, plants with secondary metabolites have been used to treat infections, health disorders, and illness (Mann, 1992; Wagner and Wiesnauer, 1995; Roberts and Wink, 1998; Wink, 1999b). Only during the past 100 years have natural medicines been replaced by synthetic drugs, for which plant structures were a lead in many instances (e.g., salicylic acid for aspirin). The use of plant drugs for medical treatment is possible since plants have evolved bioactive metabolites directed against microbes and herbivores (see above). The utilization of such compounds for medicinal purposes is, therefore, only the other side of the coin. Cardiac glycosides, for example, are very poisonous as they inhibit  $\text{Na}^+, \text{K}^+$ -ATPase, a central target in animals. However, if these compounds are used at lower concentrations the toxic effects are reduced and the medically beneficial activity is more pronounced. The  $\text{Na}^+, \text{K}^+$ -pumps are partly inactivated, leading to a higher  $\text{Na}^+$  concentration in cardiac cells. This in turn stimulates a  $\text{Na}^+, \text{Ca}^{++}$  transporter, that increases the  $\text{Ca}^{++}$  concentration in the cell; the enhanced  $\text{Ca}^{++}$  concentration then stimulates muscular contraction.

Several secondary metabolites from plants are used medicinally as isolated compounds, including many alkaloids (Roberts and Wink, 1998; Wink, 1993, 2006) such as morphine (pain killer), codeine (antitussive), papaverine (phosphodiesterase inhibitor), ephedrine (stimulant), ajmaline (antiarrhythmic), quinidine (antiarrhythmic), quinine (antimalarial), paclitaxel (tumor therapy), vinblastine (tumor therapy), podophyllotoxin (tumor therapy), camptothecin (tumor therapy), reserpine (antihypertensive), galanthamine (acetylcholine esterase inhibitor; Alzheimer's disease), aconitine (pain killer), physostigmine (acetylcholine esterase inhibitor), atropine (spasmodic; mydriatic), scopolamine (travel sickness), berberine (psoriasis), caffeine (stimulant), theophylline (antitussive), capsaicin (rheumatic pains), colchicines (gout), yohimbine (aphrodisiac), and pilocarpine (glaucoma). Other secondary metabolites include cardiac glycosides, genistein (tyrosine kinase inhibitor, phytoestrogen), khellin (angina pectoris), artemisinin (antimalarial), menthol (spasmodic), and thymol (antiseptic).

In addition to individual compounds, plant extracts and even crude drugs are widely used in many parts of the world. In complex health disorders for which the targets are not known, the application of extracts with unselective ingredients that affect several proteins and biomembranes might even be the solution of choice. The likelihood is high that the relevant target will also be affected, even if it is not known.

One very large group of microbial secondary metabolites – the antibiotics – are most likely synthesized by microorganisms as defense compounds against other microbes, but have been used medicinally for the past 60 years. Today, because resistance against common antibiotics is increasing there is an urgent need for new antibiotics with new targets, and consequently bioprospecting for antibiotics and cytotoxic compounds from bacteria and fungi is an especially active field of research. Several bacteria cannot be cultivated and have therefore not been studied in

the laboratory. However, by using genetic methods it might be possible to clone and express the corresponding genes that encode biosynthetic pathways for secondary metabolites, thereby overcoming the problem of cultivation.

Marine organisms produce secondary metabolites that have mostly been selected against microbes and lower animals. It is therefore not surprising that among the secondary metabolites isolated from these organisms, many have antibiotic and cytotoxic properties. Indeed, some of these have undergone extensive pharmacological trials and now provide interesting drug candidates.

## 6.5

### Conclusions

Plants, sessile animals and bacteria produce a wide variety of bioactive metabolites (Table 6.2) that, to date, have been only partly studied. Understanding the physiology, biochemistry and ecology of secondary metabolism offers an opportunity to breed plants with a better protection against microbes and herbivores. Moreover, understanding their molecular pharmacology represents a key to exploit bioactive natural chemicals in a rational way in medicine and agriculture (biorational pesticides). The Human Genome Project will in time identify a large number of new molecular targets, and already today industry is employing high-throughput screening to seek interesting compounds that interact with such a target. Secondary metabolites from plants, animals and microbes which have been preselected and shaped during evolution offer a very interesting chance to obtain relevant “-hits”. In this respect, the search for new active compounds or leads has been aptly named as “bioprospecting” – the search for biological gold.

### Key references

- Balandrin, M.F., Klocke, J.A., Wurtele, E.S. and Bollinger, W.H. Natural plant chemicals: sources of industrial and medicinal materials. *Science* **1985**, *228*, 1154–1160.
- Dewick, P.M. *Medicinal Natural Products. A biosynthetic approach*. Wiley, New York, **2002**.
- Harborne, J.B. *Introduction to ecological biochemistry*. 4th edition. Academic Press, London, **1993**.
- Luckner, M. *Secondary Metabolism in Microorganisms, Plants and Animals*. Springer, Heidelberg, **1990**.
- Mann, J. *Murder, Magic and Medicine*. Oxford University Press, London, **1992**.
- Roberts, M.F. and Wink, M. *Alkaloids-Biochemistry, ecological functions and medical applications*. Plenum, New York, **1998**.
- Rosenthal, G.A. and Berenbaum, M.R. *Herbivores: Their interactions with secondary plant metabolites. Volume 1. The chemical participants; Volume 2. Ecological and evolutionary processes*. Academic Press, San Diego, **1991/1992**.
- Seigler, D.S. *Plant Secondary Metabolism*. Kluwer, Boston, **1998**.
- Swain, T. Secondary compounds as protective agents. *Annu. Rev. Plant Physiol.* **1977**, *28*, 479–501.
- Teuscher, E. and Lindequist, U. *Biogene Gifte*. Fischer, Stuttgart, **1994**.
- Wagner, H. and Wiesenauer M. *Phytotherapie*. Fischer, Stuttgart, **1995**.
- Wink, M. Plant breeding: Importance of plant secondary metabolites for protection against pathogens and herbivores. *Theoret. Appl. Genet.* **1988**, *75*, 225–233.



- Wink, M. Allelochemical properties and the raison d'être of alkaloids. In: Cordell, G. (Ed.), *The Alkaloids*. Academic Press, Orlando, Volume 43, **1993**, pp. 1–118.
- Wink, M. *Biochemistry of Plant Secondary Metabolism*. Sheffield Academic Press and CRC Press, Annual Plant Reviews, Volume 2, **1999a**.
- Wink, M. *Function of Plant Secondary Metabolites and their Exploitation in Biotechnology*. Sheffield Academic Press and CRC Press, Annual Plant Reviews, Volume 3, **1999b**.
- Wink, M. Interference of alkaloids with neuroreceptors and ion channels. In: Atta-Ur-Rahman (Ed.), *Bioactive Natural Products*. Elsevier, Volume 11, **2000**, pp. 3–129.
- Wink, M. and Schimmer, O. Modes of action of defensive secondary metabolites. In: Wink, M. (Ed.), *Function of Plant secondary metabolites and their exploitation in biotechnology*. Sheffield Academic Press and CRC Press, Annual Plant Reviews, Volume 3, **1999**, pp. 17–133.
- Wink, M. Wie funktionieren Phytopharmaka? Wirkmechanismen der Vielstoffgemische. *Z. für Phytotherapie* **2005**, 26, 271–274.
- Wink, M. Molecular modes of action of cytotoxic alkaloids. From DNA intercalation, spindle poisoning, topoisomerase inhibition to apoptosis and multiple drug resistance. In: Cordell, G. (Ed.), *The Alkaloids*. Academic Press, **2006** (in press).



## 7

**Biotechnological Approaches for the Production of some Promising Plant-Based Chemotherapeutics**

*Ashish Baldi, V.S. Bisaria, and A.K. Srivastava*

**Abstract**

Today, natural products from plants provide better templates for the design of potential chemotherapeutic agents than synthetic drugs. Paclitaxel (Taxol), podophyllotoxin and camptothecin are some lead molecules which have proved to be Nature's boon in the treatment of cancer. To meet ever-increasing demands, biotechnological methods offer an excellent alternative, but the economy of such a production is the major hurdle to be overcome. The successful industrial application of plant cell cultivation for the production of these therapeutic compounds will trigger further research on other promising plant-based chemotherapeutics. As the initial hurdles for large-scale cultivation of plant cells have been overcome, the new areas of concern to produce desired products are synergistic product enhancement strategies, along with in-depth knowledge of the biosynthetic pathway. The complete pathway for the biosynthesis of podophyllotoxin has already been established, but alternative pathways of different metabolic fates of lignans, the precise sequence of the later steps in taxol biosynthesis, and the iridoid section of camptothecin biosynthesis have yet to be realized. Understanding of biochemistry, enzymology, physiology, bioreactor design and the application of proteomics and genomics are other areas on which to focus. Several points in a given metabolic pathway can be controlled simultaneously, either by overexpressing and/or suppressing several enzymes, or through the use of transcriptional regulators to control endogenous genes. Thus, multipoint metabolic engineering offers new perspectives for improvements in the production of plant-based chemotherapeutics. The aim of this chapter is to provide an overview of research on key anticancer drugs in order to elucidate the biotechnological approaches for their production in cell cultures. Special emphasis is placed on the biosynthetic pathway mapping and metabolic engineering.

## 7.1

### Introduction

Cancer, an unrestrained proliferation and migration of cells, is a scourge that has afflicted mankind since time immemorial. In spite of the spectacular advances made by medical science during the past century, the treatment of cancer remains an enigma. Cancer represents the single largest cause of death in both men and women, and is a growing public health menace. Each year, about seven million new cases are diagnosed, and about five million people die as a result of cancer. Prevalence data indicate that, currently, about 14 million people are suffering from cancer. Bearing in mind the level of morbidity that is often affiliated with this disease, comprehension of such a high incidence is horrifying.

In recent years, efforts have been made to synthesize potential anticancer drugs; consequently, hundreds of chemical variants of known classes of anticancer therapeutic agents have been synthesized. It has been recognized that a successful anticancer drug should be one, which kills or incapacitates cancer cells without causing excessive damage to the normal cells. This criterion is difficult, or perhaps, impossible to attain, and that is why cancer patients suffer from unpleasant side effects while undergoing treatments. While vast amounts of synthetic chemistry have provided relatively small improvements over the prototype drugs, the synthesis of modified forms of known drugs continues as an important aspect of research. There exists a need for new prototypes and new templates for use in the design of potential chemotherapeutic agents. Natural products are capable of providing such templates.

In the United States, under the Cancer Chemotherapy National Service Centre (CCNSC), National Cancer Institute (NCI) programme, over 35 000 plants were screened for anticancer activity between 1960 and 1986, and over 2000 crystalline plant-derived compounds were isolated and tested for activity against P<sub>388</sub> lymphocytic leukemia and KB carcinoma in cell culture. The screening program of the CCNSC brought to light hundreds of plant species, which were never used to treat cancer in any system of medicine. Some of the well-recognized anticancer plants are listed in Table 7.1. Chemical and biochemical investigations on some of these plants have yielded certain “lead” molecule as Nature’s boon for cancer chemotherapeutic uses. With an understanding of the mechanism of action as well as the structure–activity relationship, several better analogues of these “lead” molecules have been prepared. Thus, it is now doubtless that plants are the most vital source of several compounds, which possess significant therapeutic values for combating cancer.

Plants are the most exclusive source of drugs for the majority of the world’s population, and plant products constitute about 25% of prescribed medicines [1,2]. The impact of natural products upon anticancer drug discovery and design can be gauged by the fact that approximately 60% of all drugs, now in clinical trials for the treatment of cancer, are either natural products, compounds derived from natural products, or contain pharmacophores derived from natural products [3,4]. Some important antitumor compounds isolated from different parts of higher plants are listed in Table 7.2.

**Table 7.1** The anticancer plants and their active constituents.

<b>Plant</b>	<b>Family</b>	<b>Active constituent(s)</b>
<i>Acer negundo</i>	Aceraceae	Acer saponin P (Saponin)
<i>Acnistus arborescens</i>	Solanaceae	Withalerin A (Withanolide)
<i>Acronychia baueri</i>	Rutaceae	Acronycine (Acrlaone alkaloid)
<i>Allamanda cathartica</i>	Apocynaceae	Allarnandin (Monoterpene)
<i>Baccharis megapotamica</i>	Asteraceae	Baccharin (Sesquiterpene)
<i>Baileya multiradiata</i>	Asteraceae	Pseudoguaianolide
<i>Bersama abyssinica</i>	Meliantaceae	Hellebrigenin acetate (Buladienullde)
<i>Bouvardia temifolia</i>	Rubiaceae	Bourvardin (Peptide)
<i>Brucea antidysenterica</i>	Simaroubaceae	Broceanlin (Simaroubolide)
<i>Caesalpinia gilliesii</i>	Fabaceae	Cesalin
<i>Camptotheca acuminata</i>	Nyssaceae	Camptothecin (Pyrroloquinolone alkaloid)
<i>Catharanthus roseus</i>	Apocynaceae	Vinblastine, Vincristine (Bis-indole alkaloid)
<i>Cephalis acuminata</i>	Rubiaceae	Emetine (Isoquinoline alkaloid)
<i>C. ipeccacuanha</i>	Rubiaceae	Emetine (Isoquinoline alkaloid)
<i>Cephalotaxus harringtonia</i>	Cephalotaxaceae	Harringtonine (Cephalotaxine alkaloid)
<i>Cocculus</i> sp.	Menispermaceae	Gocculine, Cocculidine (Bisclaurine alkaloid)
<i>Colchicum autumnale</i>	Liliaceae	Colchicine (alkaloid)
<i>C. speciosum</i>	Liliaceae	Colchicine (alkaloid)
<i>Crococsmia crocosmiiflora</i>	Iridaceae	Medicagenic acid (Saponin)
<i>Crotalaria assamica</i>	Leguminosae	Monocrotaline (Pyrrolizidine alkaloid)
<i>C. spectabilis</i>	Leguminosae	Monocrotaline (Pyrrolizidine alkaloid)
<i>Croton macrostachys</i>	Euphorbiaceae	Crotopoxide
<i>C. tiglium</i>	Euphorbiaceae	Phorbol derivatives (Terpenoid)
<i>Cyclea peltata</i>	Menispermaceae	Tetrandrine (Isoquinoline alkaloid)
<i>Daphne mezereum</i>	Thymelaeaceae	Mezerein (Diterpene)
<i>Elephantopus elatus</i>	Asteraceae	Elephantopin (Sesquiterpene)
<i>E. mollis</i>	Asteraceae	Molephantinin (Sesquiterpene)
<i>Eupatorium hyssopifolium</i>	Asteraceae	Eupahyssopin (Sesquiterpene)
<i>Euphorbia escula</i>	Euphorbiaceae	Ingenal dibenzoate
<i>Fagara macrophylla</i>	Rutaceae	Nilidine (Benzophenanthridine alkaloid)
<i>F. zanthoxyloides</i>	Rutaceae	Fagaronine (Benzophenanthridine alkaloid)
<i>Gnidia lamprantha</i>	Thymelaeaceae	Guidin (Diterpene)
<i>Gossypium</i> sp.	Malvaceae	Gossypol (Sesquiterpene dimer)
<i>Helenium autumnale</i>	Asteraceae	Helevalin (Sesquiterpene)
<i>H. microcephalum</i>	Asteraceae	Microlenin (Sesquiterpene dimer)
<i>Heliotropium indicum</i>	Boraginaceae	Indicine- <i>N</i> -oxide (Pyrrolizidine alkaloid)
<i>Holacantha emoryi</i>	Simaroubaceae	Holacanthone (Simaroubalide)
<i>Hymenoclea salsola</i>	Asteraceae	Ambrosin (Sesquiterpene)
<i>Ipomoea batatas</i>	Convolvulaceae	4-Ipomeanol (Monoterpene)
<i>Jacaranda caucana</i>	Bignoniaceae	Jacaranone (Quinone)
<i>Jatropha gossypifolia</i>	Euphorbiaceae	Jatrophone (Diterpene)
<i>Juniperus chinensis</i>	Cupressaceae	Podophyllotoxin (Lignan)
<i>Liatrix chapmanii</i>	Asteraceae	Liatrixin (Sesquiterpene)
<i>Linum album</i>	Linaceae	Podophyllotoxin (Lignan)
<i>Linum flavum</i>	Linaceae	5-Methoxypodophyllotoxin (Lignan)
<i>Mappia foetida</i>	Olinaceae	Camptothecin (Pyrroloquinoline alkaloid)
<i>Marah omganus</i>	Cucurbitaceae	Cucurbitacin E
<i>Maytenus buchananii</i>	Celastraceae	Maytansine (Ansa macrolide)

Table 7.1 Continued

<b>Plant</b>	<b>Family</b>	<b>Active constituent(s)</b>
<i>M. ovatus</i>	Celastraceae	Maytansine (Ansa macrolide)
<i>M. serrata</i>	Celastraceae	Maytansine (Ansa macrolide)
<i>Montezuma speciasissima</i>	Malvaceae	Gossypol (Sesquiterpene dimer)
<i>Ochrosia elliptica</i>	Apocynaceae	Ellipticine (Pyridocarbazole alkaloid)
<i>O. maculata</i>	Apocynaceae	9-Methoxyellipticine (Pyridocarbazole alkaloid)
<i>O. moorei</i>	Apocynaceae	Ellipticine (Pyridocarbazole alkaloid)
<i>Parquetina nigrescens</i>	Asclepiadaceae	Strophanthidin (Cardenolide)
<i>Penstemon deutus</i>	Scrophulariaceae	Penstimide (Monoterpene)
<i>Phyllanthus acuminatus</i>	Euphorbiaceae	Phyllathoside
<i>Pierreodendron kerstingii</i>	Sapotaceae	Glaucarubinone (Simaroubolide)
<i>Piper futokadzura</i>	Piperaceae	Crotopoxide
<i>Podtaxopus gracilori</i>	Podocarpaceae	Podolide (Dilactone)
<i>Podophyllum hexandrum</i>	Podophyllaceae	Podophyllotoxin, Peltatin (Lignan)
<i>P. peltatum</i>	Podophyllaceae	Podophyllotoxin, (Lignan)
<i>Putterlickia verrucosa</i>	Celastraceae	Maytansine (Ansa macrolide)
<i>Simarouba glauka</i>	Simaroubaceae	Glaucarubinone (Simaroubolide)
<i>Steganotaenia araliaceae</i>	Umbelliferae	Liatrin (Sesquiterpene)
<i>Stereospermum suaveolens</i>	Bignoniaceae	Lapachol (Quinone)
<i>Strophanthus</i> sp.	Apocynaceae	Strophanthidin (Cardenolide)
<i>Taxodium distichum</i>	Taxodiaceae	Taxodione (Diterpene)
<i>Taxus baccata</i>	Taxaceae	Paclitaxel (Diterpene)
<i>T. brevifolia</i>	Taxaceae	Paclitaxel (Diterpene)
<i>Thalictrum dasycatpum</i>	Ranunculaceae	Thalicarpine (Isoquinoline alkaloid)
<i>T. minus</i>	Ranunculaceae	Thalicarpine (Isoquinoline alkaloid)
<i>Tripterygium wilfordii</i>	Celastraceae	Tripdiolide, Triptolide (Diterpene)
<i>Tylophora asthmatica</i>	Asclepiadaceae	Tylophorine
<i>T. cerbiflora</i>	Asclepiadaceae	Tylocrebine (Phenanthroindolizidine alkaloid)
<i>Vernonia guineensis</i>	Asteraceae	Vemolepin (Sesquiterpene lactone)
<i>V. hymenolepis</i>	Asteraceae	Vemolepin (Sesquiterpene lactone)
<i>Withania somnifera</i>	Solanaceae	Withaferin A, B (Withanolides)
<i>Zaulzainia</i> sp.	Rubiaceae	Zaluzonic C (Ridoid)
<i>Zanthoxylum</i> sp.	Rutaceae	Nitidine (Benzoohenathridine)

Table 7.2 Concentrations of antitumor compounds present in higher plants.

<b>No.</b>	<b>Antitumor compound</b>	<b>Concn. [dry wt. %]</b>
1	Baccharin	$2.0 \times 10^{-2}$
2	Bruceantin	$1.0 \times 10^{-2}$
3	Camptothecin	$5.0 \times 10^{-3}$
4	Ellipticine	$3.2 \times 10^{-5}$
5	Homoharringtonine	$1.8 \times 10^{-5}$
6	Maytansine	$2.0 \times 10^{-5}$
7	Podophyllotoxin	$6.4 \times 10^{-1}$
8	Taxol	$5.0 \times 10^{-1}$
9	Tripdiolide	$1.0 \times 10^{-3}$
10	Vinblastine, Vincristine	$5.0 \times 10^{-3}$

During the past decade, renewed interest in investigating plant-based products has led to the advent of several important anticancer substances. Most important are paclitaxel (taxol) from *Taxus brevifolia* L., podophyllotoxin from *Podophyllum peltatum* L., and camptothecin from *Camptotheca acuminata* Decne. Interestingly, these substances embrace some of the most exciting new chemotherapeutic agents currently available for use in clinical settings. The analogues of podophyllotoxin, taxol and camptothecin are illustrated in Figures 7.1, 7.2 and 7.3, respectively. The

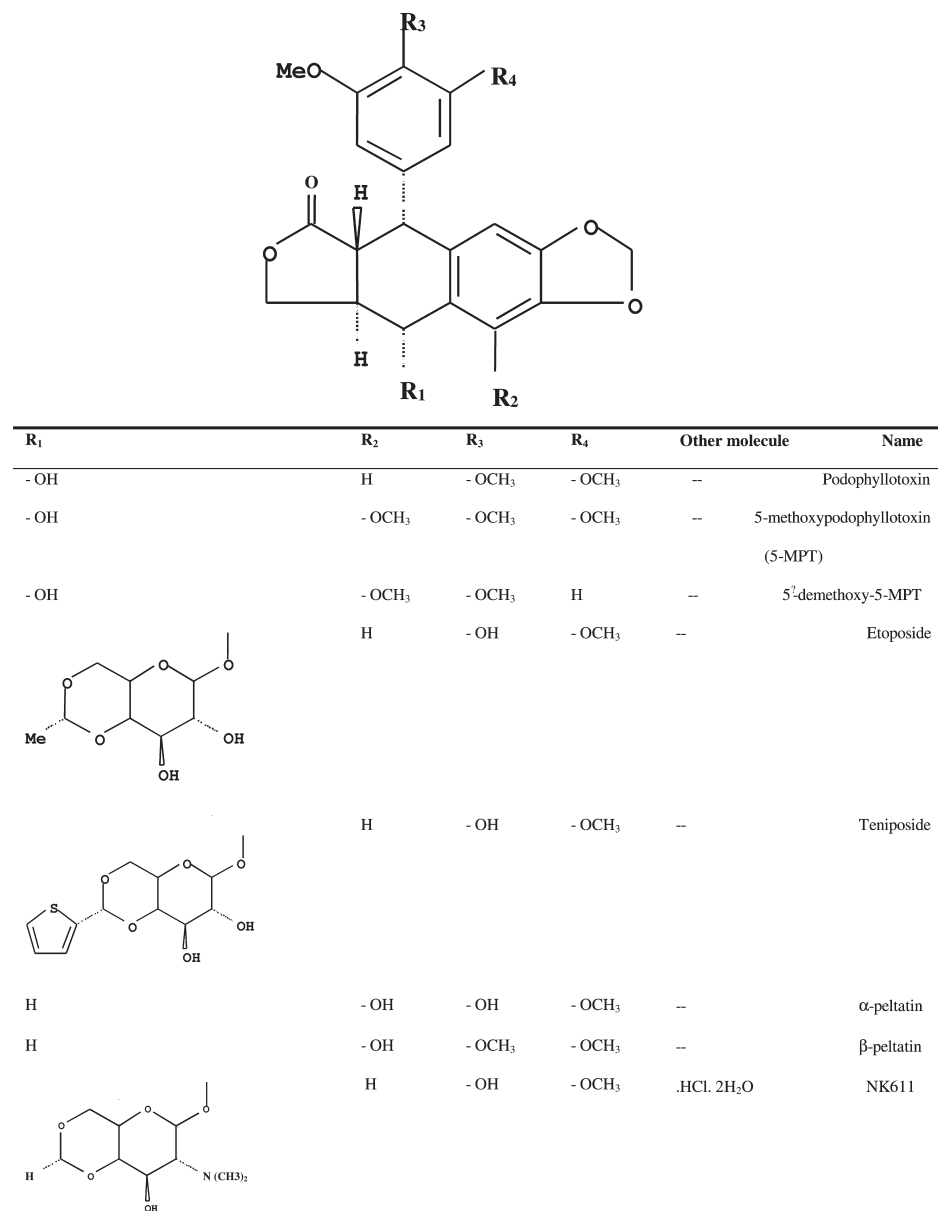
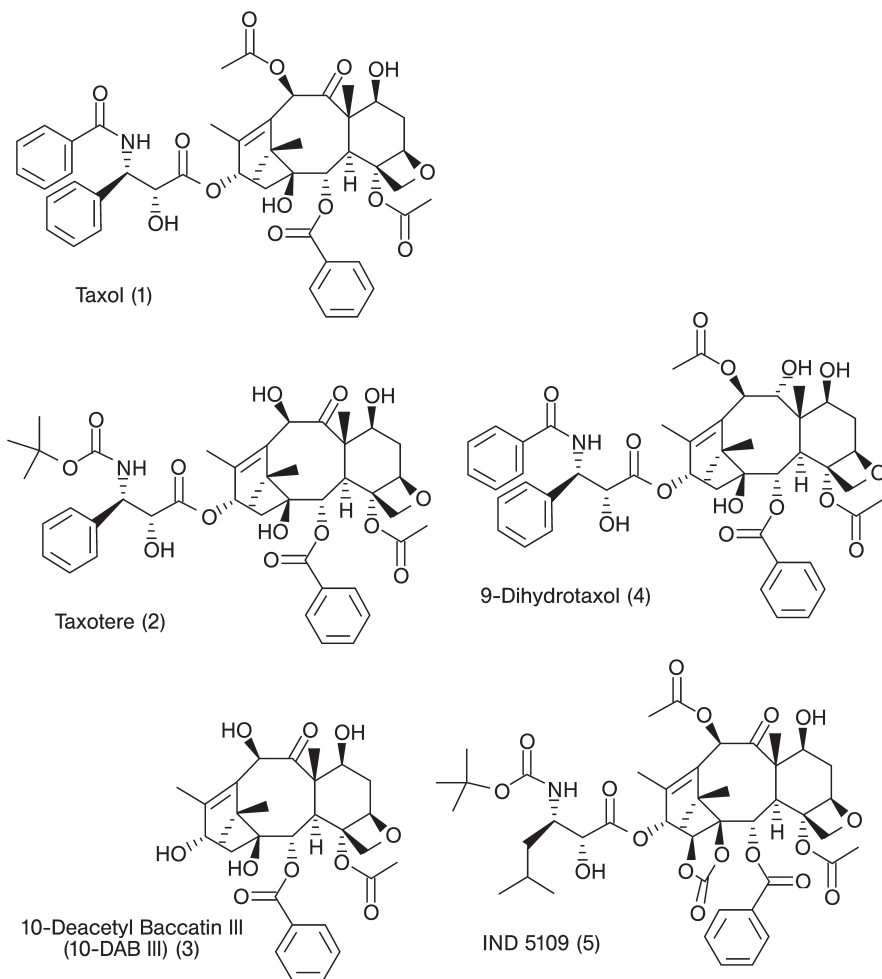
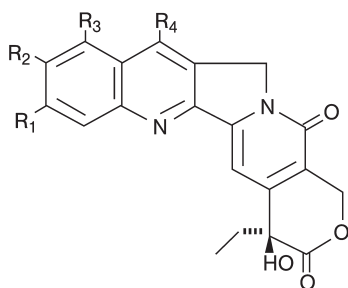


Fig. 7.1 Podophyllotoxin and its analogues.



**Fig. 7.2** Taxol and its analogues.

use of paclitaxel has been expanded to include a greater variety of cancers and more recently, Taxotere<sup>®</sup> has received approval by the FDA. Further, a podophyllotoxin analogue, teniposide (Vumon<sup>®</sup>), and a water-soluble camptothecin analogue, topotecan hydrochloride (Hycamtin<sup>®</sup>), have been approved for human use during the past few years. Based on this impressive array of structures and activities, it is clear that plants and plant-derived drugs play a dominant role in contemporary cancer therapy [5]. The mode of action of some promising chemotherapeutics from natural origin and their derivatives is indicated in Table 7.3.



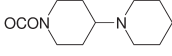
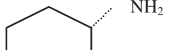
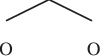
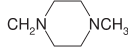
R <sub>1</sub>	R <sub>2</sub>	R <sub>3</sub>	R <sub>4</sub>	Analogue
H	H	H	H	Camptothecin
H	OH	CH <sub>2</sub> N(CH <sub>3</sub> ) <sub>2</sub>	H	Topotecan
H	H	NO <sub>2</sub>	H	Rubitecan
H		H	Ethyl	Irinotecan
F	Me			Exatecan
		H		Lurtotecan

Fig. 7.3 Camptothecin and its analogues.

## 7.2

### Production by Plant Cell Cultures

It is not an easy task to produce these compounds economically by extraction from intact plants and meet the ever-increasing demand. This may be due to very low concentrations of these active compounds in plants (Table 7.4), the slow growth rate of plants, complex accumulation patterns, and high susceptibility to geographical and environmental conditions. Other possible reasons are the non-availability of uniform and unadulterated quality plant material in quantities sufficient for in-

**Table 7.3** Some chemotherapeutic products from natural sources, and their mode of action.

<b>Source</b>	<b>Natural compounds or its derivatives</b>	<b>Mode of action</b>	<b>Cancer inhibited</b>	<b>Reference(s)</b>
<i>Podophyllum</i> spp.	Podophyllotoxin (Natural)	As a mitotic spindle poison, binds the microtubule and causes mitotic arrest in metaphase	Lung	161
	Etoposide and teniposide (Semisynthetic derivatives)	Induce a premitotic blockage in the cell cycle, at two specific places, either in late S-phase or in early G-phase, by binding to and stabilizing the cleavable complex of DNA–topoisomerase II.	Lung, testicular, leukemias	161, 162
<i>Taxus baccata</i>	10-Deacetyl baccatin 111:Docetaxel (Semisynthetic derivatives)	Promotes tubulin assembly and inhibition of microtubule depolymerization; also acts as a mitotic spindle poison and induced mitotic block in proliferative cells	Breast, ovarian, nonsmall-cell lung, head and neck, colorectal melanoma	66, 163
<i>Taxus brevifolia</i>	Paclitaxel (Natural)	Promotes assembly of microtubules, stabilizes them against depolymerization, and inhibits cell replication; causes cell apoptosis.	Advanced breast, ovarian, adenocarcinoma, and other solid tumors	164–167
<i>Camptotheca acuminata</i>	10-hydroxy camptothecin, Irinotecan (CPT-11), SN-38 (Semisynthetic derivatives)	Inhibits action of topoisomerase I, prevents religation of DNA strand, results in cell death	Liver, colorectal, head and neck cancer, leukemia	168–170

**Table 7.4** Antitumor compounds from cell cultures versus intact plant.

<b>Plant</b>	<b>Antitumor compound</b>	<b>Plant [% DW]</b>	<b>Cultured cells [% DW]</b>	<b>Reference(s)</b>
<i>Camptotheca acuminata</i>	Camptothecin	$5 \times 10^{-3}$	$2.5 \times 10^{-4}$	160
<i>Podophyllum</i> spp.	Podophyllotoxin	$6.4 \times 10^{-1}$	$7.1 \times 10^{-1}$	8, 9
<i>Taxus</i> spp.	Taxol	$5 \times 10^{-1}$	153 mg L <sup>-1</sup>	25

DW, dry weight.



dustrial production and uneconomical chemical synthesis, particularly for large complex molecules. Therefore, biotechnological methods offer an excellent alternative for production of such compounds.

Some of the major limitations to meet the demand of podophyllotoxin are the inaccessible region from where the plant is obtained, its endangered status due to over-exploitation of natural resources, a long juvenile phase, poor fruit-setting ability, a long period of germination of the seeds, the continuing demand for the drug and very complicated and rather difficult chemical synthesis because of the presence of four chiral centers, a rigid trans lactone and an axially located 1-aryl substituent. The most difficult problems encountered in paclitaxel production are supply limitation arising from its very low concentration in the bark of the *T. brevifolia* (ca. 0.01% dry weight), and the very slow growth of the yew tree [6]. In order to isolate 1 kg of taxol, 10000 kg of dried bark from 3000 *T. brevifolia* trees must be extracted, whilst almost 2 g of taxol is needed to treat one patient. On the other hand, certain secondary metabolites such as camptothecin are accumulated only after a certain age or maturity of the plant. Hence, it is difficult to increase the area under plantation.

To overcome all these hurdles, the industry requires alternative methods of supply of uniform material throughout the year. Plant cell culture technology is undoubtedly one of the appropriate approaches to solve the above-described problems. However, before implementing this approach, the cost of the product and its demand should justify production by biotechnological means. For commercialization, one must consider the economic aspects and development of feasible bioprocess technologies and relevant reactor design and mode of operations for the production of these plant secondary metabolites. In this respect, batch, fed-batch and continuous cultivation of suspension culture are found to be the most economic methods [7]. The goal should therefore be to improve the productivity of cells in order to make the production of these compounds commercially viable. Commonly, no single growth-enhancing strategy can produce such a large increase, but in many cases the simultaneous application of multiple strategies results in synergistic interaction and thus an improvement of the yield. The biotechnological approaches used for production of anticancer drugs, podophyllotoxin, taxol, and camptothecin, will be addressed in the following sections.

## 7.3

### Biotechnological Approaches for Production

#### 7.3.1

#### Dedifferentiated Cultures

Today, the potential of plant cells to produce secondary metabolites in dedifferentiated cultures is used extensively to produce plant-derived drugs. Screening by selection of high-yielding cell lines is the most common method to enhance productivity.

Tissue cultures of *Podophyllum peltatum* for the production of podophyllotoxin were initiated from various explants such as rhizomes, roots and leaf segments of field-grown plants. The efficiency of various factors such as the source of explant, growth regulators and light conditions on callus growth and podophyllotoxin production were studied [8,9]. Callus was also induced from *P. hexandrum* in-vitro-grown seedlings [10]. When the callus derived from *P. hexandrum* was incubated in B5 medium containing 2,4-D, gibberellic acid and 6-benzylaminopurine, podophyllotoxin, 4'-demethyl-podophyllotoxin and podophyllotoxin-4-O-glucoside were produced, and the levels of podophyllotoxin and its derivatives were similar to those in the parent plant (0.3% dry weight) [11]. As the levels found in these cultures were quite low, the interest in podophyllotoxins was revived when root cultures of *Linum flavum* were found to contain high levels (1% dry weight) of 5-methylpodophyllotoxin and its glucosides [12]. Other podophyllotoxin-producing callus cultures are those from sterile leaves in *Juniperus chinensis*, needles of *Callitris drummondii*, and the stem and leaves of young seedlings of *Linum album* on different media [13–16]. Callus tissues and suspension culture cells of *Lilium album* also demonstrate podophyllotoxin production. One of the cell lines produced 0.3% podophyllotoxin of dried cells, together with small amounts of 5-methyl podophyllotoxin, lariciresinol and pinoresinol after three weeks of cultivation [14]. Cell suspension cultures of *Callitris drummondii* (conifer) also accumulated podophyllotoxin- $\beta$ -D-glucoside. In the dark, the cells produced approximately 0.02% podophyllotoxin of the dry cell mass, and 85–90% of the lignans were of the  $\beta$ -D-glucoside form, while in light the yield of podophyllotoxin- $\beta$ -D-glucoside increased to 0.11% [17].

*Podophyllum hexandrum* cell suspension was initiated under dark conditions on a rotary shaker at 26°C using Gamborg's B5 salts supplemented with coconut milk, sucrose and naphthalene acetic acid (NAA) [10], on Gamborg's B5 salts supplemented with 2,4-D, gibberellin and benzyladenine [11], and on MS medium containing indole acetic acid (IAA) on a gyratory shaker at 20°C in the dark in the authors' laboratory [18]. During culture growth, reduction in cell viability, biomass and product yield were found to be associated with browning of culture medium, clumping of cells, and a fall in medium pH. Supplementations of the medium with polyvinylpyrrolidone (PVP) stopped browning of the culture medium, as well as the fall in pH. Clumping of cells was reduced by the application of pectinase. *P. hexandrum* cells were found to be slow-growing and required 30 days to reach the maximum biomass of 8.3 g L<sup>-1</sup>. Podophyllotoxin production in unoptimized medium was only 4.9 mg L<sup>-1</sup> after 32 days [18]. The production of lignans by plant cell cultures at significant levels is listed in Table 7.5.

In the past, several investigators reported low paclitaxel levels in plant cell cultures [19–21], but today levels of 10–22 mg L<sup>-1</sup> are common [22–24], significantly higher levels (i.e., 153 mg L<sup>-1</sup> [25] and 110 mg L<sup>-1</sup> [26]) have been reported by some research groups. Callus cultures and suspension cultures from *T. brevifolia* cv. Repandens, *T. cuspidata*, *T. media* cvs. Hicksii and Densiformis were established. Although some cell lines grew rapidly, with doubling times of 9–14 days, the levels of paclitaxel were too low for commercial production [20]. Twenty-seven different yew

trees belonging to various genotypes and hybrids have been screened for their capacity to produce significantly high amounts of taxoids. *Taxus media* “Sargentii” proved capable of producing viable callus cultures from excised roots placed *in vitro*. In leaves and calluses, 0.069 and 0.032% paclitaxel contents were found, re-

**Table 7.5** Production of lignans in various cell cultures.

<b>(a) In callus culture</b>					
<b>Species</b>	<b>Explant</b>	<b>Lignan content [% dry weight]</b>	<b>Culture strategy</b>	<b>Reference(s)</b>	
<i>Callitris drummondii</i>	Needle	0.02% (PT)	Callus	58	
<i>Juniperus chinensis</i>	Leaf	0.005% (PT)	Callus	16	
<i>Linum album</i>	Leaf and stem of young seedling	0.3% (PT)	Callus	14	
<i>Podophyllum peltatum</i>	Rhizome	0.7% (PT)	Callus	9	
<i>Podophyllum hexandrum</i>	Seedling	0.3% (PT)	Callus	11	
<b>(b) In shake flasks</b>					
<b>Species</b>	<b>Culture time [days]</b>	<b>Lignan content [mg L<sup>-1</sup>]</b>	<b>Culture Strategy</b>	<b>Reference(s)</b>	
<i>Callitris drummondii</i>	25	16.5 (PT)	Suspension	171	
<i>Linum album</i>	11	18.0 (PT)	Suspension	172	
<i>L. flavum</i>	14	5.4 (5-MPT)	Suspension	173	
<i>L. flavum</i>	21	121.4 (5-MPT)	Root-like Suspension	37	
<i>L. nodiflorum</i>	20	22.4 (PT)			
	12	76.6 (5-MPT)	Suspension	174	
<i>Podophyllum hexandrum</i>	15	24.3 (PT)	Suspension	10	
	21	48.8 (PT)	Suspension in optimized medium	47	
<i>P. peltatum</i>	21	27.0 (PT)	Embryogenic Suspension	175	
<b>(c) In bioreactors</b>					
<b>Species</b>	<b>Biomass [g L<sup>-1</sup>]</b>	<b>Podophyllotoxin [mg L<sup>-1</sup>]</b>	<b>Volumetric productivity [mg L<sup>-1</sup> · d]</b>	<b>Culture strategy</b>	<b>Reference(s)</b>
<i>P. hexandrum</i>	21.4	13.8	0.53	Batch	46
	48.0	43.2	0.72	Fed-batch	98
	53.0	48.8	0.81	Continuous	97

PT, podophyllotoxin; 5-MPT, 5-methoxy podophyllotoxin.

spectively; these were significantly higher than were previously reported for other genotypes [27]. The production of taxoids in various cell cultures of *Taxus* spp. on industrially interesting levels is provided in Table 7.6.

**Table 7.6** Production of taxoids in various cell cultures.

<b>(a) In shake flasks</b>				
<b>Species</b>	<b>Culture time [days]</b>	<b>Taxoid content [mg L<sup>-1</sup>]</b>	<b>Culture strategy</b>	<b>Reference</b>
<i>T. canadensis</i>	12	117.0 (PcT)	Elicitation with methyl jasmonate	74
	14	506.0 (TT)		
<i>T. media</i>	14	110.3 (PcT)	Elicitation with methyl jasmonate	26
	14	145.3 (TT)		
<i>T. chinensis</i>	42	153.0 (PcT)	Medium optimization + elicitation + two-stage culture	25
	42	295.0 (TT)		
	35	67.0 (PcT)	Intermittent maltose feeding	49
	35	49.6 (PcT)	Silver nitrate elicitation	49
	35	885.9 (Tc)		
	35	82.4 (PcT)	Silver nitrate elicitation + temperature shift	49
	35	512.9 (Tc)		
	42	137.5 (PcT)	Silver nitrate elicitation + temperature shift	49
	23	274.4 (Tc)	Sucrose feeding	59
15	527.0 (Tc)	Sucrose feeding + elicitation with methyl jasmonate	176	
<b>(b) In bioreactors</b>				
<b>Species</b>	<b>Reactor</b>	<b>Taxoid content [mg L<sup>-1</sup>]</b>	<b>Culture strategy</b>	<b>Reference</b>
<i>T. cuspidata</i>	600-mL Wilson type	22.0 (PcT)	Batch study	22
	Balloon-type bubble reactor	74.0 (TT)	Media replacement	105
<i>T. media</i>	5-L stirred reactor	21.1 (PcT)	Two stage culture + Elicitation with methyl jasmonate + precursor	82
		56.0 (Bc)		
<i>T. chinensis</i>	1-L bubble column	229.0 (Tc)	Ethylene addition	107
	1-L airlift	336.0 (Tc)	Sucrose feeding + Elicitation with methyl jasmonate + ethylene addition	81
	1-L airlift	612.0 (Tc)	Sucrose feeding + Repeated elicitation with methyl jasmonate	48

PcT, paclitaxel; Tc, taxuyunnanine C; TT, total taxanes; Bc, Baccatin III.

Suspension cultures of *Nothapodytes foetida* were established, and the cell biomass was higher in the presence of NAA in comparison with 2,4-D. Culture medium supplemented with NAA and benzyl adenine (BA) attained 31.3 g L<sup>-1</sup> dry weight during 20 days of cultivation in shake flasks. In the presence of NAA, maximum concentrations of camptothecin (0.035 mg mL<sup>-1</sup>) and 9-methoxycamptothecin (0.026 mg mL<sup>-1</sup>) were found in the medium. Alkaloid production was reduced in the presence of 2,4-D in the culture medium [28]. *Camptotheca acuminata* callus cultures were induced on MS medium containing 2,4-D, and kinetin and liquid cultures were developed in the presence of gibberellin, L-tryptophan, and conditioned medium, which yielded camptothecin at about 0.0025% on a dry weight basis [29]. When the cultures were grown on MS medium containing NAA, accumulation of camptothecin reached 0.998 mg L<sup>-1</sup> [30]. Camptothecin and 10-hydroxycamptothecin were also detected in the shoots and callus cultures of *C. acuminata*. Cultures maintained on MS medium supplemented with NAA contained 0.08% dry weight of 10-hydroxycamptothecin [31]. The culture strategies used to produce camptothecin and related compounds are listed in Table 7.7.

**Table 7.7** Production of camptothecin in various cell cultures.

<i>(a) In callus culture</i>			
<i>Species</i>	<i>Alkaloid content [% dry weight]</i>	<i>Culture strategy</i>	<i>Reference</i>
<i>Camptotheca acuminata</i>	0.0025% (CPT)	Gibberillin+ Tryptophan+ Conditioned medium	29
<i>Camptotheca acuminata</i>	0.08% (10 OH CPT)	MS+ NAA	31
<i>(b) In shake flasks</i>			
<i>Species</i>	<i>Alkaloid content [mg L<sup>-1</sup>]</i>	<i>Culture strategy</i>	<i>Reference</i>
<i>Nothapodytes foetida</i>	0.035 (CPT) 0.026 (MCPT)	MS+ NAA+ BA	28

CPT, camptothecin; 10 OH CPT, 10-hydroxy camptothecin; MCPT, methoxy camptothecin.

### 7.3.2

#### Differentiated Cultures

Different plant parts such as roots, shoots and embryo have been cultured, and produce compounds similar to that from the whole plant. Embryogenic roots from a *Podophyllum peltatum* callus were induced in liquid MS medium supplemented with NAA, kinetin and casein hydrolyzate. The roots were then transferred to the medium without growth regulators, whereupon 1.6% of podophyllotoxin was detected in the dried tissues, which was sixfold higher than in the mother plant [32].

Strategies towards the *in-vitro* propagation and cultivation of *P. hexandrum* have been established by growing excised embryo on basal medium [33,34]. Rapidly producing and high-yielding *P. peltatum* plants were developed from *in-vitro* propagation protocol by growing rhizome tips on the basal MS medium containing sucrose, supplemented with benzyladenine and activated carbon. The podophyllotoxin contents of *in-vitro*-rooted bud and plantlet cultures were similar to the contents found in the wild [35].

Improvements in the productivity of podophyllotoxin required some morphological differentiation, for example root formation [37]. A threefold increase in podophyllotoxin content in comparison to controls was obtained in transformed calli of *P. hexandrum* developed by transformation of embryo using different strains of *Agrobacterium rhizogenes* viz. A4, 15834, and K599 [38]. Hairy root cultures of *Linum flavum* were also reported to produce up to 1% of 5-methoxypodophyllotoxin and its glucoside derivative on a dry cell weight basis. 5-Methoxypodophyllotoxin, isolated from the root cultures of *L. flavum* grown on vitamin-free MS basal medium supplemented with sucrose, appeared to have about the same cytotoxic potency as podophyllotoxins and its semisynthetic derivatives [36]. The levels of podophyllotoxins varied from 0.05% to 0.3% dry weight, depending on the culture conditions and the tendency to differentiate. Thus, hairy root cultures of *Linum flavum*, producing 1.5–3.5% podophyllotoxins in dry weight, seem to be most suitable for future research efforts [39].

*Linum flavum* hairy roots were also initiated from leaf discs with a success rate of approximately 50% using *A. rhizogenes* strains LBA9402 and TR105, while coniferin accumulation was significantly greater in LS medium containing 2,4-D and NAA than in MS medium without growth regulators. In LS medium, biomass and coniferin concentrations varied substantially by a factor of about 34 across eight different hairy root lines in shake-flask studies. The maximum coniferin concentration measured in the biomass was 58 mg g<sup>-1</sup> dry weight, and little or no coniferin was released into the medium during culture [40].

The genetic transformation of *Taxus brevifolia* and *T. baccata* was also reported using two strains of *Agrobacterium tumefaciens* (Bo542 and C58) [41]. Very few reports exist of *Agrobacterium*-mediated genetic transformation of *Taxus*, as the botany hierarchy of the *Taxus* is classified within group Gymnosperm of the Taxaceae family and *Agrobacterium* strains are less or no virulence towards gymnosperms.

The embryos developed unorganized callus tissues in medium containing BA + 2,4-D. BA + NAA medium promoted multiple shoot development, while kinetin (Kn) + NAA and Kn + IAA in the medium favored plantlet formation. The differentiated plantlet cultures showed slightly higher amounts of 9-methoxycamptothecin (0.0007% dry weight) than the undifferentiated callus cultures (0.0001% dry weight) [43]. The hairy roots of *Ophiorrhiza pumila*, producing camptothecin and its related alkaloids (i.e., (3S)-pumiloside, (3S)- and (3R)- deoxypumilosides and strictosamide) were also reported [44].

## 7.3.3

**Optimization of Culture Media Composition and Culture Conditions**

Medium and culture condition optimization can increase the productivity in suspension culture by a factor of 20 to 30, and is very important in order to obtain an efficient system for the production of high levels of secondary metabolites from plant cells.

Podophyllotoxin accumulation was strongly affected by light, with red light stimulating its production in *P. pelatum* cell cultures [9]. Illumination stimulated the endogenous production of podophyllotoxin- $\beta$ -D-glucoside, to a concentration of 0.11% (dry weight), in *L. flavum* cultures [44]. Dark-grown suspension cultures of *P. hexandrum* accumulated 0.1% podophyllotoxin, which was three- to fourfold that in light-grown cultures [44]. Similar results were also observed in the authors' laboratory [45]. *P. hexandrum* cells growing in shake flasks were found to be sensitive to hydrodynamic stresses generated by changing rotational speeds. A rotational speed of 150 rpm showed more than 80% viability of *P. hexandrum* cells. A medium pH of 6.0 was favorable for high biomass production and podophyllotoxin accumulation in *P. hexandrum* cell cultures [46]. MS medium with 60 mM nitrogen having an ammonium to nitrate salt ratio of 1:2, 60 g L<sup>-1</sup> glucose and 1.25 mM phosphate were found to be optimum for podophyllotoxin production [47]. Statistical optimization methodology, such as Plackett–Burman design and Response Surface Methodology, have been employed to optimize the media and culture conditions for growth and podophyllotoxin production in *P. hexandrum* cultures. The optimized values of important nutritional parameters were found to be medium pH 6.0, 1.25 mg L<sup>-1</sup> IAA concentration, 72 g L<sup>-1</sup> glucose concentration, and an inoculum level of 8 g L<sup>-1</sup>. When *P. hexandrum* was cultivated under statistically optimized culture conditions, a maximum of 20.2 g L<sup>-1</sup> (dry weight) of biomass and 48.8 mg L<sup>-1</sup> podophyllotoxin was obtained [46].

The addition of 50% (v/v) conditioned medium on day 0 resulted in a higher average growth rate compared to controls. In the case of bioreactor cultivation, taxuyunnanine (Tc) production and productivity of 43.0±17.6 mg L<sup>-1</sup> and 1.0±0.8 mg L<sup>-1</sup> day<sup>-1</sup> in the control culture increased to 78.9±20.6 mg L<sup>-1</sup> and 4.5±1.2 mg L<sup>-1</sup> day<sup>-1</sup>, respectively, when conditioned medium was added [48]. The effects of temperature shift on cell growth and paclitaxel production in suspension culture of *T. chinensis* was studied. Cell growth was optimum at 24°C, while paclitaxel synthesis reached a maximum at 29°C [49]. The most effective gas mixture composition in terms of paclitaxel production was 10% (v/v) oxygen, 0.5% (v/v) carbon dioxide, and 5 mg L<sup>-1</sup> ethylene [50,51]. The manipulation of the amount and source of sugar in cell cultures was studied as a factor for enhanced growth and secondary metabolite production [52,53]. Elevated sucrose levels were favorable in some cultures [52,54], and the addition of fructose promoted taxol production in *Taxus* spp. cell cultures [48,55].

To date, no optimization studies have been reported on the production of camptothecin in plant cell cultures.

## 7.3.4

**Immobilization**

Although immobilization was originally proposed due to its bioprocessing advantages such as the re-use of expensive biomass and easier downstream processing, experimental evidence indicates that it may also have an impact on cell physiology and the production of secondary metabolites. The immobilization of plant cells often results in increased secondary metabolite production, most likely due to improved cell–cell adhesion and eventual aggregation.

Immobilization of *P. hexandrum* cells using calcium alginate in combination with precursor feeding of L-phenylalanine and L-tyrosine was attempted, but no improvement was obtained in the accumulation of podophyllotoxin, possibly because the stress environment [56].

Paclitaxel in the callus of *T. cuspidata* was detected at a level of  $0.02 \pm 0.005\%$  (dry weight) after two months in culture. Suspension cultures of *T. cuspidata* were also established from the callus cultures and subsequently immobilized onto glass-fiber mats. The cells were maintained as immobilized cultures for six months, during which time the level of paclitaxel within the cells reached  $0.012 \pm 0.007\%$  of dry weight [57].

## 7.3.5

**Feeding of Precursors**

The addition of precursors to the media in order to direct metabolic flux towards enhanced production of the desired products represents an interesting approach to exploit the biosynthetic potential of the enzymes present in plant cell cultures.

The addition of coniferyl alcohol complexed with  $\beta$ -cyclodextrin to *P. hexandrum* cell suspension cultures increased the concentration of podophyllotoxin fourfold, to 0.013% on a dry weight basis. Noncomplexed coniferyl alcohol, suspended in the medium, also enhanced podophyllotoxin production, albeit to a lower degree [17]. Coniferin, the  $\beta$ -D-glucoside of coniferyl alcohol, was found to be a more potent precursor in terms of yield of the anticancer compound (0.055%), but is not available commercially [17]. Various phenylpropanoid precursors (phenylalanine, tyrosine, cinnamic acid, caffeic acid, coumaric acid, ferrulic acid, coniferyl alcohol, coniferin, etc.) were utilized in cell cultivation for the improvement of podophyllotoxin levels in *P. hexandrum* cell cultures. Of these, only coniferin at a concentration of 2.1 mM was able significantly to increase podophyllotoxin accumulation on the tenth day of cultivation, by a factor of 12.8. However, most of the coniferin was transformed into unknown products [17,56]. Application of the amino acid, L-phenylalanine, to cell cultures of *Linum flavum* resulted in a three- to fivefold increase in levels of 6-methoxypodophyllotoxin [58]. Co-cultured hairy roots of *Linum flavum* and *Podophyllum hexandrum* suspensions resulted in increased podophyllotoxin concentrations by 240% in shake flasks, and by 72% in a dual bioreactor, as compared to *P. hexandrum* suspension cultured alone. The coniferin provided by



*L. flavum* hairy roots acted as a precursor for the production of podophyllotoxin by *P. hexandrum* suspension cultures [40].

Improved paclitaxel yields in both callus and cell suspension cultures of *T. cuspidata* were observed following the feeding of phenylalanine and other potential paclitaxel side-chain precursors such as benzoic acid and *N*-benzoylglycine. This might be related to the possible roles of phenylalanine and other compounds in the biosynthesis of the *N*-benzoylphenylisoserine paclitaxel side chain [19]. In suspension cultures of *T. chinensis*, a combination of an initial low sucrose concentration (20 g L<sup>-1</sup>) and fed-batch mode improved both cell growth and taxane production [59]. A high level of paclitaxel production (26 mg L<sup>-1</sup>) was achieved through intermittent feeding of 3%, 1%, and 2% sucrose on days 0, 7, and 21, respectively, while intermittent feeding of 1% and 2% maltose to the *T. chinensis* cultures on days 7 and 21 increased paclitaxel production to 67 mg L<sup>-1</sup> [49]. A combination of sucrose feeding and dissolved O<sub>2</sub> tension control might represent a means of maximizing paclitaxel production [60].

Precursors such as phenylalanine, benzoic acid, serine and benzoylglycine were reported to increase the accumulation of paclitaxel in callus cultures of *T. cuspidata* [19,61,62]. In one study of *in-vitro* production of radiolabeled taxol by pacific yew, phenylalanine and leucine were shown to be the best precursors among the various compounds tested [63]. Feeding of acetate also enhanced the formation of taxol-like metabolites [23]. The addition of precursors such as sodium benzoate, hippuric acid, leucine and phenylalanine to cell cultures of *T. wallachiana* significantly improved the production of paclitaxel, baccatin, and 10-deacetyl baccatin [64].

Precursor studies using tryptamine and loganin (combined), secologanin and strictosidine were performed in *C. accuminata* cultures; feeding with strictosidine showed the precursor to be easily biotransformed by two enzymes (i.e., a hydroxylase and a dehydrogenase) to hydroxystictosidine and didehydrostrictosidine, but camptothecin was never detected [65].

### 7.3.6

#### Elicitors

Elicitation is the induction of secondary metabolite production by molecules or treatments known as “elicitors”. Elicitation is used to induce the expression of genes often associated with the enzymes responsible for synthesis of secondary metabolites by mimicking the pathogen defense or wound response in plants.

Attempts have been made to increase the accumulation of aryltetralin lignans in *Linum* spp. cultures by inducing a hypersensitive defense reaction with a variety of elicitors. However, nigeran, *Phytophthora megasperma* cell wall fractions, methyl jasmonate, hydrogen peroxide and salicylic acid were not found significantly to increase lignan accumulation in *Linum* spp. [66]. The addition of methyl jasmonate to cell cultures of *Forsythia intermedia* resulted in three- and sevenfold accumulations of the lignans, pinoresinol and matairesinol, predominantly as glucosides [67]. The effect of adding methyl jasmonate to various cell lines in suspension cul-

ture of *Linum album* has also been studied, with a twofold increase in podophyllotoxin ( $7.69 \pm 1.45 \text{ mg g}^{-1}$  dry weight) and 6-methoxypodophyllotoxin ( $1.11 \pm 0.09 \text{ mg g}^{-1}$  dry weight) being achieved as maximum in one of the cell lines [68]. The effect of yeast extract and abiotic elicitors ( $\text{Ag}^{2+}$ ,  $\text{Pb}^{2+}$  and  $\text{Cd}^{2+}$ ) was also studied on podophyllotoxin production in *L. album* suspension cultures, though only  $\text{Ag}^{2+}$  at 1 mM concentration was found to enhance production up to  $0.24 \text{ mg g}^{-1}$  cell dry weight [69].

It has been found that oxidative stress caused by treatment with a fungal elicitor leads to cell apoptosis and low paclitaxel production [70–72]. Methyl jasmonate treatment led to large improvements in both cost and efficiency over the use of undefined fungal extracts; 100 pM methyl jasmonate increased the paclitaxel level from 28 to  $110 \text{ mg L}^{-1}$  in a *T. media* cell line, and from 0.4 to  $48 \text{ mg L}^{-1}$  in *T. baccata* [26]. Other groups have reported similar effects of methyl jasmonate in cell cultures of *T. cuspidata* [73], *T. canadensis* and *T. cuspidata* [74] and *T. media* [75]. Significant enhancement of taxoid production by repeated elicitation using methyl jasmonate in bioreactor cell cultures of *T. chinensis* has also been reported [48]. Abiotic elicitors – especially the salts of some heavy metals such as lanthanum, cerium, and silver – were also effective in inducing paclitaxel production in plant cell cultures, generally resulting in several-fold increases in taxoid production [76,77].

The addition of cell extracts and culture filtrates of *Penicillium minioluteum*, *Botrytis cinerea*, *Verticillium dahliae*, and *Gilocladium deliquescens* on the day 10 after transferring *Taxus* sp. cell suspensions into an induction medium improved taxoid production [78]. Enhanced paclitaxel production in a *T. chinensis* cell culture by a combination of fungal elicitation and medium renewal was also reported [79]. *T. chinensis* culture treated with  $50 \text{ mg L}^{-1}$  of a fungal elicitor with  $50 \text{ mg L}^{-1}$  salicylic acid not only gained more biomass than was the case with treatment by the elicitor alone, but also achieved higher paclitaxel production [80]. A higher level of paclitaxel ( $3.4 \text{ mg L}^{-1}$ ) was obtained when ethylene was added at a concentration of 5 ppm in the presence of 10 pM methyl jasmonate compared with treatment solely by 10 pM methyl jasmonate in suspension cultures of *T. cuspidata* [50]. In *T. chinensis* cells, conditioned medium addition combined with methyl jasmonate (100 pM) elicitation enhanced Taxuyunnanine C productivity in bioreactors by about 30% (from  $9.2 \pm 0.9$  to  $11.8 \pm 0.9 \text{ mg L}^{-1} \text{ day}^{-1}$ ) compared with methyl jasmonate elicitation alone [48]. Furthermore, it was shown that Taxuyunnanine C productivity could be increased by combining elicitation, sucrose feeding, and ethylene incorporation in bioreactors [81].

*Taxus* suspension cultures were elicited with cell extracts and culture filtrates of four different fungi and arachidonic acid [78]. Interestingly, a preferential increase in paclitaxel over other taxanes was achieved by arachidonic acid [78] and by the addition of methyl jasmonate [26]. Membrane-lipid peroxidation caused by fungal elicitor (F5), prepared from fungus isolated from the inner bark of *T. chinensis*, was decreased by the addition of salicylic acid, even if the latter also induced cell membrane-lipid peroxidation. F5 + salicylic acid also improved the activity of glucose-6-phosphate dehydrogenase compared to single F5 treatment, and achieved the greatest taxol production of  $11.5 \text{ mg L}^{-1}$ , this being 1.5-, 2.3- and 7.5-fold higher

than that of F5, salicylic acid and the control [80]. The *Fusarium oxysporum* selected from seven species was found to be the most effective inducer of taxane accumulation. Suspension-cultured *Taxus chinensis* var. *mairei* Y901-L responded to crude elicitors from the fungus *Fusarium oxysporum* by influencing the general phenylpropanoid pathway and incorporating taxol synthesis. The maximum taxol concentration was eightfold that of controls, and increased amounts of phenolics were observed in the culture medium [71]. A two-stage culture for cell suspension was carried out with addition of methyl jasmonate ( $220 \mu\text{g g}^{-1}$  fresh weight) as elicitor in combination with mevalonate (0.38 mM) and *N*-benzoylglycine (0.2 mM) as precursors. An approximately tenfold enhancement in taxol ( $21.12 \text{ mg L}^{-1}$ ) and 20-fold enhancement in baccatin III ( $56.03 \text{ mg L}^{-1}$ ) was found in suspension cultures of *Taxus media* [82].

Cobalt chloride and silver nitrate have also been reported as elicitors, either alone or in combination, for the production of taxol in suspension cultures of *Taxus* spp. [71,79,83]. Synergistic enhancement of taxol content was also achieved by a mixture of ammonium citrate with salicylic acid [72]. Significant improvements in taxol content were also reported after the use of various elicitors such as methyl jasmonate, fungal elicitor and salicylic acid alone, or in a combination of two [26,71,84]. Statistical optimization of various precursors and elicitors for paclitaxel production using Central Composite Design was also reported. A maximum of  $54 \text{ mg L}^{-1}$  paclitaxel was produced in *T. chinensis* cell suspension cultures by adding  $10 \text{ mg L}^{-1}$  silver nitrate,  $6 \text{ mg L}^{-1}$  abscisic acid,  $23 \text{ mg L}^{-1}$  chitosan,  $15 \text{ mg L}^{-1}$  phenylalanine,  $31 \text{ mg L}^{-1}$  methyl jasmonate,  $30 \text{ mg L}^{-1}$  sodium benzoate, and  $30 \text{ mg L}^{-1}$  glycine on day 12, together with a feeding solution containing  $20 \text{ g L}^{-1}$  sucrose on day 16; this was twofold higher than paclitaxel production without optimization [85]. A combined strategy of adding various biotic and abiotic elicitors during different stages of a two-stage cell suspension culture of *T. baccata* led to a 16-fold increase in taxol production ( $39.5 \text{ mg L}^{-1}$ ) than untreated cultures in B5 medium [86].

### 7.3.7

#### ***In-Situ* Product Removal Strategies**

Strategies such as permeabilization using solvents and the addition of adsorbants to cell cultures have been used to increase secondary metabolite production. The advantages of using these strategies include the stimulation of the secondary metabolite biosynthesis and the easy separation of products.

A combination of 0.5% isopropanol and coniferin led to an accumulation of total extracellular podophyllotoxin of  $12 \text{ mg L}^{-1}$  due to partial release of intracellular product. A concentration of isopropanol exceeding 0.5% led to a reduction in dry cell weight of *P. hexandrum*, indicating a destructive effect of isopropanol on the cells [56].

The effects of adsorbent addition on the production of taxol and taxane compounds were investigated in *Taxus cuspidata* cell culture. As a suitable adsorbent, the non-ionic exchange resin XAD-4 (among several adsorbents tested) showed a

maximum adsorptive capacity for taxol, due to hydrophobic interaction between them. The addition of XAD resin to the culture medium on day 16 after subculture enhanced taxol biosynthesis by 40–70% [87].

### 7.3.8

#### **Biotransformation Studies**

Plant enzymes are able to catalyze both regioselective and stereospecific reactions. Thus, freely suspended and immobilized plant cells, as well as enzyme preparations, can be used for the production of pharmaceuticals by biotransformation, as such or in combination with chemical synthases.

The microbial transformation of deoxypodophyllotoxin to epipodophyllotoxin (a parent compound of etoposide) by *Penicillium* sp. has been reported whereas, in contrast, *Aspergillus niger* sp. transformed deoxypodophyllotoxin to podophyllotoxin [88]. The incubation of dibenzylbutanolides with cell-free extracts of *C. roseus* yielded an enzyme-catalyzed oxidative coupling of these compounds to picropodophyllotoxin analogues [89]. Four cyclodextrins –  $\beta$ -cyclodextrin,  $\gamma$ -cyclodextrin, dimethyl- $\beta$ -cyclodextrin and hydroxypropyl- $\beta$ -cyclodextrin – were investigated for the glucosylation of podophyllotoxin. A maximal bioconversion rate of  $0.51 \text{ mmol L}^{-1} \text{ day}^{-1}$  was achieved with dimethyl- $\beta$ -cyclodextrin complex at a final concentration of 1.35 mM in *L. flavum* cell suspension cultures [90]. A semi-continuous process for the biotransformation of butanolide to 4'-demethylepipodophyllotoxin at the multigram level by *P. peltatum* cell suspension cultures was also reported [91]. A synthetic dibenzylbutanolide was shown to be biotransformed into complex podophyllotoxin analogues by shoot cultures of *Hallophyllum patavinum* [92]. At low concentration (0.1 mM), deoxypodophyllotoxin was converted to 6-methyl podophyllotoxin-7-O-glycoside, 6-methyl podophyllotoxin, and traces of  $\alpha$ -peltatin and podophyllotoxin in *L. album* cultures [93].

The bioconversion of taxol/cephalomannine by *Streptomyces* sp. MA 7065 resulted in hydroxylation on the 10-acetyl methyl group with 60% yield, and on the benzene ring at the *para* position of the phenylisoserine side chain with 10% yield [94]. The incubation of *Eucalyptus perriniana* cells in medium containing paclitaxel led to the isolation of three taxoid derivatives, which were subsequently identified by  $^1\text{H}$  NMR and mass spectrometry as baccatin III, 10-deacetyl baccatin III, and 2-benzoyltaxol [95]. Similar results were also reported with *E. citridora* cell cultures [96].

### 7.3.9

#### **Bioreactor and Scale-Up Studies**

The environment in which plant cells grow usually changes when cultures are scaled-up from shake flasks to bioreactors, and this may result in reduced productivity. With the ultimate aim of implementing an industrial-scale process, the behavior of cell cultures in bioreactors has received much attention.

Submerged batch and fed-batch cultivation of *Podophyllum hexandrum* cells for podophyllotoxin production studied in a 3-L stirred-tank bioreactor. A 36% increase in volumetric productivity of podophyllotoxin was achieved in fed-batch cultivation of *P. hexandrum* cells over batch cultivation in a stirred-tank bioreactor [46, 97, 98]. Continuous cultivation of *P. hexandrum* with cell retention was also carried out in a 3-L bioreactor equipped with a spin filter mounted on the agitator shaft of the bioreactor. The result was an accumulation of 53 g L<sup>-1</sup> biomass and 48.8 mg L<sup>-1</sup> podophyllotoxin, with volumetric productivity of 0.8 mg L<sup>-1</sup> day<sup>-1</sup> [97]. A maximal product yield of podophyllotoxin, up to 0.2% dry weight, was achieved when *Linum album* cell suspensions were cultured in a 20-L bioreactor [99].

*Taxus* has been cultivated successfully for paclitaxel production in a pneumatically mixed stirred tank [100], and in Wilson-type bioreactors [22]. A continuous production system for paclitaxel production with a mesh-net cell separator was developed that increased productivity by a factor of ten compared to batch operation [101]. Low-temperature treatment not only maintained a stable high taxol production but also further enhanced taxol production compared to elicited asynchronous cultures. This resulted in a highest taxol production of 27 mg L<sup>-1</sup>, which was approximately two- and 11-fold higher than in asynchronous cultures and in elicited asynchronous cultures, respectively. Taxol production in a stirred bioreactor proved to be less than that in shake flasks [70].

Cell cultures of *T. chinensis*, when cultivated in a novel low-shear centrifugal impeller bioreactor (CIB), had a shorter lag phase and showed less cell adhesion to the reactor wall compared to a conventional cell-lift bioreactor [102, 103]. Pneumatically agitated bubble columns and airlift reactors have been more widely used for taxoid production than stirred-tank reactors [100]. Suspension cultures of *Taxus baccata* var. *fastigiata* and *Taxus wallichiana* were reported to grow in a 20-L airlift bioreactor operating in batch mode [104]. In cell cultures of *T. cuspidata*, a balloon-type bubble reactor was claimed to be more efficient in promoting cell growth than a bubble-column reactor (BCR), a BCR with a split-plate internal loop, a BCR with a concentric draught-tube internal loop, a BCR with a fluidized bed, and two different models of stirred-tank reactors. The cell growth pattern in pilot-scale balloon-type bubble reactors (100–500 L) was the same as that in smaller bioreactors (20 L) [105]. However, this study seemed not to have noted whether the inner structure of such reactors could affect reactor performance [106]. When cell cultures of *T. chinensis* were transferred from shake flasks to bioreactors, taxol production was greatly reduced [107]. However, the incorporation of 18 ppm ethylene into the inlet air of a BCR caused the taxuyunnanine C content and volumetric production in the reactor to recover to maximum values of 13.28 mg g<sup>-1</sup> dry weight and 163.7 mg L<sup>-1</sup>, respectively, which were very similar to values obtained in shake flasks. Using a low-shear CIB, the quantitative effects of mixing time on suspension cultures of *T. chinensis* were demonstrated, and the favorable effect of more rapid mixing on taxol production was confirmed [108].

To date, no studies on camptothecin production by plant cell cultures in bioreactors have been reported; hence, this represents an important area for future research.

## 7.3.10

**Biosynthetic Pathway Mapping and Metabolic Engineering**

In order to develop an improved biological process, it is desirable to understand the biosynthetic pathway to produce the required product, the enzymes catalyzing those sequences of reactions (especially the rate-limiting steps), and the genes encoding these enzymes. In this respect, a molecular understanding for complete knowledge of the biosynthesis of secondary metabolites is necessary. Multipoint metabolic engineering by overexpression of the enzymes required for synthesis of the desired product and/or down-regulation of the genes leading to undesired or side products would greatly help in improving the production of these chemotherapeutics.

In the very early biosynthetic studies, radiolabeled precursors were fed to whole plants, but more recently plant cell cultures fed with stable isotope-labeled precursors have been used as the preferred model system. This allows analyses to be performed of labeled metabolites using advanced methods such as nuclear magnetic resonance (NMR) and mass spectrometry. The final step in the analysis of biosynthetic pathways is the identification of enzymes catalyzing individual bioconversions in cell-free systems, and of the genes coding for these enzymes.

**7.3.10.1 Biosynthesis of Podophyllotoxin**

The biosynthesis of podophyllotoxin in *Linum album* is not yet known completely, but is thought to be similar to that in *Forsythia intermedia*, *Podophyllum peltatum*, and *Linum flavum* [109]. The initial step of this biosynthesis is the dirigent protein-mediated formation of (+)-pinoresinol from two molecules of coniferyl alcohol. (+)-Pinoresinol serves as a substrate for an NADPH-dependent pinoresinol-lariciresinol reductase, which sequentially converts (+)-pinoresinol into (+)-lariciresinol and (–)-secoisolariciresinol. The latter is dehydrogenated into (–)-matairesinol by NAD-dependent secoisolariciresinol dehydrogenase. The subsequent pathway from (–)-matairesinol to either 6-methoxypodophyllotoxin (*L. flavum*) or podophyllotoxin (*L. album*) is still under investigation. The detailed biosynthetic pathway for podophyllotoxin production is illustrated in Figure 7.4.

Extensive studies have been carried out on the isolation and overexpression of genes involved in the biosynthesis of podophyllotoxin, but the alternative pathways for different metabolic fates of lignans in complex biosynthesis are still unknown. The important enzymes involved in biosynthesis of podophyllotoxin and their functions are listed in Table 7.8.

A 1207-bp cDNA of cinnamoyl-CoA reductase (CCR) encoding a polypeptide of 344 amino acids with a predicted molecular mass of 37.4 kDa was isolated from a ryegrass (*Lolium perenne*) stem cDNA library [110]. A cDNA encoding CCR was isolated from a cDNA library of *Linum album* [111], while a PCR screening method was used to obtain laccase-gene-specific sequences from the white-rot fungus *Trametes sanguinea* MU-2. The *kc1* cDNA was inserted into yeast vectors for heterologous expression by *Saccharomyces cerevisiae* and *Pichia pastoris* [112]. The molecu-

lar cloning and characterization of a *Eucalyptus globulus* genomic fragment encoding cinnamyl alcohol dehydrogenase (CAD) and isolation of the corresponding full-length cDNA from young stem material has already been reported [113]. Two cDNA full-length clones probably encoding the phenylalanine ammonia lyase (PAL) were isolated from a cDNA library of *Linum album* [114]. The enzymes PAL,

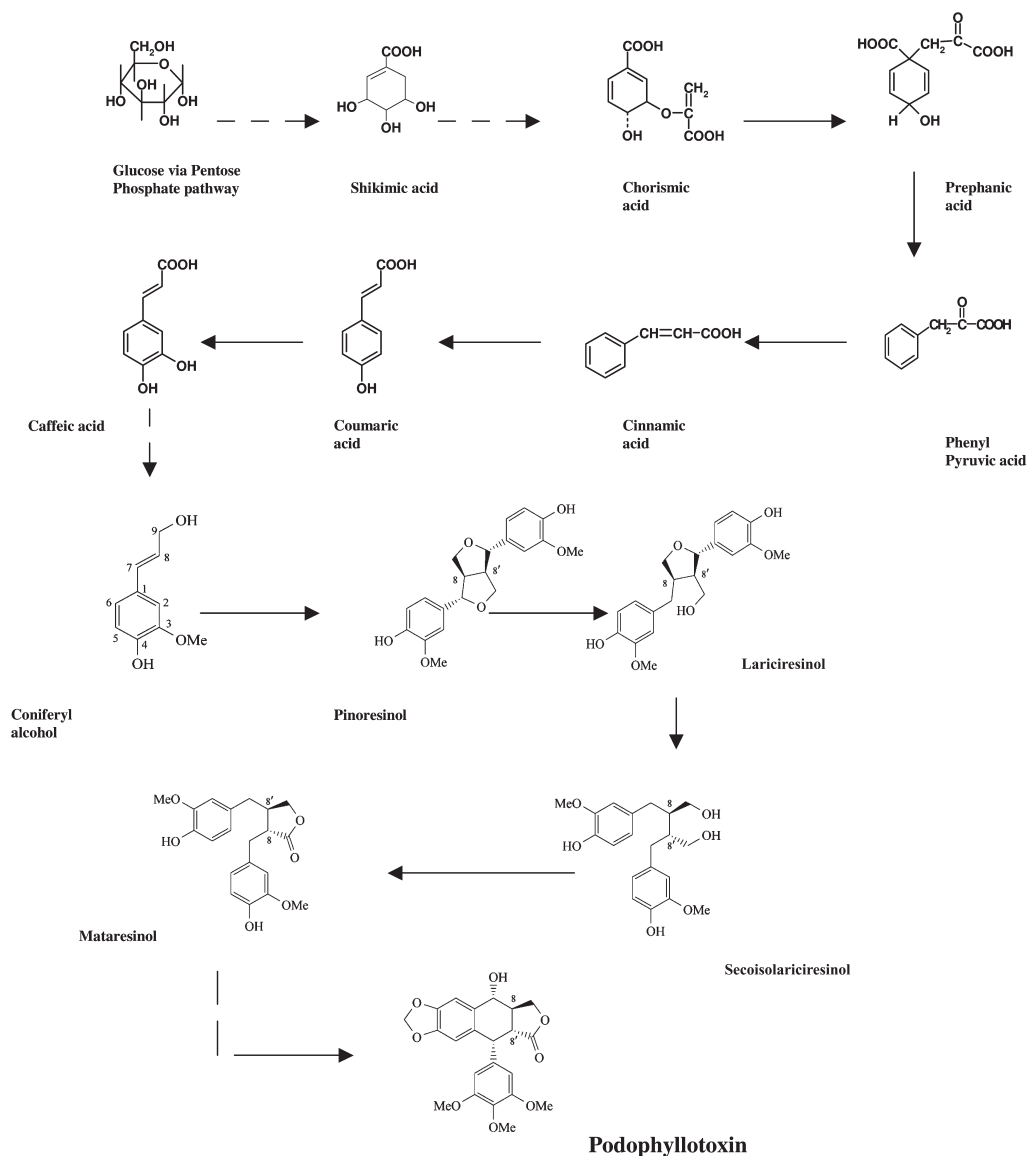


Fig. 7.4 Biosynthesis of podophyllotoxin (solid lines indicate single-step reactions; broken lines indicate multistep reactions).

**Table 7.8** Enzymes involved (and function) in the biosynthesis of podophyllotoxin.

<b>Serial no.</b>	<b>Enzyme involved</b>	<b>Function</b>	<b>Reference(s)</b>
1	3-deoxy-D-arabino-heptulosonate 7-phosphate synthase (DAHPS)	Key point of regulation of the shikimate pathway, involved in DAHP synthesis	177
2	Chorismate synthase (CS)	Elimination of phosphate from EPSP to form chorismate, and introduces the second double bond towards aromatization	177
3	Phenylalanine ammonia lyase (PAL)	Connects the primary metabolism with the secondary metabolism by catalyzing the entry point reaction from phenylalanine to <i>trans</i> -cinnamic acid.	178
4	4-Hydroxycinnamate:CoA ligase	Attachment of CoA to hydroxycinnamic acid	179
5	Cinnamoyl-CoA reductase (CCR)	Conversion of cinnamoyl-CoAs into their corresponding cinnamaldehydes	180
6	S-Adenosyl-L-methionine: caffeic acid methyl transferase	Transfer of a methyl group from S-adenosyl-L-methionine to the 3-hydroxyl group of caffeic acid to form ferrulic acid; also catalyzes the methylation of 5-hydroxy ferrulic acid to sinnapic acid	117
7	Cinnamoyl alcohol dehydrogenase (CAD)	Reducing the cinnamyl aldehydes ( <i>para</i> -coumaryl, coniferyl and sinapyl aldehydes) to the corresponding alcohols in the presence of NADPH	113
8	Caffeic acid 3-O-methyltransferase (COMT)	Methylation of caffeoylaldehyde to sinapyl alcohol formation	116
9	Caffeoyl CoA 3-O-methyltransferase (CCoAOMT)	3-O-methylation of caffeoyl CoA	116
10	Pinoresinol synthase	Stereo-specific phenoxy free-radical coupling reaction for pinoresinol synthesis	109
11	Pinoresinol-lariciresinol reductase	NADPH-dependent enzyme which sequentially converts (+)-pinoresinol into (+)-lariciresinol and (-)-secoisolariciresinol	116
12	Secoisolariciresinol dehydrogenase	Dehydrogenation of secoisolariciresinol into (-)-matairesinol via intermediate lactol	116
13	Cytochrome P450-dependent monooxygenase	Hydroxylation of deoxypodophyllotoxin (DOP) at the 5 position	179
14	Deoxypodophyllotoxin 7-hydroxylase	Conversion of deoxypodophyllotoxin to podophyllotoxin	181
15	Deoxypodophyllotoxin 6-hydroxylase	Conversion of deoxypodophyllotoxin to $\beta$ -peltatin	82, 183
16	SAM: $\beta$ -peltatin 6-O methyl transferase	Transfers a methyl group from S-adenosyl-L-methionine to the only free OH-group of $\beta$ -peltatin in position 6 thus forming $\beta$ -peltatin-A methylether	119
17	$\beta$ -peltatin-A methylether 7-hydroxylase	Hydroxylation of $\beta$ -peltatin-A methylether in position 7 to 6-methoxypodophyllotoxin	183
18	Laccases	Dehydrogenative polymerization of lignin	121



4-hydroxycinnamate: CoA ligase (4CL), cinnamoyl-CoA: NADP oxidoreductase and CAD were isolated from the cultures of *Linum album* [115]. Two different cDNAs with high homologies to known caffeic acid 3-*O*-methyltransferases (COMTs) were isolated, although a cDNA with homology to caffeoyl CoA 3-*O*-methyltransferase (CCoAOMT) has not yet been found [116]. A number of c-DNA clones encoding *S*-adenosyl-L-methionine: caffeic acid methyl transferases were isolated by a heterologous probe screening of  $\lambda$ ZapII c-DNA library constructed from m-RNA isolated from kinetin-induced suspension cultures of *Vanilla planifolia* [117]. Much of the overall biosynthetic pathway to podophyllotoxin in *Podophyllum peltatum* and *Linum flavum* has been established from the dirigent-mediated coupling of E-coniferyl alcohol and its subsequent conversions to 7-hydroxymatairesinol. Bifunctional pinoresinol/lariciresinol reductase genes were also isolated and cloned in the same study [109].

The ~32-kDa NAD-dependent secoisolariciresinol dehydrogenase gene was isolated from a *Forsythia intermedia* stem c-DNA library, and a homologous secoisolariciresinol dehydrogenase gene was also isolated from a *Podophyllum peltatum* rhizome cDNA library and expressed in *E. coli* [118]. *S*-Adenosyl-L-methionine:  $\beta$ -peltatin 6-*O*-methyltransferase was isolated and characterized from cell suspension cultures of *Linum nodiflorum* L. (Linaceae), a *Linum* species accumulating aryltetralin lignans such as 6-methoxypodophyllotoxin [119]. Characterization of deoxypodophyllotoxin 5-hydroxylase (dop5h), a cytochrome p450-dependent enzyme in lignan biosynthesis of *Linum* species cell cultures producing 5-methoxypodophyllotoxin (5-MPT), has been reported [120]. Five different laccase-encoding cDNA sequences were identified from ryegrass (*Lolium perenne*), four from the stem and one from meristematic tissue [121]. The down-regulation of cinnamoyl-CoA: NADP CCR in lignin biosynthesis leads to the reduction of lignin content [122].

#### 7.3.10.2 Biosynthesis of Paclitaxel

The diterpenoid skeleton of paclitaxel was shown [123] to be derived via the mevalonate-independent (1-deoxy-D-xylulose-5-phosphate) pathway [124–126]. The committed step in the biosynthesis of paclitaxel and other taxanes is represented by cyclization of the universal diterpenoid precursor geranylgeranyl diphosphate to taxa-4(5), 11(12)-diene [127]. This slow (but apparently not rate-limiting) reaction is catalyzed by taxadiene synthase [128]. The second specific step in taxane biosynthesis is considered to be the cytochrome P450-dependent hydroxylation at the C-5 position of the taxane ring, which is accomplished by allylic rearrangement of the 4(5) double bond to the 4(20) position to yield taxa-4(20),11(12)-diene-5 $\alpha$ -ol [129,130]. The taxadien-5 $\alpha$ -ol-*O*-acetyltransferase likely represents the third specific step of the taxol biosynthetic pathway, and is responsible for generating the 4(20)-en-5 $\alpha$ -acetoxy functional grouping that ultimately gives rise to the oxetane ring. Previous evaluations of the relative abundances of naturally occurring taxanes [131–133] have suggested that hydroxylations at positions C-5, C-10, C-9, and C-2 represent early steps of the paclitaxel pathway, which precede hydroxylation at C-13; and hydroxylation at the C-1 and C-7 positions of the taxane ring are consid-

ered to represent relatively late steps in paclitaxel biosynthesis. Such acylation reactions appear to occur early, as well as late, in the paclitaxel pathway. Acetylation at the C-5 hydroxyl group of the taxane core represents an early step in the biosynthesis of paclitaxel, whereas acetylation at the C-10 hydroxyl and benzylation at the C-2 hydroxyl represent later-stage transformations. As order of the oxygenation reactions of taxol biosynthesis, the precise sequence of the acylation reactions and timing of the epoxidation and ring expansion steps are not yet fully defined, and several routes to taxol synthesis may be possible. Hence, this remains an area for future exploration.

A detailed biogenesis of paclitaxel in plants is provided in Figure 7.5, and the enzymes involved in various steps of pathway, and their functions, are listed in Table 7.9.

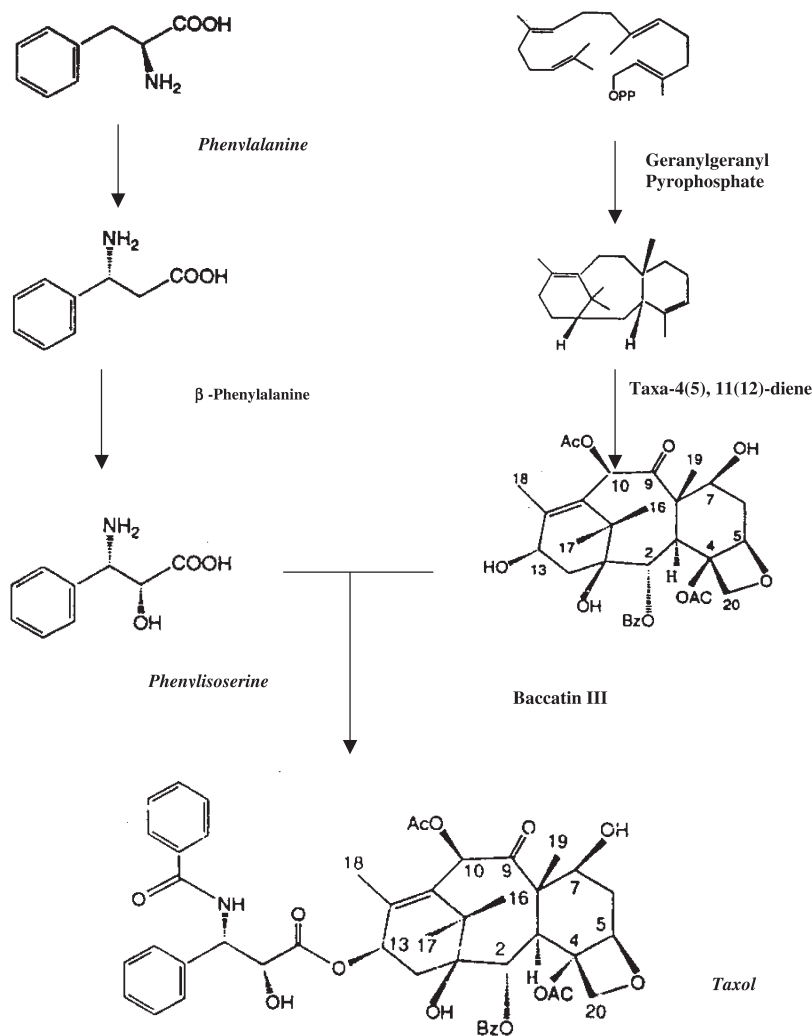


Fig. 7.5 Major steps in the biosynthesis of paclitaxel (Taxol).

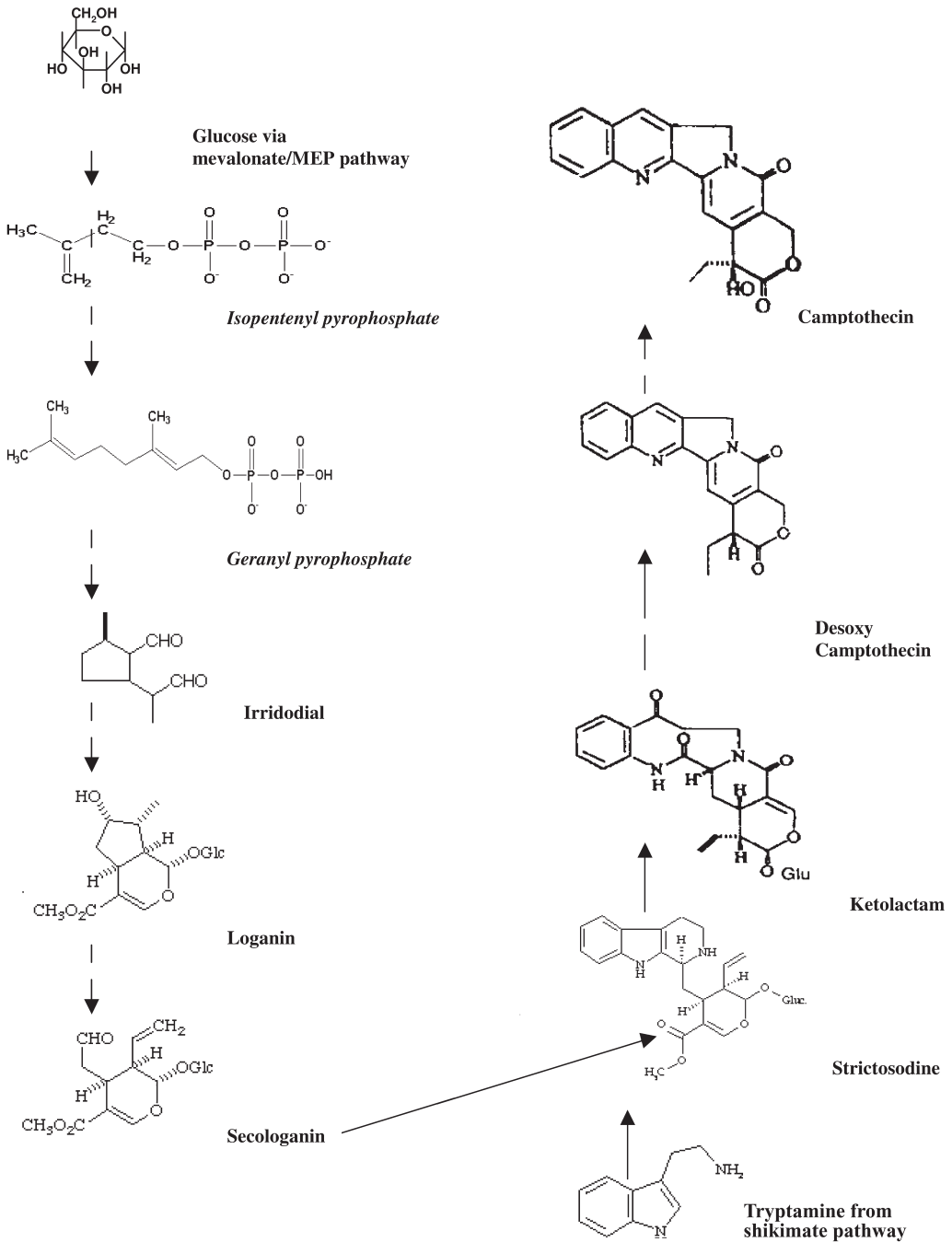
**Table 7.9** Enzymes involved (and their functions) in the biosynthesis of taxol.

Serial no.	Enzyme involved	Function	Reference(s)
1	Taxadiene synthase	Cyclization of the universal diterpenoid precursor geranylgeranyl diphosphate to taxa-4(5),11(12)-diene	127
2	Cytochrome P450 taxadiene 5 $\alpha$ -hydroxylase	Hydroxylation at the C-5 position of the taxane ring, which is accomplished by allylic rearrangement of the 4(5) double bond to the 4(20) position to yield taxa-4(20),11(12)-diene-5 $\alpha$ -ol	129, 130
3	Taxa-4(20),11(12)-dien-5 $\alpha$ -O-acetyl transferase	Responsible for generating the 4(20)-en-5 $\alpha$ -acetoxy functional grouping that ultimately gives rise to the oxetane ring	138
4	Cytochrome P450 taxane-13 $\alpha$ -hydroxylase	Hydroxylation of taxane ring at C-13 position	184
5	Cytochrome P450 taxane-10 $\beta$ -hydroxylase	Hydroxylation at the C-10 position	184

A homology-based PCR cloning strategy led to the isolation of a cDNA encoding taxadiene synthase from *T. brevifolia* [134]. A cytochrome P450-specific differential display of the mRNA-PCR method and a PCR-based homology-cloning strategy led to the isolation of full-length cytochrome P450 cDNA from *T. cuspidata* [135–137]. More recent studies employing the baculovirus–insect cell expression system identified a second cytochrome P450 cDNA clone capable of hydroxylating taxadien-5 $\alpha$ -ol at the C-13 position [137]. cDNA clones encoding all three of these taxane O-acetyltransferases have been identified. The taxadien-5 $\alpha$ -ol-O-acetyltransferase cDNA clone was obtained by a reverse genetic approach, based upon partial amino acid sequences derived from the corresponding purified protein [138–140]. The cDNAs encoding the 10-deacetylbaccatin-III-10 $\beta$ -O-acetyltransferase and the taxane-2 $\alpha$ -O-benzoyltransferase were identified by a homology-based PCR cloning strategy [139–141]. A method for the heterologous overexpression of cDNA encoding taxadiene synthase in *E. coli* using thioredoxin fusion expression system, which increases the solubility of expressed protein, is described in Chapter 13.

### 7.3.10.3 Biosynthesis of Camptothecin

Camptothecin, which is structurally grouped in the quinoline alkaloids, is biogenetically a modified monoterpene indole alkaloid (TIA). The common intermediate, from which a variety of TIAs are formed, is strictosidine; this is formed by the condensation of tryptamine with the iridoid glucoside, secologanin [142]. This condensation is catalyzed by strictosidine synthase (STR) [143, 144]. The detailed pathway for the first part of the biosynthesis leading to strictosidine was discussed



**Fig. 7.6** Biosynthesis of camptothecin (solid lines indicate single-step reactions; broken lines indicate multistep reactions).

earlier [145]. Subsequent intramolecular cyclization of strictosidine yields strictosamide; a penultimate precursor of camptothecin formation in *C. acuminata* is also reported [146]. As an alternative pathway from strictosidine, a variety of TIAs are derived from deglucosylated strictosidine, and the resulting reactive dialdehyde produces different types of TIAs, such as cathenamine in *Catharanthus roseus* [147]. The iridoid section of the pathway has still not been completely elucidated, but details of the biogenetic pathway for camptothecin production are provided in Figure 7.6, with details of the enzymes involved listed in Table 7.10.

Tryptophan decarboxylase (TDC) [145,148] and strictosidine synthase (STR) [145,149] have been studied extensively. TDC channels tryptophan from primary metabolism into the terpenoid indole alkaloid pathway, while STR couples tryptamine with secologanin, a product of the iridoid pathway. Both enzymes have been overexpressed in a number of plants and plant cells [150–154]. Expression of TDC and STR was coordinately regulated by elicitation, with jasmonate being the intermediate signal required, indicating that common regulators control these genes [155–158]. The cloning and characterization of cDNAs encoding STR (OpSTR) and TDC (OpTDC) – two key enzymes in the biosynthesis of monoterpene indole alkaloids from hairy roots of *O. pumila* – has already been carried out, and the cDNA coding for NADPH: cytochrome P450 reductase (OpCPR) – which is presumed to be indirectly involved in camptothecin synthesis – has also been isolated [159].

**Table 7.10** Enzymes involved (and their function) in the biosynthesis of camptothecin.

<b>Serial no.</b>	<b>Enzyme involved</b>	<b>Function</b>	<b>Reference(s)</b>
1	Tryptophan decarboxylase	Channels tryptophan from primary metabolism into terpenoid indole alkaloid pathway	145, 148
2	Geraniol 10 hydroxylase	Hydrolysis of geraniol at 10 <sup>th</sup> carbon	185
3	Primary alcohol dehydrogenase	Conversion of 10-hydroxygeraniol to 10-oxogeraniol	185
4	Cyclases	Cyclization of oxogeraniol to irridodial	185
5	Loganic acid methyl transferase	Conversion of loganic acid to loganin	185
6	Secologanin synthase	Formation of secologanin from loganin	185
7	Stroctisidine synthase	Condensation of tryptamine and secologanin to yield stroctisidine	143, 144
8	Stroctosamide synthase	Intramolecular recyclization of stroctisidine to yield stroctosamide	146
9	NADPH: cytochrome P450 reductase	Indirect involvement in camptothecin biosynthesis	159

## 7.4

### Future Prospects

Today, natural-product drugs play a dominant role in pharmaceutical care, especially in the case of antitumor agents. This increased demand for plant-based compounds for medicinal purposes, in association with low product yields and concerns about the destruction of plant-growing areas, has led to great strides being made in the large-scale production of pharmaceuticals using plant cell cultures. In this respect, the use of genetic tools has provided a clearer picture of biosynthetic pathway regulation, of secondary metabolism, and of signal transduction and elicitation. Hence, the optimization of production has moved from an empirical approach towards one of multiple productivity enhancements and synergistic effects. Ultimately, this approach should lead to significant reductions in the time taken to achieve optimal production of plant-based drugs at commercially acceptable and economic levels.

Metabolic engineering is important for the production of phytopharmaceuticals, and concise knowledge of the biosynthetic pathway and the responsible genes should allow cell cultures to be bioengineered to provide high and commercially sustainable production rates. This technology can be applied in two ways. First, the genes controlling the slow reaction steps can be overexpressed, thus raising production of the desired product(s). Second, by using antisense technology, the amounts of unwanted byproducts can be suppressed. This would result not only in an improved flux to the desired end product, but also a simplification of downstream purification processes. Moreover, pathways could be redirected to produce novel derivatives with a greater range and potency, and fewer adverse side effects.

Clearly, the successful industrial production of paclitaxel by plant cell cultures will trigger research into other plant-based chemotherapeutics such as podophyllo-toxin and camptothecin. Today, the metabolic fate of complexed lignans and details of multi-branched biosynthesis form the major area of concern for the production of chemotherapeutics on a commercial scale. Notably, the production of camptothecin by plant cell cultures will require much attention.

In conclusion, improvements in bioreactor design, the use of synergism, the development of *in-situ* product removal strategies, and an insight into the mechanisms that regulate the flux of precursors to desired end-products are the focal points of future research. Thus, the up-regulation of biosynthetic pathways using regulatory genes, and the development of short bioconversion pathways in microbes are the two main areas likely to be exploited for the production of plant-based chemotherapeutics.

## References

- 1 Farnsworth, N.R., Bingel, A.S. Problems and prospects of discovering new drugs from higher plants by pharmacological screening, Wagner, H., Wolff, P. (Eds.), *New natural products with pharmacological, biological or therapeutic activity*. Springer-Verlag, New York, 1977, pp. 1–22.
- 2 Principe, P.P. Moneterizing the pharmacological benefits of plants. In: Balick, M.J., Elisabetsky, E., Laird, S.A. (Eds.), *Medicinal Plant Resources of the Tropical Forest*. Columbia University Press, New York, 1996, pp. 191–218.
- 3 Cragg, G.M., Newman, D.J., Snader, K.M. Natural products in drug discovery and development. *J. Nat. Prod.* 1997, 60, 52–60.
- 4 Cragg, G.M., Newman, D.J. Antineoplastic agents from natural sources: Achievements and future directions. *Expert Opin. Investig. Drugs* 2000, 9, 2783–2797.
- 5 Pezzuto, J.M. Plant-derived anticancer agents. *Biochem. Pharmacol.* 1997, 53, 121–133.
- 6 Cragg, G.M., Scherpartz, S.A., Suffness, M., Grever, M.R. The Taxol supply crisis. New NCI policies for handling the large-scale production of novel natural product anticancer and anti-HIV agents. *J. Nat. Prod.* 1993, 56, 1657–1668.
- 7 Verpoorte, R., Contin, A., Memelink, J. Biotechnology for the production of plant secondary metabolites. *Phytochem. Rev.* 2002, 1, 13–25.
- 8 Kadkade, P.G. Formation of podophyllo-toxin by *Podophyllum peltatum* tissue cultures. *Naturwissenschaften* 1981, 68, 481–482.
- 9 Kadkade, P.G. Growth and podophyllo-toxin production in callus tissues of *Podophyllum peltatum*. *Plant Sci. Lett.* 1982, 25, 107–115.
- 10 Van Uden, W., Pras, N., Visser, J.F., Malingre, T.M. Detection and identification of podophyllotoxin produced by cell cultures derived from *Podophyllum hexandrum* Royle. *Plant Cell Rep.* 1989, 8, 165–168.
- 11 Heyenga, A.G., Lucas, J.A., Dewick, P.M. Production of tumor-inhibitory lignans in callus cultures of *Podophyllum hexandrum*. *Plant Cell Rep.* 1990, 9, 382–385.
- 12 Berlin, J., Bedorf, N., Molleschott, C., Wray, V., Sasse, F., Hofle, G. On the podophyllotoxins of root cultures of *Linum flavum*. *Planta Med.* 1988, 54, 204–206.
- 13 Van Uden, W., Pras, N., Batterman, S., Visser, J.F., Malingre, T.M. The accumulation and isolation of coniferin from a high-producing cell suspension of *Linum flavum* L. *Planta* 1990, 183, 25–30.
- 14 Smolnly, T., Wichers, H., De-Rijk, T., Van-Zwam, A., Shahsavari, A., Alfermann, A.W. Formation of lignans in suspension cultures of *Linum album*. *Planta Med.* 1992, 58, A622–A624.
- 15 Wichers, H.J., Versluis-de-Haan, G.G., Marsman, J.W., Harkes, M.P. Podophyllotoxin related lignans in plants and cell cultures of *Linum flavum*. *Phytochemistry* 1991, 30, 3601–3604.
- 16 Muranaka, T., Miyata, M., Kazutaka, I., Tachibana, S. Production of podophyllo-toxin in *Juniperus chinensis* callus cultures treated with oligosaccharides and a biogenetic precursor. *Phytochemistry* 1998, 49, 491–496.
- 17 Woerdenbag, H.J., van Uden, W., Frijlink, H.W., Lerk, C.F., Pras, N., Malingre, T.M. Increased podophyllo-toxin production in *Podophyllum hexandrum* cell suspension cultures after feeding coniferyl alcohol as a beta-cyclodextrin complex. *Plant Cell Rep.* 1990, 9, 97–100.
- 18 Chattopadhyay, S., Srivastava, A.K., Bhojwani, S.S., Bisaria, V.S. Development of suspension culture of *Podophyllum hexandrum* for the production of podophyllotoxin. *Biotechnol Lett.* 2001, 23, 2063–2066.
- 19 Fett-Neto, A.G., Melanson, S.J., Nicholson, S.A., Pennington, J.J., Dicosmo, F. Improved taxol yield by aromatic carboxylic acid and amino acid feeding to cell cultures of *Taxus cuspidata*. *Biotechnol Bioeng.* 1994, 44, 967–971.
- 20 Wickremesinhe, E.R.M., Arteca, R.N. *Taxus* cell suspension cultures:

- optimizing growth and production of Taxol. *J. Plant Physiol.* **1994**, *144*, 183–188.
- 21 Kim, J.H., Yun, J.J., Hwang, Y.S., Byun, S.Y., Kim, D.I. Production of Taxol and related taxanes in *Taxus brevifolia* cell cultures: effect of sugar. *Biotechnol Lett.* **1995**, *17*, 101–106.
  - 22 Pestchanker, L., Roberts, S.C., Shuler, M.L. Kinetics of taxol production and nutrient use in suspension cultures of *Taxus cuspidata* in shake flasks and a Wilson-type bioreactor. *Enzyme Microb. Tech.* **1996**, *19*, 256–260.
  - 23 Hirasuna, T.J., Pestchanker, L.J., Srinivasan, V., Shuler, M.L. Taxol production in suspension cultures of *Taxus baccata*. *Plant Cell Tissue Organ Cult.* **1996**, *44*, 95–102.
  - 24 Ketchum, R.E.B., Gibson, D.M. Paclitaxel production in suspension cell cultures of *Taxus*. *Plant Cell Tissue Organ Cult.* **1996**, *46*, 9–16.
  - 25 Bringi, V., Kadkade, P.G., Prince, C.L., Schubmehl, B.F., Kane, E.J., Roach, B. Enhanced production of Taxol and taxanes by cell cultures of *Taxus* species (1995) US Patent 5407816.
  - 26 Yakimune, Y., Tabata, H., Higashi, Y., Hara, Y. Methyl jasmonate-induced overproduction of paclitaxel and baccatin III in *Taxus* cell suspension cultures. *Nat. Biotechnol.* **1996**, *14*, 1129–1132.
  - 27 Parc, G., Canaguier, A., Landre, P., Hocquemiller, R., Chriqui, D., Meyer, M. Production of taxoids with biological activity by plants and callus culture from selected *Taxus* genotypes. *Phytochemistry* **2002**, *59*, 725–730.
  - 28 Fulzele, D.P., Satdive, R.K., Pol, B.B. Growth and production of camptothecin by cell suspension cultures of *Nothapodytes foetida*. *Planta Med.* **2001**, *67*, 150–152.
  - 29 Sakato, K., Misawa, M. Effects of chemical and physical conditions on growth of *Camptotheca acuminata* cell cultures. *Agric. Biol. Chem.* **1974**, *38*, 491–497.
  - 30 Van Hengal, A.J., Harkes, M.P., Witchers, H.J., Hesselinc, P.G.M., Buitglaar, R.M. Characterization of callus formation and camptothecin production by cell lines of *Camptotheca acuminata*. *Plant Cell Tissue Organ Cult.* **1992**, *28*, 11–18.
  - 31 Wiedenfeld, H., Furmanowa, M., Roeder, E., Guzewska, J., Gustowski, W. Camptothecin and 10-hydroxycamptothecin in callus and plantlets of *Camptotheca acuminata*. *Plant Cell Tissue Organ Cult.* **1997**, *49*, 213–218.
  - 32 Sakata, K., Morita, E., Takezono, T. Annual Meeting of the Society of Agricultural Chemistry. Fukuoka, Japan, March 30, **1990**.
  - 33 Arumugam, N., Bhojwani, S.S. Somatic embryogenesis in tissue cultures of *Podophyllum hexandrum*. *Can. J. Bot.* **1990**, *68*, 487–491.
  - 34 Nadeem, M., Palni, L.M.S., Purohit, A.N., Pandey, H., Nandi, S.K. Propagation and conservation of *Podophyllum hexandrum* Royle: an important medicinal herb. *Biol. Conserv.* **2000**, *92*, 121–129.
  - 35 Moraes-Cerdeira, R.M., Burandt, C.L., Jr, Bastos, J.K., Nanayakkara, N.P.D., McChesney, J.D. *In vitro* propagation of *Podophyllum peltatum*. *Planta Med.* **1998**, *64*, 42–46.
  - 36 Van Uden, W., Homan, B., Woerdenbag, H.J., Pras, N., Malingre, T.M., Wichers, H.J. Isolation, purification and cytotoxicity of 5-methoxypodophyllotoxin, a lignan from a root culture of *Linum flavum*. *J. Nat. Prod.* **1992**, *55*, 102–110.
  - 37 Van Uden, W., Pras, N., Homan, B., Malingre, T.M. Improvement of the production of 5-methoxypodophyllotoxin using a new selected root culture of *Linum flavum* L. *Plant Cell Tissue Organ Cult.* **1991**, *27*, 115–121.
  - 38 Giri, A., Giri, C.C., Dhingra, V., Narasu, M.L. Enhanced podophyllotoxin production from *Agrobacterium rhizogenes* transformed cultures of *Podophyllum hexandrum*. *Nat. Prod. Lett.* **2001**, *15*, 229–235.
  - 39 Oostdam, A., Mol, J.N.M., van der Plas, L.H.W. Establishment of hairy root cultures of *Linum flavum* producing the lignan 5-methoxypodophyllotoxin. *Plant Cell Rep.* **1993**, *12*, 474–477.
  - 40 Lin, H., Kwok, K.H., Doran, P.M. Production of podophyllotoxin using cross-species coculture of *Linum flavum* hairy roots and *Podophyllum hexandrum* cell suspensions. *Biotechnol. Prog.* **2003**, *19*, 1417–1426.



- 41 Han, K.H., Fleming, P., Walker, K., Loper, M., Chilton, W.S., Mocek, U., Gordon, M.P., Floss, H.G. Genetic transformation of mature *Taxus*: an approach to genetically control the *in vitro* production of the anticancer drug, taxol. *Plant Sci.* **1994**, *95*, 187–196.
- 42 Roja, G., Heble, M.R. The quinoline alkaloids camptothecin and 9-methoxycamptothecin from tissue cultures and mature trees of *Nothapodytes foetida*. *Phytochemistry* **1994**, *36*, 65–66.
- 43 Kitajima, M., Fischer, U., Nakamura, M., Ohsawa, M., Ueno, M., Takayama, H., Unger, M., Stöckigt, J., Aimi, N. Anthraquinones from *Ophiorrhiza pumila* tissue and cell cultures. *Phytochemistry* **1998**, *48*, 107–111.
- 44 Van Uden, W., The biotechnological production of podophyllotoxin and related cytotoxic lignans by plant cell cultures. *Pharm. World Sci.* **1993**, *15*, 41–43.
- 45 Chattopadhyay, S., Srivastava, A.K., Bisaria, V.S. Optimization of culture parameters for production of podophyllotoxin in suspension culture of *Podophyllum hexandrum*. *Appl. Biochem. Biotechnol.* **2002**, *102/103*, 381–393.
- 46 Chattopadhyay, S., Srivastava, A.K., Bhojwani, S.S., Bisaria, V.S. Production of podophyllotoxin by plant cell cultures of *Podophyllum hexandrum* in bioreactor. *J. Ferment. Bioeng.* **2002**, *93*, 215–220.
- 47 Chattopadhyay, S., Mehra, R.S., Srivastava, A.K., Bhojwani, S.S., Bisaria, V.S. Effect of major nutrients on podophyllotoxin production in *Podophyllum hexandrum* suspension cultures. *Appl. Microbiol. Biotechnol.* **2003**, *60*, 541–546.
- 48 Wang, Z.Y., Zhong, J.J. Combination of conditioned medium and elicitation enhances taxoid production in bioreactor cultures of *Taxus chinensis* cells. *Biochem. Eng. J.* **2002**, *12*, 93–97.
- 49 Choi, H.K., Kim, S.I., Son, J.S., Hong, S.S., Lee, H.S., Chung, I.S., Lee, H.J. Intermittent maltose feeding enhances paclitaxel production in suspension culture of *Taxus chinensis* cells. *Biotechnol. Lett.* **2000**, *22*, 1793–1796.
- 50 Mirjalili, N., Linden, J.C. Gas phase composition effects on suspension cultures of *Taxus cuspidata*. *Biotechnol. Bioeng.* **1995**, *48*, 123–132.
- 51 Linden, J.C., Haigh, J.R., Mirjalili, N., Phisaphalong, M. Gas concentration effects on secondary metabolite production by plant cell cultures. *Adv. Biochem. Eng. Biotechnol.* **2001**, *72*, 28–62.
- 52 Smith, M.A.L. Large-scale production of secondary metabolites. In: Terzi, M., Cella, R., Falavigna, A. (Eds.), *Current Issues in Plant Molecular and Cellular Biology*. Kluwer Academic Publishers, Dordrecht, The Netherlands, **1995**, pp. 669–674.
- 53 Stierle, A., Strobel, G., Stierle, D. Taxol and taxane production by *Taxomyces andreanae*, an endophytic fungus of pacific yew. *Science* **1993**, *260*, 214–216.
- 54 Altstadt, T.J., Fairchild, C.R., Golik, J., Johnston, K.A., Kadow, J.F., Lee, F.Y., Long, B.H., Rose, W.C., Vyas, D.M., Wong, H., Wu, M.J., Wittman, M.D. Synthesis and antitumor activity of novel C-7 paclitaxel ethers: discovery of BMS-184476. *J. Med. Chem.* **2001**, *44*, 4577–4583.
- 55 Pezzutto, J.M. Taxol production in plant cell culture comes of age. *Nat. Biotechnol.* **1996**, *14*, 1083.
- 56 Van Uden, W., Pras, N., Malingre, T.M. On the improvement of the podophyllotoxin production by phenylpropanoid precursor feeding to cell cultures of *Podophyllum hexandrum* Royle. *Plant Cell Tissue Organ Cult.* **1990**, *23*, 217–224.
- 57 Fett-Neto, A.G., Dicosmo, F., Reynolds, W.F., Sakata, K. Cell culture of *Taxus* as a source of the antineoplastic drug taxol and related taxanes. *Biotechnology* **1992**, *10*, 1572–1575.
- 58 Van Uden, W., Pras, N., Malingre, T.M. The accumulation of podophyllotoxin- $\beta$ -D-glucoside by cell suspension cultures derived from the conifer *Callitris drummondii*. *Plant Cell Rep.* **1990**, *9*, 257–260.
- 59 Wang, H.Q., Yu, J.T., Zhong, J.J. Significant improvement of taxane production in suspension cultures of *Taxus chinensis* by sucrose feeding strategy. *Process Biochem.* **2000**, *35*, 479–483.
- 60 Luo, J., Mei, X., Liu, L., Hu, D.W. Improved paclitaxel production by fed-

- batch suspension cultures of *Taxus chinensis* in bioreactors. *Biotechnol. Lett.* **2002**, *24*, 561–565.
- 61 Fleming, P.E., Knaggs, A.R., He, X.G., Mocek, U., Floss, H.G. Biosynthesis of taxoids. Mode of attachment of the taxol side chain. *J. Am. Chem. Soc.* **1994**, *116*, 4137.
- 62 Srinivasan, V., Ciddi, V., Bringi, V., Shuler, M.L., Metabolic inhibitors, elicitors, and precursors as tools for probing yield limitation in taxane production by *Taxus chinensis* cell cultures. *Biotechnol. Prog.* **1996**, *12*, 457–465.
- 63 Strobel, G.A., Stierle, A., Vankujik, F.J.G.M. Factors influencing the *in vitro* production of radiolabelled taxol by pacific yew, *Taxus brevifolia*. *Plant Sci.* **1992**, *84*, 65–74.
- 64 Mamatha, R. Studies in tissue cultures of taxus species and other higher plants. PhD thesis, Kakatiya University, Warangal, A.P., India, **2000**.
- 65 Silvestrine, A., Pasqua, G., Botta, B., Monacelli, B., Van der Heijden, R., Verpoorte, R. Effects of alkaloid precursor feeding on a *Camptotheca acuminata* cell line. *Plant Physiol.* **2002**, *40*, 749–753.
- 66 Aapro, M. Docetaxel versus doxorubicin in patients with metastatic breast cancer who have failed alkylating chemotherapy: a preliminary report of the randomized phase III trial. *Semin. Oncol.* **1998**, *25*, 7–11.
- 67 Schmitt, J., Petersen, M. Influence of methyl jasmonate and coniferyl alcohol on pinoresinol and matairesinol accumulation in a *Forsythia intermedia* suspension culture. *Plant Cell Rep.* **2002**, *20*, 885–889.
- 68 Van Furden, B., Humburg, A., Fuss, E. Influence of methyl jasmonate on podophyllotoxin and 6-methoxypodophyllotoxin accumulation in *Linum album* cell suspension cultures. *Plant Cell Rep.* **2005**, *24*, 312–317.
- 69 Shams-Ardakani, M., Hemmati, S., Mohagheghzadeh, A. Effect of elicitors on the enhancement of podophyllotoxin biosynthesis in suspension cultures of *Linum album*. *DARU* **2005**, *13*, 56–60.
- 70 Yu, L.J., Lan, W.Z., Qin, W.M., Jin, W.W., Xu, H.B. Oxidative stress and taxol production induced by fungal elicitor in cell suspension cultures of *Taxus chinensis*. *Biol. Plant. (Prague)* **2002**, *45*, 459–461.
- 71 Yuan, Y.J., Li, C., Hu, Z.D., Wu, J.C. A double oxidative burst for taxol production in suspension cultures of *Taxus chinensis* var. *mairei* induced by oligosaccharide from *Fusarium oxysprum*. *Enzyme Microb. Technol.* **2002**, *30*, 774–778.
- 72 Yuan, Y.J., Li, C., Hu, Z.D., Wu, J.C., Zeng, A.P. Fungal elicitor-induced cell apoptosis in suspension cultures of *Taxus chinensis* var. *mairei* for taxol production. *Process Biochem.* **2002**, *38*, 193–198.
- 73 Mirajilili, N., Linden, J.C. Methyl jasmonate induced production of taxol in suspension cultures of *Taxus cuspidate*: ethylene interaction and induction models. *Biotechnol. Prog.* **1996**, *12*, 110–118.
- 74 Ketchum, R.E.B., Gibson, D.M., Croteau, R.B., Shuler, M.L. The kinetics of taxoid accumulation in cell suspension cultures of *Taxus* following elicitation with methyl jasmonate. *Biotechnol. Bioeng.* **1999**, *62*, 97–105.
- 75 Baebler, S., Camloh, M., Kovac, M., Ravnikar, M., Zel, J. Jasmonic acid stimulates taxane production in cell suspension culture of yew (*Taxus media*). *Planta Med.* **2002**, *68*, 475–476.
- 76 Yuan, Y.J., Hu, G.W., Wang, C.G., Jing, Y., Zhou, Y.Q., Shen, P.W. Effect of rare earth compounds on the growth, taxol biosynthesis and release in *Taxus cuspidata* cell culture. *J. Chin. Rare Earth Soc.* **1998**, *16*, 56–60.
- 77 Wu, J., Wang, C., Mei, X. Stimulation of taxol production and excretion in *Taxus* spp. cell cultures by rare earth chemical lanthanum. *J. Biotechnol.* **2001**, *85*, 67–73.
- 78 Ciddi, V., Srinivasan, V., Shuler, M.L. Elicitation of *Taxus* sp. cell cultures for production of taxol. *Biotechnol. Lett.* **1995**, *17*, 1343–1346.
- 79 Wang, C., Wu, J., Mei, X. Enhanced taxol production and release in *Taxus chinensis*

- cell suspension cultures with selected organic solvents and sucrose feeding. *Biotechnol. Prog.* **2001**, *17*, 89–94.
- 80 Yu, L.J., Lan, W.Z., Qin, W.M., Xu, B.H. Effects of salicylic acid on fungal elicitor induced membrane-lipid peroxidation and taxol production in cell suspension cultures of *Taxus chinensis*. *Process Biochem.* **2001**, *37*, 477–482.
- 81 Dong, H.D., Zhong, J.J. Enhanced taxane production in bioreactor cultivation of *Taxus chinensis* cells by combining elicitation, sucrose feeding and ethylene incorporation. *Enzyme Microb. Technol.* **2002**, *31*, 116–121.
- 82 Cusido, R.M., Palazo, M., Bonfill, M., Navia-Osorio, A., Morales, M., Pinol, M.T. Improved paclitaxel and baccatin III production in suspension cultures of *Taxus media*. *Biotechnol. Prog.* **2002**, *18*, 418–423.
- 83 Zhang, C.H., Wu, J.Y. Ethylene inhibitors enhance elicitor-induced paclitaxel production in suspension cultures of *Taxus* spp. cells. *Enzyme Microb. Technol.* **2003**, *32*, 71–77.
- 84 Laskaris, G., Bounkhay, M., Theodoridis, G., Van der Heijden, R., Verpoorte, R., Jaziri, M. Induction of geranylgeranyl diphosphate synthase activity and taxane accumulation in *Taxus baccata* cell cultures after elicitation by methyl jasmonate. *Plant Sci.* **1999**, *147*, 1–8.
- 85 Luo, J., He, G.Y. Optimization of elicitors and precursors for paclitaxel production in cell suspension culture of *Taxus chinensis* in the presence of nutrient feeding. *Process Biochem.* **2004**, *39*, 1073–1079.
- 86 Khosroushahi, A.Y., Valizadeh, M., Ghasempour, A., Khosrowshahli, M., Naghdibadi, M., Dadpour, M.R., Omid, Y. Improved Taxol production by combination of inducing factors in suspension cell culture of *Taxus baccata*. *Cell Biol. Inter.* **2005**, *30*, 262–269.
- 87 Kwon, I.C., Yoo, Y.J., Lee, J.H., Hyun, J.O. Enhancement of taxol production by *in situ* recovery of product. *Process Biochem.* **1998**, *33*, 701–707.
- 88 Kondo, O., Honda, H., Taya, M., Kobayashi, T. Comparison of growth properties of carrot hairy root in various bioreactors. *Appl. Microbiol. Biotechnol.* **1989**, *32*, 291–294.
- 89 Kutney, J.P., Hewitt, G., Jarvis, T.C., Palaty, J., Retting, S.J. Studies with plant cell cultures of *Catharanthus roseus*. Oxidative coupling of dibenzylbutanolides catalyzed by plant cell culture extracts. *Can. J. Chem.* **1992**, *70*, 2115–2133.
- 90 Van Uden, W., Holidi Oeij, K., Woerdenbag, H.J., Pras, N. Glucosylation of cyclodextrin-complexed podophyllotoxin by cell cultures of *Linum flavum*. *Plant Cell Tissue Organ Cult.* **1993**, *34*, 169–175.
- 91 Kutney, J.P. Biotechnology and synthetic chemistry routes to clinically important compounds. *Pure Appl. Chem.* **1999**, *71*, 1025–1032.
- 92 Puricelli, L., Caniato, R., Delle Monache, G. Biotransformation of a dibenzylbutanolide to podophyllotoxin analogues by shoot cultures of *Haplophyllum patavinum*. *Chem. Pharm. Bull.* **2003**, *51*, 848–850.
- 93 Koulman, A., Beekman, A.C., Pras, N., Quax, J.W. The bioconversion process of deoxypodophyllotoxin with *Linum flavum* cell cultures. *Planta Med.* **2003**, *69*, 739–744.
- 94 Chen, T.S., Li, X., Bollag, D., Liu, Y.C., Chang, C.J. Biotransformation of taxol. *Tetrahedron Lett.* **2001**, *42*, 3787–3789.
- 95 Hamada, H., Furaya, T. Recent advances in plant biotransformation. *Plant Tiss. Cult. Biotech.* **1996**, *2*, 52–60.
- 96 Veeresham, C., Rao, M.A., Babu, P.C., Mamatha, R., Kokate, C.K. Biotransformation of paclitaxel (Taxol) by plant cell cultures. *Indian Drugs* **2000**, *37*, 86–89.
- 97 Chattopadhyay, S., Bisaria, V.S., Srivastava, A.K. Enhanced production of podophyllotoxin by *Podophyllum hexandrum* using *in situ* cell retention bioreactor. *Biotechnol. Prog.* **2003**, *19*, 1026–1028.
- 98 Chattopadhyay, S., Bisaria, V.S., Bhojwani, S.S., Srivastava, A.K. Enhanced production of podophyllotoxin by fed-batch cultivation of *Podophyllum hexandrum*. *Can. J. Chem. Eng.* **2003**, *81*, 1–8.

- 99 Arroo, R.R.J., Alfermann, A.W., Medarde, M., Petersen, M., Pras, N., Woolley, J.G. Plant cell factories as a source for anti-cancer lignans. *Phytochem. Rev.* **2002**, *1*, 27–35.
- 100 Srinivasan, V.L., Pestchanker, L., Moser, S., Hirasuna, T., Tatleck, R.A., Schular, M.L. Taxol production in bioreactors: Kinetics of biomass accumulation, nutrient uptake, and taxol production by cell suspensions of *Taxus baccata*. *Biotech. Bioeng.* **1995**, *47*, 666–676.
- 101 Seki, M., Ohzora, C., Takede, M., Furasaki, S. Taxol (paclitaxel) production using free and immobilized cells of *Taxus cuspidata*. *Biotech. Bioeng.* **1997**, *53*, 214–219.
- 102 Wang, S.J., Zhong, J.J. A novel centrifugal impeller bioreactor. I. Fluid circulation, mixing, and liquid velocity profiles. *Biotechnol. Bioeng.* **1996**, *51*, 511–519.
- 103 Zhong, J.J., Wang, S.J., Wang, H.Q. A new centrifugal impeller reactor and its application to plant cell cultures. In: *Horizon of biochemical engineering*. The Society of Chemical Engineers, Japan, Tokyo, **1997**, pp. 175–179.
- 104 Navia-Osorio, A., Garden, H., Cusido, R.M., Palazon, J., Alfermann, A.W., Pinol, M.T. Taxol and baccatin III production in suspension cultures of *Taxus baccata* and *Taxus wallichiana* in an airlift bioreactor. *J. Plant Physiol.* **2002**, *159*, 97–102.
- 105 Son, S.H., Choi, S.M., Lee, Y.H., Choi, K.B., Yun, S.R., Kim, J.K., Park, H.J., Kwon, O.W., Noh, E.W., Seon, J.H., Park, Y.G. Large-scale growth and taxane production in cell cultures of *Taxus cuspidata* (Japanese yew) using a novel bioreactor. *Plant Cell Rep.* **2000**, *19*, 628–633.
- 106 Hu, W.W., Zhong, J.J. Effect of bottom clearance on performance of airlift bioreactor in high-density culture of *Panax notoginseng* cells. *J. Biosci. Bioeng.* **2001**, *92*, 389–392.
- 107 Pan, Z.W., Wang, H.Q., Zhong, J.J. Scale-up study on suspension cultures of *Taxus chinensis* cells for production of taxane diterpene. *Enzyme Microb. Technol.* **2000**, *27*, 714–723.
- 108 Zhong, J.J., Pan, Z.W., Wang, Z.Y., Wu, J.Y., Chen, F., Takagi, M., Yoshida, A.T. Effect of mixing time on taxoid production in suspension cultures of *Taxus chinensis* in a centrifugal impeller bioreactor. *J. Biosci. Bioeng.* **2002**, *94*, 244–250.
- 109 Xia, Z.Q., Costa, M.A., Proctor, J., Davin, L.B., Lewis, N.G. Dirigent-mediated podophyllotoxin biosynthesis in *Linum flavum* and *Podophyllum peltatum*. *Phytochemistry* **2000**, *55*, 537–549.
- 110 Larsen, K. Cloning and characterization of a ryegrass (*Lolium perenne*) gene encoding cinnamoyl-CoA reductase (CCR). *Plant Sci.* **2004**, *166*, 569–581.
- 111 Windhövel, J., Fuss, E., Alfermann, A.W. The biosynthesis of lignans in *Linum album*: Cinnamoyl-CoA: NADP oxidoreductase: Abstract (Biochemistry) (2001) [www.biologie.uni-erlangen.de/pharmabiol/Abstract/Biochemistry](http://www.biologie.uni-erlangen.de/pharmabiol/Abstract/Biochemistry).
- 112 Hoshida, H., Nakao, M., Kazava, N., Kubo, K., Hakukawa, T., Morimasa, K., Akada, R., Nishizawa, Y. Isolation of five lactase gene sequences from the white-rot fungus *Trametes sanguinea* by PCR, and cloning, characterization and expression of the laccase cDNA in yeasts. *J. Biosci. Bioeng.* **2001**, *92*, 372–380.
- 113 De Melis, L.E., Whiteman, P.H., Stevenson, T.W. Isolation and characterisation of a cDNA clone encoding cinnamyl alcohol dehydrogenase in *Eucalyptus globulus* Labill. *Plant Sci.* **1999**, *143*, 173–182.
- 114 Schwelm, A., Fuss, E., Schönell, B., Windhövel, J., Alfermann, A.W. The biosynthesis of cytotoxic lignans in *Linum album*: phenylalanine ammonia lyase and cinnamoyl alcohol dehydrogenase: Abstract (Biochemistry) (2001) [www.biologie.uni-erlangen.de/pharmabiol/Abstract/Biochemistry](http://www.biologie.uni-erlangen.de/pharmabiol/Abstract/Biochemistry).
- 115 Seidel, V., Windhövel, J., Eaton, G., Alfermann, A.W., Arroo, R.R.J., Woolley, J.G. Podophyllotoxin biosynthesis in *Linum album* cell cultures – the role of phenylpropanoid ring substitution patterns: Abstract (Biochemistry) (2001) [www.biologie.uni-erlangen.de/pharmabiol/Abstract/Biochemistry](http://www.biologie.uni-erlangen.de/pharmabiol/Abstract/Biochemistry).
- 116 Hegener, U., Fuss, E., Alfermann, A.W. Biosynthesis of cytotoxic lignans in *Linum album*: caffeic acid 3-O-methyltransferase: Abstract (Biochemistry)

- (2001) www.biologie.uni-erlangen.de/pharmabiol/Abstract/Biochemistry.
- 117 Xue, Z., Brodellius, P. Kinetin induced caffeic acid O-methyltransferases in cell suspension cultures of *Vanilla planifolia* Andr. and isolation of caffeic acid O-methyltransferases cDNAs. *Plant Physiol. Biochem.* **1998**, *36*, 779–788.
- 118 Xia, Z.Q., Costa, M.A., Pellisier, H., Davin, L.B., Lewis, N.G. Secoisolaricresinol dehydrogenase purification, cloning and functional expression. *J. Biol. Chem.* **2001**, *276*, 12614–12623.
- 119 Kranz, K., Petersen, M.  $\beta$ -Peltatin 6-O-methyltransferase from suspension cultures of *Linum nodiflorum*. *Phytochemistry* **2003**, *64*, 453–458.
- 120 Kuhlmann, S., Molog, G., Empt, U., Van Uden, W., Pras, N., Alfermann, A.W., Petersen, M. characterisation of deoxypodophyllotoxin 5-hydroxylase (dop5h), a cytochrome p450-dependent enzyme in lignan biosynthesis of *Linum* species: Abstract (Biochemistry) (2001) www.biologie.uni-erlangen.de/pharmabiol/Abstract/Biochemistry.
- 121 Gavnholt, B., Larsen, K., Rasmussen, S.K. Isolation and characterisation of laccase cDNAs from meristematic and stem tissues of ryegrass (*Lolium perenne*). *Plant Sci.* **2002**, *162*, 873–885.
- 122 Piquemal, J., Lapierre, C., Myton, K., O'Connell, A., Schuch, W., Grima-Pettenati, J., Boudet, A.M. Down-regulation of cinnamoyl-CoA reductase induces significant changes of lignin profiles in transgenic tobacco plants. *Plant J.* **1998**, *13*, 71–83.
- 123 Eisenreich, W., Menhard, B., Hylands, P.J., Zenk, M.H., Bacher, A. Studies on the biosynthesis of Taxol: the taxane carbon skeleton is not of mevalonoid origin of special interest. *Proc. Natl. Acad. Sci. USA* **1996**, *93*, 6431–6436.
- 124 Rohmer, M., Knani, M., Simonin, P., Sutter, B., Sahm, H. Isoprenoid biosynthesis in bacteria: a novel pathway for the early steps leading to isopentenyl diphosphate. *Biochem. J.* **1993**, *295*, 517–524.
- 125 Lichtenthaler, H.K., Rohmer, M., Schwender, J. Two independent biochemical pathways for isopentenyl diphosphate and isoprenoid biosynthesis in higher plants. *Physiol. Plant.* **1997**, *101*, 643–652.
- 126 Lichtenthaler, H.K. The 1-deoxy-D-xylulose-5-phosphate pathway of isoprenoid biosynthesis in plants. *Annu. Rev. Plant Physiol. Plant Mol. Biol.* **1999**, *50*, 47–65.
- 127 Koepp, A.E., Hezari, M., Zajicek, J., Vogel, B.S., Lafever, R.E., Lewis, N.G., Croteau, R. Cyclization of geranylgeranyl diphosphate to taxa-4(5),11(12)-diene is the first committed step of Taxol biosynthesis in Pacific yew. *J. Biol. Chem.* **1995**, *270*, 8686–8690.
- 128 Hezari, M., Lewis, N.G., Croteau, R. Purification and characterization of taxa-4(5),11(12)-diene synthase from Pacific yew (*Taxus brevifolia*) that catalyzes the first committed step of Taxol biosynthesis. *Arch. Biochem. Biophys.* **1995**, *322*, 437–444.
- 129 Hefner, J., Rubenstein, S.M., Ketchum, R.E.B., Gibson, D.M., Williams, R.M., Croteau, R. Cytochrome P450-catalyzed hydroxylation of taxa-4(5),11(12)-diene to taxa-4(20),11(12)-dien-5a-ol: the first oxygenation step in Taxol biosynthesis. *Chem. Biol.* **1996**, *3*, 479–489.
- 130 Vazquez, A., Williams, R.M. Studies on the biosynthesis of taxol. Synthesis of taxa-4(20),11(12)-diene-2,5-diol. *J. Org. Chem.* **2000**, *65*, 7865–7869.
- 131 Floss, H.G., Mocek, U. Biosynthesis of taxol. In: Suffness, M. (Ed.), *Taxol science and applications*. CRC Press, Boca Raton, **1995**, pp. 191–298.
- 132 Kingston, D.G.I., Molinero, A.A., Rimoldi, J.M. The taxane diterpenoids. *Prog. Chem. Org. Nat. Prod.* **1993**, *61*, 1–206.
- 133 Baloglu, E., Kingston, D.G.I. The taxane diterpenoids. *J. Nat. Prod.* **1999**, *62*, 1448–1472.
- 134 Wildung, M.R., Croteau, R. A cDNA clone for taxadiene synthase, the diterpene cyclase that catalyzes the committed step of Taxol biosynthesis. *J. Biol. Chem.* **1996**, *271*, 9201–9204.
- 135 Schoendorf, A., Rithner, C.D., Williams, R.M., Croteau, R.B. Molecular cloning of a cytochrome P450 taxane 10-hydroxylase cDNA from *Taxus* and functional expression in yeast. *Proc. Natl. Acad. Sci. USA* **2001**, *98*, 1501–1506.

- 136 Jennewein, S., Croteau, R. Taxol: biosynthesis, molecular genetics, and biotechnological applications. *Appl. Microbiol. Biotechnol.* **2001**, *57*, 13–19.
- 137 Jennewein, S., Rithner, C.D., Williams, R.M., Croteau, R.B. Taxol biosynthesis: taxane 13 alpha-hydroxylase is a cytochrome P450-dependent monooxygenase. *Proc. Natl. Acad. Sci. USA* **2001**, *98*, 13595–13600.
- 138 Walker, K., Ketchum, R.E., Hezari, M., Gatfield, D., Goleniowski, M., Barthol, A., Croteau, R. Partial purification and characterization of acetyl coenzyme A: taxa-4(20),11(12)-dien-5-alpha-ol O-acetyl transferase that catalyzes the first acylation step of taxol biosynthesis. *Arch. Biochem. Biophys.* **1999**, *364*, 273–279.
- 139 Walker, K., Croteau, R. Molecular cloning of a 10-deacetylbaccatin III-10-O-acetyl transferase cDNA from *Taxus* and functional expression in *Escherichia coli*. *Proc. Natl. Acad. Sci. USA* **2000**, *97*, 583–587.
- 140 Walker, K., Schoendorf, A., Croteau, R. Molecular cloning of a taxa-4(20),11(12)-dien-5-ol-O-acetyl transferase cDNA from *Taxus* and functional expression in *Escherichia coli*. *Arch. Biochem. Biophys.* **2000**, *374*, 371–380.
- 141 Huang, K.X., Huang, Q.L., Wildung, M.R., Croteau, R., Scott, A.I. Overproduction, in *Escherichia coli*, of soluble taxadiene synthase, a key enzyme in the Taxol biosynthetic pathway. *Protein Expr. Purif.* **1998**, *13*, 90–96.
- 142 Stockigt, J., Zenk, M.H. Strictosidine (isovincoside): the key intermediate in the biosynthesis of monoterpene indole alkaloids. *J. Chem. Soc. Chem. Commun.* **1977**, 646–648.
- 143 Scott, A.I., Lee, S.L. Biosynthesis of the indole alkaloids – A cell-free system from *Catharanthus roseus*. *J. Am. Chem. Soc.* **1975**, *97*, 6906–6908.
- 144 Stockigt, J., Ruppert, M. Strictosidine – the biosynthetic key to monoterpene indole alkaloids. In: Barton, S.D., Nakanishi, K., Meth-Cohn, O. (Eds.), *Comprehensive Natural Products Chemistry*, Volume 4. Pergamon, Oxford, **1999**, pp. 109–138.
- 145 Verpoorte, R., Van der Heijden, R., Moreno, P.R.H. Biosynthesis of terpenoid indole alkaloids in *Catharanthus roseus* cells. In: Cordell, G.A. (Ed.), *The Alkaloids*. Academic Press, San Diego, **1997**, pp. 221–299.
- 146 Hutchinson, C.R., Heckendorf, A.H., Straughn, J.L., Daddona, P.E., Cane, D.E. Biosynthesis of camptothecin: Definition of strictosamide as the penultimate biosynthetic precursor assisted by <sup>13</sup>C and <sup>1</sup>H NMR spectroscopy. *J. Am. Chem. Soc.* **1979**, *101*, 3358–3369.
- 147 Hemscheidt, T., Zenk, M.H. Glucosidases involved in indole alkaloid biosynthesis of *Catharanthus* cell cultures. *FEBS Lett.* **1980**, *110*, 187–191.
- 148 De Luca, V. Metabolic engineering of crops with the tryptophan decarboxylase of *Catharanthus roseus*. In: Verpoorte, R., Alfermann, A.W. (Eds.), *Metabolic engineering of plant secondary metabolism*. Kluwer Academic Press, Dordrecht, **2000**, pp. 179–194.
- 149 Kutchan, T.M. Alkaloid biosynthesis – The basis for metabolic engineering of medicinal plants. *Plant Cell* **1995**, *7*, 1059–1070.
- 150 Canel, C., Lopez-Cardoso, M.I., Whitmer, S., Van der Fits, L., Pasquali, G., Van der Heijden, R., Hoge, J.H.C., Verpoorte, R. Effects of over-expression of strictosidine synthase and tryptophan decarboxylase on alkaloid production by cell cultures of *Catharanthus roseus*. *Planta* **1998**, *205*, 414–419.
- 151 Whitmer, S., Canel, C., Hallard, D., Goncalves, C., Verpoorte, R. Influence of precursor availability on alkaloid accumulation by transgenic cell lines of *Catharanthus roseus*. *Plant Physiol.* **1998**, *116*, 853–857.
- 152 Geerlings, A., Hallard, D., Martinez, C.A., Lopez, C.I., Van der Heijden, R., Verpoorte, R. Alkaloid production by a *Cinchona officinalis* ‘Ledgeriana’ hairy root culture containing constitutive expression constructs of tryptophan decarboxylase and strictosidine synthase cDNAs from *Catharanthus roseus*. *Plant Cell Rep.* **1999**, *19*, 191–196.
- 153 Whitmer, S. *Aspects of terpenoid indole alkaloid formation by transgenic cell lines of Catharanthus roseus over-expressing tryptophan decarboxylase and strictosidine synthase*. PhD Thesis, University of Leiden, The Netherlands, **1999**.



- 154 Hallard, D. *Transgenic plant cells for the production of indole alkaloids*. PhD Thesis, University of Leiden, The Netherlands, 2000.
- 155 Menke, F.L.H., Champion, A., Kijne, J.W., Memelink, J. A novel jasmonate- and elicitor-responsive element in the periwinkle secondary metabolite biosynthetic gene *Str* interacts with a jasmonate- and elicitor-inducible AP2-domain transcription factor, *ORCA2*. *EMBO J.* 1999, 18, 4455–4463.
- 156 Menke, F.L.H., Parchmann, S., Mueller, M.J., Kijne, J.W., Memelink, J. Involvement of the octadecanoid pathway and protein phosphorylation in fungal elicitor-induced expression of terpenoid indole alkaloid biosynthetic genes in *Catharanthus roseus*. *Plant Physiol.* 1999, 119, 1289–1296.
- 157 Menke, F.L.H. *Elicitor signal transduction in Catharanthus roseus leading to terpenoid indole alkaloid biosynthetic gene expression*. PhD Thesis, University of Leiden, The Netherlands, 1999.
- 158 Van der Fits, L. *Transcriptional regulation of stress-induced plant secondary metabolism*. PhD Thesis, University of Leiden, The Netherlands, 2000.
- 159 Yamazaki, Y., Urano, A., Sudo, H., Kitajima, M., Takayama, H., Yamazaki, M., Aimi, N., Saito, K. Metabolite profiling of alkaloids and strictosidine synthase activity in camptothecin-producing plants. *Phytochemistry* 2003, 62, 461–470.
- 160 Misawa, M., Sakato, K., Tanaka, H., Hayashi, M., Samejima, M., Production of physiologically active substances by plant cell suspension cultures. In: Street, H.E. (Ed.), *Tissue culture and Plant Science*. Academic Press, London, New York, 1974, pp. 235–246.
- 161 Stahelin, H.F., von Wartburg, A.V. The chemical and biological route from podophyllotoxin glucoside to etoposide. *Cancer Res.* 1991, 51, 5–15.
- 162 Imbert, T.F. Discovery of podophyllotoxins. *Biochimie* 1998, 80, 207–222.
- 163 Sjöstrom, J., Blomqvist, C., Mouridsen, H., Pluzanska, A., Ottosson-Lonn, S., Bengtsson, N.O., Ostenstad, B., Mjaaland, I., Palm-Sjovall, M., Wist, E., Valvere, V., Anderson, H., Bergh, J. Docetaxel compared with sequential methotrexate and 5-fluorouracil in patients with advanced breast cancer after anthracycline failure: a randomized phase III study with crossover on progression by the Scandinavian Breast Group. *Eur. J. Cancer* 1999, 35, 1194–1201.
- 164 Fan, W. Possible mechanisms of paclitaxel-induced apoptosis. *Biochem. Pharmacol.* 1999, 57, 1215–1221.
- 165 Huang, Y., Fan, W. I $\kappa$ B kinase activation is involved in regulation of paclitaxel-induced apoptosis in human tumour cell lines. *Mol. Pharmacol.* 2002, 61, 105–113.
- 166 Johnson, K.R., Fan, W. Reduced expression of p<sup>53</sup> and p<sup>21WAF1/CIP1</sup> sensitizes human breast cancer cells to paclitaxel and its combination with 5-fluorouracil. *Anticancer Res.* 2002, 22, 1–8.
- 167 Johnson, K.R., Wang, L., Miller, M.C., Willingham, M.C., Fan, W. 5-Fluorouracil interferes with paclitaxel cytotoxicity against human solid tumour cells. *Clin. Cancer Res.* 1997, 3, 1739–1745.
- 168 Chabot, G.G. Clinical pharmacokinetics of irinotecan. *Clin. Pharmacokinet.* 1997, 33, 245–259.
- 169 Friedman, H.S., Petros, W.P., Friedman, A.H., Schaaf, L.J., Kerby, T., Lawyer, J., Parry, M., Houghton, P.J., Lovell, S., Rasheed, K., Cloughsey, T., Stewart, E.S., Colvin, O.M., Provenzale, J.M., Mclendon, R.E., Bigner, D.D., Cokgor, I., Haglund, M., Rich, J., Ashley, D., Malczyn, J., Elfring, G.L., Miller, L.L. Irinotecan therapy in adults with recurrent or progressive malignant glioma. *J. Clin. Oncol.* 1999, 17, 1516–1525.
- 170 Jiang, J.F., Lui, W.J., Ding, J. Regulation of telomerase activity in camptothecin induced apoptosis of leukemia HL-60 cells. *Acta Pharmacol. Sin.* 2000, 21, 759–764.
- 171 Van Uden, W., Pras, N., Malingre, T.M. The accumulation of podophyllotoxin- $\beta$ -D-glucoside by cell suspension cultures derived from the conifer *Callitris drummondii*. *Plant Cell Rep.* 1990, 9, 257–260.
- 172 Empt, U., Alfermann, A.W., Pras, N., Peterson, M. The use of plant cell

- cultures for the production of podophyllotoxin and related lignans. *J. Appl. Bot.* **2000**, *74*, 145–150.
- 173** Van Uden, W., Pras, N., Vosseveld, E.M., Mol, J.N.M., Malingre, T.M. Production of 5-methoxypodophyllotoxin in cell suspension cultures of *Linum flavum* L. *Plant Cell Tissue Organ Cult.* **1990**, *20*, 81–87.
- 174** Konuklugil, B., Schimdt, T.J., Alfermann, A.W. Accumulation of aryltetralin lactone lignans in cell suspension cultures of *Linum nodiflorum*. *Planta Med.* **1999**, *65*, 587–588.
- 175** Kutney, J.P., Arimoto, M., Hewitt, G.M., Jarvis, T.C., Sakata, K. Studies with plant cell cultures of *Podophyllum peltatum* L. I. Production of podophyllotoxin, deoxypodophyllotoxin, podophyllotoxone, and 4'-demethylpodophyllotoxin. *Heterocycle* **1991**, *32*, 2305–2309.
- 176** Dong, H.D., Zhong, J.J. Significant improvement of taxane production in suspension cultures of *Taxus chinensis* by combining elicitation with sucrose feed. *Biochem. Eng. J.* **2001**, *8*, 145–150.
- 177** Hermann, K.M. The shikimate pathway: Early steps in biosynthesis of aromatic compounds. *Plant Cell* **1995**, *7*, 907–910.
- 178** Hahlbrock, K., Scheel, D. Physiology and molecular biology of phenylpropanoid metabolism. *Annu. Rev. Plant Physiol. Plant Mol. Biol.* **1989**, *40*, 347–369.
- 179** Seidel, V., Windhövel, J., Eaton, G., Alfermann, A.W., Arroo, R.R.J., Medarde, M., Petersen, M., Wolley, J.G. Biosynthesis of podophyllotoxin in *Linum album* cell cultures. *Planta* **2002**, *215*, 1013–1039.
- 180** Lauvergeat, V., Lacomme, C., Lacombe, E., Lasserre, E., Roby, D., Grima-Pettenati, J. Two cinnamoyl-CoA reductase (CCR) genes from *Arabidopsis thaliana* are differentially expressed during development and in response to infection with pathogenic bacteria. *Phytochemistry* **2001**, *57*, 1187–1195.
- 181** Henges, A. *Biosynthese und Kompartimentierung von Lignan in Zellkulturen von Linum album*. Dissertation, University of Dusseldorf, **1999**.
- 182** Molog, M.G., Empt, U., Petersen, M., Van Uden, W., Pras, N., Alfermann, A.W. Deoxypodophyllotoxin 6-hydroxylase, a cytochrome P450 monooxygenase from cell cultures of *Linum flavum* involved in biosynthesis of cytotoxic lignans. *Planta* **2001**, *214*, 288–294.
- 183** Kuhlmann, S., Kranz, K., Lücking, B., Alfermann, A.W., Petersen, M. Aspects of cytotoxic lignan biosynthesis in suspension cultures of *Linum nodiflorum*. *Phytochem. Rev.* **2002**, *1*, 37–43.
- 184** Hezari, M., Croteau, R. Taxol biosynthesis: an update. *Planta Med.* **1997**, *63*, 291–295.
- 185** Collu, G., Unver, N., Peltenburg-Looman, A.M.G., Van der Heijden, R., Verpoorte, R., Memelink, J. Geraniol 10-hydroxylase, a cytochrome P450 enzyme involved in terpenoid indole alkaloid biosynthesis. *FEBS Lett.* **2001**, *508*, 215–220.



## Part 2

# Genetic Modifications, Transgenic Plants and Potential of Medicinal Plants in Genetechnology and Biotechnology

## 8

**In-Vitro Culturing Techniques of Medicinal Plants**

Wolfgang Kreis

## 8.1

**Introduction**

As early as 1934, it was demonstrated that plant cells and tissues could be cultivated for long periods of time on appropriate media (Gautheret, 1934; White, 1934). By including indole-3-acetic acid and vitamins in his media, Gautheret (1934) extended the culture period of *Salix* callus to 18 months, and was able to subculture the tissue aseptically. Later, White (1939) reported the “Potentially Unlimited Growth of Excised Plant Callus in an Artificial Nutrient”, and found that these callus cultures basically showed no evidence of differentiation or polarity. Being undifferentiated, yet capable of unlimited growth, they appeared to satisfy the two main requirements for a true “tissue culture”. Meanwhile, the initiation of plant cell and tissue cultures and cultivation of plant cells and tissues *in vitro* has become a relatively simple task (see, for example, Murashige, 1974; Allan, 1991). During the 1970s and 1980s, plant cell suspension culture was regarded as the most appropriate means of studying plant secondary metabolism, and as the most suitable form of plant tissue culture with a view to producing plant secondary metabolites on a commercial scale. As a consequence, these decades witnessed the establishment of cell suspension cultures from hundreds of plant species, including many medicinal plants, as well as the development of bioreactor environments suitable for the cultivation of plant cells and plant organs on a large scale.

Provided that an appropriate phytohormone regime is chosen, plant cells cultivated *in vitro* may undergo coordinated division and development resulting in the formation of complex structures such as roots, shoots, somatic embryoids, and finally intact plants. Several textbooks, proceedings, and review articles have described this topic more comprehensively than is possible in this chapter (Murashige, 1974; Mantell et al., 1985; Day et al., 1985; Stafford and Warren, 1991; Payne et al., 1992). Issues that will be detailed in this chapter are summarized in Table 8.1 and Figure 8.1.

**Table 8.1** *In-vitro* culturing techniques of medicinal plants.

<i>Basic methods and techniques</i>	
Seed germination <i>in vitro</i>	Multiple protocorm formation
Embryo culture	Embryo rescue
Callus culture	Initiation, maintenance
Organogenesis	Adventitious shoots, adventitious roots
Haploid technology	Anther culture, microspore culture
Somatic embryogenesis	Somatic embryoids, artificial seeds
<i>Protoplast technology</i>	
Protoplasts	Isolation, cultivation, plant regeneration
Somatic hybridization	Protoplast fusion, plant regeneration
<i>Special techniques</i>	
Gene transfer	<i>Agrobacterium</i> -mediated transformation
Germplasm storage	Cryopreservation
<i>Permanent in-vitro cultures</i>	
Suspension culture	Initiation, subculture, scale-up
Root culture	Initiation, subculture
Shoot culture	Initiation, subculture, rooting, plant regeneration
Bioreactors	Cell suspension cultures, root cultures, shoot cultures, bioreactor design, operation mode
<i>Methods and techniques related to secondary metabolism</i>	
Inducing variability	Mutation, somaclonal variation
Selection	Cell-aggregate cloning, protoplast cloning
Biotransformation	Bioconversion
Elicitation	Biotic elicitors, abiotic elicitors
Immobilization and permeation	Techniques, chemical and physical methods

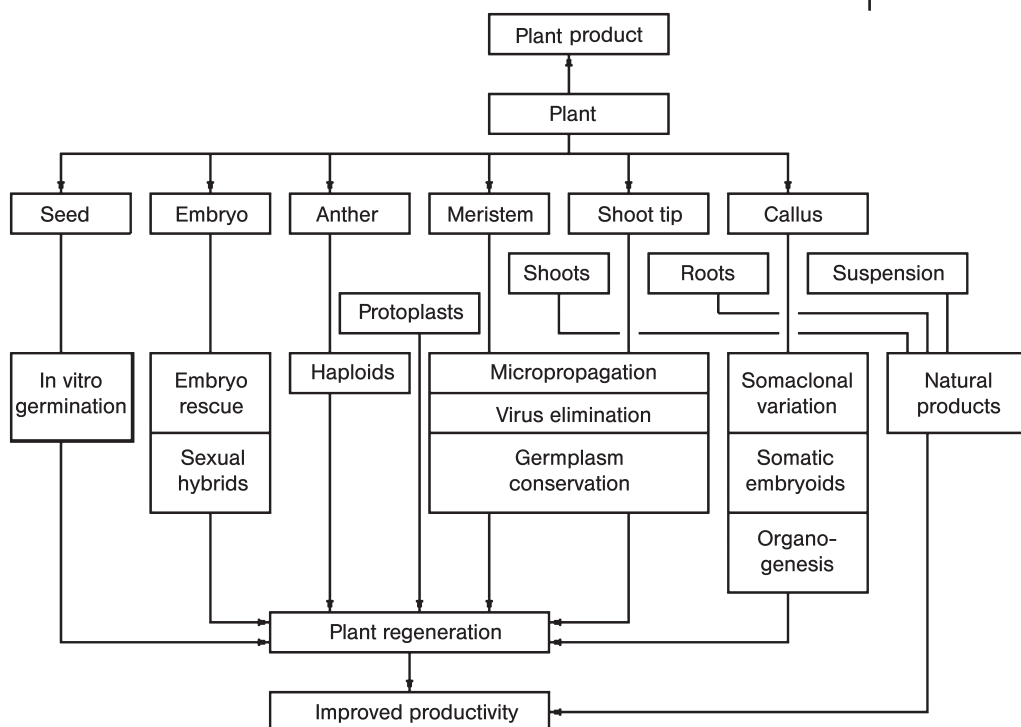
## 8.2

### Basic Methods and Techniques

#### 8.2.1

##### Seed Germination In Vitro

Seed germination under axenic conditions is the simplest *in-vitro* culturing technique used. Surface-sterilized seeds of almost any plant species can be germinated on agar-solidified media on which they develop into small sterile plantlets. These in turn can be used to establish plant tissue cultures, such as callus or organ cultures. Since aggressive chemicals (e.g., hypochlorite or hydrogen peroxide) are generally used for decontamination, it may be of advantage to treat the rather robust seeds instead of the much softer explants, such as leaf or stem pieces.



**Fig. 8.1** *In-vitro* culture techniques exploited in plant breeding, preservation and propagation, as well as techniques used in the production of secondary metabolites.

The method has a broad application in the commercial propagation of orchids (Sato et al., 1978). Orchids produce tiny seeds in which only a few reserve compounds are stored. In Nature, orchids will not germinate unless infected by a fungus, which feeds the young plants until they are tall enough to produce their own food. Once the seed has germinated the embryo develops into a spherical protocorm that will continue to grow for weeks, months or years, until large enough to differentiate into an orchid plant. When germinated under sterile conditions (i.e., without the fungus) on suitable media, the nutrients provided will substitute for the fungus and allow the seeds to germinate and grow without it. Sterile seeds are usually isolated from surface-sterilized immature capsules; this procedure has the advantage that the seeds themselves have not to be sterilized. Another advantage of using unripe seeds is that they may germinate more quickly than mature seeds, since seed dormancy can be overcome. However, protocorm formation may also be significantly lower in immature seeds than in mature seeds (e.g., Kitsaki et al. 2004). When germinated *in vitro*, the developing protocorm will form additional

protocorm-like bodies (multiple protocorm formation). The tendency toward the formation of such structures can be influenced by suitable additions to the nursing medium. Each protocorm-like structure will develop into an orchid plantlet. With *in-vitro* germination large numbers of seedlings can be raised in a relatively short time. As a rule, the young plants transferred to the greenhouse are infected without any further assistance with “their” fungus so that the endomycorrhiza necessary for further plant development will be established. Seed germination *in vitro* is not only used for the propagation of known orchids but can also be employed for the breeding of hybrid plants and their subsequent preservation and propagation.

### 8.2.2

#### **Embryo Culture**

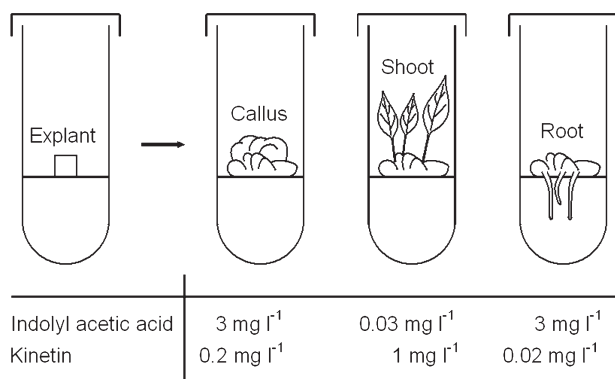
Embryos can be isolated from seeds and cultivated under axenic conditions *in vitro* (Sharma et al., 1996). Grain fruits contain relatively large embryos which can be isolated quite easily, but if the embryos are too tiny to be prepared safely, the complete ovule can be isolated instead. The composition of culture media on which isolated embryos will develop is a problematic issue, and requires much experimental effort; however, if the respective demands are met, then regeneration to intact plants is easily achieved.

By applying the embryo culture technique, it is possible to shorten generation times by breaking seed dormancy. Moreover, embryos present in seeds obtained from sexual crossings that are not able to germinate can be “rescued” and stimulated to develop. Embryos can even be prepared from one seed and then transplanted into the endosperm of a “nurse” seed which, together with the nutrients added to the culture medium, supports further development of the embryo. Actually, the development of various *Triticale* cultivars, the first “synthetic” cereals, would not have been possible without the embryo rescue technique. Embryo rescue thus holds great promise, especially for obtaining plants from inherently weak embryos and for shortening the breeding cycle.

### 8.2.3

#### **Callus Culture**

The cell material described in early reports on plant cell and tissue culture is known as callus, and is initiated by removing explants (e.g., pieces of stem, leaf or root) from the whole plant or plants already kept *in vitro*. Except for those cases where axenic material is used, the respective explants are surface-sterilized and placed on agar-solidified nutrient media. The “wound callus” formed at sites of tissue injury can easily be removed from the initial explant, and its further development can be controlled by exogenous phytohormones or synthetic growth regulators (Fig. 8.2). During prolonged culture *in vitro* cells may achieve hormone autonomy, and often be distinguished as either cytokinin or auxin autotrophic, or completely hormone autotrophic. This phenomenon is called “hormone habituation” (White, 1951), and has been reported in cultures of several species. Hormone



**Fig. 8.2** Initiation of callus cultures and induction of organogenesis. Morphogenesis can be triggered by changing the phytohormone regime. (Modified after Kreis, 2003.)

habituation is reversible in some cases, and hence epigenetic rather than genetic changes may be responsible.

Plant cell culture media are composed of many different compounds, including inorganic macronutrients (salts of N, P, S, K, Na, Ca, Mg) and micronutrients (salts of e.g., I, Ni, Fe, Cu, B, Mn, Co), as well as vitamins and a carbohydrate source (usually 2–5% sucrose). The most common media for plant cell culture are those devised by Murashige and Skoog (1962), Gamborg et al. (1968), Schenk and Hildebrandt (1972), and White (1934).

Plant cell culture media support the growth of microbial cells, and therefore any contamination must be avoided in order to provide an aseptic environment. The standard sterilization techniques that are used in microbiology can be applied. Usually, plant cells and tissues are handled under laminar flow in suitable cabinets. Culture media are autoclaved (121°C, 15 min), while thermolabile compounds (e.g., phytohormones) can be filter-sterilized and then added to the autoclaved media. Various types of vessels are used for cell line preservation and subcultivation, for example disposable, sterile Petri dishes, tubes or Erlenmeyer flasks. Glass flasks and tubes may be sealed with foam or cotton bungs, while metal caps, aluminum foil or sterile clingwrap are used to cover the vessels to avoid them becoming contaminated.

Once established, individual callus isolates can be subcultivated over decades; typically, subculture periods range from three to six weeks. The callus must not be supposed to be homogeneous and composed of identical cells, and therefore subculture is selective. Selection may be either deliberate or unwittingly, but in general rapidly growing cells are favored. Callus becomes more homogeneous with time, and heterogeneity can be reduced by using strict subculture protocols. Callus provides a reliable, self-contained and quite uniform material, and is therefore suited to the study of biosynthetic problems. However, it cannot be advised as a system for the production of secondary metabolites because of the slow growth rates and the lack of suitable bioreactor systems to grow callus on a large scale.

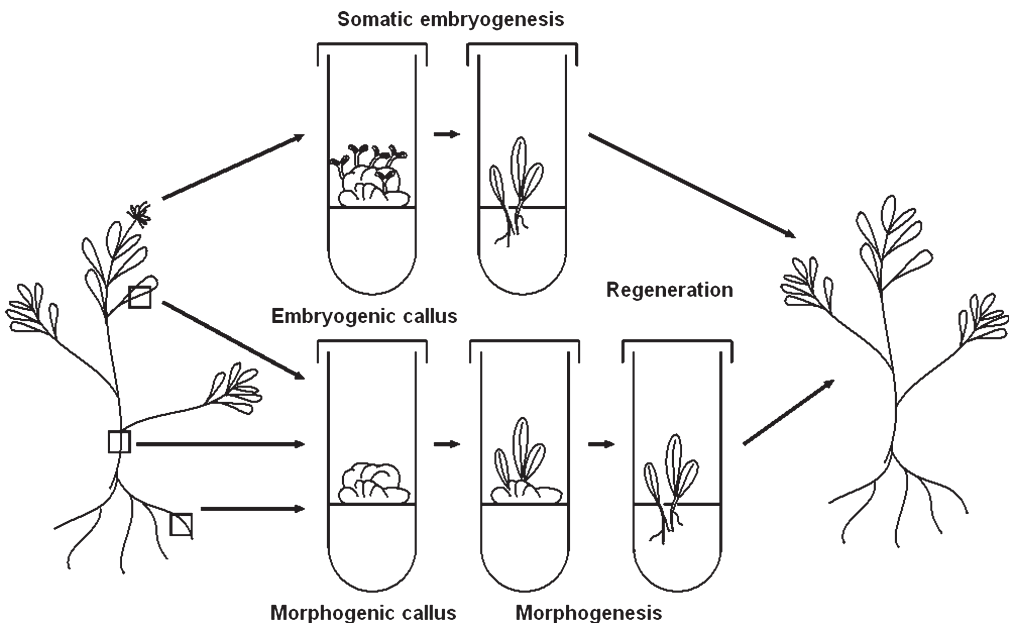
Callus contains meristematic plant cells that are considered as being totipotent – that is, they may be differentiated and finally regenerated to intact plants. Callus can therefore be used as a starting material for organ and plant regeneration.

Plant cell cultures are collected and delivered on request. For example, the DSMZ (German Collection of Microorganisms and Cell Cultures) maintains more than 700 different plant cell lines from more than 80 different plant families. The collection contains a large number of cultures derived from plant species containing secondary metabolites of pharmaceutical importance ([http://www.dsmz.de/plant\\_cell\\_lines](http://www.dsmz.de/plant_cell_lines)).

#### 8.2.4

#### Organogenesis

So-called adventitious roots or shoots are formed when organ development is induced in non-meristematic areas of a given plant tissue. In this process, specialized cells (e.g., epidermis cells) may turn meristematic, usually passing through a short period of callus formation (Fig. 8.3). Those plants which can be propagated vegetatively are especially susceptible to adventitious organ formation *in vitro*. Plant regeneration through multiple adventitious shoot differentiation has been established in many species (Bajaj, 1991, 1992a,b,c, 1997a,b). Most often, leaf ex-



**Fig. 8.3** Morphogenesis from root, stem or leaf explants via adventitious organ formation and somatic embryogenesis from embryogenic callus via somatic embryos.

plants are used and shoot formation is then induced by a suitable phytohormone treatment. Explants of younger plants usually respond better than older ones, and herbaceous plants as a rule respond better than woody plants. Adventitious root or shoot formation can also be induced in other plant organs or in callus. Depending on the starting material, growth regulators such as benzyladenine, 4-dichlorophenoxyacetic acid, indole-3-butyric acid,  $\alpha$ -naphthalene acetic acid, 2-isopentenyladenine or thidiazuron are added to the basal growth media to induce shoot formation. Shoots are then propagated and rooted as described for shoot cultures (see below). Changes of light conditions, photoperiod, temperature, and/or reduction of the nutrients in the culture medium may help to achieve high rooting efficiency. With some ornamental plants (e.g., geraniums and petunias) adventitious organ formation is the method of choice for clonal propagation.

Although micropropagation by adventitious shoot proliferation or through meristem culture (see below) may be equally successful, it must be considered that adventitious propagation systems yield plants that are genetically more variable compared to those obtained via meristem culture. Adventitious organ formation may also occur in meristematic shoot cultures. A degree of expertise is required to decide whether newly formed shoots arise from true meristematic zones, or whether they were formed adventitiously (i.e., not at the vegetation tips or zones).

### 8.2.5

#### Haploid Technology

Haploid technology is an important tool for plant breeding, and involves the cultivation of plant tissue *in vitro* (Hu and Zeng, 1984; Morrisson and Evans, 1988; Bajaj, 1990a; Atanassov et al., 1995). The technique allows for a significant time reduction in the achievement of homozygous breeding lines in crop improvement. As early as 1953 it was found that anthers of ginkgo developed haploid callus when cultivated *in vitro* (Tulecke, 1953), but a further 10 years passed until the first haploid plants (*Datura innoxia*) were successfully regenerated via anther culture (Guha and Maheshwari, 1964). Meanwhile, many plants – including medicinal plants – have been regenerated via anther culture (Jain et al., 1997; Bajaj, 1990a).

Haploids are sporophytes with the chromosome number of gametophytes, and haploid cells are formed during meiosis. Haploid plant cells are present in the embryo sack (megagametophyte) or the pollen (microgametophyte), and consequently haploids can be obtained via gynogenesis from cells of the embryo sack, or by androgenesis from pollen. In this way, monohaploid and dihaploid plants can be obtained from diploid and tetraploid plants, respectively. Colchicine can be used to induce chromosome doubling by inhibiting chromosome segregation during meiosis, and in this way homozygous cells can be obtained. These may form a regenerable callus that can be stimulated to develop into homozygous (“dihaploid”) plants, while haploid callus can be produced via gynogenesis or androgenesis, the latter method being the preferred one in practice. In androgenesis, two basic techniques can be distinguished, namely anther culture and microspore culture.



One disadvantage of anther culture is that callus may develop from diploid cells of the anther wall. Thus, the plants may result from somatic embryogenesis (see below) or adventitious shoot formation (see above). These then compete with the haploid plants derived via androgenesis, and must be sorted out by cytogenetic analysis, cultivating microspores alone, i.e. without adhering diploid anther tissue will solve this problem. A number of methods have been developed for the preparation and cultivation of microspores and protocols for the regeneration of haploid plants thereof. Genetic variation, termed “gametoclonal variation” (Evans et al., 1984), may occur during the tissue culture phase.

#### 8.2.6

##### **Somatic Embryogenesis**

When roots and shoots develop simultaneously and from a common origin, a differentiation process is seen that leads to shoot and root formation in a coordinated manner. This process resembles the development of zygotic embryos, and is termed “somatic embryogenesis”. The structures formed from callus or suspension cells are therefore called somatic embryos or, more precisely, somatic embryoids (embryo-like structures). Globular somatic embryoids, which can be maintained in culture over long periods of time, can differentiate into heart-shaped and later torpedo-shaped embryoids (Merkle et al., 1995). The regeneration of properly developed somatic embryoids to intact plants is quite simple (see Fig. 8.3). For carrot – which serves as a model system for studying somatic embryogenesis – it was calculated that about 50 000 somatic embryoids per liter medium are formed each day (Ducos et al., 1993). Hence, somatic embryogenesis is regarded as a system of choice for mass propagation, but for this purpose the process must be synchronized (Osuga and Komamine, 1994). It must also be considered that embryogenic cell cultures may lose this quality during prolonged cultivation. The advantages of somatic embryoids include high multiplication rates and the potential for scale-up in bioreactors (Eeva et al., 2003).

Somatic embryoids can be encapsulated in alginate as single-embryo beads to produce so-called “artificial seeds” (Redenbaugh et al., 1988; Senaratna, 1992; Bajaj, 1995a; Cervelli and Senaratna, 1995). The quality of artificial seeds depends on the supply of growth regulators and nutrients. Artificial seeds can be desiccated in this way, thereby facilitating year-round production, storage, and distribution. The production of artificial seeds has been reported in many species (Gupta et al., 1993), with germination rates as high as 30% and 65% being found in alfalfa and celery, respectively. Somatic embryoids have also been used for the production of secondary plant metabolites. For example, the torpedo stages of somatic celery embryoids (*Apium graveolens*) will develop the celery flavor (Al-Abta et al., 1979), while embryoids of foxglove (*Digitalis lanata*) are capable of producing cardenolides (Greidziac et al., 1990), albeit in only small quantities.

### 8.3

## Protoplast Technology

### 8.3.1

#### Protoplasts

Plant cells possess a thick and quite rigid cell wall which is composed of cellulose and other polysaccharides, such as pectin. In hypertonic solutions, the plasma membranes of cells contract from their walls, with removal of the wall material releasing large populations of spherical, osmotically fragile structures, termed “protoplasts”. The main objectives in using protoplast isolation and culture techniques are to:

- regenerate an intact plant from a single cell for proving the concept of totipotency;
- fuse protoplasts of different origin with a view to producing a hybrid cell which subsequently regenerates into a hybrid plant that cannot be obtained by sexual crossing (somatic hybridization); and
- obtain cells accessible for genetic manipulation.

Indeed, many economically important species – including medicinal plants – have been regenerated via protoplasts (Potrykus et al., 1983; Eriksson, 1985; Davey et al., 2005).

During recent years the isolation of protoplasts has become routine since, if chopped plant tissue is treated with pectinase and cellulase, it will release protoplasts (Cocking, 1960). Today, mechanical procedures are rarely employed, though they can be used to isolate the protoplasts of very large cells, or to isolate protoplasts used in patch-clamp experiments in order to avoid unwanted changes in physiological and electrical properties that might result from enzymatic digestion of the cell wall (Binder et al., 2003). In any case, plasmolysed tissue must be used. A slightly hypertonic medium during the isolation and cultivation process is mandatory, as otherwise the protoplasts will burst. When provided with the correct chemical and physical stimuli, each protoplast is capable (in theory) of regenerating a new wall and undergoing repeated mitotic division to produce a callus from which fertile plants may be regenerated.

Isolated protoplasts begin cell wall regeneration almost immediately after their isolation. To achieve this they require osmotic protection until their new cell walls can withstand the normal cell turgor, and this is generally provided by the addition of non-metabolizable sugar alcohols (e.g., mannitol or sorbitol). Protoplasts from different species, or from different tissues of the same species, may vary in their nutritional requirements, but guidance is available from the monographs of the *Biotechnology in Agriculture and Forestry* series, edited by Y.P.S. Bajaj (e.g., Bajaj, 1994a). There is no universal protocol with regard to medium composition and physical parameters, however, and many of the protocols developed have been based on media introduced for plant cell culture. For the culture of protoplasts at low density, coconut milk (Kao and Michayluk, 1975) may be added to the culture

medium, and auxins and cytokinins are normally essential for sustained protoplast growth. Isolated protoplasts may be cultured in liquid medium over semi-solid medium containing so-called “nurse” or “feeder” cells. Nurse cells are located in the same vessel as the protoplast, separated only by a semi-permeable membrane or any other device that supports the separation of protoplasts from feeders. Nurse cells may be from either the same or from different species, and can help overcome the problem of cell densities that are too low to allow proliferation. The nurse cells support protoplast growth and division by unknown factors, or via nutrients emitted by the feeder cells and absorbed by the protoplasts. Alternatively, toxic compounds generated during protoplast culture may be adsorbed or sequestered by the nurse cells.

### 8.3.2

#### **Somatic Hybridization**

Somatic hybrids obtained through the fusion of plant protoplasts have widened the genetic variability of plants (Bajaj, 1994b; Nagata and Bajaj, 2001). Several groups have reported the generation of hybrid plants through protoplast fusion, and some improvements have been described in fusion technology since the early days when plant protoplasts were fused using the polyethylene glycol (PEG) method (Kao and Michayluk, 1974). This chemically induced fusion was achieved at high pH (10.5) in the presence of calcium (10 mM) and PEG (10–50%). However in 1979 it was found that protoplasts, when held in an appropriate electric field, would fuse together (Senda et al., 1979), and today electrofusion is the preferred method, mainly because membrane damage is reduced and the entire process is much cleaner and more controllable than PEG-induced fusion (Davey et al., 2005).

Electrofusion is a two-step procedure. In the first step, a non-uniform, alternating electric field is applied which causes the protoplasts to line up perpendicular to the electrodes. The protoplasts chain length is influenced by the distance between the electrodes and the cell density, but ideally the protoplasts agglutinate pair-wise. In the second step, fusion is induced by a single high-voltage DC pulse. It is thought that the charge difference between the outside and inside of the plasma membrane finally crushes the membrane. This causes the electric potential to break down, whereupon the membrane structure can be reformed, including the mixing of membranes of agglutinated protoplasts; the result is cell fusion. A number of recent reports have described the generation of unique plants through somatic hybridization by protoplast fusion (Davey et al., 2000, 2005). As with medicinal plants, quite extensive hybridization studies have been performed in the Solanaceae (*Nicotiana*, *Solanum*) and in *Mentha*. In the latter genus, somatic hybridization was aimed either at modifying the composition of the oil (Sato et al., 1996), or at combining essential oil quality with disease resistance (Krasnyanski et al., 1998).

## 8.4 Special Techniques

### 8.4.1 Gene Transfer

The key tool for genetic transformation with a view towards the design and creation of engineered plants or plant tissue cultures, is the Ti plasmid of the plant pathogen *Agrobacterium tumefaciens*. This bacterium is responsible for crown gall disease in higher plants, and its Ti plasmid can be used as a natural vector for genetic transformation. This plasmid bears a region termed T-DNA which can be transferred into the host genome (Chilton et al., 1977). Additional genetic material can be tailored into the T-DNA, whereas the “disease genes” – which are responsible for the tumor growth of the crown galls – can be either destroyed or removed.

Today, the introduction of genes into plant cells has become routine, and the available methods include not only the biological approach using *A. tumefaciens* but also the physical methods of biolistics (which uses microprojectiles coated with DNA) or electroporation (which uses a high-voltage electric pulse) to achieve transfection (Hoykaas, 2000; Leech et al., 2000). In the biological approach, only one or a few copies of T-DNA containing the gene(s) of interest are inserted; in contrast, the physical methods are generally less tidy but offer certain advantages over conventional *Agrobacterium*-mediated gene transfer. One such advantage is the possibility of bypassing *Agrobacterium* host specificity, which allows a broadening of the range of transformable plants. In many cases either plantlets cultured *in vitro* or isolated protoplasts are used as the targets for genetic transformation.

*In-vitro* culture usually forms part of the overall transformation protocol, as the transformed cells must be separated from those non-transformed and regenerated to viable plants or permanent tissue cultures. In cases where transformed cells can be regenerated into whole and fertile plants, cultivars with new traits can be created.

### 8.4.2 Germplasm Storage

The maintenance and analysis of hundreds of cell culture lines or organ cultures is a labor-intensive task, especially when many cell cultures grow quite rapidly and require transfer to fresh medium almost weekly. In addition, the risk of losing material because of microbial contamination, technical or human errors is always present. Therefore, efforts have been undertaken to develop methods for storing plant cells in a convenient way, at minimal personnel expense. One means of limiting growth is to reduce the cultivation temperature. Alternatively (or in addition), growth-retardant chemicals such as phytohormones (abscisic acid) or osmotics (mannitol) may be added to the culture medium to achieve reduced growth rates.

The deposition of plant tissue at cryogenic temperatures with retention of viability (cryopreservation) is another option for long-term storage. Initially, cryopreser-

vation was driven by the concern for loss of diversity of crops. Highly sophisticated protocols, including two-stage freezing, vitrification and encapsulation-dehydration, have been developed (e.g., Withers, 1983; Bajaj, 1995b; Towill and Bajaj, 2002). The main drawback for the broad utilization of cryopreservation in the storage of plant germplasm is the lack of standardized protocols. In particular, cell suspension cultures with a high content of secondary metabolites are still recalcitrant to cryopreservation, because of the possible autotoxicity of the secondary compounds that accumulate in these cells. During freezing and thawing membranes may become permeable, such that compounds usually stored in a safe intracellular location may leak and consequently inhibit metabolic processes. With regard to genetic stability, it has been shown that variety-specific characteristics have not been changed by storage in liquid nitrogen (Mix-Wagner et al., 2003).

## 8.5

### Permanent *In-Vitro* Cultures

#### 8.5.1

##### Cell Suspension Culture

Callus can be submerged in liquid media, where it usually disintegrates into small cell aggregates; suspension cultures can be established in this way. Real single-cell suspensions have been reported, but in most cases cell aggregates are eventually formed. Suspension-cultured plant cells can be maintained in a dedifferentiated state with rather uncoordinated cell division over long periods of time. With regard to homogeneity and genetic stability, the same limitations as described for callus apply, though cells in suspension proliferate more rapidly than callus cells. Growth can be followed simply by assessing various parameters that are associated either directly or indirectly with growth, such as cell number, fresh and dry mass, mitotic index, medium components (e.g., sugar, phosphate), medium conductivity (Allan, 1991), or – non-invasively – by packed cell volume (Blom et al., 1992).

Since plant cell cultures can be cultivated on a large scale in commercial bioreactors they may serve as an alternative source for the production of plant secondary metabolites (Alfermann and Petersen, 1995; Scragg, 1997; Ramachandra Rao and Ravishankar, 2002; Vanisree et al., 2004). Arguments scored for this assumption are that:

- the production will not dependent on geographical, political, and seasonal factors;
- defined protocols and production systems offer reliable yield and quality; and
- products not known from nature can be produced either *de novo* or by biotransformation using cheap precursors.

It was supposed that, concomitant with their totipotency, cells cultivated *in vitro* should also be capable of producing compounds normally associated with the intact plant. Hence, it was tempting to use plant cells for producing important phy-

**Table 8.2** Examples of pharmaceuticals accumulating in plant cell cultures in high concentrations.

<i>Plant species</i>	<i>Product</i>	<i>Yield [% DW]</i>
<i>Salvia officinalis</i>	Rosmarinic acid	36.0
<i>Morinda citrifolia</i>	Anthraquinones	18.0
<i>Lithospermum erythrorhizon</i>	Shikonin	12.4
<i>Thalictrum minus</i>	Berberine	10.6
<i>Berberis wilsonae</i>	Jatrorrhizin	10.0
<i>Perilla frutescens</i>	Anthocyanins	8.9
<i>Dioscorea deltoidea</i>	Diosgenin	3.8
<i>Papaver somniferum</i>	Sanguinarine	2.5
<i>Catharanthus roseus</i>	Serpentine	2.2

DW, dry weight.

tochemicals with masses of highly productive cells that could be cultivated in the same way as microorganisms in large bioreactors. However, secondary product formation may be an integral part of a differentiation program, and a result of differential expression of genetic information. It was not too surprising to find that some important target compounds could not be produced by suspension-cultured cells. However, a number of plant cell cultures are able to accumulate larger quantities of secondary metabolites than the intact plant (Table 8.2).

In higher plants, certain biochemical traits are only fully developed in specific organs, or during specific developmental stages, and secondary product formation is often associated with structural differentiation. Product accumulation may be associated with: (i) the presence of certain cell types; (ii) the presence of certain organelles; and (iii) the expression and regulation of biosynthetic or catabolic genes. Therefore, with a view to producing plant secondary metabolites *in vitro*, it is important to consider not only suspensions consisting of very small cell aggregates but also organ cultures, such as root or shoot cultures that can be cultivated on a large scale.

### 8.5.2

#### Root Culture

Root cultures can be established using different approaches. One method is based on the infection of suitable tissues with *Agrobacterium rhizogenes*, which recognizes signal molecules (e.g., acetosyringone,  $\alpha$ -hydroxy-actosyringone) exuded by susceptible wounded plant cells and attaches to them. The infection of plants with *A. rhizogenes* results in the development of hairy roots at the site of infection. These developing roots can be removed and transferred several times to fresh antibiotic-containing medium before a stable axenic hairy root culture can be established. Usually, hairy roots are fast-growing and require no external supply of growth hormones (Giri and Narasu, 2000). In 1990, Tepfer reported that stable hairy root cultures had been obtained from 116 plant species belonging to 30 dicotyledonous

families, and today root cultures of this type are used in many laboratories. Root-derived plant products not produced by cell suspension culture are currently being reinvestigated for production using the hairy root culture technology (Table 8.3).

Adventitious root formation can be induced in callus by changing the phytohormone balance (see Fig. 8.2), whereafter the roots can be excised and cultivated further. Root formation can be triggered back and forth by changing the phytohormone regime. With regard to secondary metabolite formation and accumulation, it has been shown that some metabolites are produced only at the root culture stage (Flores et al., 1987). The growth and productivity of transformed and non-transformed root cultures have been compared in several reports, but convincing evidence to support the assumption that transformed roots generally have faster growth rates or higher production rates than their non-transformed counterparts is still lacking.

**Table 8.3** Examples of secondary metabolites produced in hairy root cultures of medicinal plants.

<i>Plant</i>	<i>Product</i>
<i>Artemisia absinthum</i>	Essential oils
<i>Artemisia annua</i>	Artemisinin
<i>Atropa belladonna</i>	Atropine
<i>Cassia obtusifolia</i>	Anthraquinones
<i>Catharanthus roseus</i>	Indole alkaloids
<i>Centranthus ruber</i>	Valepotriates
<i>Cinchona ledgeriana</i>	Quinine
<i>Coleus forskohlii</i>	Forskolin
<i>Datura stramonium</i>	Tropane alkaloids
<i>Digitalis purpurea</i>	Cardenolides
<i>Duboisia myoporoides</i>	Scopolamine
<i>Echinacea purpurea</i>	Alkamides
<i>Fagopyrum esculentum</i>	Flavanol
<i>Glycyrrhiza glabra</i>	Flavonoids
<i>Hyoscyamus muticus</i>	Tropane alkaloids
<i>Hyoscyamus niger</i>	Hyoscyamine
<i>Linum flavum</i>	Lignans
<i>Lithospermum erythrorhizon</i>	Shikonin, benzoquinone
<i>Nicotiana tabacum</i>	Nicotine, anatabine
<i>Panax ginseng</i>	Saponins
<i>Papaver somniferum</i>	Codeine
<i>Rauwolfia serpentina</i>	Reserpine
<i>Rubia tinctorum</i>	Anthroquinone
<i>Sesamum indicum</i>	Naphthoquinone
<i>Solanum laciniatum</i>	Steroidal alkaloids
<i>Tanacetum parthenium</i>	Sesquiterpene coumarin ether
<i>Trigonella foenum graecum</i>	Diosgenin
<i>Valeriana officinalis</i>	Valepotriates

Root cultures show a greater genetic stability than suspension cultures. The selection of well-growing cells during subculture and scale-up is unlikely, and hence productive stability is more reliable than with cell suspension cultures. Root cultures can be cultivated in large vessels and may be regarded as biocatalysts immobilized in their own organic matrix; therefore, the engineering advantages for immobilized cells may apply.

### 8.5.3

#### Shoot Culture

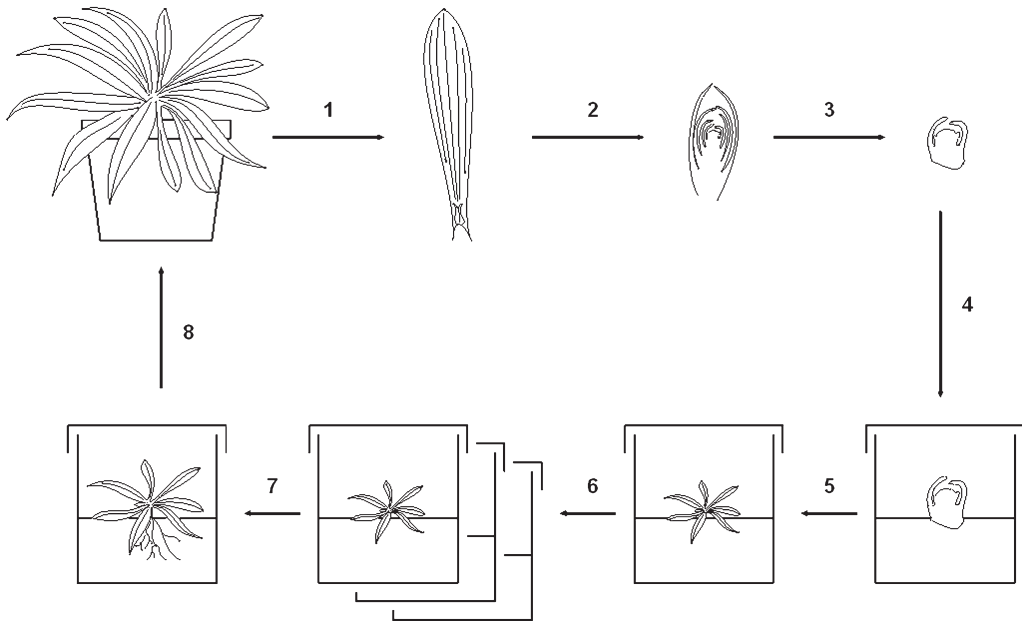
Shoot cultures are free of intervening roots and undifferentiated callus. As in the case of root cultures, shoot cultures may produce secondary metabolites that are not seen in non-differentiated cultures (Table 8.4). Although anticipated, shoot cultures will not produce all compounds seen in the leaves of intact plants. If the site of synthesis of a given compound is the root, then it will not appear in cultured shoots even if the leaves are the sink for these metabolites. Even if the compounds of interest are produced in a given shoot culture (see Table 8.4), product patterns and concentrations may differ from those seen in the intact plant.

Shoot cultures can be initiated in several ways (Payne et al., 1992). Typically, they are initiated from sterile germinated seedlings, but they can also be obtained from dissected shoot apical meristems (Fig. 8.4) or from stem sections, as well as from callus. Shoot cultures can be propagated on agar-solidified media or as amphibian cultures in liquid media. These two types of shoot culture may differ considerably with respect to their morphology; in particular, the leaves may remain rather small and rudimentary in amphibian cultures. Since shoot differentiation enables the expression of several biosynthetic pathways, amphibian cultures may accumulate lesser quantities of secondary metabolites than shoots cultured on solid media. Cytokinins stimulate shoot growth and are thus added to the culture media, which often contain reduced levels of some macronutrients (e.g., nitrogen-containing salts) as compared to cell suspension cultures. Although shoot cultures are photosynthetically active, sugars are usually added to the culture media to boost growth.

**Table 8.4** Examples of secondary metabolites in shoot cultures of medicinal plants.

<i>Plant species</i>	<i>Product</i>
<i>Artemisia annua</i>	Artemesinin
<i>Atropa belladonna</i>	Atropine
<i>Catharanthus roseus</i>	Vindoline
<i>Cinchona</i> spp.	Vinblastine, quinine
<i>Digitalis lanata</i>	Cardenolides
<i>Digitalis purpurea</i>	Cardenolides
<i>Picrorrhiza kurroa</i>	Kutkin
<i>Stevia rebaudiana</i>	Steviosides
<i>Withania somniferum</i>	Withanolides
<i>Dicentra pergrina</i>	Alkaloids





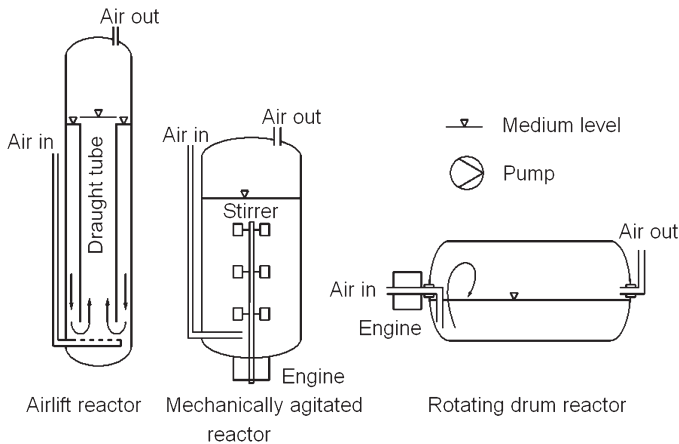
**Fig. 8.4** *In-vitro* propagation and regeneration via meristem culture. 1–3: Preparation of apical meristem from axial buds. 4–6: Cultivation and multiple shoot formation. 7: Rooting *in vitro*. 8: Regeneration of intact plants.

Shoot cultures are regarded as being genetically more stable than non-differentiated callus or suspension cultures; this is an important point, as most shoot cultures have been initiated with a view towards micropropagation (Bajaj, 1991, 1992a,b,c, 1997a,b). Rooting can be achieved when shoots are transferred to agar-solidified media containing auxins only, with roots generally developing within two weeks.

#### 8.5.4

##### **Bioreactors**

The initial studies on the production of a particular natural compound by plant tissue culture are carried out with small tissue samples grown in shake flasks or other small vessels. Most of the physiological and biochemical experiments designed to elucidate metabolic pathways can be performed with cells cultured under these conditions. Since mass cultivation of plant cells has been proposed as an alternative way for supplying important phytochemicals, it was necessary to develop systems that would allow plant cells to be cultivated on a large scale (Kreis and Reinhard, 1989; Payne et al., 1992; Ramachandra Rao and Ravishankar, 2002). However scale-up – that is, the reproduction on a larger scale of a production process developed on a smaller scale – is not feasible with this type of vessel. Thus, if cultivation in larger volumes is planned, then bioreactors must be used (Fig. 8.5). One advantage of bioreactors is that they are scalable – that is, it is possible to reproduce



**Fig. 8.5** Bioreactors used for the cultivation of plant cells with a view to producing secondary metabolites.

on a large scale those conditions which were found conducive to optimal production on a smaller scale. With regard to scale-up, the maintenance of constant environmental conditions at the various scales of operation is simple in terms of the soluble components (nutrients), but more difficult with respect to the physical environment (shear, mixing, gas transfer).

The most common type of reactor for culturing plant cells is the mechanically agitated vessel, also called a stirred-tank bioreactor. This type of reactor uses impellers of various types for gas-liquid transfer and mixing. Because of the shear sensitivity of plant cells, low agitation speeds of about 100 to 300 rpm are appropriate. Unfortunately, however, these low speeds are generally insufficient to break the incoming gas stream into small bubbles, and in order to obtain sufficient oxygen transfer the incoming gas stream is dispersed as fine bubbles using a perforated ring or sintered glass or metal.

The second type of bioreactors used in plant cell cultivation is the pneumatically agitated bioreactor, most often referred to as the air-lift fermentor. Here, agitation is coupled to aeration, and consequently it may be necessary to use higher gas flow rates to provide mixing than would be required for oxygen transfer. More recently, the trend has been towards the use of mechanically agitated bioreactors, though at present no guidelines can be given concerning the best stirrer-type. Since metabolic activity is a function of the surface area of an organism, it is evident that growth and production rates are much lower in the case of plant cell cultures than microbial cells. In microbes, secondary metabolite production is generally not associated with biomass production, and generally the products are released into the bathing medium. Production rates are generally high, and production phases short. In the case of plant cell cultures, growth is quite slow, metabolite production is low, and usually the products are stored in the cells. Most plant cell culture processes have productivities between 0.025 and 1.0 g L<sup>-1</sup> per day (see Table 8.5). Thus, the goal

must be to make less-productive cells more productive, or to place as many cells as possible into a bioreactor (Matsubara et al. 1989).

Depending on the characteristics of product formation, fermentation can be operated in different modes. The operating mode refers to how the nutrient and product streams are supplied or removed with respect to time, with the appropriate operating mode depending on the timing of product synthesis and growth.

- When all nutrients the culture requires are supplied initially this operating mode is termed *batch operation*, which may be regarded as the standard operation mode:
- In *fed-batch operation* the nutrients (including elicitors and precursors) are fed either at intervals or continuously. A fed-batch mode is justified if it were detrimental to the cells to supply all of the nutrients in one operation.
- In *repeated fed-batch operation*, a substantial portion of the spent medium or the cell suspension is withdrawn and replaced with fresh culture medium, and in this way the culture can be reactivated. Overall productivity may be improved, mainly because the bioreactor can be used for several consecutive production runs without the need of cleaning and sterilization.
- A *two-stage batch operation* is appropriate for non-growth-associated products, and also offers the possibility of medium exchange, where the first medium supports rapid growth and the second medium supports product synthesis.
- The term *chemostat* refers to the operation in which fresh medium is continuously fed to the bioreactor and a stream of suspension is continuously withdrawn. In plant cell culture, a chemostat mode is mainly used as an experimental tool (van Gulik et al., 1993) rather than for secondary product synthesis.
- In a *perfusion operation*, fresh medium is added to the vessel continuously and spent medium (but not cells, as in the chemostat) are withdrawn continuously. In general, the perfusion reactor is appropriate for non-growth-associated product synthesis and immobilized systems.

The demands for bioreactors devised for use with root cultures and shoot cultures are different, and thus considered separately. It was mentioned earlier that shoot or root differentiation sometimes enables the expression of biosynthetic pathways that are expressed at very low levels or not at all in cell suspension cultures. The scale-up of shoot cultures in bioreactors poses several challenges, largely stemming from the cells' unique morphological characteristics, their susceptibility to mechanical damage, possible vitrification, and light requirements (Payne et al., 1992). Production processes with cultured shoots are unlikely to be substituted for field-grown plants, though they may provide excellent systems to study biosynthetic sequences not operative in suspension cultures.

Root cultures, on the other hand, may serve as good candidates for the production of root-specific metabolites. In order to enhance the productivity of hairy root cultures, various methods have been used, including the selection of high-producing clones and elicitation. Bioreactor set-ups have been designed for the cultivation

of roots on a large scale (Wysokinska and Chmiel, 1997; Giri and Narasu, 2000), though in general cultured roots form loosely entangled mats and it is not necessary (it may even be deleterious) to use stirrers in order to provide mixing. The use of mist bioreactors also appears promising (Wysokinska and Chmiel, 1997). Roots may be regarded as a form of an immobilized system, and consequently techniques developed for immobilized cells can be employed. The bioreactor system described by Wilson et al. (1990) contains an immobilization matrix, comprised of a series of stainless steel barbs, to which roots may attach. The vessel can be run in either submerged mode or mist-phase mode. Root cultures may also serve as good candidates for processes using perfusion operation.

## 8.6

### Methods and Techniques Related to Secondary Metabolism

#### 8.6.1

##### Inducing Variability

*In-vitro* culture techniques can be used to select variant cells from which improved cell lines or plants may be established. Variation can be enhanced by the use of induced physical or chemical mutagenesis (Ahloowahlia, 1998; Donini and Sonnino, 1998). Even without mutagenic treatment plant tissues show genetic instability when cultured *in vitro* (Stafford, 1991). Variability in embryogenic and regenerative potential has frequently been reported, and permanent plant cell cultures may exhibit variation in product yield over successive subcultures. Variability may to some extent also reflect the fact that cell cultures are usually not of clonal origin, and that fast-growing cells may be selected during successive subculture. This involves the fact that rapidly proliferating cells may be more susceptible to mutations, and that the culture conditions themselves may therefore be regarded as mutagenic. This may be problematic for the preservation and micropropagation of elite plants, but for the generation of variant plants this phenomenon offers possibilities (Evans and Sharp, 1986; Bajaj, 1990b). Variation occurring in plants regenerated from tissue culture is termed “somaclonal variation” (Larkin and Scowcroft, 1981). The regenerated “somaclones” may be stable, but this may not be taken as a rule since somaclonal variation is most likely a result of both mutations and reversible epigenetic changes.

Related to somaclonal variation is the question of the stability of plant cell suspension cultures with regard to their biosynthetic potential. As cell cultures are neither homogeneous nor synchronous with regard to their mitotic cycle, rapidly dividing but non-producing cells may eventually overgrow the producing cells, and this would result in productivity loss. Indeed, this has been reported for many plant cell suspension cultures, including those of important medicinal plants (Stafford, 1991). This phenomenon constitutes a clear problem for the commercialization of any plant cell culture process if a given elite cell culture might lose its high-yield character, even during production of the cell mass required for a large culture

vessel. The “apparent” stability (meta-stability) of a given cell culture may be the effect of a strict subculture regime (Ulbrich et al., 1985; Fowler, 1988) rather than the result of the clonal origin of the cells.

### 8.6.2

#### Selection

Elite cell lines are obtained by selection following a variety of strategies that include macroscopic, microscopic and chemical inspections. Cell-aggregates or protoplasts may be used as the starting material for selection (for a comprehensive description, see Dix, 1990). Selection can be easily achieved if the product of interest is a pigment (Fujita et al., 1984). The screening and selection of high-producing cell lines has not been successful in all cases, however. For example, cell cultures of opium poppy (*Papaver somniferum*) were initiated in many laboratories worldwide with a view to producing codeine in large quantities. As yet, unfortunately, all approaches have failed as poppy cell cultures simply do not produce considerable amounts of morphinanes (Table 8.5).

**Table 8.5** Examples of productivity of plant cell cultures.

<i>Plant species</i>	<i>Product</i>	<i>Productivity</i> [mg L <sup>-1</sup> day <sup>-1</sup> ]
<i>Castanospermum australe</i>	Castanospermine	0.05
<i>Catharanthus roseus</i>	Ajmalicin	4
<i>Coptis japonica</i>	Berberin	600
<i>Dioscorea deltoidea</i>	Diosgenin	10
<i>Lithospermum erythrorhizon</i>	Shikonin	150
<i>Marchantia polymorpha</i>	Arachidonic acid	4.4
<i>Papaver somniferum</i>	Codeine	0.25
	Sanguinarin	34
<i>Taxus canadensis</i>	Paclitaxel	10

### 8.6.3

#### Biotransformation

Although many plant cell suspension cultures fail to produce the compounds seen in the plants from which they have been established, these cells may be used in biotransformation processes where exogenous organic compounds are modified by living cells. For any organism, biotransformation represents a means of coping with lipophilic xenobiotics that may easily cross membranes and thus accumulate in cells and tissues, where they may act as toxins. Biotransformation studies in cell suspension cultures have been carried out with a view to: (i) producing new chemicals; (ii) producing known chemicals more economically; (iii) investigating the

metabolic fate of xenobiotics; and (iv) elucidating metabolic pathways (Franssen and Walton, 1999; Giri et al., 2001).

The supply of a suitable precursor may result in the formation of a compound known from the intact plant. This would indicate that part of the biosynthetic sequence is still operating in the cultured cells. The demonstration of a biotransformation reaction *in vivo* may be a first step towards elucidating an enzyme-catalyzed conversion, or isolating biosynthetic enzymes or genes.

During the 1970s and 1980s, *Digitalis lanata* cell cultures, which had a large capacity to convert digitoxin derivatives to the respective digoxin derivatives, were selected by cell aggregate cloning. Finally, a cell culture process was developed in which metildigoxin could be prepared with good yields and almost no side reactions from 4''-*O*-methyl digitoxin (Reinhard et al., 1989). More recently, alternative approaches using *D. lanata* cells to produce digoxin-type cardenolides have been attempted, with special emphasis being placed on the use of digitoxin as the substrate for biotransformation (Kreis and Reinhard, 1992). With regard to the biotechnological application of a biotransformation process using plant cells, it must be borne in mind that plant cell cultures cannot compete with microbial systems in terms of the production rates attainable. Therefore, only those reactions that are restricted to plant cells and which yield products of high economic value can be of commercial interest.

#### 8.6.4

##### **Elicitation**

Several “non-invasive” strategies were undertaken with a view to improving productivity in plant cell culture. Some of the major roles of plant secondary metabolites are to protect plants from attack by herbivores and pathogens, or to aid in surviving other biotic and abiotic stresses. Indeed, some strategies for culture production of the metabolites based on this principle have been developed to improve the yield of such plant secondary metabolites. These include treatment with various elicitors, signal compounds, and abiotic stresses (Yukimune et al., 1996; Zhao et al., 2000, 2001, 2005).

*Elicitors* are compounds that are isolated from microorganisms and known capable of triggering secondary metabolite formation in plant cell cultures (Barz, 1988; Zhao et al., 2005). In whole plants, elicitors stimulate the formation of so-called phytoalexins as a part of pathogen defense. Jasmonates are transducers of elicitor signals for the production of plant secondary metabolites, and their exogenous application to plant cell cultures may stimulate the biosynthesis of various secondary metabolites (Gundlach et al., 1992; Farmer et al., 2003).

Many such treatments effectively promote the production of a wide range of plant secondary metabolites, but to date only the production of shikonin by *Lithospermum erythrorhizon* cell cultures and of taxol by *Taxus* cell cultures have been successfully industrialized. The elicitor approach was not successful in all cases: codeine biosynthesis, for example, has not yet been achieved. However, compounds sharing the same precursors and intermediates, such as the antimicrobial

alkaloid sanguinarine, may accumulate in quite high amounts. Using cell cultures of *Papaver somniferum*, the production of sanguinarine was shown to be “elicited” by preparations from fungal mycelia (Eilert and Constabel, 1986; Park et al., 1992).

In the above-mentioned example, the fungal preparation simulated the pathogen attack, whereupon sanguinarine production was increased in the presence of the elicitor compared to the control without fungal mycelia.

#### 8.6.5

##### **Immobilization and Permeation**

Immobilization is a technique which traps catalytically active cells or enzymes in a matrix, thus preventing them from entering the mobile phase. The main types of immobilization are adsorption (e.g., to polystyrene or glass), covalent attachment (e.g., by glutaraldehyde or carbodiimide coupling) and entrapment (e.g., alginate or agarose) (Yeoman, 1987; Scragg, 1991). Immobilization has distinct advantages: (i) the biomass can be retained and utilized continuously; (ii) high biomass levels can be achieved; and (iii) cells can easily be separated from the spent medium. However, it is essential that product formation is not strictly associated with growth, and that cell growth can be suppressed in order to prevent disintegration of the immobilization matrix. Assuming that immobilized cells maintain prolonged viability and biosynthetic capacity, the product should leach out of the cells and beads into the medium. Although Brodelius et al. (1979) were the first to immobilize plant cells, this approach has subsequently been used for the *de-novo* biosynthesis of secondary metabolites as well as for biotransformations (Payne et al., 1992; Ramachandra Rao and Ravishankar, 2002). A special application of an immobilization technique may be seen in the entrapment of somatic embryos with a view towards the production of artificial seeds (see Section 8.2.6).

One very important point for the success of an immobilized system is that of product release. In microbial processes, the products are generally released into the bathing medium from which they can be extracted with ease. In plant cells, however, natural products are usually stored in the vacuole, and in order for them to be released the two membranes, namely the tonoplast and plasma membrane, must be penetrated. Several methods have been attempted to release intracellular products without affecting cell viability (Brodelius and Nilsson, 1983; Knorr et al., 1985; Parr et al., 1987). Dimethylsulfoxide is widely used as a permeabilizing agent (e.g., Parr et al., 1984), while ultrasonication, electroporation and ultra-high pressure have also been used to recover secondary metabolites (Dornenburg and Knorr, 1993; Brodelius et al., 1988).

#### 8.7

##### **Conclusions**

The *in-vitro* cultivation of plant cells and organs has become a relatively simple task. Some of the methods described are commercially used worldwide in plant

breeding, micropropagation and the generation of disease-free stocks. The ability to regenerate fertile plants from explants and selected or engineered cells is the most important aspect of medicinal plant biotechnology. Although permanent cell and organ cultures can produce a wide range of compounds used in medicine, there are few success stories of production at the commercial scale. However, *in-vitro* cultures provide useful systems to study the biosynthetic pathways leading to plant secondary metabolites at the enzyme level. In this respect, plant tissue cultures have turned out to be a “a pot of gold” for those seeking to identify and isolate the enzymes and genes of secondary metabolism (Zenk, 1991). *In-vitro* culturing techniques are also exploited in genetic engineering of plants; for example, transgenic *Atropa belladonna* plants producing scopolamine instead of hyoscyamine (Yun et al., 1992) provided the first example of how pharmaceutically important plants could be engineered successfully.

## References

- Ahloowalia, B.S. In vitro techniques and mutagenesis for the improvement of vegetatively propagated plants. In: Jain, S.M., Brar, D.S., Ahloowalia, B.S. (Eds.), *Somaclonal Variation and Induced Mutations in Crop Improvement*. Kluwer Academic Publishers, Dordrecht, 1998, pp. 293–310.
- Al-Abta, S., Galpin, I.J., Collin, H.A. Flavor compounds in tissue cultures of celery. *Plant Sci. Lett.* 1979, 16, 129–134.
- Alfermann, A.W., Petersen, M. Natural product formation by plant cell biotechnology. Results and perspectives. *Plant Cell, Tissue Organ Culture* 1995, 43, 199–205.
- Allan, E. Plant cell culture. In: Stafford, A., Warren, G. (Eds.), *Plant Cell and Tissue Culture*. Open University Press, Milton Keynes, 1991, pp. 1–24.
- Atanassov, A., Zagorska, N., Boyadjiev, P., Djilianov, D. In vitro production of haploid plants. *World J. Microbiol. Biotechnol.* 1995, 11, 400–408.
- Bajaj, Y.P.S. (Ed.), *Biotechnology in Agriculture and Forestry, Vol. 12, Haploids in Crop Improvement I*. Springer, Berlin, Heidelberg, New York, 1990a.
- Bajaj, Y.P.S. (Ed.), *Biotechnology in Agriculture and Forestry, Vol. 11, Somaclonal Variation in Crop Improvement I*. Springer, Berlin, Heidelberg, New York, 1990b.
- Bajaj, Y.P.S. (Ed.), *Biotechnology in Agriculture and Forestry, Vol. 17, High-Tech and Micropropagation I*. Springer, Berlin, Heidelberg, New York, 1991.
- Bajaj, Y.P.S. (Ed.), *Biotechnology in Agriculture and Forestry, Vol. 18, High-Tech and Micropropagation II*. Springer, Berlin, Heidelberg, New York, 1992a.
- Bajaj, Y.P.S. (Ed.), *Biotechnology in Agriculture and Forestry, Vol. 19, High-Tech and Micropropagation III*. Springer, Berlin, Heidelberg, New York, 1992b.
- Bajaj, Y.P.S. (Ed.), *Biotechnology in Agriculture and Forestry, Vol. 20, High-Tech and Micropropagation IV*. Springer, Berlin, Heidelberg, New York, 1992c.
- Bajaj, Y.P.S. (Ed.), *Biotechnology in Agriculture and Forestry, Vol. 29, Plant Protoplasts and Genetic Engineering V*. Springer, Berlin, Heidelberg, New York, 1994a.
- Bajaj, Y.P.S. (Ed.), *Biotechnology in Agriculture and Forestry, Vol. 27, Somatic Hybridization in Crop Improvement I*. Springer, Berlin, Heidelberg, New York, 1994b.
- Bajaj, Y.P.S. (Ed.), *Biotechnology in Agriculture and Forestry, Vol. 30, Somatic Embryogenesis and Synthetic Seed I*. Springer, Berlin, Heidelberg, New York, 1995a.
- Bajaj, Y.P.S. (Ed.), *Biotechnology in Agriculture and Forestry, Vol. 32, Cryopreservation of Plant Germplasm I*. Springer, Berlin, Heidelberg, New York, 1995b.



- Bajaj, Y.P.S. (Ed.), *Biotechnology in Agriculture and Forestry*, Vol. 40, *High-Tech and Micropropagation VI*. Springer, Berlin, Heidelberg, New York, 1997a.
- Bajaj, Y.P.S. (Ed.), *Biotechnology in Agriculture and Forestry*, Vol. 39, *High-Tech and Micropropagation V*. Springer, Berlin, Heidelberg, New York, 1997b.
- Barz, W. Elicitation and metabolism of photoalexins in plant cell cultures. In: *Applications of Plant Cell and Tissue Culture*. Ciba Foundation Symposium 137, John Wiley & Sons, Chichester, 1988, pp. 239–253.
- Binder, K.A., Wegner, L.H., Heidecker, M., Zimmermann, U. Gating of Cl<sup>-</sup> currents in protoplasts from the marine alga *Valonia utricularis* depends on the transmembrane Cl<sup>-</sup> gradient and is affected by enzymatic cell wall degradation. *J. Membr. Biol.* 2003, 191, 165–178.
- Blom, T.J.M., Kreis, W., Van Iren, F., Libbenga, K.R. A non-invasive method for the routine-estimation of fresh weight of cells grown in batch suspension cultures. *Plant Cell Rep.* 1992, 11, 146–149.
- Brodelius, P., Nilsson, K. Permeabilization of immobilized plant cells resulting in release of intracellularly stored products with preserved cell viability. *Eur. J. Appl. Microbiol. Biotechnol.* 1983, 17, 275–280.
- Brodelius, P., Deus, B., Mosbach, K., Zenk, M.H. Immobilized plant cells for the production of natural products. *FEBS Lett.* 1979, 103, 93–97.
- Brodelius, P., Funk, C., Shillito, R.D. Permeabilization of cultured plant cells by electroporation for the release of intracellularly stored secondary products. *Plant Cell Rep.* 1988, 7, 186–188.
- Cervelli, R., Senaratna, T. Economic aspects of somatic embryogenesis. In: Aitken-Christie, J., Kozai, T., Smith, L. (Eds.), *Automation and Environmental Control in Plant Tissue Culture*. Kluwer Academic Publishers, Dordrecht, 1995, pp. 29–64.
- Chilton, M.D., Drummond, M.H., Merio, D.J., Sciaky, D., Montoya, A.L., Gordon, M.P., Nester, E.W. Stable incorporation of plasmid DNA into higher plant cells: the molecular basis of crown gall tumorigenesis. *Cell* 1977, 11, 263–271.
- Cocking, E.C. A method for the isolation of plant protoplasts and vacuoles. *Nature* 1960, 187, 927–929.
- Davey, M.R., Lowe, K.C., Power, J.B. Protoplast fusion for the generation of unique plants. In: Spier, R.E. (Ed.), *Encyclopaedia of Cell Technology*. John Wiley & Sons, New York, 2000, pp. 1090–1096.
- Davey, M.R., Anthony, P., Power, J.B., Lowe, K.C. Plant protoplasts: status and biotechnological perspectives. *Biotechnology Adv.* 2005, 23, 131–171.
- Day, P., Zaitlin, M., Hollaender, A. *Biotechnology in Plant Science*. Academic Press, Florida, 1985.
- Dix, P. *Plant Cell Line Selection: Procedures and Applications*. VCH, Weinheim, 1990.
- Donini, P., Sonnino A. Induced mutation in plant breeding: current status and future outlook. In: Jain, S.M., Brar, D.S., Ahloowalia, B.S. (Eds.), *Somaclonal Variation and Induced Mutations in Crop Improvement*. Kluwer Academic Publishers, Dordrecht, 1998, pp. 255–292.
- Dornenburg, H., Knorr, D. Cellular permeabilization of cultured tissues by high electric field pulses or ultra high pressure for the recovery of secondary metabolites. *Food Biotechnol.* 1993, 7, 35–28.
- Ducos, J.-P., Bollon, H., Pettard, V. Production of carrot somatic embryos in a bioreactor. *Appl. Microbiol. Biotechnol.* 1993, 39, 465–470.
- Eeva, M., Ojala, T., Tammela, P., Galambosi, B., Vuorela, H., Hiltunen, R., Fagerstedt, K., Vuorela, P. Propagation of *Angelica archangelica* plants in an air-sparged bioreactor from a novel embryogenic cell line, and their production of coumarins. *Biol. Plant.* 2003, 46, 321–480.
- Eilert, U., Constabel, F. Elicitation of sanguinarine accumulation in *Papaver somniferum* cells by fungal homogenates: An induction process. *J. Plant Physiol.* 1986, 125, 167–172.
- Eriksson, T.R. Protoplast isolation and culture. In: Fowke, L.C., Constabel, F. (Eds.), *Plant Protoplasts*. CRC Press, 1985.
- Evans, D.A., Sharp, W.R. Applications of somaclonal variation. *Biotechnology* 1986, 4, 528–532.
- Evans, D.A., Sharp, W.R., Medina-Filho, H.P. Somaclonal and gametoclonal variation. *Am. J. Bot.* 1984, 71, 759–774.
- Farmer, E.E., Alm eras, E., Krishnamurthy, V. Jasmonates and related oxylipins in plant responses to pathogenesis and herbivory.

- Curr. Opin. Plant Biol.* **2003**, *6*, 372–378.
- Flores, H.E., Hoy, M.W., Puckard, J.J. Secondary metabolites from root cultures. *Trends Biotechnol.* **1987**, *5*, 64–69.
- Fowler, F.M. Problems in commercial exploitation of plant cell cultures. In: *Applications of Plant Cell and Tissue Culture*. Ciba Foundation Symposium 137, John Wiley & Sons, Chichester, **1988**, pp. 239–253.
- Franssen, M.C.R., Walton, M.J. Biotransformations. In: Walton, M.J., Brown, D.E. (Eds.), *Chemicals from Plants, Perspectives on Plant Secondary Products*. Imperial College Press, London, **1999**, pp. 277–325.
- Fujita, Y., Takahashi, S., Yamada, Y. Selection of cell lines with high productivity of shikonin derivatives through protoplasts of *Lithospermum erythrorhizon*. *Proceedings, 3rd European Congress on Biotechnology 1984*, Volume 1, pp. 161–166.
- Gamborg, O.L., Miller, R.A., Ojima, K. Nutrient requirements of suspension cultures of soybean root cells. *Exp. Cell Res.* **1968**, *50*, 151–158.
- Gautheret, R.J. Culture du tissu cambial. *C. R. Acad. Sci.* **1934**, *198*, 2195–2196.
- Giri, A., Narasu, M.L. Transgenic hairy roots: recent trends and applications. *Biotechnol. Adv.* **2000**, *18*, 1–22.
- Giri, A., Dhingra, V., Giri C.C., Singh, A., Ward, O.P., Narasu, M. L. Biotransformations using plant cells, organ cultures and enzyme systems: current trends and future prospects. *Biotechnology Adv.* **2001**, *19*, 175–199.
- Greidziac, N., Dietrich, B., Luckner, M. Batch culture of somatic embryos of *Digitalis lanata* in gaslift fermentors. Development and cardenolide accumulation. *Planta Med.* **1990**, *56*, 175–178.
- Guha, S., Maheshwari, S.C. *In vitro* production of embryos from anthers of *Datura*. *Nature* **1964**, *204*, 497.
- Gundlach, H., Müller, M.J., Kutchan, T.M., Zenk, M.H. Jasmonic acid is a signal transducer in elicitor-induced plant cell cultures. *Proc. Natl. Acad. Sci. USA* **1992**, *89*, 2389–2393.
- Gupta, P.K., Pullman, G., Timmis, R., Kreitinger, M., Carlson, W.C., Grob, J., Welty, E. Forestry in the 21st Century. *Biotechnology* **1993**, *11*, 454–459.
- Hoykaas, P.J.J. *Agrobacterium*, a natural metabolic engineer of plants. In: Verpoorte, R., Alfermann, A.W. (Eds.), *Metabolic Engineering of Plant Secondary Metabolism*. Kluwer Academic Publishers, Dordrecht, Boston, London, **2000**, pp. 51–67.
- Hu, H., Zeng, J.Z. Development of new varieties via anther culture. In: Ammirato, P.V., Evans, D.A., Sharp, W.R., Yamada, Y. (Eds.), *Handbook of Plant Oil Culture*, Vol. 3. Macmillan, New York, **1984**, pp. 65–90.
- Jain, S.M., Sopory, S.K., Veilleux, R.E.E. (Eds.) *In Vitro Haploid Production in Higher Plants*. Kluwer Academic Publishers, Dordrecht, **1997**.
- Kao, K.N., Michayluk, M.R. A method for high-frequency intergeneric fusion of plant protoplast. *Planta* **1975**, *115*, 355–367.
- Kitsaki, C.K., Zygouraki, S., Ziobora, M., Kintzios, S. In vitro germination, protocorm formation and plantlet development of mature versus immature seeds from several *Ophrys* species (Orchidaceae). *Plant Cell Rep.* **2004**, *23*, 284–290.
- Knorr, D., Miazga, S.M., Teutonico, R.A. Immobilization and permeabilization of cultured plant cells. *Food Technol.* **1985**, *39*, 139–142.
- Krasnyanski, S., Ball, T.M., Sink, K.C. Somatic hybridization in mint: identification and characterization of *Mentha piperita* (+) *M. spicata* hybrid plants. *Theoret. Appl. Genet.* **1998**, *96*, 683–687.
- Kreis, W. Plant cell, tissue and organ cultures as tools for the elucidation of biosynthetic pathways. In: Sprecher, E., Caesar, W. (Eds.), *Gesellschaft für Arzneipflanzenforschung: 50 Years 1953–2003: A Jubilee Edition*. Wissenschaftliche Verlagsgesellschaft, Stuttgart, **2003**, pp. 123–136.
- Kreis, W., Reinhard, E. The production of secondary metabolites by plant cells cultivated in bioreactors. *Planta Med.* **1989**, *55*, 409–416.
- Kreis, W., Reinhard, E. 12 $\beta$ -Hydroxylation of digitoxin by suspension-cultured *Digitalis lanata* cells. Production of digoxin in 20-litre and 300-litre airlift bioreactors. *J. Biotechnol.* **1992**, *26*, 257–273.
- Larkin, P.J., Scowcroft, W.R. Somaclonal variation – a novel source of variability from cell cultures. *Theoret. Appl. Genet.* **1981**, *67*, 197–201.

- Leech, M.J., Burtin, D., Hallard, D., Hilliou, F., Kemp, B., Palacios, N., Rocha, P., O'Callaghan, D., Verpoorte, R., Christou, P. Particle gun methodology as a tool in metabolic engineering. In: Verpoorte, R., Alfermann, A.W. (Eds.), *Metabolic Engineering of Plant Secondary Metabolism*. Kluwer Academic Publishers, Dordrecht, Boston, London, **2000**, pp. 69–86.
- Mantell, S.H., Matthews, J.A., McKee R.A. *Principles of Plant Biotechnology. An Introduction to Genetic Engineering in Plants*. Blackwell Scientific Publishers, **1985**.
- Matsubara, K., Yamada, Y., Kitani, S., Yoshioka, T., Morimoto, T., Fujita, T. High density culture *Coptis japonica* cells increases berberine production. *J. Chem. Technol. Biotechnol.* **1989**, *46*, 61–69.
- Merkle, S.A., Parrot, W.A., Flinn, B.S. Morphogenic aspects of somatic embryogenesis. In: Thorpe, T.A. (Ed.), *In Vitro Embryogenesis in Plants*. Kluwer Academic Publishers, Dordrecht **1995**, pp. 155–203.
- Mix-Wagner, G., Schumacher, H.M., Cross, R.J. Recovery of potato apices after several years of storage in liquid nitrogen. *Cryoletters* **2003**, *24*, 33–41.
- Morrison, R.A., Evans, D.A. Haploid plants from tissue culture: new plant varieties in a shortened time frame. *Biotechnology* **1988**, *6*, 684–690.
- Murashige, T. Plant propagation through tissue cultures. *Annu. Rev. Plant Physiol.* **1974**, *25*, 135–166.
- Murashige, T., Skoog, F. A revised medium for rapid growth and bioassays with tobacco tissue cultures. *Physiol. Planta* **1962**, *15*, 473–496.
- Nagata, T., Bajaj, Y.P.S. (Eds.), *Biotechnology in Agriculture and Forestry, Vol. 49, Somatic Hybridization in Crop Improvement II*. Springer, Berlin, Heidelberg, New York, **2001**.
- Osuga, K., Komamine, A. Synchronization of somatic embryogenesis from carrot cells at high frequency as a basis for the mass production of embryos. *Plant Cell Tissue Organ Cult.* **1994**, *39*, 125–135.
- Park, J.M., Yoon, S.Y., Giles, K.L., Songstad, D.D., Eppstein, D., Novakovski, D., Roewer, I. Production of sanguinarine by suspension culture of *Papaver somniferum* in bioreactor. *J. Ferm. Bioeng.* **1992**, *74*, 292–296.
- Parr, A.J., Robins, R.J., Rhodes, M.J.C. Permeabilization of *Cinchona ledgeriana* cells by dimethyl sulfoxide. Effect on alkaloid release and long term membrane integrity. *Plant Cell Rep.* **1984**, *3*, 262–265.
- Parr, A.J., Robins, R.J., Rhodes, M.J.C. Release of secondary metabolites by plant cell cultures. In: Webb, C., Mavituna, F. (Eds.), *Plant and Animal Cells: Process Possibilities*. Ellis-Horwood, Chichester, **1987**, pp. 229–237.
- Payne, G.F., Bringi, V., Prince, C., Shuler, M.L. *Plant cell and tissue culture in liquid systems*. Hanser Publishers, Munich, Vienna, New York, Barcelona, **1992**.
- Potrykus, I., Harms, C.T., Hinnen, A., Hütter, R., King, P.J., Shillito, R.D. *Protoplasts 1983*. Lecture Proceedings of 6<sup>th</sup> International Protoplast Symposium, Basel, August 12–16, 1983. *Experientia Supplement*, Vol. 46. Birkhäuser Verlag, Basel, **1983**.
- Ramachanda Rao, S., Ravishankar, G.A. Plant cell cultures: Chemical factories of secondary metabolites. *Biotechnology Adv.* **2002**, *20*, 101–153.
- Redenbaugh, K., Fugii, J.A., Slade, D. Encapsulated plant embryos. In: Mizrahi, A. (Ed.), *Biotechnology in Agriculture*. Liss, New York, **1988**, pp. 225–248.
- Reinhard, E., Kreis, W., Barthlen U., Helmbold, U. Semicontinuous cultivation of *Digitalis lanata* cells. Production of  $\beta$ -methylidigoxin in a 300-L airlift bioreactor. *Biotechnol. Bioeng.* **1989**, *34*, 502–508.
- Sato, D.M., Barnes, D., Murashige, T. Bibliography on clonal multiplication of orchids through tissue culture. *Methods Cell Sci.* **1978**, *4*, 783–786.
- Sato, H., Yamada, K., Mii, M., Hosomi, K., Okuyama, S., Uzawa, M., Ishikawa, H., Ito, Y. Production of an interspecific somatic hybrid between peppermint and gingermint. *Plant Sci.* **1996**, *115*, 101–107.
- Schenk, R.U., Hildebrandt, A.C. Medium and techniques for induction and growth of monocotyledonous and dicotyledonous plant cell cultures. *Can. J. Bot.* **1972**, *50*, 199–204.
- Scragg, A. Plant cell bioreactors. In: Stafford, A., Warren, G. (Eds.), *Plant Cell and Tissue Culture*. Open University Press, Buckingham, **1991**, pp. 221–239.

- Scragg, A.H. The production of aromas by plant cell cultures. In: Schepier, T. (Ed.), *Advances in Biochemical Engineering/Biotechnology*, Volume 55. Springer-Verlag, Berlin, 1997, pp. 239–263.
- Senaratna, T. Artificial seeds. *Biotechnology Adv.* 1992, 10, 379–392.
- Senda, M., Takeda, J., Abe, S., Nakamura, T. Induction of cell fusion of plant protoplasts by electrical stimulation. *Plant Cell Physiol.* 1979, 20, 1441–1443.
- Sharma, D.R., Kaur, R., Kumar, K. Embryo rescue in plants, a review. *Euphytica* 1996, 89, 325–337.
- Stafford, A. Genetics of cultured plant cells. In: Stafford, A., Warren, G. (Eds.), *Plant Cell and Tissue Culture*. Open University Press, Milton Keynes, 1991, pp. 25–47.
- Tepfer, D. Genetic transformation using *Agrobacterium rhizogenes*. *Physiol. Planta* 1990, 79, 14–16.
- Towill, L.E., Bajaj, Y.P.S. (Eds.), *Biotechnology in Agriculture and Forestry*, Vol. 50, *Cryopreservation of Plant Germplasm II*. Springer, Berlin, Heidelberg, New York, 2002.
- Tulecke, W. A tissue derived from the pollen of *Ginkgo biloba*. *Science* 1953, 117, 599–600.
- Ulbrich, B., Wiesner, W., Arens, H. Large-scale production of rosmarinic acid from plant cell cultures of *Coleus blumei* Benth. In: Neumann, K.H., Barz, W., Reinhard, E. (Eds.), *Primary and Secondary Metabolism of Plant Cell Cultures*. Springer-Verlag, Berlin, Heidelberg, New York, Tokyo, 1985, pp. 293–303.
- van Gulik, W.M., ten Hoopen, H.J.G., Heijnen, J.J. A structured model describing carbon and phosphate limited growth of *Catharanthus roseus* plant cell suspensions in batch and chemostat culture. *Biotechnol. Bioeng.* 1993, 41, 771–780.
- Vanisree, M., Lee, C.-Y., Lo, S.-F., Nalawade, S.M., Lin, C.Y., Tsay, H.-S. Studies on the production of some important secondary metabolites from medicinal plants by plant tissue cultures. *Bot. Bull. Acad. Sinica* 2004, 45, 1–22.
- White, P.R. Potentially unlimited growth of excised tomato root tips in a liquid medium. *Plant. Physiol.* 1934, 9, 585–600.
- White, P.R. Potentially unlimited growth of excised plant callus in an artificial nutrient. *Am. J. Bot.* 1939, 26, 59–64.
- White, P.R. Neoplastic growth in plants. *Q. Rev. Biol.* 1951, 26, 1–16.
- Wilson, P.D.G., Hilton, M.G., Meehan, P.T.H., Waspe, C.R., Rhodes, M.J.C. The cultivation of transformed roots, from laboratory to pilot plant. In: Nijkamp, H.J.J., Van der Plaas, L.H.W., Van Aartrijk, J. (Eds.), *Progress in Plant Cellular and Molecular Biology*. Kluwer Academic Publishers, Dordrecht, 1990, pp. 700–705.
- Withers, L.A. Germplasm maintenance and storage in plant biotechnology. In: Mantell, S.H., Smith, H. (Eds.), *Plant Biotechnology. Society for Experimental Biology Seminar Series 18*. Cambridge University Press, Cambridge 1983, pp. 187–218.
- Wysokinska, H., Chmiel, A. Transformed root cultures for biotechnology. *Acta Biotechnol.* 1997, 17, 131–159.
- Yeoman, M.M. Techniques, characteristics, properties, and commercial potential of immobilized plant cells. In: Constabel, F., Vasil, I. (Eds.), *Cell Culture and Somatic Cell Genetics of Plants*, Vol. 4. Academic Press, San Diego, 1987, pp. 197–215.
- Yukimune, Y., Tabata, H., Higashi, Y., Hara, Y. Methyl jasmonate-induced overproduction of paclitaxel and baccatin III in *Taxus* cell suspension cultures. *Nature Biotechnol.* 1996, 14, 1129–1132.
- Yun, D.-J., Hashimoto, H., Yamada, Y. Metabolic engineering of medicinal plants: transgenic *Atropa belladonna* with an improved alkaloid composition. *Proc. Natl. Acad. Sci. USA* 1992, 89, 11799–11803.
- Zenk, M.H. Chasing the enzymes of secondary metabolism: plant cell cultures as a pot of gold. *Phytochemistry* 1991, 30, 3861–3863.
- Zhao, J., Zhu, W.H., Hu, Q., He, X.W. Improved indole alkaloid production in *Catharanthus roseus* suspension cell cultures by various chemicals. *Biotechnol. Lett.* 2000, 22, 1221–1226.
- Zhao, J., Fujita, K., Yamada, J., Sakai, K. Improved beta-thujaplicin production in *Cupressus lusitanica* suspension cultures by fungal elicitor and methyl jasmonate. *Appl. Microbiol. Biotechnol.* 2001, 55, 301–305.
- Zhao, J., Davis, L.C., Verpoorte, R. Elicitor signal transduction leading to production of plant secondary metabolites. *Biotechnol. Adv.* 2005, 23, 283–333.

## 9

## Biotechnological Methods for Selection of High-Yielding Cell Lines and Production of Secondary Metabolites in Medicinal Plants

Donald P. Briskin

## 9.1

### Introduction

There is widespread interest in the application of plant tissue culture methods and biotechnological approaches to the production of medicinal plants and isolation of medicinal secondary products. When compared to traditional agricultural growth, plant tissue culture production of medicinal plants offers a number of unique advantages, including the possibility of year-round, continuous production of plant medicinal compounds under highly controlled conditions. As the *in-vivo* production of secondary metabolites by plants can be highly influenced by plant growth environment factors such as climatic and soil conditions, pathogen attack and herbivory [1, 2], *in-vitro* tissue culture growth of medicinal plants can provide a route for consistent medicinal chemical isolation from plant materials [3]. Indeed, the lack of consistency in the levels of active chemicals in herbal medicines has been a continual issue [4] and variation in secondary metabolite production in agriculturally grown plant material can certainly contribute to this problem. Plant tissue culture growth of medicinal plants can also be scaled up using continuous-culture systems such as “bioreactors”, and this could allow for automated, high-level isolation of medicinal secondary products [5, 6]. This would be particularly advantageous for secondary metabolite production from medicinal plants that are slow-growing *in vivo*, and could eliminate concerns regarding over-harvesting of medicinal plants which are either rare or endangered [3, 5, 6].

In order to be a viable approach for the commercial production of herbal medicines or pharmaceutical chemical precursors, plant tissue culture growth must result in a high-yield recovery of secondary metabolites. Enhanced production of medicinal plant secondary metabolites in cell culture has been achieved in some cases via the optimization of culture conditions, immobilization and physical shock, and the use of host-pathogen “elicitor” compounds [7, 8]. The ability to transform *in-vitro* plant cell cultures with *Agrobacterium rhizogenes* to produce “hairy root cultures” has had a major impact on this field as this approach leads to fast-growing tissue cultures that are easy to maintain and which produce elevated levels of sec-

ondary metabolites [9, 10]. In addition, recent advances in molecular methods have allowed the modification (“bioengineering”) of metabolic pathways in cell cultures, which as resulted in either enhanced secondary metabolite production or the generation of unique metabolites not produced in the original plant material [11, 12].

This chapter will focus on methods utilized in plant tissue culture growth for the recovery of phytomedicinal chemicals. A major emphasis will be placed on describing approaches for the enhancement of secondary metabolite production in cell cultures and the development of systems for the large-scale recovery of phytomedicinal plant secondary products.

## 9.2

### Medicinal Plant Tissue Cultures and the In-Vitro Production of Phytomedicinal Secondary Metabolites

A number of medicinal plants have been successfully introduced into tissue culture (see Table 9.1). Typically, these tissue cultures involve either callus cells growing on a semi-solid media, or liquid suspension cultures. Both systems, involving the unorganized growth of plant cells, have the advantage of allowing straightforward, continual propagation of cultures and in the case of liquid suspension cells, cell production can be scaled up to high levels using bioreactors [7, 8]. In this respect, suspension cell cultures have the advantage of higher growth rates than callus cultures [7]. Moreover, secondary metabolites can be more easily extracted from liquid suspension culture than organized growth systems. Hence, if adequate levels of secondary metabolites can be produced by such a system, this would be ad-

**Table 9.1** Examples of medicinal plant growth and production of secondary metabolites in cell cultures.

<i>Plant</i>	<i>Culture type</i>	<i>Phytomedicinal compound(s)</i>	<i>Function</i>	<i>Reference</i>
<i>Catharanthus roseus</i>	Suspension culture	Vinblastine/vincristine	Antitumor	13
<i>Capsicum frutescens</i>	Suspension culture	Capsaicin	Diaphoretic	14
<i>Cinchona</i> sp.	Suspension culture	Alkaloids	Antimalarial	15
<i>Coptis japonica</i>	Suspension culture	Berberine	Antimicrobial	16
<i>Digitalis purpurea</i>	Suspension culture	Cardiac glycosides	Cardiac function	17
<i>Ginkgo biloba</i>	Suspension culture	Ginkgolide A	Antioxidant	18
<i>Glycyrrhiza glabra</i>	Callus culture	Triterpenes	Anti-inflammatory	19
<i>Hypericum perforatum</i>	Suspension culture	Hypericins	Antidepressant	20
<i>Panax ginseng</i>	Callus culture	Ginsenosides	Tonic	21
<i>Panax notoginseng</i>	Suspension culture	Ginsenosides	Tonic	22
<i>Papaver somniferum</i>	Suspension culture	Opiates	Anesthetic	23
<i>Piper methysticum</i>	Callus culture	Kavapyrones	Sedative	24
<i>Podophyllum hexandrum</i>	Suspension culture	Podophyllotoxin	Antitumor	25
<i>Rauwolfia serpentina</i>	Suspension culture	Reserpine	Antihypertensive	26
<i>Taxus</i> sp.	Suspension culture	Taxol	Antitumor	27

vantageous for the commercial production of these compounds. An recent extensive survey by Vanisree et al. [8] included over 90 reports of successful culture of medicinal plants, and in most cases the work involved production of either callus or liquid suspension cultures. These authors also provide details regarding the culture media required for the successful culture of each medicinal plant species.

As noted in Table 9.1, analysis of the cell cultures revealed the production of medicinal secondary products as found for the *in-vivo* plant. One major problem, however, is that often the level of secondary metabolite production in such unorganized plant cell systems may be low, and below levels that would make industrial production feasible [3, 7]. As pointed out by Walton et al. [7], unorganized cell systems, such as callus and suspension cells, may lack the biochemical control mechanisms that specify secondary metabolite production, and secondary metabolite production may be restored or elevated with the induction of organized cell growth in organ cultures. Moreover, herbal medicines often represent a complex mixture of secondary metabolites, and cell cultures may not produce the appropriate spectrum and relative levels of secondary metabolites necessary for an effective phyto-medicinal preparation [7]. Indeed, studies conducted with Kava callus cultures by our laboratory group demonstrated levels of kavapyrones quite different from those isolated from the intact roots typically utilized in production of the sedative herbal medicine [24]. Nevertheless, it has been possible to increase secondary metabolite production in some medicinal plant callus or suspension cultures, and this was the case for some of the examples included in Table 9.1. The achievement of elevated levels of secondary metabolite production in cell culture can require modification of the growth media components, including levels of plant hormones, the addition of fungal elicitors, or the addition of metabolic precursors for the secondary metabolite [7, 8]. A more detailed discussion of the strategies and factors utilized to enhance secondary metabolite production in callus or liquid suspension cultures is presented in the next section.

### 9.3

#### Factors Leading to Elevated Production of Secondary Metabolites in Medicinal Plant Cell Cultures

Invariably, the approach to improve secondary metabolite production in medicinal plant cell cultures is empirical. Details of some factors that have led to increases in secondary metabolite production are discussed in the following sections.

##### 9.3.1

#### Cell Culture Media Components

Several research groups have found that modification of the basic components of the nutrient medium can elevate secondary metabolite production. With respect to mineral nutrients, this can involve elevation of specific nutrients or subjecting the cultures to low nutrient stress. For example, in Ginseng (*Panax ginseng*), the pro-



duction of ginsenosides – the active medicinal compounds – can be increased by optimization of levels of media nitrogen, potassium, and phosphate [30–32]. Production of the antimicrobial compound berberine in *Coptis japonica* cell cultures [16, 33] and the antitumor agent paclitaxel in *Taxus cuspidata* cell cultures [34] was also achieved by empirical optimization of mineral nutrients present in the growth medium. In contrast, the production of capsaicin – the alkaloid compound responsible for the pungent effects in pepper – was elevated by subjecting *Capsicum annum* cells to low nutrient stress [14]. It should be noted that low nutrient stress is also an environmental factor which can lead to elevated secondary product biosynthesis in intact plants [35].

The level and form of the carbon supply in the culture medium can have a strong effect upon secondary metabolite production in cell cultures. In several different studies, elevation of sucrose was found to promote paclitaxel biosynthesis in *Taxus* sp. grown in culture [36, 37]. Paclitaxel biosynthesis by cell cultures was also further enhanced by the inclusion of fructose [36]. Likewise, elevated sucrose in the growth media has been shown to increase alkaloid biosynthesis in *Catharanthus roseus* cultures [38], anthocyanin biosynthesis in *Perilla frutescens* cell suspensions [22], and steroidal alkaloid production in *Solanum aviculare* cultures [39]. For cell cultures of ginseng, the initial presence of glucose and sucrose followed by sucrose alone during the later phase of culture growth promoted the production of ginsenosides [40]. This effect of sugar supply on secondary product biosynthesis could result directly from these sugars as a specific carbon input, or it could reflect a shift in metabolism due to changes in general carbon/nitrogen balance. Indeed, carbon/nitrogen balance can have a strong effect on the levels of secondary product biosynthesis in intact plants [35]. This influence of carbon/nitrogen balance was also observed to be critical for promoting secondary metabolite biosynthesis in a large-scale culture system for *Catharanthus roseus* [41]. Here, secondary metabolism was elevated during the later phase of culture growth and correlated with a depletion of nitrate in the growth medium. Tal et al. [42] also demonstrated an influence of carbon versus nitrogen levels in determining diosgenin biosynthesis in cultures of *Dioscorea deltoidea*.

In addition to levels of mineral nutrients and carbon source/supply levels, the forms of plant hormones, as well as media components such as amino acids, can further affect secondary metabolite production in cell cultures. Levels of plant hormones present in the growth medium were shown to influence ginsenoside production in ginseng cell cultures [40], and hormone removal in a large-scale culture system of *Papaver somniferum* resulted in about a threefold elevation in production of the medicinal alkaloids, codeine and morphine [23]. The effect of amino acids on paclitaxel production in *Taxus cuspidata* cell cultures was examined by Fett-Neto et al. [34], and the presence of phenylalanine in the growth medium was found to promote maximum levels of paclitaxel biosynthesis.



## 9.3.2

**Elicitors and Jasmonates**

As many secondary metabolites have a key role in plant defense responses against pathogens, it is not surprising that the addition of molecules involved in the signaling of pathogen attack would increase secondary metabolite production. In this respect, there are a number of reports where the addition of an elicitor to the growth medium increases secondary product biosynthesis [43]. It should be noted that in this discussion the term “elicitor” refers to carbohydrate oligomers either of plant or fungal origin (excluding chitosan) involved in early pathogen recognition events leading to a plant defense response [44]. Once an elicitor is recognized by an appropriate plant receptor, the activation of signal transduction pathways results in a response which can involve an array of components including protein kinases, jasmonate, salicylic acid, and reactive oxygen species [43]. However, in the plant tissue culture literature, the term “elicitor” has been used in a broader context and can refer to any chemical substance (biological or inorganic) or treatment resulting in increased secondary product metabolism [8].

This relationship between the role of an elicitor in a pathogen defense response and the potential for induction of secondary product metabolism was clearly shown in early studies by Funk et al. [45]. Here, a fungal elicitor fraction which induced glyceollin biosynthesis in soybean (*Glycine max*) could also increase berberine biosynthesis fourfold in cell suspension cultures of *Thalictrum regosum*. Production of the phytoalexin, glyceollin, is a well-characterized early defense response in soybean to fungal pathogen attack which is initiated by elicitor recognition [44].

Several studies have demonstrated the value of fungal elicitors in promoting biosynthesis of the antitumor agent, paclitaxel, by *Taxus* sp. cell cultures, and these elicitors have been derived from a variety of microbial sources. For example, Ciddi et al. [46] utilized elicitor fractions from extracts of *Penicillium minioluteum*, *Botrytis cinerea*, *Verticillium dahliae* and *Gliocladium deliquescens*, and found that all elicitor fractions increased the biosynthesis of paclitaxel in cell cultures. Paclitaxel biosynthesis in *Taxus chinensis* cell cultures was also increased by the addition of an elicitor fraction generated from *Aspergillus niger*, an endophytic fungus which infects the inner bark of this plant *in vivo* [47].

Fungal elicitors have also been used to elevate ginsenoside production in cell suspension cultures of ginseng. In studies conducted by Lu et al. [48], a yeast extract was found to serve as an elicitor, resulting in an over 20-fold stimulation of ginsenoside production. Likewise, Archambault et al. [49] were able to obtain a twofold stimulation in the production of the antimicrobial compound, sanguinarine, through the use of a chitosan elicitor in *Papaver somniferum* cell cultures.

Jasmonic acid and its derivative forms such as methyl jasmonate (collectively referred to as “jasmonates”) represent important plant signal transduction molecules involved in the response to pathogen attack [50]. Not surprisingly, these molecules have been shown to induce secondary product metabolism in cell cultures. Indeed, Gundlach et al. [51] showed that jasmonates are involved in the elicitor-based elevation in secondary metabolite production for a wide range of cell cul-

tures. This general role of jasmonate in linking elicitor-recognition to secondary product biosynthesis was also demonstrated in studies measuring phytoalexin biosynthesis in cell cultures of rice [52]. Here, jasmonate levels were shown to correlate with phytoalexin biosynthesis, while the inhibition of jasmonate production using ibuprofen reduced both jasmonate and phytoalexin levels. Moreover, this inhibition of phytoalexin biosynthesis could be reversed by the addition of exogenous jasmonate. As such, the effects of jasmonic acid and its methyl ester (methyl jasmonate) have been extensively tested for their effects in stimulating secondary metabolite biosynthesis in a variety of medicinal plant cell cultures.

As with the effects of fungal elicitors, several studies have shown jasmonate to be effective for stimulating paclitaxel biosynthesis in cell cultures of *Taxus* sp. [8]. Yuki-mune et al. [53] showed that the addition of methyl jasmonate to cell cultures of *Taxus media* resulted in a substantial increase in production, with a preferential elevation in paclitaxel relative to other taxoids. A similar result was observed by Ketchum et al. [54] for cultures of *Taxus canadensis* and *Taxus cuspidata*, although taxoids in addition to paclitaxel were increased by this treatment. Quite interestingly, Mirjalili and Linden [55] found that combining a methyl jasmonate treatment with ethylene exposure led to an even further increase in paclitaxel biosynthesis by up to 19-fold. In contrast, these authors found that the addition of methyl jasmonate alone resulted in only about a threefold elevation in paclitaxel biosynthesis with this system. This apparent synergistic response may reflect an interaction among multiple signal transduction pathways involved in this pathogen response [43].

Jasmonates have also been effective for increasing the production of ginsenosides by cell cultures of ginseng. Treatment of *Panax ginseng* cell cultures with methyl jasmonate has been shown to elevate ginsenoside production substantially, without much effect on cell proliferation [48]. These authors also found an antagonistic interaction between methyl jasmonate and 2, 4-dichlorophenoxyacetic acid (2, 4-D), so that optimal effects were obtained when this growth regulator was removed from the medium. With *Panax notoginseng*, methyl jasmonate was found not only to increase the level of ginsenoside production (over ninefold) but also (apparently) to alter the relative levels of different ginsenoside forms in the extract [56]. This could prove to be a problem for the use of such a system in the generation of a phytomedicinal, as its effectiveness may depend upon a specific relative amounts of each ginsenoside component that is present.

Jasmonic acid has been shown to increase the production of hypericins and to promote cell proliferation in cell cultures of St. John's wort (*Hypericum perforatum*) [57]. The hypericins are naphthodianthrones which contribute to the antidepressant activity of St. John's wort extracts [58]. Quite interestingly, fungal elicitor fractions did not stimulate hypericin production in this system.

### 9.3.3

#### Exogenous Substances

A variety of inorganic substances have been shown to increase secondary metabolite biosynthesis, and could prove useful for stimulating phytomedicinal com-

pound production by cell cultures. For example, the addition of forms of vanadate to cell cultures have been shown to increase secondary product biosynthesis. The addition of sodium orthovanadate to cultures of *Eschscholtzia californica* elevated production of benzophenanthride alkaloids to levels observed with fungal elicitors [59]. Likewise, the addition of vanadyl sulfate to cultures of *Catharanthus roseus* cell cultures elevated production of the antitumor agent, vinblastine [13]. Vanadate is an inhibitor of the plasma membrane proton pump and other phosphohydrolases [60], and these elevations in secondary metabolites might represent a cell stress response.

Other substances utilized in this way have included silver ions ( $\text{Ag}^+$ ) and lanthanum ( $\text{La}^{3+}$ ). For example, the addition of silver ions was shown to increase biosynthesis of the diterpenoid tanshinones in *Salvia miltiorrhiza* cultures, and this process demonstrated many similarities to elicitor-based stimulation of secondary product biosynthesis [61]. Likewise, the biosynthesis of paclitaxel in suspension cell cultures of *Taxus yunnanensis* was elevated by treatment with lanthanum, and this also appeared similar to elicitor-based effects [62]

#### 9.3.4

##### **Immobilization**

The immobilization of cultured cells to form aggregates has been observed to enhance secondary metabolite production [63]. Typically, culture cell immobilization has been achieved through the use of alginate, polyurethane foam cubes and growing cells as aggregates [64–66]. As noted by Verpoorte et al. [67], the basis for this effect may be cell-to-cell contact and some degree of cell differentiation. As an approach to achieve large-scale production of secondary metabolites, immobilization may be problematic since such systems are difficult to maintain on a large-scale basis, and secondary metabolites may not be extensively released to the growth media [67, 68].

#### 9.3.5

##### **Physical Stress**

The exposure of plant cell cultures to physical stresses that affect membrane permeability has been shown to enhance secondary metabolite production. Moreover, any increases in membrane permeability can also lead to a greater release of the secondary metabolite to the growth medium for recovery. In suspension cultures of *Lithospermum erythrorhizon*, Lin and Wu [69] found that exposure to low-energy ultrasound resulted in about a 60–70% increase in shikonin production, and an additional increase in the recovery of this metabolite due to enhanced membrane permeability. The combined effect resulted in about a threefold increase in recovery of the metabolite. An enhancement of taxuyannanin C biosynthesis in *Taxus chinensis* was similarly achieved by exposure of suspension cultures to a pulsed electrical field [70]. The proposal was that such exposure induced a defense-type response that resulted in enhanced secondary product biosynthesis.

## 9.4

**Enhancement of Secondary Metabolite Production through *Agrobacterium rhizogenes* Transformation**

An alternative biotechnological approach for obtaining improved secondary metabolite biosynthesis in medicinal plant tissue cultures can involve the transformation of plant cells with the soil bacterium, *Agrobacterium rhizogenes*. This results in the development of a fast-growing root culture which can, for many plants, also involve elevated secondary metabolite production [9, 10]. These root cultures are called “hairy roots” due to the large number of root hairs typically associated with the highly branched root structures [7].

Hairy root cultures are usually generated by *Agrobacterium rhizogenes* infection of sterile plant explants such as leaf and leaf petioles [7, 9]. Transformation involves bacterial plasmid transfer and the incorporation of key sections of the plasmid DNA into the host plant genome. In particular, the *Agrobacterium rhizogenes* plasmid TL section with its three genes, *Rol A*, *B*, and *C*, is important for root induction and growth [71]. Once the roots have grown for a sufficient period of time, they can be excised from the explant tissue and then cultured in a growth medium containing an antibiotic, ultimately to free the cultures of residual *Agrobacterium*. These root cultures grow very quickly and generate a highly branched network structure with rapid rates of linear extension [7]. Overall, the resulting hairy root cultures are fast-growing and can be maintained on a very simple culture medium, without plant hormones [9, 10].

With respect to secondary product metabolism, one particular advantage of hairy root cultures is that they exhibit biosynthetic levels equal to or even greater than those observed for the same plant grown *in vivo* [72–74]. Examples of medicinal plants which have been introduced into hairy root culture are listed in Table 9.2. The data in the table also indicate the relevant phytomedicinal chemicals produced by the cultures and their medicinal functions.

**Table 9.2** Examples of medicinal plants and phytomedicinal compounds generated with growth in hairy root culture.

<i>Plant species</i>	<i>Phytomedicinal compound</i>	<i>Function</i>	<i>Reference</i>
<i>Artemisia annua</i>	Artemisinin	Antimalarial	75
<i>Catharanthus roseus</i>	Indole alkaloids	Antihypertensive	76
<i>Coleus forskohlii</i>	Forskolin	Antihypertensive	77
<i>Datura candida</i> × <i>D. aureas</i>	Tropane alkaloids	Anticholinergic	78
<i>Glycyrrhiza glabra</i>	Isoprenylated flavonoids	Antimicrobial	88
<i>Paulownia tomentosa</i>	Verbascoside	Antibacterial, antiviral	79
<i>Scutellaria baicalensis</i>	Flavonoid glycosides	Antibacterial, antioxidant	80
<i>Solanum aviculare</i>	Solasodine	Steroid drug precursor	81
<i>Valeriana wallichii</i>	Valepotriates	Sedative	82

The pattern of secondary metabolite production by hairy root cultures may be similar to that which is observed for roots of the intact plant, or there may be an accumulation of secondary metabolites in the root cultures that would normally be present in other plant regions [7, 9, 10]. For example, hairy root cultures of ginseng accumulate high levels of ginsenosides which are normally produced in the roots [56]. On the other hand, hairy root cultures of *Artemisia annua* accumulate the sesquiterpenoid artemisinin [83–85]. This compound is normally accumulated in the aerial (oil-containing) parts of the *in-vivo* plant [86]. To some extent this may be due to the fact that, in the root cultures, long-distance transport processes are not present and the metabolites would remain and hence, accumulate in the roots [7, 10].

There have been some instances where hairy root cultures produced novel secondary metabolites not associated with the native plant species. For example, hairy root cultures of *Panax ginseng* were found to produce four novel polyacetetylene compounds not observed for the native plant [87]. Likewise, two novel isoprenylated flavonoids with antimicrobial activity were produced by hairy root cultures of *Glycyrrhiza glabra* [88].

Walton et al. [7] point out that an important aspect of the capacity of hairy root cultures to generate elevated levels of secondary metabolites relates to their root morphology. These authors cite the example of *Nicotiana rustica* roots, where mechanical damage to the root morphology in culture led to a decrease in the capacity for nicotine production.

## 9.5 Metabolite Engineering of Medicinal Plants in Culture

In contrast to “inducing” native enzyme pathways in plant cell cultures for increased secondary metabolite production, metabolic engineering can serve to directly modify pathways, the result being an increased production of secondary metabolites or the production of metabolites not normally produced by a given plant species. While a major limitation to this approach is the requirement for a thorough knowledge of the pathway steps involved, the application of bioinformatic approaches coupled with biochemical studies promises to provide the necessary information to make metabolic engineering a reality. With respect to strategies to enhance secondary metabolite production, useful approaches can involve the overexpression of an enzyme (or enzymes) at a key limiting step(s) in a pathway, decreasing the expression of enzymes in competitive pathway branches, increasing an entire pathway through expression of regulatory factors (excluding transcription factors), and the introduction of novel enzymes utilizing a pathway intermediate for the generation of a different secondary metabolite [11, 12, 68]. At present, a limited number of examples are available where these approaches have been utilized in cell cultures resulting in the enhanced production of secondary products. However, these studies demonstrate the potential for application for production of phytomedicinal compounds from medicinal plant cells in culture.

In cell cultures of *Coptis japonica*, isoquinoline alkaloid metabolism leads to the production of berberine, as well as to other alkaloid components [89]. By overexpressing an enzyme located at a key branch point in this pathway (scoulerine 9-O-methyltransferase), Sato et al. [90] enhanced berberine (and columbamine) production over that of an alternative metabolite, coptisine. Overexpression of this enzyme resulted in a ca. 20% increase in enzyme activity and an elevation of the amount of berberine and columbamine levels ranging from 79% to 91% of the total alkaloid level. Likewise, in hairy root cultures of *Hyoscyamus muticans*, overexpression of the enzyme hyoscyamine 6 $\beta$ -hydroxylase was utilized to shift the relative production of the tropane alkaloids, hyoscyamine and scopolamine, towards increased scopolamine biosynthesis [91]. This compound has a number of important pharmaceutical uses, including the reduction of motion sickness [2]. While hairy root cultures produced hyoscyamine as the major tropane alkaloid, scopolamine production was increased 100-fold following overexpression of this enzyme. This elevation in scopolamine production was achieved without a concomitant reduction in the level of hyoscyamine production.

In *Catharanthus roseus*, one portion of the metabolic pathway for terpenoid indole alkaloid biosynthesis is under the control of ORCA3, a transcription factor which is involved in the jasmonate-dependent induction of this pathway [11]. When this transcription factor was overexpressed in *C. roseus* culture cells, enhanced expression of several genes in the biosynthetic pathway was observed [92]. However, in order to obtain enhanced alkaloid production in the cells it was necessary to include the compound loganin, which is an early metabolic intermediate. Since it was found that ORCA3 did not control expression of a cytochrome P450 involved in an early step in the pathway, this addition was necessary to bypass this region of the pathway [12, 92]. With the inclusion of loganin, alkaloid biosynthesis was increased threefold in the *C. roseus* culture cells [92]. In maize kernels, two transcription factors, R and C1, appear to control anthocyanin biosynthesis [12], and overexpression of these transcription factors in maize cell cultures resulted in induction of the entire flavonoid pathway [93].

The introduction of genes into plant cells in culture conferring heterologous expression of novel enzymes for that species could allow for the generation of new secondary metabolites. For example, Fecker et al. [94] transformed *Nicotiana* hairy root cultures with a bacterial lysine decarboxylase gene, thereby allowing the generation of the piperidine alkaloid anabasine. Similarly, Lodhi et al. [95] introduced a bacterial gene encoding isochorismate synthase into *Rubia peregrina* hairy root cultures, which resulted in an increase in the production of anthraquinones.

While the metabolic engineering of pathways will have tremendous potential for use in *in-vitro* phytomedicinal production, there are some limitations to this approach. Although the overexpression of individual enzymes in a pathway has shown some success in increasing or modifying secondary metabolite biosynthesis, it should be recognized that, according to *metabolic control theory*, overall pathway flux is limited by the net effect of all enzymes present in the pathway [96]. As such, overexpression of a single enzyme might have little effect, as the limitation (“control”) exerted by other enzymes in the pathway may overshadow any enhanced activity

from a single enzyme. Recent studies have also supported the role of “metabolons” in many pathways, where an entire pathway or portion of a pathway is mediated by a multienzyme complex [96, 97]. In this case, the enzymes in a metabolon may be coordinately expressed, and intermediary metabolites are passed directly from one enzyme to the next via metabolite channeling, and without free metabolite pools. As such, the effect of overexpression of a single enzyme would be limited by the levels of the other enzymes present in the metabolon for assembly, and the lack of metabolic pools due to metabolite channeling could limit the effectiveness of novel enzyme introduction to generate new metabolites. Finally, as pointed out by Oksman-Caldentey and Inze [11], the autotoxicity of secondary metabolites could pose a problem when their levels of synthesis are elevated by metabolic engineering. With *in-vivo* plants, many toxic secondary metabolites are accumulated in the vacuole, and transport processes could prove to be a limiting factor [11]. Alternatively, secondary metabolites might be glycosylated as a means of preventing toxicity. This latter possibility was observed when a phenolic metabolism was modified by the introduction of a bacterial gene for chorismate-pyruvate lyase into *Nicotiana* cell cultures [98, 99]. While this enzyme would lead to the production of 4-hydroxybenzoate, the glycosylated forms of this compound were found.

## 9.6

### Large-Scale Production of Medicinal Secondary Metabolites in Bioreactor Systems

The scaling-up of plant culture systems to allow the industrial production of secondary metabolites has been achieved for a limited number of medicinal plant species. These production systems, or “bioreactors”, can allow for continuous culture growth and possibly, continuous recovery of secondary metabolites. A number of different types of bioreactor have been developed for plant culture systems which differ in terms of how the cultures are mixed, how the medium is supplied to the culture, and how gas exchange is controlled [63, 100, 101]. Some examples of medicinal plant species, together with the active secondary metabolites produced in bioreactors, are listed in Table 9.3. These data indicate that bioreactors have been

**Table 9.3** Some examples of medicinal plants grown and phytomedicinal compounds recovered in bioreactor systems.

<i>Plant species</i>	<i>Culture type</i>	<i>Phytomedicinal compound</i>	<i>Function</i>	<i>Reference</i>
<i>Artemisia annua</i>	Hairy roots	Artemisinin	Antimalarial	101
<i>Atropa belladonna</i>	Hairy roots	Atropine	Anticholinergic	102
<i>Coleus blumei</i>	Suspension	Rosmarinic acid	Antioxidant	103
<i>Coptis japonica</i>	Suspension	Berberine	Antimicrobial	104
<i>Datura stramonium</i>	Hairy roots	Hyoscyamine	Anticholinergic	105
<i>Papaver somniferum</i>	Suspension	Sanguinarine	Antimicrobial	106
<i>Taxus baccata</i>	Suspension	Taxol	Antitumor	107

used with both suspension cultures and hairy root cultures. The scaling-up of a plant culture with a bioreactor requires careful consideration of several growth parameters, including oxygen supply, nutrient medium composition, light supply, and factors required to induce secondary product synthesis [63, 100]. With such an approach, only the ginsenosides from ginseng and the antimicrobial compound berberine have been produced commercially, on a large-scale basis [104, 108]. The production of taxol in bioreactors has provided very favorable results, and a clear potential for commercial use [11]. For other compounds to be produced at commercial levels, the bioreactor design may need further optimization, and the methods used to recover the secondary metabolites may need to be improved.

## 9.7

### Summary and Perspective

While plant cell culture systems can, potentially, have a number of advantages in the production of phytomedicinal compounds, there are a number of technical challenges that would need to be resolved. Whilst it is generally possible to introduce most plants into tissue culture, the production of adequate levels of particular secondary metabolites may be problematic. Identifying growth conditions to induce secondary product production, either through growth medium optimization or by the addition of elicitors or jasmonates, can lead to increased production of secondary metabolites. However, this process is both empirical and time-consuming. On the other hand, the transformation of medicinal plants using *Agrobacterium rhizogenes* to form hairy root cultures has the potential benefits of fast growth and rates of secondary metabolite production equal to or greater than that found for the intact plant. Moreover, hairy root cultures can be scaled-up for bioreactor production to allow for the large-scale recovery of medicinal products. Finally, advances in molecular methods and in knowledge relating to secondary metabolite pathways can lead to the use of metabolic engineering as a means of directly modifying pathways for increased phytomedicinal product biosynthesis.



## References

- 1 Sudha, G., Ravishankar, G.A. *Plant Cell Tissue Organ Culture* **2002**, *71*, 181–212.
- 2 Wink, M., Schimmer, O. In: Wink, M. (Ed.), *Functions of Plant Secondary Metabolites and Their Exploitation in Biotechnology*. CRC Press, USA, **1999**, pp. 17–133.
- 3 Wawrosch, C. In: *Handbook of Medicinal Plants*. CRC Press, USA, **2005**, pp. 261–278.
- 4 Wills, R.B.H., Bone, K., Morgan, M. *Nutrit. Res. Rev.* **2000**, *13*, 47–77.
- 5 Kim, Y., Wyslouzil, B.E., Weathers, P.J. *In Vitro Cell. Dev. Biol.* **2002**, *38*, 1–10.
- 6 Gupta, R.. In: Wijesekera, R.O.B. (Ed.), *The Medicinal Plant Industry*. CRC Press, **1991**, pp. 43–57.
- 7 Walton, N.J., Alfermann, A.W., Rhodes, M.J.C. In: Wink, M. (Ed.), *Functions of Plant Secondary Metabolites and Their Exploitation in Biotechnology*. CRC Press, USA, **1999**, pp. 311–345.
- 8 Vanisree, M., Lee, C.-Y., Lo, S.-F., Nalawade, M.S, Lin, C.Y., Tsay, T.-S. *Bot. Bull. Acad. Sing.* **2004**, *45*, 1–22.
- 9 Shanks, J.V., Morgan, J. *Curr. Opin. Biotechnol.* **1999**, *10*, 151–155.
- 10 Giru, A., Narasu, M.L. *Biotechnol. Adv.* **2000**, *18*, 1–22.
- 11 Oksman-Caldentey, K.-M., Inze, D. *Trends Plant Sci.* **2004**, *9*, 433–440.
- 12 Verpoorte, R., Memelink, J. *Curr. Opin. Biotechnol.* **2002**, *13*, 181–187.
- 13 Smith, J.I., Smart, N.J., Misawa, W.G.W., Kurtz, S.G. *Plant Cell Rep.* **1987**, *58*, 142–145.
- 14 Lindsey, K., Yeoman, M.M. *Annuum. Planta* **1984**, *162*, 495–501.
- 15 Koblitz, H., Koblitz, D., Schmauder, H.P., Groger, D. *Plant Cell Rep.* **1983**, *2*, 122–125.
- 16 Sato, F., Yamada, Y. *Phytochemistry* **1984**, *23*, 281–285.
- 17 Hagimori, M., Matsumoto, T., Obi, Y. *Plant Cell Physiol.* **1983**, *23*, 1205–1211.
- 18 Carrier, D., Chauret, N., Mancini, M., Coulombe, P., Neufeld, R., Weber, M., Archambault, J. *Plant Cell Rep.* **1991**, *10*, 256–259.
- 19 Ayabe, S., Takano, H., Fujita, T., Hirota, H., Takahashi, T. *Plant Cell Rep.* **1990**, *9*, 181–184.
- 20 Bais, H.P., Walker, T.S., McGrew, J.J., Vivanco, J.M. *In Vitro Cell. Dev. Biol.* **2002**, *38*, 58–65.
- 21 Furuya, T., Kojima, H., Syono, K., Ishi, T., Uotani, K., Nishio, M. *Chem. Pharm. Bull.* **1973**, *21*, 98–101.
- 22 Zhong, J.J., Zhu, Q.X. *Appl. Biochem. Biotechnol.* **1995**, *55*, 241–246.
- 23 Siah, C.L., Doran, P.M. *Plant Cell Rep.* **1991**, *10*, 349–353.
- 24 Briskin, D.P., Kobayashi, H., Lila, M.A., Gawienowski, M. In: Dyer, L.A., Palmer, A.D.N. (Eds.), *Piper. A model genus for studies of phytochemistry, ecology and evolution*. Kluwer Academic Press, New York, USA, **2004**, pp. 140–155.
- 25 Uden, W., Pras, N., Vossebeld, E.M., Mol, J.N.M., Malingre, T.M. *Plant Cell Tiss. Cult.* **1990**, *20*, 81–87.
- 26 Yamamoto, O., Yamada, Y. *Plant Cell Rep.* **1986**, *5*, 50–53.
- 27 Wu, J., Wang, C., Mei, X. *J. Biotechnol.* **2001**, *85*, 67–73.
- 28 Bourgaud, F., Gravot, A., Milesi, S., Gontier, E. *Plant Sci.* **2001**, *161*, 839–851.
- 29 Ravishankar, G.A., Sharma, K.S., Venkataraman, L.V., Kadyan, A.K. *Curr. Sci.* **1988**, *57*, 381–383.
- 30 Franklin, C.I., Dixon, R.A. In: Dixon, R.A., Gonzales, R.A. (Eds.), *Plant Cell Culture – A Practical Approach*. 2nd edn. IRL Press, UK, **1994**, pp. 1–25.
- 31 Zhang, Y.H., Zhong, J.J. *Enzyme Microb. Technol.* **1997**, *21*, 59–63.
- 32 Liu, S., Zhong, J.J. *J. Biotechnol.* **1996**, *52*, 121–126.
- 33 Morimoto, T., Hara, Y., Kato, Y., Hiratsuka, J., Yoshioka, T., Fujita, Y., Yamada, Y. *Agric. Biol. Chem.* **1988**, *52*, 1835–1836.
- 34 Fett-Neto, A.G., Stewart, J.M., Nicholson, S.A., Pennington, J.J., DiCosmo, F. *Biotechnol. Bioeng.* **1994**, *44*, 967–971.
- 35 Wink, M.. In: Wink, M. (Ed.), *Biochemistry of Plant Secondary Product Metabolism*. CRC Press, USA, **1999**, pp. 1–16.
- 36 Hirasuna, T.J., Pestchanker, L.J., Srinivasan, V., Shuler, M.L. *Plant Cell Tissue Org. Cult.* **1996**, *44*, 95–102.
- 37 Ellis, D.D., Zeldin, E.L., Brodhagen, M., Russin, W.A., McCowan, B.H. *J. Nat. Prod.* **1996**, *59*, 246–250.

- 38 Vazquez-Flota, F., Moreno-Valenzuela, O., Miranda-Hamm, M.L., Coello-Coello, J., Loyola-Vargas, V.M. *Plant Cell Org. Cult.* **1994**, *38*, 273–279.
- 39 Yu, S., Kwok, K.H., Doran, P.M. *Enzyme Microb. Technol.* **1996**, *18*, 238–243.
- 40 Furuya, T., Yoshikawa, T., Orihara, Y., Oda, H. *J. Nat. Prod.* **1984**, *47*, 70–75.
- 41 Schlattmann, J.E., Moreno, P.R.H., Selles, M., Vinke, J.L., Ten Hoopen, H.U.G., Verpoorte, R., Heijnen, J.J. *Biotechnol. Bioeng.* **1995**, *47*, 53–59.
- 42 Tal, B., Rokem, J.S., Goldberg, I. *Plant Cell Rep.* **1983**, *2*, 219–222.
- 43 Zhao, J., Davis, L.C., Verpoorte, R. *Biotech. Adv.* **2005**, *23*, 283–333.
- 44 Benhamou, N. *Trends Plant Sci.* **1996**, *1*, 233–240.
- 45 Funk, C., Gügler, K., Brodelius, P. *Phytochemistry* **1987**, *26*, 401–405.
- 46 Ciddi, V., Srinivasan, V., Shuler, M.L. *Biotechnol. Lett.* **1995**, *17*, 1343–1346.
- 47 Wang, C.G., Wu, J.Y., Mei, X.G. *Appl. Microbiol. Biotech.* **2001**, *55*, 404–410.
- 48 Lu, M.B., Wong, H.L., Teng, W.L. *Plant Cell Rep.* **2001**, *20*, 674–677.
- 49 Archambault, J., Williams, R.D., Bedard, C., Chavarie, C. *J. Biotech.* **1996**, *46*, 95–106.
- 50 Pozo, M.J., Van Loon, L.C. *J. Plant Growth Reg.* **2004**, *23*, 211–222.
- 51 Gundlach, H., Muller, M.J., Kuchan, T.M., Jenk, M.H. *Proc. Natl. Acad. Sci. USA* **1992**, *89*, 2389–2393.
- 52 Nojiri, H., Sugimori, M., Yamanhe, H., Nishimura, Y., Yamada, A. *Plant Physiol.* **1996**, *110*, 387–392.
- 53 Yukimune, Y., Tabata, H., Higashi, Y., Hara, Y. *Nature Biotech.* **1996**, *14*, 1129–1132.
- 54 Ketchum, R.E.B., Gibson, D.M., Croteau, R.B., Shuler, M.L. *Biotechnol. Bioeng.* **1999**, *62*, 97–105.
- 55 Mirjalili, N., Linden, J.C. *Biotech. Prog.* **1996**, *12*, 110–118.
- 56 Wang, W., Zhong, J.J. *J. Biosci. Bioeng.* **2002**, *93*, 48–53.
- 57 Walker, T.S., Bais, H.P., Vivanco, J.M. *Phytochemistry* **2002**, *60*, 289–293.
- 58 Briskin, D.P. *Plant Physiol.* **2000**, *124*, 507–514.
- 59 Villegas, M., Sommarin, M., Brodelius, P.E. *Plant Physiol. Biochem.* **2000**, *38*, 233–241.
- 60 Briskin, D.P., Hanson, J.B. *J. Exp. Bot.* **1992**, *43*, 269–289.
- 61 Zhang, C.H., Yan, Q., Cheukl, W.K., Wu, J.Y. *Planta Med.* **2004**, *70*, 147–151.
- 62 Wu, J.Y., Wang, C.G., Mei, X.G. *J. Biotech.* **2001**, *85*, 67–73.
- 63 Roberts, S.C., Shuler, M.L. *Curr. Opin. Biotechnol.* **1997**, *8*, 154–159.
- 64 Hulst, A.C., Tramper, J.J. *Enzyme Microbiol. Technol.* **1989**, *11*, 564–568.
- 65 Doerenburg, H., Knorr, D. *J. Biotech.* **1995**, *50*, 55–62.
- 66 Gontier, E., Sangwan, B.S., Barbotin, J.N. *Plant Cell Rep.* **1994**, *13*, 533–536.
- 67 Verpoorte, R., van der Heijden, R., ten Hoopen, H.J.G., Memelink, J. *Biotechnol. Lett.* **1999**, *21*, 467–479.
- 68 Verpoorte, R., van der Heijden, R., Memelink, J. *Transgenic Res.* **2000**, *9*, 323–343.
- 69 Lin, L.D., Wu, J.Y. *Biotechnol. Bioeng.* **2002**, *78*, 81–88.
- 70 Ye, H., Huang, L.L., Chen, S.D., Zhong, J.J. *Biotechnol. Bioeng.* **2004**, *89*, 788–795.
- 71 Micheal, A., Spena, A. *Methods Mol. Biol.* **1995**, *44*, 207–222.
- 72 Charlwood, B.V., Charlwood, K.A., Molina-Torres, J. In: Charlwood, B.V., Rhoades, M.J.C. (Eds.), *Secondary Products from Plant Tissue Culture*. Clarendon Press, Oxford, UK, **1990**, pp. 201–226.
- 73 Flores, H.E., Vivanco, J.M., Loyola-Vargas, V.M. *Trends Plant Sci.* **1999**, *4*, 220–226.
- 74 Kim, Y., Wyuslouzil, B.E., Weathers, P.J. *In Vitro Cell. Dev. Biol.* **2002**, *38*, 1–10.
- 75 Weathers, P.J., Hemmavanh, D.D., Walcerz, D.B., Cheetham, R.D. *In Vitro Cell. Dev. Biol. Plant* **1997**, *33*, 306–312.
- 76 Rijhwani, S., Shanks, J.V. *Biotech. Prog.* **1998**, *14*, 442.
- 77 Sasaki, K., Udagawa, A., Ishimaru, H., Hayashi, T., Alfermann, A.W., Nakanishi, F., Shimomura, K. *Plant Cell Rep.* **1998**, *17*, 457–459.
- 78 Nussbaumer, P., Kapetanidis, I., Christan, P. *Plant Cell Rep.* **1998**, *17*, 405–409.
- 79 Wysokinska, H., Rozga, M. *J. Plant Physiol.* **1998**, *152*, 78–83.
- 80 Nishikawaa, K., Ishimaru, K. *J. Plant Physiol.* **1997**, *151*, 633–636.

- 81 Kittipongpatana, N., Hock, R.S., Porter, J.R. *Plant Cell Tissue Org. Cult.* **1998**, *52*, 133–143.
- 82 Banerjee, S., Rahman, L., Uniyal, G.C., Ahuja, P.S. *Plant Sci.* **1998**, *131*, 203–208.
- 83 Weathers, P.J., Cheetham, R.D., Follansbee, E., Teoh, T. *Biotechnol. Lett.* **1994**, *16*, 1281–1286.
- 84 Jaziri, M., Shimomura, K., Yoshimatsu, K., Fauconnier, M.-L., Homes, J. J. *Plant Physiol.* **1995**, *145*, 175–177.
- 85 Liu, C.Z., Wang, Y.C., Zhao, B., Guop, C., Ouyang, F., Ye, H.C., Li, G.F. *In Vitro Cell Dev. Biol.* **1999**, *35*, 271–274.
- 86 Wallaart, T.E., Pras, N., Quax, W.J. *J. Nat. Prod.* **1999**, *62*, 1160–1162.
- 87 Kwon, B.M., Ro, S.H., Kim, M.K., Nam, J.Y., Jung, H.J., Lee, I.R., Kim, Y.K., Bok, S.H. *Planta Med.* **1997**, *63*, 552–553.
- 88 Asada, Y., Li, W., Yoshikawa, T. *Phytochemistry* **1998**, *47*, 389–392.
- 89 Roberts, M.F., Strack, D. In: Wink, M. (Ed.), *Biochemistry of Plant Secondary Product Metabolism*. CRC Press, USA, 1999, pp. 17–78.
- 90 Sata, F., Hashimoto, T., Hacia, A., Tamura, K., Choi, K.-B., Morishige, T., Fujimoto, H., Yamada, Y. *Proc. Natl. Acad. Sci. USA* **2001**, *98*, 367–372.
- 91 Jouhikainen, J., Lindgren, L., Jokelainen, T., Hiltunen, R., Teeri, T.H., Oksman-Caldentey, K.-M. *Planta* **1999**, *208*, 545–551.
- 92 van der Frits, L., Memelink, J. *Science* **2000**, *289*, 295–297.
- 93 Grotewold, E., Chamberlin, M., Snook, M., Siame, B., Butler, L., Swenson, J., Maddock, S., St. Clair, G., Bowen, B. *Plant Cell* **1998**, *10*, 721–740.
- 94 Fecker, L.H., Hildebrandt, S., Rügenhagen, C., Herminghaus, S., Landsmann, J., Berlin, J. *Biotechnol. Lett.* **1992**, *14*, 1035–1040.
- 95 Lodhi, A.H., Bongaerts, R.J.M., Verpoorte, R., Coomber, S.A., Charlwood, B.V. *Plant Cell Rep.* **1996**, *16*, 54–57.
- 96 Winkel, B.S.J. *Annu. Rev. Plant Biol.* **2004**, *55*, 85–107.
- 97 Spivey, H.O., Ovadi, J. *Methods* **1999**, *19*, 306–321.
- 98 Li, S.-M., Wang, Z.-X., Wemako, E., Heide, L. *Plant Cell Physiol.* **1997**, *38*, 844–850.
- 99 Siebert, S., Sommer, S., Li, S., Wang, Z., Severin, K., Heide, L. *Plant Physiol.* **1996**, *112*, 811–819.
- 100 Sajc, L., Grubisic, D., Vunjak-Novakoivic, G. *Biochem. Eng. J.* **2000**, *4*, 89–99.
- 101 Kim, Y., Wyslouzil, B.E., Weathers, P.J. *Plant Cell Rep.* **2001**, *20*, 451–455.
- 102 Lee, K., Suzuki, T., Yamakawa, T., Kodama, T., Igarashi, Y., Shimomura, K. *Plant Cell Rep.* **1999**, *18*, 567–571.
- 103 Ulbrich, B., et al. In: Neuman, K.H. (Ed.), *Primary and Secondary Metabolism of Plant Cell Cultures*. Springer-Verlag, Berlin, **1985**, pp. 293–303.
- 104 Fujita, Y., Tabatha, M. In: Green, C.E., Somers, D.A., Hacket, W.P., Biesboer, D.D. (Eds.), *Plant Tissue and Cell Culture*. Alan R. Liss, New York, USA, **1987**, pp. 169–185.
- 105 Hilton, M.G., Rhoades, M.J.C. *Appl. Microbiol. Biotech.* **1990**, *33*, 132–138.
- 106 Eilert, U., et al. *J. Plant Physiol.* **1985**, *119*, 65–76.
- 107 Srinivasan, V., Pestchanker, L., Moser, S., Hirasuna, T.J., Taticek, R.A., Shuler, M.L. *Biotech. Bioeng.* **1995**, *47*, 666–676.
- 108 Hara, Y. In: DiCosmo, F., Misawa, M. (Eds.), *Plant Cell Culture Second Metabolism – Towards Industrial Application*. CRC Press, Boca Raton, FL, USA, **1996**, pp. 187–202.

## 10

# Impact of Whole-Genome and Expressed Sequence Tag Databases on the Study of Plant Secondary Metabolism

Jillian M. Hagel, Jonathan E. Page, and Peter J. Facchini

### 10.1

#### Introduction

Plants produce a wide diversity of low-molecular-weight natural products via a network of typically complex secondary metabolic pathways. To date, more than 100 000 natural products, such as terpenoids, phenylpropanoids and alkaloids, have been identified [1]. Despite the widespread application and economic importance of these compounds as dyes, pigments, flavors, aromas, medicines and poisons, the physiological relevance of most natural products has not been determined. However, secondary metabolites – deemed *secondary* only because they are not required for normal growth and development – generally play physiological roles ranging from plant defense against herbivores to the attraction of pollinators.

The past few decades have seen the elucidation of major secondary metabolic pathways and the discovery of many novel biosynthetic enzymes. The early development of radioactive tracing techniques, the later use of plant tissue culture methods, and the more recent application of molecular biological approaches have each represented a *revolution* in the efficiency and efficacy of research on plant secondary metabolism. The most recent – and perhaps the most profound – revolution involves the widespread use of genomics, which can be defined as the use of current knowledge of whole or partial genome sequences to answer broad biological questions [2]. Research involving plant secondary metabolism has taken advantage of the genomics revolution by using new tools to isolate novel genes, to elucidate evolutionary relationships between plant species, and to understand intricate signaling and regulatory networks. In this chapter, we review the application of plant genome and related sequence resources to the discovery of novel biosynthetic genes involved in terpenoid, phenylpropanoid, and alkaloid metabolism in order to demonstrate the potential of genomics to advance research in the field of plant secondary metabolism.

## 10.2

### Whole-Genome Sequences

Plant biology was formally ushered into a new era in December 2000, with the completion of the *Arabidopsis thaliana* genome sequence. Representing 115 million base pairs (Mb) of euchromatin out of the estimated 125-Mb genome, recent estimates total the number of genes at 30 700 (version 5 annotation; The Arabidopsis Information Resource, TAIR; <http://www.arabidopsis.org>). The International Rice Genome Sequencing Project declared the rice genome sequence complete in December 2004, while large-scale efforts are being made toward the sequencing of tomato (*Lycopersicon esculentum*), lotus (*Lotus corniculatus*), barrel medic (*Medicago truncatula*), and black cottonwood (*Populus trichocarpa*) genomes. Certainly, the sequencing of an entire plant genome is a daunting task; nuclear genomes of plants are often notoriously large, requiring immense resources, investment and coordination. However, the real challenge of this new era lies not with the amassment of sequence data, but with the application of genomic information to biological problems. The high quality of the *A. thaliana* annotation is expected to strengthen broad comparisons involving proteome content, transcriptional patterns, and epigenetic state, with other plants and distantly related model organisms [3]. Comparative genomics may be used to identify functional elements, which are more likely to be conserved through time while neutral mutations accumulate. When multiple gene sequences are aligned, conserved regulatory regions, noncoding genes, and protein coding genes become evident [4, 5]. Ultimately, information garnered from genome analyses may be applied to functional genomics in plants for which little or no sequence data are available, rendering whole-genome studies of model organisms invaluable to medicinal plant biology.

Computers, software, and the World Wide Web are integral components to the analysis of, and access to, genome sequence information. Reiser et al. [6] provided a survey of plant genome data resources, including those containing information for single or multiple plant species. The types of data available through public databases include DNA and protein sequences, precomputed phylogenetic profiles of completed genomes, sequence analysis software, maps, clones and seed stocks. The National Center for Biotechnology Information (NCBI; <http://www.ncbi.nih.gov>) provides a data-rich platform in support of genomic research by integrating data from more than 20 biological databases, using a flexible search and retrieval system named Entrez [7]. Entrez-Nucleotide, a core database in Entrez, includes GenBank [8], which is a primary database of nucleotide sequences synchronized daily with the DNA Databank of Japan [9] and the European Molecular Biological Laboratory [10]. The Entrez system also covers a suite of more specialized databases of particular relevance to genomics, such as Entrez Genomes, Unigene, Entrez Gene, and HomoloGene. Entrez Genome contains genomic sequence and annotations for over 1000 organisms, including 39 complete sequences for plant chromosomes, plastids, and mitochondria. Taking advantage of the same database technology as Entrez, and supporting text queries with Boolean logic, the NCBI Map Viewer (<http://www.ncbi.nih.gov/mapview/>) is used to display genomic maps for

many plants and animal genomes. Performing a BLAST search using an accession, GI, or sequence in FASTA format leads to Map Viewer displays in which the genomic context of the hits can be seen. This function is useful for identifying non-coding, putative regulatory elements in model organisms, and finding conserved regulatory regions in plants for which genome sequence is unavailable.

Comparative plant genomics resources are also available through PlantGDB (<http://www.plantgdb.org/>), a database of plant molecular sequences. PlantGDB contains data of plant sequences extracted from public sequence repositories such as GenBank, including assembled expressed sequence tag (EST) and genome survey sequence (GSS) contigs, and the complete genome sequences for *Arabidopsis* and rice [11]. The extracted sequences are sorted by taxonomic classification to provide fast and easy access to sequence subsets limited to individual species or phylogenetic group, and the site is synchronized daily with source public repositories. Currently, PlantGDB contains sequences from over 24 000 plant species, representing more than 6000 genera. Unique to PlantGDB, researchers have access to three online sequence data analysis tools: BLAST@PlantGDB, GeneSequer@PlantGDB, and PatternSearch@PlantGDB. Although nearly all sequence databases provide an online BLAST server, most restrict researchers to one database at a time, making PlantGDB's multi-source database an attractive alternative. For example, the current NCBI BLAST server requires a selection of predefined database options (e.g., "nr", "est", "gss", etc.), whereas this distinction is not necessary at PlantGDB.

Research progress toward the completion of large-scale genome sequencing projects may be accessed at <http://www.ncbi.nih.gov/genomes/PLANTS/PlantList.html>. Following the links leads to information regarding species-specific genome characteristics (i.e., size, chromosome number, ploidy) and the research center or consortium currently engaged in genome sequencing. A more comprehensive listing of genome sequencing initiatives is available (<http://www.ncbi.nih.gov/genomes/leuks.cgi>), although many of the projects listed have not yet started, or are operating on a "small-scale" basis. Plant species for which genome sequencing initiatives are in progress include *Arabidopsis* family members *A. lyrara* and *Capsella rubella*, cultivated grains *Sorghum bicolor* and *Triticum aestivum*, fruits, legumes, trees, and evolutionarily important fern (*Selaginella moellendorffii*) and moss (*Physcomitrella patens*) species. The genomes of several green algae are also being sequenced.

As sequence data accumulate for myriad plant species, the model genome of *Arabidopsis thaliana* will continue to serve as our genetic workhorse. Plant research has placed enormous expectation in this small, weedy "supermodel" plant, prompting the launch of the ambitious *Arabidopsis* 2010 Program, the aim of which is to determine the function of every gene within the span of a decade [12]. The *Arabidopsis* genome contains an impressive array of genes, encoding enzymes involved in primary and secondary metabolism. More than 300 members of the cytochrome P450 gene family are represented, in addition to a large number of transcription factors (~1500), many of which are unique to plants [3]. Despite these features, and although *Arabidopsis* has been used extensively to study aspects of primary metabolism, secondary metabolism is more often studied in "exotic" or medicinal plants [13]. Ironically, once genes that encode enzymes involved in the bio-

synthesis of a class of secondary metabolites (e.g., alkaloids) are found in such species, sequence comparisons often reveal that the *Arabidopsis* genome contains related sequences [14]. However, sequence homology is often insufficient evidence on which to base predictions of specific enzyme function, let alone the overall biosynthetic capacity of a certain plant. Due to examples of minor, even single, amino acid substitutions conferring distinct substrate specificities in enzymes involved in natural product metabolism, caution is advised when interpreting sequence data [15, 16]. While available genome information cannot be used to replace traditional, empirical enzyme characterization, gene annotations may be used to identify conserved sequence domains suggesting putative enzyme function.

Gene discovery and annotation within sequenced genomes provide tools for the identification and isolation of homologues in non-model plants. Reference plants often produce metabolites known to be involved in the biosynthesis of nutraceutical or pharmaceutical compounds, thereby facilitating the study of these compounds in medicinal plant species. The completion of genome sequences of model organisms also permits broader applications, such as comparative genomics. Comparative mapping has revealed extensive genome co-linearity between species in the same family, and microsyntenic correlations between distantly related species [17]. Syntenic relationships can extend genetic maps established in one species to related species, and provide unambiguous identification of gene orthologues [18]. Comparative sequence analysis of large DNA regions across species has identified long-range, *cis*-regulatory elements that are difficult to find by conventional methods [19–21]. The first comparative genetic maps were created during the late 1980s [22, 23]. As a natural product of the “genome”, comparative mapping gained the precision necessary for a more exact delineation of the syntenic relationships between members of the grass and legume families [24–26].

The most comprehensive comparative dataset to date is from the grass family, which contains all of the major cereals [27]. The Poaceae family includes wheat, maize, barley, sorghum, oats, sugarcane, and the model plant, rice. Synteny is fairly conserved across the cereal genomes, and local regions of co-linearity will be of immense use in positional cloning efforts in larger cereal genomes [28]. Availability of genomic sequence from two subspecies of rice (*O. japonica* and *O. indica*) provides a profound resource for adaptation and evolution studies. Phylogenetic approaches have been used to identify conserved, noncoding sequences (CNS) in plant genes in a number of studies [29–31], including a comparative analysis of *phytochrome A* gene promoters from sorghum, maize, and rice, revealing a CNS that spanned known *cis*-regulatory sequences [32]. Buchanan et al. [33] carried out a phylogenetic analysis of 5′-noncoding regions from ABA-responsive *rab16/17* gene family of sorghum, maize and rice, with the goal of determining how to use sequence data to identify *cis*-elements that control gene expression in grass species. Using the FootPrinter software package (<http://bio.cs.Washington.edu/software>) and the well-characterized maize *rab17* as a model, several conserved 5′-noncoding regions were identified as putative transcription factor binding sites.

Evidently, the concept that conserved genome structure can facilitate transfer of knowledge among related plant species has been exemplified in grasses. Sequenc-



ing of *Medicago truncatula* and *Lotus japonicus* has encouraged a similar trend within the legume family [34]. Fabaceaeous plants include the crop species soybean (*Glycine max*), peanut (*Arachis hypogaea*), and alfalfa (*Medicago sativa*), along with numerous beans and peas. Using *M. truncatula* as the central point of comparison, an in-depth analysis of legume macrosynteny within pea, mungbean and alfalfa was reported by Choi et al. [26, 35]. Microsynteny, which refers to conserved gene content and order at the sequence level in a short, physically defined DNA contig, has been estimated between *M. truncatula* and soybean using a hybridization strategy involving bacterial artificial chromosome (BAC) contigs [36]. The demonstrably conserved genome structure between *M. truncatula* and crop legumes has permitted map-based cloning of genes required for nodulation in crop legumes, using *M. truncatula* as a surrogate genome [37, 38]. Beyond comparisons between members of the grass or legume families, genome-wide comparisons of gene families within more divergent species have been reported. Open reading frames (ORFs) encoding P-type ATPase ion pumps [39], *CONSTANS*-like genes [40], cryptochrome ORFs [41] and calcium-sensing gene families [42] that have been examined in both rice and *Arabidopsis* have shed light on conserved genes and pathway components in these two model species.

### 10.3

#### Expressed Sequence Tags

In plants for which the complete genome sequence is available, information on both the physical and functional annotation of the genome can be gained through transcriptional genomics [43, 44]. This advantage is especially true for the model plant *Arabidopsis*, whose genome annotation is particularly strong. In plant species for which complete genomes sequences are not available, cDNA libraries, and increasingly, EST databases have been used as a source of DNA sequence information [13]. ESTs differ from cDNAs in that they are generally shorter and/or incomplete copies of mRNA sequence. Generating sequence information from EST fragments serves two purposes: (i) the discovery of new genes; and (ii) the assessment of their expression levels in the source tissue [45]. The approach is based on the premise that the level of an mRNA molecule in a specific tissue is mirrored by the frequency of the occurrence of its corresponding EST in a clone library. In this regard, EST sequencing methods are distinct from ratio-based techniques, such as microarraying, in that they are immediately quantitative [46]. EST-based projects are attractive because they do not rely on existing sequence information from the organism under study. For this reason, the construction of EST databases presents a distinct advantage for non-model plants. A disadvantage of EST sequencing approaches, however, is the expense. Even at a few dollars per sequence, the process can be costly if one desires to progress beyond a cursory screening of abundant transcripts to an in-depth analysis [47]. Beyond the statistical questions raised by sampling small numbers of a large population [48], there are also bias problems involved with cloning and cDNA synthesis. Consequently, EST sequencing on a larg-



er scale is favored as this minimizes such concerns. In theory, expression profiles can be derived for very weakly expressed genes if ESTs are sequenced in sufficient number.

Exhaustive sequencing of ESTs is a common method for gene expression profiling, while the primary objective of EST sequencing is usually to generate genic sequence information [49]. To reduce the amount of sequencing required in achieving a survey of expressed genes, auxiliary techniques such as subtractive hybridization [50], representational difference analysis (RDA) [51] and suppression subtractive hybridization (SSH) [52] can be used. Expressed sequence tag data are generated by bulk, single-pass, partial sequencing of cDNA clones (~500 base pairs). Comparisons of EST frequencies in libraries constructed from different tissues may reveal differential gene expression patterns [53]. Unfortunately, public plant EST libraries are, in general, too small or from too many sources for accurate expression analyses.

As of November 2005, there were 420 789 *Arabidopsis thaliana* ESTs or cDNAs in GenBank (<http://www.ncbi.nlm.nih.gov/dbEST>). The abundance of ESTs in the GenBank *Arabidopsis* library does not accurately reflect gene expression levels, however, since most of these clones were generated either from a single library derived from multiple tissues or were selected from normalized libraries [49, 54, 55]. Although model plants and crop species are well represented in GenBank EST databases, few and often no ESTs are available for “exotic” and/or medicinal plants. Other public or non-profit sites containing EST sequence information include <http://www.tigr.org> and <http://www.plantgdb.org>. Specialized internet-accessible databases exist for individual crop species [11] and plants such as grapevine (*Vitis vinifera*) (<http://www.vitigen.com>) and various conifer species (<http://treenomix.com>). In some cases, EST databases amassed by private corporations may be mined for academic purposes [56], usually with proprietary/monetary considerations.

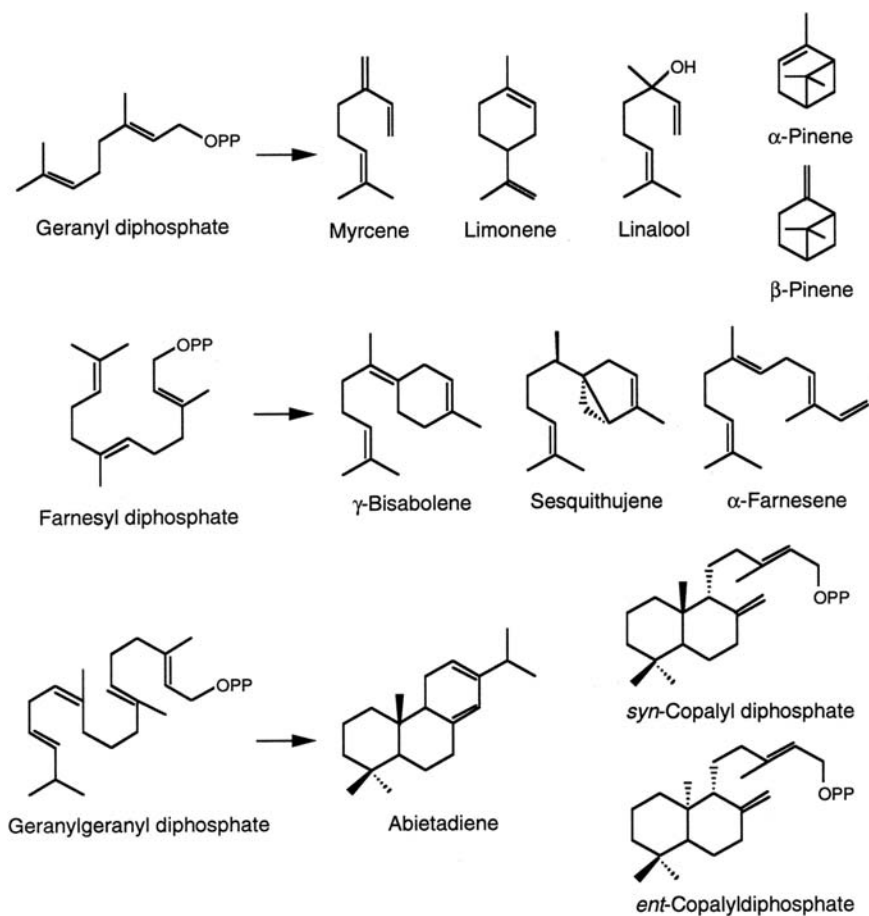
Software developments for use in EST analyses are routinely published [11, 57, 58]. Because EST sequences are typically redundant, assembly of overlapping ESTs into putative contigs constitutes the first step in generating a usable library. EST assembly remains a computational challenge given the large number of ESTs currently available. Computational requirements can be reduced using parallel EST clustering programs such as PaCE [59] (<http://bioinformatics.iastate.edu/bioinformatics2go/PaCE/>), which is employed by PlantGDB. Researchers working on a particular organism often generate their own species-specific contigs, either independently or in collaboration with groups specializing in genomic analysis. Additionally, PlantGDB makes available data analysis tools such as GeneSeqer@PlantGDB and PatternSearch@GDB. In particular, GeneSeqer@PlantGDB allows researchers to “thread” EST sequences onto genomic DNA across all plant species, helping identify linking patterns between genes. The PatternSearch tool permits searches for relatively short matches – possibly interspersed with mismatches, insertions, or deletions – against PlantGDB sequences. For a more complete review of these and related EST analysis programs, the reader is referred to Dong et al. [11].

## 10.4 Terpenoids

The isoprenoids comprise the largest and most diverse family of natural products [60]. More than 30 000 individual terpenoid compounds have been identified, of which at least half are synthesized by plants [61]. Although the vast majority of terpenoids are classified as secondary metabolites, a relatively small number of isopentenyl-derived compounds are involved in plant primary metabolism including, for example, the phytol side chain of chlorophyll, the carotenoid pigments, the phytosterols of cellular membranes, and the gibberellin plant hormones. Mixtures of terpenoids form the basis of a range of commercially important products, such as essential oils, turpentine, and resins [62, 63]. The flavors and aromas of many herbs, spices and fruit can be attributed to the presence of volatile isoprenoids. Mints, sages and basil synthesize and store terpenoid cocktails in glandular trichomes, and citrus fruit owes its scent to the sesquiterpenoid valencene [64–66]. For centuries, plant varieties such as rose have provided humankind with a source of natural perfume [67, 68], while many flowers have relied for much longer on the monoterpene constituents of floral scent to attract pollinating insects [69–71]. Constitutive and induced terpenoids are important defense compounds for many plants against potential herbivores and pathogens, as seen in the traumatic resin response of Norway spruce to insect infestation [72, 73]. In terms of our own defense, several terpenoids are of pharmacological significance, including the dietary anticarcinogen limonene [74] (Fig. 10.1), the antimalarial artemisinin [75], and the anticancer drug paclitaxel (Taxol) [76, 77].

All terpenoids are derived from the central precursor isopentenyl diphosphate (IPP). In plants, IPP is synthesized in the cytosol via the classical mevalonate (MVA) pathway [78], by which sesquiterpenes ( $C_{15}$ ) and triterpenes ( $C_{30}$ ) are formed, and in the plastids via the non-mevalonate, or methylerythritol phosphate (MEP) pathway [79, 80]. New evidence in snapdragon, however, has suggested that both mono- and sesquiterpenes may be synthesized in the plastid [81]. These two spatially distinct pathways have recently been elucidated in plants and microorganisms, and the genes encoding all the enzymes in both pathways have now been identified [82, 83]. As shown in Figure 10.1, these three acyclic prenyl diphosphates serve as immediate substrates for terpene synthases (TPSs), which generate a vast array of mono-, sesqui-, and diterpenoid compounds. Although the first three TPS genes were isolated from distantly related plants [84–86], sequence comparisons revealed a degree of relatedness [86–89]. Later analysis of the deduced amino acid sequences of 33 TPSs from angiosperms and gymnosperms allowed the identification of six TPS gene subfamilies [90]. Conservation between these subfamilies has eased subsequent efforts to clone new genes based on genome sequence data alone [91].

Prior to the availability of complete genome sequences, the search for isoprenoid biosynthetic genes began in plants well-known for their production of essential oils, resins, or terpenoid volatiles. In the case of *Arabidopsis*, a reversal of this trend occurred. Analysis of the *A. thaliana* genome sequence revealed a family of 40 TPS genes [92] which, when taken together with supporting evidence [93, 94], suggest-



**Fig. 10.1** Representative monoterpenes, sesquiterpenes, and diterpenes produced from geranyl diphosphate, farnesyl diphosphate, and geranylgeranyl diphosphate, respectively.

ed the presence of terpenoid metabolism in the model plant. This hypothesis was confirmed by Chen et al. [95] and Aharoni et al. [96], who within the same year published conclusive data concerning the emission of volatile isoprenoids from *Arabidopsis* flowers. The inflorescences were found to emit a complex mixture of more than 20 sesquiterpenes that was primarily dominated by (–)-(E)-β-caryophyllene, in addition to eight monoterpenes [97]. Proton-transfer-reaction mass spectrometry was used to show that *Arabidopsis* roots emit 1,8-cineole [98], a monoterpene formed by the action of a root-specific TPS [99]. The *Arabidopsis* genome sequence has proven to be an invaluable resource, enabling the rapid cloning, characterization, and localization of new genes involved in isoprenoid metabolism [97, 100]. Genomic evidence has suggested that *A. thaliana* also contains higher terpenes, including triterpenes. Fazio et al. [101] used genomic information to clone a predict-

ed oxidosqualine synthase capable of synthesizing tricyclic triterpenoids *in vitro*, adding to previous studies demonstrating the presence of genes encoding similar, higher terpene-synthesizing enzymes in *Arabidopsis* [102–104].

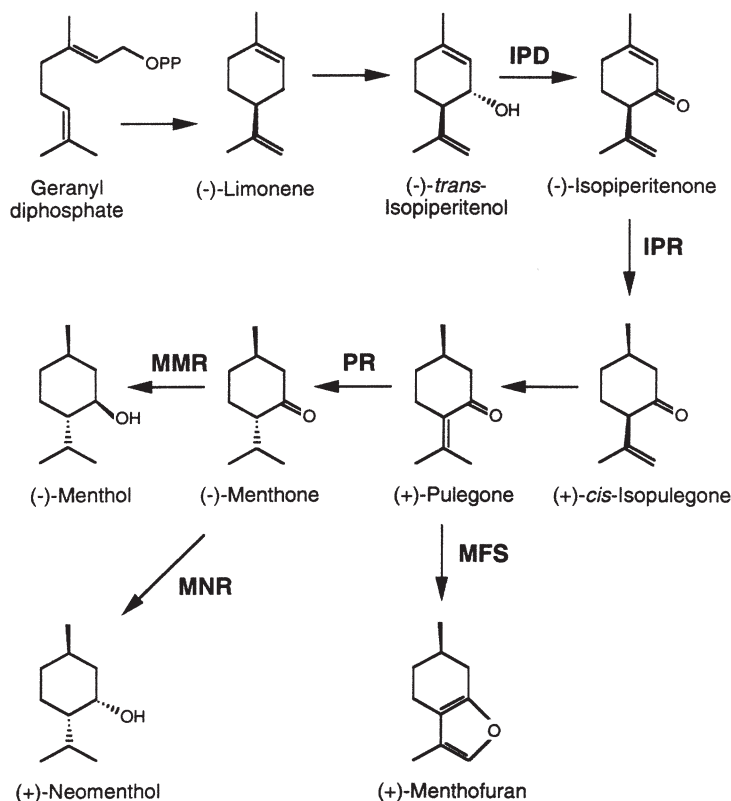
The more recent completion of the rice genome [105] has similarly eased the process of cloning new genes involved in terpenoid metabolism. In particular, there is current interest in the biosynthesis of labdadienyl/copalyl diphosphate (CDP)-derived isoprenoids in rice, since these diterpenoids serve as precursors to important primary metabolites such as gibberellin hormones, as well as to myriad natural products [106–108]. As seen in Figure 10.1, the C<sub>20</sub> terpenoid GGPP is converted to *ent*-CDP by the terpene synthase OsCPS<sub>ent</sub>, for which more than one isoform exists. Two isoforms of OsCPS<sub>ent</sub> were reported by Prisic et al. [109], with one of the two being mined from rice genomic sequence. Weeks earlier, a very similar report of two OsCPS<sub>ent</sub> isoforms had been published [108]. In both papers, the authors concluded that one OsCPS<sub>ent</sub> isoform was UV-inducible and specific for phytoalexin biosynthesis, whereas the other terpene synthase isoform was not inducible and was specific for gibberellin biosynthesis. Rice genomic sequence was also used to isolate a third TPS, specifically responsible for *syn*-CDP-derived phytoalexin/allelopathic compounds (OsCPS<sub>syn</sub>) [107].

With the exceptions of *Arabidopsis* and rice, plant isoprenoid metabolism research relies most heavily on EST sequence databases. In some cases, combinations of public and private EST databases are mined for appropriate clones. Schnee et al. [56] searched a proprietary maize database assembled by Pioneer Hi-Bred International in addition to public databases [110] for ESTs with sequence homology to known TPSs. The selected ESTs were aligned with each other to form contigs. One of these contigs was used to isolate a full-length cDNA encoding a sesquiterpene synthase, which surprisingly exhibited low overall similarity to other plant TPSs. Transcript levels of the corresponding gene *terpene synthase 1* increased with herbivore damage, and the heterologously expressed enzyme was found to catalyze the formation of (*E*)- $\beta$ -farnesene, (*E*)-nerolidol, and (*E,E*)-farnesol. Continued study of maize isoprenoid metabolism showed that allelic variation of two TPS genes, *tps4* and *tps5*, caused variability in sesquiterpene emissions between two maize cultivars [111]. Clones of both genes were obtained by searching the Pioneer Hi-Bred EST sequence libraries. Genomics-based selection of triterpene glycosyltransferases from the model legume *Medicago truncatula* was reported recently [112], as was the cytochrome P450 monooxygenase CYP720B1 (abietadienol/abietadienal oxidase; PtAO) from loblolly pine (*Pinus taeda*) [113]. In conifers, P450s are involved in the formation of a suite of diterpene resin acids. PtAO was cloned and identified using phylogenetic cluster analysis of P450-like ESTs from loblolly pine, functional cDNA screening in yeast (*Saccharomyces cerevisiae*) and *in-vitro* enzyme characterization. Conifer TPSs have been a research focus for ecologists and molecular biochemists alike over the past decade [73]. Resin terpenoids are sequestered in specialized anatomical structures, such as resin ducts or resin blisters. Stem-boring insects damage the resin ducts, exuding monoterpenoid-solvated diterpenes such as pinene (Fig. 10.1). The release of terpenoids creates a long-lasting chemical and physical barrier at the site of insect attack. The evolution of gymno-

sperm TPSs of the *TPS-d* subfamily was examined following the cloning and functional characterization of nine Norway spruce (*Picea abies*) TPS genes [114]. Four clones were isolated by cDNA library filter hybridization, whereas a combination of similarity-based PCR, EST-mining and rapid amplification of cDNA ends (RACE) cloning strategies enabled the isolation of the remaining five TPS genes.

Many other species possess specialized anatomical structures known to biosynthesize and/or store isoprenoid compounds. Plants secrete a diverse array of secondary metabolites within modified epidermal hairs called glandular trichomes. The products that accumulate in or exude from plant glandular trichomes are biosynthesized by secretory cells located at the apex of the trichome [115]. Due to the low level of trichome biomass relative to the organs on which they are located, it is not clear how well trichome-expressed genes are represented in whole-organ cDNA libraries. In response to this problem, specialized EST libraries have been developed from the glandular trichome cells of peppermint (*Mentha × piperita*) [116], sweet basil (*Ocimum basilicum*) [64], alfalfa (*Medicago sativa*) [117] and wild and cultivated tomatoes (<http://www.tigr.org/tdb/tgi/>). While a significant proportion of ESTs from mint and tomato trichome libraries represented genes involved in terpenoid metabolism, the peltate glands of basil appeared to be richer with clones dedicated to phenylpropene biosynthesis [64]. In the case of alfalfa, no ESTs corresponded to enzymes of cyclized terpenoid biosynthesis [117]. The isolated secretory cells of peppermint oil glands are capable of *de-novo* biosynthesis of monoterpenes from primary carbohydrate precursors [118], and have been shown to be highly enriched in the enzymes of monoterpene biosynthesis [119]. The monoterpene (*R*)-(+)-menthofuran (Fig. 10.2) is a common component of the essential oil of several *Mentha* species, of which levels in excess of a few percent can decrease the quality of the distilled commercial product. Drawing a candidate cytochrome P450 monooxygenase clone from their EST sequence library [64], Berteau et al. [120] characterized the responsible enzyme menthofuran synthase (MFS) (Fig. 10.2). Exploitation of this highly enriched library has further led to the cloning and functional expression of isopiperitenone reductase (IPR) and pulegone reductase (PR) [121], isopiperitenol dehydrogenase (IPD) [122], and the two menthol reductases (–)-menthone:(–)-(3*R*)-menthol reductase (MMR) and (–)-menthone:(+)-(3*S*)-neomenthol reductase (MNR) [123]. Taken together, these three papers describe the entire complement of cDNAs encoding the redox enzymes of (–)-menthol biosynthesis in peppermint [123]. The biosynthetic pathway and corresponding enzymes are illustrated in Figure 10.2.

Although the EST library of sweet basil was especially rich with clones encoding phenylpropene-related enzymes [64], Iijima et al. [124] reported the isolation of a cDNA encoding geraniol synthase using the sequence database. In a related publication, Iijima et al. [125] examined the biochemical and molecular basis for the divergent patterns in the biosynthesis of terpenes and phenylpropenes in the peltate glands of three cultivars of basil. Interestingly, the total amount of terpenes was correlated with total levels of TPS activities, and negatively correlated with levels of phenylpropanoids and phenylalanine ammonia lyase (PAL) activity. Using an annotated EST database for the three basil cultivars [64, 124], an exhaustive search re-



**Fig. 10.2** Biosynthesis of (-)-menthol, (+)-neomenthol, and (+)-menthofuran. Enzymes for which corresponding molecular clones have been isolated using a genomics-based approach are shown. Abbreviations: IPD, (-)-*trans*-isopiperitenol dehydrogenase;

IPR, (-)-isopiperitenol reductase; PR, (+)-pulegone reductase; MFS, (+)-menthofuran synthase; MMR, (-)-menthone: (-)-*(3R)*-menthol reductase; MNR, (-)-menthone: (+)-*(3S)*-neomenthol reductase.

vealed a total of nine contigs encoding proteins with sequence homology for known TPSs. After obtaining full-length cDNAs for all the contigs, the corresponding protein sequences were aligned and compared, and phylogenetic relationships assessed [125]. TPSs have been similarly isolated and compared in grapevine flowers and berries [126]. Recently, two sesquiterpene synthase cDNAs encoding (+)-valencene synthase and (-)-germacrene D synthase were obtained by *in-silico* screening of a database developed for the grapevine cultivar Gewürztraminer (<http://www.vitigen.com>) [126, 127]. In snapdragon, three genes of a new TPS subfamily were cloned and characterized using a flower EST library containing 792 sequences [71]. Further work with these genes, which encode two myrcene synthases (Fig. 10.1) and one (*E*)- $\beta$ -ocimene synthase, led to the discovery that the nonmevalonate pathway supports both monoterpene and sesquiterpene formation in snapdragon flowers [81].

Genomics approaches have become increasingly popular to investigate the metabolism of natural products in less-characterized exotic and/or medicinal plant species. The root of ginseng (*Panax ginseng*) is known to be rich in ginsenosides, which are glycosylated triterpenes (saponins) and considered to be the main active compounds in ginseng root. Despite the commercial interest in ginseng, little is known about the genes and biochemical pathways involved in ginsenoside biosynthesis. To create a genomic resource, Jung et al. [128] sequenced 11 636 ESTs from five different ginseng libraries. Numerous putative biosynthetic enzymes were identified, including four oxidosqualine cyclase candidates putatively involved in modification of the triterpene backbone. Random sequencing of an induced *Taxus* cell cDNA library was carried out to identify clones involved in Taxol biosynthesis [129]. Taxol is a structurally complex taxane diterpenoid (taxoid) with well-established use as a chemotherapeutic agent. First isolated from bark of the Pacific yew (*Taxus brevifolia*), Taxol is now produced semi-synthetically using natural source taxoid intermediates [130]. To circumvent this dependence on biological sources for Taxol manufacture, research has focused on elucidating the entire Taxol biosynthetic pathway. Jennewein et al. [129] reported surprisingly high abundances for transcripts of several previously defined genes, cDNAs encoding two new cytochrome P450 taxoid hydroxylases, and candidate genes for all but one of the remaining uncharacterized steps. Natural rubber biosynthesis was investigated using a genomics-based approach, wherein the latex of the Brazilian rubber tree (*Hevea brasiliensis*) was used to develop a sequence library of over 20 000 cDNA-AFLP-based transcription-derived fragments (TDFs) and 1176 ESTs [131]. Despite the availability of petroleum-based synthetics, natural rubber (*cis*-1,4-polyisoprene) is highly valued because no synthetic substitute has comparable elasticity, resilience and resistance to high temperature [132, 133]. Surprisingly, only seven gene families accounted for more than 51% of the latex transcriptome, with rubber particle proteins REF (rubber elongation factor) and SRPP (small rubber particle protein) comprising 29% of the total ESTs. Several candidate rubber biosynthetic genes were present, albeit at lower levels.

Logically, the next step toward gene discovery included the use of sequenced elements for transcriptional profiling. Several microarrays of ESTs isolated from plants known to produce isoprenoids either constitutively or inducibly have been reported. Recent examples have included microarray analyses of spider mite-infested tomato [134] and cucumber [135] leaves. In both cases, spider mite (*Tetranychus urticae*) herbivory-induced transcriptional up-regulation of enzymes involved in the biosynthesis of monoterpenes and diterpenes, although a three-day delay between transcriptional up-regulation and emission of volatile terpenoids was noted in tomato. The late increase in volatile production coincided with an increased olfactory preference of predatory mites (*Phytoseiulus persimilis*) for infested plants, leading to the conclusion that tomato activates indirect defenses (volatile production) to complement direct defense responses against spider mites. Transcriptional analysis was used to identify novel scent-related genes in rose petals, using rose flowers from tetraploid scented and nonscented cultivars. DNA chips were prepared from an annotated petal EST database of ~2100 unique genes from both cul-



tivars. Identification of secondary metabolism-related genes whose expression coincided with scent production, combined with detailed analysis of volatile composition in the two rose varieties, led to the discovery of several novel scent-related candidate genes. The biological function of some of these clones, including a germacrene D synthase, was determined using bacteria-expressed recombinant enzymes.

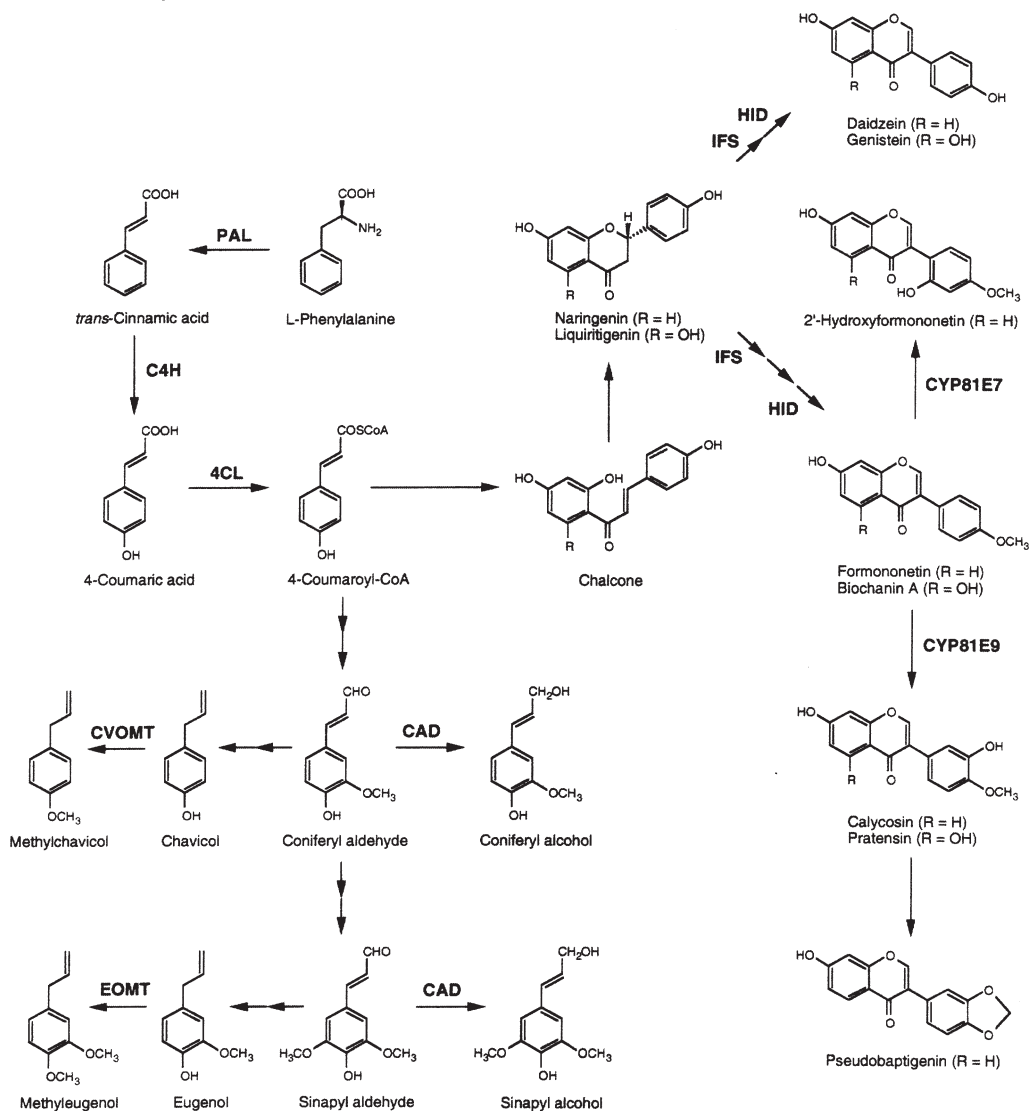
## 10.5

### Phenylpropanoids

Phenylpropanoids are natural products derived from the aromatic amino acid L-phenylalanine. Coumarins, stilbenes, flavonoids/isoflavonoids, lignins and lignans are among the important classes of metabolites that arise from a core phenylpropanoid pathway, which begins with the deamination of phenylalanine via PAL (Fig. 10.3). Although a large proportion of polyphenolic products play defensive and/or structural roles in the plant [136], certain volatile C<sub>6</sub>C<sub>1</sub> benzoic acid derivatives, which are generally included in discussions of phenylpropanoids because of their presumed biosynthetic origin via side-chain shortening of hydroxycinnamic acids (HCAs), serve to attract pollinating insects to flowers [137, 138]. Benzoic/benzoic volatiles are also partly responsible for imparting the unique aromas associated with such herbs as sweet basil (*Osimum basilicum*) [139]. Certainly, more than one metabolic route may exist *in planta* for these compounds. Isochorismate synthase (ICS), for example, was shown to be required for the production of salicylic acid (SA) [140], circumventing PAL-catalyzed phenylpropanoid biosynthesis. The C<sub>6</sub>C<sub>3</sub> phenylpropane-based HCAs comprise a central pathway in phenylpropanoid metabolism (Fig. 10.3). Following phenylalanine-derived cinnamic acid formation, cinnamate 4-hydroxylase (C4H) catalyzes the initial aromatic ring oxidation to generate *p*-coumaric acid. The enzyme 4-coumarate:coenzyme A ligase (4CL) then activates *p*-coumaric acid with an addition of a thioester-bonded coenzyme A group. Although the details are uncertain [136], a series of methyl transfers, hydroxylations, and coniferylaldehyde dehydrogenase (CAD)-catalyzed reductions generate the monolignol precursors for lignin biosynthesis. Complex phenylpropanoids such as flavonoids, isoflavonoids, and stilbenes are formed by the condensation of a phenylpropane unit with malonyl-CoA (MCoA)-derived acetate groups.

As with terpenoid research, the availability of the complete genome sequence of *Arabidopsis thaliana* has proven an important tool to the area of phenylpropanoid biochemistry, especially with respect to lignin biosynthesis. In a study by Costa et al. [141], an exhaustive analysis of TIGR and TAIR databases, together with compiled EST sequence data, was carried out to determine the extent to which various metabolic networks from phenylalanine to the monolignols were organized and/or could be predicted. Although some 65 genes in *A. thaliana* had been annotated as encoding putative enzymatic steps in monolignol biosynthesis, many of them had only low homology to monolignol pathway genes of known function in other plant





**Fig. 10.3** Biosynthesis of phenylpropanoids and isoflavonoids. Enzymes for which corresponding molecular clones have been isolated using a genomics-based approach are shown. Abbreviations: PAL, phenylalanine ammonia lyase; C4H, cinnamate 4-hydroxylase; 4CL, 4-coumaroyl-CoA ligase; CVOMT,

chavicol *O*-methyltransferase; EOMT, eugenol *O*-methyltransferase; CAD, coniferylaldehyde dehydrogenase; IFS, isoflavone synthase; HID, hydroxyisoflavone dehydratase; CYP81E7, isoflavonoid 2'-hydroxylase; CYP81E9, isoflavonoid 5'-hydroxylase.

systems. As a result, only 13 genes could be classified as having *bona fide* function in phenylpropanoid metabolism, whereas the remaining 52 genes were resigned to “undetermined” physiological roles. The authors admitted that biochemical enzyme characterization and physiological studies were necessary to complement genomic database mining in order to discover new genes. In a follow-up report, Costa et al. [142] expressed 11 of the 14 undetermined genes originally annotated as 4CL homologues, and assayed empirically for 4CL enzyme activity. It was found that four of the 11 recombinant proteins were catalytically active, confirming that the 4CL gene family in *A. thaliana* had only four members.

The *Arabidopsis* genome sequence has also proven useful for identification of glucosyltransferase genes involved in sinapate metabolism. Sinapic acid, a major phenylpropanoid of the Brassicaceae family, is an intermediary compound in two distinct metabolic pathways, leading to sinapoyl ester formation and lignin, respectively [143–145]. Glucosyltransferases play key roles in the production of these intermediates, either through the formation of sinapoylglucose leading to the production of sinapoylmalate and sinapoylcholine, or through the production of sinapyl alcohol-4-*O*-glucoside, potentially leading to the syringyl units found in lignins. In combining *Arabidopsis* genome sequence information with biochemical data obtained via screening recombinant proteins for appropriate activities, Lim et al. [145] identified five new sinapoyl-glucosyltransferase clones. As well as sinapate metabolism, glycosyltransferases involved in flavonol glycoside biosynthesis in *A. thaliana* have been cloned [146]. Candidate genes were selected based on sequence homology to other known flavonoid glycosyltransferases, and corresponding T-DNA knockout lines were used to identify plants lacking any glycosylated flavonols. *In planta* observations and *in vitro* enzyme studies led to the cloning of UDP-rhamnose:flavonol-3-*O*-rhamnosyltransferase and UDP-glucose:flavonol-3-*O*-glucoside-7-*O*-glucosyltransferase. A genomics-oriented review of glycosyltransferases involved in plant secondary metabolism was recently published [147].

While *Arabidopsis* has provided a practical model system for the study of certain glycosylated phenylpropanoid products, the use of this species to elucidate lignin biosynthesis in conifers has conjured doubt. It came therefore as a surprise that expressed genes from wood-forming tissues of loblolly pine (*Pinus taeda*) displayed substantial homology with *A. thaliana* genes [148]. Initially, analysis of 59 797 pine ESTs revealed that only 50% of the expressed sequences had homologues in *A. thaliana* or any other angiosperm in public databases. However, very different results were found when the pine ESTs were assembled into contigs containing long, high-quality sequence data. For example, in contigs containing more than 1100 bp, over 90% had an apparent *Arabidopsis* homologue. In another study, global transcript profiling of primary stems from *A. thaliana* identified candidate genes for missing links in lignin biosynthesis and transcriptional regulators of fiber differentiation [149]. Using near-full-genome *Arabidopsis*-spotted 70-mer oligonucleotide arrays, discrete sets of candidate genes involved in various aspects of fiber cell differentiation and maturation were identified, including novel candidates for transcriptional regulation, monolignol polymerization, monolignol transport, and phenylalanine biosynthesis.

Notwithstanding the argument for *A. thaliana* as a model plant for the study of lignin biosynthesis in conifers, EST databases have been developed and used successfully in several coniferous plants, including loblolly pine, *Eucalyptus globulus* and white spruce (*Picea glauca*). In fact, transcriptomics in pine predates the completion of the *Arabidopsis* genome project, wherein 1097 ESTs from gravistimulated immature xylem were sequenced [150]. This database was later employed for the molecular cloning and expression of five laccase cDNAs in loblolly pine [151]. Laccases are multicopper oxidases believed to be involved in lignin oxidation and/or degradation [152, 153].

Since the report of Allona et al. [150], the number of xylem-derived pine ESTs has expanded to over 75 000 (<http://web.ahc.umn.edu/biodata/nsfpine/>) [154]. Investigations involving microarray analyses have also been reported in *Eucalyptus* species. Kirst et al. [155] correlated transcript abundance with trunk diameter variation, revealing coordinated down-regulation of genes encoding lignin biosynthetic enzymes in fast-growing individuals. Additionally, quantitative trait locus (QTL) analysis of transcript levels for lignin-related genes demonstrated that mRNA abundance is regulated by two genetic loci. These two loci were shown to co-localize with QTLs for trunk diameter increases, indicating that the same genetic regions were responsible for regulating trunk growth and lignin biosynthesis. Further microarray-based investigations of QTL involvement in differentiating xylem were reported for a *Eucalyptus* hybrid, along with *E. grandis* and *E. globulus* parents [156]. In this case, the genetic architecture of transcript regulation in different genetic backgrounds was compared. Beyond pine and *Eucalyptus*, transcript profiles of stress-related genes in developing white spruce somatic embryos have been examined [157]. The effects of polyethylene glycol (PEG) on the transcript levels of 512 stress-related genes were analyzed via microarray technique. As well as genes encoding heat shock proteins, glutathione-S-transferases and cysteine proteases, several genes involved in lignin biosynthesis were found to be differentially regulated upon PEG treatment.

It is likely that model plant species such as pine, *Eucalyptus* and spruce will be used well into the future for phenylpropanoid research. Although investigations of lignin metabolism have relied heavily on coniferous systems, members of the Leguminosae family have been used extensively to study flavonoids and isoflavonoids, along with myriad other products [158, 159]. While flavonoids are found throughout the plant kingdom, isoflavonoids are more restricted, and are particularly prevalent in the Papilionoideae subfamily of the Leguminosae. Due to the purported health-promoting activities of both flavonoids and isoflavones, in addition to their uses as colorants [160] and phytoestrogenic agents [161], respectively, major efforts have been made to elucidate the biosynthesis of these compounds. Prior to the initiation of the *Medicago* Genome Initiative [162], soybean EST sequence databases were being developed and used for the cloning of P450 enzymes involved in isoflavone metabolism [163, 164]. Isoflavone synthase (IFS) catalyzes the first committed step of isoflavone biosynthesis (Fig. 10.3), and was identified by searching a fungal-infected soybean seed database of 1700 EST sequences [164].

Since these initial reports, most studies have relied on either *Medicago truncatula* or *Lotus japonica* as model legume systems [159, 165]. Searches of public EST

databases of both these species, in addition to EST databases for soybean (<http://www.tigr.org/tgi/>) was necessary to identify 2-hydroxyisoflavonone dehydratase (HID) (Fig. 10.3). Following the IFS-catalyzed biosynthesis of 2-hydroxyisoflavonone, a water molecule must be shed to convert the flavonone to a flavone. The next steps in forming the more complex isoflavonoid products rely on P450 enzymes, three of which were identified by Liu et al. [166]. Mining of public *M. truncatula* EST databases and screening of a root cDNA library led to identification of the cytochrome P450 81E enzymes CYP81E7, CYP81E8 and CYP81E9; the catalytic role of two of these is indicated in Figure 10.3. These monooxygenases were found to be responsible for regiospecific hydroxylations of various isoflavonoids, although some pathway details remained unclear. In the same year, Xie et al. [167] randomly sequenced a cDNA library from young *M. truncatula* seeds, leading to the identification of a clone encoding anthocyanidin reductase (BANYULS, abbreviated MtBAN). Like isoflavonoids, flavonoids are derived from precursor flavanones, although branching of the flavonoid pathway occurs at leucoanthocyanidin, which can form anthocyanins via ANS (anthocyanin synthase) or condensed tannins via BAN.

In contrast to the aforementioned natural products, little is known about the biosynthesis of phenylpropenes, a group of small phenolic molecules that are key flavoring agents in many important herbs and spices. Phenylpropenes are found in peppercorns, cloves, nutmeg, cinnamon, allspice, pimenta, tarragon and basil [168]; they are also important components of the defensive arsenal of plants or function as pollinator attractants. Eugenol, for example, has antiherbivory and antimicrobial properties [169, 170], while methyl-eugenol attracts pollinating moths and bees to many flower types [65]. Conflicting reports have left unanswered questions regarding how the allyl/propenyl side chain of the phenylpropenes is formed [171–174]. Several recent elaborations on downstream reactions in the pathway have been made, however, for which references are found in Section 10.4. Sweet basil EST sequence databases have been mined for both terpenoid-related genes and phenylpropenoid-related genes, as basil peltate glandular trichomes contain volatiles belonging to both classes of secondary metabolites. Particular attention was paid to phenylpropenes by Gang et al. [175], when a biochemical genomics approach was used to isolate chavicol *O*-methyltransferase (CVOMT) and eugenol *O*-methyltransferase (EOMT). Gang et al. [139] used the same EST sequence database to isolate a cDNA encoding a 3'-hydroxylase (CS 3'H, or CYP98A13).

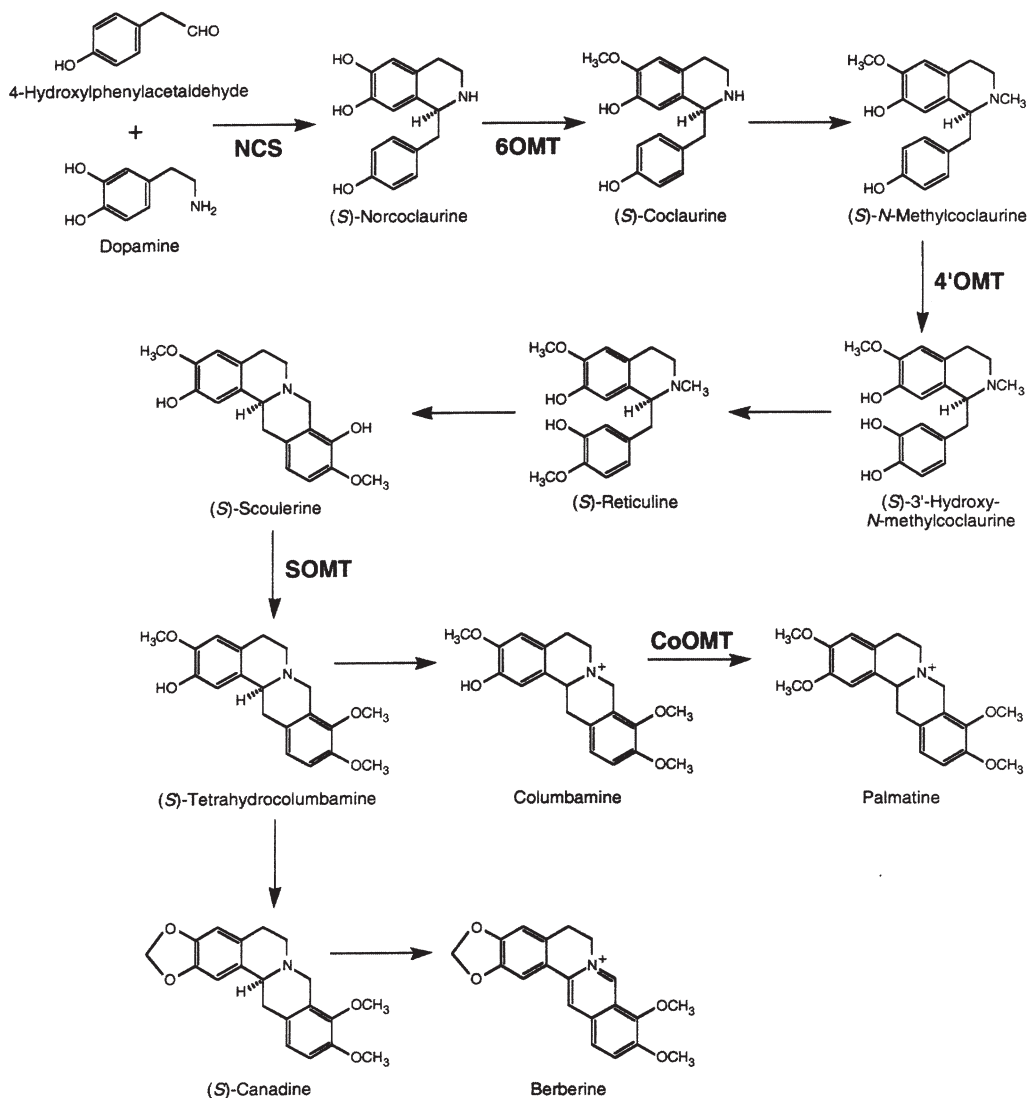
## 10.6 Alkaloids

Alkaloids are a large, diverse group of natural products found in approximately 20% of plant species. Generally characterized by the presence of a nitrogen atom within a heterocyclic ring, many of the 12 000 known alkaloids possess pharmacological activities and are widely used in medicine. Alkaloids draw on the products of primary metabolism for their biosynthesis, with amino acids serving as their

main precursors [176]. Unlike most other groups of secondary metabolites, the structurally diverse alkaloids have independent biosynthetic origins. Tropane alkaloids such as cocaine, atropine and scopolamine are derived from ornithine, benzyloquinoline alkaloids such as morphine, codeine and berberine are produced from tyrosine, whereas tryptophan is used for the biosynthesis of the indole alkaloids vinblastine and strychnine. The biosynthesis of benzyloquinoline alkaloids palmatine and berberine is shown in Figure 10.4, while nicotine/nornicotine biosynthesis is illustrated in Figure 10.5. Typically, multiple catalytic steps are required for the formation of the basic structural nuclei of alkaloids, along with subsequent carbon-ring modifications and “decorative” hydroxylations, methylations, acetylations and glycosylations [177]. Many of the different enzyme classes involved in plant alkaloid metabolism are engaged in primary metabolism, or in the formation of other natural products.

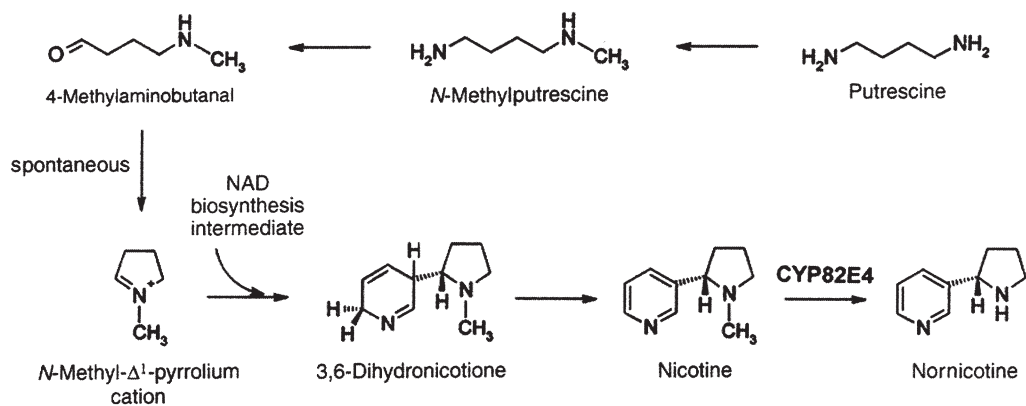
To date, about 40 genes encoding alkaloid biosynthetic enzymes have been cloned [176, 178]. The vast majority of these clones were obtained using traditional biochemical approaches, requiring enzyme purification and protein sequencing. Morishige et al. [179] were the first to use EST sequence data for the molecular cloning of a new gene involved in alkaloid biosynthesis. Using a high-metabolite-producing *Coptis japonica* cell culture, 1014 cDNA clones were isolated and sequenced. Sequences corresponding to three previously reported *C. japonica* O-methyltransferases – norcoclaurine 6-O-methyltransferase (6OMT), 3'-hydroxy-N-methylcoclaurine 4'-O-methyltransferase (4'OMT), and scoulerine 9-O-methyltransferase (SOMT) – were present in the collection (Fig. 10.4). In addition, a novel O-methyltransferase-like cDNA, S-adenosyl-L-methionine:columbamine O-methyltransferase (CoOMT), which catalyzes the conversion of columbamine to palmatine (Fig. 10.4), was also found. The study illustrated the utility of EST analysis for the isolation of new genes involved in benzyloquinoline alkaloid biosynthesis. Comparative macroarray analysis of opium poppy and various morphine-free *Papaver* species was used to identify a *P. somniferum* O-methyltransferase clone [180]. In this case, *P. somniferum* seedlings were used to develop a cDNA sequence library. Of the 849 sequenced elements, three were shown on a macroarray to be differentially expressed in *P. somniferum* compared to non-morphine-producing species. Whereas two of these cDNAs showed no significant homology to any known protein, one was found to encode a protein identified as S-adenosyl-L-methionine(R, S)-3'-hydroxy-N-methylcoclaurine 4'-OMT (4'OMT). Recently, an EST sequence database was used to obtain the *P. somniferum* clone of (S)-norcoclaurine synthase (NCS; Fig. 10.4), which catalyzes the first committed step in benzyloquinoline alkaloid metabolism [181].

A similar gene discovery strategy was used by Pilazke-Wunderlich and Nessler [182], in which homologues for cell-wall-degrading enzymes were found during random sequencing of an opium poppy latex cDNA library. Poppy elements putatively encoding pectin methyltransferase (PME), pectin acetyltransferase (PAE) and pectate lyase (PL) were shown to express specifically in laticifers. Although the corresponding enzymes were not heterologously expressed, assays of latex serum confirmed the presence of PME, PAE and PL activities. Pectin-degrading enzymes



**Fig. 10.4** Biosynthesis of the benzylisoquinoline alkaloids berberine and palmatine. Enzymes for which corresponding molecular clones have been isolated using a genomics-based approach are shown. Abbreviations: NCS, norcoclaurine synthase; 6OMT,

nococlaurine 6-O-methyltransferase; 4'OMT, 3'-hydroxy-N-methylcoclaurine 4'-O-methyltransferase; SOMT, scoulerine 9-O-methyltransferase; CoOMT, columbamine O-methyltransferase.



**Fig. 10.5** Biosynthesis of nicotine and nornicotine. The enzyme for which a corresponding molecular clone was isolated using a genomics-based approach is shown. Abbreviation: CYP82E4, nicotine *N*-demethylase.

with laticifer-specific expression suggested potential involvement of these enzymes in laticifer cell wall expansion and/or degradation. Poppy laticifers are classed as articulated and anastomosing because of their compound origin and the perforations that develop between the lateral walls of adjacent latex vessels. These perforations lead to the long, continuous laticifer cell network found in mature poppy. Since the cellular contents of this network are under positive pressure [183], volumes of latex are released upon cutting. Understanding laticifer development in opium poppy could lead to the prevention of perforations between initials, thereby disallowing the illicit harvesting of opium latex via lancing techniques.

Piperidine alkaloid biosynthesis has also been studied using genomics approaches. The steps leading to the formation of nicotine and nornicotine in tobacco (*Nicotiana tabacum*) are illustrated in Figure 10.5. The production and accumulation of nornicotine, a secondary product formed by the *N*-demethylation of nicotine, is undesirable because it serves as a precursor to the well-characterized carcinogen *N*'-nitrosonornicotine during the curing and processing of tobacco. Typically, nornicotine is a minor piperidine alkaloid in tobacco plants (<5% of total alkaloid content). However, through a process termed “conversion”, plants that accumulate nicotine as their principal alkaloid may give rise to progeny that metabolize a large portion (up to 95%) of leaf nicotine to nornicotine [184]. The enzyme responsible for this conversion is the cytochrome P450 CYP82E4 (Fig. 10.5). Siminszky et al. [184] identified a small number of candidate P450 clones using a microarray-based strategy to identify genes that are differentially regulated between predominantly nicotine- and nornicotine-accumulating plants. RNA interference-induced silencing of these genes in nornicotine-accumulating plants resulted in the suppression of nornicotine production, and further analysis revealed that CYP82E4 was the only P450 directly responsible for nicotine *N*-demethylation.

Evidently, sequenced EST collections derived from alkaloid-producing plant varieties provide information and materials specifically useful for the isolation of genes involved in alkaloid metabolism. Whether genomic information derived from non-alkaloid-producing plants is similarly useful is a matter of current debate [14]. Plant species for which genome sequence data are currently available include *A. thaliana*, rice, *M. truncatula* and other model organisms which are not known to accumulate complex alkaloids. In spite of the apparent lack of complex alkaloid accumulation in *Arabidopsis*, completion of the *A. thaliana* genome sequence has shown that genes involved in the biosynthesis of complex alkaloids in the exotic plant species opium poppy, Madagascar periwinkle (*Catharanthus roseus*) and deadly nightshade (*Atropa belladonna*) are represented by multiple *A. thaliana* homologues [14, 185]. In the original publication describing the complete *A. thaliana* sequence, members of the *Arabidopsis* Genome Initiative [185] surmised that "...the presence of 12 genes with sequence similarity to berberine bridge enzyme (BBE) and 13 genes with similarity to tropinone reductase (TRI) suggests that *Arabidopsis* might have the ability to produce alkaloids." At the transcriptional level, *Arabidopsis* genes encoding putative enzymes BBE and strictosidine synthase (SS) – two key proteins involved in benzyloisoquinoline and monoterpene indole alkaloid biosynthesis, respectively – were found to be regulated by methyl jasmonate and wounding [186]. A postulated capacity for complex alkaloid biosynthesis was further corroborated by the earlier detection of stress-inducible, putative BBE and tyrosine transaminase genes in *Arabidopsis* [187], and the identification of a plant efflux carrier with the ability to transport berberine and related alkaloids [188].

Although *Arabidopsis* does accumulate the simple alkaloid camalexin as a phytoalexin [189], BBE, TRI and SS are key branch-point enzymes in the biosynthesis of certain benzyloisoquinoline, tropane and monoterpene indole alkaloids, respectively, the occurrences of which have never been documented in *A. thaliana*. While these enzymes catalyze reactions specific to complex alkaloid biosynthesis, related enzymes would be expected to act on a broad range of substrates. For example, a recently characterized tobacco BBE sequence homologue was functionally identified as a glucose oxidase (NEC5) [190]. Both BBE and NEC5 are members of the general FAD-dependent oxidoreductase family [190, 191]. Evidence for the existence of a novel gene family with similarity to *C. roseus* SS has been presented [192]. Members of this family are found in a wide variety of organisms, including vertebrates, insects, and nematodes. The *Drosophila* protein hemomucin is a well-studied protein with an SS-like domain [192–194], although the function of hemomucin and its other animal counterparts have not been established. While animal members of the SS-like protein family have not been examined for SS activity, these data suggest a role for such proteins in the coagulation process rather than an involvement in complex alkaloid metabolism [194, 195].

The isolation of a berberine transporter might appear as strong support for the occurrence of complex alkaloids in *Arabidopsis*. However, the common acceptance of berberine as a substrate for such ATP binding cassette (ABC) carriers [196] suggests that even the ABC transporter identified in Japanese goldthread (*Coptis japonica*), a berberine-producing plant, is not necessarily involved in berberine me-



tabolism [197]. An important undercurrent of the present debate is the well-known, yet often overlooked, tenet that sequence homology is an insufficient datum on which to base predictions of specific enzyme function, much less the overall biosynthetic capacity of a plant. The problem is due in part to the protocol used to annotate genomic and EST data. Such annotations are intended only to identify conserved sequence domains and to suggest putative functions as a guide to empirical characterization. A combination of biochemical and molecular phylogenetic approaches was used to investigate the evolution of benzyloquinoline alkaloid biosynthesis in angiosperms [181]. As part of the study, Consensus Bayesian trees were derived from putative or functionally characterized FAD-dependent proteins homologous to BBE. Gene products functionally characterized as BBE grouped together and were found only distantly related to putative BBE-like proteins from non-alkaloid-producing plants such as *Arabidopsis*. Sequence similarity between BBE-like genes from *A. thaliana* and functionally characterized BBE clones may reflect a shared, monophyletic origin, but the question of whether *Arabidopsis* homologues retain BBE activity has yet to be investigated. Beyond BBE, a phylogenetic analysis of proteins sharing homology with NCS was performed. Functionally characterized NCSs from *P. somniferum* and *T. flavum* clustered together, distant from uncharacterized homologues [181].

Since NCS catalyzes the first committed step in benzyloquinoline alkaloid biosynthesis, plant species lacking NCS activity likely do not have the capacity for alkaloid production. A parallel conclusion may be drawn for plants lacking functional SS enzyme, which catalyzes the formation of the structural nucleus common to all monoterpenoid indole alkaloids [176]. Homologues for SS also occur in the *Arabidopsis* genome, albeit with low sequence identity with functionally characterized SSs. The limited similarity between NCS, or SS, and their *Arabidopsis* sequence homologues contrasts with the extensive identity between other groups of alkaloid biosynthetic genes and their counterparts in the *Arabidopsis* genome. Sequence identities of 50–70% are not uncommon when comparing the decarboxylases, methyltransferases, and P450-dependent monooxygenases involved in the biosynthesis of berberine with sequence homologues in *Arabidopsis* [14]. Interestingly, compared to the relatively isolated phylogenetic clustering of functional NCS enzymes, the Consensus Bayesian tree for selected *O*-methyltransferases (OMTs) shows a greater dispersal of functionally characterized OMTs [181]. The ability of a plant species to synthesize a specific alkaloid may depend on the presence of a functional, key entry-point enzyme, even if downstream enzymes retain some catalytic activity. As suggested by Facchini et al. [14], the abundance of *Arabidopsis* sequences sharing homology with genes encoding benzyloquinoline and monoterpenoid indole alkaloid biosynthetic enzymes may reflect an evolutionary phenomenon known as exaptive evolution [198]. Genetic drift of a key enzyme no longer under selective pressure could cause an entire “shutdown” of a biosynthetic pathway, as would hypothetically occur if either NCS or SS activity were to be lost. Perhaps *Arabidopsis* displays a genomic fingerprint for complex alkaloid biosynthesis, but the substrate specificity of some – if not all – of the gene products has changed.

## 10.7

**Conclusion**

Plant secondary metabolites can be defined as compounds that have no recognized role in the maintenance of fundamental life processes in the plants that synthesize them. Despite this rather dismissive description, secondary products play important roles in the interaction of a plant with its environment, and many are economically, medically, and traditionally valuable. The question of how these often highly complex compounds are biosynthesized *in planta* has motivated intense research, and required the application of new technologies and approaches. Revolutionary advances have been made in large steps, beginning with the use of radiotracing methods in the mid-twentieth century, followed by a reliance on tissue culture techniques and subsequently, molecular biology. Genomics represents the most recent revolution in biology. The use of whole genome sequences and species-specific EST collections has allowed rapid discovery of new genes involved in plant secondary metabolism. Additionally, genomic tools have provided the means necessary to understand intricate signaling and regulatory pathways, complex phylogenetic relationships, and overall genetic architecture. The genomics revolution has already had a major impact in the field of natural products research, and will undoubtedly continue to lead to new discoveries.

**Acknowledgments**

P.J.F. is privileged to hold the Canada Research Chair in Plant Biotechnology. Research in his laboratory is funded by grants from the Natural Sciences and Engineering Research Council of Canada. J.M.H. is the recipient of an Alberta Ingenuity doctoral scholarship.

**References**

References marked \* are of interest; those marked \*\* are of considerable interest

- 1 Wink, M. *Functions of Plant Secondary Metabolites and Their Exploitation in Biotechnology*. Sheffield Academic Press, Sheffield, UK, 1999.
- 2 Cullis, C.A. *Plant Genomics and Proteomics*. John Wiley & Sons, Hoboken, New Jersey, 2004.
- 3 Borevitz, J.O., Ecker, J.R. Plant genomics: the third wave. *Annu. Rev. Genomics Hum. Genet.* **2004**, *5*, 443–477.
- 4 Cliften, P., Sudarsanam, P., Desikan, A., Fulton, L., Fulton, B., et al. Finding functional features in *Saccharomyces* genomes by phylogenetic footprinting. *Science* **2003**, *301*, 71–76.
- 5 \* Kellis, M., Patterson, N., Endrizzi, M., Birren, B., Lander, E.S. Sequencing and comparison of yeast species to identify genes and regulatory elements. *Nature* **2003**, *423*, 241–254. [This paper was among the first to use comparative genomics for the discovery of novel genes and regulatory elements. Similar approaches have since been applied to plants, especially in the grass and legume families.]
- 6 \* Reiser, L., Mueller, L.A., Rhee, S.Y. Surviving in a sea of data: a survey of plant genome data resources and issues in building data management systems.

- Plant Mol. Biol.* **2002**, *48*, 59–74. [This paper discussed resources available in the public domain and describes some of the software for data management systems currently available for plant research.]
- 7 \*\* Wheeler, D.L., Smith-White, B., Chetvernin, V., Resenchuk, S., Dombrowski, S.M., Pechous, S.W., Tatusova, T., Ostell, J. Plant genome resources at the National Center for Biotechnology Information. *Plant Physiol.* **2005**, *138*, 1280–1288. [The paper outlines resources available through NCBI for use in nucleotide sequence analysis.]
  - 8 Benson, D.A., Karsch-Mizrachi, I., Lipman, D.J., Ostell, J., Wheeler, D.L. GenBank: update. *Nucleic Acids Res.* **2005**, *33*, D34–D38.
  - 9 Tateno, Y., Saitou, N., Okubo, K., Sugawara, H., Gojobori, T. DDBJ in collaboration with mass-sequencing teams on annotation. *Nucleic Acids Res.* **2004**, *33*, D25–D28.
  - 10 Kanz, C., Aldebert, P., Althorpe, N., Baker, W., Baldwin, A., Bates, K., Browne, P., van den Broek, A., Castro, M., Cochrane, G., Duggan, K., Eberhardt, R., Faruque, N., Gamble, J., Diez, F.G., Harte, N., Kulikova, T., Lin, Q., Lombard, V., Lopez, R., Mancuso, R., McHale, M., Nardone, F., Silventoinen, V., Sobhany, S., Stoehr, P., Tuli, M.A., Tzouvara, K., Vaughan, R., Wu, D., Zhu, W., Apweiler, R. The EMBL nucleotide sequence database. *Nucleic Acids Res.* **2005**, *33*, D29–D33.
  - 11 Dong, Q., Lawrence, C.J., Schlueter, S.D., Wilkerson, M.D., Kurtz, S., Lushbough, C., Brendel, V. Comparative plant genomics resources at PlantGDB. *Plant Physiol.* **2005**, *139*, 610–618.
  - 12 Ausubel, F.M. Summaries of the National Science Foundation-sponsored *Arabidopsis* 2010 projects and National Science Foundation-sponsored plant genome projects that are generating *Arabidopsis* resources for the community. *Plant Physiol.* **2002**, *129*, 394–437.
  - 13 Fridman, E., Pichersky, E. Metabolomics, genomics, proteomics, and the identification of enzymes and their substrates and products. *Curr. Opin. Plant Biol.* **2005**, *8*, 242–248.
  - 14 \* Facchini, P.J., Bird, D.A., St. Pierre, B. Can *Arabidopsis* make complex alkaloids? *Trends Plant Sci.* **2004**, *9*, 116–122. [This review critically examines the suggestion that *Arabidopsis* can produce complex alkaloids based on the occurrence of numerous alkaloid biosynthetic gene homologues in the genome sequence of this plant.]
  - 15 Frey, M., Chomet, P., Glawischnig, E., Stettner, C., Grun, S., Winklmaier, A., Eisenreich, W., Bacher, A., Meeley, R.B., Briggs, S.P., Simcox, K., Gierl, A. Analysis of a chemical plant defense mechanism in grasses. *Science* **1997**, *277*, 696–699.
  - 16 Frick, S., Kutchan, T.M. Molecular cloning and functional expression of O-methyltransferases common to isoquinoline alkaloid and phenylpropanoid biosynthesis. *Plant J.* **1999**, *17*, 329–339.
  - 17 Schmidt, R. Plant genome evolution: lessons from comparative genomics at the DNA level. *Plant Mol. Biol.* **2002**, *48*, 21–37.
  - 18 Brunner, A.M., Busov, V.B., Strauss, S.H. Poplar genome sequence: functional genomics in an ecologically dominant plant species. *Trends Plant Sci.* **2004**, *9*, 49–56.
  - 19 Vu, T.H., Hoffman, A.R. Comparative genomics sheds light on mechanisms of genomic imprinting. *Genome Res.* **2000**, *10*, 1660–1663.
  - 20 King, G.J. Through a genome, darkly: comparative analysis of plant chromosomal DNA. *Plant Mol. Biol.* **2002**, *48*, 5–20.
  - 21 Van der Peer, Y. 'Horozontal' plant biology on the rise. *Genome Biol.* **2004**, *6*, 302
  - 22 Bonierbale, M.W., Plaisted, R.L., Tanksley, S.D. RFLP maps based on a common set of clones reveal modes of chromosomal evolution in potato and tomato. *Genetics* **1988**, *120*, 1095–1103.
  - 23 Chao, S., Sharp, P.J., Worland, A.J., Warham, E.J., Koebner, R.M.D., Gale, M.D. RFLP-based genetic maps of wheat homologous group 7 chromosomes. *Theoret. Appl. Genet.* **1989**, *78*, 495–504.
  - 24 Devos, K.M., Gale, M.D. Comparative genetics in the grasses. *Plant Mol. Biol.* **1997**, *35*, 3–15.

- 25 Gale, M.D., Devos, K.M. Plant comparative genetics after 10 years. *Science* **1998**, *282*, 656–659.
- 26 Choi, H.-K., Mun, J.-H., Kim, D.-J., Zhu, H., Baek, J.-M., Mudge, J., Roe, B., Ellis, N., Doyle, J., Kiss, G.B., Young, N.D., Cook, D.R. Estimating genome conservation between crop and model legume species. *Proc. Natl. Acad. Sci. USA* **2004**, *101*, 15289–15294.
- 27 Devos, K.M. Updating the crop circle. *Curr. Opin. Plant Biol.* **2005**, *8*, 155–162.
- 28 Rensink, W.A., Buell, C.R. *Arabidopsis* to rice. Applying knowledge from a weed to enhance our understanding of a crop species. *Plant Physiol.* **2004**, *135*, 622–629.
- 29 Koch, M.A., Weisshaar, B., Kroymann, J., Haubold, B., Mitchell-Olds, T. Comparative genomics and regulatory evolution: conservation and function of the *Chs* and *Apetala* promoters. *Mol. Biol. Evol.* **2001**, *18*, 1882–1891.
- 30 Hong, R.L., Hamaguchi, L., Busch, M.A., Weigel, D. Regulatory elements of the floral homeotic gene *AGAMOUS* identified by phylogenetic footprinting and shadowing. *Plant Cell* **2003**, *15*, 1296–1309.
- 31 Colinas, J., Birnbaum, K., Benfey, P.N. Using cauliflower to find conserved non-coding regions in *Arabidopsis*. *Plant Physiol.* **2002**, *129*, 451–454.
- 32 Morishige, D.T., Childs, K.L., Moore, L.D., Mullet, J. Targeted analysis of orthologous *phytochrome A* regions of the sorghum, maize, and rice genomes using comparative gene-island sequencing. *Plant Physiol.* **2002**, *130*, 1614–1625.
- 33 Buchanan, C.D., Klein, P.E., Mullet, J.E. Phylogenetic analysis of 5′-noncoding regions from the ABA-responsive *rab16/17* gene family of sorghum, maize and rice provides insight into the composition, organization and function of *cis*-regulatory modules. *Genetics* **2004**, *168*, 1639–1654.
- 34 Zhu, H., Choi, H.-K., Cook, D.R., Shoemaker, R.C. Bridging model and crop legumes through comparative genomics. *Plant Physiol.* **2005**, *137*, 1189–1196.
- 35 Choi, H.-K., Kim, D., Uhm, T., Limpens, E., Lim, H., Mun, J.H., Kalo, P., Penmetsa, R.V., Seres, A., Kulikova, O., Roe, B.A., Bisseling, T., Kiss, G.B., Cook, D.R. A sequence-based genetic map of *Medicago truncatula* and comparison of marker colinearity with *M. sativa*. *Genetics* **2004**, *166*, 1463–1502.
- 36 Yan, H.H., Mudge, J., Kim, D.-J., Shoemaker, R.C., Cook, D.R., Young, N.D. Estimates of conserved micro-synteny among genomes of *Glycine max*, *Medicago truncatula*, and *Arabidopsis thaliana*. *Theoret. Appl. Genet.* **2003**, *106*, 1256–1265.
- 37 Endre, G., Kereszt, A., Kevei, Z., Mihacea, S., Kalo, P., Kiss, G.B. A receptor kinase gene regulating symbiotic nodule development. *Nature* **2002**, *417*, 962–966.
- 38 Limpens, E., Franken, C., Smit, P., Willemse, J., Bisseling, T., Geurts, R. LysM domain receptor kinases regulating rhizobial Nod factor-induced infection. *Science* **2003**, *302*, 630–633.
- 39 Baxter, I., Tchieu, J., Sussman, M.R., Boultry, M., Palmgren, M.G., Gribskov, M., Harper, J.F., Axelsen, K.B. Genomic comparison of P-type ATPase ion pumps in *Arabidopsis* and rice. *Plant Physiol.* **2003**, *132*, 618–628.
- 40 Griffiths, S., Dunford, R.P., Coupland, G., Laurie, D.A. The evolution of *CONSTANS-like* gene families in barley, rice and *Arabidopsis*. *Plant Physiol.* **2003**, *131*, 1855–1867.
- 41 Matsumoto, N., Hirano, T., Iwasaka, T., Yamamoto, N. Functional analysis and intracellular localization of rice cryptochromes. *Plant Physiol.* **2003**, *133*, 1494–1503.
- 42 Kolukisaoglu, U., Weinl, S., Blazevic, D., Batistic, O., Kudla, J. Calcium sensors and their interacting protein kinases: genomics of the *Arabidopsis* and rice CBL-CIPK signaling networks. *Plant Physiol.* **2004**, *134*, 43–58.
- 43 Hughes, T.R., Mao, M., Jones, A.R., Burchard, J., Marton, M.J., Shannon, K.W., Lefkowitz, S.M., Ziman, M., Schelter, J.M., Meyer, M.R., Kobayashi, S., Davis, C., Dai, H., He, Y.D., Stephanian, S.B., Cavet, G., Walker, W.L., West, A., Coffey, E., Shoemaker, D.D., Stoughton, R., Blanchard, A.P., Friend, S.H., Linsley, P.S. Expression

- profiling using microarrays fabricated by an ink-jet oligonucleotide synthesizer. *Nature Biotechnol.* **2001**, *19*, 342–347.
- 44 Shoemaker, D.D., Schadt, E.E., Armour, C.D., He, Y.D., Garrett-Engele, P., McDonagh, P.D., Loerch, P.M., Leonardson, A., Lum, P.Y., Cavet, G., Wu, L.F., Altschuler, S.J., Edwards, S., King, J., Tsang, J.S., Schimmack, G., Schelter, J.M., Koch, J., Ziman, M., Marton, M.J., Li, B., Cundiff, P., Ward, T., Castle, J., Krolewski, M., Meyer, M.R., Mao, M., Burchard, J., Kidd, M.J., Dai, H., Phillips, J.W., Linsley, P.S., Stoughton, R., Scherer, S., Boguski, M.S. Experimental annotation of the human genome using microarray technology. *Nature* **2001**, *409*, 922–927.
  - 45 Donson, J., Fang, Y., Espiritu-Santo, G., Xing, W., Salazar, A., Miyamoto, S., Armendarez, V., Volkmoth, W. Comprehensive gene expression analysis by transcript profiling. *Plant Mol. Biol.* **2002**, *48*, 75–97.
  - 46 Bohnert, H.J., Ayoubi, P., Borchert, C., Bressan, R.A., Burnap, R.L., Cushman, J.C., Cushman, M.A., Deyholos, M., Fischer, R., Galbraith, D.W., Sawegawa, P.M., Jenks, M., Kawasaki, S., Koiwa, H., Kore-eda, S., Lee, B.H., Michalowski, C.B., Misawa, E., Nomura, M., Ozturk, N., Postier, B., Prade, R., Song, C.P., Tanaka, Y., Wang, H., Zhu, J.K. A genomics approach towards salt stress tolerance. *Plant Physiol. Biochem.* **2001**, *39*, 1–17.
  - 47 Ohlrogge, J., Benning, C. Unraveling plant metabolism by EST analysis. *Curr. Opin. Plant Biol.* **2000**, *3*, 224–228.
  - 48 Audic, S., Claverie, J.M. The significance of digital gene expression profiles. *Genome Res.* **1997**, *7*, 986–995.
  - 49 Meyers, B.C., Galbraith, D.W., Nelson, T., Agrawal, V. Methods for transcriptional profiling in plants. *Plant Physiol.* **2004**, *135*, 637–652.
  - 50 Sargent, T.D. Isolation of differentially expressed genes. *Methods Enzymol.* **1987**, *152*, 423–432.
  - 51 Hubank, M., Schatz, D.G. Identifying differences in mRNA expression by representational difference analysis of cDNA. *Nucleic Acids Res.* **1994**, *25*, 5640–5648.
  - 52 Diatchenko, L., Lau, Y.F., Campbell, A.P., Chenchik, A., Moqadam, F., Huang, B., Lukyanov, S., Lukyanov, K., Gurskaya, N., Sverklov, E.D., Siebert, P.D. Suppression subtractive hybridization: a method for generating differentially regulated or tissue-specific cDNA probes and libraries. *Proc. Natl. Acad. Sci. USA* **1996**, *12*, 6025–6030.
  - 53 Ewing, R.M., Kahla, A.B., Poirot, O., Lopez, F., Audic, S., Claverie, J.M. Large-scale statistical analyses of rice ESTs reveal correlated patterns of gene expression. *Genome Res.* **1999**, *9*, 950–959.
  - 54 Newman, T., de Bruijn, F.J., Green, P., Keegstra, K., Kende, H., McIntosh, I., Ohlrogge, J., Raikhel, N., Somerville, S., Thomashow, M., et al. Genes galore: a summary of methods for accessing results from large-scale partial sequencing of anonymous *Arabidopsis* cDNA clones. *Plant Physiol.* **1994**, *106*, 1241–1255.
  - 55 Delseny, M., Cooke, R., Raynal, M., Grellet, F. The *Arabidopsis thaliana* cDNA sequencing projects. *FEBS Lett.* **1997**, *405*, 129–132.
  - 56 Schnee, C., Köllner, T.G., Gershenzon, J., Degenhardt, J. The maize gene *terpene synthase 1* encodes a sesquiterpene synthase catalyzing the formation of (*E*)- $\beta$ -farnesene, (*E*)-nerolidol, and (*E*, *E*)-farnesol after herbivore damage. *Plant Physiol.* **2002**, *130*, 2049–2060.
  - 57 Lee, Y., Tsai, J., Sunkara, S., Karamycheva, S., Perte, G., Sultana, R., Antonescu, V., Chan, A., Cheung, F., Quackenbush, J. The TIGR Gene Indices: clustering and assembling ESTs and known genes and integration with eukaryotic genomes. *Nucleic Acids Res.* **2005**, *33*, D71–D74.
  - 58 Schoof, H., Spannagl, M., Yang, L., Ernst, R., Gundlach, H., Haase, D., Haberer, G., Mayer, K.F.X. Munich Information Center for protein sequences plant genome resources. A framework for integrative and comparative analyses. *Plant Physiol.* **2005**, *138*, 1301–1309.
  - 59 Kalyanaraman, A., Aluru, S., Kothari, S., Brendel, V. Efficient clustering of large EST data sets on parallel computers. *Nucleic Acids Res.* **2003**, *31*, 2963–2974.

- 60 Gershenzon, J., Kreis, W. Biochemistry of terpenoids: monoterpenes, sesquiterpenes, diterpenes, sterols, cardiac glycosides, and steroid saponins. In: Wink, M. (Ed.), *Biochemistry of Plant Secondary Metabolism*. CRC Press, Boca Raton, Florida, 1999, pp. 222–299.
- 61 Buckingham, J. *Dictionary of Natural Products on CD-ROM, Version 6.1*. Chapman & Hall, London, UK, 1998.
- 62 Zinkel, D.F., Russell, J. *Naval Stores: Production, Chemistry, Utilization*. Pulp Chemicals Association, New York, 1989.
- 63 Dawson, F.A. The amazing terpenes. *Naval Stores Rev.* 1994, 104, 6–12.
- 64 Gang, D.R., Wang, J.H., Dudareva, N., Nam, K.H., Simon, J.E., Lewinsohn, E., Pichersky, E. An investigation of the storage and biosynthesis of phenylpropenes in sweet basil. *Plant Physiol.* 2001, 125, 539–555.
- 65 Pichersky, E., Gershenzon, J. The formation and function of plant volatiles: perfumes for pollinator attraction and defense. *Curr. Opin. Plant Biol.* 2002, 5, 237–243.
- 66 Sharon-Asa, L., Shalit, M., Frydman, A., Bar, E., Holland, D., Or, E., Lavi, U., Lewinsohn, E., Eyal, Y. Citrus fruit flavor and aroma biosynthesis: isolation, functional characterization, and developmental regulation of *cstps1*, a key gene in the production of the sesquiterpene aroma compound valencene. *Plant J.* 2003, 36, 664–674.
- 67 Knudsen, J.T., Tollesten, L., Bergström, G.L. Floral scent: a checklist of volatile compounds isolated by head-space techniques. *Phytochemistry* 1993, 33, 252–280.
- 68 Guterman, I., Shalit, M., Menda, N., Piestun, D., Dafny-Yelin, M., Shalev, G., Bar, E., Davydov, O., Ovadis, M., Emanuel, M., Wang, J., Adam, Z., Pichersky, E., Lewinsohn, E., Zamir, D., Vainstein, A., Weiss, D. Rose scent: genomics approach to discovering novel floral fragrance-related genes. *Plant Cell* 2002, 14, 2325–2338.
- 69 Dobson, H.E.M. Floral volatiles in insect biology. In: Bernays, E. (Ed.), *Insect–Plant Interactions*. CRC Press, Boca Raton, Florida, 1994, Volume 5, pp. 47–81.
- 70 Dudareva, N., Pichersky, E. Biochemical and molecular aspects of floral scents. *Plant Physiol.* 2000, 122, 627–634.
- 71 Dudareva, N., Martin, D., Kish, C.M., Kolosova, N., Gorenstein, N., Fäldt, J., Miller, B., Bohlmann, J. (*E*)- $\beta$ -Ocimene and myrcene synthase genes of floral scent biosynthesis in snapdragon: function and expression of three terpene synthase genes of a new terpene synthase subfamily. *Plant Cell* 2003, 15, 1227–1241.
- 72 Bohlmann, J., Croteau, R. Diversity and variability of terpenoid defenses in conifers: molecular genetics, biochemistry and evolution of the terpene synthase gene family in grand fir (*Abies grandis*). In: Chadwick, D.J., Goode, J.A. (Eds.), *Insect–Plant Interactions and Induced Plant Defense*. John Wiley & Sons, West Sussex, UK, 1999, pp. 132–146.
- 73 Huber, D.P.W., Ralph, S., Bohlmann, J. Genomic hardwiring and phenotypic plasticity of terpenoid-based defenses in conifers. *J. Chem. Ecol.* 2004, 30, 2399–2418.
- 74 Crowell, P.L., Gould, M.N. Chemoprevention and therapy of cancer by *d*-limonene. *Crit. Rev. Oncog.* 1994, 5, 1–22.
- 75 Van Geldre, E., Vergauwe, A., Van den Eekchout, E. State of the art of the production of the antimalarial compound artemisinin in plants. *Plant Mol. Biol.* 1997, 33, 199–209.
- 76 Holmes, F.A., Kudelka, A.P., Kavanagh, J.J., Huber, M.H., Ajani, J.A. Current status of clinical trials with paclitaxel and docetaxel. In: Georg, G.I., Chen, T.T., Ojima, I., Vyas, D.M. (Eds.), *Taxane Anticancer Agents: Basic Science and Current Status*. American Chemical Society Symposium Series 583, Washington DC, 1995, pp. 31–57.
- 77 Jennewein, S., Croteau, R. Taxol: biosynthesis, molecular genetics, and biotechnological applications. *Appl. Microbiol. Biotechnol.* 2001, 57, 13–19.
- 78 Newman, J.D., Chappell, J. Isoprenoid biosynthesis in plants: carbon partitioning within the cytoplasmic pathway. *Crit. Rev. Biochem. Mol. Biol.* 1999, 34, 95–106.

- 79 Eisenreich, W., Schwarz, M., Cartayrade, A., Arigoni, D., Zenk, M.H., Bacher, A. The deoxyxylose phosphate pathway of terpenoid biosynthesis in plants and microorganisms. *Chem. Biol.* **1998**, *5*, R221–R233.
- 80 Lichtenthaler, H.K. The 1-deoxy-D-xylulose-5-phosphate pathway of isoprenoid biosynthesis in plants. *Annu. Rev. Plant Physiol. Plant Mol. Biol.* **1999**, *50*, 47–66.
- 81 \* Dudareva, N., Andersson, S., Orlova, I., Gatto, N., Reichelt, M., Rhodes, D., Boland, W., Gershenzon, J. The nonmevalonate pathway supports both monoterpene and sesquiterpene formation in snapdragon flowers. *Proc. Natl. Acad. Sci. USA* **2005**, *102*, 933–938. [This paper shows that only the methylerythritol phosphate (MEP or nonmevalonate) pathway, and not the mevalonate pathway, provides isopentenyl diphosphate and dimethylallyl diphosphate for the biosynthesis of volatile terpenes in snapdragon flowers.]
- 82 Rodriguez-Concepcion, M., Boronat, A. Elucidation of the methylerythritol phosphate pathway for isoprenoid biosynthesis in bacteria and plastids. A metabolic milestone achieved through genomics. *Plant Physiol.* **2002**, *130*, 1079–1089.
- 83 Lange, B.M., Ghassemian, M. Genome organization in *Arabidopsis thaliana*: a survey for genes involved in isoprenoid and chlorophyll metabolism. *Plant Mol. Biol.* **2003**, *51*, 925–948.
- 84 Facchini, P.J., Chappell, J. Gene family for an elicitor-induced sesquiterpene synthase in tobacco. *Proc. Natl. Acad. Sci. USA* **1992**, *89*, 11088–11092.
- 85 Colby, S.M., Alonso, W.R., Katahira, E.J., McGarvey, D.J., Croteau, R. 4-S-Limonene synthase from the oil glands of spearmint (*Mentha spicata*): cDNA isolation, characterization and bacterial expression of the catalytically active monoterpene cyclase. *J. Biol. Chem.* **1993**, *268*, 23016–23024.
- 86 Mau, C.J.D., West, C.A. Cloning of casbene synthase cDNA: evidence for conserved structural features among terpenoid cyclases in plants. *Proc. Natl. Acad. Sci. USA* **1994**, *91*, 8479–8501.
- 87 Back, K., Chappell, J. Cloning and bacterial expression of a sesquiterpene cyclase from *Hyoscyamus muticus* and its molecular comparison to related terpene cyclases. *J. Biol. Chem.* **1995**, *270*, 7375–7381.
- 88 Chappell, J. The biochemistry and molecular biology of isoprenoid metabolism. *Plant Physiol.* **1995**, *107*, 1–6.
- 89 Chappell, J. Biochemistry and molecular biology of the isoprenoid biosynthetic pathway in plants. *Annu. Rev. Plant Physiol. Plant Mol. Biol.* **1995**, *46*, 521–547.
- 90 Bohlmann, J., Meyer-Gauen, G., Croteau, R. Plant terpenoid synthases: molecular biology and phylogenetic analysis. *Proc. Natl. Acad. Sci. USA* **1998**, *95*, 4126–4133.
- 91 Trapp, S.C., Croteau, R.B. Genomic organization of plant terpene synthases and molecular evolutionary implications. *Genetics* **2001**, *158*, 811–832.
- 92 Aubourg, S., Lecharny, A., Bohlmann, J. Genomic analysis of the terpenoid synthase (*AtTPS*) gene family of *Arabidopsis thaliana*. *Mol. Genet. Genomics* **2002**, *267*, 730–745.
- 93 Bohlmann, J., Martin, D., Oldham, N.J., Gershenzon, J. Terpenoid secondary metabolism in *Arabidopsis thaliana*: cDNA cloning, characterization, and functional expression of a myrcene/ (*E*)- $\beta$ -ocimene synthase. *Arch. Biochem. Biophys.* **2000**, *375*, 261–269.
- 94 Van Poeke, R.M.P., Posthumus, M.A., Dicke, M. Herbivore-induced volatile production by *Arabidopsis thaliana* leads to attraction of the parasitoid *Cotesia rubecula*: chemical, behavioral and gene-expression analysis. *J. Chem. Ecol.* **2001**, *27*, 1911–1928.
- 95 \*\* Chen, F., Tholl, D., D'Auria, J.C., Farooq, A., Pichersky, E., Gershenzon, J. Biosynthesis and emission of terpenoid volatiles from *Arabidopsis* flowers. *Plant Cell* **2003**, *15*, 481–494. [This paper was one of the first to show that *Arabidopsis* flowers emit monoterpenes and sesquiterpenes as potential olfactory cues for pollinating insects.]
- 96 \* Aharoni, A., Giri, A.P., Deuerlein, S., Griepink, F., de Kogel, W.-D.,



- Verstappen, F.W.A., Verheoven, H.A., Jongma, M.A., Schwab, W., Bouwmeester, H.J. Terpenoid metabolism in wild-type and transgenic *Arabidopsis* plants. *Plant Cell* **2003**, *15*, 2866–2884. [This paper was one of the first to report the occurrence of terpenoid metabolism in *Arabidopsis*. The work demonstrates the value of *Arabidopsis* to study the biosynthesis and ecological role of terpenoids in wild-type and transgenic plants.]
- 97 D'Auria, J.C., Gershenzon, J. The secondary metabolism of *Arabidopsis thaliana*: growing like a weed. *Curr. Opin. Plant Biol.* **2005**, *8*, 308–316.
- 98 Steeghs, M., Bais, H.P., de Gouw, J., Goldan, P., Kuster, W., Northway, M., Fall, R., Vivanco, J.M. Proton-transfer-reaction mass spectrometry as a new tool for real time analysis of root-secreted volatile organic compounds in *Arabidopsis*. *Plant Physiol.* **2004**, *135*, 47–58.
- 99 Chen, F., Ro, D.-K., Petri, J., Gershenzon, J., Bohlmann, J., Pichersky, E., Tholl, D. Characterization of a root-specific *Arabidopsis* terpene synthase responsible for the formation of the volatile monoterpene 1, 8-cineole. *Plant Physiol.* **2004**, *135*, 1956–1966.
- 100 Tholl, D., Chen, F., Petri, J., Gershenzon, J., Pichersky, E. Two sesquiterpene synthases are responsible for the complex mixture of sesquiterpenes emitted from *Arabidopsis* flowers. *Plant J.* **2005**, *42*, 757–771.
- 101 Fazio, G.C., Xu, R., Matsuda, S.P. Genome mining to identify new plant triterpenoids. *J. Am. Chem. Soc.* **2004**, *126*, 5678–5679.
- 102 Herrera, J.B., Bartel, B., Wilson, W.K., Matsuda, S.P. Cloning and characterization of the *Arabidopsis thaliana* lupeol synthase gene. *Phytochemistry* **1998**, *49*, 1905–1911.
- 103 Segura, M.J., Meyer, M.M., Matsuda, S.P. *Arabidopsis thaliana* LUP1 converts oxidosqualene to multiple triterpene alcohols and a triterpene diol. *Organic Lett.* **2000**, *2*, 2257–2259.
- 104 Kushiro, T., Shibuya, M., Masuda, K., Ebizuka, Y. A novel multifunctional triterpene synthase from *Arabidopsis thaliana*. *Tetrahedron Lett.* **2000**, *41*, 7705–7710.
- 105 \* Yu, J., Hu, S., Wang, J., Wong, G.K.-S., Li, S., et al. A draft sequence of the rice genome (*Oryza sativa* L. ssp. *Indica*). *Science* **2002**, *296*, 79–92. [This paper reports the first extensive analysis of the rice genome sequence.]
- 106 McGarvey, D., Croteau, R. Terpenoid metabolism. *Plant Cell* **2005**, *7*, 1015–1026.
- 107 Xu, M., Hillwig, M.L., Pristic, S., Coates, R.M., Peters, R.J. Functional identification of rice *syn*-copalyl diphosphate synthase and its role in initiating biosynthesis of diterpenoid phytoalexin/allelopathic natural products. *Plant J.* **2004**, *39*, 309–318.
- 108 Otomo, K., Kenmoku, H., Oikawa, H., Konig, W.A., Toshima, H., Mitsuhashi, W., Yamane, H., Sassa, T., Toyomasu, T. Biological functions of *ent*- and *syn*-copalyl diphosphate synthases in rice: key enzymes for the branch point of gibberellin and phytoalexin biosynthesis. *Plant J.* **2004**, *39*, 886–893.
- 109 Pristic, S., Xu, M., Wilderman, P.R., Peters, R.J. Rice contains two disparate *ent*-copalyl diphosphate synthases with distinct metabolic functions. *Plant Physiol.* **2004**, *136*, 4228–4236.
- 110 Gai, X.W., Lal, S., Xing, L.Q., Brendel, V., Walbot, V. Gene discovery using the maize genome database ZmDB. *Nucleic Acids Res.* **2000**, *28*, 94–96.
- 111 Köllner, T.G., Schnee, C., Gershenzon, J., Degenhardt, J. The variability of sesquiterpenes emitted from two *Zea mays* cultivars is controlled by allelic variation of two terpene synthase genes encoding stereoselective multiple product enzymes. *Plant Cell* **2004**, *16*, 1115–1131.
- 112 Achnine, L., Huhman, D.V., Farag, M.A., Sumner, F.W., Blount, J.W., Dixon, R.A. Genomics-based selection and functional characterization of triterpene glycosyl-transferases from the model legume *Medicago truncatula*. *Plant J.* **2005**, *41*, 875–887.
- 113 Ro, D.-K., Arimura, G.-I., Lau, S.Y.W., Piers, E., Bohlmann, J. Loblolly pine abietadienol/abietadienal oxidase PTAO (CYP720B1) is a multifunctional, multi-



- substrate cytochrome P450 monooxygenase. *Proc. Natl. Acad. Sci. USA* **2005**, *102*, 8060–8065.
- 114** Martin, D., Fäldt, J., Bohlmann, J. Functional characterization of nine Norway spruce *TPS* genes and evolution of gymnosperm terpene synthases of the *TPS-d* subfamily. *Plant Physiol.* **2004**, *135*, 1908–1927.
- 115** \* Gershenzon, J., McCaskill, D., Rajaonarivony, J.I.M., Mihaliak, C., Karp, F., Croteau, R. Isolation of secretory cells from plant glandular trichomes and their use in biosynthetic studies of monoterpenes and other gland products. *Anal. Biochem.* **1992**, *200*, 130–138. [This paper describes an efficient method for the isolation of mint glandular trichomes, which allowed the establishment of cell type-specific cDNA libraries rich in terpenoid biosynthetic genes.]
- 116** \* Lange, B.M., Wildung, M.R., Stauber, E.J., Sanchez, C., Pouchnik, D., Croteau, R. Probing essential oil biosynthesis and secretion by functional evaluation of expressed sequence tags from mint glandular trichomes. *Proc. Natl. Acad. Sci. USA* **2000**, *97*, 2934–2939. [This paper describes the first characterization of a cell type-specific EST database from mint glandular trichomes.]
- 117** Aziz, N., Paiva, N.L., May, G.D., Dixon, R.A. Transcriptome analysis of alfalfa glandular trichomes. *Planta* **2005**, *221*, 28–38.
- 118** McCaskill, D., Gershenzon, J., Croteau, R. Morphology and monoterpene biosynthetic capabilities of secretory cell clusters isolated from glandular trichomes of peppermint *Mentha × piperita* L. *Planta* **1992**, *187*, 445–454.
- 119** Alonso, W.R., Rajaonarivony, J.I.M., Gershenzon, J., Croteau, R. Purification of 4S-limonene synthase, a monoterpene cyclase from the glandular trichomes of peppermint (*Mentha × piperita*) and spearmint (*Mentha spicata*). *J. Biol. Chem.* **1992**, *267*, 7582–7587.
- 120** Bertea, C.M., Schalk, M., Karp, F., Maffei, M., Croteau, R. Demonstration that menthofuran synthase of mint (*Mentha*) is a cytochrome P450 monooxygenase: cloning, functional expression, and characterization of the responsible gene. *Arch. Biochem. Biophys.* **2001**, *390*, 279–286.
- 121** Ringer, K.L., McConkey, M.E., Davis, E.M., Rushing, G.W., Croteau, R. Monoterpene double-bond reductases of the (–)-menthol biosynthetic pathway: isolation and characterization of cDNAs encoding (–)-isopiperitenone reductase and (+)-pulegone reductase of peppermint. *Arch. Biochem. Biophys.* **2003**, *418*, 80–92.
- 122** Ringer, K.L., Davis, E.M., Croteau, R. Monoterpene metabolism. Cloning, expression and characterization of (–)-isopiperitenol/(–)-carveol dehydrogenase of peppermint and spearmint. *Plant Physiol.* **2005**, *137*, 863–872.
- 123** Davis, E.M., Ringer, K.L., McConkey, M.E., Croteau, R. Monoterpene metabolism. Cloning, expression, and characterization of menthone reductases from peppermint. *Plant Physiol.* **2005**, *137*, 873–881.
- 124** Iijima, Y., Gang, D.R., Fridman, E., Lewinsohn, E., Pichersky, E. Characterization of geraniol synthase from the peltate glands of sweet basil. *Plant Physiol.* **2004**, *134*, 370–379.
- 125** Iijima, Y., Davidovich-Rikanati, R., Fridman, E., Gang, D.R., Bar, E., Lewinsohn, E., Pichersky, E. The biochemical and molecular basis for the divergent patterns in the biosynthesis of terpenes and phenylpropenes in the peltate glands of three cultivars of basil. *Plant Physiol.* **2004**, *136*, 3724–3736.
- 126** Lückner, J., Bowen, P., Bohlmann, J. *Vitis vinifera* terpenoid cyclases: functional identification of two sesquiterpene synthase cDNAs encoding (+)-valencene synthase and (–)-germacrene D synthase and expression of mono- and sesquiterpene synthases in grapevine flowers and berries. *Phytochemistry* **2004**, *65*, 2649–2659.
- 127** Driesel, A.J., Lommele, A., Drescher, D., Topfer, R., Bell, M., Cartharius, I., Cheutin, N., Huck, J.-F., Kubiak, J., Regnard, P., Steinmetz, A. Towards the transcriptome of grapevine (*Vitis vinifera* L.) *Acta Hort.* **2003**, *603*, 239–249.
- 128** Jung, J.D., Park, H.-W., Hahn, Y., Jur, C.-G., In, D.S., Chung, H.-J., Liu, J.R., Choi, D.-W. Discovery of genes for

- ginsenoside biosynthesis by analysis of ginseng expressed sequence tags. *Plant Cell Rep.* **2003**, *22*, 224–230.
- 129 Jennewein, S., Wildung, M.R., Chau, M., Walker, K., Croteau, R. Random sequencing of an induced *Taxus* cell cDNA library for identification of clones involved in Taxol biosynthesis. *Proc. Natl. Acad. Sci. USA* **2004**, *101*, 9149–9154.
- 130 Kingston, D.G.I., Jagtap, P.G., Yuan, H., Samala, L. The chemistry of Taxol and related taxoids. *Prog. Chem. Organic Nat. Prod.* **2002**, *84*, 53–225.
- 131 Ko, J.-H., Chow, K.-S., Han, K.-H. Transcriptome analysis reveals novel features of the molecular events occurring in the laticifers of *Hevea brasiliensis* (para rubber tree). *Plant Mol. Biol.* **2003**, *53*, 479–492.
- 132 Davis, W. The rubber industry's biological nightmare. *Fortune* **1997**, *4*, 86–95.
- 133 Dennis, M.S., Light, D.R. Rubber elongation factor from *Hevea brasiliensis*. Identification, characterization, and role in rubber biosynthesis. *J. Biol. Chem.* **1989**, *264*, 18608–18617.
- 134 Kant, M.R., Ament, K., Sabelis, M.W., Haring, M.A., Schuurink, R.C. Differential timing of spider mite-induced direct and indirect defenses in tomato plants. *Plant Physiol.* **2004**, *135*, 483–485.
- 135 Merke, P., Kappers, I.F., Verstappen, F.W.A., Vorst, O., Dicke, M., Bouwmeester, H.J. Combined transcript and metabolite analysis reveals genes involved in spider mite induced volatile formation in cucumber plants. *Plant Physiol.* **2004**, *135*, 2012–2024.
- 136 Dixon, R.A., Achnine, L., Kota, P., Liu, C.-J., Reddy, M.S.S., Wang, L. The phenylpropanoid pathway and plant defense – a genomics perspective. *Mol. Plant Pathol.* **2002**, *3*, 371–390.
- 137 Raguso, R.A., Pichersky, E. Floral volatiles from *Clarkia breweri* and *C. concinna* (Onagraceae): recent evolution of floral scent and moth pollination. *Plant System. Evol.* **1995**, *194*, 55–67.
- 138 Dudareva, N., Pichersky, E., Gershenzon, J. Biochemistry of plant volatiles. *Plant Physiol.* **2004**, *135*, 1893–1902.
- 139 Gang, D.R., Beuerle, T., Ullmann, P., Werk-Reichhart, D., Pichersky, E. Differential production of *meta* hydroxylated phenylpropanoids in sweet basil peltate glandular trichomes and leaves is controlled by the activities of specific acyltransferases and hydroxylases. *Plant Physiol.* **2002**, *130*, 1536–1544.
- 140 Wildermuth, M.C., Dewdney, J., Wu, G., Ausubel, F.M. Isochorismate synthase is required to synthesize salicylic acid for plant defence. *Nature* **2001**, *414*, 562–565.
- 141 Costa, M.A., Collins, R.E., Anterola, A.M., Cochrane, F.C., Davin, L.B., Lewis, N.G. An *in silico* assessment of gene function and organization of the phenylpropanoid pathway metabolic networks in *Arabidopsis thaliana* and limitations thereof. *Phytochemistry* **2003**, *64*, 1097–1112.
- 142 Costa, M.A., Bedgar, D.L., Moinuddin, S.G.A., Kim, K.-W., Cardenas, C.L., Cochrane, F.C., Shockey, J.M., Helms, G.L., Amakura, Y., Takahashi, H., Milhollan, J.K., Davin, L.B., Browse, J., Lewis, N.G. Characterization *in vitro* and *in vivo* of the putative multigene 4-coumarate:CoA ligase network in *Arabidopsis*: syringyl lignin and sinapate/sinapyl alcohol derivative formation. *Phytochemistry* **2005**, *66*, 2070–2091.
- 143 Hostel, W. *The Biochemistry of Plants*, Volume 7. Academic Press, New York, **1981**.
- 144 Whetten, R.W., MacKay, J.J., Sederoff, R.R. Recent advances in understanding lignin biosynthesis. *Annu. Rev. Plant Physiol. Plant Mol. Biol.* **1998**, *49*, 585–609.
- 145 Lim, E.-K., Li, Y., Parr, A., Jackson, R., Ashford, D.A., Bowles, D.J. Identification of glucosyltransferase genes involved in sinapate metabolism and lignin synthesis in *Arabidopsis*. *J. Biol. Chem.* **2001**, *276*, 4344–4349.
- 146 Jones, P., Messner, B., Nakajima, J.-I., Schäffner, A.R., Saito, K. UGT73C6 and UGT78D1, glycosyltransferases involved in flavonol glycoside biosynthesis in *Arabidopsis thaliana*. *J. Biol. Chem.* **2003**, *278*, 43910–43918.

- 147 Gachon, C.M.M., Langlois-Meurinne, M., Saindrenan, P. Plant secondary metabolism glycosyltransferases: the emerging functional analysis. *Trends Plant Sci.* **2005**, *10*, 542–549.
- 148 Kirst, M., Johnson, A.F., Baucom, C., Ulrich, E., Hubbard, K., Staggs, R., Paule, C., Retzel, E., Whetten, R., Sederoff, R. Apparent homology of expressed genes from wood-forming tissues of loblolly pine (*Pinus taeda* L.) with *Arabidopsis thaliana*. *Proc. Natl. Acad. Sci. USA* **2003**, *100*, 7383–7388.
- 149 Ehrling, J., Mattheus, N., Aischliman, D.S., Li, E., Hamberger, B., Cullis, I.F., Zhuang, J., Kaneda, M., Mansfield, S.D., Samuels, L., Ritland, K., Ellis, B.E., Bohlmann, J., Douglas, C.J. Global transcript profiling of primary stems from *Arabidopsis thaliana* identifies candidate genes for missing links in lignin biosynthesis and transcriptional regulators of fiber differentiation. *Plant J.* **2005**, *42*, 618–640.
- 150 Allona, I., Quinn, M., Shoop, E., Swope, K., St. Cyr, S., Carlis, J., Riedl, J., Retzel, E., Campbell, M.M., Sederoff, R., Whetten, R.W. Analysis of xylem formation in pine by cDNA sequencing. *Proc. Natl. Acad. Sci. USA* **1998**, *95*, 9693–9698.
- 151 Sate, Y., Wuli, B., Sederoff, R., Whetten, R. Molecular cloning and expression of eight laccase cDNAs in loblolly pine (*Pinus taeda*). *J. Plant Res.* **2001**, *114*, 147–155.
- 152 Ward, G., Hadar, Y., Bilkis, I., Konstantinovskiy, L., Dosoretz, C.G. Initial steps of ferulic acid polymerization by lignin peroxidase. *J. Biol. Chem.* **2001**, *276*, 18734–18741.
- 153 McCaig, B.C., Meagher, R.B., Dean, J.F. Gene structure and molecular analysis of the laccase-like multicopper oxidase (LMCO) gene family in *Arabidopsis thaliana*. *Planta* **2005**, *221*, 619–636.
- 154 Egerstodter, U., van Zyl, L.M., Mackay, J., Peter, G., Kirst, M., Clark, C., Whetten, R., Sederoff, R. Gene expression during formation of earlywood and latewood in loblolly pine: expression profiles of 350 genes. *Plant Biol.* **2004**, *6*, 654–663.
- 155 Kirst, M., Myburg, A.A., de León, J.P.G., Kirst, M.E., Scott, J., Sederoff, R. Coordinated genetic regulation of growth and lignin revealed by quantitative trait locus analysis of cDNA microarray data in an interspecific backcross of *Eucalyptus*. *Plant Physiol.* **2004**, *135*, 2368–2378.
- 156 Kirst, M., Basten, C.J., Myburg, A.A., Zeng, Z.-B., Sederoff, R.R. Genetic architecture of transcript-level variation in differentiating xylem of a *Eucalyptus* hybrid. *Genetics* **2005**, *169*, 2295–2303.
- 157 Stasolla, C., van Zyl, L., Egertsdotter, U., Craig, D., Liu, W., Sederoff, R.R. Transcript profiles of stress-related genes in developing white spruce (*Picea glauca*) somatic embryos cultured with polyethylene glycol. *Plant Sci.* **2003**, *165*, 719–729.
- 158 Dixon, R.A., Sumner, L.W. Legume natural products: understanding and manipulating complex pathways for human and animal health. *Plant Physiol.* **2003**, *131*, 878–885.
- 159 Udvardi, M.K., Tabata, S., Parniske, M., Stougaard, J. *Lotus japonicus*: legume research in the fast lane. *Trends Plant Sci.* **2005**, *10*, 222–228.
- 160 Koes, R., Verweij, W., Quattrocchio, F. Flavonoids: a colorful model for the regulation and evolution of biochemical pathways. *Trends Plant Sci.* **2005**, *10*, 236–242.
- 161 Dixon, R.A., Ferreira, D. Molecules of interest: genistein. *Phytochemistry* **2002**, *60*, 205–211.
- 162 Bell, C.J., Dixon, R.A., Farmer, A.D., Flores, R., Inman, J., Gonzales, R.A., Harrison, M.J., Paiva, N.L., Scott, A.D., Weller, J.W., May, G.D. The *Medicago* Genome Initiative: a model legume database. *Nucleic Acids Res.* **2001**, *29*, 114–117.
- 163 Steele, C.L., Gijzen, M., Qutob, D., Dixon, R.A. Molecular characterization of the enzyme catalyzing the aryl migration reaction of isoflavonoid biosynthesis in soybean. *Arch. Biochem. Biophys.* **1999**, *367*, 146–150.
- 164 Jung, W., Yu, O., Lau, S.-M.C., O'Keefe, D.P., Odell, J., Fader, G., McGonigle, B. Identification and expression of isoflavone synthase, the key enzyme for biosynthesis of isoflavones in legumes. *Nature Biotechnol.* **2000**, *18*, 208–212.

- 165 Oldroyd, G.E., Geurts, R. *Medicago truncatula*, going where no plant has gone before. *Trends Plant Sci.* **2001**, *6*, 552–554.
- 166 Liu, C.-J., Huhman, D., Sumner, L.W., Dixon, R.A. Regiospecific hydroxylation of isoflavones by cytochrome P450 81E enzymes from *Medicago truncatula*. *Plant J.* **2003**, *36*, 471–484.
- 167 \* Xie, D.-Y., Sharma, S.B., Paiva, N.L., Ferreira, D., Dixon, R.A. Role of anthocyanidin reductase, encoded by *BANYULS* in plant flavonoid biosynthesis. *Science* **2003**, *299*, 396–399. [This paper uses an EST approach to identify the *BANYULS* genes from *Arabidopsis* and *Medicago truncatula* that encode anthocyanidin reductase, which converts anthocyanidins to their corresponding 2, 3-*cis*-flavan-3-ols.]
- 168 Lawrence, B.M. Chemical components of labiate oils and their exploitation. In: Harley, R.M., Reynolds, T. (Eds.), *Advances in Labiate Science*. Royal Botanical Gardens, Kew, UK, **1992**, pp. 399–436.
- 169 Obeng-Ofori, D., Reichmuth, C. Bioactivity of eugenol, a major component of essential oil of *Ocimum suave* (Wild.) against four species of stored-product *Coleoptera*. *Int. J. Pest Management* **1997**, *43*, 89–94.
- 170 Adams, S., Weidenborner, M. Mycelial deformations of *Cladosporium herbarum* due to the application of eugenol or carvacrol. *J. Essential Oil Res.* **1996**, *8*, 535–540.
- 171 Manitto, P., Monti, D., Gramatica, P. Biosynthesis of phenylpropanoid compounds. I. Biosynthesis of eugenol in *Ocimum basilicum* L. *J. Chem. Soc. Perkin Trans. I* **1974**, *14*, 1727–1731.
- 172 Manitto, P., Gramatica, P., Monti, D. Biosynthesis of phenylpropanoid compounds. II. Incorporation of specifically labeled cinnamic acids into eugenol in basil (*Ocimum basilicum*). *J. Chem. Soc. Perkin Trans. I* **1975**, *16*, 1549–1551.
- 173 Klischies, M., Stockigt, J., Zenk, M.H. Biosynthesis of the allylphenols eugenol and methyleugenol in *Ocimum basilicum* L. *Chem Commun.* **1975**, *21*, 879–880.
- 174 Senanayake, U.M., Wills, R.H.B., Lee, T.H. Biosynthesis of eugenol and cinnamic aldehyde in *Cinnamomum zeylanicum*. *Phytochemistry* **1977**, *16*, 2032–2033.
- 175 Gang, D.R., Lavid, N., Zubieta, C., Chen, F., Beuelre, T., Lewinsohn, E., Noel, J.P., Pichersky, E. Characterization of phenylpropene O-methyltransferases from sweet basil: facile change of substrate specificity and convergent evolution within a plant O-methyltransferase family. *Plant Cell* **2002**, *14*, 505–519.
- 176 Facchini, P.J. Alkaloid biosynthesis in plants: biochemistry, cell biology, molecular regulation, and metabolic engineering applications. *Annu. Rev. Plant Physiol. Plant Mol. Biol.* **2001**, *52*, 29–66.
- 177 De Luca, V., Laflamme, P. The expanding universe of alkaloid biosynthesis. *Curr. Opin. Plant Biol.* **2001**, *4*, 225–233.
- 178 Hashimoto, T., Yamada, Y. New genes in alkaloid metabolism and transport. *Curr. Opin. Biotechnol.* **2003**, *14*, 163–168.
- 179 Morishige, T., Dubouzet, E., Choi, K.-B., Yazaki, K., Sato, F. Molecular cloning of columbamine O-methyltransferase from cultured *Coptis japonica* cells. *Eur. J. Biochem.* **2002**, *269*, 5659–5667.
- 180 Ziegler, J., Diaz-Chávez, M.L., Kramell, R., Ammer, C., Kutchan, T.M. Comparative macroarray analysis of morphine containing *Papaver somniferum* and eight morphine free *Papaver* species identifies an O-methyltransferase involved in benzyloisoquinoline biosynthesis. *Planta* **2006**, *222*, 458–471.
- 181 Liscombe, D.K., MacLeod, B.P., Loukanina, N., Nandi, O.I., Facchini, P.J. Evidence for the monophyletic evolution of benzyloisoquinoline alkaloid biosynthesis in angiosperms. *Phytochemistry* **2005**, *66*, 1374–1393.
- 182 Pilatzke-Wunderlich, I., Nessler, C.L. Expression and activity of cell-wall-degrading enzymes in the latex of opium poppy, *Papaver somniferum* L. *Plant Mol. Biol.* **2001**, *45*, 567–576.
- 183 Fahn, A. *Plant Anatomy*, 4th edition. Pergamon Press, Oxford, UK, **1990**.

- 184 Siminszky, B., Gavilano, L., Bowen, S.W., Dewey, R.E. Conversion of nicotine to nornicotine in *Nicotiana tabacum* is mediated by CYP82E4, a cytochrome P450 monooxygenase. *Proc. Natl. Acad. Sci. USA* **2005**, *102*, 14919–14924.
- 185 \*\* The *Arabidopsis* Genome Initiative. Analysis of the genome sequence of the flowering plant *Arabidopsis thaliana*. *Nature* **2000**, *408*, 796–815. [This paper describes the annotation and analysis of the first complete plant genome sequence from *Arabidopsis*.]
- 186 Devoto, A., Ellis, C., Magusin, A., Chang, H.-S., Chilcott, C., Zhu, T., Turner, J.G. Expression profiling reveals *CO11* to be a key regulator of genes involved in wound- and methyl jasmonate-induced secondary metabolism, defense, and hormone interactions. *Plant Mol. Biol.* **2005**, *58*, 497–513.
- 187 Cheong, Y.H., Chang, H.S., Gupta, R., Wang, X., Zhu, T., Luan, S. Transcriptional profiling reveals novel interactions between wounding, pathogen, abiotic stress, and hormonal responses in *Arabidopsis*. *Plant Physiol.* **2002**, *129*, 661–677.
- 188 Li, L., He, Z., Pandey, G.K., Tsuchiya, T., Luan, S. Functional cloning and characterization of a plant efflux carrier for multidrug and heavy metal detoxification. *J. Biol. Chem.* **2002**, *277*, 5360–5368.
- 189 Tsuji, J., Jackson, E.P., Gage, D.A., Hammerschmidt, R., Somerville, S.C. Phytoalexin accumulation in *Arabidopsis thaliana* during the hypersensitive reaction to *Pseudomonas syringae* pv *syringae*. *Plant Physiol.* **1992**, *129*, 1304–1309.
- 190 Carter, C.J., Thornburg, R.W. Tobacco nectarin V is a flavin-containing berberine bridge enzyme-like protein with glucose oxidase activity. *Plant Physiol.* **2004**, *134*, 460–469.
- 191 Kutchan, T.M., Ditttrich, H. Characterization and mechanism of the berberine bridge enzyme, a covalently flavinylated oxidase of benzophenanthridine alkaloid biosynthesis in higher plants. *J. Biol. Chem.* **1995**, *270*, 24475–24481.
- 192 Fabbri, M., Delp, G., Schmidt, O., Theopold, U. Animal and plant members of a gene family with similarity to alkaloid-synthesizing enzymes. *Biochem. Biophys. Res. Commun.* **2000**, *271*, 191–196.
- 193 Theopold, U., Samakovlis, C., Erdjument-Bromage, H., Dillon, N., Axelsson, B., Schmidt, O., Tempst, P., Hultmark, D. *Helix pomatia* lectin, an inducer of *Drosophila* immune response binds to hemomucin, a novel surface mucin. *J. Biol. Chem.* **1996**, *271*, 12708–12715.
- 194 Theopold, U., Li, D., Fabbri, M., Scherfer, C., Schmidt, O. The coagulation of insect hemolymph. *Cell. Mol. Life Sci.* **2002**, *59*, 363–372.
- 195 Theopold, U., Schmidt, O. *Helix pomatia* lectin and annexin V, two molecular probes for insect microparticles: possible involvement in hemolymph coagulation. *J. Insect Physiol.* **1997**, *43*, 667–674.
- 196 Morita, Y., Kodama, K., Shiota, S., Mine, T., Kataoka, A., Mizushima, T., Tsuchiya, T. NorM, a putative, multidrug efflux protein of *Vibrio parahaemolyticus* and its homologue in *Escherichia coli*. *Antimicrob. Agents Chemother.* **1998**, *42*, 1778–1782.
- 197 Shitan, N., Bazin, I., Dan, K., Obata, K., Kigawa, K., Ueda, K., Sato, F., Forestier, C., Yazaki, K. Involvement of CjMDR1, a plant multidrug-resistant-type ATP-binding cassette protein, in alkaloid transport in *Coptis japonica*. *Proc. Natl. Acad. Sci. USA* **2003**, *100*, 751–756.
- 198 Gould, S.J., Vrba, E.S. Exaptation: a missing term in the science of form. *Paleobiology* **1982**, *8*, 4–15.

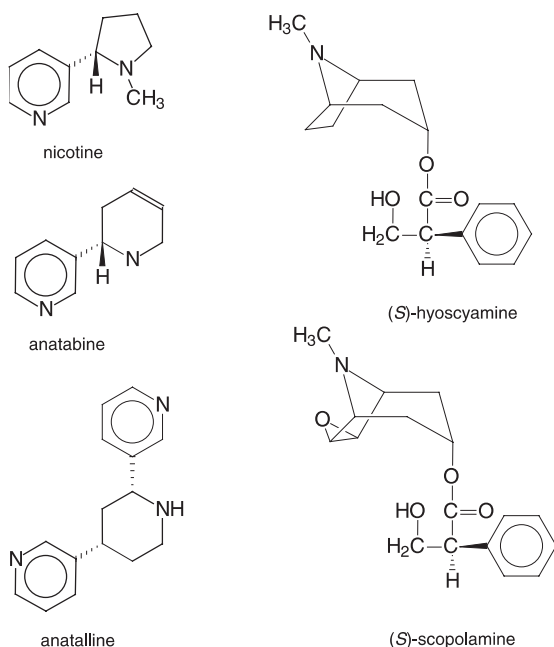
## 11

## Biotechnology of Solanaceae Alkaloids: A Model or an Industrial Perspective?

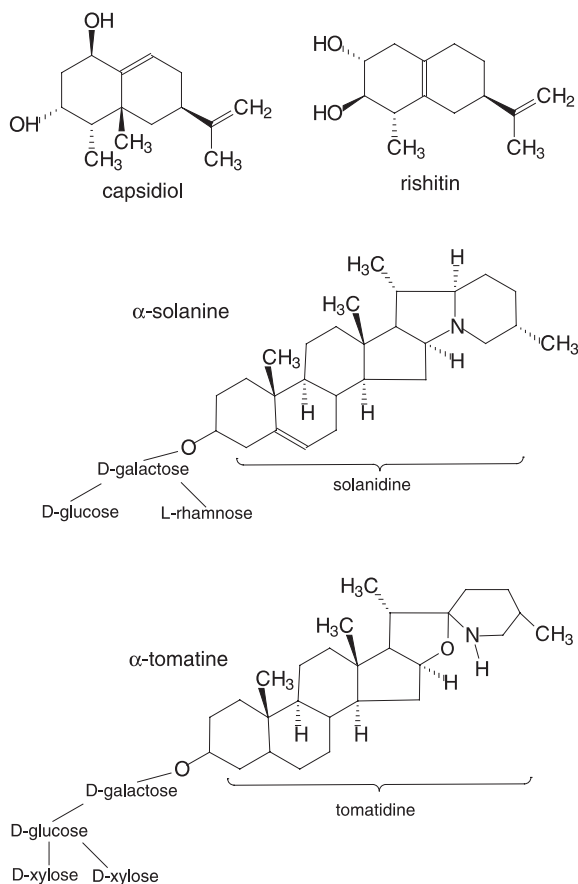
Birgit Dräger

This chapter focuses on the plant family Solanaceae which, as parent plants for cell and tissue cultures, are noteworthy for three main reasons:

1. Solanaceae produce several alkaloids of medical and biotechnological importance, namely the tropane alkaloids hyoscyamine and scopolamine, steroid alkaloids, and nicotine (Figs. 11.1 and 11.2). Among these alkaloids, scopolamine is medicinally the most important, with consumption several-fold higher than that of hyoscyamine [1], mainly because it is used as the starting material for the semi-synthesis of several important drugs. Both, scopolamine and the structurally related hyoscyamine possess strong parasympatholytic activity, blocking the



**Fig. 11.1** Typical Solanaceae alkaloids.



**Fig. 11.2** Sesquiterpenoid and glycoalkaloid phytoalexins from Solanaceae.

parasympathicus action by binding to the muscarinic acetylcholine receptors in synapses, without exerting any intrinsic activity.

2. Many other Solanaceae are important crop plants grown worldwide (e.g., potato and tomato). Regulatory mechanisms concerning growth and biomass accumulation are of major interest.
3. Solanaceae tissue cultures often grow vigorously and regenerate more easily than do those of many other medicinal plants. Almost all tissue culture systems known for plants have been realized, and some have been developed, with Solanaceae; these include root cultures, shoot cultures, and de-differentiated cells as callus or cell suspension cultures.

## 11.1

### Culture Systems

#### 11.1.1

##### The Early Days of Solanaceae Culture

Solanaceae root cultures as experimental systems for the study of alkaloid metabolism were first prepared more than 50 years ago, initially by cutting roots from aseptically grown *Datura ferox* seedlings, followed by cultivation in liquid nutrient medium [2]. Root cultures of *Datura metel* also formed tropane alkaloids and were used to investigate the biosynthesis of the tropane ring structure [2–5]. Comparable root cultures of *Nicotiana* species in White's nutrient medium [6] produced nicotine; they showed differential preferences for nitrogen and carbon sources in the nutrient medium for optimal growth and proliferation [7]. Solanaceae root cultures could also be started from dedifferentiated cell suspensions of *Hyoscyamus niger* by transfer of single cells or small cell aggregates to Linsmaier–Skoog's medium [8] devoid of auxin and with no or low concentrations of cytokinin (e.g.,  $10^{-8}$  M benzyladenine) [9]. Root cultures from *Duboisia* species were obtained by cultivation of spontaneously formed root primordia on callus in liquid medium with  $10^{-5}$  M indolebutyric acid as auxin supply [10]. Root cultures of *Hyoscyamus* species were started by the excision of roots from sterile seedlings proliferated even in the absence of phytohormones, and formed more than 1% dry mass (dm) tropane alkaloids [11]. Similarly, roots excised from sterile *Datura stramonium* seedlings showed doubling times of 6 to 19 days, and produced hyoscyamine (0.2–0.6% dm) and scopolamine (0.1–0.3% dm) [12].

In contrast, alkaloid formation by cell suspension cultures of Solanaceae is poor, with *H. niger* cell suspensions showing only traces of alkaloids [9,13,14]. Likewise, neither callus cultures of *D. stramonium* [15], *Duboisia leichhardtii* [16] nor several callus cultures of *Hyoscyamus* species [11] showed any accumulation of tropane alkaloids. Calcium alginate immobilization of *Datura innoxia* cells increased alkaloid production tenfold, but the final yield remained low (20  $\mu\text{g g}^{-1}$  dm hyoscyamine and 8  $\mu\text{g g}^{-1}$  dm scopolamine) [17]. Cell cultures of *Hyoscyamus muticus* produced only trace amounts of alkaloids, but were used for the selection of metabolic variants. Cells resistant to the amino acid analogue *p*-fluorophenylalanine accumulated high levels of cinnamoylputrescine. Root cultures regenerated from these cells produced more hyoscyamine than control root cultures [18]. Early grafting experiments [19,20] and an analysis of xylem sap [21] from Solanaceae had revealed that nicotine and tropane alkaloids are formed in the roots and transported into the aerial parts of the plants. A comparison of cultured roots with callus cultures of *H. muticus* after application of MeJas, an elicitor of alkaloid formation (see Section 11.2.2.4), showed that early enzymes of tropane alkaloid formation were induced only in the roots, and not in the callus [22]. This result confirmed the restriction of alkaloid formation to roots and, in addition, claimed that differentiated root tissue



is a prerequisite for alkaloid accumulation of more than trace quantities. The transition from root cultures to de-differentiated cell suspension was induced by transfer to medium containing auxin ( $9 \times 10^{-7}$  M 2,4-dichlorophenoxyacetic acid) and cytokinin ( $4 \times 10^{-7}$  M 6-benzylaminopurine) [23], and was followed in *Datura stramonium* by using NMR after  $^{15}\text{N}$ -nitrate and  $^{15}\text{N}$ -ammonium application. A decrease in alkaloid production during de-differentiation was accompanied by an increase in production of the primary metabolites putrescine and  $\gamma$ -aminobutyric acid [24].

#### 11.1.2

##### **Hairy Roots**

An important step towards exploitation of cultured Solanaceae roots for both, alkaloid production and study of biosynthesis and metabolism was the introduction of “hairy roots” generated by transformation with *Agrobacterium rhizogenes* [25–27]. Roots of tropane alkaloid-producing species were shown to grow rapidly in simple mineral nutrient media such as Gamborgs B5 [28] and, as with most other *Agrobacterium rhizogenes*-transformed root cultures, growth was independent of exogenous phytohormone addition. These roots produced high levels of alkaloids [29–32], for example 0.3% dm alkaloids for *D. stramonium* roots [29] (Table 11.1). When root cultures were induced by different *Agrobacterium* strains, substantial variation in alkaloid formation and growth characteristics as well as somaclonal variation occurred repeatedly [33–35]. The *rol* ABC genes of the Ri plasmid of *A. rhizogenes* were sufficient to sustain strong growth and high alkaloid production ( $8 \text{ mg g}^{-1} \text{ dm}$ ), with scopolamine concentrations rising to 2.5-fold those of hyoscyamine [36]. Once established, root cultures have proven to be more stable in metabolism during repeated subcultures than comparable cell suspension cultures [37]. The frequency of chromosome alterations was low in root cultures of *D. stramonium*. Karyotypes of roots transformed with *A. rhizogenes* were even more stable than those cultured after excision from seedlings [38]. Root cultures of many other medicinal plants obtained by transformation with *A. rhizogenes* were examined as potential sources of high-value pharmaceuticals (for a summary, see [39]). For practical purposes, long-term storage of tissue cultures is advantageous and proved possible for *H. niger*, where root cultures successfully cryopreserved using a vitrification method were subsequently found to have a high regeneration rate of 93.3% [40].

Shoots emerge spontaneously from root cultures, whether transformed by *A. rhizogenes* or cut from sterile seedlings, thus proving the regeneration potency of Solanaceae cultured tissues [55]. Potato plants obtained from shoot-forming root cultures after *A. rhizogenes* transformation displayed typical phenotypic alterations such as wrinkled leaves and abundant root growth, with reduced geotropism. These alterations are attributed to the *rol* genes of the *A. rhizogenes* plasmid that is transferred to the plant tissue during transformation [56], causing alterations in phytohormones and polyamine metabolism in the plant tissues [57,58]. *H. muticus* root cultures obtained by transformation with *A. rhizogenes*-regenerated plants that

Table 11.1 Hyoscyamine and scopolamine accumulation in cell and tissue cultures.

Species	Hyoscyamine		Scopolamine		Details	Ref.
	[% dm]	[mg L <sup>-1</sup> ]	[% dm]	[mg L <sup>-1</sup> ]		
Callus and cell suspensions						
<i>Atropa belladonna</i> cell suspension	Trace amounts	–	Trace amounts	–	Shake flasks	41
<i>Datura stramonium</i> callus	Not detected	–	Not detected	–	Shake flasks	42
<i>Datura innoxia</i> cell suspension	0.00025	–	0.00025	–	Addition of Ca <sup>2+</sup> and alginate	17
<i>D. innoxia</i> cell suspension	0.0025	–	0.001	–		17
<i>Duboisia leichhardtii</i> callus	Not detected	–	Not detected	–		16
<i>Hyoscyamus niger</i> cell suspension	0.015	0.84	0.001	0.067	Shake flasks	14
<i>H. niger</i> callus	0.01	0.694	0.002	0.227		14
<i>H. niger</i> cell suspension	0.045	5.6	–	–	Shake flasks	13
<i>H. niger</i> callus	0.03	–	0.004	–		13
<i>H. niger</i> cell suspension	0.019	–	0.003	–	Shake flasks	43
Root cultures						
<i>A. belladonna</i>	0.37	–	0.024	–	Transformed with <i>A. rhizogenes</i>	32
<i>A. belladonna</i>	0.14	–	0.013	–	Excised roots from seedlings	41
<i>A. belladonna</i>	0.95	–	0.09	–	Transformed with <i>A. rhizogenes</i>	31
<i>A. belladonna</i>	0.3	40.3	Traces	–	Transformed with <i>A. rhizogenes</i>	44
<i>A. belladonna</i>	0.23	–	0.57	–	Transformed with <i>A. rhizogenes rol genes</i>	36
<i>Datura candida</i> hybrid	0.11	–	0.57	–	Transformed with <i>A. rhizogenes</i>	45
<i>Datura quercifolia</i>	1.24	–	–	–	Transformed with <i>A. rhizogenes</i>	46
<i>Datura stramonium</i>	0.3	–	Traces	–	Transformed with <i>A. rhizogenes</i>	29
<i>D. stramonium</i>	0.62	6.2	0.33	3.5	Excised roots from seedlings	12
<i>D. stramonium</i>	0.45	6.2	–	–	Transformed with <i>A. rhizogenes</i>	47
<i>D. stramonium</i>	–	–	0.56	–	Transformed with <i>A. rhizogenes</i>	48
<i>Duboisia leichhardtii</i>	0.53	24.8	1.16	35.7	Root formation on callus	10
<i>D. leichhardtii</i>	–	–	1.8	78.0	Transformed with <i>A. rhizogenes</i> , selected for high scopolamine production	49
<i>Duboisia myoporoides</i> × <i>D. leichhardtii</i>	0.36	9.7	1.3	62.4	Transformed with <i>A. rhizogenes</i>	50
<i>D. myoporoides</i>	–	–	3.2	70.4	Transformed with <i>A. rhizogenes</i> , selected for high scopolamine production	51
<i>Hyoscyamus albus</i>	1.1	–	0.2	–	Excised roots from seedlings	11
<i>Hyoscyamus muticus</i>	1.1	180	0.1	17	Transformed with <i>A. rhizogenes</i> overexpressing H6H	52
<i>H. niger</i>	0.01	1.1	0.15	6.6	Root formation on callus	9
<i>H. niger</i>	0.2	20	4	411	Root culture overexpressing PMT and H6H	53
<i>Scopolia japonica</i>	1.3	–	0.5	–	Transformed with <i>A. rhizogenes</i> , selected for high alkaloid production	54

accumulated tropane alkaloids in the same concentration range as the non-regenerated, non-transformed plants [59]. Similarly, root cultures of a *Duboisia* hybrid with a high scopolamine content formed shoots spontaneously. The regenerated plants showed various degrees of *Agrobacterium rol* gene effects [60] and a wide range of alkaloid content [50]. Concordant with the concept of alkaloid formation bound to root tissue, isolated shoot cultures of *Duboisia myoporoides* were poor in tropane alkaloids [61,62]. The rapid shoot-forming capacity of non-transformed Solanaceae callus and root cultures is useful for the micropropagation of rare or endangered species of Solanaceae [63], and also for the *in-vitro* multiplication of cultivars with desired horticultural traits [64,65].

### 11.1.3

#### Further Culture Systems

Many diverse cell culture concepts such as photoautotrophic cell cultures were first realized with Solanaceae (e.g., for tomato and tobacco [66]), and consequently the metabolism of secondary products – and alkaloids in particular – was investigated. Tomato cell culture lines after elicitation with *Fusarium oxysporum* f. sp. *lycopersici* increased the incorporation of phenolics into the cell walls, though phytoalexins such as rishitin and capsidiol or the glycoalkaloid tomatine were not increased in photoautotrophic, photomixotrophic, or heterotrophic cell lines [67]. Tobacco cells, in contrast, accumulated the alkaloid nicotine in large quantities in heterotrophic cultures and in moderate concentrations in photomixotrophic cultures, but not under photoautotrophic conditions (Table 11.2). Treatment with a fungal elicitor from *Phytophthora megasperma* f. sp. *glycinea* led to an accumulation of the phytoalexin capsidiol in heterotrophic and photomixotrophic tobacco cells, whereas photoautotrophic cultures formed only low levels. Nicotine levels were not affected by elicitation with a fungal elicitor [68].

Glycoalkaloids such as solanine or tomatine, besides tropane alkaloids and nicotine, form another interesting group of Solanaceae alkaloids, because they may

**Table 11.2** Tobacco alkaloid production in cell suspensions and root cultures.

<i>Species</i>	<i>Alkaloid</i>	% dm	mg L <sup>-1</sup>	<i>Details</i>	<i>Ref.</i>
Cell suspension					
<i>N. tabacum</i>	Nicotine	0.032	14.4	Heterotrophic cell suspension	68
<i>N. tabacum</i>	Nicotine	0.003	0.64	Photoautotrophic cell suspension	68
<i>N. tabacum</i> cv. By-2	Anatalline	0.054	–	Cell suspension, MeJas-induced	69
	Anatabine	0.48	–	Cell suspension, MeJas-induced	69
Root culture					
<i>N. tabacum</i>	Nicotine	1.0	–	Transformed with <i>A. rhizogenes</i>	70
<i>N. tabacum</i>	Nicotine	1.1	–	Transformed with <i>rol</i> genes of <i>A. rhizogenes</i>	71

serve as a potential alternative to diosgenin as source material for commercial steroid drug synthesis (e.g., progesterone and cortisone). Glycoalkaloids occur mainly in the genus *Solanum* and in the closely related *Lycopersicon*, which recently has been grouped into *Solanum* [72]. Most glycoalkaloid terpenoid skeletons possess similar steroid structures (Fig. 11.2) and may readily be converted to 16-dehydro-pregnenolone acetate, a key intermediate in the synthesis of steroid drugs. Glycoalkaloids are found predominantly in Solanaceae shoots and leaves; in fact, they are formed *de novo* upon the greening of tissues. A prominent example is the greening of potato tubers in daylight, with concomitant accumulation of bitter and toxic glycoalkaloids. Among dark-grown Solanaceae cell culture systems, root cultures of *Solanum aviculare* proved superior to cell suspensions and callus cultures for glycoalkaloid accumulation, and showed growth-dependent alkaloid accumulation. The maximal alkaloid content was 0.6% dm in roots grown in Murashige Skoog mineral salt mixture [73] with 8% sucrose in the medium [74]. Hairy root cultures of *Solanum mauritianum* grew rapidly but contained only 0.013% dm solasodine [75]. Although the optimization of media composition provided better production, higher levels of solasodine were toxic towards the productive root cells. Exogenous solasodine added to the medium inhibited growth, with steroidal alkaloid production declining to negative values when  $>10 \text{ mg L}^{-1}$  solasodine was added, indicating that the cells degraded or converted solasodine when present in high concentrations. *In-situ* removal of the alkaloid was recommended for solasodine-producing cell cultures systems [76]. Attempts were made to create immobilization systems; for example, *Solanum xanthocarpum* cells were immobilized in calcium alginate gel beads, but the solasodine content was only ca. twofold that in free cells, and maximal in cells from stationary phase cultures. After elicitation of cells of *Solanum eleagnifolium* (using a fungal elicitor obtained from *Alternaria* species), solasodine production was increased from 0.9 to 1.5  $\text{mg g}^{-1}$  dm in suspension cultures, and from 0.75 to 1.4  $\text{mg g}^{-1}$  dm in immobilized cells [77]. However, these contents were insufficient for economic production by cell cultures. Green shoot cultures of *Solanum dulcamara* were obtained by transformation with *Agrobacterium tumefaciens* and examined following the observation of glycoalkaloid accumulation, predominantly in green photosynthetic tissues. Different glycosylation patterns on the steroid alkaloid basic molecule were stated in *in-vitro* tissues, which would basically not limit the use of steroid structures. The total glycoalkaloid content was only ca. 0.8%  $\text{g}^{-1}$  dm shoot tissue [78], but the growth rate of the *in-vitro* shoots was sufficiently rapid to be economically competitive.

In summary, Solanaceae are amenable to many tissue culture systems, with properties of good growth and easy handling. Secondary compounds – and alkaloids in particular – are found in most of these cultures, in variable concentrations. Following the optimization of culture conditions or their precursors, the exploitation of bioactive compounds for industrial production appears possible.

## 11.2

### Alkaloid Production

#### 11.2.1

##### Choice of the Best Culture System

Tropane alkaloid-producing Solanaceae were among the first cell and tissue cultures to be examined for the feasibility of economic production of alkaloids in fermenters. Tropane alkaloid concentrations in cell suspension or callus cultures were low and, as a first attempt, high-producing cells were selected repeatedly in order to exploit genetic variation among individual cell clones. Despite this, high-producing and stable cell lines were not obtained [14]. Tropane alkaloid contents in cell suspension cultures did not rise considerably by medium nutrient variation or by elicitation, with the highest hyoscyamine content being only 0.045% in *H. niger* suspension cultures (Table 11.1) [13].

Root cultures were evaluated for alkaloid productivity, and both, roots cultured with growth-promoting phytohormones and those obtained after *A. rhizogenes* transformation proved more promising. Large variations are evident when comparing root cultures of different origin for alkaloid productivity (e.g., see Table 11.1). The method of root culture initiation, for example by excision from seedlings or by transformation with *A. rhizogenes*, appears not to be decisive for alkaloid production. Two factors, however, were repeatedly described as influential:

- Rapid growth and biomass accumulation of cultured root is contrary to high alkaloid accumulation *per* biomass. *Hyoscyamus* root cultures, for example, grew faster with more auxin in the nutrient medium, but alkaloid biosynthesis decreased [11]. *Duboisia myoporoides* root cultures selected for high alkaloid production revealed those lines as highest producers that showed comparatively slow growth [51].
- The parent plant has a major influence on the alkaloid productivity of the root strain. Root cultures of *Duboisia* species repeatedly proved to be those with the highest total alkaloid contents. In particular, they produce large amounts of scopolamine, which is of high market value. This is in concordance with *Duboisia* hybrid plants also being the solanaceous species with high alkaloid contents (3–7% tropane alkaloids of dry leaf mass). The major fraction in most *Duboisia* plants is scopolamine [79,80].

#### 11.2.2

##### Optimization Strategies

Consequently, yield optimization strategies were performed not only with *Duboisia* root cultures but also with other species such as *Datura* sp. or *Atropa belladonna*. The approaches were the same as routinely chosen for cell suspension cultures, and mainly included:

- optimization of light, gas and culture vessels;
- feeding of alkaloid precursors;
- nutrient medium variation; and
- elicitation

The following sections provide examples of the success of these optimization methods.

#### 11.2.2.1 Large-Scale Culture, Light, and Aeration

Roots of *D. stramonium* were successfully cultivated in a modified 14-L-stirred-tank reactor. Both, batch or and continuous fermentation modes were performed, and productivity was optimized by variation of incubation temperature and nutrient supply. Nutrient consumption was dependent on the plant species and on growth rates [81]. The highest production rate of 8.2 mg L<sup>-1</sup>·day hyoscyamine was obtained with half-strength B5 medium and for roots growth at 30°C [82]. Alkaloid release into the culture medium was temperature-dependent [83]. Using an airlift bioreactor (4 L) with an additional vertical mesh inserted to increase root anchorage, treatment with Tween 20 encouraged both growth and alkaloid productivity of cultured roots of *Datura metel*. Scopolamine was produced at 0.84 mg L<sup>-1</sup>·day, and 70% was excreted. The scopolamine released into the culture medium was separated with an Amberlite XAD-2 column located in the media exit [84]. Transformed root cultures of *Atropa belladonna* were cultivated in 3-L and 30-L modified stirred bioreactors. After one month, 1.5 g tropane alkaloids were produced by the 30-L reactor, comprising 5.4 mg atropine, 0.9 mg scopolamine, 1.6 mg 6-OH-hyoscyamine, and 2.0 mg littorine g<sup>-1</sup> dm, respectively [85]. A hairy root clone of *Duboisia leichhardtii* was cultured in a bioreactor connected to an Amberlite XAD-2 column for entrapment of scopolamine. Nutrient medium was continuously exchanged. After 11 weeks, 0.5 g L<sup>-1</sup> scopolamine was obtained in the XAD-2 column. Polyurethane foam or stainless-steel mesh to support the hairy roots in the bioreactor increased scopolamine recovery. In a two-stage culture (initially in medium optimized for hairy root growth and subsequently in medium for scopolamine release), 1.3 g L<sup>-1</sup> scopolamine was recovered during 11 weeks of culture [86]. Similar extractive fermentation techniques were examined for the production of other of plant alkaloids [87].

The illumination of root cultures of *D. stramonium*, *Hyoscyamus albus*, and *A. belladonna* had variable effects. Within four weeks of light exposure, *A. belladonna* roots turned green, and chlorophyll-containing plastids became visible microscopically. The roots retained their typical anatomy, but alkaloid production decreased [88]. Root cultures of *H. albus* after illumination showed slightly higher concentrations of alkaloids, and in particular scopolamine was increased [89]. Root cultures of *Datura innoxia* developed photosynthetically active chloroplasts under illumination and, in addition, produced significantly more tropane alkaloids (1.2% dm in heterotrophic roots; 2.9% dm in phototrophic roots) than control root cultures in the dark [90].

Enhanced oxygen gas supplementation in root cultures of *D. myoporoides* shifted the alkaloid pattern in favor of more scopolamine production [91]. For *A. belladonna* roots, the specific growth rates, biomass yields and atropine levels were maximum at around 150% air saturation, demonstrating that roots cultivated in reactors with air sparging are oxygen-limited [92]. By better oxygen saturation, root growth to high density became possible and yielded more than 1 g L<sup>-1</sup> scopolamine within three weeks of culture [93]. Various culture vessels and fermentation strategies have been designed and successfully applied for plant cell cultures, though most of them are not applicable to cultured roots [94]. *A. belladonna* roots were successfully cultivated in airlift reactors, but their alkaloid productivity was lower compared with shake flasks [95].

#### 11.2.2.2 Feeding of Alkaloid Precursors

Precursors of hyoscyamine and scopolamine biosynthesis (Fig. 11.3) were added to the nutrient medium in order to overcome bottlenecks in metabolism and to enhance alkaloid accumulation. The results, however, were not overwhelming. Alkaloid accumulation was seen as variable, when *N*-methylputrescine, tropine, phenylalanine, and tropic acid were applied to root cultures of *H. niger* [13]. In roots of *D. innoxia*, addition of various precursors alone was ineffective in stimulating hyoscyamine production. A short treatment with Tween 20 combined with phenylalanine or phenyllactic acid application increased the level of hyoscyamine by 40–60% [96]. Polyamine feeding (e.g., with putrescine and spermidine) showed limited success for scopolamine content in *D. myoporoides* roots. The putrescine analogues diaminomethane, diaminoethane, diaminopropane, and cadaverine increased the scopolamine from 0.56% to 0.86%, 0.90%, 1.06%, and 1.04%, respectively [97]. The results should be interpreted rather as an unspecific elicitation effect (see Section 11.2.2.4) than as a specific precursor result. Diaminopropane and cadaverine are not precursors of the tropane ring system; rather, they inhibit the first specific enzyme of the pathway, putrescine *N*-methyltransferase (PMT) *in vitro* (see Section 11.3.2). The influences of precursors of the tropic acid moiety and the tropane bicyclic ring of hyoscyamine were tested separately in *D. stramonium* root cultures. Feeding precursors for the tropic acid moiety either had no influence or had a detrimental effect on hyoscyamine accumulation. Feeding putrescine, agmatine or tropine did not enhance alkaloid accumulation, but rather resulted in a lowering of hyoscyamine levels [98]. Tropinone application doubled hyoscyamine formation in root cultures of *D. stramonium*, but the absolute hyoscyamine level was rather low (0.3% dm) in these roots [99].

#### 11.2.2.3 Nutrient Medium Variation

As fast growth and alkaloid production had repeatedly been observed as oppositional, a two-stage culture method, in which the first stage promotes lateral root induction and the second stage enhances root elongation, was developed for non-transformed root cultures of *D. myoporoides*. In the first culture stage (7 days), roots

were cultivated in Nitsch and Nitsch medium supplemented with 3% sucrose and 10  $\mu\text{M}$  indolebutyric acid as synthetic auxin. In the second stage (14 days), roots received 5% sucrose in Nitsch and Nitsch medium and no auxin. Production of scopolamine reached 2.5  $\text{g L}^{-1}$ , when this two-stage culture was combined with a high-density culture method [100]. A similar increase in alkaloids after increased sucrose supply was reported for root cultures of *Datura stramonium*, *Datura quercifolia*, *Atropa baetica*, and *A. belladonna*. When sucrose in *D. stramonium* root culture medium (Gamborg's B5 [28]) was varied systematically from 1% to 6%, the total alkaloid content rose tenfold [101]. In root cultures of *D. quercifolia* accordingly, 5% sucrose in B5 medium was found optimal for hyoscyamine production (1.24% dm) [46]. Root cultures of *D. myoporoides* and *D. leichhardtii* grew optimally in MS medium with 7–10% sucrose, and showed best tropane alkaloid production under these conditions [102]. In other root cultures, an increase of sucrose alone was not as efficient as concomitant variation of carbohydrate and mineral supply in the medium. Root cultures of *A. baetica* in half-strength Gamborg's B5-medium with the usual 3% sucrose grew slower than in full-strength medium, but contained ca. 50% more hyoscyamine and threefold more scopolamine [103]. For *A. belladonna* roots, a decrease in mineral supply (half-strength Gamborg's B5) was combined with enhanced sucrose supply (5%) and increased both, hyoscyamine and calystegines, which are nortropane alkaloids derived from the tropane alkaloid pathway (Fig. 11.3) [44]. A detailed study of the sugar effect revealed contrasting results for several monosaccharides, for example, mannose, glucose, fructose, and sorbitol on growth and alkaloid formation. It was concluded that carbohydrates not only serve as carbon sources but also show differential effects as signal compounds [44, 88]. The correlation of high carbohydrate and high alkaloids, however, may not be generalized. Root cultures of a hybrid of *Datura candida*  $\times$  *D. aurea* in half-strength Gamborg's B5 medium supplemented with 5% sucrose were the best for root growth, whereas full-strength B5 medium was optimal for hyoscyamine (0.36% dm) and scopolamine (0.17% dm) accumulation [104].

#### 11.2.2.4 Elicitation

The reaction of plant cells to stress of various nature by enhanced formation of secondary product is termed "elicitation". Elicitors are thus chemicals of biotic or abiotic origin that provoke a plant-typical stress response [105]. Jasmonic acid and the ester methyljasmonate (MeJas) were detected as signal compounds (Fig. 11.4) following wounding or microbial infection of plant tissue [106–108]. They induce the formation of many secondary product biosynthetic pathways, including several alkaloids. Nicotine formation was enhanced after wounding of *Nicotiana sylvestris*, and MeJas was the signal molecule [109]. The key enzyme of nicotine biosynthesis, PMT (see Fig. 11.3) was induced upon elicitation with MeJas. Transcripts of the tobacco PMT gene were detected only in the root, and enhanced transcription was antagonized by ethylene [110,111]. In cell cultures of *Nicotiana tabacum*, mRNA for ornithine decarboxylase, S-adenosylmethionine synthase and PMT were induced simultaneously by MeJas. These enzymes provide precursors for nic-



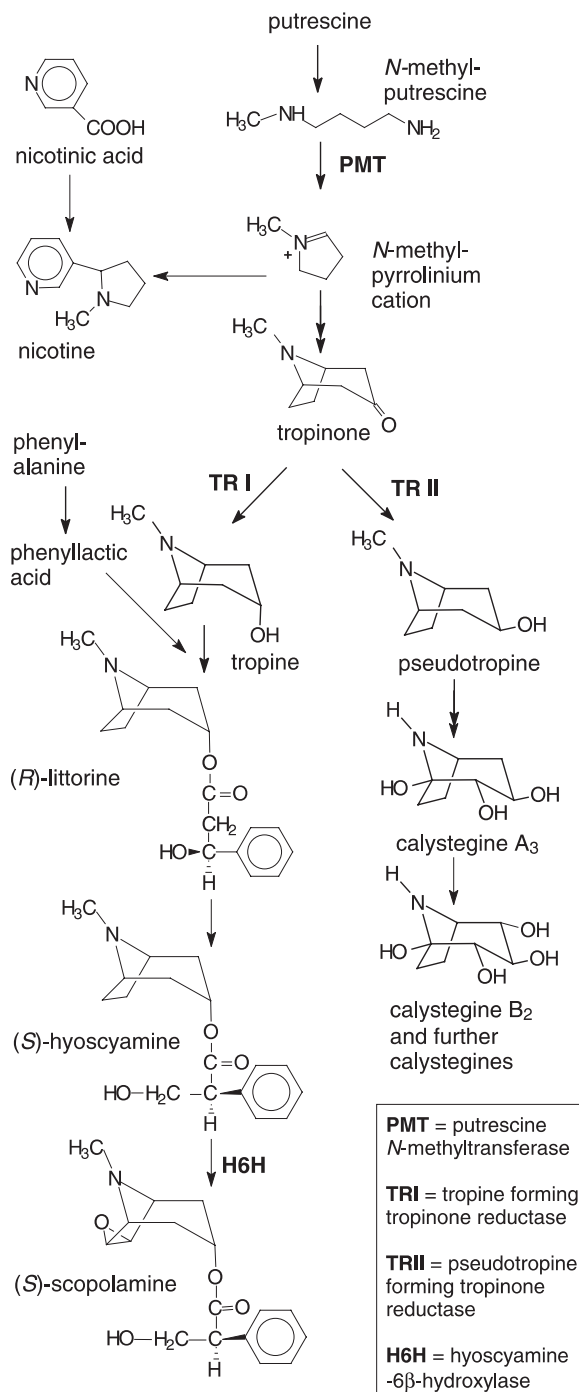


Fig. 11.3 Biosynthesis of tropane alkaloids and nicotine.

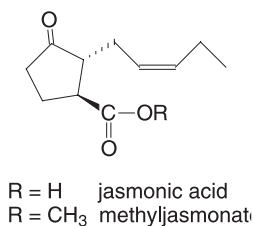
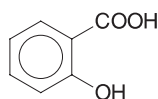


Fig. 11.4 Signal molecules in stress response.



salicylic acid

otine biosynthesis, and nicotine levels were enhanced subsequently. Auxin addition to the cell culture medium significantly reduced the accumulation of mRNA for nicotine biosynthetic enzymes [112]. Other alkaloids deriving from nicotinic acid, such as anatabine (4.8 mg g<sup>-1</sup> dm) and anatabine (0.54 mg g<sup>-1</sup> dm) (see Fig. 11.1) were enhanced after MeJas treatment of *Nicotiana tabacum* cv. By-2 cell cultures [69]. MeJas, however, does not only affect genes coding for tobacco alkaloid biosynthesis. Transcript profiling of elicited tobacco cells revealed an extensive MeJas-mediated genetic reprogramming of metabolism, which correlated with shifts in the biosynthesis of the metabolites investigated [113].

Tropane alkaloids, which share the same key enzyme PMT at the start of the pathway, respond to elicitation in some cases only, and by a less drastic total alkaloid increase. Copper and cadmium salts (1 mM), identified as abiotic elicitors in other plant cells, induced rapid accumulation of sesquiterpenoid defense compounds, for example, lubimin and 3-hydroxylubimin in root cultures of *D. stramonium*. The sesquiterpenoids were undetectable in non-elicited cultures. However, no change was seen in the total tropane alkaloid content. A considerable and rapid release of alkaloid into the nutrient medium was observed (50–75% of total alkaloids within 40–60 h) upon copper and cadmium elicitation. In cultures treated with copper ions, the alkaloids were reabsorbed [114]. MeJas increased alkaloid formation in hairy root cultures of *D. stramonium* as well as a cell wall preparation from baker's yeast and oligogalacturonides. In all cases, this was associated with an increase in tropine but a decline in phenyllactate concentrations. Increased tropane alkaloid synthesis was due to the differential enhancement of tropine biosynthesis [115]. MeJas, 100 nM in the root culture medium, was found to be the most effective concentration [101]. Root cultures of *Hyoscyamus muticus* responded to elicitation with chitosan; 50–500 µg mL<sup>-1</sup> culture enhanced the production of hyoscyamine fivefold. The response varied and was dependent upon the chitosan concentration and the time course of elicitation. Chitosan, like copper ions in *D. stramonium* roots, affected the permeability of the transformed roots, releasing hyoscyamine into the medium [116]. When examining the responses to MeJas treat-

ment in detail, large increases in *N*-methylputrescine levels in normal and hairy roots of *H. muticus* were detected. Levels of free putrescine and perchloric acid-soluble conjugated putrescine, spermidine and spermine also increased dramatically. Although treatment of root cultures with MeJas enhanced the precursors putrescine and *N*-methylputrescine, it provoked only modest increases in tropane alkaloid tissue levels [117]. It appears that every individual tropane alkaloid-producing root culture reacts in a specific way to elicitation. In *Brugmansia candida* root cultures, several biotic and abiotic elicitors were tested. Salicylic acid (Fig. 11.4) increased the release of hyoscyamine and scopolamine and enhanced their production. AgNO<sub>3</sub> similarly increased scopolamine release (threefold) and total alkaloid accumulation (five- to eightfold) in the roots; the inhibitory effects of AgNO<sub>3</sub> and salicylic acid on ethylene could partly explain these responses. Yeast extract enhanced the intracellular content of both alkaloids (ca. threefold), and increased the release of scopolamine (sevenfold). CaCl<sub>2</sub> had little effect on the accumulation or release of either alkaloid, while CdCl<sub>2</sub> released both alkaloids (three- to 24-fold), but was highly detrimental to growth [118]. Similar effects for salicylic acid and MeJas were reported for root cultures of *Scopolia parviflora* [119]. In root cultures, 200 μM MeJas increased the alkaloid accumulation 25-fold up to a level of 1 mg g<sup>-1</sup> fresh mass, while the flavonoid quercetin enhanced alkaloid production tenfold to 0.4 mg g<sup>-1</sup> fresh mass within 24 h. In contrast, 100 μM salicylic acid decreased alkaloids to a level of 1 μg g<sup>-1</sup> fresh mass [120]. Bacterial elicitors from *Pseudomonas aeruginosa*, *Bacillus cereus*, and *Staphylococcus aureus* were also investigated and altered the ratio between scopolamine and hyoscyamine. Absolute alkaloid concentrations were enhanced only slightly [121]. Considering the induction of tropane alkaloids by MeJas in root cultures, it was tempting to reinvestigate callus cultures, which are closer to dedifferentiated cell suspensions suited for large-scale production in fermenters than to roots. Putrescine and *N*-methylputrescine increased upon treatment with MeJas in root cultures of *H. muticus*, whereas in callus cultures *N*-methylputrescine levels were not affected. Arginine decarboxylase, ornithine decarboxylase and diamine oxidase activities in root cultures were strongly stimulated by treatment with MeJas, but were inhibited in callus cultures. Exposure to MeJas also enhanced PMT activity in root cultures more than in callus cultures [22]. These results match to the finding that the gene coding for PMT is transcribed specifically in the pericycle of young roots of *Atropa belladonna*. Treatment of these *A. belladonna* roots with MeJas did not up-regulate the expression of β-glucuronidase or the endogenous PMT genes [122]. Accordingly, a root culture of *A. belladonna* did not respond with increased total alkaloid concentration upon elicitation. *A. belladonna*, like many Solanaceae, produces calystegines in addition to the tropane ester alkaloid hyoscyamine. Calystegines were monitored upon chitosan and MeJas treatment within one to six days, and they decreased in concentration [44].

In summary, the contents of tropane alkaloids in Solanaceae root culture systems were optimized to impressive yields. Nonetheless, the production of tropane alkaloids from root cultures remains uneconomic in comparison with very good plant sources available [79,80]. The impact of Solanaceae cell cultures lies in providing material for the elucidation of alkaloid biosynthetic steps and their regulation.

## 11.3 Alkaloid Biosynthesis

### 11.3.1 Tropane Alkaloid Metabolites, Enzymes and Products

Despite the biosynthetic pathway of tropane alkaloids being depicted almost universally in textbooks of plant natural products, only two enzymes specific to the biosynthesis of hyoscyamine have been isolated and characterized (Fig. 11.3): PMT (EC 2.1.1.53) and the tropine-forming tropinone reductase (EC 1.1.1.206). Further, hyoscyamine-6-hydroxylase (EC 1.14.11.11), which catalyzes the formation of scopolamine from hyoscyamine, has been cloned and characterized in detail. Although most metabolic steps in tropane alkaloid formation have been elucidated using radioactive precursors and subsequent metabolite analysis, this method is prone to errors if not interpreted with caution, since assumed precursor molecules may be metabolized without participating in the plant's endogenous biosynthetic pathway (e.g., see [123]).

It is only 15 years ago that hydroxylated nortropane alkaloids, the calystegines, were structurally elucidated in extracts from roots of *Calystegia sepium*, Convolvulaceae [124]. Based on the nortropane structure, it was soon hypothesized that calystegines are formed via the tropane alkaloid pathway, and consequently tropane alkaloid-containing Solanaceae were investigated for calystegines [125,126]. Specific extraction and purification schemes were developed for the hydrophilic alkaloids, together with modified chromatographic procedures [127,128]. Calystegines were measured in many Solanaceae tissues; they also accumulate in root cultures but not in dedifferentiated cell suspension (Table 11.3). Calystegines resemble monosaccharides in structure, and were shown (somewhat unsurprisingly) to be potent inhibitors of glycosidase activity [129]. They are known to be widespread among the Solanaceae, not only in the species forming the tropane ester alkaloids but also in members of the large genus *Solanum* (e.g., potato) [130]. Erythroxy-

**Table 11.3** Calystegine accumulation in root cultures.

<i>Species/root culture</i>	<i>Total calystegines</i> % dm	<i>mg L<sup>-1</sup></i>	<i>Details</i>	<i>Reference</i>
<i>Atropa belladonna</i>	0.2	17.1	Transformed with <i>A. rhizogenes</i>	44
<i>Hyoscyamus albus</i>	0.16	–	Excised roots from seedlings	126
<i>Hyoscyamus aureus</i>	0.08	–	Excised roots from seedlings	126
<i>Hyoscyamus muticus</i>	0.11	–	Excised roots from seedlings	126
<i>Hyoscyamus niger</i>	0.11	–	Excised roots from seedlings	126
<i>Hyoscyamus pusillus</i>	0.04	–	Excised roots from seedlings	126
For comparison: <i>Calystegia sepium</i> Convolvulaceae	016	22.8	Transformed with <i>A. rhizogenes</i>	133

ceae also contain calystegines, but they are taxonomically remote from Solanaceae [131]. *Erythroxylum* species, however, are renowned for their cocaine content; the cocaine molecule also contains a tropane bicyclus. Biosynthesis of calystegines and their tropane nucleus in *Erythroxylum* species awaits elucidation. Current knowledge on calystegine biosynthesis and biochemistry has been summarized [132].

### 11.3.2

#### Putrescine N-methyltransferase (PMT)

Formation of the tropane bicyclus in Solanaceae begins by methylation of the ubiquitous diamine putrescine (see Fig. 11.3). This reaction is common to both, tropane and nicotine biosynthesis, and the enzyme PMT was initially extracted and measured from tobacco plant roots [134–137] and callus cultures [138]. Root cultures of *D. stramonium* [136,139,140], of *Hyoscyamus albus* [141,142], and of *H. niger* [143] contain PMT with catalytic properties similar to those of the tobacco enzyme. The cDNA of the *pmt* gene was cloned from tobacco (EMBL Accession No. D28506) [144] and from *Nicotiana sylvestris* (EMBL Accession Nos. AB004322, AB004323, AB004324) [110].

The *pmt* gene was shown to be expressed exclusively in the root pericycle of *A. belladonna* [122] and in the endodermis, xylem and outer cortex cells of *Nicotiana sylvestris* roots [110]. Expression was monitored by fusion of the 5'-flanking regions of the PMT genes to the  $\beta$ -glucuronidase reporter gene. The results offer an explanation for the inability of dedifferentiated cell suspension to synthesize tropane alkaloids: specific pericycle cells are required for *pmt* expression in tropane alkaloid-containing plants. Tobacco *pmt*, in comparison, is expressed in several cell types, among them root cortex parenchyma cells, to which dedifferentiated suspension cells may be similar. In tobacco, *pmt* is stress-responsive and inducible by MeJas [109–112]. In contrast to the tobacco *pmt* promoter [145], no MeJas responsive element was identified in the promoter region of *A. belladonna pmt* [122]. A detailed deletion analysis of the *N. tabacum pmt* promoter showed that as little as 111 bp upstream of the transcriptional start site were sufficient to confer MeJas-responsiveness. Deletion of a conserved G-box element (GCACGTTG) at –103 to –96 bp completely abolished MeJA-responsiveness. Further mutagenesis studies revealed that, in addition to a functional G-box, MeJA-responsiveness of the PMT promoter also required a TA-rich region and a GCC-motif (TGCGCCC) located at –80 to –69 bp and –62 to –56 bp relative to the start site, respectively, indicating multiple intersecting signal transduction pathways and different transcriptional regulatory factors involved in MeJas-response of PMT expression in tobacco [146]. Some *pmt* expression was also observed in tobacco leaves after mechanical wounding. This expression was highly localized around the wound site and proved to be transient, with levels being maximal immediately after wounding but diminishing after 2–4 h [147]. PMT expression is also regulated by auxin; in cell suspensions and root cultures, auxin was repeatedly observed to decrease nicotine and tropane alkaloid accumulation (see Sections 11.2.1 and 11.2.2.3). In fact, *pmt* gene transcription is suppressed upon auxin application [88, 112, 148].

The PMT protein resembles spermidine synthase (SPDS; EC 2.5.1.16), a ubiquitous enzyme which is considered to be the evolutionary ancestor of PMT in tobacco [149]. As calystegines are assumed to be formed via the tropane biosynthetic pathway, *Solanum tuberosum* and calystegine-forming Convolvulaceae should also contain PMT activity in order to build up the tropane alkaloid skeleton. Alternatively, it may be hypothesized that PMT is not required, because the bicyclic nortropane skeleton arises directly from putrescine without methylation via oxidation and condensation with three carbons. The alternative pathway for calystegines does not contain tropinone reductases and PMT [150]. In order to answer this question for potato, the cloning of a putative PMT gene was undertaken and, after expression, the corresponding cDNA yielded an enzyme with catalytic properties similar to those of tobacco and *D. stramonium* PMTs [151]. cDNA sequences homologous to *pmt* were also isolated from *C. sepium*, the cDNA is currently expressed (M. Teuber and B. Dräger, unpublished results). The results suggest a similar biosynthetic sequence for the formation of the tropane bicyclus in all these species with PMT as key enzyme.

The subsequent steps from *N*-methylputrescine to tropinone have been deduced mainly from precursor feeding. A diamine oxidase is thought to be involved in *N*-methylputrescine oxidation in tropane alkaloid, as well as in nicotine formation [152], but a specific enzyme was only partially purified from *H. niger* [153]. Later, a methylputrescine oxidase which differed from diamine oxidase was purified from tobacco roots [154]. The reactions from 4-aminobutanal, the *N*-methylpyrrolinium cation, and the formation of the tropane bicyclus are somewhat hypothetical [155].

### 11.3.3

#### Tropinone Reductases

For a long time – mainly because of their strong pharmacological effects – the tropane esters hyoscyamine and scopolamine were taken as the major tropane alkaloids in Solanaceae, on the basis of both quantity and activity. It was thought accordingly that during the course of its biosynthesis, tropinone was reduced stereospecifically to tropine (3 $\alpha$ -tropanol) (Fig. 11.3) and not to the isomeric pseudotropine (3 $\beta$ -tropanol). Measurement of tropinone-reducing enzyme activities in *D. stramonium* protein extracts confirmed this view: tropine only was found as reduction product, and pseudotropine was not formed [156]. The first tropinone reductase purification from *H. niger*, however, yielded an enzyme specific for pseudotropine formation [157]. In addition, pseudotropine was proved not to be isomerized into tropine in plant tissues [158]. Consequently, as that enzyme was not responsible for tropine formation, the existence of another tropinone reductase forming tropine was postulated. Two separate tropinone reductases were purified from *H. niger* root cultures [159], and also from *D. stramonium* root cultures [160]. *A. belladonna* root cultures also contained two specific enzymes [161]; the tropine-forming enzyme was termed TRI (EC 1.1.1.206), and the pseudotropine-forming enzyme TRII (EC 1.1.1.236). TRII activity was found to be strong in many Solanaceae tissues; for example, shortly after the application of tropinone, pseudotropine

accumulated faster than tropine [161]. Esters of pseudotropine (e.g., of acetic acid or tiglic acid) were identified only as minor alkaloids in those plants, and the metabolic role of TRII and the destination of pseudotropine formation were enigmatic, until calystegines were brought into the context of tropane alkaloid biosynthesis. The structure of calystegines contains an equatorial hydroxyl group in position 3, the typical feature of pseudotropine (Fig. 11.3). Accordingly, a typical TRII was isolated and characterized from potato tubers that contain calystegines, but not the tropane esters hyoscyamine and scopolamine [162]. It is now accepted that the pseudotropine-forming TRII is responsible for calystegine biosynthesis, while TRI is required for the formation of tropine, which is integrated into hyoscyamine and scopolamine.

A comparison of TRI and TRII enzymes from *D. stramonium* [160,163] and from *H. niger* [159] revealed proteins with similar properties, but with different catalytic and kinetic behavior. The molecular mass of the protein subunits was determined to be between 28 000 and 30 000 Da in each case. Sequencing of cDNA coding for *D. stramonium* TRs confirmed the protein subunits to consist of 273 (TRI) and 260 (TRII) amino acids with molecular masses of 29 615 Da and 28 310 Da, respectively [164]. Amino acid sequence homology (167 identical amino acid residues, 64%) and comparison of conserved amino acid motifs grouped both tropinone reductases into the family of short-chain dehydrogenases with their typical amino acid motifs [165,166]. All TRs require NADPH as reducing co-substrate; the enzymes are somewhat permissive for the ketone substrates, but strictly specific for the positioning of the resulting alcohol group.

The similarity in protein and catalysis of both reductases, but the apparent differences in reaction stereospecificity, were intriguing. Differential tropinone acceptance and fixation were suspected to be responsible for the selective formation of tropine and pseudotropine [163]. Reaction velocity, substrate affinity, and pH optima for TRI and TRII are conspicuously different (summarized in [167]). After heterologous expression in *E. coli*, sufficient enzyme protein was available for crystallization and protein structure elucidation of TRI and TRII [168–170]. Modeling of the tropinone binding site of TRI and TRII proved two different methods of substrate fixation. Positioning of the substrate in an optimal angle for hydride transfer from NADPH is considered an important prerequisite for efficient catalysis, and the enzyme proteins must be able to adjust to each transition state of the reaction [171].

#### 11.3.4

#### Hyoscyamine-6 $\beta$ -Hydroxylase

Subsequent esterification of tropine was shown to occur with phenyllactic acid, the first esterified alkaloid being littorine, which also accumulates in some Solanaceae and in root cultures of the respective plants [172–177]. Rearrangement of the phenyllactic acid moiety of littorine to yield hyoscyamine was demonstrated by labeled precursors and NMR [178–180], but not elucidated on an enzymatic level. There are various suggestions for the rearrangement mechanism, for example, an oxida-

tive reaction [181–183] or, alternatively, a radical mechanism with *S*-adenosylmethionine as source of a 5'-deoxyadenosyl radical, which initiates the rearrangement [184,185].

Hyoscyamine is oxidized to form scopolamine by an oxoglutarate-dependent dioxygenase, the hyoscyamine-6 $\beta$ -hydroxylase (H6H) [186]. The enzyme, which was purified and characterized from a *H. niger* root culture [186,187], performs a two-step reaction, first hydroxylating hyoscyamine in 6-position and subsequently forming the epoxy group of scopolamine [188,189]. Antibodies against the purified enzyme enabled localization of the H6H protein in the pericycle of root diameters of *H. niger* [190]. GUS-fusions to the promoter region of the *h6h* gene from *A. belladonna* and immunohistochemistry confirmed pericycle expression of *h6h* [191]. This finding similar to specific localization of PMT enforces the conclusion of differentiated root tissue being necessary for tropane alkaloid biosynthesis. Cloning of the *h6h* gene [192] and transformation of *A. belladonna* with *h6h* cDNA yielded plants with a drastically increased scopolamine production [193].

## 11.4

### Solanaceae Model Systems for Transformation and Overexpression

H6H overexpression in *A. belladonna* was the first proof of functional heterologous expression of a tropane alkaloid pathway enzyme and, thereby, directed alteration of the alkaloid yield and pattern. The success triggered many further efforts to use the cloned genes of tropane alkaloid formation for overexpression. Transformation protocols applied either *A. rhizogenes* transformation or particle bombardment by a biolistic device. Efficient regeneration of fertile plants after transformation, however – even with Solanaceae – was a major obstacle, and remains difficult. A regeneration protocol after transformation of *H. muticus* with particle bombardment was optimized [194].

PMT overexpression in transgenic plants of *Nicotiana sylvestris* increased nicotine content; suppression of endogenous PMT activity severely decreased the nicotine content and induced abnormal morphologies. In contrast, PMT-overexpressing transformants of *A. belladonna* were phenotypically normal and had hyoscyamine levels (1.3–2.4 mg g<sup>-1</sup> dm) comparable to those for the wild-type and vector controls. The only difference was some accumulation of *N*-methylputrescine [195]. Transgenic hairy root clones had a fivefold increase of the PMT transcript, but scopolamine, hyoscyamine, tropine, pseudotropine, tropinone, and calystegines were found unaltered or somewhat decreased. Auxin addition reduced tropane alkaloids in control roots as seen before, while in *pmt*-overexpressing roots, all alkaloids remained unaltered [148]. The unchanged alkaloid profiles after augmented PMT expression indicated that enforcing this enzyme alone was not sufficient to increase tropane alkaloid synthesis in *A. belladonna* plants and hairy roots. After *pmt* overexpression in hairy root cultures of *D. metel*, both hyoscyamine and scopolamine production were improved, whereas in *H. muticus* only hyoscyamine contents were increased by *pmt* gene overexpression. The results indicate that the same biosyn-



thetic pathway in related plant species is regulated differently, and overexpression of a given gene does not necessarily lead to a similar accumulation pattern of secondary metabolites [196].

For nicotine production, PMT appears to be largely regulating the whole subsequent biosynthetic pathway. Suppression of *pmt* transcripts by virus-induced gene silencing [197], by *pmt* antisensing, or by *pmt* inverted-repeats yielded plants with decreased nicotine contents that were preferred by herbivorous insects [198,199]. *pmt* antisensing did not reduce the transcript levels of other genes encoding enzymes of nicotine biosynthesis (e.g., quinolinate phosphoribosyltransferase regulating the synthesis of nicotinic acid). The pyridine ring is used for both, nicotine and anatabine synthesis. Elevated anatabine levels in antisense-PMT roots were observed and may be a direct consequence of a relative oversupply of nicotinic acid [200].

The activities of tropinone-reducing enzymes are usually high and considered as not limiting for tropine formation [159]; consequently, these enzymes were not primary targets for overexpression. The feasibility of TRI overexpression was shown in tobacco plants that, after tropinone application, formed tropine and acetyltropine as esterification product [201]. Overexpression of tropine-forming tropinone reductases became interesting with the understanding that tropinone reduction forms a branch point in tropane alkaloid metabolism (Fig. 11.3). Overexpression of either tropinone reductase was attempted in species that accumulate both tropine-derived alkaloids and calystegines. Transformation of *A. belladonna* with cDNA of tropinone reductases altered the ratio of tropine-derived alkaloids versus pseudotropine-derived alkaloids [202].

Root cultures of *A. belladonna* overexpressing *h6h* contained 0.4% dm total alkaloids, with 0.3% dm scopolamine. In control roots, hyoscyamine (0.3% dm) is the major ester alkaloid [203]. Tobacco plants overexpressing *h6h* were equally able to convert externally applied hyoscyamine into scopolamine [204]. Leaves of tobacco plants simultaneously transformed with *pmt* and *h6h* ( $T_1$  progeny) were fed with tropinone and hyoscyamine. They converted externally applied hyoscyamine into scopolamine and, besides the expected TRI reaction product tropine, acetyltropine was generated. In addition, leaves of the transgenic plants showed three- to 13-fold higher nicotine content and nicotine-related compounds such as anatabine, nor-nicotine, bipyridine, anabasine, and myosmine [201]. *h6h* was also introduced into *H. muticus*, and root cultures were obtained. The best root clone produced 17 mg L<sup>-1</sup> scopolamine – approximately 100 times more than the control clones [52]. Simultaneous introduction and overexpression of PMT and H6H in transgenic *H. niger* hairy root cultures yielded higher levels of scopolamine than wild-type and transgenic lines harboring a single gene (*pmt* or *h6h*). The best root line produced 411 mg L<sup>-1</sup> scopolamine, ninefold the corresponding wild-type with 43 mg L<sup>-1</sup> [53]. This productivity is comparable with the production of paclitaxel in cell suspension culture of *Taxus* species, which presents the latest example of industrially applied secondary compound production in plant cell cultures [205].

The decision as to whether tropane alkaloid production in root cultures now crosses the line between a model system and an economically feasible alternative

to field cultivation remains hampered by good plant sources and thereby comparable cheap prices for these alkaloids. For other alkaloids (e.g., taxanes), production in fermenters appeared highly attractive, when a similar productivity was achieved [206].

## 11.5

### Conclusion and Future Aspects

#### 11.5.1

##### More Genes and Enzymes

For successful metabolic engineering of tropane alkaloid formation, irrespective of whether this is intended for tissue cultures or intact plants, all enzymatic steps of the biosynthesis must be characterized. The genes encoding the enzymes and the corresponding regulatory gene sequences also await characterization. Alkaloid biosynthetic pathways in plants other than Solanaceae are better known at present, with more enzymes and genes having been isolated, sequenced, and characterized. A prominent example is the recent metabolic engineering of benzoquinoline alkaloid biosynthesis based on the particular knowledge of pathway enzymes [207], where transgenic plants of opium poppy (*Papaver somniferum*) have been blocked for morphine production [208, 209]. Another example of a secondary compound pathway, which has been largely elucidated during the past years, is taxane formation in *Taxus* species [210]. Natural enzymes will not remain the only instruments for overexpression, as many secondary pathway enzymes show some substrate flexibility and accept synthetic analogues of their natural ligands [211, 212]. Directed evolution of enzymes (for a review, see [213]) and alteration of enzymatic specificities – also termed “combinatorial biochemistry” (for a summary, see [214]) – followed by the introduction of the corresponding genes into plant tissue will open the way to variant and novel alkaloids and other natural products. In flavonoid biosynthesis, where many enzymes and their genes have been investigated in detail, impressive examples of targeted manipulation in the biosynthetic pathway have been published (summarized in [215, 216]).

The complex flavonoid biosynthesis was also the first secondary product pathway, where individual transcription factors for gene activity were described [217, 218]. The elucidation of more regulatory mechanisms – for alkaloid biosynthesis in particular – will become mandatory for successful metabolic engineering. The first example for transcription factors regulating alkaloid biosynthesis are ORCAs (octadecanoid responsive *Catharanthus* AP2-domain proteins), which are involved in jasmonate signaling inducing strictosidine synthase for monoterpene alkaloid formation [219, 220]. Comparable regulatory genes at hand, induction and fine-tuning of tropane alkaloid biosynthesis will become less like trial and error. Other gene elements have also been found to regulate plant transgene expression, for example the cis-acting amplification-promoting sequences (*aps*) from the non-transcribed spacer region of tobacco ribosomal RNA. Analysis of transgenic tobacco

plants showed that *aps* increased the copy number and transcription of the adjacent heterologous genes and both, increased transgene copy number and enhanced expression were stably inherited [221]. This and other regulatory elements will be helpful tools for designing plants or tissue cultures with desired metabolic traits.

The question remains as to which approaches are useful for straightforward identification of genes involved in alkaloid biosynthesis? With high-throughput hybridization and sequencing systems at hand, transcript profiling of jasmonate-elicited tobacco cells was combined with alkaloid metabolite analysis. Upon MeJas treatment, extensive genetic reprogramming of metabolism was observed [113]. Careful selection of promising target sequences and in-depth analysis is prone to detect genes regulating alkaloid biosynthesis in tobacco in the future. A similar concept was successfully applied for the detection of genes of morphine biosynthesis in *Papaver somniferum*, with macroarrays with cDNA having been prepared for differentiating expression between morphine-containing *P. somniferum* plants and eight other *Papaver* species that accumulate other benzyloisoquinolines instead of morphine. Among three cDNAs showing increased expression in *P. somniferum* compared to all other *Papaver* species, one encoded a novel O-methyltransferase, thus proving the potency of the concept [222]. In the future, potent genomics tools will be combined with metabolic profiling to identify key genes that serve for engineering secondary product pathways [223]

#### 11.5.2

#### Compartmentation, Transport, and Excretion

For large-scale production in fermenters, the excretion of alkaloids into the medium is desirable. When the *h6h* gene from *H. niger* was overexpressed in *Nicotiana tabacum*, externally applied hyoscyamine was taken up, and up to 85% of the scopolamine formed was released to the culture medium [224]. The mechanism of secretion is unknown in this case, but membrane transport may be hypothesized. When ATP-binding cassette (ABC) transporter genes from yeast were expressed in cultured tobacco cells, exogenously applied nicotine, hyoscyamine and scopolamine were less toxic than in control cells. It was assumed that the engineered tobacco cells were able to excrete the alkaloids [225].

The toxicity of alkaloids to the cells that produce them must be considered as a major constraint of high-level production, and efficient compartmentation of the toxic products is necessary. Storage in the vacuole is often assumed, but this demands transport of the metabolites through the tonoplast as well as secretion through the plasmalemma. A cDNA encoding an ABC-transporter was cloned from a berberine-producing *Coptis japonica* cell culture [226], whereupon functional analysis showed that the encoded protein transported berberine and was localized in the plasma membrane of *C. japonica* cells. In the plant, the protein is localized in the xylem of the rhizome and is held responsible for berberine transport from the root to the rhizome [227, 228].

Further examples of membrane transport being fairly specific and highly regulated for each secondary metabolite also exist. Genes for such transporters will be important for systematic metabolic engineering aimed at increasing the productivity of valuable secondary metabolites in plants [227]. In addition, consecutive enzymes of secondary product pathways may be exclusively localized to individual specialized cell types and demand transport of metabolites between those cells. Examples are essential oil biosynthesis in glandular trichomes [229], formation of terpenoid indole alkaloids in several cells types of *Catharanthus* leaf ([230]), or morphine biosynthesis in vascular bundles and lactifers of opium poppy [231, 232]. Highly ordered translocation processes that involve transport proteins must be elucidated when attempting to understand how plants regulate the formation and accumulation of natural product profiles, and which are the limitations of biosynthesis and accumulation [233].

### Acknowledgment

The author thanks Stefan Biastoff of the Department of Pharmaceutical Biology, Martin-Luther University for critically reading and correcting the manuscript.

### References

- 1 Bruhn, J.G. *Acta Pharmaceutica Nordica* **1989**, *1*, 117–130.
- 2 Romeike, A. *Naturwissenschaften* **1959**, *46*, 492–493.
- 3 Liebis, H.W., Ramin, H., Schoeffinius, I., Schuette, H.R. *Z. Naturforschung, Teil B: Anorganische Chemie, Organische Chemie, Biochemie, Biophysik, Biologie* **1965**, *20*, 1183–1185.
- 4 Liebis, H.W., Peisker, K., Radwan, A.S., Schuette, H.R. *Z. Pflanzenphysiologie* **1972**, *67*, 1–9.
- 5 Gross, D., Schuette, H.R. *Arch. Pharm.* **1963**, *296*, 1–6.
- 6 Singh, M., Krikorian, A.D. *Ann. Botany* **1981**, *47*, 133–139.
- 7 Alcalde, M.B. *Farmacognosia* **1956**, *16*, 283–455.
- 8 Linsmaier, E.M., Skoog, F. *Physiol. Plant.* **1965**, *18*, 100–127.
- 9 Hashimoto, T., Yamada, Y. *Planta Med.* **1983**, *47*, 195–199.
- 10 Endo, T., Yamada, Y. *Phytochemistry* **1985**, *24*, 1233–1236.
- 11 Hashimoto, T., Yukimune, Y., Yamada, Y. *J. Plant Physiol.* **1986**, *124*, 61–75.
- 12 Maldonado, M., Ayora-Talavera, I.T.-D. R., Loyola, V. *In Vitro Cell. Dev. Biol. Plant* **1992**, *28P*, 67–72.
- 13 Hashimoto, T., Yamada, Y. *Agric. Biol. Chem.* **1987**, *51*, 2769–2774.
- 14 Yamada, Y., Hashimoto, T. *Plant Cell Rep.* **1982**, *1*, 101–103
- 15 Hiraoka, N., Tabata, M., Konoshima, M. *Phytochemistry* **1973**, *12*, 795–799.
- 16 Yamada, Y., Endo, T. *Plant Cell Rep.* **1984**, *3*, 166–168.
- 17 Gontier, E., Sangwan, B.S., Barbotin, J.N. *Plant Cell Rep.* **1994**, *13*, 533–536.
- 18 Medina, B.F., Flores, H.E. *Plant Physiol.* **1995**, *108*, 1553–1560.
- 19 Mothes, K. *Angew. Chem.* **1952**, *64*, 254–258.
- 20 Hills, K.L., Trautner, E.M., Rodwell, C.N. *Aust. J. Sci.* **1946**, *9*, 24–25.
- 21 Dawson, R.F. *Science* **1941**, *94*, 396–397.
- 22 Biondi, S., Scaramagli, S., Oksman-Caldentey, K.-M., Poli, F. *Plant Sci.* **2002**, *163*, 563–569.
- 23 Mesnard, F., Girard, S., Fliniaux, O., Bhogal, R.K., Gillet, F., Lembreton, J., Fliniaux, M.A., Robins, R.J. *Plant Sci.* **2001**, *161*, 1011–1018.

- 24 Fliniaux, O., Mesnard, F., Raynaud-Le Grandic, S., Baltora-Rosset, S., Bieneme, C., Robins, R.J., Fliniaux, M.-A. *J. Exp. Bot.* **2004**, *55*, 1–8.
- 25 White, F.F., Ghidossi, G., Gordon, M.P., Nester, E.W. *Proc. Natl. Acad. Sci. USA* **1982**, *79*, 3193–3197.
- 26 Cardarelli, M., Spano, L., De-Paolis, A., Mauro, M.L., Vitali, G., Costantino, P. *Plant Mol. Biol.* **1985**, *5*, 385–392.
- 27 Chilton, M.D., Tepfer, D.A., Petit, A., David, C., Casse-Delbart, F., Tempe, J. *Nature* **1982**, *295*, 432–434.
- 28 Gamborg, O.L., Miller, R.A., Ojima, K. *Exp. Cell Res.* **1968**, *50*, 151–158.
- 29 Payne, J., Hamill, J.D., Robins, R.J., Rhodes, M.-J.C. *Planta Med.* **1987**, *53*, 474–478.
- 30 Deno, H., Yamagata, H., Emoto, T., Yoshioka, T., Yamada, Y., Fujita, Y. *J. Plant Physiol.* **1987**, *131*, 315–324.
- 31 Jung, G., Tepfer, D. *Plant Sci.* **1987**, *50*, 145–152.
- 32 Kamada, H., Okamura, N., Satake, M., Harada, H., Shimomura, K. *Plant Cell Rep.* **1986**, *5*, 239–242.
- 33 Sevon, N., Hiltunen, R., Oksman-Caldentey, K.M. *Planta Med.* **1998**, *64*, 37–41.
- 34 Aoki, T., Matsumoto, H., Asako, Y., Matsunaga, Y., Shimomura, K. *Plant Cell Rep.* **1997**, *16*, 282–286.
- 35 Giulietti, A.M., Parr, A.J., Rhodes, M.-J.C. *Planta Med.* **1993**, *59*, 428–431.
- 36 Bonhomme, V., Laurain, M.D., Lacoux, J., Fliniaux, M., Jacquoin, D.A. *J. Biotechnol.* **2000**, *81*, 151–158.
- 37 Toivonen, L. *Biotechnol. Progress* **1993**, *9*, 12–20.
- 38 Baiza, A.M., Quiroz, M.A., Ruiz, J.A., Loyola, V. *Plant Cell Tiss. Organ Cult.* **1999**, *59*, 9–17.
- 39 Sevon, N., Oksman-Caldentey, K.M. *Planta Med.* **2002**, *68*, 859–868.
- 40 Jung, D.-W., Sung, C.K., Touno, K., Yoshimatsu, K., Shimomura, K. *J. Plant Physiol.* **2001**, *158*, 801–805.
- 41 Hartmann, T., Witte, L., Oprach, F., Toppel, G. *Planta Med.* **1986**, *52*, 390–395.
- 42 Staba, E.J., Jindra, A. *J. Pharm. Sci.* **1968**, *57*, 701–704.
- 43 Oksman-Caldentey, K.M., Vuorela, H., Strauss, A., Hiltunen, R. *Planta Med.* **1987**, *53*, 349–354.
- 44 Rothe, G., Garske, U., Dräger, B. *Plant Sci.* **2001**, *160*, 1043–1053.
- 45 Christen, P., Roberts, M.F., Phillipson, J.D., Evans, W.C. *Plant Cell Rep.* **1989**, *8*, 75–77.
- 46 Dupraz, J.M., Christen, P., Kapetanidis, I. *Planta Med.* **1993**, *60*, 158–162.
- 47 Pinol, M.T., Palazon, J., Cusido, R., Serrano, M. *Botanica Acta* **1996**, *109*, 133–138.
- 48 Jaziri, M., Legros, M., Homes, J., Vanhaelen, M. *Phytochemistry* **1988**, *27*, 419–420.
- 49 Mano, Y., Ohkawa, H., Yamada, Y. *Plant Sci.* **1989**, *59*, 191–202.
- 50 Celma, C.R., Palazon, J., Cusido, R.M., Pinol, M.T., Keil, M. *Planta Med.* **2001**, *67*, 249–253.
- 51 Yukimune, Y., Hara, Y., Yamada, Y. *Biosci. Biotechnol. Biochem.* **1994**, *58*, 1443–1446.
- 52 Jouhikainen, K., Lindgren, L., Jokelainen, T., Hiltunen, R., Teeri, T.H., Oksman-Caldentey, K.M. *Planta* **1999**, *208*, 545–551.
- 53 Zhang, L., Ding, R., Chai, Y., Bonfill, M., Moyano, E., Oksman-Caldentey, K.-M., Xu, T., Pi, Y., Wang, Z., Zhang, H., Kai, G., Liao, Z., Xiaofen Sun, X., Tang, K. *Proc. Natl. Acad. Sci. USA* **2004**, *101*, 6786–6791.
- 54 Mano, Y., Nabeshima, S., Matsui, C., Ohkawa, H. *Agric. Biol. Chem.* **1986**, *50*, 2715–2722.
- 55 Zelcer, A., Soferman, O., Izhar, S., Volcani, C. *Plant Cell Rep.* **1983**, *2*, 252–254.
- 56 Ooms, G., Karp, A., Burrell, M.M., Twell, D., Roberts, J. *Theoret. Appl. Genetics* **1985**, *70*, 440–446.
- 57 Martin, T.J., Tepfer, D., Burtin, D. *Plant Sci.* **1991**, *80*, 131–144.
- 58 Martin, T.J., Corbinau, F., Burtin, D., Ben-Hayyim, G., Tepfer, D. *Plant Sci.* **1993**, *93*, 63–76.
- 59 Oksman-Caldentey, K.M., Kivela, O., Hiltunen, R. *Plant Sci.* **1991**, *78*, 129–136.
- 60 Dehio, C., Grossmann, K., Schell, J., Schmulling, T. *Plant Mol. Biol.* **1993**, *23*, 1199–1210.
- 61 Khanam, N., Khoo, C., Close, R., Khan, A.G. *Ann. Botany* **2000**, *86*, 745–752.
- 62 Khanam, N., Khoo, C., Close, R., Khan, A.G. *Phytochemistry* **2001**, *56*, 59–65.

- 63 Panaia, M., Senaratna, T., Brunn, E., Dixon, K.W., Sivasithamparam, K. *Plant Cell Tiss. Organ Cult.* **2000**, *63*, 23–19.
- 64 Kang, Y.M., Min, J.Y., Moon, H.S., Karigar, C.S., Prasad, D.T., Lee, C.H., Choi, M.S. *Plant Cell Rep.* **2004**, *23*, 128–133.
- 65 Hiraoka, N., Shinohara, C., Ogata, H., Chang, J.I., Bhatt, I.D. *Natural Med.* **2004**, *58*, 98–103.
- 66 McHale, N.A. *Plant Physiol.* **1985**, *77*, 204–242.
- 67 Beimen, A., Witte, L., Barz, W. *Botanica Acta* **1992**, *105*, 152–160.
- 68 Ikemeyer, D., Barz, W. *Plant Cell Rep.* **1989**, *8*, 479–482.
- 69 Haekkinen, S.T., Rischer, H., Laakso, I., Maaheimo, H., Seppänen-Laakso, T., Oksman-Caldentey, K.M. *Planta Med.* **2004**, *70*, 936–941.
- 70 Parr, A.J., Hamill, J.D. *Phytochemistry* **1987**, *26*, 3241–3246.
- 71 Palazon, J., Cusido, R.M., Roig, C., Pinol, M.T. *Plant Cell Rep.* **1998**, *17*, 384–390.
- 72 Olmstead, R.G., Palmer, J.D. *Systematic Bot.* **1997**, *22*, 19–29.
- 73 Murashige, T., Skoog, F. *Physiol. Plant.* **1962**, *15*, 473–497.
- 74 Kittipongpatana, N., Hock, R.S., Porter, J.R. *Plant Cell Tiss. Organ Cult.* **1998**, *52*, 133–143.
- 75 Drewes, F.E., Van-Staden, J. *Plant Growth Regul.* **1995**, *17*, 27–31.
- 76 Yu, S., Kwok, K.H., Doran, P.M. *Enzyme Microb. Technol.* **1996**, *18*, 238–243.
- 77 Quadri, L.E.N., Giuliotti, A.M. *Enzyme Microb. Technol.* **1993**, *15*, 1074–1077.
- 78 Ehmke, A., Ohmstede, D., Eilert, U. *Plant Cell Tiss. Organ Cult.* **1995**, *43*, 191–197.
- 79 Lean, J.A., Ralph, C.S. *J. Proc. Royal Soc. New South Wales* **1944**, *77*, 96–98.
- 80 Hills, K.L., Bottomley, W., Mortimer, P.I. *Aust. J. Appl. Sci.* **1954**, *5*, 283–291.
- 81 Hilton, M.G., Wilson, P.-D.G. *Planta Med.* **1995**, *61*, 345–350.
- 82 Hilton, M.G., Rhodes, M.J. *Appl. Biochem. Biotechnol.* **1990**, *33*, 132–138.
- 83 Hilton, M.G., Rhodes, M.-J.C. *Planta Med.* **1993**, *59*, 340–344.
- 84 Cusido, R.M., Palazon, J., Pinol, M.T., Bonfill, M., Morales, C. *Planta Med.* **1999**, *65*, 144–148.
- 85 Lee, K.T., Suzuki, T., Yamakawa, T., Kodama, T., Igarashi, Y., Shimomura, K. *Plant Cell Rep.* **1999**, *18*, 567–571.
- 86 Muranaka, T., Ohkawa, H., Yamada, Y. *Appl. Biochem. Biotechnol.* **1993**, *140*, 219–223.
- 87 Chang, H.N., Sim, S.J. *Curr. Opin. Biotechnol.* **1995**, *6*, 209–212.
- 88 Rothe, G., Dräger, B. *Plant Sci.* **2002**, *163*, 979–985.
- 89 Sauerwein, M., Wink, M., Shimomura, K. *J. Plant Physiol.* **1992**, *140*, 147–152.
- 90 Flores, H.E., Dai, Y.R., Cuello, J.L., Maldonado, M., Loyola, I.V. *Plant Physiol.* **1993**, *101*, 363–371.
- 91 Yukimune, Y., Yamagata, H., Hara, Y., Yamada, Y. *Biosci. Biotechnol. Biochem.* **1994**, *58*, 1824–1827.
- 92 Williams-Gary, R.C., Doran, P.M. *Biotechnol. Bioeng.* **1999**, *64*, 729–740.
- 93 Yukimune, Y., Tabata, H., Hara, Y., Yamada, Y. *Biosci. Biotechnol. Biochem.* **1994**, *58*, 1447–1450.
- 94 Roberts, S.C., Shuler, M.L. *Curr. Opin. Biotechnol.* **1997**, *8*, 154–159.
- 95 Sharp, J.M., Doran, P.M. *J. Biotechnol.* **1990**, *16*, 171–186.
- 96 Boitel, C.M., Laberche, J.C., Lanoue, A., Ducrocq, C., Sangwan-Norreel, B.S. *Plant Cell Tiss. Organ Cult.* **2000**, *60*, 131–137.
- 97 Yoshioka, T., Yamagata, H., Ithoh, A., Deno, H., Fujita, Y., Yamada, Y. *Planta Med.* **1989**, *55*, 523–524.
- 98 Robins, R.J., Parr, A.J., Bent, E.G., Rhodes, M.-J.C. *Planta* **1991**, *183*, 185–195.
- 99 Dräger, B., Portsteffen, A., Schaal, A., MacCabe, P.H., Peerless, A.-C.J., Robins, R.J. *Planta* **1992**, *188*, 581–586.
- 100 Yukimune, Y., Tabata, H., Hara, Y., Yamada, Y. *Biosci. Biotechnol. Biochem.* **1994**, *58*, 1820–1823.
- 101 Saenz, C.L., Loyola, V. *Appl. Biochem. Biotechnol.* **1997**, *61*, 321–337.
- 102 Kitamura, Y., Sugimoto, Y., Samejima, T., Hayashida, K., Miura, H. *Chem. Pharm. Bull.* **1991**, *39*, 1263–1266.
- 103 Zarate, R. *Plant Cell Rep.* **1999**, *18*, 418–423.
- 104 Nussbaumer, P., Kapetanidis, I., Christen, P. *Plant Cell Rep.* **1998**, *17*, 405–409.

- 105 Poulev, A., O'Neal, J.M., Logendra, S., Pouleva, R.B., Timeva, V., Garvey, A.S., Gleba, D., Jenkins, I.S., Halpern, B.T., Kneer, R., Cragg, G.M., Raskin, I. *J. Med. Chem.* **2003**, *46*, 2542–2547.
- 106 Gundlach, H., Mueller, M.J., Kutchan, T.M., Zenk, M.H. *Proc. Natl. Acad. Sci. USA* **1992**, *89*, 2389–2393.
- 107 Creelman, R.A., Tierney, M.L., Mullet, J.E. *Proc. Natl. Acad. Sci. USA* **1992**, *89*, 4938–4941.
- 108 Bleichert, S., Brodschelm, W., Hoelder, S., Kammerer, L., Kutchan, T.M., Mueller, M.J., Xia, Z.Q., Zenk, M.H. *Proc. Natl. Acad. Sci. USA* **1995**, *92*, 4099–4105.
- 109 Baldwin, I.T., Zhang, Z.P., Diab, N., Ohnmeiss, T.E., McCloud, E.S., Lynds, G.Y., Schmelz, E.A. *Planta* **1997**, *201*, 397–404.
- 110 Shoji, T., Yamada, Y., Hashimoto, T. *Plant Cell Physiol.* **2000**, *41*, 831–839.
- 111 Shoji, T., Nakajima, K., Hashimoto, T. *Plant Cell Physiol.* **2000**, *41*, 1072–1076.
- 112 Imanishi, S., Hashizume, K., Nakakita, M., Kojima, H., Matsubayashi, Y., Hashimoto, T., Sakagami, Y., Yamada, Y., Nakamura, K. *Plant Mol. Biol.* **1998**, *38*, 1101–1111.
- 113 Goossens, A., Haekkinen, S.T., Laakso, I., Seppänen-Laakso, T., Biondi, S., De Sutter, V., Lammertyn, F., Nuutila, A.M., Soederlund, H., Zabeau, M., Inze, D., Oksman-Caldentey, K.M. *Proc. Natl. Acad. Sci. USA* **2003**, *100*, 8595–8600.
- 114 Furze, J.M., Rhodes, M.-J.C., Parr, A.J., Robins, R.J., Whitehead, I.M., Threlfall, D.R. *Plant Cell Rep.* **1991**, *10*, 111–114.
- 115 Zabetakis, I., Edwards, R., O'Hagan, D. *Phytochemistry* **1999**, *50*, 53–56.
- 116 Sevon, N., Hiltunen, R., Oksman-Caldentey, K.M. *Pharm. Pharmacol. Lett.* **1992**, *2*, 96–99.
- 117 Biondi, S., Fornale, S., Oksman-Caldentey, K.M., Eeva, M., Agostani, S., Bagni, N. *Plant Cell Rep.* **2000**, *19*, 691–697.
- 118 Pitta, A.S., Spollansky, I.T.C., Giuliatti, A.M. *Enzyme Microb. Technol.* **2000**, *26*, 252–258.
- 119 Kang, S.M., Jung, H.Y., Kang, Y.M., Yun, D.J., Bahk, J.D., Yang, J.K., Choi, M.S. *Plant Sci.* **2004**, *166*, 745–751.
- 120 Zayed, R., Wink, M. *Z. Naturforschung, C: J. Biosci.* **2004**, *59*, 863–867.
- 121 Jung, H.Y., Kang, S.M., Kang, Y.M., Kang, M.J., Yun, D.J., Bahk, J.D., Yang, J.K., Choi, M.S. *Enzyme Microb. Technol.* **2003**, *33*, 987–990.
- 122 Suzuki, K., Yamada, Y., Hashimoto, T. *Plant Cell Physiol.* **1999**, *40*, 289–297.
- 123 Hashimoto, T., Yamada, Y., Leete, E. *J. Am. Chem. Soc.* **1989**, *111*, 1141–1142.
- 124 Goldmann, A., Milat, M.L., Ducrot, P.H., Lallemand, J.Y., Maille, M., Lepingle, A., Charpin, I., Tepfer, D. *Phytochemistry* **1990**, *29*, 2125–2128.
- 125 Dräger, B., van Almsick, A., Mrachatz, G. *Planta Med.* **1995**, *61*, 577–579.
- 126 Dräger, B., Funck, C., Hoehler, A., Mrachatz, G., Nahrstedt, A., Portsteffen, A., Schaal, A., Schmidt, R. *Plant Cell Tiss. Organ Cult.* **1994**, *38*, 235–240.
- 127 Dräger, B. *Phytochem. Analyt.* **1995**, *6*, 31–37.
- 128 Dräger, B. *J. Chromatogr. A* **2002**, *978*, 1–35.
- 129 Asano, N., Nash, R.J., Molyneux, R.J., Fleet, G.W. *Tetrahedron: Asymmetry* **2000**, *11*, 1645–1680.
- 130 Keiner, R., Dräger, B. *Plant Sci.* **2000**, *150*, 171–179.
- 131 Brock, A., Bieri, S., Christen, P., Dräger, B. *Phytochemistry* **2005**, *66*, 1231–1240.
- 132 Dräger, B., *Nat. Prod. Rep.* **2004**, *21*, 211–223.
- 133 Scholl, Y., Höke, D., Dräger, B. *Phytochemistry* **2001**, *58*, 883–889.
- 134 Mizusaki, S., Tanabe, Y., Noguchi, M., Tamaki, E. *Plant Cell Physiol.* **1973**, *14*, 103–110.
- 135 Mizusaki, S., Tanabe, Y., Noguchi, M., Tamaki, E. *Plant Cell Physiol.* **1971**, *12*, 633–640.
- 136 Feth, F., Arfmann, H.A., Wray, V., Wagner, K.G. *Phytochemistry* **1985**, *24*, 921–923.
- 137 Wagner, R., Feth, F., Wagner, K.G., *Physiol. Plant.* **1986**, *68*, 667–672.
- 138 Feth, F., Wagner, R., Wagner, K.G. *Planta* **1986**, *168*, 402–407.
- 139 Walton, N.J., Robins, R.J., Peerless, A.-C.J. *Planta* **1990**, *182*, 136–141.
- 140 Walton, N.J., Peerless, A.-C.J., Robins, R.J., Rhodes, M.-J.C., Boswell, H.D., Robins, D.J. *Planta* **1994**, *193*, 9–15.



- 141 Hashimoto, T., Yukimune, Y., Yamada, Y. *Planta* **1989**, *178*, 131–137.
- 142 Hashimoto, T., Yukimune, Y., Yamada, Y. *Planta* **1989**, *178*, 123–130.
- 143 Hibi, N., Fujita, T., Hatano, M., Hashimoto, T., Yamada, Y. *Plant Physiol.* **1992**, *100*, 826–835.
- 144 Hibi, N., Higashiguchi, S., Hashimoto, T., Yamada, Y. *Plant Cell* **1994**, *6*, 723–735.
- 145 Hashimoto, T., Shoji, T., Mihara, T., Oguri, H., Tamaki, K., Suzuki, K.i., Yamada, Y. *Plant Mol. Biol.* **1998**, *37*, 25–37.
- 146 Xu, B., Timko, M. *Plant Mol. Biol.* **2004**, *55*, 743–761.
- 147 Sachan, N., Falcone, D.L. *Phytochemistry* **2002**, *61*, 797–805.
- 148 Rothe, G., Hachiya, A., Yamada, Y., Hashimoto, T., Dräger, B. *J. Exp. Bot.* **2003**, *54*, 2065–2070.
- 149 Hashimoto, T., Tamaki, K., Suzuki, K., Yamada, Y. *Plant Cell Physiol.* **1998**, *39*, 73–79.
- 150 Asano, N., Kato, A., Miyauchi, M., Kizu, H., Tomimori, T., Matsui, K., Nash, R.J., Molyneux, R.J. *Eur. J. Biochem.* **1997**, *248*, 296–303.
- 151 Stenzel, O., Teuber, M., Dräger, B. *Planta* **2006**, *223*, 200–212.
- 152 Walton, N.J., McLauchlan, W.R. *Phytochemistry* **1990**, *29*, 1455–1457.
- 153 Hashimoto, T., Mitani, A., Yamada, Y. *Plant Physiol.* **1990**, *93*, 216–221.
- 154 McLauchlan, W.R., Mckee, R.A., Evans, D.M. *Planta* **1993**, *191*, 440–445.
- 155 Robins, R.J., Walton, N.J. *The Alkaloids* **1993**, *44*, 115–187.
- 156 Koelen, K.J., Gross, G.G. *Planta Med.* **1982**, *44*, 227–230.
- 157 Dräger, B., Hashimoto, T., Yamada, Y. *Agric. Biol. Chem.* **1988**, *52*, 2663–2667.
- 158 Yamada, Y., Hashimoto, T., Endo, T., Yukimune, Y., Kohno, J., Hamaguchi, N., Dräger, B. *Proc. Phytochem. Soc. Europe* **1990**, *30*, 227–242.
- 159 Hashimoto, T., Nakajima, K., Ongena, G., Yamada, Y. *Plant Physiol.* **1992**, *100*, 836–845.
- 160 Portsteffen, A., Dräger, B., Nahrstedt, A. *Phytochemistry* **1992**, *31*, 1135–1138.
- 161 Dräger, B., Schaal, A. *Phytochemistry* **1994**, *35*, 1441–1447.
- 162 Keiner, R., Kaiser, H., Nakajima, K., Hashimoto, T., Dräger, B. *Plant Mol. Biol.* **2002**, *48*, 299–308.
- 163 Portsteffen, A., Dräger, B., Nahrstedt, A. *Phytochemistry* **1994**, *37*, 391–400.
- 164 Nakajima, K., Hashimoto, T., Yamada, Y. *Proc. Natl. Acad. Sci. USA* **1993**, *90*, 9591–9595.
- 165 Jornvall, H., Persson, B., Krook, M., Atrian, S., Gonzalez, D.R., Jeffery, J., Ghosh, D. *Biochemistry* **1995**, *34*, 6003–6013.
- 166 Joshi, C.P., Chiang, V.L. *Plant Mol. Biol.* **1998**, *37*, 663–674.
- 167 Dräger, B. *Phytochemistry* **2006**, *67*, 327–337.
- 168 Nakajima, K., Yamashita, A., Akama, H., Nakatsu, T., Kato, H., Hashimoto, T., Oda, J., Yamada, Y. *Proc. Natl. Acad. Sci. USA* **1998**, *95*, 4876–4881.
- 169 Yamashita, A., Nakajima, K., Kato, H., Hashimoto, T., Yamada, Y., Oda, J., *Acta Crystallogr., Section D: Biol. Crystallogr.* **1998**, *D54*, 1405–1407.
- 170 Yamashita, A., Kato, H., Wakatsuki, S., Tomizaki, T., Nakatsu, T., Nakajima, K., Hashimoto, T., Yamada, Y., Oda, J. *Biochemistry* **1999**, *38*, 7630–7637.
- 171 Yamashita, A., Endo, M., Higashi, T., Nakatsu, T., Yamada, Y., Oda, J., Kato, H. *Biochemistry* **2003**, *42*, 5566–5573.
- 172 Ansarin, M., Woolley, J.G. *J. Nat. Prod.* **1993**, *56*, 1211–1218.
- 173 Ansarin, M., Woolley, J.G. *Phytochemistry* **1993**, *32*, 1183–1187.
- 174 Ansarin, M., Woolley, J.G. *Phytochemistry* **1994**, *35*, 935–939.
- 175 Robins, R.J., Woolley, J.G., Ansarin, M., Eagles, J., Goodfellow, B.J. *Planta* **1994**, *194*, 86–94.
- 176 Nakanishi, F., Sasaki, K., Shimomura, K. *Plant Cell Rep.* **1998**, *18*, 249–251.
- 177 Kitamura, Y., Nishimi, S., Miura, H., Kinoshita, T. *Phytochemistry* **1993**, *34*, 425–427.
- 178 Chesters, N.C.J.E., O'Hagan, D., Robins, R.J. *J. Chem. Soc., Perkin Trans. 1: Organic Bio-Org. Chem. (1972-1999)* **1994**, 1159–1162.
- 179 Chesters, N.C.J.E., O'Hagan, D., Robins, R.J. *J. Chem. Soc., Chem. Commun.* **1995**, 127–128.



- 180 Duran, P.R., O'Hagan, D., Hamilton-John, T.G., Wong, C.W. *Phytochemistry* **2000**, *53*, 777–784.
- 181 Robins, R.J., Chesters, N.C.J.E., O'Hagan, D., Parr, A.J., Walton, N.J., Woolley, J.G. *J. Chem. Soc. Perkin Trans. 1* **1995**, *4*, 481–485.
- 182 Chesters, N.C.J.E., Walker, K., O'Hagan, D., Floss, H.G. *J. Am. Chem. Soc.* **1996**, *118*, 925–926.
- 183 Zabetakis, I., Edwards, R., Hamilton, J.-T.G., O'Hagan, D. *Plant Cell Rep.* **1998**, *18*, 341–345.
- 184 Ollagnier, S., Kervio, E., Retej, J. *FEBS Lett.* **1998**, *437*, 309–312.
- 185 Patterson, S., O'Hagan, D. *Phytochemistry* **2002**, *61*, 323–329.
- 186 Hashimoto, T., Yamada, Y. *Plant Physiol.* **1986**, *81*, 619–625.
- 187 Hashimoto, T., Yamada, Y. *Eur. J. Biochem.* **1987**, *164*, 277–285.
- 188 Hashimoto, T., Kohno, J., Yamada, Y. *Plant Physiol.* **1987**, *84*, 144–147.
- 189 Hashimoto, T., Matsuda, J., Yamada, Y. *FEBS Lett.* **1993**, *329*, 35–39.
- 190 Hashimoto, T., Hayashi, A., Amano, Y., Kohno, J., Iwanari, H., Usuda, S., Yamada, Y. *J. Biol. Chem.* **1991**, *266*, 4648–4653.
- 191 Suzuki, K., Yun, D.J., Chen, X.Y., Yamada, Y., Hashimoto, T. *Plant Mol. Biol.* **1999**, *40*, 141–152.
- 192 Matsuda, J., Okabe, S., Hashimoto, T., Yamada, Y. *J. Biol. Chem.* **1991**, *266*, 9460–9464.
- 193 Yun, D.J., Hashimoto, T., Yamada, Y. *Proc. Natl. Acad. Sci. USA* **1992**, *89*, 11799–11803.
- 194 Zeef Leo, A.H., Christou, P., Leech, M.J. *Transgenic Res.* **2000**, *9*, 163–168.
- 195 Sato, F., Hashimoto, T., Hachiya, A., Tamura, K.I., Choi, K.B., Morishige, T., Fujimoto, H., Yamada, Y. *Proc. Natl. Acad. Sci. USA* **2001**, *98*, 367–372.
- 196 Moyano, E., Jouhikainen, K., Tammela, P., Palazon, J., Cusido, R.M., Pinol, M.T., Teeri, T.H., Oksman-Caldentey, K.M. *J. Exp. Bot.* **2003**, *54*, 203–211.
- 197 Saedler, R., Baldwin, I.T. *J. Exp. Bot.* **2004**, *55*, 151–157.
- 198 Steppuhn, A., Gase, K., Krock, B., Halitschke, R., Baldwin, I.T. *PLoS Biology* **2004**, *2*, 1074–1080.
- 199 Voelckel, C., Krugel, T., Gase, K., Heidrich, N., Van Dam, N.M., Winz, R., Baldwin, I.T. *Chemoecology* **2001**, *11*, 121–126.
- 200 Chintapakorn, Y., Hamill, J.D. *Plant Mol. Biol.* **2003**, *53*, 87–105.
- 201 Rocha, P., Stenzel, O., Parr, A., Walton, N., Christou, P., Dräger, B., Leech, M.J. *Plant Sci.* **2002**, *162*, 905–913.
- 202 Richter, U., Rothe, G., Fabian, A.-K., Rahfeld, B., Dräger, B. *J. Exp. Bot.* **2005**, *56*, 645–652.
- 203 Hashimoto, T., Yun, D.J., Yamada, Y. *Phytochemistry* **1993**, *32*, 713–718.
- 204 Yun, D.J., Hashimoto, T., Yamada, Y. *Biosci. Biotechnol. Biochem.* **1993**, *57*, 502–503.
- 205 Zhong, J.J. *J. Biosci. Bioeng.* **2002**, *94*, 591–599.
- 206 Jennewein, S., Croteau, R. *Appl. Microbiol. Biotechnol.* **2001**, *57*, 13–19.
- 207 Kutchan, T.M. *Alkaloids* **1998**, *50*, 257–316.
- 208 Millgate, A.G., Pogson, B.J., Wilson, I.W., Kutchan, T.M., Zenk, M.H., Gerlach, W.L., Fist, A.J., Larkin, P.J. *Nature* **2004**, *431*, 413–414.
- 209 Page, J.E. *Trends Biotechnol.* **2005**, *23*, 331–333.
- 210 Ketchum, R.E.B., Rithner, C.D., Qiu, D., Kim, Y.S., Williams, R.M., Croteau, R.B. *Phytochemistry* **2003**, *62*, 901–909.
- 211 Boswell, H.D., Dräger, B., McLauchlan, W.R., Portsteffen, A., Robins, D.J., Robins, R.J., Walton, N.J. *Phytochemistry* **1999**, *52*, 871–878.
- 212 Boswell, H.D., Dräger, B., Eagles, J., McClintock, C., Parr, A., Portsteffen, A., Robins, D.J., Robins, R.J., Walton, N.J., Wong, C. *Phytochemistry* **1999**, *52*, 855–869.
- 213 Sterner, R., Hoecker, B. *Chemical Rev.* **2005**, *105*, 4038–4055.
- 214 Oksman-Caldentey, K.M., Inze, D. *Trends Plant Sci.* **2004**, *9*, 433–440.
- 215 Dixon, R.A. *Curr. Opin. Plant Biol.* **2005**, *8*, 329–336.
- 216 Dixon, R.A. *Nature* **2001**, *411*, 843–847.
- 217 Memelink, J., Kijne, J.W., vom Endt, D. *Phytochemistry* **2002**, *61*, 107–114.
- 218 Memelink, J. *Curr. Opin. Plant Biol.* **2005**, *8*, 230–235.

- 219 Menke-Frank, L.H., Champion, A., Kijne, J.W., Memelink, J. *EMBO J.* **1999**, *18*, 4455–4463.
- 220 Memelink, J., Verpoorte, R., Kijne, J.W. *Trends Plant Sci.* **2001**, *6*, 212–219.
- 221 Borisjuk, N., Borisjuk, L., Komarnytsky, S., Timeva, S., Hemleben, V., Gleba, Y., Raskin, I. *Nature Biotechnol.* **2000**, *18*, 1303–1306.
- 222 Ziegler, J., Diaz-Cha'vez, M.L., Kramell, R., Ammer, C., Kutchan, T.M., *Planta* **2005**, *222*, 458–471.
- 223 Oksman-Caldentey, K.M., Saito, K. *Curr. Opin. Biotechnol.* **2005**, *16*, 174–179.
- 224 Haekkinen, S.T., Moyano, E., Cusido, R.M., Palazon, J., Pinol, M.T., Oksman-Caldentey, K.M. *J. Exp. Bot.* **2005**, *56*, 2611–2618.
- 225 Goossens, A., Hakkinen, S.T., Laakso, I., Oksman-Caldentey, K.M., Inze, D. *Plant Physiol.* **2003**, *131*, 1161–1164.
- 226 Yazaki, K., Shitan, N., Takamatsu, H., Ueda, K., Sato, F. *J. Exp. Bot.* **2001**, *52*, 877–879.
- 227 Yazaki, K. *Curr. Opin. Plant Biol.* **2005**, *8*, 301–307.
- 228 Shitan, N., Bazin, I., Dan, K., Obata, K., Kigawa, K., Ueda, K., Sato, F., Forestier, C., Yazaki, K. *Proc. Natl. Acad. Sci. USA* **2003**, *100*, 751–756.
- 229 Turner, G.W., Croteau, R. *Plant Physiol.* **2004**, *136*, 4215–4227.
- 230 Burlat, V., Oudin, A., Courtois, M., Rideau, M., St. Pierre B. *Plant J.* **2004**, *38*, 131–141.
- 231 Bird, D.A., Franceschi, V.R., Facchini, P.J. *Plant Cell* **2003**, *15*, 2626–2635.
- 232 Weid, M., Ziegler, J., Kutchan, T.M. *Proc. Natl. Acad. Sci. USA* **2004**, *101*, 13957–13962.
- 233 Kutchan, T.M. *Curr. Opin. Plant Biol.* **2005**, *8*, 292–300.

## 12

# Plant Cell Cultures: Production of Biologically Important Secondary Metabolites from Medicinal Plants of Taiwan

*Mulabagal Vanisree and Hsin-Sheng Tsay*

### Abstract

Plants are capable of synthesizing an overwhelming variety of organic compounds, termed “secondary metabolites”, usually with unique and complex structures. The evolving commercial importance of the secondary metabolites has during recent years resulted in great interest in secondary metabolism, and particularly in the possibility of altering the production of bioactive plant metabolites by means of cell culture technology. Advances in biotechnology, most notably in methods of culturing plant cells and tissues, have resulted in new approaches to the commercial production of rare plants and the bioactive compounds that they produce. The principal advantage of this technology is that it may provide a continuous, reliable source of plant pharmaceuticals, and could also be used for the large-scale culture of plant cells from which these metabolites can be extracted. Different strategies, using *in-vitro* systems, have been extensively studied to improve the production of biologically active secondary metabolites. This chapter focuses on the application of plant cell cultures in the production of bioactive secondary metabolites. In addition, some plant cell culture protocols for the production of important secondary metabolites from Taiwan medicinal plants are described.

### 12.1

#### Introduction

The plant kingdom provides a wide variety of natural products with diverse chemical structures and a vast array of biological activities. Over the years, many of these compounds have found applications in the health sciences such that today, medicinal plants are very important to the global economy [1], with approximately 85% of traditional medicine preparations involving the use of plant or plant extracts. Much of the traditional healthcare industry is highly dependent on wild populations to supply raw materials for the extraction of medicinally important compounds. The isolation of active compounds from plants is sometimes very difficult due to their

extremely low concentrations. Furthermore, when the raw material is scarce or its chemical production is too low, the industry – at present – lacks viable methods to produce the desired plant-derived active compounds. In addition, some active compounds are available only in endemic or extremely rare plants. Consequently, there is great interest in developing alternatives for the production of bioactive secondary metabolites of commercial importance. Biotechnological approaches such as plant cell cultures offer rapid and efficient methods for the production of these high-value medicinal compounds in cultured cells [2].

Plant tissue culture can be defined as a process whereby small pieces of living tissues explants are isolated from an organism and grown aseptically on a nutrient medium under controlled conditions. The potential of plant tissue culture techniques to produce useful secondary metabolites, especially, for drug development, were first perceived during the late 1960s. The major advantages of cell culture systems over the conventional cultivation of whole plants are:

- Useful compounds can be produced under controlled conditions independent of climatic changes or soil conditions.
- Cultured cells would be free of microbes and insects.
- The cells of any plants, whether tropical or alpine, could be easily be multiplied to yield their specific metabolites.
- Automated control of cell growth and rational regulation of metabolite processes would contribute to reductions in labor costs and improvements in productivity.
- Organic substances are easily extractable from callus cultures.

It should be possible to achieve the synthesis of a broad spectrum of secondary metabolites with complex chemical structures using plant tissue culture technology. In addition, the novel compounds which have not been found previously in plants or have never been synthesized chemically could also be produced by cell cultures. In this respect, many research groups demonstrated the outstanding metabolic capacities of plant cell cultures, and highlighted the variability of plant cell biosynthetic capacity. Moreover, this variability could be exploited to identify high-yielding cultures for use on an industrial scale [3–6]. Ongoing research in plant cell culture is largely focused on identifying the rate-limiting steps in biosynthetic pathways, while other approaches such as elicitation, precursor feeding, cell immobilization, *in-situ* product removal and bioreactor design have led to enhancements production. The strong and growing demand for natural, renewable products has refocused attention on in-cell culture techniques as potential routes to the production of biologically active secondary metabolites. Indeed, recent advances in molecular biology, enzymology and fermentation technology of plant cell cultures have suggested that these systems will become a viable source of important secondary metabolites.

During the past decade, many investigations into the biosynthetic capabilities of various cell cultures have been conducted by plant scientists and microbiologists worldwide. At present, advances in tissue culture, such as improvements in genetic engineering (specifically, transformation technology) have opened new avenues for the high-volume production of pharmaceuticals, nutraceuticals and other ben-

eficial substances [7]. This chapter will focus on the importance of cell culture methods in the production of some of these biologically active secondary metabolites. In addition, some interesting cell culture protocols used to produce biologically important secondary metabolites from Taiwan medicinal plants are outlined.

## 12.2

### Cell Culture Protocols for Biologically Important Secondary Metabolites

Cell cultures are preferred for large-scale production processes, due mainly to the rapid cell growth cycles that permit the generation of large quantities of cells. This is then coupled to quantitative and/or qualitative analyses of growth responses and the metabolism of novel chemicals. Studies on the growth, development and metabolism of plant cells have provided – and continue to provide – a better understanding of plant cell biology and tissue physiology, and this in turn generates the impetus for bioprocess design. The main goals of plant cell process development are to achieve a high product concentration, high productivity, and high product yields using novel biosynthetic approaches. Consequently, during the past few years a vast number of applied research investigations have been conducted to improve the commercial applications of plant cell culture techniques.

The longstanding, classic examples of commercially viable productions of secondary metabolites in cell culture include shikonin production by cell suspension cultures of *Lithospermum erythrorhizon*, berberin production by cell cultures of *Coptis japonica*, rosmarinic acid production by cell cultures of *Coleus bluemii*, and ginsenosides from *Panax ginseng*. More recently, research groups have aimed at developing new strategies for streamlining the critical bioprocesses to produce antitumor compounds such as paclitaxel (Taxol) from *Taxus* species, podophyllotoxin from *Podophyllum peltatum*, camptothecin from *Camptotheca acuminata*, and vinblastine and vincristine from *Catharanthus roseus*.

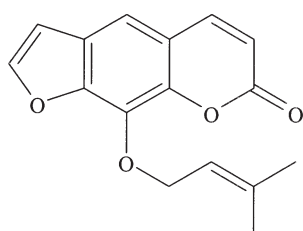
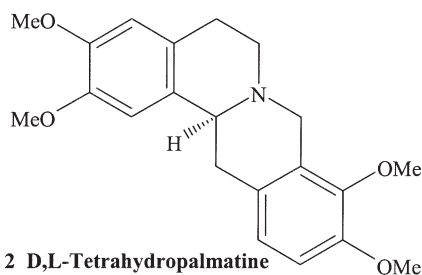
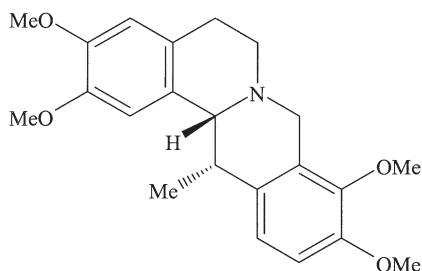
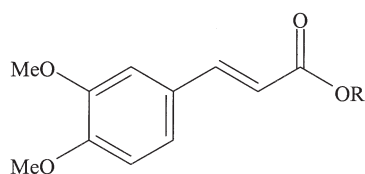
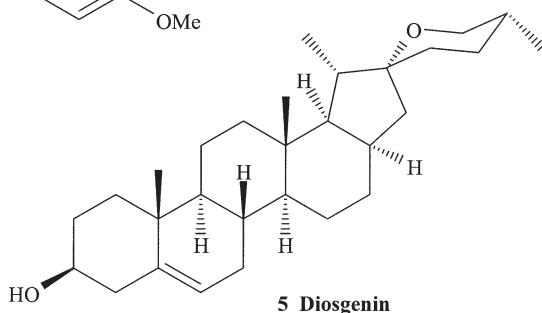
Recently, plant cell cultures have become the focal point of procedures to produce interesting bioactive secondary metabolites from the medicinal plants of Taiwan. As a country, Taiwan is situated in the tropic and subtropic zones, but also possesses a temperate zone based on the ecological systems of its high mountains. Taiwan's abundant botanical resources have provided the country with a reputation as a natural botanical garden. Indeed, surveys have shown that almost 7000 species of vascular plants grow in Taiwan, including at least 4477 native species and approximately 2500 introduced species. More importantly, many of these plants have medicinal uses. Based on the initial exciting findings for the production of medicinal compounds using cell cultures, an array of research investigations have been undertaken in the area of plant cell, tissue and organ cultures to produce valuable medicinal compounds from traditional medicinal plants collected in Taiwan. As a part of this program, we have successfully established cell culture methods to produce imperatorin from *Angelica dahurica*, corydaline and tetrahydropalmatine from *in-vitro*-grown tubers of *Corydalis yanhusuo*, alkyl ferulates from *Dendrobium tosaense*, diosgenin from *Dioscorea doryophora*, gentipicro-

side and swertiamarin from *Gentiana*, anthraquinones from *Polygonum multiflorum*, cryptotanshinone from *Salvia miltiorrhiza*, harpagoside from *Scrophularia yoshimurae*, anthocyanins from *Solanum melongena*, and paclitaxel from *Taxus mairei*.

## 12.2.1

**Production of Imperatorin from *Angelica dahurica* var. *formosana***

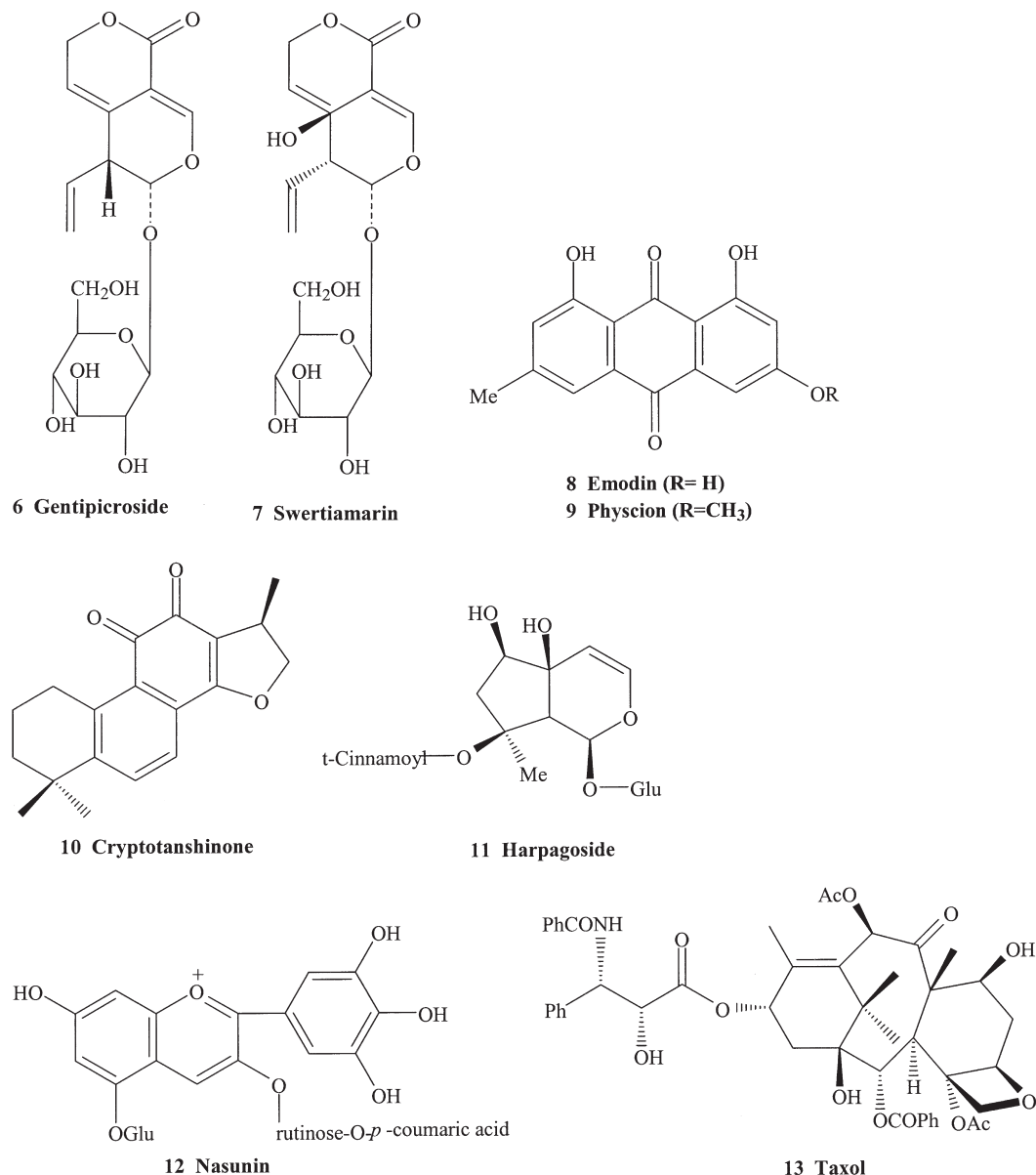
*Angelica dahurica* var. *formosana*, commonly known as “Bai-Zhi” in Chinese, is a valuable medicinal herb used to treat headache and psoriasis in China [8]. The constituent imperatorin (1) is the major active ingredient for curing the skin disease [9]. *A. dahurica* is a perennial and indigenous plant in Taiwan [10], but cannot be grown in sufficient quantities using conventional cultural methods to meet demands. Consequently, cell suspension culture methods to produce imperatorin became imperative. In order to establish a rapidly growing and finely dispersed cell suspension culture, the best medium composition was half-strength Murashige and Skoog (MS) medium [11] supplemented with 1 mg L<sup>-1</sup> 2,4-dichlorophenoxy-

**1 Imperatorin****2 D,L-Tetrahydropalmatine****3 D-Corydaline****4 Alkyl ferulates (R=C<sub>n</sub>H<sub>2n+1</sub>; n=24,25)****5 Diosgenin**

Structures 1–5

acetic acid (2,4-D), 0.1 mg L<sup>-1</sup> kinetin, and 3% sucrose. All cultures were routinely subcultured at an interval of 14 days.

In a growth cycle of the suspension cells, imperatorin production was maximal between 10 and 14 days. Growth conditions, especially with regard to nutritional factors optimal for imperatorin production, were also investigated. The MS basal



Structures 6–13

medium was found to provide the best cell growth, whilst deletion of auxins from the medium improved imperatorin production. Likewise, the addition of benzyladenine (BA) ( $0.5\text{--}1\text{ mg L}^{-1}$ ) promoted imperatorin synthesis in the cell suspension.

A moderate ammonium nitrate:nitrate ratio (2:1) in the medium led to increased imperatorin production, as did an increased phosphate concentration (from 1 to 2 mM). Glucose was found to be better carbon source than either sucrose or fructose in terms of imperatorin production. When studying possible stimulatory effects of elicitors on imperatorin synthesis, vanadyl sulfate added to cell suspension cultures ( $30\text{ mg L}^{-1}$  on day 10) led to significant increases in imperatorin production, but this was also partly dependent upon the growth stage of the cells. Addition of the adsorbent Amberlite XAD-7 ( $20\text{ g L}^{-1}$ ) to suspension cells on day 10 of culture led to a rapid and drastic (140-fold compared to control culture;  $460\text{ }\mu\text{g g}^{-1}$  dry wt) increase in imperatorin synthesis [12, 13]. Thus, the cultured cells clearly possessed the biosynthetic potential of the intact plants from which they were derived. Moreover, such potential could be further facilitated by the addition of stimulants to the culture medium.

#### 12.2.2

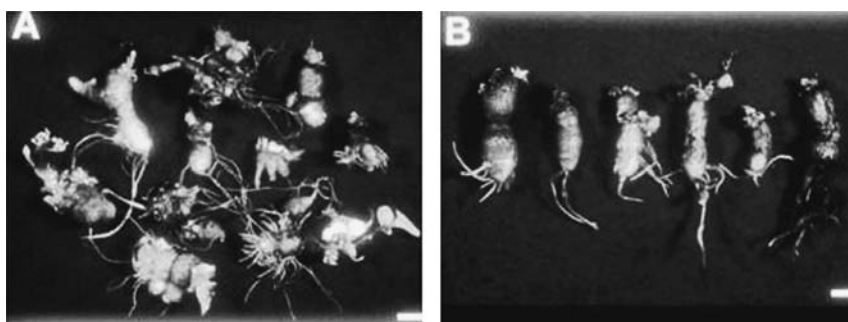
#### **Production and Analysis of Corydaline and Tetrahydropalmatine from *Corydalis yanhusuo***

The genus *Corydalis* (Fumariaceae or Papaveraceae) comprises approximately 320 species, widely distributed in the northern hemisphere. Of these species, about 70 have been used in traditional herbal remedies in China, Japan, and Korea [14]. The dried and pulverized tubers of *Corydalis yanhusuo*, also known as *Rhizoma corydalis* or yan-hu-suo are a rich source of several pharmacologically important alkaloids [15]. These are used in traditional Chinese medicine to treat gastric and duodenal ulcers, cardiac arrhythmia [14], rheumatism, and dysmenorrhea [16]. *C. yanhusuo* is a slow-growing herb which is susceptible to fungal diseases that cause serious crop losses and also affects the quality of the tubers. In order to achieve high productivity, homogeneity and good tuber quality, it is necessary to obtain pathogen-free planting material [17]. Clearly, plant regeneration via *in-vitro* culture of *C. yanhusuo* would be useful for the mass propagation of this important medicinal plant over a short time period.

A protocol for complete plant regeneration via somatic embryogenesis from tuber-derived callus, and the production of bioactive compounds such as D,L-tetrahydropalmatine (2) and D-corydaline (3) from the tubers of somatic embryo-derived plants has been standardized in our laboratory [18]. Primary callus was induced by culturing mature tuber pieces on a medium supplemented with  $2.0\text{ mg L}^{-1}$  BA and  $0.5\text{ mg L}^{-1}$   $\alpha$ -naphthalene acetic acid (NAA) in darkness. Somatic embryos were induced by subculturing the primary callus on medium supplemented with various concentrations of cytokinins, within two weeks of culture in light. The converted somatic embryos of *C. yanhusuo* were cultured for one month on different treatments (growth regulators) in order to promote tuberization and to assess their effect on the accumulation of protoberberine alkaloids. Somatic embryo-derived



plants were also maintained individually on  $0.1 \text{ mg L}^{-1}$  GA<sub>3</sub> and  $0.5 \text{ mg L}^{-1}$  paclobutrazol for six months to ascertain the effect of age on alkaloid accumulation. Figure 12.1 illustrates well-developed tubers formed after six months of growth on medium containing  $0.1 \text{ mg L}^{-1}$  GA<sub>3</sub> (Fig. 12.1A) and  $0.5 \text{ mg L}^{-1}$  paclobutrazol (Fig. 12.1B). After one and six months of culture in different treatments, the tuber alkaloid contents were analyzed using high-performance liquid chromatography (HPLC). Somatic embryos cultured on  $0.1 \text{ mg L}^{-1}$  GA<sub>3</sub> for six months were found to contain high concentrations of both D,L-tetrahydropalmatine and D-corydalin in the tubers. The highest content of corydalin was ca.  $3.8 \text{ mg g}^{-1}$  dry weight after six months' culture on  $0.5 \text{ mg L}^{-1}$  paclobutrazol. Supplementation of an amino acid precursor such as tyrosine [19] to the culture medium may further improve the production of these compounds.



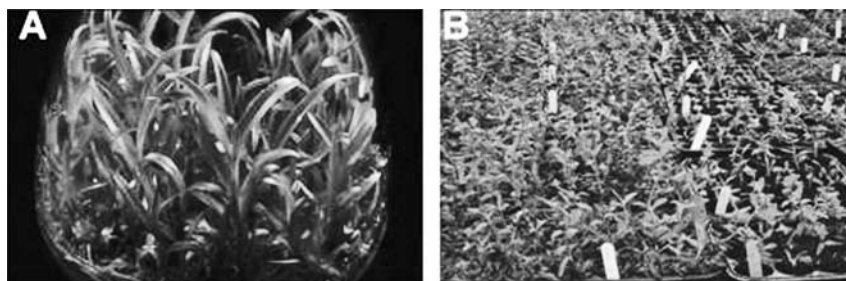
**Fig. 12.1** Somatic embryo-derived tubers of *Corydalis yanhusuo* formed after 6 months of culture on: (A) half-strength MS medium supplemented with  $0.1 \text{ mg L}^{-1}$  GA<sub>3</sub>; and (B) half-strength MS medium supplemented with  $0.51 \text{ mg L}^{-1}$  paclobutrazol. (Scale bars: A = 9.17 mm; B = 6.31 mm.)  
Note: A color version of this figure is available in the color plate section.

### 12.2.3

#### Identification of Alkyl Ferulates in Micropropagated Plants of *Dendrobium tosaense* MAKINO

*Dendrobium* is the second largest genus in the entire family Orchidaceae, and exhibits a vast diversity in vegetative and floral characteristics. The genus is of considerable interest due to its broad geographic distribution and high value of hybrids as a floricultural commodity [20,21]. The stems of *Dendrobium* species, also known as Shih-hu (Japanese: sekkoku; English: *Dendrobium* stem), are used in traditional Chinese medicine as a tonic to improve the digestion and to promote the production of body fluid, nourishing “yin” and eliminating “evil-heat” [22]. “Shih” means rock, while “hu” means living; this signifies the plant living on rocks, referring to the saxicolous habit of the species [23]. *Dendrobium* was first recorded in Shen-Nung-Ben-Cao-Jing (the earliest Chinese medicine herbs book, published more than 1900 years) under the “Inferior Category”, and was also recorded in the successive Pen-ts’ao of the subsequent dynasties.

Due to the destruction of habitat, ruinous harvesting practices, and over-harvesting for commercial purposes in tropical countries, the population of orchids is steadily declining such that today, *in-vitro* methods are being used to conserve and propagate these medicinally important orchids. The present authors established an efficient [24] method for the propagation of *Dendrobium tosaense* plants via asymbiotic germination of seeds pollination germinated after being cultured on full-strength or half-strength MS medium devoid of plant growth regulators and with 3% sucrose. Germinated seedlings after transfer to MS medium with 1.5% sucrose and 8% banana homogenate or potato homogenate or coconut water and 20 weeks' incubation developed into healthy plantlets (Fig. 12.2A). These well-developed plantlets were transplanted to moss or moss and tree fern or tree fern as substrates in plastic trays, and then transferred to a greenhouse for hardening (Fig. 12.2B). Plants grown in the greenhouse for a period of six months were extracted with methanol and evaluated for their antioxidant activity using the 1,1-diphenyl 2-picrylhydrazyl radical (DPPH) assay. *D. tosaense* scavenged DPPH 95.9%, at a concentration of 0.4 mg mL<sup>-1</sup>. The methanol extract was fractionated further and the fractions evaluated for antioxidant activities. The active fractions were purified further through bioguided purification using column chromatography, which resulted in identification of antioxidant components, alkyl ferulates (4) from *D. tosaense* [25].



**Fig. 12.2** Asymbiotic seed germination and *ex-vitro* establishment of plants of *Dendrobium tosaense*. (A) Optimum seedling growth after 5 months on MS basal medium + 8% banana homogenate + 1.5% sucrose. (B) Hardened plants after 6 months in the greenhouse. (Scale bars: A = 0.82 cm; B = 6 cm.)  
Note: A color version of this figure is available in the color plate section.

#### 12.2.4

#### **Production of Diosgenin from *Dioscorea doryophora* by Cell Suspension Cultures**

*Dioscorea* spp. (Dioscoreaceae) is frequently used as a tonic in Chinese traditional medicine. The tubers of *Dioscorea doryophora* are in great demand as they are used not only as a crude drug but also as a food. The most active ingredient found in the tuber is diosgenin, which can be used as a precursor for many important medicinal steroids such as prednisolone, dexamethasone, norethisterone, and metenolone [26].

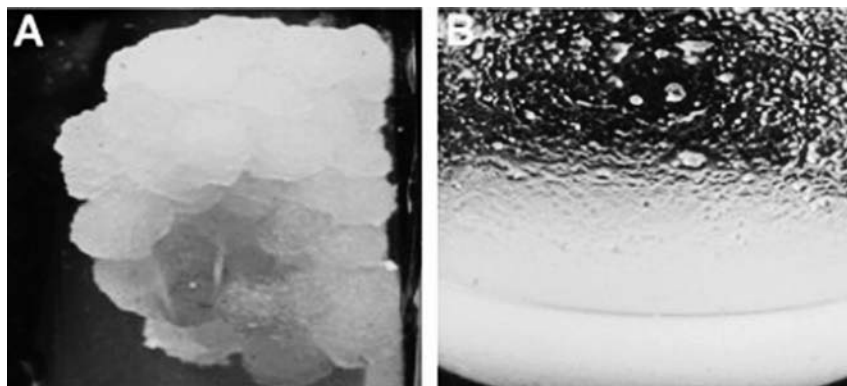
In order to increase the diosgenin yield and to facilitate the purification process, we have established a cell suspension culture of *D. doryophora* [27]. Cell suspension cultures were obtained from microtuber and stem node-derived callus in liquid culture medium supplemented with 0.1 mg L<sup>-1</sup> 2,4-D, 3% sucrose, and incubated on a rotary shaker at 120 rpm. Although 6% sucrose was found to be optimum for the growth of cell suspension culture, cells cultured in 3% sucrose-containing medium produced higher level of diosgenin (5). Analysis by HPLC revealed that both stem-node and microtuber-derived suspension cells contained diosgenin. The content of microtuber-derived cell suspension culture contained 3.2% diosgenin per gram dry weight, whereas, the stem-node-derived cultures contained only 0.3%. As the amount of diosgenin obtained from tuber-derived cell suspension was high and comparable with that found in the intact tuber [28], cell suspension culture could be used for production of diosgenin.

#### 12.2.5

#### **Establishment of *Gentiana davidii* var. *formosana* (Hayata) T. N. Ho Cell Suspension Cultures**

The genus *Gentiana* (Gentianaceae) comprises about 400 species distributed worldwide [29]. The bitter principles of Gentianaceae constitute many pharmacologically important compounds, which justifies the use of most species of this family in traditional medicine or for the preparation of bitter tonics [30]. In Taiwan, 11 species and two varieties of the genus *Gentiana* have been identified [31]. Among the species in Taiwan, *Gentiana davidii* var. *formosana* is the most widespread, ranging from low to high elevation throughout the central mountain range of the island. The whole dried herb, collected from the wild habitat, is used as a crude drug in traditional medicine in Taiwan. However, the plant is fully protected by law in Taiwan, and collection of plants from the wild habitat is illegal. In spite of its importance, a general method for commercial cultivation has not been reported for *G. davidii*. A cell suspension culture might represent a more suitable alternative to the pharmaceutical industry for obtaining the important bioactive compounds.

We have optimized the conditions for establishment of cell suspension cultures of *G. davidii* for the production of gentipicroside (6) and swertiamarin (7), the two pharmacologically important compounds. The influence of factors such as plant growth regulator addition, shaker speed, light intensity, medium pH and incubation period on growth of *G. davidii* cells in suspension cultures were also studied [32]. The callus cultures were initiated by culturing the stem internode explants in the dark for six weeks at 25 ± 1 °C on MS basal medium containing 0.2 mg L<sup>-1</sup> kinetin and 1.0 mg L<sup>-1</sup> NAA (Fig. 12.3A). Cell suspension cultures were established using the stem-derived callus (Fig. 12.3B). Among the various concentrations of 2,4-D, NAA, β-indole acetic acid (IAA) and kinetin tested, optimal cell growth was obtained when the callus was cultured in 25 mL of liquid MS basal medium supplemented with 0.2 mg L<sup>-1</sup> kinetin and 3% sucrose. The cultures were rotated at 80–100 rpm at 25 ± 1 °C and low light intensity of 2.33 μE m<sup>-2</sup> s<sup>-1</sup>. The cells increased in size and turned brown when the cultures were rotated below 60 rpm,



**Fig. 12.3** (A) Induction of *Gentiana* callus from stem segments cultured on MS basal medium with 3% sucrose,  $1 \text{ mg L}^{-1}$   $\alpha$ -naphthalene acetic acid (NAA), and  $0.2 \text{ mg L}^{-1}$  kinetin for 8 weeks. (B) Established suspension cultures from the stem-derived cells. Note: A color version of this figure is available in the color plate section.

and the cell sizes were small when the shaker speed was 120 rpm. Cultures incubated under either higher light intensity or darkness showed a slower growth rate. Optimal cell growth was obtained when callus cultured in 25 mL liquid MS basal medium supplemented with  $0.2 \text{ mg L}^{-1}$  kinetin and 3% sucrose, pH 4.2–5.2, incubated in light  $2.33 \mu\text{E m}^{-2} \text{ s}^{-1}$  at  $25 \pm 1 \text{ }^\circ\text{C}$ , at 80–100 rpm shaker speed. In the suspension cultures, maximum content of gentiopicroside was observed in 24-day-old cultures, while the highest content of swertiamarin was obtained in 12-day-old cultures. The final developed system will be of assistance in studying the effects of precursor feeding on the content of active principles.

#### 12.2.6

#### **Quantitative Analysis of Anthraquinones Emodin and Physcion formed in *In-Vitro*-Propagated Shoots and Plants of *Polygonum multiflorum***

*Polygonum multiflorum*, a perennial vine-like herb, is one of the most important and widely used Chinese medicinal herbs of the family Polygonaceae. The vine is known as *Ye-Jiao* and the root tubers *Ho-shou-wu*, which is used as tonic and in many Chinese medicines [33,34]. Ethnopharmacologically, it is a tonic for anemia, neurasthenia, and hypercholesterolemia, and is used clinically to treat coronary heart disease, hyperlipidemia, neurosis, and other diseases commonly associated with aging.

An efficient and rapid protocol for the *in-vitro* induction and complete plant regeneration of *P. multiflorum* has been developed [35]. Nodal explants were grown *in vitro* on MS basal medium containing different concentrations of NAA and BA. Maximum multiplication of shoots (97%) was obtained on a medium supplemented with  $0.2 \text{ mg L}^{-1}$  NAA and  $2.0 \text{ mg L}^{-1}$  BA after six weeks of culture (Fig. 12.4A–L). However, between 88% and 100% of shoots (1.0 cm in length) elongated



**Fig. 12.4** Induction and multiplication of multiple shoots in the nodal explants of *Polygonum multiflorum* Thunb. Nodal explants cultured for 6 weeks on MS basal medium with 3% sucrose, 1% Difco agar, without growth regulators. (A) With 0.2 ng L<sup>-1</sup>  $\alpha$ -naphthalene acetic acid (NAA); (B) 0.2 ng L<sup>-1</sup> NAA and 0.5 mg L<sup>-1</sup> benzyladenine (BA); (C) 0.2 ng L<sup>-1</sup> NAA and 1.0 mg L<sup>-1</sup> BA; (D) 0.2 ng L<sup>-1</sup> NAA and 2.0 mg L<sup>-1</sup> BA; (E) 0.2 ng L<sup>-1</sup> NAA and 4.0 mg L<sup>-1</sup> BA; (F) 0.2 ng L<sup>-1</sup> NAA and

8.0 mg L<sup>-1</sup> BA; (G) 0.5 ng L<sup>-1</sup> NAA and 2.0 mg L<sup>-1</sup> BA; (H) 1.0 ng L<sup>-1</sup> NAA and 2.0 mg L<sup>-1</sup> BA; (I) 2.0 ng L<sup>-1</sup> NAA and 2.0 mg L<sup>-1</sup> BA; (J) 4.0 ng L<sup>-1</sup> NAA and 2.0 mg L<sup>-1</sup> BA; (K) 8.0 ng L<sup>-1</sup> NAA and 2.0 mg L<sup>-1</sup> BA; (L) *in-vitro*-propagated plantlets transferred to autoclaved soil and grown under greenhouse conditions with high humidity, after 2 weeks (M) and after 3 months (N). Note: A color version of this figure is available in the color plate section.

(ca. 3.02–4.28 cm) and rooted on MS basal medium supplemented with NAA or indole-3-butyric acid (IBA). All rooted shoots were transferred to pots containing autoclaved soil, vermiculite and peat moss (1:1:1). The plantlets were successfully acclimatized under greenhouse conditions with high humidity before being transferred to the field (Fig. 12.4M,N). The presence of the anthraquinones, emodin (8) and physcion (9), in *in-vitro*-grown shoots and plants grown in the greenhouse were determined using HPLC. Analysis showed that concentrations of the major medicinal compounds (emodin and physcion) in the six-week *in-vitro*-grown shoots and three-month-old *in-vitro*-propagated plants grown in the greenhouse were greater than those of the marketed crude drug (processed underground or in the stem parts of *P. multiflorum*). These results indicate that, under defined cultural conditions, it is possible to produce shoots with a high emodin and physcion content within a short period (six weeks), and that these compounds could be used for pharmacological evaluation.

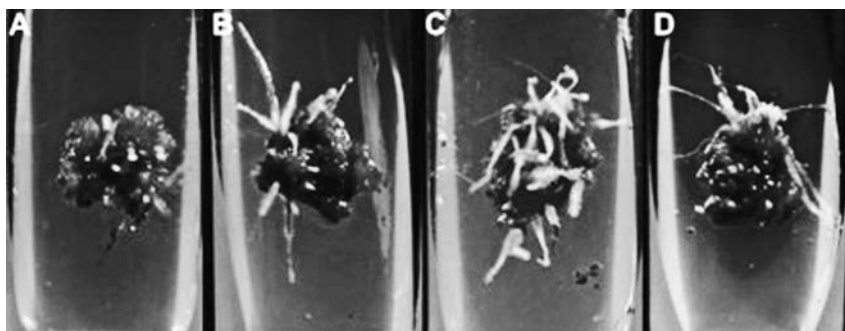
### 12.2.7

#### Production of Cryptotanshinone from Callus Cultures of *Salvia miltiorrhiza* Bunge

*Salvia* is an important genus consisting of approximately 900 species within the family Lamiaceae. Some species of *Salvia* have been cultivated worldwide for use in folk medicine. For example, Dan-shen, the dried roots of *Salvia miltiorrhiza* Bunge, is a very popular Chinese medicines that is widely used to promote blood circulation, to remove blood stasis, to relieve pyrexia and vexation, nourish the blood, tranquilize the mind, and cool the blood for relief of carbuncles [36]. The major active principles of the organic extract of Dan-shen are tanshinones, the quinoid diterpenes [38]. Since Dan-shen preparations constitute a basis for considerable commercial activity, there is continued interest in the biotechnology-based production of tanshinones [37–40]. In our continuing investigations into the use of tissue cultures of medicinal plants to produce bioactive secondary metabolites, we have developed a method to produce cryptotanshinone from *S. miltiorrhiza* through callus cultures.

The effect of BA on cryptotanshinone formation by *Salvia miltiorrhiza* was examined using a primary callus. This was induced by culturing leaf explants on MS basal medium supplemented with 1.0 mg L<sup>-1</sup> 2,4-D, in darkness. The callus proliferated further on MS basal medium containing 1.0 mg L<sup>-1</sup> 2,4-D and 0.5 mg L<sup>-1</sup> BA, and was found (by HPLC analysis) to contain small amounts (0.26 ± 0.05 mg g<sup>-1</sup> dry wt) of cryptotanshinone (10). The omission of 2,4-D from the medium resulted in a marked increase in callus cryptotanshinone content. During the culture period the callus acquired a deep red color (Fig. 12.5). HPLC analyses showed the cryptotanshinone content of callus cultured on MS basal medium supplemented with 0.1, 0.2, 0.5, 1.0, and 2.0 mg L<sup>-1</sup> BA to be significantly higher than that of the marketed crude drug (processed from underground portions of *S. miltiorrhiza*). The maximum yield of cryptotanshinone (4.59 ± 0.09 mg g<sup>-1</sup> dry wt.) was observed in the callus cultured on MS basal medium supplemented with 0.2 mg L<sup>-1</sup> BA for 60 days [41].





**Fig. 12.5** *Salvia* callus grown on MS basal medium supplemented with  $0.2 \text{ mg L}^{-1}$  benzyladenine (BA) for periods of: (A) 8 days; (B) 16 days; (C) 24 days; and (D) 60 days. Note: A color version of this figure is available in the color plate section.

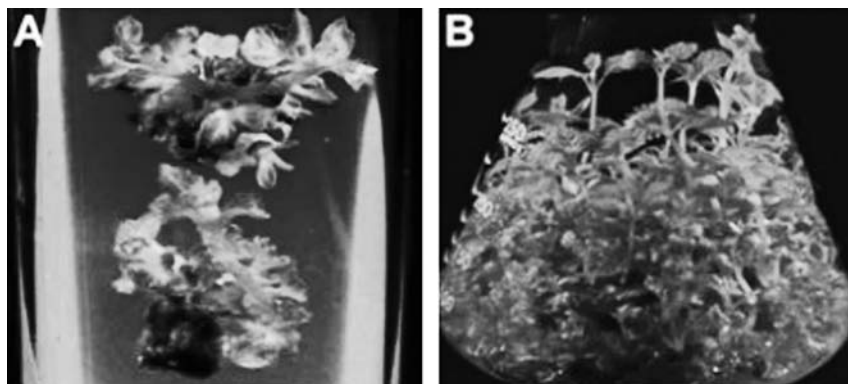
### 12.2.8

#### **Harpagoside Production in Micropropagated Plants of *Scrophularia yoshimurae* Yamazaki**

*Scrophularia yoshimurae* (Scrophulariaceae) is an indigenous herbaceous perennial plant of Taiwan, and is a substitute for *S. ningpoensis* in traditional Chinese medicine. The roots of *S. ningpoensis* have been used to treat inflammation, laryngitis, tonsillitis, abscesses of carbuncles and constipation [42]. Moreover, it can lower blood pressure and blood sugar levels, has antibacterial and antioxidant effects, and is normally used in combinations with other herbs as nutrient and health-strengthening agents. The roots contains iridoid glycosides (the active principles) in addition to small amounts of essential oils, alkaloids, flavanoids, and *p*-methoxycinnamic acid. For the crude drug, the roots of *S. yoshimurae* are collected from plants growing naturally in the mountains of Taiwan. Correct cultivation of the plant is needed, as the supply is insufficient to meet the local drug demand. In order to aid the commercial cultivation and conserve the germplasm of this medicinally important species, a rapid *in-vitro* propagation system for *S. yoshimurae* has been developed. Herein, we describe the tissue culture protocol of *S. yoshimurae* standardized in our laboratory [43, 44].

In order to obtain the healthy explants for *in-vitro* organogenesis, plants were collected from the natural habitat and grown under controlled hygienic conditions. Various explants, such as the shoot tip, leaf base, node and internode taken from the actively growing shoots of these plants, were tested for induction of the morphogenetic response. Multiple shoots were induced not only from the pre-existing meristems of shoot tip and stem node explants, but also directly from the cut end of the internode and leaf-base explants without an intervening callus phase in a one-month culture on MS basal medium supplemented with  $4.44 \text{ }\mu\text{M}$  BA and  $1.07 \text{ }\mu\text{M}$  NAA. All stem node and shoot tip explants induced multiple shoots, whereas the leaf-base explants were least responsive. Figure 12.6A shows the in-

duction of multiple shoots from the internode explants of *S. yoshimurae*. The induced shoots were further proliferated by subculturing them in the fresh medium of similar composition (Fig. 12.6B). The micropropagated shoots were elongated and rooted by subculturing on growth regulator-free MS basal medium. The plantlets were transplanted to soil and acclimatized in the growth chamber under high humidity conditions. The cultures could be maintained for over two years without losing their morphogenetic potential. The content of harpagoside (11), a quantitatively predominant iridoid glycoside, in different plant materials was determined by HPLC. Analysis showed the content of harpagoside in the aerial and underground parts of *S. yoshimurae* to be significantly higher than the marketed crude drug. In order to extract the secondary metabolites and to conduct pharmacological studies, it is necessary to have plants of high quality and with uniform content of active principles. Genetically homogeneous plants with uniform content of secondary metabolites could be obtained by *in-vitro* propagation of selected, elite plants. *In-vitro*-propagated plants of many species showed less variation in the content of secondary metabolites than their wild/cultivated counterparts [45]. The protocol obtained could be also used for rapid micropropagation, commercial cultivation, and germplasm conservation of this medicinal plant.



**Fig. 12.6** (A) Induction of multiple shoots from the internode explants of *Scrophularia yoshimurae*. (B) Shoot proliferation from the node explants. Note: A color version of this figure is available in the color plate section.

### 12.2.9

#### **Production of Anthocyanins in Callus Cultures of *Solanum melongena***

*Solanum melongena*, popularly known as “egg plant”, belongs to the family Solanaceae, and is an important vegetable crop that plays an inevitable role in many diets worldwide. The fluid obtained from the macerated roots is used to treat asthma and syphilis, the juice obtained from the fruits is used to treat certain liver ailments [46, 47], while the leaves and stem bark are used to combat dysentery [48]. The ability of eggplant to regenerate in tissue culture has allowed the application of biotechnology, particularly the exploitation of somaclonal variation, haploidy, somatic



hybridization, and genetic transformation [49]. Several anthocyanin isolates from *S. melongena* are reported to possess antioxidant activity.

An efficient method for callus cultures of *S. melongena* was established [50] by culturing pericarp tissues on MS medium supplemented with 5.4  $\mu\text{M}$  NAA and 2.3  $\mu\text{M}$  kinetin. Two major anthocyanins, nasunin (12) and *cis*-coumaroyl isomer of nasunin were detected (by HPLC) in pericarp-derived callus.

#### 12.2.10

#### Taxol Synthesis in Cell Suspension Cultures of *Taxus mairei*

Wani and colleagues discovered a novel anticancer diterpene amide, “taxol” (13) from an extract of the Pacific yew (*Taxus brevifolia*) [51]. Taxol has subsequently been approved for the clinical treatment of ovarian and breast cancer by the FDA, and also shows significant therapeutic activity against malignant melanoma, lung cancer, and other solid tumors [52,53]. Consequently, taxol is considered as the prototype of a new class of cancer chemotherapeutic agents [54].

The supply of taxol for clinical use is limited, however, because it is extracted from yew trees, the bark of which represents the only commercial source. The thin bark of the yew tree contains 0.001% of taxol by dry weight basis; hence, a 100-year-old tree yields on average 3 kg of bark, corresponding to 300 mg of taxol, which is approximately a single dose during the course of a cancer treatment. Because of the scarcity of the slow-growing trees and the relatively low content of taxol, alternative sources are needed to meet the increasing demand for the drug. The total synthesis of taxol on an industrial scale seems economically unrealistic due to the complexity of the chemical structure of this molecule [55, 56]. Thus, plant cell culture of *Taxus* spp. is considered to be one approach available to provide a stable supply of taxol and related taxane derivatives [57].

In order to exploit the source of taxol, different tissues of *Taxus mairei*, a species found in Taiwan at an altitude of about 2000 m above sea level, were collected. The extracts of bark and leaf tissues were analyzed using HPLC to determine the contents of taxol and taxol-related compounds. The analysis showed the amounts of these compounds to vary among individual plants, with the contents of the principal components such as docetaxel, baccatin III and 10-deacetyl baccatin in leaf extracts being higher than those in bark extracts [58]. *T. mairei* calli were induced from needle and stem explants on B5 medium [59] supplemented with 2 mg L<sup>-1</sup> 2,4-D or NAA. Different cell lines were established using stem- and needle-derived callus. One of the cell lines, after precursor feeding and a six-week incubation period, produced 200 mg L<sup>-1</sup> of taxol in cell suspension cultures [58].

### 12.3

#### Conclusions and Future Perspectives

The advantages of plant cell cultures when producing chemicals and pharmaceuticals have led to major advances in the plant sciences. In future, these technologies will serve to enhance the continued value of higher plants as renewable resources

of chemicals, and especially of medicinal compounds. The increased use of genetic tools, combined with an emerging picture of the structure and regulation of pathways for secondary metabolism, will provide the basis for the production of commercially acceptable quantities of these products. Today, knowledge of biosynthetic pathways of desired compounds in plants as well as in cell cultures is generally in its infancy, and consequently strategies are needed to develop information based on the cellular and molecular levels. Because of the complex and incompletely understood nature of plant cells in *in-vitro* cultures, case-by-case studies have been used to explain the problems occurring in the production of secondary metabolites from cultured plant cells. The introduction of molecular biology techniques, in order to produce transgenic cultures and effect the expression and regulation of biosynthetic pathways, is also likely to be a significant step towards making cell cultures more generally applicable to the commercial production of secondary metabolites. One key in developing and evaluating strategies to improve productivity is the realization that all such problems must be seen in an holistic context. In conclusion, it is possible to achieve controllable and successful biotechnological production of specific, valuable – and as yet unknown – phytochemicals by using a combination of plant cell, tissue and organ culture technologies and metabolic engineering.

## References

- 1 Srivastava, J., Lambert, J., Vietmeyer, N. Medicinal Plants: An Expanding Role in Development, World Bank Technical Paper No. 320. World Bank Agriculture and Forestry Systems, Washington, DC, USA, 1995.
- 2 Oksman-Caldentey, KM., Inze, D. Plant cell factories in the post-genomic era: new ways to produce designer secondary metabolites. *Trends Plant Sci.* **2004**, 9, 433–440.
- 3 Tabata, M., Mizukami, H., Hiraoka, N., Konoshima, M. The production and regulation of shikonin derivatives in cultured cells. In: 12th Phytochemistry Symposium, Kyoto, Japan, 1976, pp. 1–8.
- 4 Bisaria, V., Panda, A. Large-scale plant cell cultures; methods, applications and products. *Curr. Opin. Biotechnol.* **1991**, 2, 370–374.
- 5 Yamada, Y. Selection of cell lines for high yields of secondary metabolites. In: *Cell Culture and Somatic Cell Genetics of Plants*. Volume 1. Academic Press, New York, 1984, pp. 629–636.
- 6 Benjamin, B.D., Sipahimalani, A.T., Heble, M.R., Chadha, M.S. In: *International Congress on Plant Tissue and Cell Culture*. University of Minneapolis, Minnesota, USA, 1986, p. 249.
- 7 Hansen, G., Wright, M.S. Recent advances in the transformation of plants. *Trends Plant Sci.* **1999**, 4, 226–231.
- 8 Zhou, G.M. Studies on useful compounds of Bai-Zhi for healing Yin-Hsieh Ping. *Chung-Chen-Yau Res.* **1980**, 4, 33 (in Chinese).
- 9 Zhou, G.M., Yu, C.G., Han, Y.C., Mun, C.T. Studies on Bai-Zhi. IV. The toxicity test of useful compounds. *Med. J. China Hospital* **1988**, 8, 220–221 (in Chinese).
- 10 Chen, C.C., Chang, W.T., Chang, Y.S., Tsay, H.S. Studies on the tissue culture of *Angelica dahurica* var. *formosana* II. Establishment of cell suspension culture and evaluation of cultural conditions. *J. Chinese Med.* **1994**, 5, 123–134 (in Chinese).
- 11 Murashige, T., Skoog, F. A revised medium for rapid growth and bioassays with tobacco tissue cultures. *Physiol. Plantarum* **1962**, 15, 473–497.
- 12 Tsay, H.S., Chang, W.D., Chen, C.C., Chang, Y.S. The production of

- imperatorin from *Angelica dahurica* var. *formosana* by cell suspension culture. *J. Agric. Assoc. China* **1994**, 168, 32–48.
- 13 Tsay, H.S. Tissue culture technology of medicinal herbs and its application in medicinal herbs and its application in Taiwan. In: Chou, C.H., Waller, G.R., Reinhardt, C. (Eds.), *Biodiversity and Allelopathy: From Organisms to Ecosystems in The Pacific*. Academia Sinica, Taipei, Taiwan, **1999**, pp. 137–144.
- 14 Kamigauchi, M., Iwasa, K. *Corydalis* spp.: *In vitro* culture and the biotransformation of protoberberines. In: Bajaj, Y.P.S. (Ed.), *Biotechnology in Agriculture and Forestry, Volume 26*. Springer-Verlag, Berlin, Heidelberg, **1995**, pp. 93–105.
- 15 Huang, K.C. Yan Hu Suo – The dried tuber of *Corydalis turtschaninowii* Bess f. *yanhusuo* (Papaveraceae). In: *The Pharmacology of Chinese Herbs*. CRC Press, Boca Raton, Florida, USA, **1993**, pp. 141–142.
- 16 Tang, W., Eisenbrand, G. *Corydalis turtschaninowii* Bess. F. *yanhusuo* Y.H. Chou et C.C. Hsu. In: Tang, W., Eisenbrand, G. (Eds.), *Chinese Drugs of Plant Origin: Chemistry, Pharmacology, and Use in Traditional and Modern Medicine*. Springer-Verlag, Berlin, Heidelberg, **1992**, pp. 377–393.
- 17 Sagare, A.P., Lee, Y.L., Lin, T.C., Chen, C.C., Tsay, H.S. Cytokinin-induced somatic embryogenesis and plant regeneration in *Corydalis yanhusuo* (Fumaraceae) – a medicinal plant. *Plant Sci.* **2000**, 160, 139–147.
- 18 Lee, Y.L., Sagare, A.P., Lee, C.Y., Feng, H.T., Ko, Y.C., Shaw, J.F., Tsay, H.S. Formation of protoberberine-type alkaloids by the tubers of somatic embryo-derived plants of *Corydalis yanhusuo*. *Planta Med.* **2001**, 67, 839–842.
- 19 Staba, E.J., Zito, S., Amin, M. Alkaloid production from *Papaver* tissue cultures. *J. Nat. Prod.* **1982**, 45, 256–262.
- 20 Hawkes, A.D. *Dendrobium candidum* Wall. ex. Ldl. In: *Encyclopedia of cultivated orchids: An illustrated, descriptive manual of the members of the Orchidaceae currently in cultivation*. Latimer Trend & Co. Ltd., Whitstable, UK, **1970**, p. 153.
- 21 Jones, W.E., Kuehnle, A.R., Arumuganathan, K. Nuclear DNA content of 26 orchids (Orchidaceae) genera with emphasis on *Dendrobium*. *Ann. Bot.* **1998**, 82, 189–194.
- 22 Yen, K.Y. *The illustrated Chinese Materia Medica-crude and prepared drugs*. SMC Publishing Inc., Taipei, **1992**.
- 23 Hu, S.Y. *Dendrobium* in Chinese medicine. *Economic Bot.* **1970**, 24, 165–170.
- 24 Lo, S.F., Nalawade, S.M., Chen, C.C., Tsay, H.S. Asymbiotic germination of seeds, plantlet development and ex-vitro establishment of plants of *Dendrobium tosaense* Makino – a medicinally important orchid. *In Vitro Cell Dev. Biol. Plant* **2004**, 40, 528–535.
- 25 Lo, S.F., Vanisree, M., Tsay, H.S. Bio-guided fractionation and isolation of free radical scavenging components from *in-vitro*-propagated Chinese medicinal plants, *Dendrobium tosaense* MAKINO and *Dendrobium monoliforme* SW. *J. Agric. Food Chem.* **2004**, 52, 6916–6919.
- 26 Tsukamoto, T., Yeno, Y., Ohta, Z. Glycosides of *Dioscorea tokoro* I. Diocin, dioscoreasapooxin and diosgenin. *J. Pharm. Soc. Jpn.* **1936**, 56, 135.
- 27 Yeh, F.T., Huang, W.W., Cheng, C.C., Na, C., Tsay, H.S. Tissue culture of *Dioscorea doryophora* Hance. II. Establishment of suspension culture and the measurement of diosgenin content. *Chinese Agron. J.* **1994**, 4, 257–268.
- 28 Chen, A.H. Study on application of diosgenin-I. Analysis of diosgenin constituent of plants from Taiwan. *Science Monthly* **1985**, 43, 79–85.
- 29 Skrzypczak, L., Wesolowska, M., Skrzypczak, E. *Gentiana* species XII: *In vitro* culture, regeneration, and production of secoiridoid glucosides. In: Bajaj, Y.P.S. (Ed.), *Biotechnology in Agriculture and Forestry, Volume 21, Medicinal and Aromatic Plants IV*. Springer-Verlag, Berlin, Heidelberg, **1993**, pp. 172–186.
- 30 Rodriguez, S., Wolfender, J.L., Hostettmann, K., Odontuya, G., Purev, O. Corniculoside, a new biosidic ester secoiridoid from *Halemia corniculata*. *Helv. Chim. Acta* **1996**, 79, 363–370.
- 31 Chen, C.H., Wang, J.C. Revision of the genus *Gentiana* L. (Gentianaceae) in Taiwan. *Bot. Bull. Acad. Sin.* **1999**, 40, 9–38.

- 32 Chueh, F.S., Chen, C.C., Sagare, A.P., Tsay, H.S. Quantitative determination of secoiridoid glucoside in *in vitro* propagated plants of *Gentiana davidii* var. *formosana* by high performance liquid chromatography. *Planta Med.* **2000**, *67*, 70–73.
- 33 Chen, S.Y., Li, F. Tonic and astringents. In: *Clinical Guide to Herbs and Formulae*. Churchill Livingstone, Madrid, Melbourne, New York, Tokyo, **1993**, p. 75.
- 34 Huang, W.W., Cheng, C.C., Yeh, F.T., Tsay, H.S. Tissue culture of *Dioscorea doryophora* HANCE 1, callus organs and the measurement of diosgenin content. *Chin. Med. Coll. J.* **1993**, *2*, 151–160.
- 35 Lin, L.C., Satish, S.M., Vanisree, M., Shing, Y.M., Tsay, H.S. *In vitro* propagation of *Polygonum multiflorum* Thunb. and quantitative analysis of antioxidant anthraquinones – emodin and physcion. *Biol. Pharm. Bull.* **2003**, *10*, 1–5.
- 36 Verpoorte, R. Exploration of Nature's chemodiversity: the role of secondary metabolites as leads in drug development. *Drug Discovery Today* **1998**, *3*, 232–238.
- 37 Bruneton, J. *Pharmacognosy, Phytochemistry, Medicinal plants*. Intercept, UK, **1995**.
- 38 Hu, Z.B., Alfermann, A.W. Diterpenoid production in hairy root cultures of *Salvia miltiorrhiza*. *Phytochemistry* **1993**, *32*, 699–703.
- 39 Miyasaka, H., Nasu, M., Yoneda, K. *Salvia miltiorrhiza*: *In vitro* production of cryptotanshinone and feruginol. In: Bajaj, Y.P.S. (Ed.), *Biotechnology in Agriculture and Forestry, Volume 7, Medicinal and Aromatic Plants II*. Springer-Verlag, Berlin, Heidelberg, **1989**, pp. 417–430.
- 40 Shimomura, K., Kitazawa, T., Okamura, N., Yagi, A. Tanshinone production in adventitious roots and regenerates of *Salvia miltiorrhiza*. *J. Nat. Prod.* **1991**, *54*, 1583.
- 41 Wu, C.T., Vanisree, M., Satish, M.N., Chen, C.L., Yang, T.F., Tsay, H.S. Isolation and quantitative analysis of cryptotanshinone, an active quinoid diterpene formed in the callus of *Salvia miltiorrhiza* Bunge. *Biol. Pharm. Bull.* **2003**, *26*, 845–848.
- 42 Qian, J., Hunkler, D., Safayhi, H., Rimpler, H. Iridoid-related aglycone and its glycosides from *Scrophularia ningpoensis*. *Phytochemistry* **1992**, *31*, 905–911.
- 43 Lin, H.M., Chen, S.M., Chen, C.C., Tsay, H.S. Mass propagation of *Scrophularia yoshimurae* Yamazaki by tissue culture. *J. Agric. Assoc. China* **1998**, *18*, 1–12.
- 44 Sagare, A.P., Kuo, C.H., Chueh, F.S., Tsay, H.S. *De novo* regeneration of *Scrophularia yoshimurae* YAMAZAKI (Scrophulariaceae) and quantitative analysis of harpagoside, an iridoid glycoside, formed in aerial and under ground parts of *in vitro* propagated and wild plants by HPLC. *Biol. Pharm. Bull.* **2001**, *24*, 1311–1315.
- 45 Yamada, Y., Shoyama, Y., Nishioka, I., Kohda, H., Namera, A., Okamoto, T. Clonal micropropagation of *Gentiana scabra* Bunge var. *buergeri* Maxim. and examination of the homogeneity concerning the gentiopicroside content. *Chem. Pharm. Bull.* **1991**, *39*, 204–206.
- 46 Ambasta, P. *The Useful Plants of India*. Publications and Information Directorate, New Delhi, India, **1986**.
- 47 Jain, S.K., Defillips, R.A. *Medicinal Plants of India*. Reference Publications, Inc., Algonac, Michigan, USA, **1991**.
- 48 Hyde, H. *Geneesplanten van Suriname*. Offsetdrukkerij Westfort N.V., Paramaribo, Suriname, **1992**, p. 3.
- 49 Collonier, C., Fock, I., Kashyap, V., Rotino, G.L., Dunay, M.C., Lian, Y., Mariska, I.K., Rajam, M.V., Servaes, A., Ducreux, G., Sihachakr, D. Application of biotechnology in eggplant. *Plant Cell Tiss. Organ Cult.* **2001**, *65*, 91–107.
- 50 Hua, W.N., Tsai, T.C., Tsay, H.S., Wen, M.C. Production of anthocyanins in pericarp derived callus cultures of *Solanum melongena*. *Taiwanese J. Agric. Chem. Food Sci.* **2001**, *39*, 322–328.
- 51 Wani, M.C., Taylor, H.L., Wall, M.E., Coggon, P., McPhail, A.T. Plant antitumor agents VI. The isolation and structure of taxol, a novel antileukemic and antitumor agent from *Taxus brevifolia*. *J. Am. Chem. Soc.* **1971**, *93*, 2325–2327.
- 52 Wickremesinha, E.R.M., Artega, R.N. *Taxus* callus cultures: Initiation, growth optimization, characterization and taxol production. *Plant Cell Tiss. Org. Cult.* **1993**, *35*, 181–193.

- 53 Wickremesinhe, E.R.M., Artega, R.N. *Taxus* cell suspension cultures: optimizing growth and production of taxol. *J. Plant Physiol.* **1994**, *144*, 183–188.
- 54 Cragg, G.M., Schepartz, S.A., Suffness, M., Grever, M.R. The taxol supply crisis. New NCI policies for handling the large-scale production of novel natural product anticancer and anti-HIV agents. *J. Nat. Prod.* **1993**, *56*, 1657–1668.
- 55 Holton, R.A., Somoza, C., Kim, H.B., Liang, F., Biediger, R.J., Boatman, P.D., Shindo, M., Smith, C.C., Kim, S., Nadizadeh, H., Suzuki, Y., Tao, C., Vu, P., Tang, S., Zhang, P., Murthi, K.K., Gentile, L.N., Liu, J.H. First total synthesis of taxol. 1. Functionalization of the B ring. *J. Am. Chem. Soc.* **1994**, *116*, 1597–1600.
- 56 Nicolaou, K.C., Yang, Z., Liu, J.J., Ueno, H., Nantermet, P.G., Guy, R.K., Claiborne, C.F., Renaud, J., Couladouros, E.A., Paulvannan, K., Sorensen, E.J. Total synthesis of taxol. *Nature* **1994**, *367*, 630–634.
- 57 Slichenmyer, W.J., Von Horf, D.D. Taxol: a new and effective anticancer drug. *Anti-Cancer Drugs* **1991**, *2*, 519–530.
- 58 Lee, C.Y., Lin, F.L., Yang, C.T., Wang, L.H., Wei, H.L., Tsay, H.S. Taxol production by cell cultures of *Taxus mairei*. Proceedings Symposium on development and utilization of resources of medicinal plants in Taiwan. Taiwan Agricultural Research Institute, Taiwan, April 21, 1995. *TARI Special Publication* **1995**, *48*, 137–148.
- 59 Gamborg, O.L., Miller, R.A., Ojima, K. Nutrient requirements of suspension cultures of soyabean root cells. *Exp. Cell Res.* **1968**, *50*, 151–158.

## 13

# Exploring and Accessing Plant Natural Product Biosynthesis in Engineered Microbial Hosts

*Erin K. Marasco and Claudia Schmidt-Dannert*

### 13.1

#### Introduction

Plants or extracts of plants have been used since prehistoric times in traditional medicine. Today, natural products isolated from plants are used as pharmaceuticals, as industrial precursors for fuels, as flavors, pesticides, perfumery ingredients, plant hormones, adhesives, and as drugs of abuse. Almost one-quarter of all prescribed pharmaceuticals contain compounds that are directly or indirectly (through semi-synthesis) derived from plants [1, 2]. In the USA alone, the market value in 2002 of phytochemicals was in excess of US \$ 30 billion [3], and this demand is not expected to lessen in the near future as natural products still produce more leads in drug discovery than does combinatorial chemistry.

Considering the importance of phytochemicals, it is important to understand their biosynthetic pathways on a molecular level. This information will aid in the discovery of new compounds and allow for diversification of natural product scaffolds by the genetic manipulation of metabolic pathways. It will also be used to increase the production levels within native hosts and/or increase the biotechnological production of plant natural products in plant cell cultures and recombinant microbial hosts.

However, compared to the large number of microbial secondary metabolic pathways characterized, only a relatively small number of biosynthetic genes and pathways leading to plant secondary metabolites have been described. This can be attributed to four main reasons:

1. Unlike in microorganisms, biosynthetic genes in plants are not clustered, which requires that each single gene of a biosynthetic reaction series must be identified and isolated individually.
2. Compared to a microorganism, the metabolic complexity of a plant is considerably larger. For example, *Arabidopsis* has 5000 metabolites compared to typically 1500 present in a microorganism. More than 100 000 secondary metabolites have been discovered in plants, and the estimated total number in plants is in ex-

cess of 500 000, while approximately 50 000 have been identified from microbial sources [4–6].

3. The biosynthesis of plant secondary metabolites is under complex temporal and spatial control; moreover, the transport and localization of secondary metabolites varies, which makes intermediates and enzymes difficult to isolate and biosynthetic genes difficult to identify [7, 8].
4. Recently determined genome sequences of plants have revealed remarkable duplications of genes involved in natural product biosynthesis. For example, *Arabidopsis thaliana* has about 290 cytochrome P450 enzymes, which makes the correct designation for each of these enzymes to its role in metabolism, without individual biochemical characterization, very challenging – if not impossible [9].

This chapter will focus on the important roles that engineered microbial cells have played – and will continue to play – in the identification of plant biosynthetic pathways and, in particular, for the production of plant natural products. As detailed below, the heterologous overexpression of biosynthetic genes has been instrumental in characterizing catalytic activities. Moreover, microbial cells have successfully been engineered to synthesize natural and modified plant and microbial natural products [10, 11]. The use of plant cell cultures for the production of plant natural products will not be discussed here, but is reviewed elsewhere [12–15]. Instead, a special emphasis will be placed on the prospects of using microbial fermentation as a technologically less challenging, more scalable and cost-effective alternative in the production of plant natural products.

## 13.2

### Heterologous Expression of Plant Natural Product Genes and Pathways

The characterization of plant biosynthetic pathways is in most cases a challenging and tedious undertaking. Over the past few decades, the pathway discovery process has benefited from three major technological advances, namely isotope labeling experiments, plant cell culture technology and recombinant DNA technology (Fig. 13.1) [8, 16]. The feeding of radiolabeled precursors allowed the chemical elucidation of biosynthetic pathway intermediates, and has been instrumental for example in the discovery of the non-mevalonate pathway of isoprenoid biosynthesis [17, 18]. Cell cultures provided an abundant source of materials for the isolation and characterization of natural enzymes allowing for the discovery and partial characterization of over 80 new enzymes involved in the biosynthesis of indole, isoquinoline, tropane, pyrrolizidine, and purine alkaloids. Finally, recombinant DNA technologies allowed for the overexpression of identified plant genes in microbial hosts for biochemical characterization.

With the emergence of “omics”-based approaches for plant pathway elucidation [5, 19–24], heterologous expression of plant genes in microbial hosts becomes increasingly important in correctly assigning function to a putative gene by enabling

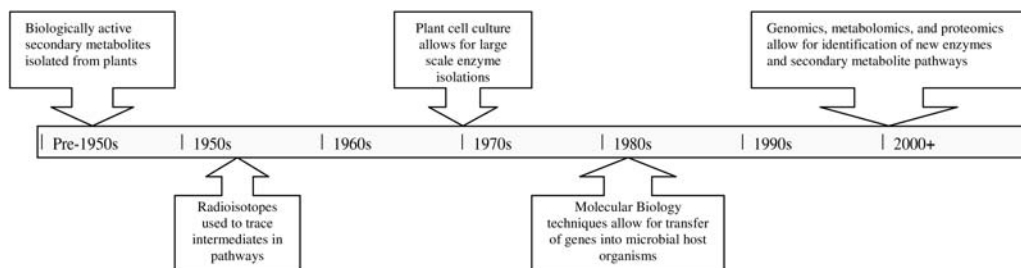


Fig. 13.1 The secondary metabolite pathway discovery trajectory.

*in-vitro* biochemical studies on the overexpressed protein. Available genome sequence and expressed sequence tag (EST) data from plant model organisms such as *A. thaliana* or agriculturally relevant plants such as *Medicago truncatula*, *Oryza sativa*, and *Zea mays* reveal that many enzyme families (e.g., cytochrome P450s, glycosyltransferases, methyltransferases and other group-transferases) known to be involved in the biosynthesis of natural products have undergone extensive gene duplication [25–27]. Sequence duplications and redundancy severely limits homology-based predictions of gene functions as well as comparative genomics approaches to decipher biosynthetic pathways.

A comprehensive approach including genome and EST sequence data, expression and metabolite profiling and ultimately heterologous expression and analysis of enzyme activity, is therefore necessary to correctly annotate new biosynthetic gene functions. For example, such a combined approach using data from DNA microarrays of elicited *Medicago truncatula* cultures, metabolite profiling and *in-silico* EST data mining predicted several glycosyltransferases genes out of 300 glycosyltransferase sequences present in the genome to be involved in the biosynthesis of the triterpene saponin [28]. The identified targets were then heterologously expressed and characterized in *E. coli* to confirm their biosynthetic functions.

The overexpression of plant biosynthetic genes has been instrumental in the elucidation of alkaloid, isoprenoid and flavonoid natural product biosynthetic pathways. The availability of gene sequences encoding several consecutive enzymatic steps in a plant secondary metabolic pathway made it possible to implement the biosynthetic reaction sequences into microbial hosts for the synthesis of complex plant natural products by such engineered cells. Furthermore, combinations of biosynthetic genes from different sources into new reaction sequences and the engineering of catalytic activities allowed an expansion of the range of structures synthesized. Microbial cells have been engineered to produce diverse isoprenoid and flavonoid compounds, while heterologous biosynthesis of alkaloid compounds is not yet entirely feasible because of our incomplete knowledge of their biosynthesis. The following sections provide a survey on our current knowledge on the biosynthesis of these compounds and the use of recombinant microbial cells for characterization of biosynthetic activities and for natural product synthesis.



### 13.3

#### Alkaloids

Alkaloids are a structurally diverse class of nitrogen-containing compounds with important pharmacological activities. In plants, over 12 000 alkaloid structures have been elucidated [23, 29, 30]. A few dozen alkaloids are used medicinally, corresponding to a market value of \$4 million dollars in 2002 in the US [3]. Alkaloid compounds of particular medicinal interest include monoterpene indole alkaloids (vinblastine, ajmaline), benzyloquinoline alkaloids (berberine and morphine), and tropane alkaloids (cocaine and scopolamine). Alkaloids are classified based on their amino acid precursor: Monoterpene indole alkaloids (MIA) derive from tryptophan, isoquinoline alkaloids (IQA) are synthesized from tyrosine, and tropane alkaloids (TA) are produced from ornithine. Each amino acid is converted into a central intermediate, which is strictosidine for MIAs, norcolaurine for IQAs, and homosperidine for TAs (Figs. 13.2 and 13.3). Subsequent rearrangement and tailoring reactions such as acetylations, hydroxylations, glycosylations, and methylations convert these intermediates into the multitude of alkaloid structures produced by different plant species. Strictosidine and norcolaurine make up the central intermediates for over half of all characterized alkaloids [31].

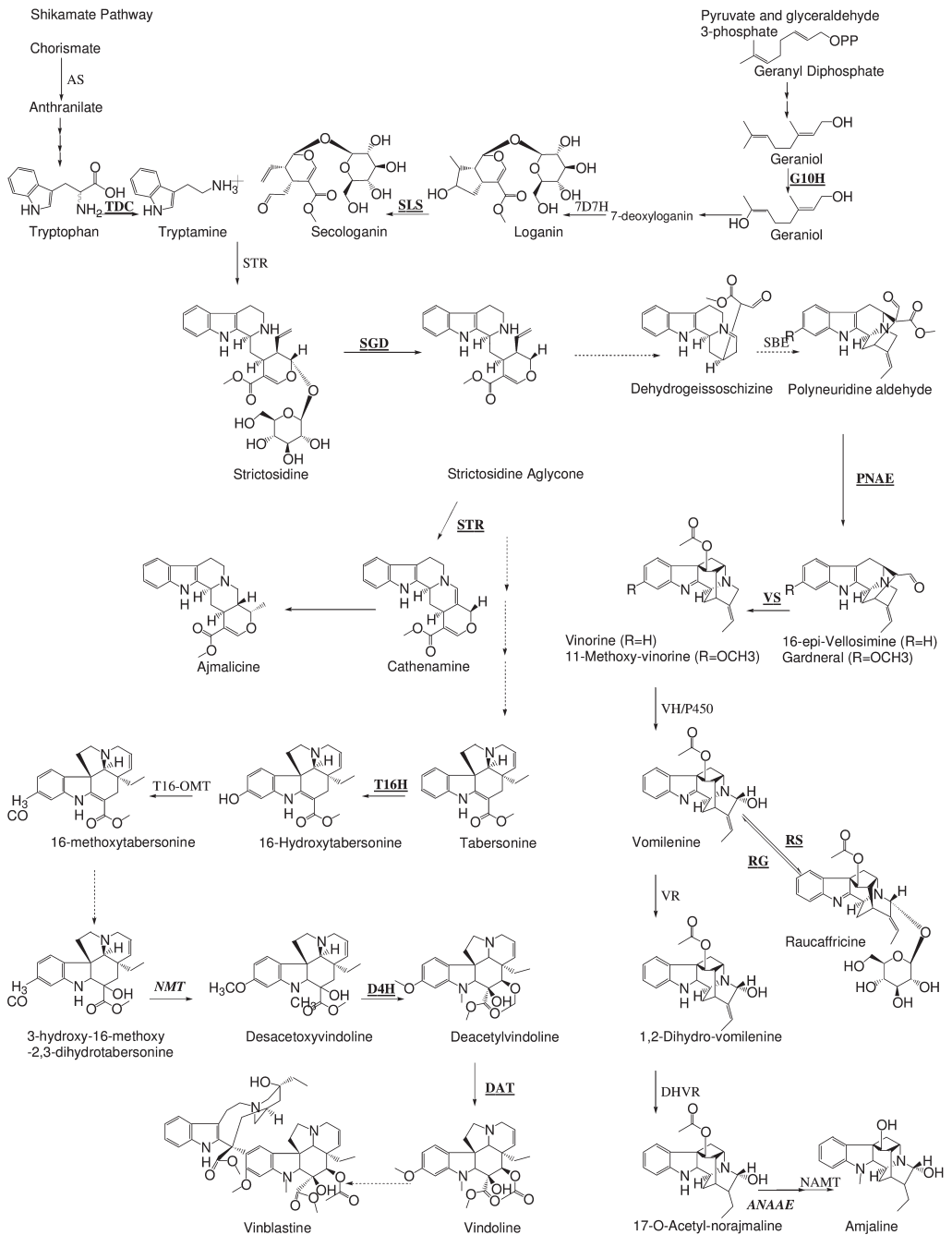
#### 13.3.1

##### Monoterpene Indole Alkaloids

The structures of approximately 2000 MIAs have been described, amongst which are 15 compounds currently used in pharmacological and therapeutic applications. The most important MIAs are the antineoplastic agents vinblastine and vincristine which are used in cancer chemotherapy, the toxin strychnine, the vasodilator yohimbine, the antihypertensive ajmalicine, and the antiarrhythmic ajmaline used to treat heart disease. Because of their pharmacological importance, deciphering the very complex biosynthetic pathways of these compounds has been a longstanding aim of research in plant natural product biosynthesis [16]. Knowledge of the enzymatic steps leading to structurally complex intermediates would enable their overproduction in metabolically engineered plant or microbial cells. These intermediates would then act as scaffolds for further chemical modifications to the desired drug targets. However, despite decades of research, MIA biosynthesis is – on a molecular level – the least well-described pathway among all plant natural product class pathways (the biosynthesis of MIAs, together with known enzymes and those for which the gene sequence is known are shown in Fig. 13.2). From the in-

**Fig. 13.2** Biosynthesis of the monoterpene indole alkaloids vinblastine and ajmaline. Enzymes that have been expressed in microbial cells are shown in bold type and underlined; enzymes that have been partially characterized are shown in bold type and italicized. Vindoline: DAT, deacetylvindoline 4-*O*-acetyltransferase; D4H, desacetoxvindoline

4-hydroxylase; NMT, *N*-methyltransferase; T16-OMT, tabersonine 16-*O*-methyltransferase; T16H, tabersonine 16-hydroxylase; STR, strictosidine synthase; Strictosidine: G10H, geraniol 10-hydroxylase; OMT, *O*-methyltransferase; SGD, strictosidine β-*D*-glucosidase; SLS, secologanin synthase; TDC, tryptophan decarboxylase; Ajmaline: PNAE,



Polyneuridine aldehyde esterase; VS, vinorine synthase; VR, vomilenine reductase; DHVR, vomilenine hydroxylase and reductase;

ANAAE, acetyljmalan esterase; NAMT, norajmaline methyltransferase; RS, raucaffricine synthase; RG, raucaffricine glucosidase.

itial metabolites tryptophan and geraniol, there are over 35 intermediates and 30 enzymes responsible for the formation of vindoline [32]. Nevertheless, a patent was recently filed on the production of terpenoid indole alkaloids in transgenic yeast [33]. The precursors tryptamine and secologanin were efficiently converted to strictosidine and its aglycone (the branch point intermediates of all MIAs; see below), when fed to recombinant yeast cells overexpressing strictosidine synthase and strictosidine glucosidase [34].

As their name indicates, MIAs are derived from an indole and a terpenoid precursor. The indole precursor tryptamine is synthesized from tryptophan by tryptophan decarboxylase, which has been functionally expressed in *E. coli* [35,36]. The terpenoid precursor secologanin is derived from the monoterpenoid geraniol, which is first hydroxylated to 10-hydroxygeraniol followed by a series of additional enzymatic transformations [37]. Only the first enzyme (geraniol 10-hydroxylase [38]) and the last enzyme (secologanin synthase [37, 39]) involved in secologanin biosynthesis have been cloned, while most of the intermediate enzymatic steps are poorly understood. Strictosidine synthase then catalyzes the condensation reaction between tryptamine and secologanin to produce strictosidine, the common intermediate of all MIAs. At this point, or at that of the unstable strictosidine aglycone, which is deglycosylated by strictosidine glucosidase, biosynthetic routes branch off to the different monoterpenoid indole alkaloids. Strictosidine synthase and glucosidase produce valuable intermediates, and thus have been cloned and functionally expressed in microbial cells [40–42].

Two pathways leading to the pharmacologically important alkaloids vindoline (a key precursor to the cytostatic alkaloid vinblastine found in the Madagascar periwinkle *Catharanthus roseus*) and the antiarrhythmic alkaloid ajmaline (isolated from the medicinal plants *Rauwolfia serpentina* and *Tetraphylla vomitoria*) have been characterized to the greatest degree. However, as shown in Figure 13.2, not all enzymatic steps and pathway intermediates are known, and gene sequences are available for only a subset of the biosynthetic enzymes.

The biosynthesis of vindoline begins with transformation of the strictosidine aglycone via an unknown biosynthetic route to cathenamine and to tabersonine. Vindoline is derived from tabersonine by six ordered enzyme reactions that take place in multiple cellular compartments. All of these enzymes but one have been identified, and several have been heterologously expressed and characterized in microbial hosts (Fig. 13.2). Tabersonine is hydroxylated by tabersonine 16-hydroxylase (T16H), a cytochrome P450-dependent monooxygenase localized to the endoplasmic reticulum. T16H cDNA was identified by functional expression in *E. coli* as a translational fusion with a P450 reductase from *C. roseus* [43]. Hydroxytabersonine is O-methylated by cytosolic 16-hydroxytabersonine-O-methyltransferase (T16-OMT) [44], followed by a hydration reaction catalyzed by an unidentified enzyme. The resulting intermediate is N-methylated to desacetoxyvindoline by 2,3-dihydro-3-hydroxytabersonine-N-methyltransferase (NMT), which is associated with the chloroplast thylakoid membranes [45]. Desacetoxyvindoline is then hydroxylated by the cytosolic 2-oxoglutarate-dependent dioxygenase (D4H) [46]. The penultimate step is the acetylation of desacetyl vindoline to vindoline, catalyzed by deace-

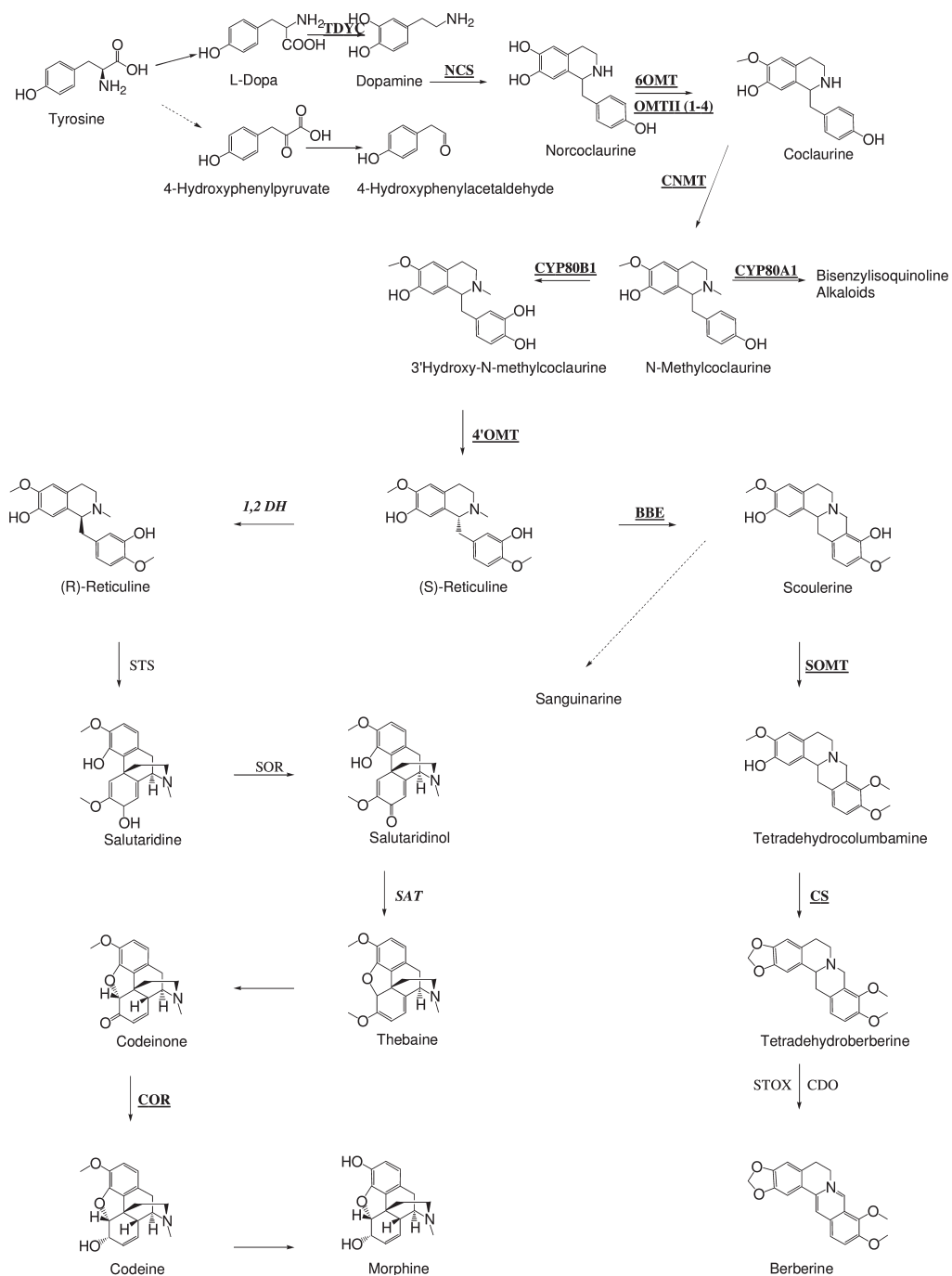
tylvindoline 4-*O*-acetyltransferase (DAT) [47, 48]. Enzymes in the vindoline pathway have been expressed in both *Saccharomyces cerevisiae* (strictosidine synthase and strictosidine glucosidase) and *E. coli* (T16H, D4H, and DAT), although many more remain to be cloned [40, 43, 48, 49].

The elucidation of ajmaline biosynthesis is more complete compared to that for vindoline [50]. To date, six of the ten enzymes thought to be involved in ajmaline biosynthesis have been identified and three of these have been cloned [51–55] (Fig. 13.2). Reconstitution of the entire biosynthetic pathway for ajmaline (for which no chemical synthesis is available) from strictosidine into a heterologous host for overproduction may become conceivable in the not too distant future, provided that the remaining genes will be cloned. The first reaction in ajmaline biosynthesis is conversion of the strictosidine aglycone to a polyneuridine aldehyde, catalyzed by sarpagan bridge enzyme. Very little is known about this enzyme other than it is a cytochrome P450 reaction under reducing conditions; ongoing studies of CYP450s from *Rauvolfia* are expected to clarify this reaction in the future [50]. Polyneuridine aldehyde esterase (PNAE, cloned and expressed in *E. coli* [51]) then synthesizes 16-*epi*-vellosimine (or gardneral), which subsequently is transformed by acetyl-CoA-dependent vinorine synthase (VS) to the first ajmalan-type alkaloid structure, vinorine [55]. Vinorine synthase was functionally expressed in *E. coli* as part of a larger aim of overexpressing the entire ajmaline pathway in engineered microbial cells [55]. This enzyme belongs to the benzylalcohol acetyl-, anthocyanin-*O*-hydroxy-cinnamoyl-, anthranilate-*N*-hydroxy-cinnamoyl/benzoyl-, deacetylvindoline acetyltransferase (BAHD) superfamily of acyltransferases, the members of which play a role in the biosynthesis of a number of plant natural products such as morphine and taxol. Very recently, the crystal structure of vinorine synthase was solved, representing the first structure of a member of the BAHD superfamily [56]. Conversion of vinorine to vomilenine is catalyzed by cytochrome P450 monooxygenase vomilenine hydroxylase (VH) and a NADPH-dependent reductase, which has been isolated and cloned into yeast, although no VH activity has been reported [50]. Vomilenine is then converted to ajmaline by a vomilenine reductase (VR) and dihydrovomilenine reductase (DHVR); both of these enzymes have been purified, but no gene sequence is known [54,57]. A full-length cDNA clone of the acetylajmalan esterase (AAE) was isolated, but attempts at expressing the enzyme in *E. coli* failed. However, AAE was functionally expressed in leaves of *Nicotiana benthamiana*, which allowed its characterization for the first time [58]. Heterologous expression of AAE and the final enzyme norajmaline methyltransferase (NAMT) is thought to be membrane-associated and has not been purified) are likely to be roadblocks to the microbial production of ajmaline.

### 13.3.2

#### **Benzoisoquinoline Alkaloids**

Benzylisoquinoline alkaloids (BIQA) comprise a large, diverse class of compounds of medicinal interest. Areas of pharmacological interest include their use as analgesics (morphine, codeine), antimicrobials (berberine, sanguinarine), and muscle



**Fig. 13.3** Biosynthesis of the benzoisoquinoline alkaloids morphine and berberine. Enzymes that have been expressed in microbial cells are shown in bold type and underlined; enzymes that have been partially characterized are shown in bold type and italicized. Reticuline: TDYC, tyrosine decarboxylase; NCS, norcoclaurine synthase; 6-OMT, narcoclaurine 6-*O*-methyltransferase; CNMT, coclaurine

*N*-methyltransferase; CYP80B1, *N*-methylcoclaurine 3'-hydroxylase; 4'OMT, 3'-hydroxy-*N*-methylcoclaurine 4'-*O*-methyltransferase. Morphine: STS, salutaridine synthase; SOR, salutaridine reductase; SAT, salutaridinol-7-*O*-acetyltransferase; COR, codeinone reductase. Berberine: BBE, berberine bridge enzyme; SOMT, scoulerine-9-*O*-methyltransferase; CS, canadiene synthase.

relaxants (papaverine and (+)-tubocurarine). Over 2500 benzyloisoquinoline alkaloids have been isolated from plants, and all pass through the central intermediate (*S*)-noroclaurine [8] (Fig. 13.3). The biosynthesis of BIAs starts with condensation of the tyrosine derivatives 4-dihydroxyphenylethylamine (dopamine) and 4-hydroxyphenylacetaldehyde (4-HPAA), catalyzed by (*S*)-norcoclaurine synthase (NCS). NCS was initially purified and characterized from *Thalictrum flavum*, but recently has been cloned and functionally expressed in *E. coli* [59, 60]. Three methyltransferases, a 6-*O*, 4-*O* and a *N*-methyltransferase [61–64], together with a P450 monooxygenase [65] convert noroclaurine into *S*-reticuline, at which point the berberine and morphinan pathways branch off.

The berberine bridge enzyme catalyzes the conversion of reticuline to scoulerine, and represents the first committed step in the berberine pathway [66]. Scoulerine conversion to tetrahydrocolumbamline is catalyzed by another methyltransferase, scoulerine 9-*O*-methyltransferase (SMT) [67]. Two more conversions result in the formation of berberine. Except for the final oxidase, all enzymes required for the conversion of noroclaurine to berberine have been cloned [8, 63, 67–71]. Installation of the berberine pathway in a heterologous host such as *S. cerevisiae* should thus be feasible and could allow the targeted production of diverse BIQA compounds for further modification.

The biosynthetic pathway to morphine in the Oriental poppy *Papaver somniferum* (opium poppy) is currently being elucidated, and characterization will benefit the production of morphine and its semi-synthetic derivatives [16, 72]. The 17-step biosynthesis of morphine in this plant has been almost completely elucidated, with the eventual goal being the biomimetic synthesis of thebaine, codeine, and morphine. The unique steps in morphine biosynthesis occur after the central intermediate (*S*)-reticuline and include three NADPH-dependent oxidoreductases [73, 74], three cytochromes P450s [75], and an acetyl-CoA-dependent acetyltransferase [76]. The first enzymes isolated were the 6-*O*-methyltransferase [77] and P450 monooxygenase of the reticuline pathway [71, 78]. The salutaridinol 7-*O*-acetyltransferase and the final enzyme in morphine biosynthesis, codeinone reductase, have recently been cloned [79, 80]. These cDNAs were all functionally expressed in insect cell culture (*S. frugiperda* Sf9 cells) or in *E. coli*. However, there are still a number of biosynthetic steps in the morphinan pathway for which the enzymes have neither been identified nor cloned. Thus, the biosynthesis of morphinan alkaloids in a microbial heterologous host is not yet feasible, though microbial biotransformations of morphine to valuable derivatives have been reported [81]. For example, a reus-

able efficient recombinant morphine/codeine biotransformation system was created using *Pseudomonas* enzymes [82].

#### 13.4

#### Isoprenoids

Isoprenoids (or terpenoids) represent the largest class of secondary metabolites, with some 30 000 structures described to date [83]. Plant-derived isoprenoids include important medicinal and antimicrobial compounds, as well as flavor and aroma compounds. These compounds are derived from the universal five carbon (C5) terpenoid building blocks, isopentenyl diphosphate (IDP) and dimethylallyl diphosphate (DMADP). Consecutive condensations of IDP with its isomer DMADP build up the carbon backbone of terpenoids. The majority of these condensation reactions are catalyzed as head-to-tail reactions by various chain-length-specific prenyltransferases [84]. Head-to-head condensations of two isoprenoid diphosphate chains are catalyzed by a different class of enzymes, and create the carbon backbone of carotenoids and sterols. Linear isoprenoid chains undergo further modifications, including cyclization catalyzed by terpene cyclases or desaturations catalyzed by carotenoid desaturases, to produce the structurally diverse classes of terpenoid compounds. Depending on the number of condensed C5 units, different terpenoid classes can be distinguished: monoterpenes (C10) are volatile compounds used as fragrances (e.g., menthol and camphor); sesquiterpenes (C15) are pheromones, antimicrobial agents or signal transducers (e.g., farnesol and nerolidol); diterpenes (C20) are antimicrobial agents and involved in signal transduction (e.g., paclitaxel and gibberellin); C30 and C40 terpenoids function as modulators of membrane fluidity and hormones (sterols; e.g., sitosterol, brassinosteroids) and function in photosynthesis, pigmentation and as antioxidants (carotenoids; e.g.,  $\beta$ -carotene).

As is the case for other classes of plant natural products, the extraction of many isoprenoid-derived compounds is expensive and low-yielding, and synthetic efforts are frequently not economically feasible. The engineering of microbial cells for terpenoid production represents an attractive alternative, and has been successful in the biosynthesis of a number of isoprenoid compounds. Unlike the majority of important alkaloid biosynthetic pathways, many isoprenoid biosynthetic routes are genetically well characterized (at least the upstream biosynthetic steps), making it currently possible to transfer these pathways into microbial hosts. Moreover, many plant isoprenoid genes have homologues in microorganisms, allowing combinatorial assembly of biosynthetic genes from different sources into recombinant biosynthetic pathways.

Two biosynthetic routes to IDP and its isomer DMADP are known. One is the mevalonate pathway (MVA), which is present in some eubacteria, in eukaryotes, archaeobacteria, and in the cytosols of higher plants. The other is the recently discovered mevalonate-independent pathway (or DXP pathway) [85]. The majority of eubacteria use the latter pathway [86], as do green algae and the chloroplasts of

higher plants. The MVA pathway converts acetyl-CoA via the intermediate mevalonate to IDP, while the DXP pathway utilizes glyceraldehyde-3-phosphate and pyruvate to synthesize IDP via key intermediates MEP (2-C-methyl-D-erythritol 4-phosphate) and DXP (1-deoxy-D-xylulose 5-phosphate). In plants, both pathways co-exist but are compartmentalized, with the MVA pathway operating in the cytosol and the DXP route in the chloroplasts (Fig. 13.4), where they produce different types of terpenoids. The biosynthesis of diterpenes, sesquiterpenes and triterpenes occurs predominantly in the cytosol, whereas mono-, di- and tetraterpene (carotenoid) biosynthesis takes place in the chloroplasts. Most eubacteria use the DXP pathway to synthesize the prenyl side chains of the menaquinones and ubiquinones of their electron transport chains and dolichols involved in cell wall synthesis [87].

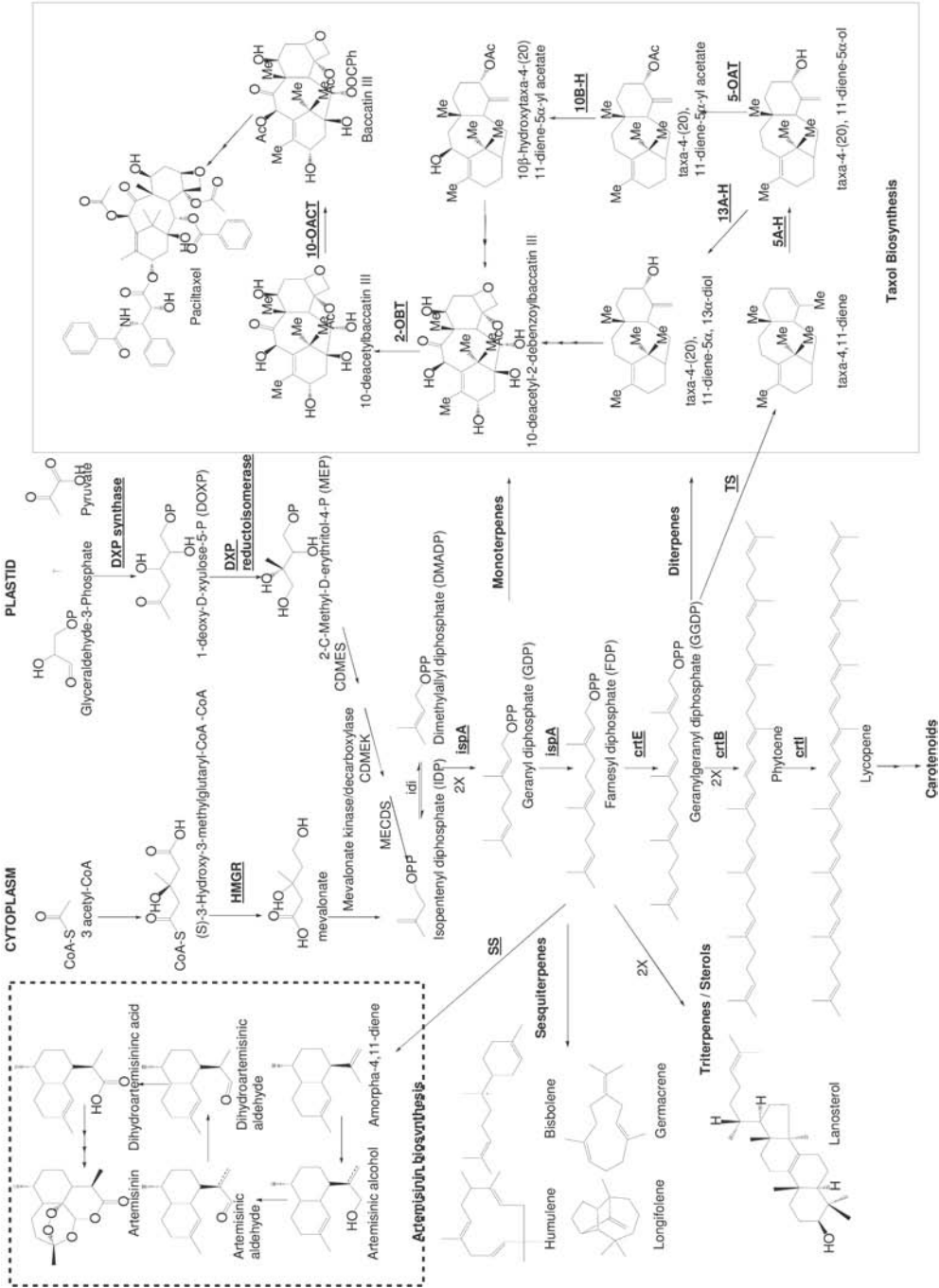
Whilst the enzymatic steps of the MVA pathway have been known for 20 years, elucidation of the DXP pathway was completed only in 2002, less than 10 years after its discovery by Rohmer [85, 88, 89]. Knowledge of these enzymatic steps and their encoding genes has made it possible to manipulate the supply of IDP and DMADP precursors in metabolically engineered microbial cells for the overproduction of diverse terpenoid compounds (*vide infra*). Studies on the manipulation of the IDP, DMADP pool in *E. coli* with the aim of diverting precursors away from competing endogenous to heterologous terpenoid pathways showed that the DXP pathway is under complex regulation and that the accumulation of some DXP pathway intermediates was not well tolerated by *E. coli* [90–94]. As an alternative approach to bypass these pathway control and toxicity issues, the eukaryotic MVA pathway was recently successfully implemented as a parallel pathway for the efficient production of terpenoids in *E. coli* [95]. This precursor engineering, combined with metabolic engineering approaches such as stoichiometric flux balance analysis, has led to an increase in terpenoid production levels in recombinant cells [96,97]. Specific advances in engineering biosynthetic routes for the overproduction in microbial cells of medicinally relevant terpenoid classes are discussed in the following sections.

#### 13.4.1

##### **Sesquiterpenes and Diterpenes**

The first reaction in the synthesis of cyclic sesquiterpenes and diterpenes from linear isoprene diphosphate precursors is catalyzed by a terpene cyclase [98,99]. Terpenoid cyclization involves the generation of a reactive carbocation, stepping of the carbocation through the isoprene chain (often involving de- and reprotonation, hydride shifts, cyclizations and rearrangements) to produce a terminal carbocation that is quenched by a base. Numerous microbial and plant terpene cyclases have been identified that differ in their isoprene chain length specificity, and also in the way that they generate the carbocation, fold up the isoprene chain, and control carbocation migration and quenching. As a result, these enzymes catalyze the formation of a bewildering number of cyclic terpenoid skeletons. With increasing length of the linear isoprene diphosphate chain and consequently, increasing number of double bonds present, the number of possible cyclic skeletons increases rapidly.





**Fig. 13.4** Biosynthetic pathways of isoprenoid-derived compounds. Cloned genes are shown in bold type and underlined. HMGR, HMG-CoA reductase; Idi, IDP isomerase; Dxs, 1-deoxy-D-xylulose 5-phosphate synthase; lspA, FDP synthase; CrtE, GGDP synthase; CrtB, phytoene synthase; CrtI, phytoene desaturase; TS, taxadiene synthase; 5A-H, taxadiene-5 $\alpha$ -hydroxylase; 13A-H, 13 $\alpha$ -hydroxylase; 5-OAT, taxadien-5 $\alpha$ -ol acetyl transferase; 10B-H, 10 $\beta$ -hydroxylase; 2-OBT, 2 $\alpha$ -O-benzoyltransferase; 10-OACT, 10-deacetyl baccatin III-10-O-acetyl transferase

For example, more than 200 different cyclic sesquiterpene skeletons can be derived from the C15 precursor FDP, resulting in an estimated number of 7000 different sesquiterpene structures, compared to about 1000 monoterpene structures derived from the C10 precursor geranyldiphosphate (GDP) [98].

Biochemical studies on the isolated enzyme have shown that many cyclases produce, in addition to the major cyclization product, several minor products *in vitro* [100]. Not only may one terpene cyclase synthesize several cyclization products, but plants frequently also have multiple cyclase genes [101] (e.g., genomic analyses identified 40 terpene synthase homologues in *A. thaliana* [102]), which makes unraveling terpene biosynthesis in plants a difficult task. As a consequence, in order to understand plant terpene biosynthesis and identify the enzymes responsible for the biosynthesis of medicinally valuable terpenoids, a large number of terpene synthases have been cloned and overexpressed in microbial hosts (for some examples, see [103–108]). Fortunately, like other isoprenoid biosynthetic enzymes, many cyclase genes can be functionally expressed in *E. coli* and their cyclization activities assayed either with purified enzymes or crude cell lysates [109–111].

The next step beyond overexpressing individual plant cyclase genes in a microbial host for biochemical studies is the biosynthesis of plant terpenoids by engineered microbial cells. As discussed later in this section, the biosynthesis of carotenoids (another class of isoprenoids) has long been shown to be feasible in non-carotenogenic *E. coli* by extending its native pathway for the C15 isoprenoid precursor FDP with heterologous carotenoid biosynthetic genes. The same strategy could also be applied to the synthesis of medicinal terpenoids. Showcase examples for the successful biosynthesis of medicinally important terpenoids in recombinant microbial host include taxadiene and amorph-4,11-diene, the undecorated terpene scaffolds of the antitumor drug taxol and antimalarial drug artemisinin, respectively.

#### 13.4.2

##### **Taxol**

The diterpene paclitaxel (tradename Taxol<sup>®</sup>) and its derivatives are potent anticancer compounds used to treat ovarian, breast, lung, neck, bladder, skin, and cervical cancers [112]. As such, the elucidation of its biosynthesis and rate-limiting metabolic steps has been an area of intense research because it may lead to the develop-

ment of higher-yielding production strategies using recombinant plant cell cultures or microbial cells. Over the past decade, five enzymes involved in paclitaxel biosynthesis have been cloned and functionally expressed in bacterial or yeast hosts. The first committed step in the biosynthesis of taxol involves the cyclization of geranylgeranyl diphosphate (GGDP) to the taxane skeleton taxa-4(5), 11(12)-diene, catalyzed by the enzyme taxadiene synthase, which was first cloned and characterized a decade ago [113]. This skeleton is then further functionalized by a series of eight oxidative modifications catalyzed by cytochrome P450 enzymes, several acylations and side chain additions catalyzed by CoA-thioester-dependent transferases [114] (Fig. 13.4).

Efforts such as polymerase chain reaction (PCR) differential display, homology-based cloning and random sequencing of cDNAs [115] from induced *Taxus* cells resulted in a relatively rapid succession over the past few years to the cloning of a majority of enzymes of this complex biosynthetic pathway. Currently, six cytochrome P450 hydroxylases [116–121] have been cloned and expressed in *E. coli*. Also cloned and functionally expressed in *E. coli* were two acetyl, two benzoyl transferases, a phenylpropanoid side chain CoA-transferase [122–125] and a phenylalanine aminomutase involved in taxol side chain biosynthesis [126]. In the near future, all enzymes involved in taxol biosynthesis may be cloned and functionally expressed in *E. coli*, which would provide the means to engineer biosynthetic pathways to at least key intermediate scaffolds for further synthetic modification to taxol or taxol derivatives.

Taxadiene, the unmodified terpenoid scaffold of taxol, was produced in *E. coli* cells transformed with taxadiene synthase and GGDP synthase [127]. Overexpression of GGDP synthase from *Taxus canadensis* [128] was required to synthesize the diterpenoid precursor in *E. coli* (which normally does not produce GGDP). Truncation of taxadiene synthase was necessary to obtain expression of soluble protein in *E. coli*. Co-overexpression of two additional key enzymes of the mevalonate-independent isoprenoid pathway in *E. coli*, DXP synthase and IDP isomerase, along with the heterologous enzymes GGDP synthase and taxadiene synthase, yielded 1.3 mg L<sup>-1</sup> taxadiene.

For the eventual synthesis of biologically active taxol (or derivatives thereof) in a microbial host, the missing biosynthetic enzymes must be cloned and an important technical hurdle, reconstitution of cytochrome P450 monooxygenase activity in the chosen microbial host, must be achieved. The functionalization of taxadiene involves a series of eight microsomal cytochrome P450 monooxygenases, all of which require a complementary NADPH:cytochrome P450 reductase for efficient electron transport from co-factor to monooxygenase. No P450 monooxygenase genes are found in *E. coli*, while yeasts such as *S. cerevisiae* have endogenous microsomal P450s and reductases. *S. cerevisiae* WAT11 cells [129] that overexpress a reductase from *Arabidopsis* have been used to express active taxol P450s in cell lysates [115–117, 120]. More recently, the use of a homologous reductase from *Taxus* has been examined in *S. cerevisiae* for transgenic redox coupling to the taxol P450 10 $\beta$ -hydroxylase. This reductase performed similar to the *Arabidopsis* enzyme, but was approximately sevenfold more efficient than the endogenous yeast reductase [130].

Recently, in an attempt to install in *S. cerevisiae* a five-step biosynthetic pathway leading to the intermediate taxa-4(20), 11(12)-dien-5 $\alpha$ -acetoxy-10 $\beta$ -ol, functional co-expression of GGPP synthase, taxadiene synthase, three P450s (taxadiene 5 $\alpha$ , 10 $\beta$  and 13 $\alpha$ -hydroxylase, two acetyl-transferases (taxadiene 5-*O* and 10-*O*-acetyl-transferases) and a 5-*O*-benzoyl transferase was studied [131]. All enzymes were functionally expressed in yeast, though at varying levels. P450 activities measured from microsomal preparations were substantially lower compared to those obtained in *S. cerevisiae* hosts expressing a heterologous P450 reductase. Five of the enzymes (GGPP synthase, taxadiene synthase, taxadiene 5 $\alpha$ - and 10 $\beta$ -hydroxylase and 5-*O*-acetyl transferase) were then co-expressed in *S. cerevisiae*. However, while taxadiene was produced at approximately 1 mg L<sup>-1</sup>, the limited expression levels of active 5 $\alpha$ -hydroxylase, the next enzyme in the biosynthetic reaction sequence, prevented further flux through the recombinant pathway. The engineering of efficient redox-coupling between P450 enzyme and NADPH using a heterologous reductase and increasing P450 expression levels may eventually lead to the functional installment of a multi-step taxol pathway in yeast. Already, the production levels of taxadiene obtained in microbial hosts *E. coli* and *S. cerevisiae* are 100-fold higher compared to those of engineered *Arabidopsis* [132].

#### 13.4.3

#### Artemisinin

Artemisinin, a sesquiterpene lactone endoperoxide isolated from sweet wormwood (*Artemisia annua*), is under intense investigation because of its effectiveness in treating all known strains of malaria. However, artemisinin isolated from plant extracts is too expensive for widespread use in developing countries, and consequently it is hoped that the development of a fermentative route to artemisinin or precursor sesquiterpenoid scaffolds might yield a production strategy for an inexpensive and effective antimalarial drug.

Artemisinin biosynthesis is initiated by the cyclization of farnesyl diphosphate to the undecorated, hydrocarbon sesquiterpenoid scaffold amorph-4,11-diene, catalyzed by amorph-4,11-diene synthase. This enzyme has been cloned and characterized in *E. coli* [133, 134]. Biosynthesis then proceeds via different oxygenated intermediates, artemisic alcohol, -aldehyde and -acid, to the final endoperoxide lactone, artemisinin. However, none of the subsequent enzymatic steps of the pathway is known, and elucidation is ongoing as intermediates are isolated from *A. annua* leaves and gland secretory cells [135].

Heterologous production of significant levels of amorph-4,11-diene was recently accomplished by engineering the *S. cerevisiae* mevalonate pathway and the amorph-4,11-diene synthase into *E. coli* [95]. Production levels of around 100 mg amorph-4,11-diene per liter of *E. coli* culture were reported under the conditions used. The obtained production levels are almost two orders of magnitude higher than those reported for other terpenoids in recombinant microbial hosts. Installment of the yeast mevalonate-dependent pathway provided an alternative route for isoprenoid precursor biosynthesis in *E. coli*. Unlike *E. coli*'s endogenous DXP isoprenoid

pathway, the installed recombinant mevalonate pathway is not under strict physiological control, and as such is able to provide sufficient FDP for subsequent cyclization by amorpha-4,11-diene synthase. A codon-optimized synthase gene was used to facilitate good expression levels in *E. coli*, as previous studies had shown that poor expression of plant sesquiterpenoid synthases in *E. coli* limited terpenoid production [136].

#### 13.4.4

#### Carotenoids

Carotenoids represent a large class of structurally diverse isoprenoid compounds synthesized by plants and microbes. The biological functions of these pigments include species-specific coloration and light-harvesting, in addition to signaling and protection against reactive oxygen species [94]. Carotenoids from plants are important in the human diet as the primary source of vitamin A, and are suggested to play an important role in preventing cancer and cardiovascular disease. Vitamin A deficiencies are the leading causes of blindness in the developing world, and also increase susceptibility to infectious disease. Providing pro-vitamin A in staple foods such as rice by metabolic engineering of  $\beta$ -carotene pathways has led to the production of “Golden Rice” [137, 138]. Carotenoids are used commercially as food colorants, feed supplements, nutraceuticals and for cosmetic and pharmaceutical purposes. Of the more than 600 different carotenoids identified in Nature, only a small number can be synthesized in useful quantities by chemical synthesis [139], extraction from their natural sources, or microbial fermentation [94, 140].

Studies on carotenoid biosynthesis in plants and microorganisms have resulted in the cloning of a number of genes encoding the enzymes of the carotenoid biosynthetic pathways leading to carotenoids with C40 (derived from GGDP in plants and majority of microorganisms) or C30 (derived from FDP in some microorganisms) carbon backbones (Fig. 13.4). Most genes are readily expressed in *E. coli* for functional studies. In addition, most known carotenoid enzymes of microbial and plant origin function cooperatively when co-expressed in recombinant *E. coli*, which allowed the recombinant biosynthesis of diverse cyclic and acyclic carotenoids in *E. coli* [94,141,142].

Because C40 carotenoids such as the diterpenoid taxol (*vide supra*) are derived from the C20 isoprenoid precursor GGDP, biosynthesis of these terpenoids in non-carotenogenic hosts such as *E. coli* requires first the extension of its isoprenoid pathway with a heterologous gene encoding geranylgeranyl diphosphate synthase (CrtE) that adds a C5 isoprenoid unit to the general C15 isoprenoid precursor FDP in a head-to-tail condensation reaction. Synthesis of the first colorless carotenoid phytoene requires an additional recombinant enzyme, phytoene synthase (CrtB), which catalyzes the head-to-head condensation of two GGDP molecules. Extension of this two-gene pathway with a gene encoding phytoene desaturase (CrtI) leads to the synthesis of the first colored carotenoid, the orange-red acyclic lycopene, in *E. coli*. This core pathway has been extended in *E. coli* with known carotenoid functionalizing enzymes that catalyze cyclization, glucosylation and diverse

oxygenation reactions for the production of a diverse set of acyclic and cyclic carotenoids and xanthophylls in *E. coli* [143].

Production levels of carotenoids in recombinant *E. coli* are typically low (~1 mg g<sup>-1</sup> dry cell weight, corresponding to 5–10 mg L<sup>-1</sup> of culture). High-yield production of carotenoids in engineered microbial hosts will require: (i) optimization of the available isoprenoid precursor pool; (ii) balancing the expression of carotenogenic genes for efficient transformation of precursors to desired carotenoid compounds; and (iii) provision of sufficient storage capabilities for the mostly lipophilic carotenoids either by engineering (e.g., additional membrane storage) or by selecting a suitable microbial heterologous host with known high storage capabilities for hydrophobic compounds, such as yeasts or photosynthetic bacteria.

Metabolic engineering efforts to increase recombinant carotenoid production in microbes have so far almost exclusively targeted isoprenoid precursor supply and the expression of carotenoid genes [94]. Manipulation of the DXP pathway in *E. coli* involved the overexpression of isoprenoid genes such as *dxr* (1-deoxy-d-xylulose-5-phosphate reductoisomerase), *dxs* (1-deoxy-d-xylulose-5-phosphate synthase), *idi* (IPP isomerase) and *ispA* (FDP synthase), either individually or in combination. This approach led to overall increases in carotenoid production levels from 1.5- to 10-fold [92, 144–146]. A different strategy targeted the supply of the immediate precursors of the DXP pathway. Redirection of the flux from pyruvate to glyceraldehyde-3-phosphate, either by overexpression of phosphoenolpyruvate synthase (*pps*) or phosphoenolpyruvate carboxykinase (*pck*) or by inactivation of pyruvate kinase (*pyk*), improved lycopene production up to fivefold in *E. coli*. Placement of *idi* and *pps* expression under dynamic control of an engineered intracellular control loop that senses excess glycolytic flux further increased lycopene yields [91]. Balancing the expression of rate-limiting enzymes has been effective for increasing flux through the carotenoid pathway by relieving growth inhibition caused by overexpression of enzymes [92, 145]. The modulation of enzyme expression levels can also be used to achieve accumulation of different ratios of carotenoid intermediates by controlling the metabolic flux through the carotenoid pathway [147].

The ease with which carotenoid enzymes from different origins can be functionally expressed in *E. coli*, along with the unique spectroscopic properties of the carotenoid products, has made carotenoid biosynthesis an ideal model system for biosynthetic scaffold diversification strategies such as combinatorial biosynthesis and the alteration of catalytic properties [94, 142, 148]. To access novel carotenoid structures in *E. coli*, individually biosynthetic genes within a recombinant assembled carotenoid pathway can be subjected to *in-vitro* evolution to generate enzyme variants with new desired catalytic activities. A directed evolution or *in-vitro* evolution approach [149] does not rely on structural information, which in most cases is not available for natural product biosynthetic enzymes, for the generation of catalytic variants, but instead follows a cycle of mutagenesis (for example, by error-prone PCR or *in-vitro* recombination of homologous DNA sequences using perhaps a DNA-shuffling protocol) and screening of the generated variant library. The inherent chromatic properties of carotenoids provide an effective screen for novel

carotenoid compounds as long as the structural modifications affect their chromophore [142]. The enzymes at the start of the carotenoid pathway – phytoene desaturase and lycopene cyclase – have been targeted by directed evolution. A mutant phytoene desaturase was obtained that carries out additional rounds of desaturation of the lycopene carbon backbone to produce 3,4-didehydrolycopene and the fully conjugated 3',4',3,4-tetrahydrolycopene [150]. When coupled with a mutant lycopene cyclase, a novel pathway to the monocyclic carotenoid torulene was produced. By combining these *in-vitro*-evolved pathways with a diverse array of microbial carotenoid-modifying enzymes, a large number of novel carotenoid structures have been produced in recombinant *E. coli* [143]. The identification of a novel carotenoid oxygenase involved in C30 carotenoid biosynthesis in *Staphylococcus aureus*, allowed further expansion of the array of novel C30 and C40 carotenoids, some of which exhibited interesting violet to dark violet color phenotypes, being produced in recombinant *E. coli* [151]. Carotenoid with unusual odd-numbered C35, C45 and C50 backbone chains have been generated by a combination of directed evolution and combinatorial biosynthesis [152, 153].

### 13.5

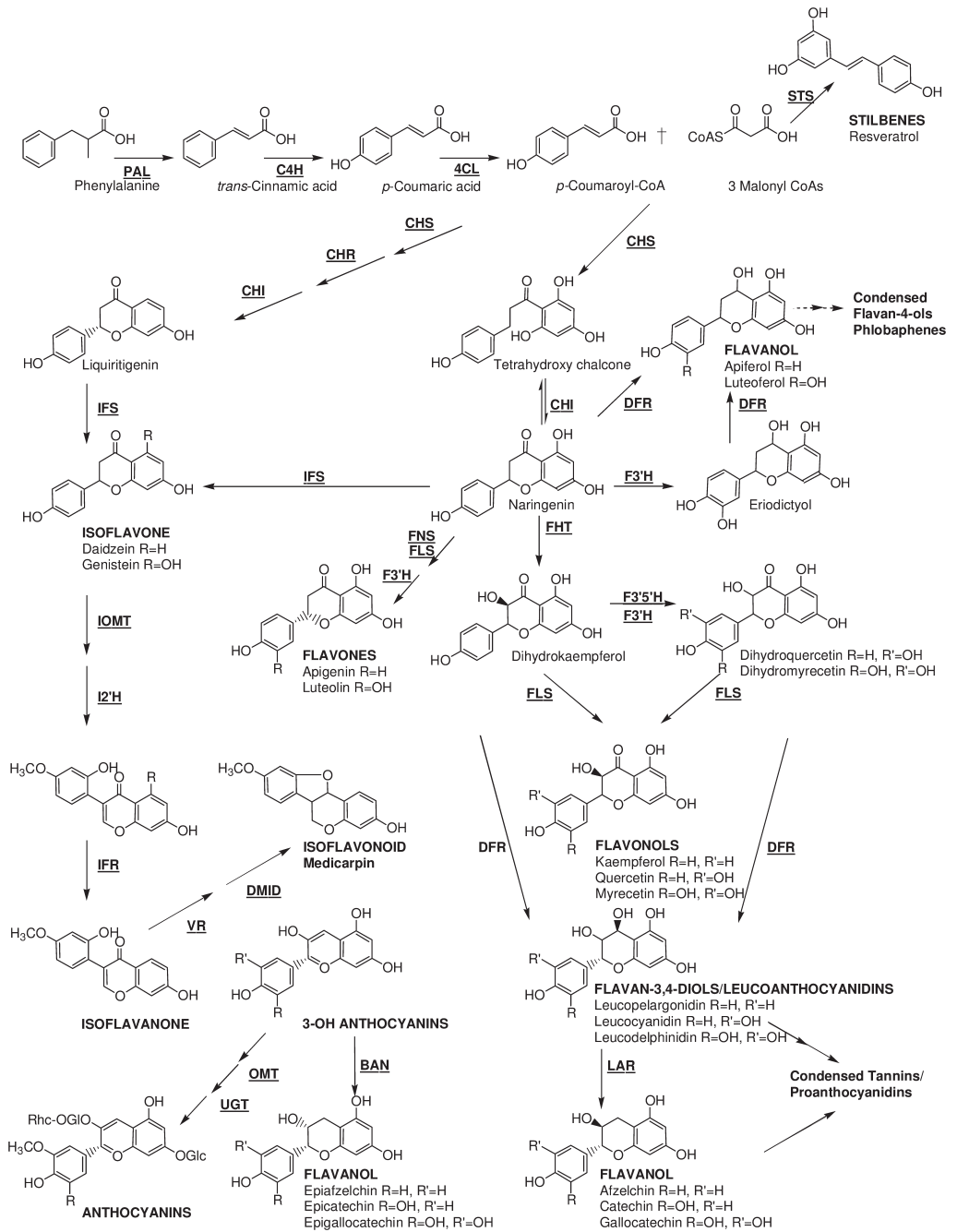
#### Flavonoids

Flavonoids are ubiquitous complex phenylpropanoid-derived plant natural products. One phenylpropene unit condenses with three acetate units derived from malonyl-CoA, and this results in a cyclic phenylchromane scaffold. From this precursor, three major biosynthetic routes leading to: (i) flavonols, anthocyanins, condensed tannins (proanthocyanidins); (ii) isoflavonoids; and (iii) stilbenes can be distinguished (Fig. 13.5) [154]. The biological functions of flavonoids in plants are various, as is their structural diversity. More than 600 flavonoid structures have been described as the result of different oxidation-levels, modifications and substitutions of the phenylchromane scaffold [155]. While some flavonoid classes are ubiquitous in plants, others with specific substitutions of the phenylchromane scaffold are restricted to certain plant genera or species, and frequently are pro-

**Fig. 13.5** Biosynthetic pathways leading to flavonoid-derived products in plants. Major biosynthetic routes for which enzymes have been characterized on a molecular level are shown. Common names for differently oxidized and substituted phenylcoumarane structures are capitalized and in bold type. Cloned genes are in bold type and underlined. Enzyme abbreviations are as follows: PAL, phenylammonia lyase; C4H, cinnamate-4-hydroxylase; 4CL, coumaroyl-CoA-ligase; CHS, chalcone synthase; STS, stilbene synthase; CHI, chalcone isomerase; CHR, chalcone reductase; FNS I/II, flavone synthase; FLS, flav-

onol synthase; FHT, flavonone 3 $\beta$ -hydroxylase; F3'H, flavonoid 3'-hydroxylase; F3'5'H, flavonoid 3'5'-hydroxylase; DFR, dihydroflavonol-4-reductase; LAR, leucoanthocyanidin reductase; BAN, anthocyanidin reductase; OMT, O-methyltransferase; UGT, UDP-glucose:flavonoid glycosyl transferase; RT, rhamnosyl transferase; IFS, isoflavone synthase; IOMT, isoflavone O-methyltransferase; I2'H, isoflavone 2-hydroxylase; IFR, isoflavone reductase; VR, vestitone reductase; DMID, 7,2'-dihydroxy-4'-methoxyisoflavonol dehydratase; LDOX (ANS), leucoanthocyanidin dioxygenase (anthocyanidin synthase)







duced only in small quantities and/or under certain environmental conditions. For example, stilbenes are found in certain plant families such as peanut, grapevine and pine, whereas isoflavonoids are mostly limited to legumes [156, 157].

Flavonoids exhibit a multitude of important functions in plants and, based on the wealth of publications on flavonoids, these compounds are possibly among one of the best-studied natural product classes [155–160]. The brightly colored anthocyanins represent flavonoid structures with the most obvious function in plants, namely attraction of insect pollinators and seed dispersers. Other important functions of flavonoids in plants involve defense against herbivory and microbial pathogens, function as signal molecules in bacterial nodulation, in fertility and germination of pollen and regulation of plant growth and development as well as UV-B protection. Medicinal activities shown for flavonoid compounds range from scavenging of harmful reactive oxygen species, enzyme inhibition, anti-inflammatory, vascular and estrogenic activities to cytotoxic antitumor activities [155, 161]. The frequency with which structures having biological activities are found within the flavonoid natural product class suggests flavonoids as possibly one of the most promising natural product class for the discovery of new biological activities.

Over the past few years considerable effort has been directed at elucidating the major flavonoid biosynthetic pathways on an enzymatic and molecular level [154, 156]. The biosynthesis of flavonoids begins with the deamidation of L-phenylalanine, catalyzed by phenylammonia lyase (PAL). Successive hydroxylation of the resulting cinnamic acid to coumaric acid by the P450 cinnamate-4-hydroxylase (C4H), followed by activation to 4-coumaroyl-CoA by coumaroyl-CoA-ligase (4CL), provides the phenylpropanoid precursor for the first committed step of flavonoid biosynthesis: the sequential condensation of one coumaroyl-CoA molecule with three malonyl-CoA molecules by chalcone synthase (CHS). This condensation forms a chalcone via intramolecular cyclization. CHS is a unimodular polyketide synthase (PKS) representing a novel class of PKS (type III) [162–165]. Stilbene synthase (STS), responsible for the synthesis of stilbenes in some plant species, carries out the same condensation reactions as CHS, but catalyzes a different ring closure (Fig. 13.5). Two pathways branch from the chalcone product of CHS: one leading to isoflavonoids, the other to flavonols, anthocyanins and condensed tannins. (2-S)-Naringenin, the core flavonoid pathway precursor, undergoes various oxidation and hydroxylation reactions catalyzed by cytochrome P450 monooxygenases and 2-oxoglutarate-dependent dioxygenases to yield flavones, flavanones, and flavonols. Further reductions, glycosylations, methylations, acylations and prenylations lead to the synthesis of diverse anthocyanins. The cytochrome P450 enzyme 2-hydroxyisoflavone synthase (IFS) catalyzes the first committed step of isoflavonoid biosynthesis. Spontaneous dehydration of the resulting unstable 2-hydroxyisoflavanone then produces the isoflavones daidzein or genistein, respectively. Subsequent reductions, cytochrome P450-catalyzed oxidations, methylations and glycosylation modify the isoflavone scaffolds to the diverse isoflavonoid compounds synthesized in legumes [156].

Of all the compound classes discussed so far, flavonoids have the most complete pathways maps at the level of genes, enzymes, and pathway intermediates. Many

flavonoid genes have been cloned from diverse plant species and heterologously expressed in microbial hosts for enzymatic characterization. Flavonoids represent therefore an ideal class of medicinally important plant compounds to be produced by metabolically engineered microbial hosts. Although some flavonoids can be synthesized chemically, their numerous stereocenters are challenging for a synthetic approach. A biosynthetic route via engineered microbial cells on the other hand could produce enantiomerically pure flavonoids in good yields from inexpensive starting materials.

Recent attempts to reconstruct flavonoid pathways have been very successful in the generation of flavonoid compounds. Using a hybrid pathway consisting of enzymes from a yeast, a *Streptomyces* and a plant, the first engineered flavonoid pathway in *E. coli* was created [166]. While production levels were relatively low, the use of bifunctional ammonia lyase enzymes in the pathway allowed for the production of two compounds, pinocembrin and naringenin, from phenylalanine and tyrosine, respectively [166]. This pathway was then extended with a gene encoding chalcone isomerase (CHI), which converts the racemic chalcone products from CHS to the corresponding (2*S*)-flavanones [167]. The addition of flavone synthase and flavanone 3 $\beta$ -hydroxylase to the CHI-containing pathway allowed synthesis in *E. coli* of the flavones apigenin and chrysin, and of the flavonols kaempferol and galangin, at levels ranging from 1 to 15 mg L<sup>-1</sup>. A different pathway consisting of solely *A. thaliana* genes for PAL, C4H, 4CL, and CHS was reconstructed in *E. coli* [168]. Expression of the plant cytochrome C4H resulted in a blockage in the pathway that was overcome by feeding exogenous 4-coumaric acid. In order to bypass the difficulties in expressing a plant P450 cytochrome monooxygenase and a complementary reductase in *E. coli*, a bacterial tyrosine ammonium lyase (TAL) was cloned from *Rhodobacter sphaeroides*. The TAL used tyrosine as a starter molecule and substituted the *Arabidopsis* PAL and C4H. This shortened biosynthetic pathway resulted in 250-fold greater naringenin production levels (~21 mg L<sup>-1</sup>) in *E. coli* compared to the plant, yeast, and bacteria hybrid pathway. In addition, it was found that phenylpropanoids could be directly fed to recombinant *E. coli* cultures for their transformation into modified flavonoid structures. Feeding of 3-(4-hydroxyphenyl)propionic acid resulted in production of phloretin, a compound not formed in the endogenous *Arabidopsis* pathway.

Like other natural product biosynthetic pathways, flavonoid biosynthesis involves many cytochrome P450-catalyzed hydroxylation and oxygenation reactions. Considering the difficulty in expressing eukaryotic P450s in active form in *E. coli*, *S. cerevisiae* (a more suitable host for functional P450 expression) has also been investigated for heterologous flavonoid biosynthesis. Co-expression of PAL from *Rhodospiridium toruloides*, 4CL from *A. thaliana*, and the CHS from *Hypericum androsaemum* resulted in the production of naringenin (7 mg L<sup>-1</sup>) and pinocembrin (0.8 mg L<sup>-1</sup>) in *S. cerevisiae* [169]. The available tyrosine precursor pool limited the flux through the engineered pathway. In addition, several polyketide derailment products accumulated. A similar pathway with genes from different plant species yielded up to 28 mg L<sup>-1</sup> naringenin when cultures were fed with 4-coumaric acid [170]. The recombinant flavanone pathway was then extended with two different

types of flavone synthases, a 2-oxoglutarate-dependent dioxygenase and a cytochrome P450, which yielded the flavones chrysin, apigenin, and luteolin in *S. cerevisiae* at levels of 1 to 10 mg L<sup>-1</sup> [171]. The stilbene compound resveratrol has also been produced in *S. cerevisiae* using a combined poplar and grapevine pathway [172], but the production levels obtained were extremely low (~1 µg L<sup>-1</sup>).

## 13.6

### Conclusions

The purpose of this chapter was to highlight the important role that recombinant microbial cells play in the elucidation of plant biosynthetic pathways and biosynthesis of plant natural products. The current status of three classes of plant secondary metabolites – alkaloids, terpenoids, and flavonoids – were also described. Although alkaloids are the most abundant class of plant secondary metabolites, their synthetic pathways are complex and difficult to elucidate. The heterologous expression of alkaloid enzymes in *E. coli* or *S. cerevisiae* has been mainly used for single enzyme characterization. In contrast, both isoprenoid and flavonoid pathways have been reconstituted in microorganisms to a greater extent. The expression of these pathways in microorganisms allowed for the optimization of flux and identification of regulatory factors involved in secondary metabolite biosynthesis.

Some general principles can be garnered from the examples described in this chapter. First, the identification of intermediates is critical when predicting the enzymes involved in metabolism. The assembly of pathways in microorganisms has allowed for the stepwise identification of intermediates and characterization of substrate specificity. Second, enzymes discovered using genomic and proteomic methods must be individually characterized biochemically in order to isolate and confirm their specific role in metabolism. Homology alone is not a good enough indicator of function as there is an abundance of enzymes with similar functions. Third, many secondary metabolite pathways contain a central intermediate that branches into diverse products through accessory enzymes. The production of this central intermediate in microorganisms may be a stepping stone for semi-synthesis or complete recombinant biosynthesis. Fourth, complex plant biosynthetic pathways can be engineered into microorganisms, but the plant enzymes may need to be modified in order to function optimally. The engineering of a 13-gene heterologous pathway for hydrocortisone biosynthesis in yeast demonstrates the feasibility of reconstructing complex biosynthetic pathways in microbial cells [173]. Finally, hybrid pathways containing genes from different plant and/or microbial sources can be constructed in microorganisms to produce both natural and “designer” secondary metabolites.

## References

- 1 Cragg, G.M., Newman, D.J., Snader, K.M. Natural products in drug discovery and development. *J. Nat. Prod.* **1997**, *60*, 52–60.
- 2 Oksman-Caldentey, K.-M., Inze, D., and Oresic, M. Connecting genes to metabolites by a systems biology approach. *Proc. Natl. Acad. Sci. USA* **2004**, *101*, 9949–9950.
- 3 Raskin, I., et al. Plants and human health in the twenty-first century. *Trends Biotechnol.* **2002**, *20*, 522–531.
- 4 Hadacek, F. Secondary metabolites as plant traits: current assessment and future perspectives. *Crit. Rev. Plant Sci.* **2002**, *21*, 273–322.
- 5 Trethewey, R.N. Metabolite profiling as an aid to metabolic engineering in plants. *Curr. Opin. Plant Biol.* **2004**, *7*, 196–201.
- 6 Demain, A.L. Pharmaceutically active secondary metabolites of microorganisms. *Appl. Microbiol. Biotechnol.* **1999**, *52*, 455–463.
- 7 Facchini, P.J., St-Pierre, B. Synthesis and trafficking of alkaloid biosynthetic enzymes. *Curr. Opin. Plant Biol.* **2005**, *8*, 657–666.
- 8 Facchini, P.J. Alkaloid biosynthesis in plants: Biochemistry, cell biology, molecular regulation, and metabolic engineering applications. *Annu. Rev. Plant Physiol. Plant Mol. Biol.* **2001**, *52*, 29–66.
- 9 Dixon, R.A., Strack, D. Phytochemistry meets genome analysis, and beyond. *Phytochemistry* **2003**, *62*, 815–816.
- 10 Mijts, B.N., Schmidt-Dannert, C. Engineering of secondary metabolite pathways. *Curr. Opin. Biotechnol.* **2003**, *14*, 597–602.
- 11 Chartrain, M., Salmon, P.M., Robinson, D.K., Buckland, B.C. Metabolic engineering and directed evolution for the production of pharmaceuticals. *Curr. Opin. Biotechnol.* **2000**, *11*, 209–214.
- 12 Verpoorte, R., van der Heijden, R., ten Hoopen, H.J.G., Memelink, J. Metabolic engineering of plant secondary metabolite pathways for the production of fine chemicals. *Biotechnol. Lett.* **1999**, *21*, 467–479.
- 13 Dornenburg, H., Knorr, D. Strategies for the improvement of secondary metabolite production in plant cell cultures. *Enzyme Microb. Technol.* **1995**, *17*, 674–684.
- 14 Ramachandra Rao, S., Ravishankar, G.A. Plant cell cultures: Chemical factories of secondary metabolites. *Biotechnol. Adv.* **2002**, *20*, 101–153.
- 15 Hughes, E.H., Shanks, J.V. Metabolic engineering of plants for alkaloid production. *Metab. Eng.* **2002**, *4*, 41–48.
- 16 Kutchan, T.M. Alkaloid biosynthesis: The basis for metabolic engineering of medicinal plants. *Plant Cell* **1995**, *7*, 1059–1070.
- 17 Rohmer, M. The discovery of a mevalonate-independent pathway for isoprenoid biosynthesis in bacteria, algae and higher plants. *Nat. Prod. Rep.* **1999**, *16*, 565–574.
- 18 Lichtenthaler, H.K. The 1-deoxy-D-xylulose-5-phosphate pathway of isoprenoid biosynthesis in plants. *Annu. Rev. Plant Physiol. Plant Mol. Biol.* **1999**, *50*, 47–65.
- 19 Sumner, L.W., Mendes, P., Dixon, R.A. Plant metabolomics: large-scale phytochemistry in the functional genomics era. *Phytochemistry* **2003**, *62*, 817–836.
- 20 Oksman-Caldentey, K.-M., Saito, K. Integrating genomics and metabolomics for engineering plant metabolic pathways. *Curr. Opin. Biotechnol.* **2005**, *16*, 174–179.
- 21 Fridman, E., Pichersky, E. Metabolomics, genomics, proteomics, and the identification of enzymes and their substrates and products. *Curr. Opin. Plant Biol.* **2005**, *8*, 242–248.
- 22 Jacobs, D.I., Gaspari, M., van der Greef, J., van der Heijden, R., Verpoorte, R. Proteome analysis of the medicinal plant *Catharanthus roseus*. *Planta* **2005**, *221*, 690–704.
- 23 Verpoorte, R., van der Heijden, R., Memelink, J. Engineering the plant cell factory for secondary metabolite production. *Transgenic Res.* **2000**, *9*, 323–343.
- 24 Ounaroon, A., Decker, G., Schmidt, J., Lottspeich, F., Kutchan, T.M. (R,S)-

- Reticuline 7-O-methyltransferase and (R,S)-norcoclaurine 6-O-methyltransferase of *Papaver somniferum* – cDNA cloning and characterization of methyl transfer enzymes of alkaloid biosynthesis in opium poppy. *Plant J.* **2003**, *36*, 808–819.
- 25 Kliebenstein, D.J., Lambrix, V.M., Reichelt, M., Gershenzon, J., Mitchell-Olds, T. Gene duplication in the diversification of secondary metabolism: Tandem 2-oxoglutarate-dependent dioxygenases control glucosinolate biosynthesis in *Arabidopsis*. *Plant Cell* **2001**, *13*, 681–693.
- 26 Pichersky, E., Gang, D.R. Genetics and biochemistry of secondary metabolites in plants: an evolutionary perspective. *Trends Plant Sci.* **2000**, *5*, 439–445.
- 27 D'Auria, J.C., Gershenzon, J. The secondary metabolism of *Arabidopsis thaliana*: growing like a weed. *Curr. Opin. Plant Biol.* **2005**, *8*, 308–316.
- 28 Achnine, L., Huhman, D.V., Farag, M.A., Sumner, L.W., Blount, J.W., Dixon, R.A. Genomics-based selection and functional characterization of triterpene glycosyltransferases from the model legume *Medicago truncatula*. *Plant J.* **2005**, *41*, 875–887.
- 29 Wink, M. Evolution of secondary metabolites from an ecological and molecular phylogenetic perspective. *Phytochemistry* **2003**, *64*, 3–19.
- 30 Wink, M. *Introduction: Biochemistry, Role and Biotechnology of Secondary Metabolites*. Sheffield Academic Press, Sheffield, **1999**.
- 31 De Luca, V., Laflamme, P. The expanding universe of alkaloid biosynthesis. *Curr. Opin. Plant Biol.* **2001**, *4*, 225–233.
- 32 van der Heijden, R., Jacobs, D.I., Snoeijs, W., Hallared, D., Verpoorte, R. The *Catharanthus* alkaloids: Pharmacognosy and biotechnology. *Curr. Medicin. Chem.* **2004**, *11*, 607–628.
- 33 Geerlings, A.V., van der Heijden, R., Memelink, J. Edn. EP 98204116.2. (I.P. Application) (**1998**).
- 34 Geerlings, A., Redondo F.J., Contin, A., Memelink, J., van der Heijden, R., Verpoorte, R. Biotransformation of tryptamine and secologanin into plant terpenoid indole alkaloids by transgenic yeast. *Appl. Microbiol. Biotechnol.* **2001**, *56*, 420–424.
- 35 De Luca, V., Marineau, C., Brisson, N. Molecular cloning and analysis of cDNA encoding a plant tryptophan decarboxylase: comparison with animal dopa decarboxylases. *Proc. Natl. Acad. Sci. USA* **1989**, *86*, 2582–2586.
- 36 Facchini, P.J., Huber-Allanach, K.L., Tari, L.W. Plant aromatic-amino acid decarboxylases: evolution, biochemistry, regulation, and metabolic engineering applications. *Phytochemistry* **2000**, *54*, 121–138.
- 37 Irmiler, S., Schroeder, G., St-Pierre, B.; Crouch, N.P., Hotze, M., Schmidt, J., Strack, D., Matem, U., Schroder, J. Indole alkaloid biosynthesis in *Catharanthus roseus*: new enzyme activities and identification of cytochrome P450 CYP72A1 as secologanin synthase. *Plant J.* **2000**, *24*, 797–804.
- 38 Collu, G., Unver, N., Peltenburg-Looman, A.M., van der Heijden, R., Verpoorte, R., Memelink, J. Geraniol 10-hydroxylase, a cytochrome P450 enzyme involved in terpenoid indole alkaloid biosynthesis. *FEBS Lett.* **2001**, *508*, 215–220.
- 39 Yamamoto, H., Katano, N., Ooi, A., Inoue, K. Secologanin synthase which catalyzes the oxidative cleavage of loganin into secologanin is a cytochrome P450. *Phytochemistry* **2000**, *53*, 7–12.
- 40 Kutchan, T.M., Hamp, N., Lottspeich, F., Beyreuther, K., Zenk, M.H. The cDNA clone for strictosidine synthase from *Rauwolfia serpentina* DNA sequence determination and expression in *Escherichia coli*. *FEBS Lett.* **1988**, *237*, 40–44.
- 41 Geerlings, A., Ibanez, M.M.-L., Memelink, J., van der Heijden, R., Verpoorte, R. Molecular cloning and analysis of strictosidine beta-D-glucosidase, an enzyme in terpenoid indole alkaloid biosynthesis in *Catharanthus roseus*. *J. Biol. Chem.* **2000**, *275*, 3051–3056.
- 42 Gerasimenko, I., Sheludko, Y., Ma, X., Stockigt, J. Heterologous expression of a *Rauwolfia* cDNA encoding strictosidine glucosidase, a biosynthetic key to over **2000** monoterpenoid indole alkaloids. *Eur. J. Biochem.* **2002**, *269*, 2204–2213.

- 43 Schroder, G., Unterbusch, E., Kaltenbach, M., Schmidt, J., Strack, D., De Luca, V., Schroder, J. Light-induced cytochrome P450-dependent enzyme in indole alkaloid biosynthesis: tabersonine 16-hydroxylase. *FEBS Lett.* **1999**, *458*, 97–102.
- 44 St-Pierre, B., De Luca, V. A cytochrome P-450 monooxygenase catalyzes the first step in the conversion of tabersonine to vindoline in *Catharanthus roseus*. *Plant Physiol.* **1995**, *109*, 131–139.
- 45 Dethier, M., De Luca, V. Partial purification of an N-methyltransferase involved in vindoline biosynthesis in *Catharanthus roseus*. *Phytochemistry* **1993**, *32*, 673–678.
- 46 De Carolis, E., De Luca, V. Purification, characterization, and kinetic analysis of a 2-oxoglutarate-dependent dioxygenase involved in vindoline biosynthesis from *Catharanthus roseus*. *J. Biol. Chem.* **1993**, *268*, 5504–5511.
- 47 Power, R., Kurz, W.G., De Luca, V. Purification and characterization of acetylcoenzyme A: deacetylvindoline 4-O-acetyltransferase from *Catharanthus roseus*. *Arch. Biochem. Biophys.* **1990**, *279*, 370–376.
- 48 St-Pierre, B., Laflamme, P., Alarco, A.-M., De Luca, V. The terminal O acetyltransferase involved in vindoline biosynthesis defines a new class of proteins responsible for coenzyme A dependent acyl transfer. *Plant J.* **1998**, *14*, 703–713.
- 49 Vazquez-Flota, F., De Carolis, E., Alarco, A.-M., De Luca, V. Molecular cloning and characterization of desacetoxyvindoline-4-hydroxylase, a 2-oxoglutarate dependent-dioxygenase involved in the biosynthesis of vindoline in *Catharanthus roseus*. *Plant Mol. Biol.* **1997**, *34*, 935–948.
- 50 Ruppert, M., Ma, X., Stockigt, J. Alkaloid biosynthesis in *Rauwolfia* – cDNA cloning of major enzymes of the ajmaline pathway. *Curr. Org. Chem.* **2005**, *9*, 1431–1444.
- 51 Dogru, E., Warzecha, H., Seibel, F., Haebel, S., Lottspeich, F., Stockigt, J. The gene encoding polyneuridine aldehyde esterase of monoterpene indole alkaloid biosynthesis in plants is an ortholog of the alpha/beta hydrolase super family. *Eur. J. Biochem.* **2000**, *267*, 1397–1406.
- 52 Warzecha, H., Gerasimenko, I., Kutchan, T.M., Stockigt, J. Molecular cloning and functional bacterial expression of a plant glucosidase specifically involved in alkaloid biosynthesis. *Phytochemistry* **2000**, *54*, 657–666.
- 53 Mattern-Dogru, E., Ma, X., Hartmann, J., Decker, H., Stockigt, J. Potential active-site residues in polyneuridine aldehyde esterase, a central enzyme of indole alkaloid biosynthesis, by modelling and site-directed mutagenesis. *Eur. J. Biochem.* **2002**, *269*, 2889–2896.
- 54 von Schumann, G., Gao, S., Stockigt, J. Vomilenine reductase – a novel enzyme catalyzing a crucial step in the biosynthesis of the therapeutically applied antiarrhythmic alkaloid ajmaline. *Bioorg. Medicin. Chem.* **2002**, *10*, 1913–1918.
- 55 Bayer, A., Ma, X.Y., Stockigt, J. Acetyltransfer in natural product biosynthesis – functional cloning and molecular analysis of vinorine synthase. *Bioorg. Medicin. Chem.* **2004**, *12*, 2787–2795.
- 56 Ma, X., Koepke, J., Panjikar, S., Fritsch, G., Stockigt, J. Crystal structure of vinorine synthase, the first representative of the BAHF superfamily. *J. Biol. Chem.* **2005**, *280*, 13576–13583.
- 57 Gao, S.J., von Schumann, G., Stockigt, J. A newly-detected reductase from *Rauwolfia* closes a gap in the biosynthesis of the antiarrhythmic alkaloid ajmaline. *Planta Med.* **2002**, *68*, 906–911.
- 58 Ruppert, M., Woll, J., Giritich, A., Genady, E., Ma, X., Stockigt, J. Functional expression of an ajmaline pathway-specific esterase from *Rauwolfia* in a novel plant-virus expression system. *Planta* **2005**, *222*, 888–898.
- 59 Samanani, N., Facchini, P.J. Purification and characterization of norcochlorine synthase. The first committed enzyme in benzyloquinoline alkaloid biosynthesis in plants. *J. Biol. Chem.* **2002**, *277*, 33878–33883.
- 60 Samanani, N., Liscombe, D.K., Facchini, P.J. Molecular cloning and characterization of norcochlorine synthase, an enzyme catalyzing the first committed step in benzyloquinoline alkaloid biosynthesis. *Plant J.* **2004**, *40*, 302–313.

- 61 Frenzel, T., Zenk, M.H. Purification and characterization of three isoforms of S-adenosyl-methionine: (R,S)-Tetrahydrobenzylisoquinoline-N-methyltransferase from *Berberis koetianeana* cell cultures. *Phytochemistry* **1990**, *29*, 3491–3497.
- 62 Choi, K.B., Morishige, T., Shitan, N., Yazaki, K., Sato, F. Molecular cloning and characterization of coclaurine N-methyltransferase from cultured cells of *Coptis japonica*. *J. Biol. Chem.* **2002**, *277*, 830–835.
- 63 Morishige, T., Tsujita, T., Yamada, Y., Sato, F. Molecular characterization of the S-adenosyl-L-methionine:3'-hydroxy-N-methylcoclaurine 4'-O-methyltransferase involved in isoquinoline alkaloid biosynthesis in *Coptis japonica*. *J. Biol. Chem.* **2000**, *275*, 23398–23405.
- 64 Morishige, T., Dubouzet, E., Choi, K.-B., Yazaki, K., Sato, F. Molecular cloning of columbamine O-methyltransferase from cultured *Coptis japonica* cells. *Eur. J. Biochem.* **2002**, *269*, 5659–5667.
- 65 Loeffler, S., Zenk, M.H. The hydroxylation step in the biosynthetic pathway leading from norcoclaurine to reticuline. *Phytochemistry* **1990**, *29*, 3499–3503.
- 66 Dittrich, H., Kutchan, T. Molecular cloning, expression, and induction of berberine bridge enzyme, an enzyme essential to the formation of benzophenanthridine alkaloids in the response of plants to pathogenic attack. *Proc. Natl. Acad. Sci. USA* **1991**, *88*, 9969–9973.
- 67 Takeshita, N., Fujiwara, H., Mimura, H., Fitch, J.H., Yamada, Y., Sato, F. Molecular-cloning and characterization of S-adenosyl-L-methionine-scoulerine-9-O-methyltransferase from cultured-cells of *Coptis japonica*. *Plant Cell Physiol.* **1995**, *36*, 29–36.
- 68 Choi, K.-B., Morishige, T., Shitan, N., Yazaki, K., Sato, F. Molecular cloning and characterization of coclaurine N-methyltransferase from cultured cells of *Coptis japonica*. *J. Biol. Chem.* **2002**, *277*, 830–835.
- 69 Chou, W.-M., Kutchan, T.M. Enzymatic oxidations in the biosynthesis of complex alkaloids. *Plant J.* **1998**, *15*, 289–300.
- 70 Ikezawa, N., Tanaka, M., Nagayoshi, M., Shinkyo, R., Sakaki, T., Inouye, K., Sato, F. Molecular cloning and characterization of CYP719, a methylenedioxy bridge-forming enzyme that belongs to a novel P450 family, from cultured *Coptis japonica* cells. *J. Biol. Chem.* **2003**, *278*, 38557–38565.
- 71 Pauli, H.H., Kutchan, T.M. Molecular cloning and functional heterologous expression of two alleles encoding (S)-N-methylcoclaurine 3'-hydroxylase (CYP80B1), a new methyl jasmonate inducible cytochrome P 450 dependent mono oxygenase of benzylisoquinoline alkaloid biosynthesis. *Plant J.* **1998**, *13*, 793–801.
- 72 Kutchan, T.M. Heterologous expression of alkaloid biosynthetic genes – a review. *Gene* **1996**, *179*, 73–81.
- 73 Gerardy, R., Zenk, M.H. Purification and characterization of salutaridine: NADPH 7-oxidoreductase from *Papaver somniferum*. *Phytochemistry* **1993**, *34*, 125–132.
- 74 Lenz, R., Zenk, M. Purification and properties of codeinone reductase (NADPH) from *Papaver somniferum* cell cultures and differentiated plants. *Eur. J. Biochem.* **1995**, *233*, 132–139.
- 75 Gerardy, R., Zenk, M.H. Formation of salutaridine from (R)-reticuline by a membrane-bound cytochrome P-450 enzyme from *Papaver somniferum*. *Phytochemistry* **1993**, *32*, 79–86.
- 76 Lenz, R., Zenk, M.H. Acetyl coenzyme A:salutaridinol-7-O-acetyltransferase from *Papaver somniferum* plant cell cultures. *J. Biol. Chem.* **1995**, *270*, 31091–31096.
- 77 Frick, S., Kutchan, T.M. Molecular cloning and functional expression of O-methyltransferases common to isoquinoline alkaloid and phenylpropanoid biosynthesis. *Plant J.* **1999**, *17*, 329–339.
- 78 Huang, F.-C., Kutchan, T.M. Distribution of morphinan and benzo[c]phenanthridine alkaloid gene transcript accumulation in *Papaver somniferum*. *Phytochemistry* **2000**, *53*, 555–564.
- 79 Grothe, T., Lenz, R., Kutchan, T.M. Molecular characterization of the salutaridinol 7-O-acetyltransferase involved in morphine biosynthesis in opium poppy *Papaver somniferum*. *J. Biol. Chem.* **2001**, *276*, 30717–30723.



- 80 Unterlinner, B., Lenz, R., Kutchan, T.M. Molecular cloning and functional expression of codeinone reductase: the penultimate enzyme in morphine biosynthesis in the opium poppy *Papaver somniferum*. *Plant J.* **1999**, *18*, 465–475.
- 81 Rathbone, D.A., Bruce, N.C. Microbial transformation of alkaloids. *Curr. Opin. Microbiol.* **2002**, *5*, 274–281.
- 82 Boonstra, B., Rathbone, D.A., Bruce, N.C. Engineering novel biocatalytic routes for production of semisynthetic opiate drugs. *Biomol. Eng.* **2001**, *18*, 41–47.
- 83 Broun, P., Somerville, C. Progress in plant metabolic engineering. *Proc. Natl. Acad. Sci. USA* **2001**, *98*, 8925–8927.
- 84 Liang, P.-H., Ko, T.-P., Wang, A.H.J. Structure, mechanism and function of prenyltransferases. *Eur. J. Biochem.* **2002**, *269*, 3339–3354.
- 85 Rodriguez-Concepcion, M., Boronat, A. Elucidation of the methylerythritol phosphate pathway for isoprenoid biosynthesis in bacteria and plastids. A metabolic milestone achieved through genomics. *Plant Physiol.* **2002**, *130*, 1079–1089.
- 86 Boucher, Y., Doolittle, W.F. The role of lateral gene transfer in the evolution of isoprenoid biosynthesis pathways. *Mol. Microbiol.* **2000**, *37*, 703–716.
- 87 Sherman, M.M., Petersen, L.A., Poulter, C.D. Isolation and characterization of isoprene mutants of *Escherichia coli*. *J. Bacteriol.* **1989**, *171*, 3619–3628.
- 88 Kuzuyama, T., Seto, H. Diversity of the biosynthesis of the isoprene units. *Nat. Prod. Rep.* **2003**, *20*, 171–183.
- 89 Dewick, P.M. The biosynthesis of C-5-C-25 terpenoid compounds. *Nat. Prod. Rep.* **2002**, *19*, 181–222.
- 90 Estevez, J.M., Cantero, A., Reindl, A., Reichler, S., Leon, P. 1-Deoxy-D-xylulose-5-phosphate synthase, a limiting enzyme for plastidic isoprenoid biosynthesis in plants. *J. Biol. Chem.* **2001**, *276*, 22901–22909.
- 91 Farmer, W.R., Liao, J.C. Improving lycopene production in *Escherichia coli* by engineering metabolic control. *Nature Biotechnol.* **2000**, *18*, 533–537.
- 92 Kim, S.W., Keasling, J.D. Metabolic engineering of the nonmevalonate isopentenyl diphosphate synthesis pathway in *Escherichia coli* enhances lycopene production. *Biotechnol. Bioeng.* **2001**, *72*, 408–415.
- 93 Kajiwara, S., Fraser, P.D., Kondo, K., Misawa, N. Expression of an exogenous isopentenyl diphosphate isomerase gene enhances isoprenoid biosynthesis in *Escherichia coli*. *Biochem. J.* **1997**, *324*, 421–426.
- 94 Lee, P.C., Schmidt-Dannert, C. Metabolic engineering towards biotechnological production of carotenoids in microorganisms. *Appl. Microbiol. Biotechnol.* **2002**, *60*, 1–11.
- 95 Martin, V.J.J., Pitera, D.J., Withers, S.T., Newman, J.D., Keasling, J.D. Engineering a mevalonate pathway in *Escherichia coli* for production of terpenoids. *Nature Biotechnol.* **2003**, *21*, 796–802.
- 96 Alper, H., Jin, Y.S., Moxley, J.F., Stephanopoulos, G. Identifying gene targets for the metabolic engineering of lycopene biosynthesis in *Escherichia coli*. *Metab. Eng.* **2005**, *7*, 155–164.
- 97 Alper, H., Miyaoku, K., Stephanopoulos, G. Construction of lycopene-overproducing *E. coli* strains by combining systematic and combinatorial gene knockout targets. *Nature Biotechnol.* **2005**, *23*, 612–616.
- 98 Bohlmann, J., Meyer-Gauen, G., Croteau, R. Plant terpenoid synthases: Molecular biology and phylogenetic analysis. *Proc. Natl. Acad. Sci. USA* **1998**, *95*, 4126–4133.
- 99 Davis, E.M., Croteau, R. Cyclization enzymes in the biosynthesis of monoterpenes, sesquiterpenes, and diterpenes. *Top. Curr. Chem.* **2000**, *209*, 53–95.
- 100 Steele, C.L., Crock, J., Bohlmann, J., Croteau, R. Sesquiterpene synthases from Grand Fir (*Abies grandis*). *J. Biol. Chem.* **1998**, *273*, 2078–2089.
- 101 Trapp, S.C., Croteau, R.B. Genomic organization of plant terpene synthases and molecular evolutionary implications. *Genetics* **2001**, *158*, 811–832.
- 102 Aubourg, S., Lecharny, A., Bohlmann, J. Genomic analysis of the terpenoid synthase gene family of *Arabidopsis thaliana*. *Mol. Gen. Genomics* **2002**, *267*, 730–745.
- 103 Phillips, M.A., Wildung, M.R., Williams, D.C., Hyatt, D.C., Croteau, R. cDNA



- isolation, functional expression, and characterization of (+)-alpha-pinene synthase and (-)-alpha-pinene synthase from loblolly pine (*Pinus taeda*): Stereo-control in pinene biosynthesis. *Arch. Biochem. Biophys.* **2003**, *411*, 267–276.
- 104 Huber, D.P.W., Philippe, R.N., Godard, K.A., Sturrock, R.N., Bohlmann, J. Characterization of four terpene synthase cDNAs from methyl jasmonate-induced Douglas-fir, *Pseudotsuga menziesii*. *Phytochemistry* **2005**, *66*, 1427–1439.
- 105 Martin, D.M., Bohmann, J. Identification of *Vitis vinifera* (-)-alpha-terpineol synthase by in silico screening of full-length cDNA ESTs and functional characterization of recombinant terpene synthase. *Phytochemistry* **2004**, *65*, 1223–1229.
- 106 Bohlmann, J., Martin, D., Oldham, N.J., Gershenzon, J. Terpenoid secondary metabolism in *Arabidopsis thaliana*: cDNA cloning, characterization, and functional expression of a myrcene/(E)-beta-ocimene synthase. *Arch. Biochem. Biophys.* **2000**, *375*, 261–269.
- 107 Faldt, J., Arimura, G., Gershenzon, J., Takabayashi, J., Bohlmann, J. Functional identification of AtTPS03 as (E)-beta-ocimene synthase: a monoterpene synthase catalyzing jasmonate- and wound-induced volatile formation in *Arabidopsis thaliana*. *Planta* **2003**, *216*, 745–751.
- 108 Chen, F., Ro, D., Petri, J., Gershenzon, J., Bohlmann, J., Pichersky, E., Tholl, D. Characterization of a root-specific *Arabidopsis* terpene synthase responsible for the formation of the volatile monoterpene 1,8-Cineole. *Plant Physiol.* **2004**, *135*, 1956–1966.
- 109 Little, D.B., Croteau, R.B. Alteration of product formation by directed mutagenesis and truncation of the multiple-product sesquiterpene synthases delta-selinene synthase and gamma-humulene synthase. *Arch. Biochem. Biophys.* **2002**, *402*, 120–135.
- 110 Segura, M.J.R., Jackson, B.E., Matsuda, S.P.T. Mutagenesis approaches to deduce structure-function relationships in terpene synthases. *Nat. Prod. Rep.* **2003**, *20*, 304–317.
- 111 Rising, K.A., Starks, C.M., Noel, J.P., Chappell, J. Demonstration of germacrene A as an intermediate in 5-epi-aristolochene synthase catalysis. *J. Am. Chem. Soc.* **2000**, *122*, 1861–1866.
- 112 Jennewein, S., Croteau, R. Taxol: biosynthesis, molecular genetics, and biotechnological applications. *Appl. Microbiol. Biotechnol.* **2001**, *57*, 13–19.
- 113 Wildung, M.R., Croteau, R. A cDNA clone for taxadiene synthase, the diterpene cyclase that catalyzes the committed step of taxol biosynthesis. *J. Biol. Chem.* **1996**, *271*, 9201–9204.
- 114 Walker, K., Croteau, R. Taxol biosynthetic genes. *Phytochemistry* **2001**, *58*, 1–7.
- 115 Jennewein, S., Wildung, M.R., Chau, M., Walker, K., Croteau, R. Random sequencing of an induced *Taxus* cell cDNA library for identification of clones involved in Taxol biosynthesis. *Proc. Natl. Acad. Sci. USA* **2004**, *101*, 9149–9154.
- 116 Schoendorf, A., Rithner, C.D., Williams, R.M., Croteau, R.B. Molecular cloning of a cytochrome P450 taxane 10beta-hydroxylase cDNA from *Taxus* and functional expression in yeast. *Proc. Natl. Acad. Sci. USA* **2001**, *98*, 1501–1506.
- 117 Jennewein, S., Long, R.M., Williams, R.M., Croteau, R. Cytochrome P450 taxadiene 5 alpha-hydroxylase, a mechanistically unusual monooxygenase catalyzing the first oxygenation step of taxol biosynthesis. *Chem. Biol.* **2004**, *11*, 379–387.
- 118 Jennewein, S., Rithner, C.D., Williams, R.M., Croteau, R. Taxoid metabolism: Taxoid 14 beta-hydroxylase is a cytochrome P450-dependent monooxygenase. *Arch. Biochem. Biophys.* **2003**, *413*, 262–270.
- 119 Jennewein, S., Rithner, C.D., Williams, R.M., Croteau, R.B. Taxol biosynthesis: Taxane 13alpha-hydroxylase is a cytochrome P450-dependent monooxygenase. *Proc. Natl. Acad. Sci. USA* **2001**, *98*, 13 595–13 600.
- 120 Chau, M., Croteau, R. Molecular cloning and characterization of a cytochrome P450 taxoid 2 alpha-hydroxylase involved in Taxol biosynthesis. *Arch. Biochem. Biophys.* **2004**, *427*, 48–57.

- 121 Chau, M., Jennewein, S., Walker, K., Croteau, R. Taxol biosynthesis: Molecular cloning and of a cytochrome p450 characterization taxoid 7 beta-hydroxylase. *Chem. Biol.* **2004**, *11*, 663–672.
- 122 Walker, K., Croteau, R. Molecular cloning of a 10-deacetylbaaccatin III-10-O-acetyl transferase cDNA from *Taxus* and functional expression in *Escherichia coli*. *Proc. Natl. Acad. Sci. USA* **2000**, *97*, 583–587.
- 123 Walker, K., Croteau, R. Taxol biosynthesis: Molecular cloning of a benzoyl-CoA:taxane 2alpha-O-benzoyltransferase cDNA from *Taxus* and functional expression in *Escherichia coli*. *Proc. Natl. Acad. Sci. USA* **2000**, *97*, 13591–13596.
- 124 Walker, K., Fujisaki, S., Long, R., Croteau, R. Molecular cloning and heterologous expression of the C-13 phenylpropanoid side chain-CoA acyltransferase that functions in Taxol biosynthesis. *Proc. Natl. Acad. Sci. USA* **2002**, *99*, 12715–12720.
- 125 Walker, K., Long, R., Croteau, R. The final acylation step in Taxol biosynthesis: Cloning of the taxoid C13-side-chain N-benzoyltransferase from *Taxus*. *Proc. Natl. Acad. Sci. USA* **2002**, *99*, 9166–9171.
- 126 Walker, K.D., Klettke, K., Akiyama, T., Croteau, R. Cloning, heterologous expression, and characterization of a phenylalanine aminomutase involved in Taxol biosynthesis. *J. Biol. Chem.* **2004**, *279*, 53947–53954.
- 127 Huang, Q.L., Roessner, C.A., Croteau, R., Scott, A.I. Engineering *Escherichia coli* for the synthesis of taxadiene, a key intermediate in the biosynthesis of taxol. *Bioorganic Medicin. Chem.* **2001**, *9*, 2237–2242.
- 128 Hefner, J., Ketchum, R.E.B., Croteau, R. Cloning and functional expression of a cDNA encoding geranylgeranyl diphosphate synthase from *Taxus canadensis* and assessment of the role of this prenyltransferase in cells induced for Taxol production. *Arch. Biochem. Biophys.* **1998**, *360*, 62–74.
- 129 Pompon, D., Louerat, B., Bronine, A., Urban, P. Yeast expression of animal and plant P450s in optimized redox environments. *Methods Enzymol.* **1996**, *272*, 51–64.
- 130 Jennewein, S., Park, H., DeJong, J.M., Long, R.M., Bollon, A.P., Croteau, R.B. Coexpression in yeast of *Taxus* cytochrome P450 reductase with cytochrome P450 oxygenases involved in taxol biosynthesis. *Biotechnol. Bioeng.* **2005**, *89*, 588–598.
- 131 Dejong, J.M., Liu, Y., Bollon, A.P., Long, R.M., Jennewein, S., Williams, D., Croteau, R.B. Genetic engineering of taxol biosynthetic genes in *Saccharomyces cerevisiae*. *Biotechnol. Bioeng.* **2006**, *93*, 212–224.
- 132 Besumbes, O., Sauret-Guetom S., Phillips, M.A., Imperial, S., Rodriguez-Concepcion, M., Boronat, A. Metabolic engineering of isoprenoid biosynthesis in *Arabidopsis* for the production of taxadiene, the first committed precursor of Taxol. *Biotechnol. Bioeng.* **2004**, *88*, 168–175.
- 133 Mercke, P., Bengtsson, M., Bouwmeester, H.J., Posthumus, M.A., Brodelius, P.E. Molecular cloning, expression, and characterization of amorpha-4,11-diene synthase, a key enzyme of artemisinin biosynthesis in *Artemisia annua* L. *Arch. Biochem. Biophys.* **2000**, *381*, 173–180.
- 134 Picaud, S., Brodelius, M., Brodelius, P.E. Expression, purification and characterization of recombinant (E)-beta-farnesene synthase from *Artemisia annua*. *Phytochemistry* **2005**, *66*, 961–967.
- 135 Berteau, C.M., Freije, J.R., van der Woude, H., Verstappen, F.W.A., Perk, L., Marquez, V., De Kraker, J.-W., Posthumus, M.A., Jansen, B.J.M., de Groot, A., Franssen, M.C.R., Bouwmeester, H.J. Identification of intermediates and enzymes involved in the early steps of artemisinin biosynthesis in *Artemisia annua*. *Planta Med.* **2005**, *71*, 40–47.
- 136 Vincent, J., Martin, J., Yoshikuni, Y., Keasling, J.D. The in vivo synthesis of plant sesquiterpenes by *Escherichia coli*. *Biotechnol. Bioeng.* **2001**, *75*, 497–503.
- 137 Ye, X., Al-Babili, S., Klott, A., Zhang, J., Lucca, P., Beyer, P., Potrykus, I. Engineering the provitamin A

- ( $\beta$ -carotene) biosynthetic pathway into (carotenoid-free) rice endosperm. *Science* **2000**, *287*, 303–305.
- 138 Al-Babili, S., Beyer, P. Golden Rice – five years on the road – five years to go? *Trends Plant Sci.* **2005**, *10*, 565–573.
- 139 Ernst, H. Recent advances in industrial carotenoid synthesis. *Pure Appl. Chem.* **2002**, *74*, 1369–1382.
- 140 Valla, A.R., Cartier, D.L., Labia, R. Chemistry of natural retinoids and carotenoids: Challenges for the future. *Curr. Org. Synth.* **2004**, *1*, 167–209.
- 141 Sandmann, G. Combinatorial biosynthesis of carotenoids in a heterologous host: A powerful approach for the biosynthesis of novel structures. *Chembiochem* **2002**, *3*, 629–635.
- 142 Mijts, B.N., Lee, P.C., Schmidt-Dannert, C. In: *Methods in Enzymology*, Volume 388. Academic Press, **2004**, pp. 315–329.
- 143 Lee, P.C., Momen, A.Z.R., Mijts, B.N., Schmidt-Dannert, C. Biosynthesis of structurally novel carotenoids in *Escherichia coli*. *Chem. Biol.* **2003**, *10*, 453–462.
- 144 Matthews, P.D., Wurtzel, E.T. Metabolic engineering of carotenoid accumulation in *Escherichia coli* by modulation of the isoprenoid precursor pool with expression of deoxyxylulose phosphate synthase. *Appl. Microbiol. Biotechnol.* **2000**, *53*, 396–400.
- 145 Jones, K.L., Kim, S.-W., Keasling, J.D. Low-copy plasmids can perform as well as or better than high-copy plasmids for metabolic engineering of bacteria. *Metab. Eng.* **2000**, *2*, 328–338.
- 146 Farmer, W.R., Liao, J.C. Precursor balancing for metabolic engineering of lycopene production in *Escherichia coli*. *Biotechnol. Prog.* **2001**, *17*, 57–61.
- 147 Smolke, C.D., Martin, V.J.J., Keasling, J.D. Controlling the metabolic flux through the carotenoid pathway using directed mRNA processing and stabilization. *Metab. Eng.* **2001**, *3*, 313–321.
- 148 Umeno, D., Tobias, A.V., Arnold, F.H. Diversifying carotenoid biosynthetic pathways by directed evolution. *Microbiol. Mol. Biol. Rev.* **2005**, *69*, 51–78.
- 149 Schmidt-Dannert, C. Directed evolution of single proteins, metabolic pathways, and viruses. *Biochemistry* **2001**, *40*, 13125–13136.
- 150 Schmidt-Dannert, C., Umeno, D., Arnold, F.H. Molecular breeding of carotenoid biosynthetic pathways. *Nature Biotechnol.* **2000**, *18*, 750–753.
- 151 Mijts, B.N., Lee, P.C., Schmidt-Dannert, C. Identification of a carotenoid oxygenase synthesizing acyclic xanthophylls: combinatorial biosynthesis and directed evolution. *Chem. Biol.* **2005**, *12*, 453–460.
- 152 Umeno, D., Arnold, F.H. Evolution of a pathway to novel long-chain carotenoids. *J. Bacteriol.* **2004**, *186*, 1531–1536.
- 153 Umeno, D., Arnold, F.H. A C35 carotenoid biosynthetic pathway. *Appl. Environ. Microbiol.* **2003**, *69*, 3573–3579.
- 154 Winkel-Shirley, B. Flavonoid biosynthesis. A colorful model for genetics, biochemistry, cell biology, and biotechnology. *Plant Physiol.* **2001**, *126*, 485–493.
- 155 Harborne, J.B., Williams, C.A. Advances in flavonoid research since 1992. *Phytochemistry* **2000**, *55*, 481–504.
- 156 Aoki, T., Akashi, T., Ayabe, S. Flavonoids of leguminous plants: Structure, biological activity, and biosynthesis. *J. Plant Res.* **2000**, *113*, 475–488.
- 157 Dixon, R.A., Achnine, L., Kota, P., Liu, C.-J., Reddy, M.S.S., Wang, L. The phenylpropanoid pathway and plant defense – a genomics perspective. *Mol. Plant Pathol.* **2002**, *3*, 371–390.
- 158 Jeandet, P., Douillet-Breuil, A.-C., Bessis, R., Debord, S., Sbaghi, M., Adrian, M. Phytoalexins from the vitaceae: biosynthesis, phytoalexin gene expression in transgenic plants, antifungal activity, and metabolism. *J. Agricult. Food Chem.* **2002**, *50*, 2731–2741.
- 159 Springob, K., Nakajima, J., Yamazaki, M., Saito, K. Recent advances in the biosynthesis and accumulation of anthocyanins. *Nat. Prod. Rep.* **2003**, *20*, 288–303.
- 160 Stafford, H.A. Roles of flavonoids in symbiotic and defense functions in legume roots. *Bot. Rev.* **1997**, *63*, 27–39.
- 161 Dixon, R.A., Ferreira, D. Genistein. *Phytochemistry* **2002**, *60*, 205–211.
- 162 Austin, M.B., Noel, A.J.P. The chalcone synthase superfamily of type III polyketide synthases. *Nat. Prod. Rep.* **2003**, *20*, 79–110.
- 163 Ferrer, J.L., Jez, J.M., Bowman, M.E., Dixon, R.A., Noel, J.P. Structure of

- chalcone synthase and the molecular basis of plant polyketide biosynthesis. *Nat. Struct. Biol.* **1999**, *6*, 775–784.
- 164** Jez, J.M., Ferrer, J.L., Bowman, M., Dixon, R.A., Noel, J.P. Structure of chalcone synthase and the molecular basis of plant polyketide biosynthesis. *FASEB J.* **1999**, *13*, A1392–A1392.
- 165** Jez, J.M., Ferrer, J.-L., Bowman, M.E., Austin, M.B., Schroder, J., Dixon, R.A., Noel, J.P. Structure and mechanism of chalcone synthase-like polyketide synthases. *J. Ind. Microbiol. Biotechnol.* **2001**, *27*, 393–398.
- 166** Hwang, E.I., Kaneko, M., Ohnishi, Y., Horinouchi, S. Production of plant-specific flavanones by *Escherichia coli* containing an artificial gene cluster. *Appl. Environ. Microbiol.* **2003**, *69*, 2699–2706.
- 167** Miyahisa, I., Kaneko, M., Funa, N., Kawasaki, H., Kojima, H., Ohnishi, Y., Horinouchi, S. Efficient production of (2S)-flavanones by *Escherichia coli* containing an artificial biosynthetic gene cluster. *Appl. Microbiol. Biotechnol.* **2005**, *68*, 498–504.
- 168** Watts, K.T., Lee, P.C., Schmidt-Dannert, C. Exploring recombinant flavonoid biosynthesis in metabolically engineered *Escherichia coli*. *Chembiochem* **2004**, *5*, 500–507.
- 169** Jiang, H.X., Wood, K.V., Morgan, J.A. Metabolic engineering of the phenylpropanoid pathway in *Saccharomyces cerevisiae*. *Appl. Environ. Microbiol.* **2005**, *71*, 2962–2969.
- 170** Yan, Y.J., Kohli, A., Koffas, M.A.G. Biosynthesis of natural flavanones in *Saccharomyces cerevisiae*. *Appl. Environ. Microbiol.* **2005**, *71*, 5610–5613.
- 171** Leonard, E., Yan, Y.J., Lim, K.H., Koffas, M.A.G. Investigation of two distinct flavone synthases for plant-specific flavone biosynthesis in *Saccharomyces cerevisiae*. *Appl. Environ. Microbiol.* **2005**, *71*, 8241–8248.
- 172** Becker, J.V., Armstrong, G.O., van der Merwe, M.J., Lambrechts, M.G., Vivier, M.A., Pretorius, I.S. Metabolic engineering of *Saccharomyces cerevisiae* for the synthesis of the wine-related antioxidant resveratrol. *FEMS Yeast Res.* **2003**, *4*, 79–85.
- 173** Szczebara, F.M., Chandelier, C., Villeret, C., Masurel, A., Bourot, S., Dupont, C., Blanchard, S., Groisillier, A., Testet, E., Costaglioli, P., Cauet G., Degryse, E., Balbuena, D., Wnter, J., Achstetter, T., Spagnoli, R., Pompon, D., Dumas, B. Total biosynthesis of hydrocortisone from a simple carbon source in yeast. *Nature Biotechnol.* **2003**, *21*, 143–149.

## 14

# Production of Therapeutic Antibodies in Plants

*Richard M. Twyman, Stefan Schillberg, and Rainer Fischer*

### 14.1

#### Introduction

Plants have a long history of medicinal use, and today more than one quarter of all the world's medicines are either obtained from plants or contain components derived from plants [1]. Until comparatively recently, it was only the natural products of plants that could be extracted and utilized as medicines. During the 1980s, however, techniques for gene transfer to plants were developed, and since that time it has been possible to manipulate the plant genome and create transgenic lines for the production of particular therapeutic molecules [2]. Some attempts have been made to alter plant metabolism and produce "small-molecule drugs", but the greatest success has been achieved with the expression of recombinant therapeutic proteins. These are traditionally produced either in microbial fermenters or cultured mammalian cells, which are expensive to establish and maintain, and are limited in capacity and scalability. By using plants, however, it is possible to address all of these problems [3–7].

The first potentially therapeutic protein to be expressed in plants was human serum albumin, which was produced in tobacco and potato leaves and suspension cells in 1990 [8]. Since then, over 100 pharmaceutical proteins have been produced in a variety of plants, including tobacco, cereals, legumes, fruit and vegetable crops, fodder crops, edible foliage such as lettuce and spinach, oilseeds, and aquatic or unicellular plant species grown in bioreactors [3, 7]. The diversity of pharmaceutical recombinant proteins produced in such hosts is vast, and due to the variety of host plants and expression systems, it has been difficult to draw any meaningful comparisons so as to determine the most suitable platform. Inevitably, the result has been a large collection of "proof-of-principle" studies which have been subject to empirical and case-by-case evaluation.

Antibodies are an exception to this general rule. A large number of different antibody molecules has been expressed in plants (Table 14.1), but since antibodies of the same format differ only in their variable regions, viable comparisons can be made across diverse systems. Research into the production of plant-derived anti-

bodies has thus helped to evaluate different hosts and expression strategies, for example the benefits of different promoters, tissues, subcellular targeting strategies and downstream processing approaches. As might be expected, antibodies are therefore at the forefront of commercial molecular farming and are likely to be among the first plant-derived pharmaceutical proteins available commercially [3, 9]. Thus, in this chapter attention is focused on the production of antibodies in plants.

**Table 14.1** A selection of recombinant therapeutic or diagnostic recombinant antibodies produced by molecular farming in plants and reported in the scientific literature (many antibodies in commercial development remain undisclosed until IP rights have been secured). Antibodies with non-medical applications, such as the modulation of plant metabolism or the neutralization of plant pathogens, are not listed.

<b>Antigen</b>	<b>Antibody format</b>	<b>Production system</b>	<b>Comments</b>	<b>Reference(s)</b>
B-cell lymphoma, murine 38C13	scFv	Virus vectors in tobacco leaves	Maximum yield 30.2 $\mu\text{g g}^{-1}$ leaves	50
Carcinoembryonic antigen	scFv, IgG1	Tobacco agroinfiltration	Directed to apoplast or ER. Maximum yields 5 $\mu\text{g scFv g}^{-1}$ leaves, 1 $\mu\text{g IgG g}^{-1}$ leaves	99
	dAb	Tobacco, agroinfiltration and transgenic		47
	scFv	Rice, rice cell cultures	Directed to apoplast or ER. Maximum yields 3.8 $\mu\text{g g}^{-1}$ callus, 29 $\mu\text{g g}^{-1}$ leaves, 32 $\mu\text{g g}^{-1}$ seed	28, 100
		Wheat	Directed to apoplast or ER. Maximum yields 900 $\text{ng g}^{-1}$ leaves, 1.5 $\mu\text{g g}^{-1}$ seed	28
		Pea	Directed to r ER. Maximum yield 9 $\mu\text{g g}^{-1}$ seed	27, 28
Colon cancer antigen	IgG	Virus vectors in tobacco leaves	Yield not reported.	80
Creatine kinase	IgG1, Fab	Tobacco leaves <i>Arabidopsis</i> leaves	Maximum yield 1.3% TSP.	101
Rhesus D antigen	IgG1	<i>Arabidopsis</i> leaves		102
Ferritin	scFv	Tobacco leaves		103
Hepatitis B virus surface antigen	IgG	Tobacco leaves	Up to 25 $\text{mg kg}^{-1}$	104, 105
Herpes simplex virus 2	IgG1	Soybean	Secreted to apoplast. Yield not reported.	36
HIV antibodies in blood	scFv-fusion	Tobacco leaves, barley grains, potato tubers	150 $\text{mg g}^{-1}$	45
Human chorionadotropin	scFv, dAb, IgG	Tobacco leaves	Secreted to apoplast. Maximum yield 40 $\text{mg kg}^{-1}$ fresh weight	106

Table 14.1 Continued

<i>Antigen</i>	<i>Antibody format</i>	<i>Production system</i>	<i>Comments</i>	<i>Reference(s)</i>
Human IgG	IgG1	Alfalfa	Secreted to apoplast. Maximum yield 1% TSP.	35
Interleukin-4	scFv	Tobacco roots		107
Interleukin-6	scFv	Tobacco roots	Up to 0.18% TSP	
Streptococcal surface antigen (I/II)	sIgA	Tobacco leaves	Secreted to apoplast. Maximum yield 500 $\mu\text{g g}^{-1}$ fresh weight	79
	IgG1	Tobacco leaves	Directed to plasma membrane. Maximum yield 1.1% TSP leaves	108
	IgG1	Secretion from tobacco roots	Up to 11.7 $\mu\text{g g}^{-1}$ dry root weight per day	33
Substance P	V <sub>H</sub>	Tobacco leaves	Secreted to apoplast. Maximum yield 1% TSP.	109

ER: endoplasmic reticulum; TSP: total soluble protein.

## 14.2

### The Evolution of Recombinant Antibody Technology

#### 14.2.1

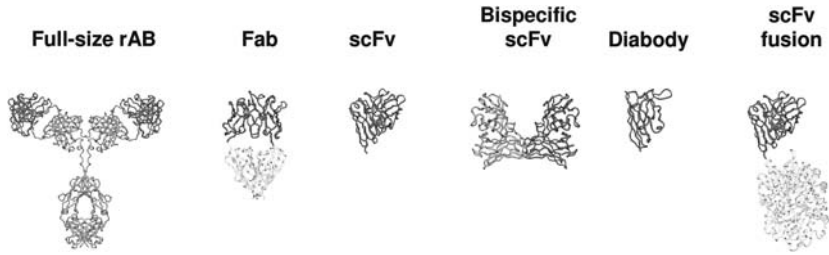
##### The Importance of Recombinant Antibodies

Antibodies are complex glycoproteins which are produced by the vertebrate immune system and recognize and bind to target antigens with great specificity. This individual and specific binding activity allows antibodies to be used for a variety of applications, including the diagnosis, prevention and treatment of disease [10, 11]. Based on our own research, we estimate that approximately 1000 therapeutic recombinant antibodies are currently being developed by biopharmaceutical companies worldwide, and over 200 of these are already undergoing clinical trials. A large proportion of these antibodies recognize cancer antigens, but others have been developed for the diagnosis and treatment of infectious diseases, autoimmune disorders, cardiovascular disease, blood disorders, neurological disorders, skin disorders, respiratory diseases, eye diseases and transplant rejection [12].

#### 14.2.2

##### Structure of Naturally Produced Antibodies

Mammalian serum antibodies comprise two identical heavy chains and two identical light chains joined by disulfide bonds (Fig. 14.1). Each heavy chain is folded into four domains, two either side of a flexible “hinge” which allows the multimeric protein to adopt its characteristic Y-shape. Each light chain is also folded into two



**Fig. 14.1** Types of recombinant antibody expressed in plants. rAB = recombinant antibody; Fab = fragment antigen binding; scFv = single chain Fv fragment. Note: A color version of this figure is available in the color plate section.

domains. The N-terminal domain of each of the four chains is variable – that is, it differs among individual B-cells due to unique rearrangements of the germline immunoglobulin genes. This part of the molecule is responsible for antigen recognition and binding. The remainder of the antibody comprises a series of constant domains, which are involved in effector functions such as immune cell recognition and complement fixation. Below the hinge, in what is known as the Fc portion of the antibody, the constant domains are class-specific. Mammals produce five classes of immunoglobulins (IgG, IgM, IgA, IgD and IgE) each with different effector functions. The Fc region also contains a conserved asparagine residue at position 297 to which N-glycan chains are added. The glycan chains play an important role both in the folding of the protein and the performance of effector functions [13]. Antibodies are found in mucosal secretions as well as serum, but these secretory antibodies have a more complex structure than their serum counterparts. They are dimers of the serum-type antibody, the two monomers being attached by an additional component called the joining chain. There is also a further polypeptide called the secretory component, which protects the antibodies from proteases.

#### 14.2.3

#### Antibody Derivatives

The constant regions of native immunoglobulins are not required for antigen recognition, so it is possible to express smaller derivative molecules and still retain antigen-binding specificity [11]. Such derivatives include Fab and  $F(ab')_2$  fragments (which contain only the sequences distal to the hinge region) and single chain Fv fragments (scFvs) which contain the variable regions of the heavy and light chains joined by a flexible peptide chain. Such derivatives are often more effective as drugs than full-length immunoglobulins because they show increased penetration of target tissues, reduced immunogenicity, and they are cleared from tissues more rapidly. Other derivatives include bispecific scFvs, which contain the antigen-recognition elements of two different immunoglobulins and can bind to two different antigens [14], and scFv-fusions, which are linked to proteins with additional functions [15, 16] (Fig. 14.1).



## 14.2.4

**Humanized Antibodies**

The traditional source of monoclonal antibodies is murine B cells. To provide a constant source of the antibody, B cells of appropriate specificity are fused to immortal myeloma cells to produce a hybridoma cell line. The use of murine hybridoma-derived antibodies as therapeutics is limited because the murine components of the antibodies are immunogenic in humans (see below). Therefore, numerous strategies have been developed to humanize murine monoclonal antibodies [17], culminating in the production of transgenic mice expressing the human immunoglobulin repertoire [18]. An alternative approach is to use phage display libraries based on the human immune repertoires for the production of scFvs. Phage display is advantageous because high-affinity antibodies can be identified rapidly, novel combinations of heavy and light chains can be tested, and the DNA sequence encoding the antibody is indirectly linked to the antibody itself [19, 20]. This avoids the laborious isolation of cDNA or genomic immunoglobulin sequences from hybridoma cell lines.

## 14.3

**Production of Recombinant Antibodies in Plants**

## 14.3.1

**Traditional Expression Systems**

Most antibodies approved by the Food and Drug Administration (FDA) are produced in mammalian cells. There are several principal cell lines of choice: Chinese hamster ovary (CHO) cells, the murine myeloma cells lines NS0 and SP2/0, baby hamster kidney (BHK), and human embryonic kidney (HEK)-293 cells, and the human retinal line PER-C6. Indeed, these have been used to produce almost all of the mammal-derived recombinant therapeutic products licensed by the FDA [21, 22]. The main reason for this is the belief that mammalian cells yield authentic products, particularly in terms of glycosylation patterns. However, there are minor differences in glycan chain structure between rodent and human cells. For example, human antibodies contain only the sialic acid residue *N*-acetylneuraminic acid (NANA), while rodents produce a mixture of NANA and *N*-glycosylneuraminic acid (NGNA) [23]. There are also many disadvantages to mammalian cell cultures, including the high set-up and running costs, the limited opportunities for scale-up, and the potential contamination of purified recombinant antibodies with human pathogens. Bacterial fermentation systems are more cost-effective than mammalian cell cultures, and are therefore preferred for the production of Fab fragments and scFvs as these derivatives are not glycosylated. Even so, the yields of such products in bacteria can be low because the proteins do not fold properly [11].

A more recent development is the production of antibodies in the milk of transgenic animals [24, 25]. Recombinant proteins can be harvested periodically, and

the yields are potentially very high. For example, a humanized version of the BR96 anti-Lewis Y monoclonal antibody developed by Bristol Myers Squibb for cancer therapy has been produced in goats. Expression levels ranged from 0.1 to 14 g L<sup>-1</sup>, the antibody was functional, and it could be isolated and prepared to a purity in excess of 99% [26]. However, the production of transgenic farm animals is a difficult process and involves a long development phase with many regulatory hurdles. Scale-up is slow, being dependent on the animal's natural breeding cycle, and it is necessary to maintain a founder herd carrying the transgene of interest. As with mammalian cell lines, there are safety concerns about the transmission of pathogens or oncogenic DNA sequences.

#### 14.3.2

##### **The Advantages of Plants**

Plants are advantageous as production systems because they address the rapidly increasing demand for diagnostic and therapeutic antibodies, and the insufficient capacity of the current supply chain to provide them. It has been estimated that fermenter production capacity must increase at least tenfold over the next decade in order to meet the projected increase in demand, given that over 300 novel protein-based drugs and diagnostics are currently going through clinical trials and many more are in the development pipeline [10]. As stated above, antibodies represent a large proportion of these molecules.

The reliance on microbial and mammalian cell cultures for recombinant antibody production not only places a heavy demand on worldwide production capacities, it also drives up the price of the resulting drugs. The expense of building and running fermenter systems makes the production of all but the most valuable recombinant proteins economically unfeasible. This reflects the need for equipment, skilled workers and, in the case of mammalian cell cultures, expensive culture media. Transgenic plants on the other hand can be grown and harvested using traditional agricultural practices and do not need any specialized medium [3, 7]. The cost of scaling fermenter-based production up or down in response to demand can be high, whereas with plants the same can be achieved simply by changing the amount of land dedicated to a particular "pharma" crop. Plants are also inherently safe, lacking the viruses, prions and other undesirable components that could potentially exist in mammalian cell cultures and transgenic animals. The presence of endotoxins in bacterial cultures can place similar limitations on the use of microbial production systems. The major advantage of these fermenter systems, however, is the constant, defined environment and the regulatory framework that has evolved around them. In contrast, a disadvantage of field-grown plants is that it will be much more difficult to apply the principles of good manufacturing practice (GMP) given the variable climate, soil composition and weather. It remains to be seen how the rigid regulatory framework that currently governs fermenter-based production systems can be adapted for field-grown plants.

Another issue addressed by the use of plant production systems is the delivery and storage of medicines. The developed world is accustomed to readily available

drugs in various formulations, and most of us take for granted the ability to store and distribute medicines in either refrigerated containers or as frozen stocks. In the developing world, however, reliable storage and distribution networks cannot be guaranteed, and delivering medicines to those most in need can be very difficult. Plants provide the ideal solution to this problem because proteins expressed in certain plant tissues (e.g., cereal seeds) remain stable for years at ambient temperatures without loss of activity, and can therefore be stored and distributed without a cold chain [6].

#### 14.3.3

##### **Limitations that Need to be Addressed**

Notwithstanding the benefits discussed above, several issues need to be addressed in order for transgenic plants to become widely accepted as a mainstream alternative to microbial and mammalian cell fermentation. First and foremost, it will be necessary to increase the yields of recombinant antibodies that can be achieved using transgenic plants, as in most cases these fall below the threshold required for commercial viability. A standardized system for reporting yields also needs to be agreed by the community. At the current time, research teams in different laboratories present their yields in various ways that are difficult to compare directly – these may be as percentage total soluble protein, or as yield per gram fresh weight or dry weight, or as a concentration in exudates or culture supernatant. Researchers are also breaking away from the idea that achieving high expression levels is the key goal of molecular farming. Instead, attention is turning to concepts such as improving protein stability, and improving the downstream processing stages of production to improve protein quality and batch-to-batch consistency. In this context, glycosylation is an important consideration. Although plants and mammals add glycan chains to the same positions on recombinant antibodies, the precise structure of the glycans is distinct. This, together with the problem of heterogeneous glycosylation, must be addressed before plants can be considered as suitable for antibody production under GMP conditions. The products themselves also need to be subjected to a battery of tests for toxicity, stability and allergenicity to ensure that they are “biosimilar” to equivalent recombinant antibodies synthesized in fermenter-based systems. Another widespread public concern about the use of transgenic plants as pharmaceutical factories is that of biosafety, which is based on fears of potential transgene spread in the environment, pollution of the human food chain with recombinant plant material, and the unknown effects of transgenic plants expressing pharmacologically active molecules on non-target organisms in the environment. These issues can be resolved through appropriate advances in formulation, quality assurance and control, and waste disposal, as well as regulatory approval and stewardship with consumers and non-governmental organizations (NGOs).

## 14.4

### Current Objectives in the Field

#### 14.4.1

##### Economic Considerations

One of the major advantages of transgenic plants for antibody production is the predicted low costs of large-scale production. Both the capital investments and running costs required for transgenic plants are significantly lower than those of cell-based production systems, and it has been estimated that recombinant proteins can be produced in plants at 2–10% of the cost of microbial fermentation systems, and at 0.1% of the cost of mammalian cell lines, depending on the yield [3, 7]. The actual cost saving depends on the required purity, since the majority of production costs lie not in the production system itself, but in the downstream processing steps required to extract and purify the pharmacologically active ingredient. The fewer processing steps required, the lower the cost. For the production of other clinical grade proteins, such as blood products, cytokines, enzymes and antibodies, the processing steps are similar to those of any other production system, and the savings must be made upstream in the generation, growth and harvesting of the transgenic material.

Downstream processing costs in plants can be minimized through the exploitation of particular tissues, or the use of specific expression technologies. The cost of processing is related to the concentration of the product in the starting material, so the yield of protein as a proportion of plant biomass is very important. Recombinant protein expression in cereal seeds is advantageous in this context because the product is concentrated in a small tissue volume that has a fairly simple composition compared to vegetative tissues [27, 28]. Different aspects of plant physiology can also be exploited to simplify downstream processing. For example, SemBioSys Genetics Inc. has developed a proprietary technology used with oilseed crops in which the target protein is expressed as a fusion with oleosin, an endogenous protein that is restricted to oil bodies. The fusion protein can be recovered from oil bodies using a simple extraction procedure and the recombinant protein separated from its fusion partner by endoprotease digestion [29]. In a similar approach developed in our laboratory, recombinant proteins are expressed as fusion constructs containing an integral membrane-spanning domain derived from the human T-cell receptor [30]. The recombinant protein accumulates at the plasma membrane and can be extracted in a small volume using appropriate buffers and detergents. A rather different approach is the excretion of recombinant proteins into the root exudates or leaf guttation fluid of transgenic tobacco plants. This system is being developed by Phytomedics Inc., initially for the production of human secreted alkaline phosphatase [31, 32], but now also for the production of recombinant antibodies and other proteins [33]. The requirement for hydroponic facilities limits the scale of this system, but it may prove useful for the production of diagnostic antibodies and pharmaceuticals with small, specialized markets.

## 14.4.2

**Choice of Plant Species and Platform for Antibody Production**

The species used for production, and also the type of production platform, each play a significant role in the final yield of recombinant protein. A decision must be made to use terrestrial plants, aquatic or unicellular plants, or plant cell suspensions. Terrestrial plants have the advantage of scalability, while the others offer containment and the ability to use defined growth conditions that will be more likely to comply with GMP. Among the terrestrial plants, a decision must be made to use either food or non-food crops, and then to use leafy crops, cereals, fruit/vegetable crops, fiber crops or oilseeds.

Tobacco is the most widely used leafy crop because it has a massive biomass yield and well-established procedures for gene transfer and expression. As a non-food crop, pharmaceutical tobacco material is unlikely to contaminate the human food chain, even if the existing infrastructure for large-scale tobacco cultivation, harvesting and processing is exploited. Tobacco is also extremely versatile, in that both the nuclear and chloroplast genome can be transformed, it is suitable for transient expression by agroinfiltration, and it is also the primary system for virus-based expression (see below). One disadvantage of tobacco, however, is the presence of toxic alkaloids in vegetative tissues (although there are low-alkaloid varieties that can be used for the production of pharmaceutical proteins). Another is the heterogeneous glycan structures that are produced by tobacco cells.

Alternative leafy crops for pharmaceutical production include alfalfa, lettuce and spinach, all of which also have high biomass yields. Alfalfa is a legume, and its ability to fix nitrogen is beneficial in terms of reduced input costs [34]. This crop has been shown to produce one antibody with homogeneous glycans, which may make it more compatible with GMP conditions than tobacco [35]. However, it is not altogether clear if the result can be extrapolated to other proteins. Alfalfa is low on the list of desirable crops for open-field cultivation because it is cross-pollinated and has wild relatives in areas where it is cultivated. However, for contained production it is being developed as a proprietary production system by the Canadian biotechnology company, Medicago. Soybean is also a legume, and while typically classed as a seed-based production vehicle, the only pharmaceutical to be expressed in soybean thus far is an antibody that was expressed in the leaves [36]. Soybean is more desirable than alfalfa from a biosafety perspective because it is self-pollinating and has no wild relatives (at least in the United States), but disappointing yields have led to this crop being largely abandoned as a commercial production platform. Lettuce and spinach, as edible salad crops, have been used for the production of vaccines [37, 38], but not thus far for antibodies.

Although favorable in terms of biomass yield, perhaps the greatest common disadvantage of leafy crops is that recombinant proteins are synthesized in an aqueous environment and are subject to rapid proteolytic degradation after harvesting [6]. To maintain high yields, foliage must be processed on-site, or transported as dried or frozen material, which adds considerably to production costs. Furthermore, oxidizing substances released from tobacco and alfalfa leaves during initial

grinding and extraction can interfere with downstream processing. Finally, it should be noted that the expression of active recombinant proteins in vegetative tissues, such as leaves, has the potential to interfere with plant growth and development, although this has not been demonstrated thus far for any pharmaceutical protein. This is not the case with the seed crops discussed below.

The expression of proteins in cereal or grain legume seeds potentially allows the long-term storage of recombinant antibodies, even at room temperature, because mature seeds are desiccated and have evolved to accumulate storage proteins in a stable environment. It has been demonstrated that antibodies expressed in seeds remain stable for at least three years, with no detectable loss of activity [39]. Cereal seeds also lack the oxidizing compounds present in tobacco and alfalfa leaves, thus improving the efficiency of downstream processing. Furthermore, since seeds are not vegetative organs, potentially toxic proteins accumulating in seeds will not affect vegetative plant growth. Four cereal species have been evaluated as production systems for pharmaceutical proteins – maize, rice, wheat, and barley.

Maize is the most widely adopted and has been used as the major production crop by a number of molecular farming companies (including Prodigene Inc., which used maize to produce the first commercial recombinant proteins from plants, the technical reagents avidin, trypsin and  $\beta$ -glucuronidase). This largely reflects the fact that maize is the most widely grown crop in North America, it is easy to transform and manipulate in the laboratory, it has the largest biomass yield of the four species, and it is the easiest to scale-up in the field. However, maize is also a cross-pollinating species and a food crop. For use in molecular farming, research is ongoing into the use of visibly distinct varieties that are unlikely to be mixed accidentally with food.

Rice and barley have been developed as production hosts by other companies, for example Ventria Bioscience for rice and Maltagen and ORF Genetics for barley. High product yields have been demonstrated for various pharmaceutical products in all three cereals, while lower yields have been achieved in wheat and pea. Rice, wheat, pea and tobacco have been compared in a head-to-head study with the same recombinant antibody expressed using the strongest promoter available for each host plant [40]. Rice plants showed the highest overall yields per unit biomass, but tobacco had a higher overall yield due to the greater biomass output per hectare. One potential disadvantage of seeds as production vehicles is that they can give rise to plants if accidentally dispersed, a problem that does not occur with harvested leaves. That is, seeds from “pharma” plants can be regarded as viable genetically modified organisms, making them subject to stricter regulatory practices, particularly in terms of processing and transport.

Fruit and vegetable crops have also been investigated as production systems, mainly for oral vaccines because fruits and many vegetables can be eaten raw or as partially processed tissue. Potato has been developed as the major model system for vaccine production, and has been used in three of the six clinical trials involving vaccines from transgenic plants [41, 42]. However, potatoes have also been used as a general production host for antibodies [43, 44] and other biopharmaceuticals based on antibodies [45]. Tomato has also been used for the production of

several candidate vaccines as well as recombinant antibodies [40]. This fruit is potentially advantageous because it has a high biomass yield per hectare and is grown in glasshouses, offering better containment than other fruits and vegetables. Other such crops, including carrot, sweet potato and bananas have been investigated for the production of vaccines but not yet for antibodies.

Various other crops have been considered as hosts for recombinant protein expression, including oilseeds, cotton, sugarcane, and sugar beet. One advantage is that byproducts can be used to offset the price of production; for example, specialty sugars from cane juice from which the recombinant protein has already been extracted. One downside is that some of these byproducts, especially oils and fibers, can interfere with downstream processing, although this is turned to an advantage in the SemBioSys oleosin-fusion technology used in canola and safflower, as described above. Another potential problem is that regulatory hurdles may prevent the use of byproducts from transgenic plants producing pharmaceuticals. As yet, none of these alternative terrestrial crops has been used for antibody production.

Transgenic terrestrial plants are not the only plant-based systems suitable for antibodies, and indeed the long development times involved are viewed by some as a disadvantage of these platforms despite the ultimate benefits of economy and scale. One way in which developmental times can be reduced is to rely on transient production systems which avoid stable gene transfer and can be used for moderate-scale production in containment, particularly in the early stages of process development. One example of this is the transient expression of recombinant proteins in tobacco and alfalfa leaves through *agroinfiltration*, a process in which *Agrobacterium tumefaciens* is introduced into the gaps between leaf cells by vacuum infiltration, resulting in the short-term production of recombinant proteins [46]. This has been used for several years as an initial test system to verify vector performance and allow the analysis of small amounts of recombinant proteins before committing to the expense and timescale required for transgenics [47], but now it is emerging as a useful production system in its own right. Baulcombe and colleagues have shown that the prevention of gene silencing in agroinfiltrated leaves can increase protein yields by up to 50-fold [48]. Furthermore, researchers at Medicago Inc. have described how the agroinfiltration of alfalfa leaves can be scaled up to 7500 leaves per week, for the production of microgram quantities of recombinant protein [49].

Virus-infected plants have also been used to produce pharmaceutical proteins, including antibodies [50, 51]. While these can, in theory, at least be grown on the same scale as transgenic plants, the development of producer lines is much quicker because virus infections take days or weeks to establish compared to the months or years required to produce transgenic plants. High-level expression is possible because viral replication is prodigious and infections are systemic. Virus-infected plants have been developed as a platform technology by several companies, including Large Scale Biology Corp. (who have performed Phase I clinical trials on at least 13 scFv antibodies) and Icon Genetics. The latter company has focused on the development of a systemic viral transfection system known as *magniffection*, which has produced impressive yields and is the basis of an emerging commercial production platform [52]. As well as viruses expressing full-length transgenes yielding

recombinant proteins that are extracted from infected plants using the same procedures developed for transgenic plants, a quite separate technology platform involves the use of plant virus particles to display the epitopes of animal viruses and other pathogens as coat fusion proteins (for reviews, see [53, 54]).

*Suspension cell cultures* derived from whole plants (e.g., tobacco and rice) possess many of the advantages of whole plants in terms of safety and capacity for the folding and modification of human proteins [55–57]. They are also cheaper to maintain than mammalian cells because they require a relatively simple, synthetic growth medium and they allow the product to be secreted into the medium for purification. Current challenges which need to be addressed include the relatively low yields (these need to be increased at least tenfold before the process becomes commercially feasible) and the genetic instability of many plant cultures [57]. As an alternative, bioreactors of aquatic plants such as *Lemna minor* [58], or cultures of algae [59] or moss [60] can be used as production systems. The *Lemna* system has been pioneered by companies such as Lemnagene and Biolex, and has successfully been used to produce a number of antibodies in preliminary studies [58]. The moss *Physcomitrella patens* is a particularly promising system because it is one of the few plant species known to be amenable to gene targeting by homologous recombination. This provides the potential to knock out genes encoding the enzymes responsible for adding non-mammalian glycan structures to recombinant glycoproteins [60].

#### 14.4.3

#### **Product Yields: Strategies to Enhance Transgene Expression and Protein Accumulation**

The intrinsic production capacity of the chosen expression platform is a property that cannot be modified easily, because it is dependent on the overall biomass yield of the crop. However, the specific yield of recombinant protein per unit of plant biomass can be influenced by the optimization of transgene expression, which is achieved through expression construct design. Perhaps the most important component of the expression construct is the promoter used to control the transcription of the transgene. For dicotyledonous species such as tobacco, potato and tomato, the strong and constitutive cauliflower mosaic virus 35S promoter (CaMV 35S) is often chosen to drive transgene expression [61]. In cereals, the CaMV 35S promoter has a lower activity and the maize ubiquitin-1 (*ubi-1*) promoter is preferred [62]. Regulated promoters can be used in preference to constitutive promoters to improve practicality and biosafety. For example, although constitutive promoters allow high-level accumulation of recombinant proteins in seeds, the proteins are also expressed in leaves, pollen, and roots. The use of seed-specific promoters largely restricts recombinant protein accumulation to the seeds, so the vegetative organs do not accumulate detectable levels of the recombinant protein. This increases the biosafety of the plants, since adventitious contact with non-target organisms is unlikely [63]. Indeed, the use of inducible promoters [64] means that recombinant protein synthesis can be delayed until just before harvest, or even after



harvest as is the case for the CropTech MeGA promoter system (mechanical gene activation) which employs a wound-inducible promoter to activate gene expression when the harvested tobacco leaves are shredded prior to protein extraction [65]. However, many of the regulated promoters that have been described show some leakiness; for example, many nominally seed-specific promoters are also active in pollen.

After promoter choice, the next most important aspect of construct design is the inclusion of sequences that control subcellular targeting of the protein. This is a general method to increase the yield of recombinant proteins because the compartment in which a recombinant protein accumulates influences its folding, assembly and post-translational modification [3, 7]. Comparative targeting experiments with full-size immunoglobulins and single-chain Fv fragments have shown that the secretory pathway is a more suitable compartment for folding and assembly than the cytosol, and is therefore advantageous for high-level protein accumulation [66, 67]. The endoplasmic reticulum (ER) provides an oxidizing environment and an abundance of molecular chaperones, while there are few proteases. Proteins are directed to the secretory pathway using either a heterologous or endogenous signal peptide, located at the N-terminus of the native protein. Such proteins are co-translationally imported into the ER and eventually secreted to the apoplast, a supracellular network of interlinked compartments underlying the cell wall. Depending on its size, a protein can be retained in the cell wall matrix or it can leach from the cell. Although the majority of recombinant proteins are generally more stable in the apoplast than the cytosol, they are even more stable in the ER lumen. Therefore, antibody expression levels can be increased even further if the protein is retrieved to the ER using an H/KDEL C-terminal tetrapeptide tag in addition to the signal peptide [68]. Accumulation levels are generally two- to tenfold greater compared with an identical protein lacking the KDEL signal [69]. As an added benefit, antibodies retrieved in this manner are not modified in the Golgi apparatus, which means that they possess high-mannose glycans but not plant-specific xylose and fucose residues [70].

High-level recombinant protein expression has also been demonstrated following transformation of the chloroplast genome in higher plants [71, 72]. Early studies focused on the tobacco plastid genome, and several examples of pharmaceutical protein production in tobacco chloroplasts have already been reported. The expression of human growth hormone in tobacco chloroplast has been reported at levels approaching 8% total soluble protein (TSP) [73]. Similarly, human serum albumin has been produced at levels exceeding 11% TSP [74], and production of the cholera and tetanus toxin fragments at levels up to 25% TSP has been reported [75, 76]. Further advantages of the chloroplast system are the natural containment both in terms of the transgene (functional chloroplast DNA is not found in the pollen of most crops, preventing transgene spread by outcrossing) and the product itself accumulates within the chloroplast limiting effects on the host cell. Limitations include the absence of reliable chloroplast transformation systems other than for algae and solanaceous plants, and the absence of glycosylation and other forms of post-translational modification in the chloroplast. Therefore, the chloroplast sys-

tem for terrestrial plants is currently limited to the production of relatively simple aglycosylated proteins in tobacco, tomato, potato, cotton, and soybean [72].

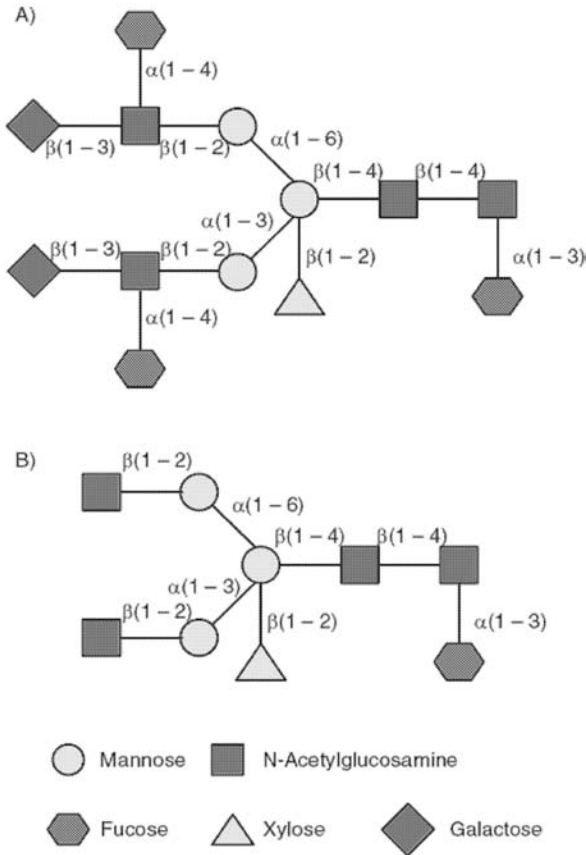
Product yields can be increased not only through construct design, but also through the implementation of a selection and backcrossing program once transgenic plants are available. In the case of maize, it has proven to increase the yield of a recombinant enzyme over 70-fold in only six generations, and to increase the yield of recombinant avidin over 150-fold in eight generations [77]. There is no reason why the same principles should not apply to pharmaceutical proteins, including antibodies.

#### 14.4.4

#### Protein Folding, Assembly, and Glycosylation

The ability of plants to fold and assemble complex human proteins has been demonstrated by the successful production of functional serum antibodies using plants carrying two transgenes (encoding the heavy and light chain components, respectively). Such antibodies comprise four polypeptides – two heavy and two light chains – covalently joined by disulfide bonds [78]. More remarkably, plants also assemble functional secretory antibodies, which have 10 polypeptides representing four different polypeptide chains (the heavy and light chains, and additional joining chain and secretory component subunits) [79, 80]. Two different cell types are required to produce and assemble such antibodies in mammals.

Although the protein synthesis and folding pathways are highly conserved between plants and animals, there are some differences in the capacity for post-translational modification. Plants do not, for example, hydroxylate proline residues in recombinant collagen. There are also various differences in glycan structure: plant-derived recombinant human glycoproteins tend to contain the carbohydrate groups  $\beta(1\rightarrow2)$  xylose and  $\alpha(1\rightarrow3)$  fucose in the core glycan, which are absent in mammals, but generally lack the terminal galactose and sialic acid residues that are found on many native human glycoproteins (Fig. 14.2). Since glycan structures can influence the solubility, stability, immunogenicity and biological activity of antibodies, the “humanization” of glycan structures produced in plants has been an important topic of research and debate in the scientific community. Although no plant-derived antibodies have thus far demonstrated unintended immunogenicity in either the human or murine immune systems [81], there has been considerable interest in modifying the plant glycosylation pathway to humanize the glycan profile of recombinant proteins. Several changes in the pathway are required to produce proteins with typical human glycan structures. Strategies used include the *in-vitro* modification of plant-derived recombinant proteins by purified human  $\beta(1,4)$ -galactosyltransferase and sialyltransferase enzymes [82] and the expression of human  $\beta(1,4)$ -galactosyltransferase in transgenic plants to produce recombinant antibodies with galactose-extended glycans [83]. In the latter case, 30% of the antibody was galactosylated, similar to the proportion found in hybridoma cells. *In-vivo* sialylation will be more difficult to achieve because plants lack the precursors and metabolic capability to produce this carbohydrate group. A recent report docu-



**Fig. 14.2** Two examples of complex glycans produced in plants. (A) Short-chain complex glycan. (B) Long-chain complex glycan. Note the presence of xylose residues and  $\alpha(1,3)$ -linked fucose residues, which are not found in mammals.

menting sialylation in *A. thaliana* suspension cells has been challenged, although the subject remains a matter of controversy [84–86]. In order to remove the non-mammalian  $\beta(1\rightarrow2)$  xylose and  $\alpha(1\rightarrow3)$  fucose residues, some research teams have explored the possibility of inhibiting the enzymes responsible for synthesizing these groups, while in one case this goal has been achieved in whole *A. thaliana* plants by using gene knockout techniques [87]. The moss *Physcomitrella patens* can also be modified by gene targeting to eliminate these enzymes [60].

#### 14.4.5

#### Biosafety Concerns

The biosafety of transgenic plants producing recombinant pharmaceuticals has a major impact on public opinion and, in turn, influences the political and regulato-

ry framework governing pharmaceutical production and biotechnology in general. Specific biosafety risks fall into two categories, which can be described as the risk of transgene escape and the risk of unintended exposure to the recombinant protein [63]. The risk of transgene spread reflects the potential for transgene DNA sequences to spread outside the intended host plants and production site. This can result in the growth of transgenic crops in other cultivated fields or in non-cultivated areas, and the spread of foreign DNA to other plants (and possibly to microbes and animals) and the uncontrolled production of recombinant proteins in natural settings. Mechanisms of transgene spread include the dispersal of transgenic plants or seeds by wind, water or by human and animal activities and outcrossing via transgenic pollen. The risk of unintended exposure concerns the potential for any organism (including humans) to come into contact with the recombinant protein produced by a transgenic plant. Many different mechanisms can be involved, including herbivory and parasitism, the exposure of pollinating insects to transgenic pollen, the exposure of microbes in the rhizosphere to root exudates, the exposure of non-target microbes and animals to proteins secreted in the leaf guttation fluid, the release of recombinant proteins by dead and decaying transgenic plant material, and the contamination of food or feed crops during harvesting, transport, processing and/or waste disposal.

An appropriate choice of production species can go a long way to prevent or minimize transgene spread by dispersal or vertical gene transfer. Certain plants have been singled out as inappropriate hosts by regulatory organizations [88, 89]. For example, alfalfa and rapeseed have been highlighted as unsuitable for *field cultivation* because they are bee-pollinated, sexually compatible with abundant and local weed species, and the seeds can lie dormant for several years, making volunteer plants difficult to isolate and destroy. Note that this does not compromise their merits as production hosts if they are grown *under containment*. Other species have been more readily accepted because of the lower risks of transgene spread, for example potato (male-sterile), sugar beet and rice (self-pollinating). The major current production crops – maize and tobacco – have intermediate status for field cultivation. Again, however, it should be emphasized that this does not influence their advantages as production crops under containment.

Given an appropriate choice of host species, the only way fully to avoid transgene spread from field plants to compatible crops and wild species is by strict containment. The aim of containment is to prevent seed and pollen dispersal, prevent the survival of dispersed seeds and pollen, or prevent gene flow from viable pollen. The containment may be physical and based on habitat barriers. For example, transgenic plants can be maintained in greenhouses, in artificially irrigated desert plots miles from any other plants, or in underground caverns and caves [90]. Alternatively, the physical containment may be focused on individual plants. For example, flowers can be emasculated before viable pollen has developed (not an option for seed- or fruit-based production, but suitable for leafy or vegetable crops), or the flowers/fruits may be concealed in plastic bags. Isolation zones are often placed around transgenic crops. These can be barren, but a more suitable alternative for insect-pollinated crops is to provide a zone of non-insect-pollinated plants which

would discourage the insects from leaving the transgenic zone. Barrier crops – that is, a border of non-genetically modified plants of the same species as the transgenic crop – are also useful as these can absorb much of the pollen released by transgenic plants and then be destroyed after flowering.

Biological containment measures provide additional barriers to gene flow, and many different strategies have been tested. In some cases, natural genetic barriers have been exploited. For example, pharmaceutical production in self-pollinating species (e.g., rice, wheat, pea) or crops with no sexually compatible wild relatives near the site of production provide a first level of defense against gene flow. Similarly, crops with asynchronous flowering times or atypical growing seasons are useful. Cleistogamy (self-fertilization before flower opening) is an extension of the above, and could be engineered into crops used for molecular farming by modifying the architecture of flower development. In practice, however, there is always a residual risk of outcrossing. Another potential strategy, yet to be fully explored, is the exploitation of apomixis (embryo development in the absence of fertilization). Transformation strategies can also be adapted to take advantage of natural barriers – for example, chloroplast transformation (which prevents gene flow by outcrossing; see above) and genomic incompatibility, which is suitable for polyploid species such as wheat that hybridize with wild relatives (in this approach, the transgene is placed on a wheat chromosome that does not contribute to the genome of the hybrid offspring). These natural mechanisms may be augmented with artificial genetic strategies including male sterility, transgene mitigation (tight linkage between the transgene encoding the recombinant protein and another gene that confers a selective disadvantage on wild plants carrying the gene, but not those cultivated under defined conditions), and genetically controlled seed sterility. As well as the transgenes encoding the pharmaceutical products of interest, marker genes used to facilitate plant transformation may also spread by the mechanisms discussed above. However, unlike the pharmaceutical transgenes, such markers are no longer necessary once the transgenic line has been established. For this reason, a suitable strategy to prevent the spread of marker genes is to excise these genes from the transgenic lines. The removal of marker genes from nuclear transgenics has been reviewed in detail [91] and has also been achieved in plastid transformants [92].

There are numerous genetic strategies to avoid unintended exposure both by “natural” processes such as adventitious herbivory, and by human activities such as the unintentional mixing of transgenic and non-transgenic crops during harvesting, transport, refining, and processing. Unintended exposure during cultivation can be prevented using restricted promoters, especially systems such as the CropTech post-harvest expression technology discussed above. The protein can also be expressed as an inactive precursor which is safe if consumed accidentally. To avoid contamination by human error, there should be a clear distinction between pharmaceutical and food plant material. The best way to ensure segregation is through the use of non-food crops such as tobacco for production, as these never come into contact with food. Where food crops are used, a rigorous series of regulatory practices should be in place from the farm to the factory, ensuring complete

isolation of transgenic material during growth, harvesting, transport, storage, processing, extraction and waste disposal, and this should be supported by validated procedures for cleaning shared equipment. An important step towards segregation is identity preservation through the use of visually distinct non-food varieties for pharmaceutical production, such as purple maize [63], or the use of visual marker genes such as DsRed and GFP (green fluorescent protein) to allow pharmaceutical material to be identified.

## 14.5

### Plant-Derived Antibodies in Clinical Trials

Three types of plant-derived antibody have been tested in Phase II clinical trials. One of these is a full-length IgG specific for EpCAM (a marker of colorectal cancer) produced in maize and developed as the drug Avicidin by NeoRx and Monsanto. Although Avicidin demonstrated some anti-cancer activity in patients with advanced colon and prostate cancers, it was withdrawn from Phase II trials in 1998 because it also resulted in a high incidence of diarrhea [12]. This was not due to the use of plants as the expression host. Indeed, the same problems occurred with antibodies produced in mammalian cells, and the conclusion of the trial was that the two antibodies were comparable in terms of physico-chemical properties, serum clearance, urine clearance, and dosimetry. The side effects were possibly due to cross-reaction with related epitopes on the cells lining the intestine.

The most advanced plant-derived antibody is CaroRx, a chimeric secretory IgA/G produced in transgenic tobacco plants, which has completed Phase II trials [93]. As stated earlier, secretory antibody production requires the expression of four separate components, which in this case were initially expressed in four different plant lines that were crossed over two generations to stack all the transgenes in one line. The antibody is specific for the major adhesin of *Streptococcus mutans*, the organism responsible for tooth decay in humans. Topical application following elimination of bacteria from the mouth helped to prevent recolonization by *S. mutans* and led to the replacement of this pathogenic organism with harmless endogenous flora.

The third type is a collection of anti-idiotypic scFv antibodies recognizing malignant B cells for the treatment of diseases such as non-Hodgkin's lymphoma. The prototype scFv (at least 12 have now been tested) was based on the well-characterized mouse lymphoma cell line 38C13. When administered to mice, the scFv stimulated the production of anti-idiotypic antibodies capable of recognizing 38C13 cells [50]. This provided immunity against lethal challenge with the lymphoma. It is envisaged that this strategy could be used as a rapid production system for tumor-specific vaccines customized for each patient and capable of recognizing unique markers on the surface of any malignant B cells. The therapeutic product has now completed Phase I trials and is undergoing Phase II. The rapid derivation of such prophylactic antibodies is ensured by the use of virus-infected plants rather than stably-transformed transgenic plants.

Other plant-derived antibodies are in the late stages of preclinical development; examples include RhinoRX (developed by Planet Biotechnology, for the treatment of respiratory infections) and a full-length humanized IgG recognizing herpes simplex virus 2 (HSV-2). The latter has been expressed in transgenic soybean and has been shown to prevent vaginal HSV-2 transmission in a mouse model of the disease [36]. Still more antibodies are at earlier stages of development, either intended as prophylactics, therapeutics or diagnostics. Current research is focusing on ways to address the few remaining obstacles to commercialization (i.e., the absence of a defined regulatory framework), and ways to optimize biological equivalence with antibodies derived from the industry favorite, CHO cells.

## 14.6

### Regulatory Considerations

#### 14.6.1

##### Downstream Processing

Downstream processing – the isolation and purification recombinant antibodies from the plant tissue – is an integral part of every biomanufacturing process. Whichever production system is used, downstream processing represents up to 80% of overall production costs, although this depends on the required level of purity and is highest for clinical-grade materials. In many cases, it is necessary to develop specific processing steps for each product, although certain classes of product can be isolated using a standardized approach (e.g., affinity chromatography to isolate recombinant antibodies [94]). Several aspects of downstream processing must be customized specifically for plant systems, including the removal of fibers, oils and other byproducts from certain crops, and process optimization for the treatment of different plant species and tissues.

For the production of clinical-grade antibodies, downstream processing steps must meet the standards set for other biopharmaceutical production systems, including a strict regime of quality assurance and quality control to achieve approval of regulatory agencies [95]. The initial stages of processing display the greatest variability and must be optimized in a system-specific manner. Disruption of cell walls and membranes is the first post-harvesting step, but different tissue types (e.g., leaves, seeds, fruits) require different forms of treatments (grinding, milling, etc.). After cell disruption, clarification of the extract is often carried out by dead-end or cross-flow filtration, sometimes preceded by bulk cell mass removal using a decanter, plate separator, or centrifuge.

Several liquid chromatography steps are required in a full purification protocol, and the initial chromatographic steps require the most specialization for plant-based production. In industrial processing, robust and inexpensive chromatography media are used in the initial steps, accepting that there will be some loss of selectivity and resolution [96]. However, important exceptions include the use of Protein A or Protein G affinity chromatography for antibody purification, and the use

of affinity tags and their respective capture agents (e.g., His<sub>6</sub> and Ni<sup>2+</sup>-NTA resin) which are highly selective initial capturing methods.

#### 14.6.2

#### **Regulation of Plant-Based Production**

One of the greatest uncertainties surrounding the use of plants for the production of pharmaceuticals is the regulatory landscape. While plants are grown in glass-houses and in enclosed bioreactors, the production of pharmaceuticals is regulated in the same way for other production systems, and comes under the authority of the FDA and equivalent agencies in other parts of the world. The switch to open-field conditions adds another layer of regulatory complexity, because the transgenic plants then come under the authority of APHIS (part of the USDA) or their counterparts in Europe and other regions. The involvement of multiple regulatory agencies makes the production process more complex because the extent of each authority's jurisdiction is not always clear and, as stated above, at the current time only draft guidelines are available [88, 89]. The impact of this is to suppress the market. It is likely that more companies will become interested in plant-derived pharmaceuticals when full guidelines become available, hopefully by 2006/7. In this context, it is interesting that certain academic/industry partnerships are engaging positively with the regulatory bodies in an attempt to define a regulatory framework for the production of plant-derived pharmaceuticals. One example is the Pharma-Planta Consortium, an EU-funded collaboration of 39 academic and industrial partners which is attempting to take candidate antibodies from initial expression through to clinical trials in order to define a standard pathway for similar products [97, 98].

All recombinant pharmaceuticals, including those derived from plants, need to comply with the national and international GMP standards for product safety, quality, potency and efficacy. However, it is not clear at which stage GMP requirements should come into effect when plants are used as the production system, since the strict rules governing defined growth conditions are difficult to implement in the field, where variables such as the weather, differences in soil quality and the presence of other organisms need to be considered. This is increasingly important now that European regulatory requirements regarding GMP-compliance for the manufacture of medicinal products have extended to the production of clinical trial material (Directive 2001/20/EC).

#### 14.7

#### **Summary**

The production of recombinant antibodies in plants has emerged during the past few years as a potential competitor to the established fermenter-based production technologies, theoretically offering unlimited production scales at unprecedented low manufacturing costs. Technical limitations such as low yields, product in-



stability and non-authentic glycan structures are being addressed, so the remaining hurdles are more political than scientific and reflect the formative and, in many cases, restrictive regulatory framework. In order to ensure that plants can be developed as an effective production system for antibodies it will be necessary to tackle the regulatory issues head on. At this early stage, the industry is cooperative rather than competitive, so issues relating to intellectual property and technical know-how are more likely to sponsor cross-collaborations and licensing than litigation. In this environment, proactive steps can be taken in process development for the benefit of all, in concert with the regulatory agencies. The ultimate hope is that, through such ventures, it will be possible to make inexpensive biologics available to all who need them.

## References

- 1 Raskin, I., Ribnický, D.M., Komarnytsky, S., Ilic, N., Poulev, A., Borisjuk, N., Brinker, A., Moreno, D.A., Ripoll, C., Yakoby, N., O'Neal, J.M., Cornwell, T., Pastor, I., Fridlender, B. Plants and human health in the twenty-first century. *Trends Biotechnol.* **2002**, *20*, 522–531.
- 2 Fischer, R., Emans, N. Molecular farming of pharmaceutical proteins. *Transgenic Res.* **2000**, *9*, 279–299.
- 3 Twyman, R.M., Schillberg, S., Fischer, R. The transgenic plant market in the pharmaceutical industry. *Expert Opin. Emerg. Drugs* **2005**, *10*, 185–218.
- 4 Schillberg, S., Twyman, R.M., Fischer, R. Opportunities for recombinant antigen and antibody expression in transgenic plants – technology assessment. *Vaccine* **2005**, *23*, 1764–1769.
- 5 Fischer, R., Stoger, E., Schillberg, S., Christou, P., Twyman, R.M. Plant based production of biopharmaceuticals. *Curr. Opin. Plant Biol.* **2004**, *7*, 152–158.
- 6 Twyman, R.M., Stoger, E., Schillberg, S., Christou, P., Fischer, R. Molecular farming in plants: Host systems and expression technology. *Trends Biotechnol.* **2003**, *21*, 570–578.
- 7 Ma, J.K.C., Drake, P., Christou, P. The production of recombinant pharmaceutical proteins in plants. *Nature Rev. Genet.* **2003**, *4*, 794–805.
- 8 Sijmons, P.C., Dekker, B.M.M., Schrammeijer, B., Verwoerd, T.C., Van Den Elzen, P.J.M., Hoekema, A. Production of correctly processed human serum albumin in transgenic plants. *Bio/Technology* **1990**, *8* (3), 217–221.
- 9 Fischer, R., Twyman, R.M., Schillberg, S. Production of antibodies in plants and their use for global health. *Vaccine* **2003**, *21*, 820–825.
- 10 Andersen, D.C., Krummen, L. Recombinant protein expression for therapeutic applications. *Curr. Opin. Biotechnol.* **2002**, *13* (2), 117–123.
- 11 Chadd, H.E., Chamow, S.M. Therapeutic antibody expression technology. *Curr. Opin. Biotechnol.* **2001**, *12*, 188–194.
- 12 Gaviñondo, J.V., Larrick, J.W. Antibody production technology in the millennium. *Biotechniques* **2000**, *29*, 128–145.
- 13 Jefferis, R. Glycosylation of human IgG antibodies: relevance to therapeutic applications. *Biopharm* **2001**, *14*, 19–27.
- 14 Fischer, R., Schumann, D., Zimmermann, S., Drossard, J., Sack, M., Schillberg, S. Expression and characterization of bispecific single chain Fv fragments produced in transgenic plants. *Eur. J. Biochem.* **1999**, *262*, 810–816.
- 15 Francisco, J.A., Gawlak, S.L., Miller, M., Bathe, J., Russell, D., Chace, D., Mixan, B., Zhao, L., Fell, H.P., Siegall, C.B. Expression and characterization of bryodin 1 and a bryodin 1-based single-chain immunotoxin from tobacco cell culture. *Bioconj. Chem.* **1997**, *8*, 708–713.
- 16 Spiegel, H., Schillberg, S., Sack, M., Holzem, A., Nähring, J., Monecke, M.,

- Liao, Y.-C., Fischer, R. Accumulation of antibody fusion proteins in the cytoplasm and ER of plant cells. *Plant Sci.* **1999**, *149*, 63–71.
- 17 Kipriyanov, S.M., Little, M. Generation of recombinant antibodies. *Mol. Biotechnol.* **1999**, *12*, 173–201.
  - 18 Green, L. Antibody engineering via genetic engineering of the mouse: xenomouse strains are a vehicle for the facile generation of therapeutic human monoclonal antibodies. *J. Immunol. Methods* **1999**, *231*, 11–23.
  - 19 Griffiths, A., Duncan, A. Strategies for selection of antibodies by phage display. *Curr. Opin. Biotechnol.* **1998**, *9*, 102–108.
  - 20 Sidhu, S.S. Phage display in pharmaceutical biotechnology. *Curr. Opin. Biotechnol.* **2000**, *11*, 610–616.
  - 21 Chu, L., Robinson, D.K. Industrial choices for protein production by large scale cell culture. *Curr. Opin. Biotechnol.* **2001**, *12*, 180–187.
  - 22 Wurm, F.M. Production of recombinant protein therapeutics in cultivated mammalian cells. *Nature Biotechnol.* **2004**, *22*, 1393–1398.
  - 23 Raju, T.S., Briggs, J., Borge, S.M., Jones, A.J.S. Species-specific variation in glycosylation of IgG: evidence for the species-specific sialylation and branch-specific galactosylation and importance for engineering recombinant glycoprotein therapeutics. *Glycobiology* **2000**, *10*, 477–486.
  - 24 Keefer, C.L. Production of bioproducts through the use of transgenic animal models. *Anim. Reprod. Sci.* **2004**, *82-83*, 5–12.
  - 25 Dyck, M.K., Lacroix, D., Pothier, F., Sirard, M.A. Making recombinant proteins in animals – different systems, different applications. *Trends Biotechnol.* **2003**, *21*, 394–399.
  - 26 Pollock, D., Kutzko, J., Birck-Wilson, E., Williams, J., Echelard, Y., Meade, H. Transgenic milk as a method for the production of recombinant antibodies. *J. Immunol. Methods* **1999**, *231*, 147–157.
  - 27 Perrin, Y., Vaquero, C., Gerrard, I., Sack, M., Drossard, J., Stoger, E., Christou, P., Fischer, R. Transgenic pea seeds as bioreactors for the production of a single-chain Fv fragment (scFv) antibody used in cancer diagnosis and therapy. *Mol. Breeding* **2002**, *6*, 345–352.
  - 28 Stoger, E., Vaquero, C., Torres, E., Sack, M., Nicholson, L., Drossard, J., Williams, S., Keen, D., Perrin, Y., Christou, P., Fischer, R. Cereal crops as viable production and storage systems for pharmaceutical scFv antibodies. *Plant Mol. Biol.* **2000**, *42*, 583–590.
  - 29 Liu, J.H., Selinger, L.B., Cheng, K.J., Beauchemin, K.A., Moloney, M.M. Plant seed oil bodies as an immobilization matrix for a recombinant xylanase from the rumen fungus *Neocallimastix patriciarum*. *Mol. Breeding* **1997**, *3*, 463–470.
  - 30 Schillberg, S., Zimmermann, S., Findlay, K., Fischer, R. Plasma membrane display of anti-viral single chain Fv fragments confers resistance to tobacco mosaic virus. *Mol. Breeding* **2000**, *6*, 317–326.
  - 31 Borisjuk, N.V., Borisjuk, L.G., Logendra, S., Petersen, F., Gleba, Y., Raskin, I. Production of recombinant proteins in plant root exudates. *Nature Biotechnol.* **1999**, *17*, 466–469.
  - 32 Komarnytsky, S., Borisjuk, N.V., Borisjuk, L.G., Alam, M.Z., Raskin, I. Production of recombinant proteins in tobacco guttation fluid. *Plant Physiol.* **2000**, *124*, 927–933.
  - 33 Drake, P.M.W., Chargelegue, D.M., Vine, N.D., Van Dolleweerd, C.J., Obregon, P., Ma, J.K.C. Rhizosecretion of a monoclonal antibody protein complex from transgenic tobacco roots. *Plant Mol. Biol.* **2003**, *52*, 233–241.
  - 34 D'Aoust, M.A., Busse, U., Martel, M., Lerouge, P., Levesque, D., Vezina, L.P. Perennial plants as a production system for pharmaceuticals. In: Christou, P., Klee, H. (Eds.), *Handbook of Plant Biotechnology*, Volume 2. Wiley-VCH, New York, **2004**, pp. 759–768.
  - 35 Bardor, M., Loutelier-Bourhis, C., Paccalet, T., Cosette, P., Fitchette, A.C., Vezina, L.P., Trepanier, S., Dargis, M., Lemieux, R., Lange, C., Faye, L., Lerouge, P. Monoclonal C5-1 antibody produced in transgenic alfalfa plants exhibits a N-glycosylation that is homogenous and suitable for glyco-engineering into human-compatible structures. *Plant Biotech. J.* **2003**, *1*, 451–462.

- 36 Zeitlin, L., Olmsted, S.S., Moench, T.R., Co, M.S., Martinell, B.J., Paradkar, V.M., Russell, D.R., Queen, C., Cone, R.A., Whaley, K.J. A humanized monoclonal antibody produced in transgenic plants for immunoprotection of the vagina against genital herpes. *Nature Biotechnol.* **1998**, *16*, 1361–1364.
- 37 Kapusta, J., Modelska, A., Figlerowicz, M., Pniewski, T., Letellier, M., Lisowa, O., Yusibov, V., Koprowski, H., Plucienniczak, A., Legocki, A.B. A plant-derived edible vaccine against hepatitis B virus. *FASEB J.* **1999**, *13*, 1796–1799.
- 38 Yusibov, V., Hooper, D.C., Spitsin, S., Fleysh, N., Kean, R.B., Mikheeva, T., Deka, D., Karasev, A., Cox, S., Randall, J., Koprowski, H. Expression in plants and immunogenicity of plant virus-based experimental rabies vaccine. *Vaccine* **2002**, *20*, 3155–3164.
- 39 Stoger, E., Ma, J.K.C., Fischer, R., Christoup, P. Sowing the seeds of success: pharmaceutical proteins from plants. *Curr. Opin. Biotechnol.* **2005**, *16*, 167–173.
- 40 Stoger, E., Sack, M., Perrin, Y., Vaquero, C., Torres, E., Twyman, R.M., Christou, P., Fischer, R. Practical considerations for pharmaceutical antibody production in different crop systems. *Mol. Breeding* **2002**, *9*, 149–158.
- 41 Tacket, C.O., Mason, H.S., Losonsky, G., Clements, J.D., Levine, M.M., Arntzen, C.J. Immunogenicity in humans of a recombinant bacterial-antigen delivered in transgenic potato. *Nature Med.* **1998**, *4*, 607–609.
- 42 Tacket, C.O., Mason, H.S., Losonsky, G., Estes, M.K., Levine, M.M., Arntzen, C.J. Human immune responses to a novel Norwalk virus vaccine delivered in transgenic potatoes. *J. Infect. Dis.* **2000**, *182*, 302–305.
- 43 Artsaenko, O., Kettig, B., Fiedler, U., Conrad, U., Doring, K. Potato tubers as a biofactory for recombinant antibodies. *Mol. Breeding* **1998**, *4*, 313–319.
- 44 De Wilde, C., Peeters, K., Jacobs, A., Peck, I., Depicker, A. Expression of antibodies and Fab fragments in transgenic potato plants: a case study for bulk production in crop plants. *Mol. Breeding* **2002**, *9*, 271–282.
- 45 Schunmann, P.H.D., Coia, G., Waterhouse, P.M. Biopharming the SimpliRED™ HIV diagnostic reagent in barley, potato and tobacco. *Mol. Breeding* **2002**, *9*, 113–121.
- 46 Kapila, J., Derycke, R., Vanmontagu, M., Angenon, G. An *Agrobacterium*-mediated transient gene expression system for intact leaves. *Plant Sci.* **1997**, *122*, 101–108.
- 47 Vaquero, C., Sack, M., Schuster, F., Finnern, R., Drossard, J., Schumann, D., Reimann, A., Fischer, R. A carcino-embryonic antigen-specific diabody produced in tobacco. *FASEB J.* **2002**, *16*, 408–410.
- 48 Voinet, O., Rivas, S., Mestre, P., Baulcombe, D. An enhanced transient expression system in plants based on suppression of gene silencing by the p19 protein of tomato bushy stunt virus. *Plant J.* **2003**, *33*, 949–956.
- 49 D'Aoust, M.A., Lerouge, P., Busse, U., Bilodeau, P., Trepanier, S., Gomord, V., Faye, L., Vezina, L.-P. Efficient and reliable production of pharmaceuticals in alfalfa. In: Fischer, R., Schillberg, S. (Eds.), *Molecular Farming: Plant-made Pharmaceuticals and Technical Proteins*. John Wiley & Sons, New York, **2004**, pp. 1–12.
- 50 McCormick, A.A., Kumagai, M.H., Hanley, K., Turpen, T.H., Hakim, I., Grill, L.K., Tuse, D., Levy, S., Levy, R. Rapid production of specific vaccines for lymphoma by expression of the tumor-derived single-chain Fv epitopes in tobacco plants. *Proc. Natl Acad. Sci. USA* **1999**, *96*, 703–708.
- 51 Verch, T., Yusibov, V., Koprowski, H. Expression and assembly of a full-length monoclonal antibody in plants using a plant virus vector. *J. Immunol. Methods* **1998**, *220*, 69–75.
- 52 Marillonnet, S., Thoeringer, C., Kandzia, R., Klimyuk, V., Gleba, Y. Systemic *Agrobacterium tumefaciens*-mediated transfection of viral replicons for efficient transient expression in plants. *Nature Biotechnol.* **2005**, *23*, 718–723.
- 53 Lomonossoff, G.P., Hamilton, W.D. Cowpea mosaic virus-based vaccines. *Curr. Top. Microbiol. Immunol.* **1999**, *240*, 177–189.

- 54 Porta, C., Lomonosoff, G.P. Viruses as vectors for the expression of foreign sequences in plants. *Biotechnol. Genet. Eng. Rev.* **2002**, *19*, 245–291.
- 55 Doran, P.M. Foreign protein production in plant tissue cultures. *Curr. Opin. Biotechnol.* **2000**, *11*, 199–204.
- 56 Fischer, R., Emans, N., Schuster, F., Hellwig, S., Drossard, J. Towards molecular farming in the future: using plant-cell-suspension cultures as bioreactors. *Biotechnol. Appl. Biochem.* **1999**, *30*, 109–112.
- 57 Hellwig, S., Drossard, J., Twyman, R.M., Fischer, R. Plant cell cultures for the production of recombinant proteins. *Nature Biotechnol.* **2004**, *22*, 1415–1422.
- 58 Gasdaska, J.R., Spencer, D., Dickey, L. Advantages of therapeutic protein production in the aquatic plant *Lemna*. *Bioprocess J.* **2003**, *2*, 49–56.
- 59 Mayfield, S.P., Franklin, S.E., Lerner, R.A. Expression and assembly of a fully active antibody in algae. *Proc. Natl Acad. Sci. USA* **2003**, *100*, 438–442.
- 60 Decker, E.L., Reski, R. The moss bioreactor. *Curr. Opin. Plant Biol.* **2004**, *7*, 166–170.
- 61 Tyagi, A.K. Plant genes and their expression. *Curr. Sci. India* **2001**, *80*, 161–169.
- 62 Christensen, A.H., Quail, P.H. Ubiquitin promoter-based vectors for high-level expression of selectable and/or screenable marker genes in monocotyledonous plants. *Transgenic Res.* **1996**, *5*, 213–218.
- 63 Commandeur, U., Twyman, R.M., Fischer, R. The biosafety of molecular farming in plants. *AgBiotechNet* **2003**, *5*, ABN 110.
- 64 Padidam, M. Chemically regulated gene expression in plants. *Curr. Opin. Plant Biol.* **2003**, *6*, 169–177.
- 65 Cramer, C.L., Boothe, J.G., Oishi, K.K. Transgenic plants for therapeutic proteins: linking upstream and downstream technologies. *Curr. Top. Microbiol. Immunol.* **1999**, *240*, 95–118.
- 66 Zimmermann, S., Schillberg, S., Liao, Y.C., Fisher, R. Intracellular expression of TMV-specific single-chain Fv fragments leads to improved virus resistance in *Nicotiana tabacum*. *Mol. Breeding* **1998**, *4*, 369–379.
- 67 Schillberg, S., Zimmermann, S., Voss, A., Fischer, R. Apoplastic and cytosolic expression of full-size antibodies and antibody fragments in *Nicotiana tabacum*. *Transgenic Res.* **1999**, *8*, 255–263.
- 68 Conrad, U., Fiedler, U. Compartment-specific accumulation of recombinant immunoglobulins in plant cells: an essential tool for antibody production and immunomodulation of physiological functions and pathogen activity. *Plant Mol. Biol.* **1998**, *38*, 101–109.
- 69 Schillberg, S., Emans, N., Fischer, R. Antibody molecular farming in plants and plant cells. *Phytochem. Rev.* **2002**, *1*, 45–54.
- 70 Sriraman, R., Sack, M., Talwar, G.P., Fischer, R. Glycosylation of recombinant antibodies in plants. In: *Proceedings of the Ninth Annual Ranbaxy Science Foundation Symposium*. Ranbaxy Science Foundation, New Delhi, **2003**, pp. 89–98.
- 71 Daniell, H., Khan, M.S., Allison, L. Milestones in chloroplast genetic engineering: an environmentally friendly era in biotechnology. *Trends Plant Sci.* **2002**, *7*, 84–91.
- 72 Daniell, H., Kumar, S., Duformantel, N. Breakthrough in chloroplast genetic engineering of agronomically important crops. *Trends Biotechnol.* **2005**, *23*, 238–245.
- 73 Staub, J.M., Garcia, B., Graves, J., Hajdukiewicz, P.T.J., Hunter, P., Nehra, N., Paradkar, V., Schlittler, M., Carroll, J., Spatola, L., Ward, D., Ye, G.N., Russell, D.A. High-yield production of a human therapeutic protein in tobacco chloroplasts. *Nature Biotechnol.* **2000**, *18*, 333–338.
- 74 Fernandez-San Millan, A., Mingo-Castel, A., Miller, M., Daniell, H. A chloroplast transgenic approach to hyper-express and purify human serum albumin, a protein highly susceptible to proteolytic degradation. *Plant Biotechnol. J.* **2003**, *1*, 77–79.
- 75 Daniell, H., Lee, S.B., Panchal, T., Wiebe, P.O. Expression of the native cholera B toxin subunit gene and assembly as functional oligomers in transgenic tobacco chloroplasts. *J. Mol. Biol.* **2001**, *311*, 1001–1009.

- 76 Tregoning, J., Nixon, P., Kuroda, H., Svab, Z., Clare, S., Bowe, F., Fairweather, N., Ytterberg, J., Van Wijk, K., Dougan, G., Maliga, P. Expression of tetanus toxin fragment C in tobacco chloroplasts. *Nucleic Acids Res.* **2003**, *31*, 1174–1179.
- 77 Hood, E.E., Woodard, S.L., Horn, M.E. Monoclonal antibody manufacturing in transgenic plants – myths and realities. *Curr. Opin. Biotechnol.* **2002**, *13*, 630–635.
- 78 Stoger, E., Sack, M., Fischer, R., Christou, P. Plantibodies: applications, advantages and bottlenecks. *Curr. Opin. Biotechnol.* **2002**, *13*, 161–166.
- 79 Ma, J.K., Hiatt, A., Hein, M., Vine, N.D., Wang, F., Stabila, P., Van Dolleweerd, C., Mostov, K., Lehner, T. Generation and assembly of secretory antibodies in plants. *Science* **1995**, *268*, 716–719.
- 80 Larrick, J.W., Yu, L., Naftzger, C., Jaiswal, S., Wycoff, K. Production of secretory IgA antibodies in plants. *Biomolecular Eng.* **2001**, *18*, 87–94.
- 81 Chargelegue, D., Vine, N.D., Van Dolleweerd, C.J., Drake, P.M.W., Ma J.K.C. A murine monoclonal antibody produced in transgenic plants with plant-specific glycans is not immunogenic in mice. *Transgenic Res.* **2000**, *9*, 187–194.
- 82 Blixt, O., Allin, K., Pereira, L., Datta, A., Paulson, J.C. Efficient chemoenzymatic synthesis of O-linked sialyl oligosaccharides. *J. Am. Chem. Soc.* **2002**, *124*, 5739–5746.
- 83 Bakker, H., Bardor, M., Molthoff, J.W., Gomord, V., Elbers, I., Stevens, L.H., Jordi, W., Lommen, A., Faye, L., Lerouge, P., Bosch, D. Galactose-extended glycans of antibodies produced by transgenic plants. *Proc. Natl Acad. Sci. USA* **2001**, *98*, 2899–2904.
- 84 Shah, M.M., Fujiyama, K., Flynn, C.R., Joshi, L. Sialylated endogenous glycoconjugates in plant cells. *Nature Biotechnol.* **2003**, *21*, 1470–1471.
- 85 Seveno, M., Bardor, M., Paccalet, T., Gomord, V., Lerouge, P., Faye, L. Glycoprotein sialylation in plants? *Nature Biotechnol.* **2004**, *22*, 1351–1352.
- 86 Shah, M.M., Fujiyama, K., Flynn, C.R., Joshi, L. Glycoprotein sialylation in plants? Reply. *Nature Biotechnol.* **2004**, *22*, 1352–1353.
- 87 Strasser, R., Altmann, F., Mach, L., Glossl, J., Steinkellner, H. Generation of *Arabidopsis thaliana* plants with complex N-glycans lacking beta1,2-linked xylose and core alpha1,3-linked fucose. *FEBS Lett.* **2004**, *561*, 132–136.
- 88 FDA. Guidance for industry. Drugs, biologics, and medical devices derived from bioengineered plants for use in humans and animals. Food and Drug Administration, **2002**.
- 89 CPMP. Point to consider on quality aspects of medicinal products containing active substances produced by stable transgene expression in higher plants (CPMP/BWP/764/02), The European Agency for the Evaluation of Medicinal Products (EMA), **2002**.
- 90 Tackaberry, E., Prior, F., Bell, M., Tocchi, M., Porter, S., Mehic, J., Ganz, P.R., Sardana, R., Altosaar, I., Dudani, A. Increased yield of heterologous viral glycoprotein in the seeds of homozygous transgenic tobacco plants cultivated underground. *Genome* **2003**, *46*, 521–526.
- 91 Hare, P.D., Chua, N.H. Excision of selectable marker genes from transgenic plants. *Nature Biotechnol.* **2002**, *20*, 575–580.
- 92 Klaus, S.M.J., Huang, F.C., Golds, T.J., Koop, H. Generation of marker-free plastid transformants using a transiently cointegrated selection gene. *Nature Biotechnol.* **2004**, *22*, 225–229.
- 93 Ma, J.K.C., Hikmat, B., Wycoff, K., Vine, N., Chargelegue, D., Yu, L., Hein, M., Lehner, T. Characterization of a recombinant plant monoclonal secretory antibody and preventive immunotherapy in humans. *Nature Med.* **1998**, *4*, 601–606.
- 94 Stoger, E., Sack, M., Nicholson, L., Fischer, R., Christou, P. Recent progress in plantibody technology. *Curr. Pharma. Design* **2005**, *11*, 2439–2457.
- 95 Fahrner, R., Knudsen, H., Basey, C., Galan, W., Feuerhelm, D., Vanderlaan, M., Blank, G. Industrial purification of pharmaceutical antibodies: development, operation, and validation of chromatography processes. *Biotechnol. Genet. Eng. Rev.* **2001**, *18*, 301–327.
- 96 Bai, Y., Glatz, C.E. Bioprocess considerations for expanded-bed chromatography

- of crude canola extract: sample preparation and adsorbent reuse. *Biotechnol. Bioeng.* **2003**, *81*, 775–782.
- 97 Ma, J.K.C., Barros, E., Bock, R., Christou, P., Dale, P., Dix, P., Fischer, R., Irwin, J., Mahoney, R., Pezzotti, M., Schillberg, S., Sparrow, P., Stoger, E., Twyman, R.M. Molecular farming for new drugs and vaccines. Current perspectives on the production of pharmaceuticals in transgenic plants. *EMBO Rep.* **2005**, *6*, 593–599.
- 98 Ma, J.K.C., Chikwamba, R., Dale, P.J., Fischer, R., Mahoney, R., Twyman, R.M. Plant-derived pharmaceuticals – The road forward. *Trends Plant Sci.* **2006**, *10*, 580–585.
- 99 Vaquero, C., Sack, M., Chandler, J., Drossard, J., Schuster, F., Monecke, M., Schillberg, S., Fischer, R. Transient expression of a tumor-specific single chain fragment and a chimeric antibody in tobacco leaves. *Proc. Natl Acad. Sci. USA* **1999**, *96*, 11128–11133.
- 100 Torres, E., Vaquero, C., Nicholson, L., Sack, M., Stoger, E., Drossard, J., Christou, P., Fischer, R., Perrin, Y. Rice cell culture as an alternative production system for functional diagnostic and therapeutic antibodies. *Transgenic Res.* **1999**, *8*, 441–449.
- 101 Deneve, M., Deloouse, M., Jacobs, A., Vanhoudt, H., Kaluza, B., Weidle, U., Vanmontagu, M., Depicker, A. Assembly of an antibody and its derived antibody fragment in *Nicotiana* and *Arabidopsis*. *Transgenic Res.* **1993**, *2*, 227–237.
- 102 Bouquin, T., Thomsen, M., Nielsen, L.K., Green, T.H., Mundy, J., Dziegiel, M. Human anti-rhesus D IgG1 antibody produced in transgenic plants. *Transgenic Res.* **2002**, *11*, 115–122.
- 103 Semenyuk, E.G., Orlova, I., Stremovskii, O., Balandin, T., Nosov, A., Bur'yanov, Y., Deev, S. Transgenic tobacco plants produce miniantibodies against human ferritin. *Dokl. Biochem. Biophys.* **2002**, *384*, 176–178.
- 104 Ramirez, N., Rodriguez, M., Ayala, M., Cremata, J., Perez, M., Martinez, A., Linares, M., Hevia, Y., Paez, R., Valdes, R., Gavilondo, J., Selman-Housein, G. Expression and characterization of an anti-(hepatitis B surface antigen) glycosylated mouse antibody in transgenic tobacco (*Nicotiana tabacum*) plants and its use in the immunopurification of its target antigen. *Biotechnol. Appl. Biochem.* **2003**, *38*, 223–230.
- 105 Valdes, R., Reyes, B., Alvarez, T., Garcia, J., Montero, J., Figueroa, A., Gomez, L., Padilla, S., Geada, D., Abrahantes, M., Dorta, L., Fernandez, D., Mendoza, O., Ramirez, N., Rodriguez, M., Pujol, M., Borroto, C., Brito, J. Hepatitis B surface antigen immunopurification using a plant-derived specific antibody produced in large scale. *Biochem. Biophys. Res. Commun.* **2003**, *310*, 742–747.
- 106 Kathuria, S., Sriraman, R., Sack, M., Pal, R., Artsaenko, O., Talwar, G., Fischer, R., Finnern, R. Efficacy of plant-produced recombinant antibodies against HCG. *Hum. Reprod.* **2002**, *17*, 2054–2061.
- 107 Ehsani, P., Meunier, A., Nato, F., Jafari, A., Nato, A., Lafaye, P. Expression of anti human IL-4 and IL-6 scFvs in transgenic tobacco plants. *Plant Mol. Biol.* **2003**, *52*, 17–29.
- 108 Vine, N.D., Drake, P., Hiatt, A., Ma, J.K.C. Assembly and plasma membrane targeting of recombinant immunoglobulin chains in plants with a murine immunoglobulin transmembrane sequence. *Plant Mol. Biol.* **2001**, *45*, 159–167.
- 109 Benvenuto, E., Ordas, R.J., Tavazza, R., et al. 'Phytoantibodies': A general vector for the expression of immunoglobulin domains in transgenic plants. *Plant Mol. Biol.* **1991**, *17* (4), 865–874.

## 15

# Glycosylation of Recombinant Proteins in Plants

*Gilbert Gorr and Friedrich Altmann*

### 15.1

#### Introduction

One of the reasons for choosing plants or plant cells as hosts for recombinant protein production arises from their capability to perform most of the post-translational modifications that proteins experience in a mammalian cell. These abilities make them superior to bacterial hosts, which are virtually incapable of glycosylating proteins in a proper fashion – irrespective of the bewildering variety of glycan types produced by many bacterial species (Schaffer et al., 2001). Indeed, *Escherichia coli*, the most widely used expression system, does not glycosylate at all. Thus, with regard to all physico-chemical functions exerted by protein N-glycosylation, plants appear as perfect systems for the production of complex biopharmaceuticals. In fact, numerous recombinantly expressed human glycoproteins were harvested in a biologically active form from a broad spectrum of different plant species (Knaeblein, 2004; Ma et al., 2005a). However, closer examination of the plant-specific N-glycan pattern reveals several problematic features which may either lead to reduced efficacy and half-life or immunogenicity of the recombinant glycoproteins. In recent times it has been shown for a few plant species that limitations related to glycosylation can be overcome by genetic engineering.

In this chapter we will provide an insight in plant glycosylation and the progress made on “glyco-engineering”. After an initial introduction of the nomenclature of N-glycans, the subject of protein glycosylation will be introduced – including hydroxyproline-linked oligosaccharides and O-glycosylation – with special emphasis on plants. In terms of N-glycosylation, many details can be taken from recent reviews (Gomord and Faye, 2004; Seveno et al., 2004; Faye et al., 2005), and therefore we focus on the basic concept and newer insights. We will then compare this actual status with the desired mode of glycosylation and discuss potential drawbacks of plant-type glycosylation. Strategies for the “humanization” of the plant N-glycosylation pathway and recent results thereof will be discussed, and finally methods for the structural analysis of recombinant proteins and their attached modifications will be presented.



## 15.2

**A Word on Names**

While per definition any N-glycan which has been processed by GlcNAc-T I, GlcNAc-T II, fucosyltransferase, etc. is a complex-type N-glycan, many plant N-glycans (e.g., MMXF, MMX) are not so very “complex”, and will be referred to as truncated complex-type glycans. They are also sometimes referred to as paucimannosidic N-glycans, but this term should be reserved for glycans with two to four mannose residues and no further substituents (Kubelka et al., 1993).

Oligosaccharides with their branched structures have so far largely resisted attempts towards a linearized code. It is very difficult to communicate – either orally or in writing – about glycan structures without the help of figures or of arbitrary codes, which are useless without explanatory tables. Therefore, the “proglycan” system has been advised for N-glycans ([www.proglycan.com](http://www.proglycan.com)). Only the terminal residues of an N-glycan are denoted, starting from the residue in the upper left corner – that is, the one on the 6-linked antenna which is followed by the one on the 3-arm and then by substituents to the core. The residues have single-letter codes (M = mannose, G = glucose, A = galactose, F = fucose, X = xylose; Gn = N-acetylglucosamine, An = N-acetylgalactosamine, Na = N-acetylneuraminic acid, Ng = N-glycolylneuraminic acid). Where the linkage to the aglycon is ambiguous, it can be specified by a superscript, as for example in the case of the core-fucose which occurs in 6- or in 3-linkage. Likewise, sialic acids can be linked  $\alpha$ 2,3 or  $\alpha$ 2,6 to the galactose residue, which, however, itself may form a  $\beta$ 1,4- or a  $\beta$ 1,3-linkage. Therefore, both these linkages are specified as, for example, in the formula  $\text{Na}^{6-4}\text{Na}^{6-4}\text{F}^6$  (this may also be written:  $\text{Na}6-4\text{Na}6-4\text{F}6$ ) (Fig. 15.1). The written abbreviations with linkages can be substituted by simpler strings without numbers in oral communication. The first two terms represent the termini of the upper (6-linked) and lower (3-linked) antenna, respectively, while the following symbols stand for substituents of the core in the order: Xyl, 3-linked Fuc, 6-linked Fuc and bisecting GlcNAc which is represented by “bi”, for example in the IgG glycan  $\text{GnAFbi}$  (more exact:  $\text{GnA}^4\text{F}^6\text{bi}$ ). In triantennary glycans, the two terminal residues on one antenna are grouped by square brackets as for example in a glycan  $\text{Na}[\text{NaNa}]$  from bovine fetuin, where the branching is on the 3-arm. More details and examples can be found on [www.proglycan.com](http://www.proglycan.com).

## 15.3

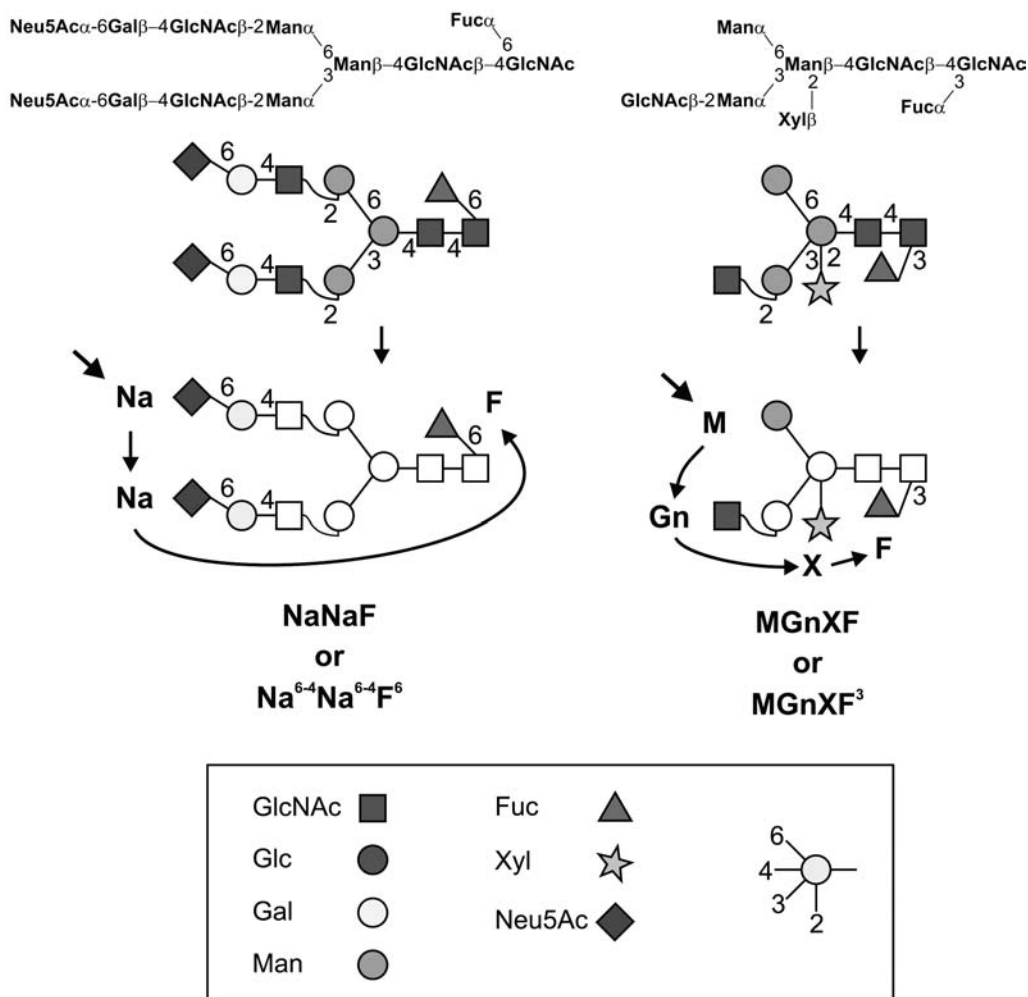
**General Aspects of Glycosylation**

## 15.3.1

**Asn-Linked Oligosaccharides (N-Glycans)**

The initial steps of protein N-glycosylation are conserved in all eukaryotic organisms. The same  $\text{Glc}_3\text{Man}_9\text{GlcNAc}_2$ -precursor is transferred to a nascent polypeptide chain in plants as in animals or yeasts (Lerouxel et al., 2005). The sequence motif for N-glycosylation (Asn-Xaa-Ser (NXS) or Asn-Xaa-Thr (NXT), with Xaa not





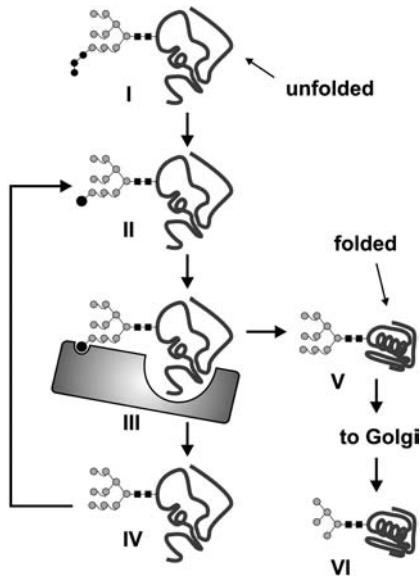
**Fig. 15.1** The “proglycan” nomenclature for N-glycans. The upper two structures depict typical mammalian and plant complex type N-glycans, respectively. In the lower drawing the non-terminal, invariable residues are shown as open symbols and the invariable linkages are omitted. The arrow in the upper left corner points at the residue with which the listing of terminal sugars starts. Superscript

numbers can be used to specify the linkage of sugars where alternative linkages are possible. In the case of sialylated complex type chains, the term  $\text{Na}^{6-4}$  (an abbreviation of  $\text{Na}^6\text{-A}^4$ ) means that Neu5Ac is linked  $\alpha 2,6$  to a galactose which is itself in  $\beta 1,4$ -linkage to the GlcNAc. (See also [www.proglycan.com](http://www.proglycan.com).) Note: A color version of this figure is available in the color plate section.

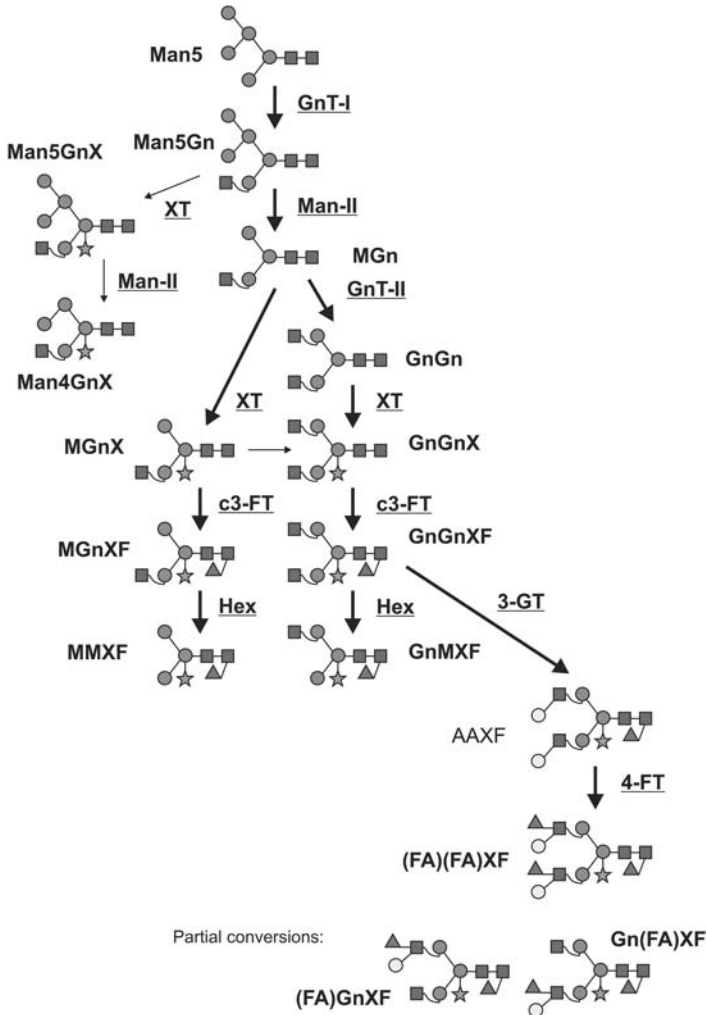
being Pro) is likewise the same, irrespective of possible differences in the relative efficiency towards various sequences of the phylogenetically very distant oligosaccharyltransferases. The glycosylation-dependent chaperones calnexin and calreticulin are found in the plant endoplasmic reticulum (ER) (Pagny et al., 2000), and it is fair to assume that here they exert the same support function for protein folding

as is found in the ER of mammalian cells (Helenius and Aebi, 2001) or yeast (Parodi, 1999). These chaperones bind to glycoproteins still containing Glc-residues at the non-reducing terminus as marker for synthesized proteins which, however, lose these glucoses by the action of ER glucosidase I and II (Caramelo et al., 2003, 2004; Gomord and Faye, 2004). Glycoproteins having failed to fold properly in this time window are re-glycosylated to allow repeated chaperoning by calnexin or calreticulin (Fig. 15.2). Here is encountered a highly important role of protein-glycosylation for the control of protein quality (Ellgaard and Helenius, 2003), which affects the yield and secretion of biologically active protein. Recombinant proteins where the NXS/T motif has been mutated to prevent glycosylation cannot benefit from this support during folding. Almost needless to say, the same holds true for glycoproteins expressed in bacterial hosts.

The next steps of glycoprotein maturation in the ER and in the cis-Golgi apparatus are again identical in plants and mammals up to the action of GlcNAc-transferase I, GlcNAc-transferase II and Golgi  $\alpha$ -mannosidase (Fig. 15.3). From here on, the two kingdoms have decided to go their own ways. Whilst in mammals the terminal GlcNAc residues are immediately shielded by the action of  $\beta$ 1,4- (or, seldom, by  $\beta$ 1,3-)Gal-transferase – with the notable exception of IgG, where this step occurs only partially – elongation in plants is exclusively by  $\beta$ 1,3-galactosylation, though only a very small part of the glycans appear to undergo this modification, as can be deduced from the relative abundance of various structural types (Wilson et al., 2001b). The Gal-residues in mammals may be capped by sialic acid and only quite rarely substituted by fucose. Again, plants are different, as they are devoid of sialylation (Seveno et al., 2004; Zeleny et al., 2006), and in case that a terminal 1,3-linked Gal residue was attached they essentially always fucosylate the penultimate GlcNAc residue, thereby forming a Lewis a (Le a) determinant (Fitchette-Laine et



**Fig. 15.2** Folding assistance by glycosylation-dependent chaperones. The unfolded protein with a glucose residue at the non-reducing end (large circle) is bound and chaperoned by calnexin or calreticulin (Parodi, 1999; Helenius and Aebi, 2001). Glucosidase eventually removes this glucose residue. If the protein has still not succeeded in folding properly it is re-glycosylated by a folding-sensitive glucose-transferase. Only the correctly folded glycoprotein is allowed to proceed to the Golgi body. Note: A color version of this figure is available in the color plate section.



**Fig. 15.3** Biosynthesis of complex-type N-glycans in the plant Golgi body. Starting with the smallest oligomannosidic N-glycan Man5, the assumed major routes are shown by bold arrows. Less important routes are indicated with thin lines. The symbols for the sugars follow the recommendations of the *Consortium for Functional Glycomics*. The direction in which the linkage lines emanate symbolize the linkage, as indicated in Fig. 15.2. Anomerities are as follows: GlcNAcs are  $\beta$ , Fuc  $\alpha$ , Gal  $\beta$ , Xyl  $\beta$ , Man  $\alpha$  except the one  $\beta$ -linked to GlcNAc. The route invariably involves

GlcNAc-transferase I (GnT-I), then  $\alpha$ -mannosidase II (Man II), GlcNAc-transferase II (Gn T-II), xylosyltransferase (XT), core- $\alpha$ 1,3-fucosyltransferase (c3-FT), an unidentified *N*-acetylglucosaminidase (Hex), a  $\beta$ 1,3-galactosyltransferase (3-GT), and finally an  $\alpha$ 1,4-fucosyltransferase (4-FT). Often, the last two steps, which generate Lewis x determinants, only occur on one antenna, thus leading to Gn(FA)XF and (FA)GnXF (Wilson et al., 2001b; Koprivova et al., 2003).

al., 1997; Melo et al., 1997; Wilson et al., 2001b). Apparently, the  $\beta$ 1,3-Gal-transferase is the limiting enzyme, whereas most plant cells contain sufficient activity of  $\alpha$ 1,4-Fuc-transferase to ensure that each Gal-containing antenna is fucosylated (Wilson et al., 2001a). The LeA structure is a human blood group determinant. It is rare as such in healthy adults, but as sialyl-Lewis a (sLe a) it is notoriously found in malignant tissues such as colon cancer (Sakamoto et al., 1986; Ichihara et al., 1993; Kannagi et al., 2004). One would assume that a LeA structure on a plant-made biopharmaceutical would not be immunogenic. The non-reducing termini, although at that time with an incorrect structural assignment, have also been alleged as IgE epitopes some time ago (Ogawa et al., 1996), but no follow-up study on this topic is known to the authors.

Anyway, LeA-containing glycoproteins are rarely isolated from plants, possibly because soluble bulk proteins usually are not modified in this way. Another explanation would be that, upon tissue homogenization, the glycosidases degrade the LeA antennae. However, this seems unlikely as human erythropoietin expressed in glycoengineered moss and secreted into the supernatant of liquid cultures thereof contained mainly N-glycans with one or two LeA antennae (A. Weise et al., unpublished results).

Another highly remarkable peculiarity of plants is that they contain two enzymes totally unknown in higher animals, the  $\beta$ 1,2-xylosyltransferase (Xyl-T) and the core- $\alpha$ 1,3-fucosyltransferase (c3-Fuc-T) (Leiter et al., 1999; Strasser et al., 2000; Wilson et al., 2001a; Pagny et al., 2003; Leonard et al., 2004). The residues transferred by these enzymes render plant N-glycans immunogenic (Lauriere et al., 1989; Kurosaka et al., 1991; Ramirez-Soto and Poretz, 1991; Prenner et al., 1992; Faye et al., 1993; Tretter et al., 1993; van Ree et al., 2000; Hemmer et al., 2001; Bardor et al., 2003a; Bencurova et al., 2004). To our knowledge, both sugar residues are present on plant N-glycans of any plant host analyzed to date.

The biotechnological repercussions of this immunogenic glycosylation and strategies for glyco-engineering, respectively are discussed below.

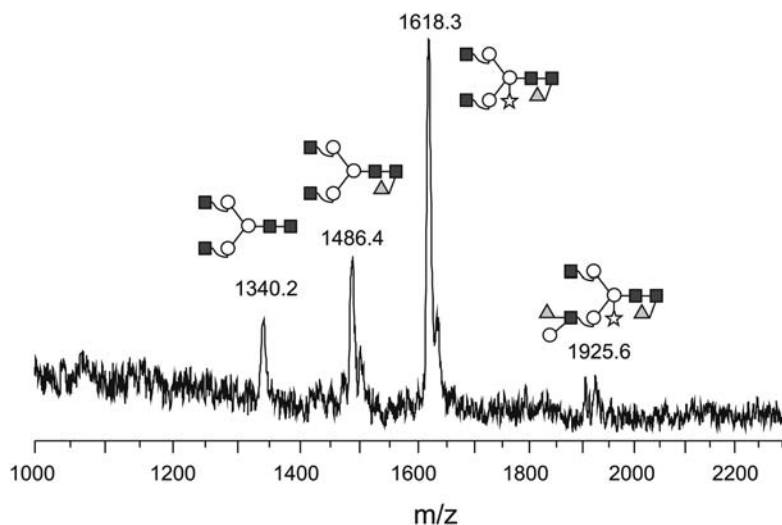
Xyl-T can act as soon as GlcNAc-T I has done its job (Strasser et al., 2000; Bencur et al., 2005). If Xyl-T works before  $\alpha$ -mannosidase, a side route to hybrid-type glycans is initiated because the mannosidase is severely slowed by the presence of xylose (Strasser et al., 2006). The bulk flow of glycans experiences removal of two mannose residues and the subsequent addition of xylose and fucose to the MGn structure. A third enzyme, GlcNAc-transferase II (GlcNAc-T II), is supposed to act before Xyl- and Fuc-T, but the order appears to be loose, at least with respect to Xyl-T (Bencur et al., 2005). Thus, the level of GlcNAc-T II determines if the final product is MGnXF or GnGnXF (Fig. 15.3). In terms of seed plants, this GlcNAc-T II appears to constitute a limiting factor, as almost in all cases studied a substantial amount of the complex-type glycans had the structure MGnXF (Wilson and Altmann, 1998; Wilson et al., 2001b), whereas, the GnGnXF structure dominates in the wild-type strain of the moss *Physcomitrella patens* (Koprivova et al., 2003; Vietor et al., 2003).

However, in seed plants a roughly comparable fraction turned out to be the other isomer GnMXF, where the single terminal GlcNAc residue is on the 6-arm (Wilson and Altmann, 1998; Wilson et al., 2001b). At this point we must concede

that the prototypical N-glycan structure of isolated glycoproteins in seed plants is MMXF – that is, a glycan which lacks the GlcNAc-residue on the 3-arm which is prerequisite to the action of mannosidase II, Xyl-T and c3-Fuc-T (Fournet et al., 1987; Sturm et al., 1987; Sonnewald et al., 1989; Ashford et al., 1991; Kurosaka et al., 1991; Ramirez-Soto and Poretz, 1991; Sturm, 1991; Stahl et al., 1994; Lerouge et al., 1998, 2000; Wilson and Altmann, 1998; Bardor et al., 1999, 2003b; Rayon et al., 1999; Olczak and Watorek, 2000; Bakker et al., 2001; Samyn-Petit et al., 2001; Wilson et al., 2001b; Koprivova et al., 2003; Mokrzycki-Issartel et al., 2003; Leonard et al., 2004; Strasser et al., 2004a,b).

The phenomenon was described some time ago and termed “transient GlcNAc” (Vitale and Chrispeels, 1984). These authors found the removal of GlcNAc to take place in protein bodies. However, in seed plants, loss of GlcNAc was also observed on secretory glycoproteins (Dirnberger et al., 2001). The question remains of whether the partial to full removal of the 3-arm GlcNAc is simply an incidental degradative process, that possibly also affects the 6-arm GlcNAc, or whether it is deliberately performed by a dedicated  $\beta$ -N-acetyl-glucosaminidase activity ( $\beta$ -Hex), as is the case in insects (Leonard et al., 2006).

As pointed out above, for the moss *Physcomitrella patens* the situation is likely different. No loss of GlcNAc residues was found on N-glycans of recombinantly expressed antibody (Fig. 15.4). In this case, the moss strain showing wild-type glycos-



**Fig. 15.4** Truly complex N-glycosylation on antibodies expressed in the moss *Physcomitrella patens*. MALDI-TOF analysis of N-glycans released from antibody expressed in a moss strain with unmodified plant-specific glycosylation. Remarkably, almost all structures are of the complex-type. While the antibody shown here still contained plant wild-type glycans with xylose and core- $\alpha$ 1,3-fucose

residues, the production of proteins lacking these two immunogenic sugar residues has been successfully accomplished with double knock-out strains of *Physcomitrella patens* (Koprivova et al., 2004; Huether et al., 2005; Jost and Gorr, 2005; M. Schuster et al., unpublished results; A. Weise et al., unpublished results). Note: A color version of this figure is available in the color plate section.

ylation pattern was used, and therefore not only the terminal GlcNAc residues but also the plant-specific xylose and fucose residues are present.

Until very recently, it was firmly held that plants are unable to synthesize sialic acids and sialylated glycoproteins (Lerouge et al., 2000), though this dogma was recently challenged by an article describing the discovery of reasonable amounts of sialic acids, mainly *N*-glycolylneuraminic acid, in cultured *Arabidopsis thaliana* MMY2 cells (of undefined origin) (Shah et al., 2003). This claim met considerable skepticism in the plant glycoprotein community, and was quickly followed by a dissenting article (Seveno et al., 2004), which questioned the validity of the lectin blot results. These authors could not find sialic acids by HPLC with fluorescence detection. Moreover, Zeleny et al. questioned the chromatographic and mass spectrometric methodology and showed that traces of sialic acids detected by sensitive procedures were likely to be contaminations (Zeleny et al., 2006).

### 15.3.2

#### **Mucin-Type and Other O-Linked Glycans (O-Glycan)**

Mammalian glycoproteins may contain oligosaccharides linked to serine or threonine residues. The most frequently found type in this diverse group of O-glycans are the mucin-type O-glycans with the basic structure Gal $\beta$ 1-3GalNAc $\alpha$ -Ser or -Thr which can be sialylated and substituted in various ways (Brockhausen et al., 2001). A single report described the detection by two-dimensional HPLC of this disaccharide in rice glutelin (Kishimoto et al., 1999). The attachment site was not experimentally determined, and thus it remains unclear whether plant cells use the same O-glycosylation motifs as do mammalian cells. Unfortunately, for human proteins that are naturally O-glycosylated, no report of a mucin-type O-glycosylation by a plant expression system has been published to the best of the author's knowledge.

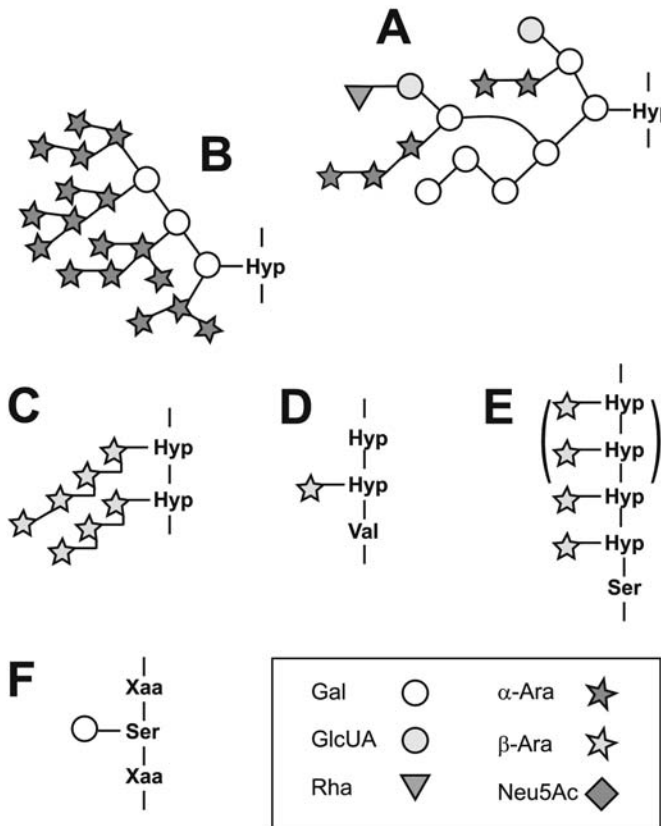
Several not too-recent papers describe the detection by methylation analysis and other strategies of single galactose residues linked to serine in potato lectin and extensins (Lamport et al., 1973; Cho and Chrispeels, 1976; Allen et al., 1978; Ashford et al., 1982). This Gal-Ser linkage has led a hidden life ever since.

### 15.3.3

#### **Hydroxyproline-Linked Oligosaccharides (Hyp-O-Glycans)**

Prolyl oxidation by prolyl hydroxylases is found in animals as well as in plants, though the responsible enzyme can be expected to have a different substrate specificity (Myllyharju, 2003). In mammalian glycoproteins (e.g., collagen), the hydroxyproline (Hyp) residues are not glycosylated. In the special class of plant proteins termed hydroxy-proline-rich glycoproteins (HRGPs), the Hyp residues bear either small arabino-oligosaccharides or large arabinogalactan-polysaccharides (Fig. 15.5) (Showalter, 2001). The latter lent their name to the most prominent group of HRGPs, the arabinogalactan-proteins (AGPs), which play multiple important roles in developing plant tissues (Sun et al., 2004). For a long time, AGPs and HRGPs have been virtually neglected by plant biotechnologists not directly involved in

studies on plant tissue developmental or cell wall structure. However, this situation is about to change as it transpires that rather small sequence motifs, which also may occur in many proteins not regarded as HRGPs, determine these types of modification. The contiguity hypothesis provides a simple rule as for the attachment of arabinans or polysaccharide (Goodrum et al., 2000; Kieliszewski, 2001; Kieliszewski and Shpak, 2001; Shpak et al., 2001; Tan et al., 2003). In detail, non-



**Fig. 15.5** O-linked poly-, oligo- and monosaccharides. Due to the bewildering structural heterogeneity of plant O-glycans, and to the difficulties of separating and analyzing these glycans, the figures must be taken as arbitrary selections from a large pool of related structures. Structure A depicts a (rather small) type II arabinogalactan polysaccharide with additional sugars such as rhamnose and glucuronic acid according to Tan et al. (2004). Structure B shows a type III arabinogalactan as found on a mugwort pollen allergen (Leonard et al., 2005). Structure C represents

arabinan chains on adjacent Hyp residues (Ashford et al., 1982), while D and E show the mono-arabinose moieties found in timothy grass and mugwort pollen allergens (Wicklein et al., 2004; Leonard et al., 2005). Structure F finally depicts the Gal-Ser motif thought to occur in extensins and solanaceous lectins (Lampert et al., 1973; Ashford et al., 1982). Connecting lines between sugar symbols indicate the linkage as specified in Figure 15.1. Note: A color version of this figure is available in the color plate section.

contiguous Hyp residues such as the sequence -Xaa-Hyp-Xaa-Hyp-Xaa- (Xaa being any amino acid) will most often bear arabinogalactan-polysaccharides (see below for a description). Contiguous Hyp residues as for example the motifs Xaa-Hyp-Hyp or Xaa-Hyp-Hyp-Hyp-Hyp, are arabinosylated; that is, the Hyp residues bear linear chains composed of  $\beta$ 1,3- and  $\beta$ 1,2-linked arabinosyl residues (Akiyama et al., 1980). This type of glycosylation is typically found on extensins, another class of proteins essential for the formation of cell walls, and also on solanaceous lectins (Ashford et al., 1982; Peumans and Van Damme, 1998). To guarantee confusion, nature also developed intermediate or mixed proteins containing both types of glycosylation, such as the gum arabic AGPs, the tomato LeAGP-1, or a pistil-specific protein from tobacco (Goodrum et al., 2000; Bosch et al., 2001; Zhao et al., 2002). The type II arabinogalactans consist of a  $\beta$ 1,3-linked galactan backbone which also contains (or is substituted by)  $\beta$ 1,6-linked galactose residues and by mainly terminal or  $\alpha$ 1,5-linked arabinose residues (Bacic et al., 1987; Gane et al., 1995). Additional sugars such as rhamnose and glucuronic acid can be found. Type II arabinogalactans generally are complex, highly branched, disperse and it is hardly possible to fully characterize their structure (Saulnier et al., 1992; Gane et al., 1995; Tan et al., 2004). Tan and co-workers provided a model of an arabinogalactan with only around 15 to 17 sugar residues (Fig. 15.5) (Tan et al., 2004). This contrasts with other results indicating that type II arabinogalactans are large and consist of hundreds and more sugar residues (Fincher et al., 1974; Gane et al., 1995), so that they may constitute up to 95% of the mass of an AGP (Gane et al., 1995; Classen et al., 2000; Kim et al., 2002). Notably, arabinogalactans can be immunogenic and immunostimulatory (Kim et al., 2002).

The allergen Art v 1 from the compositum *Artemisia vulgaris* (mugwort) was shown to contain a so-called type III arabinogalactan consisting of a short  $\beta$ 1,6-galactan and branched side chains of arabinose only (Fig. 15.5) (Leonard et al., 2005). Additionally, the (hydroxy-) proline-rich domain of Art v 1 contained a number of single arabinose residues in  $\beta$ -linkage to adjacent Hyp-residues instead of the arabino-oligosaccharides found on similar domains in other plants (Leonard et al., 2005). These clusters of mono-arabinosylated Hyp bound IgE from sera of allergic patients (Leonard et al., 2005). The distribution of this novel carbohydrate IgE epitope in the plant kingdom is currently unknown.

To conclude, plants assemble an array of odd molecules from proline, galactose and arabinose. None of these glycan types is found in mammalian glycoproteins and some of them are immunogenic. However, plants do not refrain from grafting these structures onto recombinant proteins intended for therapeutic use (see also below) (Karnoup et al., 2005).

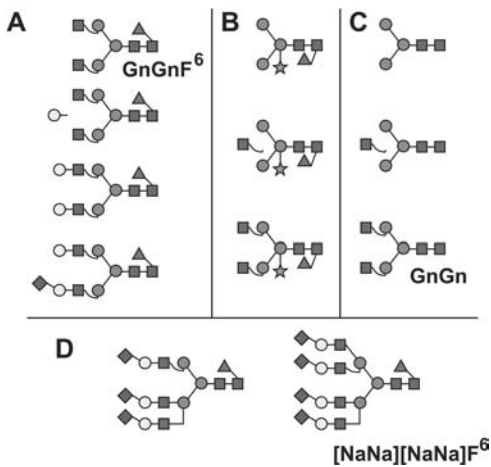
## 15.4

### Why Antibodies?

The probably most interesting group of human glycoproteins which can be produced in plants is that of antibodies, and here again that immunoglobulins of class



G. This is a logical consequence of the large current (and even larger anticipated) demand for this class of biotech drugs in terms of quantity and diversity (Ma et al., 2005a). Several plant-, plant tissue- or plant cell-based expression systems have proven their principal ability to produce functional antibodies in a large number of cases (Ma et al., 2003, 2005a; Jefferis, 2005). In addition, the glycosylation pattern found on human antibodies appears to be a comparably simple problem to be solved when compared to, for example erythropoietin and coagulation factor VIII. IgG has a single conserved N-glycosylation site at Asn297 in the Fc part of each heavy chain. Some idiotypes may additionally bear N-glycans in the variable region. However, the incidental nature of these glycosylation sites may indicate a marginal significance of the N-glycans attached to them. In contrast, glycosylation at the conserved site has been shown to be essential for many aspects of antibody efficiency *in vivo* (Mimura et al., 2001; Jefferis, 2005). Approximately 90% of the oligosaccharides are complex-type glycans without sialic acid, while the remaining 10% carry one sialic acid residue (Fig. 15.6). Although this amounts to one-fifth of the assembled antibodies being mono-sialylated (antibodies with two sialylated glycans are considered rare for statistical and steric reasons), this fraction may be regarded as dispensable until the opposite is proven. In fact, Chinese hamster ovary (CHO) cells – the approved traditional host for the production of recombinant therapeutic antibodies – tend to undersialylate the recombinant protein. Therefore, the inability of plants to produce sialic acid and to transfer it to glycoproteins results in



**Fig. 15.6** N-glycans on IgG and other serum glycoproteins. Panel A lists the major structures found on natural human IgG, the sialylated species accounting for only ca. 10%. Glycans of IgG expressed in plants are shown in panel B, whereas panel C shows the major structures expected to occur on IgG expressed in glyco-mutants devoid of Xyl- and

Fuc-transferase. IgG was found to be even more potent with N-glycans lacking fucose (GnGn) than with the natural fucosylation (GnGnF<sup>6</sup>). Panel D shows examples of tri- and tetra-antennary, fully sialylated glycans as found on human erythropoietin as an example of the most complex glycosylated human proteins.

no limitation for the majority of antibodies which are not glycosylated in the variable domains.

In contrast, human serum glycoproteins other than IgGs almost invariably bear completely sialylated N-glycans. In many cases (e.g., on erythropoietin; EPO) there are not only two but three or four antennae (Fig. 15.6) (Tsuda et al., 1988; Takeuchi et al., 1990). A plethora of fine distinctions (linkages) and additional modifications (LacNAc-repeats, sulfation, Lewis structures) may further add to the complexity of glycan structures. It is largely unclear how exacting the natural structures must be reproduced on a recombinant therapeutic glycoprotein. This is reflected by the fact that until now none of the approved expression hosts allows the identical copy of a human glycoprotein in terms of microheterogeneity. As a rule of thumb, underglycosylation (i.e., the presence of terminal galactose or GlcNAc residues) reduces the half-life in the circulation and hence the efficacy of the drug; this situation is not tolerable, with the notable exception of IgG (Wright and Morrison, 1998). Therefore, the production of antibodies in plants appears as a comparatively simple and realizable task.

Plants are even able to correctly synthesize and fold the even more complex secretory antibodies of the IgA class (Ma et al., 1995; Karnoup et al., 2005; Yoo and Morrison, 2005). A thorough mass spectrometric inspection of a plant-made IgA, however, revealed that in the hinge region a number of the numerous contiguous proline residues had been oxidized and arabinosylated (Karnoup et al., 2005). Therefore, the plant host of choice for recombinant expression of biopharmaceuticals should be genetically well characterized (for identification of the responsible genes) and should be accessible for glycoengineering, for example by extensive genetic modification, as in the case of the moss *Physcomitrella patens* (Decker and Reski, 2004; Gorr and Wagner, 2005).

However, in terms of recombinant production of mammalian glycoproteins in plants, it should be borne in mind that analysis of the integrity of the target protein is a highly important issue and should be performed as early as possible. Nonetheless, recent advances in plant glycoengineering (see below) are auspicious and not limited to plant-made antibodies.

## 15.5

### “Humanization” of N-Glycans in Plants

#### 15.5.1

##### Authentic or Human-Like Glycosylation as the Benchmark

The question of how the glycosylation of a given protein should “look” is complicated by the heterogeneity of glycan structures on a particular site and protein. In other words, we are dealing with sets of structures, and the simplest concept for a recombinant product is to request it to have a glycan pattern which is substantially equivalent to that of the human protein. For antibodies, it is fortunately possible to define such an “authentic glycosylation pattern”, but for many other glycoproteins

the authentic pattern is either not known or dependent on the producing organ and on the medical status of a person. Generally, the more complex the glycosylation structure of a given protein (e.g., bi-, tri-, tetra-antennary and/or highly sialylated), the more microheterogeneity related to the different N-glycans on this protein will be detected (e.g., erythropoietin or follicle-stimulating hormone) (Kobata, 1992). In such cases the quest for an authentic glycosylation profile must be substituted by two questions:

1. Is the glycan an usual constituent of the human glycome (assuming the drug to be intended for humans), or is it foreign to the human immune system and hence potentially immunogenic and precarious for the consumer?
2. Which structural details enhance and which reduce the pharmacological efficacy of the glycoprotein of interest?

Plants in fact equip proteins with glycan structures very different from those found in mammals. Truncated N-glycans expose terminal mannose residues which make the protein prey to endocytosis and hence decrease its circulatory half-life (Mukhopadhyay and Stahl, 1995; Dirnberger et al., 2001; Ko et al., 2003). Besides, in some cases even GlcNAc may not be the optimal terminal sugar on IgG N-glycans, and a high degree of galactosylation may be beneficial (Dong et al., 1999; Warnock et al., 2005b). Therefore the under-GlcNAcylation seen on most secretory proteins expressed in seed plants (see above) is undesirable. Comparable to the N-glycan pattern of an antibody expressed by the moss *Physcomitrella patens* (see Fig. 15.4), only alfalfa (*Medicago trunculata*) has provided a more "homogeneous" glycosylation of a particular antibody – that is, a strong preponderance of GnGn-type structures (Bardor et al., 2003b). Results obtained with recombinant phytase, however, indicate that homogenous glycosylation with two terminal GlcNAc residues cannot routinely be achieved with alfalfa (Abranches et al., 2005). As a general rule, the glycosylation pattern depends upon the expression system, the protein expressed, and on growth conditions and even the developmental stage of the host tissue (Elbers et al., 2001).

The most precarious feature of plant-made glycans is the presence of the two sugars xylose and fucose (in 3-linkage to the core GlcNAc), each making the glycan an immunogenic entity (Bencurova et al., 2004). About one-quarter of allergic individuals have developed IgE specifically binding such complex type plant N-glycans (Tretter et al., 1993; van Ree et al., 2000; Mari, 2002). Anti-carbohydrate antibodies confer a broad immunological cross-reactivity owing to the ubiquitous occurrence of such glycans in plants, lower animals, mollusks and – with only fucose – insect venoms (Van Kuik et al., 1985, 1986; Laine and Faye, 1988; Kubelka et al., 1993; Altmann et al., 1999; van Die et al., 1999; Hemmer et al., 2001; Gutternigg et al., 2004). These glycans have therefore been christened "cross-reactive carbohydrate determinants" (CCDs) (Aalberse and van Ree, 1996).

Healthy individuals contain IgG directed against such CCDs, as judged from antibody binding to snail hemocyanin and a honeybee venom allergen (Bardor et al., 2003a). Surprisingly, results on the binding of such human or of rabbit anti-CCD antibodies to plant-made antibodies have not yet been published, excepting

studies conducted on an antibody which, however, contained a glycosylation site in the variable domain (Sriraman et al., 2004). Given the tight packing and shielding of the sugar residues in the Fc region of IgG, the xylose and especially fucose residue may be less accessible to antibodies, as in the more usual case of sugars protruding from the surface of proteins. A related but different question is whether the administration of plant-made pharmaceuticals would elicit an anti-CCD immune response.

A plant-produced antibody has recently been reported not to be immunogenic in mice (Chargelegue et al., 2000). However, the mouse strain used (BALB/c) was shown to be a non-responder to complex-type plant N-glycans (Bardor et al., 2003a). Antibodies binding complex plant N-glycans can be raised in C57BL/6 mice (Bardor et al., 2003a), but a recent comparison of the immunogenicity of plant glycans in mice and rabbits indicated that mice, also those of the C57BL/6 strain, are inappropriate hosts for eliciting specific anti-CCD antibodies (Jin et al., 2006). This particularity of the murine immune system also appears to extend to rats (Bencurova et al., 2004). Any conclusion on the significance of plant glycans on recombinant proteins drawn from studies with rodents must therefore be considered with some caution. A recent review cited a personal communication from Dr. L. Grill (Large Scale Biology, CA), who could not find any serious adverse reactions following immunization with a plant-derived antibody (Ma et al., 2005b).

One should be aware that glycan immunogenicity may be a much less severe issue for proteins which are not injected into the patients body but administered only atopically (e.g., for caries prophylaxis; Chargelegue et al., 2000; Ma et al., 2005b). Humans are in fact routinely exposed to plant glycoproteins in their diet, though obviously without negative consequences.

For parenteral drugs, however, the most widely accepted view is that, with regard to patient's safety, the immunogenic sugar residues must not be present on the biopharmaceutical. In turn, other residues such as terminal GlcNAc and Gal should be added, as we shall see below.

The issue of non-human glycosylation is not restricted to N-glycans. It is highly questionable – to express it diplomatically – whether the exchange of mucin type Ser/Thr linked glycans to Hyp-linked arabinans in the proline-rich hinge region of IgA can be accepted in parenteral drugs (Karnoup et al., 2005). However, as for other expression systems (e.g., CHO cells), the attachment sites for post-translational modifications such as Hyp-O-glycosylation or O-glycosylation (see above) are predictable from the primary amino acid sequence and might be excluded in advance. The integrity of the product must be tested in any case.

Finally, it should not be forgotten that antibodies produced in animal cells (mainly CHO, NS0) may likewise be immunogenic (Werner et al., 1998; Gomord et al., 2005). Moreover, the protein portion of “humanized” antibodies may itself be immunogenic (Gomord et al., 2005). Thus, while immunogenicity is not an “extra-terrestrial” phenomenon seen only with plant-made antibodies, it is certainly deserving of the notorious statement: “More research is needed”.

## 15.5.2

**Towards a Humanized N-Glycosylation in Plants**

As highlighted above, the two plant-specific sugar residues – the core fucose and the xylose – are considered to be the major limitation for plant-made injectable glycoproteins, especially due to their immunogenic potential.

The very first approach in the direction of non-immunogenic plant glycans was the isolation of an *Arabidopsis* mutant by immunostaining which was found to lack GlcNAc-T I (von Schaeuwen et al., 1993; Strasser et al., 2005). Although of minimal biotechnological value by itself, this *cgl* mutant (*cgl* indicates complex type glycosylation) showed that plants without complex-type sugars are viable and in fact do not show an eye-catching, easily observable phenotype. At a time when investigations with knock-out mice drastically showed the absolute necessity of complex-type glycans in animals (Schachter, 2002), this was an important encouragement for biologists to pursue the glycoengineering of plants. It should be noted that in this mutant plant the enzymes responsible for attachment of the two immunogenic plant-specific residues are still present, but because of the lack of proper substrate they cannot generate cross-reactive carbohydrate determinants.

An early approach with anti-sense RNA intended to silence GlcNAc-T I in *Nicotiana benthamiana* plants failed to reduce the content of immunoreactive sugars, despite a more than 50-fold reduction of transferase level (Strasser et al., 2004a). A marginal increase in Man5 was seen as the only response.

Another very popular (as far as this term is appropriate in this context) approach makes use of the retention signal for ER-resident proteins, KDEL or HDEL (Wandelt et al., 1992; Gomord et al., 1997; Ko et al., 2003; Tekoah et al., 2004). ER-retention was found to considerably increase product yield (Schouten et al., 1996), but the final product bears oligomannosidic N-glycans, which hardly can be regarded as desirable for injectable glycoproteins except for products with a desired short half-life. In addition, in many instances (but not always) the ER-retention mechanism is subject to slight leakage (Ko et al., 2003; Tekoah et al., 2004). This leakage leads to the occurrence of some complex-type N-glycans in the product, and probably also to the presence of plant-specific residues. Its abundance may have been underestimated in cases where N-glycosidase F was used during the course of glycan analysis (see below) (Ko et al., 2003; Tekoah et al., 2004).

The most elegant, radical and convincing approach would be the targeted knock-out of the two respective genes coding for the xylosyl- and core  $\alpha$ 1,3-fucosyltransferase by homologous recombination. Unfortunately, plants (at least higher plants) are not accessible to this aim, but there are two exceptions to this rule. The first one, *A. thaliana*, also does not allow gene knock-out, but there exists a large collection of T-DNA insertion lines (<http://signal.salk.edu/about.html>) which can be searched specifically for insertions into the gene of interest (Alonso et al., 2003). By identifying T-DNA lines for the two fucosyl- and the one xylosyltransferase knock-outs and by crossing these three lines, a mutant *Arabidopsis* plant was generated in which the N-glycans no longer contained xylose and core-fucose and which did not at all bind anti-CCD antiserum (Strasser et al., 2004b). While *Arabidopsis* is not re-

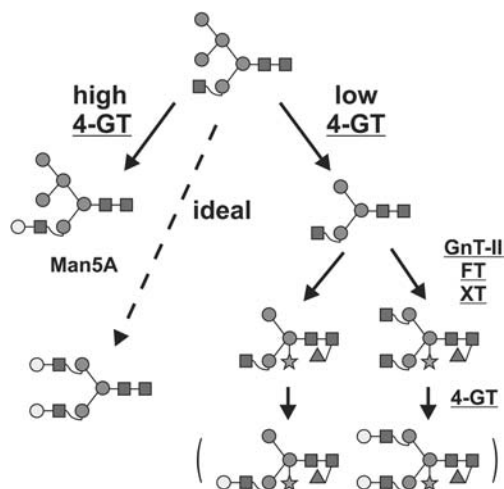
garded as an industrial protein production system, this line may allow the generation of humanized antibody in plants.

The only plant, however, where true targeted gene knock-out has ever been successfully and efficiently performed is the moss *Physcomitrella patens* (Girke et al., 1998; Koprivova et al., 2002). In contrast to *Arabidopsis*, fucosyltransferase is encoded by just one single-copy gene in *Physcomitrella patens*. A stable knock-out line devoid of fucosyl- and xylosyltransferase has been generated (Koprivova et al., 2004). *Physcomitrella* is used as an expression host based on secretion of the target protein into the medium of liquid cultures. Several products have been expressed successfully in double knock-out strains in high yields, including IgG4 (Gorr and Jost, 2005), IgG1 (M. Schuster et al., unpublished results), and EPO (A. Weise et al., unpublished results).

For modern crop plants, there is however little hope for gene knock-out, not least because of their polyploidy. In the case of tobacco, corn, alfalfa, and duckweed RNAi technology promises results within a predictable timeframe. In fact, RNAi technology was used successfully in *N. benthamiana* plants to knock-down the expression of  $\beta$ 1,2-xylosyltransferase, which resulted in clearly reduced amounts of  $\beta$ 1,2-linked xylose containing N-glycans (R. Strasser et al., Fourth International Symposium on Glycosyltransferases, Le Touquet, 2004). This contrasts the poor result obtained with sense/antisense RNA of GlcNAc-T I (Strasser et al., 2004a), which may be explained by the higher efficiency of newer RNAi strategies or by differences in the rate of overexpression of GlcNAc-T I versus Fuc-T and Xyl-T (R. Strasser, personal communication).

A fourth strategy employs enzymes competing for substrates with the undesirable Xyl-T and Fuc-T activities. In fact, co-expression of  $\beta$ 1,4-galactosyl-transferase (4-Gal-T) with the product of interest is an obvious means to “humanize” plant N-glycans (Fig. 15.6), and this has repeatedly been reported (Palacpac et al., 1999; Bakker et al., 2001; Fujiyama et al., 2001). The Xyl- and Fuc-Ts can no longer act on substrates containing galactosylated antennae (Leiter et al., 1999; Bencur et al., 2005). In fact, the N-glycans of 4-Gal-T-expressing plants were found to be less xylosylated and especially less fucosylated (Palacpac et al., 1999; Fujiyama et al., 2001; Misaki et al., 2003). However, while the idea of converting all N-glycans into dian-tennary digalactosylated structures by the recombinant (human) 4-Gal-T is elegant, the results are disappointing. Either, the amount of “humanized” glycans was low (Bakker et al., 2001), and then the “bad” transferases had not been inhibited effectively (Fig. 15.7), or the glycan processing was disturbed such that it gave rise to hybrid-type glycans in unexpected ways, with, however, reduced amounts of immunogenic sugars, especially of fucose (Fig. 15.7) (Palacpac et al., 1999; Fujiyama et al., 2001; Misaki et al., 2003; Bakker et al., 2006). Human-like galactosylation has also been performed in double knock-out strains of *Physcomitrella* (Gorr and Jost, 2005; Huether et al., 2005), and some progress was achieved in further glycoengineering in this promising expression host.

Much time has passed since the first report on the co-expression of 4-Gal-T (Bakker et al., 2001) was published, and attempts at a quantitative human-like galactosylation have still to be completed successfully.



**Fig. 15.7** Co-expression of mammalian Gal-transferase in plants: possible results of co-expression of mammalian  $\beta$ 1,4-galactosyl-transferase. The two branches show hypothetical extremes where the Gal-T activity in the Golgi is so high that it already interferes with mannosidase II (left branch "high"), or it

is too low to successfully compete with Fuc-T and Xyl-T on the one hand and to achieve complete galactosylation on the other hand. The dotted line depicts the result of an ideal level of expression together with optimal localization of the enzymes. This has, however, not yet been fully achieved.

An alternative to *in-vivo* galactosylation is the post-harvesting glyco-remodeling with  $\beta$ 1,4-Gal-T. This approach has already been performed on plant-derived antibodies (Raju et al., 2001; Bardor et al., 2003b), and even large-scale reactions are possible, as shown with human IgG (Warnock et al., 2005a). Although glyco-remodeling can even be extended to sialylation, it remains to be shown that such a process can be operated economically, and in competition with alternative (or actually classical) production systems (Borth et al., 2005).

### 15.5.3

#### Improving Antibodies by Glycoengineering

We now have summarized attempts to implement an authentic human-like glycosylation on plant-made proteins. Recent studies on antibodies, however, demonstrated that it is possible by glycoengineering to generate drugs which are not only equivalent but even superior to the natural version in terms of their pharmacological efficiency (Elliott et al., 2003). The N-glycans in the Fc region of IgG are of no relevance to antigen binding. However, their presence is required for the antibody effector functions, namely antibody-dependent cellular cytotoxicity (ADCC), and complement-dependent cytotoxicity (CDC) (Jefferis et al., 1998, Mimura et al., 2001; Jefferis, 2005). ADCC depends on the interaction of the Fc-part of antibodies with Fc $\gamma$  receptors, especially Fc $\gamma$ RIII. The interaction of the antibody with Fc $\gamma$ RIII was found to be increased in the absence of the core fucose (Umana et al., 1999;



Shields et al., 2002; Shinkawa et al., 2003; Schuster et al., 2005). In mammalian cells, underfucosylation is achieved indirectly by overexpression of a NOGO signal – that is, GlcNAc transferase III (Umana et al., 1999), a strategy which can lead to a tenfold increase in efficacy (Schuster et al., 2005). Alternatively, silencing or knock-out of the *FUT8* gene in CHO proved useful to produce improved non-fucosylated antibodies (Mori et al., 2004; Yamane-Ohnuki et al., 2004). Plants *a priori* do not add a core  $\alpha$ 1,6-fucose to N-glycans, and therefore a transgenic plant host system devoid of the immunogenic 3-fucosylation such as *Physcomitrella* could be a suitable expression platform for glyco-optimized antibodies.

The advantages of a more efficient antibody, for example in tumor treatment, are twofold (Elliott et al., 2003; Schuster et al., 2005). First, the antibody dose required to achieve a certain clinical effect can be lowered, thereby evading adverse reactions caused by the foreign protein. Second, at the original dose, the panel of cells attacked and eliminated due to the antibody will also include cells with a lower antigen density on their surface (Schuster et al., 2005).

Of course, these thoughts do not necessarily relate to plants, but a recent study – which showed a 40-fold lytic activity related to improved ADCC – indicated that the above-mentioned moss *Physcomitrella patens* may be a promising host in the hunt for efficient, glyco-optimized biopharmaceuticals such as antibodies (M. Schuster et al., unpublished results).

## 15.6

### Trust is Good, Control is Better: A Structural Analysis

Glycoproteins in general and tetrameric glycoproteins such as antibodies of the IgG class are very complex entities, and the structure of the (heterogeneous) N-glycans is only one of the aspects of the primary structure which must be controlled. For the sake of brevity, only glycosylation analysis shall be considered here. One possible approach is the use of lectins, which has its merits in special cases but it is near to impossible to obtain a complete qualitative and quantitative profile of the structures present. Lectin arrays in conjunction with sophisticated data evaluation may, however, be a useful tool to measure quantitative changes within a defined glycosylation pattern ([www.procognia.com](http://www.procognia.com)). The other two approaches both start with the release of the glycans by peptide:N-glycosidase or anhydrous hydrazine (Harvey, 2005). The usually employed N-glycosidase F (PNGase F) can act on whole proteins, often without any denaturation. However, PNGase F is not able to release core- $\alpha$ 1,3-fucosylated glycans (Tretter et al., 1991). Therefore, plant glycoproteins, as well as those from protostomia and “lower” animals, shall be treated with N-glycosidase A (glycoamidase A, PNGase A) from almonds. This enzyme, however, exhibits a generally poor activity towards whole proteins, denatured or not (Tarentino and Plummer, 1982). Although exceptions to this rule can be found, it is advisory to employ PNGase A only after a proteolytic digest of the substrate protein (Kolarich and Altmann, 2000). We will neither discuss here the need nor the various methods for purification/isolation of the released sugar chains (Har-



vey, 2005; Kolarich and Altmann, 2000; Kuster et al., 2001; Wheeler and Harvey, 2001), but only the principal methods of oligosaccharide analysis.

The free glycans can be analyzed by mass spectrometry (MS), by high pH anion exchange HPLC or – after derivatization with a fluorophore – by regular HPLC or electrophoresis.

Mass spectrometric analysis is often performed using matrix-assisted laser-desorption time-of-flight instruments (MALDI-TOF) (Guile et al., 1996; Kolarich and Altmann, 2000; Bardor et al., 2003b; Koprivova et al., 2004; Strasser et al., 2004b; Harvey, 2005; Sagi et al., 2005). Apart from the unmatched speed of this method, it yields unequivocal information about the composition of the glycans, though not about the actual structure. Therefore, a combination of mass spectrometry and HPLC plus successive digestion with glycosidases or NMR spectroscopy is needed to fully define the glycosylation pattern on a glycoprotein. However, once this has been achieved for a particular protein from a particular host system, MALDI-TOF spectra appear adequate to monitor the glycosylation profile. For example, an N-glycan from a plant source with the composition  $\text{GlcNAc}_4\text{Man}_3\text{XylFuc}$  can be assigned the structure called  $\text{GnGnXF}^3$  (see Fig. 15.3), whereas a deoxyhexose on an IgG produced in a mammalian system can safely be assumed to be  $\alpha$ 1,6-linked to the innermost GlcNAc. However, with structures becoming more complex additional information is needed.

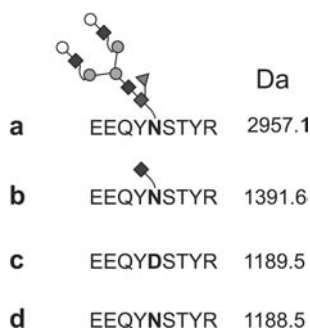
High pH anion-exchange HPLC (HPAEC HPLC) (Hermentin et al., 1992) requires specialized equipment, and today has been largely superseded by HPLC methods where a chromo- or fluorophore is attached to the oligosaccharide by reductive amination (Bigge et al., 1995; Natsuka and Hase, 1998). Other chemistries (e.g., reaction with 1-phenyl-3-methyl-5-pyrazolone; PMP) have remained less popular, probably due to the name of the reagent (Ethier et al., 2002). Despite the derivatization step, these methods are by far easier to implement and also offer the advantage that they can be coupled (online or not) to mass spectrometry. The “japanese” fluorophore 2-aminopyridine is suitable for normal-phase as well as reversed-phase HPLC (Hase, 1993; Takahashi, 1996), whereas the “anglo-american” 2-aminobenzamide is mostly used only with normal-phase HPLC (NP-HPLC) (Guile et al., 1996; Royle et al., 2002; Tekoah et al., 2004). NP-HPLC separates according to size but provides enough structural selectivity to discriminate, for example, the isomers of the mono-galactosylated N-glycans in IgG (Guile et al., 1996). Great promise lies in the high resolution obtained by capillary electrophoresis of fluorophore-labeled glycans (Callewaert et al., 2004), whereas slab gel-based applications (e.g., the FACE<sup>®</sup> system from Prozyme/Glyco, San Leandro, CA, USA) are easily implemented but probably less efficient in terms of resolution and identification power (Jackson, 1996). All of the methods employing fluorophores offer reliable molar quantitation of the glycan species. An interesting comparison of methods for the evaluation of IgG glycosylation was recently provided (Routier et al., 1998). Their inherent disadvantage lies in the restricted information content of the sole identification criterion retention time. Exoglycosidases can be used to corroborate assignments, making the analysis a tedious undertaking due to the repeated HPLC runs. The same applies to two- or three-dimensional HPLC as practiced with 2-aminopy-

ridine-labeled glycans. It can therefore be expected that combinations of liquid chromatography with mass spectrometry will play an important role in glycoprotein analysis.

One approach in this direction makes use of tryptic peptides which are subjected to HPLC coupled with electrospray ionization (ESI) and a mass spectrometer with high resolution and precision such as Q-TOF type instruments. In most cases – notably in that of the human IgG constant region – the glycopeptide(s) give good signals which can be interpreted similarly as MALDI-TOF MS data (J. Stadlmann, D. Kolarich, and F. Altmann, unpublished results; Hodoniczky et al., 2005; Karnoup et al., 2005; Kolarich et al., 2005, 2006a,b). As with MS of released sugars, the glycopeptide MS approach cannot resolve isobaric structures, but it has several advantages:

- It is less laborious than the enzyme array/NP-HPLC approach.
- It delivers a far more explicit information about the glycans, since glycan mass can be translated into composition.
- It provides site-specific information about glycan structures (in contrast to MALDI MS).
- It reveals underglycosylation, deglycosylation and cleavage by endo-*N*-acetylglucosaminidase – that is, by modifications which are overlooked by MALDI MS or HPLC of free glycans (Fig. 15.8).
- It delivers a plethora of data about the protein, for example about the integrity of N- and C-termini.

To conclude, there is considerable motion in the area of glycoprotein analysis, and the method applied is determined by the question and by the availability of instrumentation.



**Fig. 15.8** Glycosylation status of the IgG heavy chain. (a) An example of a normally glycosylated tryptic glycopeptide from human IgG<sub>1</sub>. (b) The result of endo- $\beta$ -*N*-acetylglucosaminidase action on a non-fucosylated N-glycan (E. Stöger and J. Stadlmann, unpublished results). (c) The glycopeptide containing an

aspartic acid instead of the asparagine which would result from the action of peptide:N-glycosidase on a formerly glycosylated peptide. (d) The truly unglycosylated peptide. Modifications b to d cannot be revealed by methods analyzing the glycan moiety alone, but only by mass spectrometry of (glyco-)peptides.

## 15.7

## Conclusions and Outlook

Plants are recognized as promising hosts for the production of biopharmaceuticals, especially in terms of safety and economy (Ma et al., 2005a). In the past, some major limitations of plants for the production of glycosylated biopharmaceuticals have been based on a few differences in the N-glycan pattern between plants and humans. Some of these differences, such as fucose and xylose residues attached to the core structure, are considered to comprise immunogenic potential, while others such as sialylation may influence the pharmacokinetics and activity of a given protein. The recently achieved successes regarding the humanization of N-glycans in plants creates much opportunity for the production of glycosylated biopharmaceuticals. Moreover, glycoengineering in plants also represents a promising tool for product optimization. In the future, products will not be limited to antibodies which, nonetheless, constitute the economically most interesting group of biopharmaceuticals.

## References

- Aalberse, R.C., van Ree, R. Cross-reactive carbohydrate determinants. *Monogr. Allergy* **1996**, *32*, 78–83.
- Abranches, R., Marcel, S., Arcalis, E., Altmann, F., Fevereiro, P., Stoger, E. Plants as bioreactors: A comparative study suggests that *Medicago truncatula* is a promising production system. *J. Biotechnol.* **2005**, *120*, 121–134.
- Akiyama, Y., Mori, M., Kato, K. 13C-NMR analysis of hydroxyproline arabinoside from *Nicotiana tabacum*. *Agric. Biol. Chem.* **1980**, *44*, 2487–2489.
- Allen, A.K., Desai, N.N., Neuberger, A., Creeth, J.M. Properties of potato lectin and the nature of its glycoprotein linkages. *Biochem. J.* **1978**, *171*, 665–674.
- Alonso, J.M., Stepanova, A.N., Leisse, T.J., Kim, C.J., Chen, H., Shinn, P., Stevenson, D.K., Zimmerman, J., Barajas, P., Cheuk, R., Gadrinab, C., Heller, C., Jeske, A., Koesema, E., Meyers, C.C., Parker, H., Prednis, L., Ansari, Y., Choy, N., Deen, H., Geralt, M., Hazari, N., Hom, E., Karnes, M., Mulholland, C., Ndubaku, R., Schmidt, I., Guzman, P., Aguilar-Henonin, L., Schmid, M., Weigel, D., Carter, D.E., Marchand, T., Risseuw, E., Brogden, D., Zeko, A., Crosby, W.L., Berry, C.C., Ecker, J.R. Genome-wide insertional mutagenesis of *Arabidopsis thaliana*. *Science* **2003**, *301*, 653–657.
- Altmann, F., Staudacher, E., Wilson, I.B., Marz, L. Insect cells as hosts for the expression of recombinant glycoproteins. *Glycoconj. J.* **1999**, *16*, 109–123.
- Ashford, D., Desai, N.N., Allen, A.K., Neuberger, A., O'Neill, M.A., Selvendran, R.R. Structural studies of the carbohydrate moieties of lectins from potato (*Solanum tuberosum*) tubers and thorn-apple (*Datura stramonium*) seeds. *Biochem. J.* **1982**, *201*, 199–208.
- Ashford, D.A., Dwek, R.A., Rademacher, T.W., Lis, H., Sharon, N. The glycosylation of glycoprotein lectins. Intra- and inter-genus variation in N-linked oligosaccharide expression. *Carbohydr. Res.* **1991**, *213*, 215–227.
- Bacic, A., Churms, S.C., Stephen, A.M., Cohen, P.B., Fincher, G.B. Fine structure of the arabinogalactan-protein from *Lolium multiflorum*. *Carbohydr. Res.* **1987**, *162*, 85–93.
- Bakker, H., Bardor, M., Molthoff, J.W., Gomord, V., Elbers, I., Stevens, L.H., Jordi, W., Lommen, A., Faye, L., Lerouge, P., Bosch, D. Galactose-extended glycans

- of antibodies produced by transgenic plants. *Proc. Natl. Acad. Sci. USA* **2001**, *98*, 2899–2904.
- Bakker, H., Rouwendal, G.J.A., Karnoup, A.S., Florack, D.E.A., Stoop, G.M., Helsper, J.P.F., van Ree, R., van Die, I., Bosch, D. An antibody produced in tobacco expressing a hybrid beta1,4-galactosyltransferase is essentially devoid of plant carbohydrate epitopes. *Proc. Natl. Acad. Sci. USA* **2006**, *103*, 7577–7582.
- Bardor, M., Faye, L., Lerouge, P. Analysis of the N-glycosylation of recombinant glycoproteins produced in transgenic plants. *Trends Plant Sci.* **1999**, *4*, 376–380.
- Bardor, M., Faveeuw, C., Fitchette, A.C., Gilbert, D., Galas, L., Trottein, F., Faye, L., Lerouge, P. Immunoreactivity in mammals of two typical plant glyco-epitopes, core alpha(1,3)-fucose and core xylose. *Glycobiology* **2003a**, *13*, 427–434.
- Bardor, M., Loutelier-Bourhis, C., Paccalet, T., Cosette, P., Fitchette, A.C., Vezina, L.P., Trepanier, S., Dargis, M., Lemieux, R., Lange, C., Faye, L., Lerouge, P. Monoclonal C5-1 antibody produced in transgenic alfalfa plants exhibits a N-glycosylation that is homogenous and suitable for glyco-engineering into human-compatible structures. *Plant Biotechnol. J.* **2003b**, *1*, 451–462.
- Bencur, P., Steinkellner, H., Svoboda, B., Mucha, J., Strasser, R., Kolarich, D., Hann, S., Kollensperger, G., Glossl, J., Altmann, F., Mach, L. *Arabidopsis thaliana* beta1,2-xylosyltransferase: an unusual glycosyltransferase with the potential to act at multiple stages of the plant N-glycosylation pathway. *Biochem. J.* **2005**, *388*, 515–525.
- Bencurova, M., Hemmer, W., Focke-Tejkl, M., Wilson, I.B., Altmann, F. Specificity of IgG and IgE antibodies against plant and insect glycoprotein glycans determined with artificial glycoforms of human transferrin. *Glycobiology* **2004**, *14*, 457–466.
- Bigge, J.C., Patel, T.P., Bruce, J.A., Goulding, P.N., Charles, S.M., Parekh, R.B. Non-selective and efficient fluorescent labeling of glycans using 2-amino benzamide and anthranilic acid. *Anal. Biochem.* **1995**, *230*, 229–238.
- Borth, N., Mattanovich, D., Kunert, R., Katinger, H. Effect of increased expression of protein disulfide isomerase and heavy chain binding protein on antibody secretion in a recombinant CHO cell line. *Biotechnol. Prog.* **2005**, *21*, 106–111.
- Bosch, M., Knudsen, J.S., Derksen, J., Mariani, C. Class III pistil-specific extensin-like proteins from tobacco have characteristics of arabinogalactan proteins. *Plant Physiol.* **2001**, *125*, 2180–2188.
- Brockhausen, I., Vavasseur, F., Yang, X. Biosynthesis of mucin type O-glycans: lack of correlation between glycosyltransferase and sulfotransferase activities and CFTR expression. *Glycoconj. J.* **2001**, *18*, 685–697.
- Callewaert, N., Contreras, R., Mitnik-Gankin, L., Carey, L., Matsudaira, P., Ehrlich, D. Total serum protein N-glycome profiling on a capillary electrophoresis-microfluidics platform. *Electrophoresis* **2004**, *25*, 3128–3131.
- Caramelo, J.J., Castro, O.A., Alonso, L.G., De Prat-Gay, G., Parodi, A.J. UDP-Glc:glycoprotein glucosyltransferase recognizes structured and solvent accessible hydrophobic patches in molten globule-like folding intermediates. *Proc. Natl. Acad. Sci. USA* **2003**, *100*, 86–91.
- Caramelo, J.J., Castro, O.A., de Prat-Gay, G., Parodi, A.J. The endoplasmic reticulum glucosyltransferase recognizes nearly native glycoprotein folding intermediates. *J. Biol. Chem.* **2004**, *279*, 46280–46285.
- Chargelegue, D., Vine, N.D., van Dolleweerd, C.J., Drake, P.M., Ma, J.K. A murine monoclonal antibody produced in transgenic plants with plant-specific glycans is not immunogenic in mice. *Transgenic Res.* **2000**, *9*, 187–194.
- Cho, Y.-O., Chrispeels, M.J. Serine-O-galactosyl linkages in glycoproteins from carrot cell walls. *Phytochemistry* **1976**, *15*, 165–169.
- Classen, B., Witthohn, K., Blaschek, W. Characterization of an arabinogalactan-protein isolated from pressed juice of *Echinacea purpurea* by precipitation with the beta-glucosyl Yariv reagent. *Carbohydr. Res.* **2000**, *327*, 497–504.
- Decker, E.L., Reski, R. The moss bioreactor. *Curr. Opin. Plant Biol.* **2004**, *7*, 166–170.
- Dirnberger, D., Steinkellner, H., Abdennebi, L., Remy, J.J., van de Wiel, D. Secretion of biologically active glycoforms of bovine follicle stimulating hormone in plants. *Eur. J. Biochem.* **2001**, *268*, 4570–4579.

- Dong, X., Storkus, W.J., Salter, R.D. Binding and uptake of agalactosyl IgG by mannose receptor on macrophages and dendritic cells. *J. Immunol.* **1999**, *163*, 5427–5434.
- Elbers, I.J., Stoopen, G.M., Bakker, H., Stevens, L.H., Bardor, M., Molthoff, J.W., Jordi, W.J., Bosch, D., Lommen, A. Influence of growth conditions and developmental stage on N-glycan heterogeneity of transgenic immunoglobulin G and endogenous proteins in tobacco leaves. *Plant Physiol.* **2001**, *126*, 1314–1322.
- Ellgaard, L., Helenius, A. Quality control in the endoplasmic reticulum. *Nat. Rev. Mol. Cell. Biol.* **2003**, *4*, 181–191.
- Elliott, S., Lorenzini, T., Asher, S., Aoki, K., Brankow, D., Buck, L., Busse, L., Chang, D., Fuller, J., Grant, J., Hernday, N., Hokum, M., Hu, S., Knudten, A., Levin, N., Komorowski, R., Martin, F., Navarro, R., Osslund, T., Rogers, G., Rogers, N., Trail, G., Egrie, J. Enhancement of therapeutic protein in vivo activities through glycoengineering. *Nat. Biotechnol.* **2003**, *21*, 414–421.
- Ethier, M., Saba, J.A., Ens, W., Standing, K.G., Perreault, H. Automated structural assignment of derivatized complex N-linked oligosaccharides from tandem mass spectra. *Rapid Commun. Mass Spectrom.* **2002**, *16*, 1743–1754.
- Faye, L., Gomord, V., Fitchette-Laine, A.C., Chrispeels, M.J. Affinity purification of antibodies specific for Asn-linked glycans containing alpha 1→3 fucose or beta 1→2 xylose. *Anal. Biochem.* **1993**, *209*, 104–108.
- Faye, L., Boulaflous, A., Benchabane, M., Gomord, V., Michaud, D. Protein modifications in the plant secretory pathway: current status and practical implications in molecular pharming. *Vaccine* **2005**, *23*, 1770–1778.
- Fincher, G.B., Sawyer, W.H., Stone, B.A. Chemical and physical properties of an arabinogalactan-peptide from wheat endosperm. *Biochem. J.* **1974**, *139*, 535–545.
- Fitchette-Laine, A.C., Gomord, V., Cabanes, M., Michalski, J.C., Saint Macary, M., Foucher, B., Cavelier, B., Hawes, C., Lerouge, P., Faye, L. N-glycans harboring the Lewis a epitope are expressed at the surface of plant cells. *Plant J.* **1997**, *12*, 1411–1417.
- Fournet, B., Leroy, Y., Wieruszkeski, J.M., Montreuil, J., Poretz, R.D., Goldberg, R. Primary structure of an N-glycosidic carbohydrate unit derived from *Sophora japonica* lectin. *Eur. J. Biochem.* **1987**, *166*, 321–324.
- Fujijama, K., Palacpac, N.Q., Sakai, H., Kimura, Y., Shinmyo, A., Yoshida, T., Seki, T. In vivo conversion of a glycan to human compatible type by transfected tobacco cells. *Biochem. Biophys. Res. Commun.* **2001**, *289*, 553–557.
- Gane, A.M., Craik, D., Munro, S.L., Howlett, G.J., Clarke, A.E., Bacic, A. Structural analysis of the carbohydrate moiety of arabinogalactan-proteins from stigmas and styles of *Nicotiana glauca*. *Carbohydr. Res.* **1995**, *277*, 67–85.
- Girke, T., Schmidt, H., Zahringer, U., Reski, R., Heinz, E. Identification of a novel delta 6-acyl-group desaturase by targeted gene disruption in *Physcomitrella patens*. *Plant J.* **1998**, *15*, 39–48.
- Gomord, V., Faye, L. Posttranslational modification of therapeutic proteins in plants. *Curr. Opin. Plant Biol.* **2004**, *7*, 171–181.
- Gomord, V., Denmat, L.A., Fitchette-Laine, A.C., Satiat-Jeunemaitre, B., Hawes, C., Faye, L. The C-terminal HDEL sequence is sufficient for retention of secretory proteins in the endoplasmic reticulum (ER) but promotes vacuolar targeting of proteins that escape the ER. *Plant J.* **1997**, *11*, 313–325.
- Gomord, V., Chamberlain, P., Jefferis, R., Faye, L. Biopharmaceutical production in plants: problems, solutions and opportunities. *Trends Biotechnol.* **2005**, *23*, 559–565.
- Goodrum, L.J., Patel, A., Leykam, J.F., Kieliszewski, M.J. Gum arabic glycoprotein contains glycomodules of both extensin and arabinogalactan-glycoproteins. *Phytochemistry* **2000**, *54*, 99–106.
- Gorr, G., Jost, W. Glycosylation design in transgenic moss for better product efficacy. *Bioprocess. J.* **2005**, *4*, 26–30.
- Gorr, G., Wagner, S. Humanised glycosylation – production of biopharmaceuticals in a moss bioreactor. In: Knaeblein, J. (Ed.), *Modern biopharmaceuticals – Design, development and optimisation*. Wiley-VCH, **2005**, pp. 919–929.

- Guile, G.R., Rudd, P.M., Wing, D.R., Prime, S.B., Dwek, R.A. A rapid high-resolution high-performance liquid chromatographic method for separating glycan mixtures and analyzing oligosaccharide profiles. *Anal. Biochem.* **1996**, *240*, 210–226.
- Gutternigg, M., Ahrer, K., Grabher-Meier, H., Burgmayr, S., Staudacher, E. Neutral N-glycans of the gastropod *Arion lusitanicus*. *Eur. J. Biochem.* **2004**, *271*, 1348–1356.
- Harvey, D.J. Structural determination of N-linked glycans by matrix-assisted laser desorption/ionization and electrospray ionization mass spectrometry. *Proteomics* **2005**, *5*, 1774–1786.
- Hase, S. Analysis of sugar chains by pyridylation. *Methods Mol. Biol.* **1993**, *14*, 69–80.
- Helenius, A., Aebi, M. Intracellular functions of N-linked glycans. *Science* **2001**, *291*, 2364–2369.
- Hemmer, W., Focke, M., Kolarich, D., Wilson, I.B., Altmann, F., Wohrl, S., Gotz, M., Jarisch, R. Antibody binding to venom carbohydrates is a frequent cause for double positivity to honeybee and yellow jacket venom in patients with stinging-insect allergy. *J. Allergy Clin. Immunol.* **2001**, *108*, 1045–1052.
- Hermentin, P., Witzel, R., Doenges, R., Bauer, R., Haupt, H., Patel, T., Parekh, R.B., Brazel, D. The mapping by high-pH anion-exchange chromatography with pulsed amperometric detection and capillary electrophoresis of the carbohydrate moieties of human plasma alpha 1-acid glycoprotein. *Anal. Biochem.* **1992**, *206*, 419–429.
- Hodoniczky, J., Zheng, Y.Z., James, D.C. Control of recombinant monoclonal antibody effector functions by Fc N-glycan remodeling in vitro. *Biotechnol. Prog.* **2005**, *21*, 1644–1652.
- Huether, C.M., Lienhart, O., Baur, A., Stemmer, C., Gorr, G., Reski, R., Decker, E.L. Glyco-engineering of moss lacking plant-specific sugar residues. *Plant Biol. (Stuttg.)* **2005**, *7*, 292–299.
- Ichihara, T., Sakamoto, J., Nakao, A., Furukawa, K., Watanabe, T., Suzuki, N., Horisawa, M., Nagura, H., Lloyd, K.O., Takagi, H. Expression of blood group-related antigens in normal and malignant pancreatic tissue correlated with genotype of the patient defined by saliva glycoprotein. *Cancer* **1993**, *71*, 71–81.
- Jackson, P. The analysis of fluorophore-labeled carbohydrates by polyacrylamide gel electrophoresis. *Mol. Biotechnol.* **1996**, *5*, 101–123.
- Jefferis, R. Glycosylation of recombinant antibody therapeutics. *Biotechnol. Prog.* **2005**, *21*, 11–16.
- Jefferis, R., Lund, J., Pound, J.D. IgG-Fc-mediated effector functions: molecular definition of interaction sites for effector ligands and the role of glycosylation. *Immunol. Rev.* **1998**, *163*, 59–76.
- Jin, C., Bencurova, M., Borth, N., Ferko, B., Altmann, F., Hantusch, B. Immunoglobulin G specifically binding plant N-glycans with high affinity could be generated in rabbits but not in mice. *Glycobiology* **2006**, *16*, 349–357.
- Kannagi, R., Izawa, M., Koike, T., Miyazaki, K., Kimura, N. Carbohydrate-mediated cell adhesion in cancer metastasis and angiogenesis. *Cancer Sci.* **2004**, *95*, 377–384.
- Karnoup, A.S., Turkelson, V., Anderson, W.H. O-linked glycosylation in maize-expressed human IgA1. *Glycobiology* **2005**, *15*, 965–981.
- Kieliszewski, M.J. The latest hype on Hyp-O-glycosylation codes. *Phytochemistry* **2001**, *57*, 319–323.
- Kieliszewski, M.J., Shpak, E. Synthetic genes for the elucidation of glycosylation codes for arabinogalactan-proteins and other hydroxyproline-rich glycoproteins. *Cell. Mol. Life Sci.* **2001**, *58*, 1386–1398.
- Kim, L.S., Waters, R.F., Burkholder, P.M. Immunological activity of larch arabinogalactan and Echinacea: a preliminary, randomized, double-blind, placebo-controlled trial. *Altern. Med. Rev.* **2002**, *7*, 138–149.
- Kishimoto, T., Watanabe, M., Mitsui, T., Hori, H. Glutelin basic subunits have a mammalian mucin-type O-linked disaccharide side chain. *Arch. Biochem. Biophys.* **1999**, *370*, 271–277.
- Knaeblein, J. Biopharmaceuticals expressed in plants. In: Kayser, O., Müller, R.H. (Eds.), *Pharmaceutical Biotechnology – Drug discovery and clinical applications*. Wiley-VCH, Heidelberg, **2004**, pp. 35–56.

- Ko, K., Tekoah, Y., Rudd, P.M., Harvey, D.J., Dwek, R.A., Spitsin, S., Hanlon, C.A., Rupprecht, C., Dietzschold, B., Golovkin, M., Koprowski, H. Function and glycosylation of plant-derived antiviral monoclonal antibody. *Proc. Natl. Acad. Sci. USA* **2003**, *100*, 8013–8018.
- Kobata, A. Structures and functions of the sugar chains of glycoproteins. *Eur. J. Biochem.* **1992**, *209*, 483–501.
- Kolarich, D., Altmann, F. N-Glycan analysis by matrix-assisted laser desorption/ionization mass spectrometry of electrophoretically separated nonmammalian proteins: application to peanut allergen Ara h 1 and olive pollen allergen Ole e 1. *Anal. Biochem.* **2000**, *285*, 64–75.
- Kolarich, D., Leonard, R., Hemmer, W., Altmann, F. The N-glycans of yellow jacket venom hyaluronidases and the protein sequence of its major isoform in *Vespula vulgaris*. *FEBS J.* **2005**, *272*, 5182–5190.
- Kolarich, D., Sunderesan, E., Altmann, F. Structural analysis of the glycoprotein allergen Hev b 4 from natural rubber latex by mass spectrometry. *Biochim. Biophys. Acta* **2006a**, *1760*, 715–720.
- Kolarich, D., Weber, A., Turecek, P., Schwarz, H.P., Altmann, F. Comprehensive glyco-proteomic analysis of human a1 antitrypsin and its charge isoforms. *Proteomics* **2006b**, *6*, 3369–3380.
- Koprivova, A., Meyer, A.J., Schween, G., Herschbach, C., Reski, R., Kopriva, S. Functional knockout of the adenosine 5'-phosphosulfate reductase gene in *Physcomitrella patens* revives an old route of sulfate assimilation. *J. Biol. Chem.* **2002**, *277*, 32195–32201.
- Koprivova, A., Altmann, F., Gorr, G., Kopriva, S., Reski, R., Decker, E.L. N-glycosylation in the moss *Physcomitrella patens* is organized similarly to that in higher plants. *Plant Biol.* **2003**, *5*, 582–591.
- Koprivova, A., Stemmer, C., Altmann, F., Hoffmann, A., Kopriva, S., Gorr, G., Reski, R., Decker, E.L. Targeted knockouts of *Physcomitrella* lacking plant specific immunogenic N-glycans. *Plant Biotechnol. J.* **2004**, *2*, 517–523.
- Kubelka, V., Altmann, F., Staudacher, E., Treter, V., Marz, L., Hard, K., Kamerling, J.P., Vliegthart, J.F. Primary structures of the N-linked carbohydrate chains from honeybee venom phospholipase A2. *Eur. J. Biochem.* **1993**, *213*, 1193–1204.
- Kurosaka, A., Yano, A., Itoh, N., Kuroda, Y., Nakagawa, T., Kawasaki, T. The structure of a neural specific carbohydrate epitope of horseradish peroxidase recognized by anti-horseradish peroxidase antiserum. *J. Biol. Chem.* **1991**, *266*, 4168–4172.
- Kuster, B., Krogh, T.N., Mortz, E., Harvey, D.J. Glycosylation analysis of gel-separated proteins. *Proteomics* **2001**, *1*, 350–361.
- Laine, A.C., Faye, L. Significant immunological cross-reactivity of plant glycoproteins. *Electrophoresis* **1988**, *9*, 841–844.
- Lampert, D.T., Katona, L., Roerig, S. Galactosylserine in extensin. *Biochem. J.* **1973**, *133*, 125–132.
- Lauriere, M., Lauriere, C., Chrispeels, M.J., Johnson, K.D., Sturm, A. Characterization of a xylose-specific antiserum that reacts with the complex asparagine-linked glycans of extracellular and vacuolar glycoproteins. *Plant Physiol.* **1989**, *90*, 1182–1188.
- Leiter, H., Mucha, J., Staudacher, E., Grimm, R., Glossl, J., Altmann, F. Purification, cDNA cloning, and expression of GDP-L-Fuc:Asn-linked GlcNAc alpha1,3-fucosyltransferase from mung beans. *J. Biol. Chem.* **1999**, *274*, 21830–21839.
- Leonard, R., Kolarich, D., Paschinger, K., Altmann, F., Wilson, I.B. A genetic and structural analysis of the N-glycosylation capabilities. *Plant Mol. Biol.* **2004**, *55*, 631–644.
- Leonard, R., Petersen, B.O., Himly, M., Kaar, W., Wopfner, N., Kolarich, D., van Ree, R., Ebner, C., Duus, J.O., Ferreira, F., Altmann, F. Two novel types of O-glycans on the mugwort pollen allergen Art v 1 and their role in antibody binding. *J. Biol. Chem.* **2005**, *280*, 7932–7940.
- Leonard, R., Rendic, D., Rabouille, C., Wilson, I.B., Preat, T., Altmann, F. The *Drosophila* fused lobes gene encodes an N-acetylglucosaminidase involved in N-glycan processing. *J. Biol. Chem.* **2006**, *281*, 4867–4875.
- Lerouge, P., Cabanes-Macheteau, M., Rayon, C., Fischette-Laine, A.C., Gomord, V., Faye, L. N-glycoprotein biosynthesis in plants: recent developments and future trends. *Plant Mol. Biol.* **1998**, *38*, 31–48.



- Lerouge, P., Bardor, M., Pagny, S., Gomord, V., Faye, L. N-glycosylation of recombinant pharmaceutical glycoproteins produced in transgenic plants: towards a humanisation of plant N-glycans. *Curr. Pharm. Biotechnol.* **2000**, *1*, 347–354.
- Lerouxel, O., Mouille, G., Andeme-Onzighi, C., Bruyant, M.P., Seveno, M., Loutelier-Bourhis, C., Driouich, A., Hofte, H., Lerouge, P. Mutants in DEFECTIVE GLYCOSYLATION, an *Arabidopsis* homolog of an oligosaccharyltransferase complex subunit, show protein underglycosylation and defects in cell differentiation and growth. *Plant J.* **2005**, *42*, 455–468.
- Ma, J.K., Hiatt, A., Hein, M., Vine, N.D., Wang, F., Stabila, P., van Dolleweerd, C., Mostov, K., Lehner, T. Generation and assembly of secretory antibodies in plants. *Science* **1995**, *268*, 716–719.
- Ma, J.K., Drake, P.M., Christou, P. The production of recombinant pharmaceutical proteins in plants. *Nat. Rev. Genet.* **2003**, *4*, 794–805.
- Ma, J.K., Barros, E., Bock, R., Christou, P., Dale, P.J., Dix, P.J., Fischer, R., Irwin, J., Mahoney, R., Pezzotti, M., Schillberg, S., Sparrow, P., Stoger, E., Twyman, R.M. Molecular farming for new drugs and vaccines. Current perspectives on the production of pharmaceuticals in transgenic plants. *EMBO Rep.* **2005a**, *6*, 593–599.
- Ma, J.K., Drake, P.M., Chargelegue, D., Obregon, P., Prada, A. Antibody processing and engineering in plants, and new strategies for vaccine production. *Vaccine* **2005b**, *23*, 1814–1818.
- Mari, A. IgE to cross-reactive carbohydrate determinants: analysis of the distribution and appraisal of the in vivo and in vitro reactivity. *Int. Arch. Allergy Immunol.* **2002**, *129*, 286–295.
- Melo, N.S., Nimtz, M., Conradt, H.S., Fevereiro, P.S., Costa, J. Identification of the human Lewis(a) carbohydrate motif in a secretory peroxidase from a plant cell suspension culture (*Vaccinium myrtillus* L.). *FEBS Lett.* **1997**, *415*, 186–191.
- Mimura, Y., Sondermann, P., Ghirlando, R., Lund, J., Young, S.P., Goodall, M., Jefferis, R. Role of oligosaccharide residues of IgG1-Fc in Fc gamma RIIb binding. *J. Biol. Chem.* **2001**, *276*, 45 539–45 547.
- Misaki, R., Kimura, Y., Palacpac, N.Q., Yoshida, S., Fujiyama, K., Seki, T. Plant cultured cells expressing human beta1,4-galactosyltransferase secrete glycoproteins with galactose-extended N-linked glycans. *Glycobiology* **2003**, *13*, 199–205.
- Mokrzycki-Issartel, N., Bouchon, B., Farrer, S., Berland, P., Laparra, H., Madelmont, J.C., Theisen, M. A transient tobacco expression system coupled to MALDI-TOF-MS allows validation of the impact of differential targeting on structure and activity of a recombinant therapeutic glycoprotein produced in plants. *FEBS Lett.* **2003**, *552*, 170–176.
- Mori, K., Kuni-Kamochi, R., Yamane-Ohnuki, N., Wakitani, M., Yamano, K., Imai, H., Kanda, Y., Niwa, R., Iida, S., Uchida, K., Shitara, K., Satoh, M. Engineering Chinese hamster ovary cells to maximize effector function of produced antibodies using FUT8 siRNA. *Biotechnol. Bioeng.* **2004**, *88*, 901–908.
- Mukhopadhyay, A., Stahl, P. Bee venom phospholipase A2 is recognized by the macrophage mannose receptor. *Arch. Biochem. Biophys.* **1995**, *324*, 78–84.
- Myllyharju, J. Prolyl 4-hydroxylases, the key enzymes of collagen biosynthesis. *Matrix Biol.* **2003**, *22*, 15–24.
- Natsuka, S., Hase, S. Analysis of N- and O-glycans by pyridylamination. *Methods Mol. Biol.* **1998**, *76*, 101–113.
- Ogawa, H., Hijikata, A., Amano, M., Kojima, K., Fukushima, H., Ishizuka, I., Kurihara, Y., Matsumoto, I. Structures and contribution to the antigenicity of oligosaccharides of Japanese cedar (*Cryptomeria japonica*) pollen allergen Cry j I: relationship between the structures and antigenic epitopes of plant N-linked complex-type glycans. *Glycoconj. J.* **1996**, *13*, 555–566.
- Olczak, M., Watorek, W. Structural analysis of N-glycans from yellow lupin (*Lupinus luteus*) seed diphosphonucleotide phosphatase/phosphodiesterase. *Biochim. Biophys. Acta* **2000**, *1523*, 236–245.
- Pagny, S., Cabanes-Macheteau, M., Gillikin, J.W., Leborgne-Castel, N., Lerouge, P., Boston, R.S., Faye, L., Gomord, V. Protein recycling from the Golgi apparatus to the endoplasmic reticulum in plants and its minor contribution to calreticulin retention. *Plant Cell* **2000**, *12*, 739–756.



- Pagny, S., Bouissonnie, F., Sarkar, M., Follet-Gueye, M.L., Driouich, A., Schachter, H., Faye, L., Gomord, V. Structural requirements for *Arabidopsis* beta1,2-xylosyltransferase activity and targeting to the Golgi. *Plant J.* **2003**, *33*, 189–203.
- Palacpac, N.Q., Yoshida, S., Sakai, H., Kimura, Y., Fujiyama, K., Yoshida, T., Seki, T. Stable expression of human beta1,4-galactosyltransferase in plant cells modifies N-linked glycosylation patterns. *Proc. Natl. Acad. Sci. USA* **1999**, *96*, 4692–4697.
- Parodi, A.J. Reglycosylation of glycoproteins and quality control of glycoprotein folding in the endoplasmic reticulum of yeast cells. *Biochim. Biophys. Acta* **1999**, *1426*, 287–295.
- Peumans, W.J., Van Damme, E.J. Plant lectins: specific tools for the identification, isolation, and characterization of O-linked glycans. *Crit. Rev. Biochem. Mol. Biol.* **1998**, *33*, 209–258.
- Prenner, C., Mach, L., Glossl, J., Marz, L. The antigenicity of the carbohydrate moiety of an insect glycoprotein, honey-bee (*Apis mellifera*) venom phospholipase A2. The role of alpha 1,3-fucosylation of the asparagine-bound N-acetylglucosamine. *Biochem. J.* **1992**, *284* (Pt 2), 377–380.
- Raju, T.S., Briggs, J.B., Chamow, S.M., Winkler, M.E., Jones, A.J. Glycoengineering of therapeutic glycoproteins: in vitro galactosylation and sialylation of glycoproteins with terminal N-acetylglucosamine and galactose residues. *Biochemistry* **2001**, *40*, 8868–8876.
- Ramirez-Soto, D., Poretz, R.D. The (1→3)-linked alpha-L-fucosyl group of the N-glycans of the *Wistaria floribunda* lectins is recognized by a rabbit anti-serum. *Carbohydr. Res.* **1991**, *213*, 27–36.
- Rayon, C., Cabanes-Macheteau, M., Loutelier-Bourhis, C., Salliot-Maire, I., Lemoine, J., Reiter, W.D., Lerouge, P., Faye, L. Characterization of N-glycans from *Arabidopsis*. Application to a fucose-deficient mutant. *Plant Physiol.* **1999**, *119*, 725–734.
- Routier, F.H., Hounsell, E.F., Rudd, P.M., Takahashi, N., Bond, A., Hay, F.C., Alavi, A., Axford, J.S., Jefferis, R. Quantitation of the oligosaccharides of human serum IgG from patients with rheumatoid arthritis: a critical evaluation of different methods. *J. Immunol. Methods* **1998**, *213*, 113–130.
- Royle, L., Mattu, T.S., Hart, E., Langridge, J.I., Merry, A.H., Murphy, N., Harvey, D.J., Dwek, R.A., Rudd, P.M. An analytical and structural database provides a strategy for sequencing O-glycans from microgram quantities of glycoproteins. *Anal. Biochem.* **2002**, *304*, 70–90.
- Sagi, D., Kienz, P., Denecke, J., Marquardt, T., Peter-Katalinic, J. Glycoproteomics of N-glycosylation by in-gel deglycosylation and matrix-assisted laser desorption/ionisation-time of flight mass spectrometry mapping: application to congenital disorders of glycosylation. *Proteomics* **2005**, *5*, 2689–2701.
- Sakamoto, J., Furukawa, K., Cordon-Cardo, C., Yin, B.W., Rettig, W.J., Oettgen, H.F., Old, L.J., Lloyd, K.O. Expression of Lewisx, Lewisy, and Y blood group antigens in human colonic tumors and normal tissue and in human tumor-derived cell lines. *Cancer Res.* **1986**, *46*, 1553–1561.
- Samyn-Petit, B., Gruber, V., Flahaut, C., Wajda-Dubos, J.P., Farrer, S., Pons, A., Desmaizieres, G., Slomianny, M.C., Theisen, M., Delannoy, P. N-glycosylation potential of maize: the human lactoferrin used as a model. *Glycoconj. J.* **2001**, *18*, 519–527.
- Saulnier, L., Brillouet, J.M., Moutounet, M., Herve du Penhoat, C., Michon, V. New investigations of the structure of grape arabinogalactan-protein. *Carbohydr. Res.* **1992**, *224*, 219–235.
- Schachter, H. The role of the GlcNAc(beta)-1,2Man(alpha)- moiety in mammalian development. Null mutations of the genes encoding UDP-N-acetylglucosamine:alpha-3-D-mannoside beta-1,2-N-acetylglucosaminyltransferase I and UDP-N-acetylglucosamine:alpha-D-mannoside beta-1,2-N-acetylglucosaminyltransferase I.2 cause embryonic lethality and congenital muscular dystrophy in mice and men, respectively. *Biochim. Biophys. Acta* **2002**, *1573*, 292–300.
- Schaffer, C., Graninger, M., Messner, P. Prokaryotic glycosylation. *Proteomics* **2001**, *1*, 248–261.
- Schouten, A., Roosien, J., van Engelen, F.A., de Jong, G.A., Borst-Vrensens, A.W.,

- Zilverentant, J.F., Bosch, D., Stiekema, W.J., Gommers, F.J., Schots, A., Bakker, J. The C-terminal KDEL sequence increases the expression level of a single-chain antibody designed to be targeted to both the cytosol and the secretory pathway in transgenic tobacco. *Plant Mol. Biol.* **1996**, *30*, 781–793.
- Schuster, M., Umama, P., Ferrara, C., Brunker, P., Gerdes, C., Waxenecker, G., Wiederkum, S., Schwager, C., Loibner, H., Himmler, G., Mudde, G.C. Improved effector functions of a therapeutic monoclonal Lewis Y-specific antibody by glycoform engineering. *Cancer Res.* **2005**, *65*, 7934–7941.
- Seveno, M., Bardor, M., Paccalet, T., Gomord, V., Lerouge, P., Faye, L. Glycoprotein sialylation in plants? *Nat. Biotechnol.* **2004**, *22*, 1351–1352; author reply 1352–1353.
- Shah, M.M., Fujiyama, K., Flynn, C.R., Joshi, L. Sialylated endogenous glycoconjugates in plant cells. *Nat. Biotechnol.* **2003**, *21*, 1470–1471.
- Shields, R.L., Lai, J., Keck, R., O'Connell, L.Y., Hong, K., Meng, Y.G., Weikert, S.H., Presta, L.G. Lack of fucose on human IgG1 N-linked oligosaccharide improves binding to human Fcγ<sub>3</sub>RIII and antibody-dependent cellular toxicity. *J. Biol. Chem.* **2002**, *277*, 26733–26740.
- Shinkawa, T., Nakamura, K., Yamane, N., Shoji-Hosaka, E., Kanda, Y., Sakurada, M., Uchida, K., Anazawa, H., Satoh, M., Yamasaki, M., Hanai, N., Shitara, K. The absence of fucose but not the presence of galactose or bisecting N-acetylglucosamine of human IgG1 complex-type oligosaccharides shows the critical role of enhancing antibody-dependent cellular cytotoxicity. *J. Biol. Chem.* **2003**, *278*, 3466–3473.
- Showalter, A.M. Arabinogalactan-proteins: structure, expression and function. *Cell. Mol. Life Sci.* **2001**, *58*, 1399–1417.
- Shpak, E., Barbar, E., Leykam, J.F., Kieliszewski, M.J. Contiguous hydroxyproline residues direct hydroxyproline arabinosylation in *Nicotiana tabacum*. *J. Biol. Chem.* **2001**, *276*, 11272–11278.
- Sonnenwald, U., Sturm, A., Chrispeels, M.J., Willmitzer, L. Targeting and glycosylation of patatin, the major tuber protein in leaves of transgenic tobacco. *Planta* **1989**, *179*, 171–180.
- Sriraman, R., Bardor, M., Sack, M., Vaquero, C., Faye, L., Fischer, R., Finnem, R., Lerouge, P. Recombinant anti-hCG antibodies retained in the endoplasmic reticulum of transformed plants lack core-xylose and core- $\alpha$ (1,3)-fucose residues. *Plant Biotechnol. J.* **2004**, *2*, 279–287.
- Stahl, B., Klabunde, T., Witzel, H., Krebs, B., Steup, M., Karas, M., Hillenkamp, F. The oligosaccharides of the Fe(III)-Zn(II) purple acid phosphatase of the red kidney bean. Determination of the structure by a combination of matrix-assisted laser desorption/ionization mass spectrometry and selective enzymic degradation. *Eur. J. Biochem.* **1994**, *220*, 321–330.
- Strasser, R., Mucha, J., Mach, L., Altmann, F., Wilson, I.B., Glossl, J., Steinkellner, H. Molecular cloning and functional expression of beta1,2-xylosyltransferase cDNA from *Arabidopsis thaliana*. *FEBS Lett.* **2000**, *472*, 105–108.
- Strasser, R., Altmann, F., Glossl, J., Steinkellner, H. Unaltered complex N-glycan profiles in *Nicotiana benthamiana* despite drastic reduction of beta1,2-N-acetylglucosaminyltransferase I activity. *Glycoconj. J.* **2004a**, *21*, 275–282.
- Strasser, R., Altmann, F., Mach, L., Glossl, J., Steinkellner, H. Generation of *Arabidopsis thaliana* plants with complex N-glycans lacking beta1,2-linked xylose and core alpha1,3-linked fucose. *FEBS Lett.* **2004b**, *561*, 132–136.
- Strasser, R., Stadlmann, J., Svoboda, B., Altmann, F., Glossl, J., Mach, L. Molecular basis of N-acetylglucosaminyltransferase I deficiency in *Arabidopsis thaliana* plants lacking complex N-glycans. *Biochem. J.* **2005**, *387*, 385–391.
- Strasser, R., Schoberer, J., Jin, C., Glossl, J., Mach, L., Steinkellner, H. Molecular cloning and characterization of *Arabidopsis thaliana* Golgi  $\alpha$ -mannosidase II, a key enzyme in the formation of complex N-glycans in plants. *Plant J.* **2006**, *45*, 789–803.
- Sturm, A., Van Kuik, J.A., Vliegenthart, J.F., Chrispeels, M.J. Structure, position, and biosynthesis of the high mannose and the complex oligosaccharide side chains of the bean storage protein phaseolin. *J. Biol. Chem.* **1987**, *262*, 13392–13403.

- Sturm, A. Heterogeneity of the complex N-linked oligosaccharides at specific glycosylation sites of two secreted carrot glycoproteins. *Eur. J. Biochem.* **1991**, *199*, 169–179.
- Sun, W., Kieliszewski, M.J., Showalter, A.M. Overexpression of tomato LeAGP-1 arabinogalactan-protein promotes lateral branching and hampers reproductive development. *Plant J.* **2004**, *40*, 870–881.
- Takahashi, N. Three-dimensional mapping of N-linked oligosaccharides using anion-exchange, hydrophobic and hydrophilic interaction modes of high-performance liquid chromatography. *J. Chromatogr. A* **1996**, *720*, 217–225.
- Takeuchi, M., Takasaki, S., Shimada, M., Kobata, A. Role of sugar chains in the in vitro biological activity of human erythropoietin produced in recombinant Chinese hamster ovary cells. *J. Biol. Chem.* **1990**, *265*, 12127–12130.
- Tan, L., Leykam, J.F., Kieliszewski, M.J. Glycosylation motifs that direct arabinogalactan addition to arabinogalactan-proteins. *Plant Physiol.* **2003**, *132*, 1362–1369.
- Tan, L., Qiu, F., Lamport, D.T., Kieliszewski, M.J. Structure of a hydroxyproline (Hyp)-arabinogalactan polysaccharide from repetitive Ala-Hyp expressed in transgenic *Nicotiana tabacum*. *J. Biol. Chem.* **2004**, *279*, 13156–13165.
- Tarentino, A.L., Plummer, T.H., Jr. Oligosaccharide accessibility to peptide:N-glycosidase as promoted by protein-unfolding reagents. *J. Biol. Chem.* **1982**, *257*, 10776–10780.
- Tekoah, Y., Ko, K., Koprowski, H., Harvey, D.J., Wormald, M.R., Dwek, R.A., Rudd, P.M. Controlled glycosylation of therapeutic antibodies in plants. *Arch. Biochem. Biophys.* **2004**, *426*, 266–278.
- Tretter, V., Altmann, F., Marz, L. Peptide-N<sub>4</sub>-(N-acetyl-beta-glucosaminyl)asparagine amidase F cannot release glycans with fucose attached alpha 1→3 to the asparagine-linked N-acetylglucosamine residue. *Eur. J. Biochem.* **1991**, *199*, 647–652.
- Tretter, V., Altmann, F., Kubelka, V., Marz, L., Becker, W.M. Fucose alpha 1,3-linked to the core region of glycoprotein N-glycans creates an important epitope for IgE from honeybee venom allergic individuals. *Int. Arch. Allergy Immunol.* **1993**, *102*, 259–266.
- Tsuda, E., Goto, M., Murakami, A., Akai, K., Ueda, M., Kawanishi, G., Takahashi, N., Sasaki, R., Chiba, H., Ishihara, H., et al. Comparative structural study of N-linked oligosaccharides of urinary and recombinant erythropoietins. *Biochemistry* **1988**, *27*, 5646–5654.
- Umana, P., Jean-Mairet, J., Moudry, R., Amstutz, H., Bailey, J.E. Engineered glycoforms of an antineuroblastoma IgG1 with optimized antibody-dependent cellular cytotoxic activity. *Nat. Biotechnol.* **1999**, *17*, 176–180.
- van Die, I., Gomord, V., Kooyman, F.N., van den Berg, T.K., Cummings, R.D., Vervelde, L. Core alpha1→3-fucose is a common modification of N-glycans in parasitic helminths and constitutes an important epitope for IgE from *Haemonchus contortus*-infected sheep. *FEBS Lett.* **1999**, *463*, 189–193.
- Van Kuik, J.A., van Halbeek, H., Kamerling, J.P., Vliegthart, J.F. Primary structure of the low-molecular-weight carbohydrate chains of *Helix pomatia* alpha-hemocyanin. Xylose as a constituent of N-linked oligosaccharides in an animal glycoprotein. *J. Biol. Chem.* **1985**, *260*, 13984–13988.
- Van Kuik, J.A., Sijbesma, R.P., Kamerling, J.P., Vliegthart, J.F., Wood, E.J. Primary structure of a low-molecular-mass N-linked oligosaccharide from hemocyanin of *Lymnaea stagnalis*. 3-O-methyl-D-mannose as a constituent of the xylose-containing core structure in an animal glycoprotein. *Eur. J. Biochem.* **1986**, *160*, 621–625.
- van Ree, R., Cabanes-Macheteau, M., Akkerdaas, J., Milazzo, J.P., Loutelier-Bourhis, C., Rayon, C., Villalba, M., Koppelman, S., Aalberse, R., Rodriguez, R., Faye, L., Lerouge, P. Beta(1,2)-xylose and alpha(1,3)-fucose residues have a strong contribution in IgE binding to plant glycoallergens. *J. Biol. Chem.* **2000**, *275*, 11451–11458.
- Vietor, R., Loutelier-Bourhis, C., Fitchette, A.C., Margerie, P., Gonneau, M., Faye, L., Lerouge, P. Protein N-glycosylation is similar in the moss *Physcomitrella patens* and in higher plants. *Planta* **2003**, *218*, 269–275.

- Vitale, S., Chrispeels, M.J. Transient N-acetylglucosamine in the biosynthesis of phytohemagglutinin: attachment in the Golgi apparatus and removal in protein bodies. *J. Cell Biol.* **1984**, *99*, 133–140.
- von Schaeuwen, A., Sturm, A., O'Neill, J., Chrispeels, M.J. Isolation of a mutant *Arabidopsis* plant that lacks N-acetylglucosaminyl transferase I and is unable to synthesize Golgi-modified complex N-linked glycans. *Plant Physiol.* **1993**, *102*, 1109–1118.
- Wandelt, C.I., Khan, M.R., Craig, S., Schroeder, H.E., Spencer, D., Higgins, T.J. Vicilin with carboxy-terminal KDEL is retained in the endoplasmic reticulum and accumulates to high levels in the leaves of transgenic plants. *Plant J.* **1992**, *2*, 181–192.
- Warnock, D., Bai, X., Autote, K., Gonzales, J., Kinealy, K., Yan, B., Qian, J., Stevenson, T., Zopf, D., Bayer, R.J. In vitro galactosylation of human IgG at 1 kg scale using recombinant galactosyltransferase. *Biotechnol Bioeng.* **2005a**, *92*, 831–842.
- Warnock, D., Bai, X., Autote, K., Gonzales, J., Kinealy, K., Yan, B., Qian, J., Stevenson, T., Zopf, D., Bayer, R.J. In vitro galactosylation of human IgG at 1 kg scale using recombinant galactosyltransferase. *Biotechnol. Bioeng.* **2005b**, *92*, 831–842.
- Werner, R.G., Noe, W., Kopp, K., Schluter, M. Appropriate mammalian expression systems for biopharmaceuticals. *Arzneim.-Forsch.* **1998**, *48*, 870–880.
- Wheeler, S.F., Harvey, D.J. Extension of the in-gel release method for structural analysis of neutral and sialylated N-linked glycans to the analysis of sulfated glycans: application to the glycans from bovine thyroid-stimulating hormone. *Anal. Biochem.* **2001**, *296*, 92–100.
- Wicklein, D., Lindner, B., Moll, H., Kolarich, D., Altmann, F., Becker, W.M., Petersen, A. Carbohydrate moieties can induce mediator release: a detailed characterization of two major timothy grass pollen allergens. *Biol. Chem.* **2004**, *385*, 397–407.
- Wilson, I.B., Altmann, F. Structural analysis of N-glycans from allergenic grass, ragweed and tree pollens: core alpha1,3-linked fucose and xylose present in all pollens examined. *Glycoconj. J.* **1998**, *15*, 1055–1070.
- Wilson, I.B., Rendic, D., Freilinger, A., Dunic, J., Altmann, F., Mucha, J., Muller, S., Hauser, M.T. Cloning and expression of cDNAs encoding alpha1,3-fucosyltransferase homologues from *Arabidopsis thaliana*. *Biochim. Biophys. Acta* **2001a**, *1527*, 88–96.
- Wilson, I.B., Zeleny, R., Kolarich, D., Staudacher, E., Stroop, C.J., Kamerling, J.P., Altmann, F. Analysis of Asn-linked glycans from vegetable foodstuffs: widespread occurrence of Lewis a, core alpha1,3-linked fucose and xylose substitutions. *Glycobiology* **2001b**, *11*, 261–274.
- Wright, A., Morrison, S.L. Effect of C2-associated carbohydrate structure on Ig effector function: studies with chimeric mouse-human IgG1 antibodies in glycosylation mutants of Chinese hamster ovary cells. *J. Immunol.* **1998**, *160*, 3393–3402.
- Yamane-Ohnuki, N., Kinoshita, S., Inoue-Urakubo, M., Kusunoki, M., Iida, S., Nakano, R., Wakitani, M., Niwa, R., Sakurada, M., Uchida, K., Shitara, K., Satoh, M. Establishment of FUT8 knock-out Chinese hamster ovary cells: an ideal host cell line for producing completely defucosylated antibodies with enhanced antibody-dependent cellular cytotoxicity. *Biotechnol. Bioeng.* **2004**, *87*, 614–622.
- Yoo, E.M., Morrison, S.L. IgA: an immune glycoprotein. *Clin. Immunol.* **2005**, *116*, 3–10.
- Zeleny, R., Kolarich, D., Strasser, R., Altmann, F. Sialic acid concentrations in plants lay in the range of inadvertent contaminations. *Planta* **2006**, *224*, 222–227.
- Zhao, Z.D., Tan, L., Showalter, A.M., Lampert, D.T., Kieliszewski, M.J. Tomato LeAGP-1 arabinogalactan-protein purified from transgenic tobacco corroborates the Hyp contiguity hypothesis. *Plant J.* **2002**, *31*, 431–444.

## 16

### Frontiers in Transgenic Medicinal Plants Research

*Ya'akov Tadmor and Efraim Lewinsohn*

#### 16.1

##### Introduction

Medicinal and aromatic crops are valuable sources of fresh and dry herbs, essential oils, botanicals, food supplements, and pharmaceuticals. Many of these plants have been traditionally collected from the wild, but with the advent of increasing demands, many of them have been domesticated and grown under intensive agricultural conditions. All of our cultivated crops originated from wild species, and in order to adapt wild plants into cultivation it has been necessary to introduce uniformity as well as other quality and agronomic traits [1]. The main methodology to attain this has been by breeding based on classical genetics. This approach has been largely successful, and has resulted in the huge number of crop varieties available, with unique agronomical attributes. However, this has resulted in limited genetic variation within the crop species [1, 2]. Additionally, the implementation of classic genetic methodologies in crop breeding is a relatively slow and laborious process as it usually involves several generations of crosses and selections, and sometimes requires the introduction of a novel trait from distant (often wild relatives) of the crop plant [3,4]. The transfer of a beneficial trait from one genetic background to another via sexual hybridizations results in hybrids often containing undesired traits of the donor parent. Several backcrosses to the recurrent parent are necessary to eliminate these unfavorable traits. This is often a long, costly and tedious process, but it is essential for the efficient preservation of most of the beneficial traits of the original variety into which the novel trait was introduced [3, 4].

Recent advances in molecular biology have offered promising tools for the creation of many novel crop varieties with improved nutritional and health values, resistance to herbicides, pests, diseases, pollutants and adverse climatic conditions. This has been accomplished by the use of molecular markers to monitor breeding programs and facilitate the precise and efficient introduction of a desired trait into an elite background, while maintaining the original elite content of other genomic regions [4,5]. Molecular markers are used to track the linked gene of interest to an easily detectable DNA fragment and thus accelerate recovery of the recurrent par-

ent genome in backcross programs. DNA molecular markers have also been widely used to create DNA fingerprints of plants, and have thus become useful tools for genotype identification, pedigree analysis, and estimating genetic distances between organisms. DNA fingerprints are also utilized for plant variety protection and purity, ensuring breeders' rights [4]. Classical breeding programs usually utilized phenotypic selection, while the use of molecular markers enables the initial development of the desired phenotype by direct selection at the genotypic level. The use of molecular markers has significantly reduced the time and costs of the backcross processes, increased the efficiency of precise selection of desired phenotypes, and thus has increased the efficacy and profitability of breeding programs [4]. However, the use of molecular markers does not eliminate the necessity to conduct crosses. Also, the source of contributing genes is limited by reproductive barriers, and the transfer of genes is limited only within the same biological species or to very close relatives [4, 5].

A complementary approach to crop breeding is based in the implementation of genetic engineering. The *Britannica Concise Encyclopedia* defines "genetic engineering" as the "... Artificial manipulation, modification, and recombination of DNA or other nucleic-acid molecules in order to modify an organism or population of organisms". The term initially meant any of a wide range of techniques for modifying or manipulating organisms through heredity and reproduction. Today, however, it denotes the narrower field of recombinant-DNA technology, or gene cloning, in which DNA molecules from two or more sources are combined, either within cells or in test tubes, and then inserted into host organisms in which they are able to reproduce. The implementation of genetic engineering into crop-breeding programs has become a reality, gaining much importance (and controversy) during the past few decades. Through genetic engineering the gene that is transferred may either originate from the same species, or from a completely unrelated organism. Moreover, genetic engineering enables one to silence, control and modify the expression patterns of the transferred and endogenous genes. It is presently possible to direct the synthesis of metabolites to organs or developmental stages that normally would not produce the metabolites of interest by reintroducing endogenous genes with modified expression patterns [5]. For example, the linalool synthase gene (LIS), a key gene in flower aroma, was isolated from the flowers of *Clarkia breweri* and has been cloned and transferred to tomato, where its expression was imposed to fruits by the use of the E8 promoter [6]. This has resulted in a modified aroma profile of the transgenic fruit. In an analogous fashion, by suppressing existing pathways to undesired metabolites or degradation products, it is possible to improve the quality of agricultural crops and modify the pharmacologically active components of a given medicinal plant. As only one or several new traits are efficiently incorporated into existing varieties, the need for backcross hybridizations is minimized. Genetic engineering has therefore an unprecedented ability to complement existing breeding programs. By using genetic engineering, it is now possible to efficiently manipulate the levels and composition of many primary and secondary metabolites in crops for human benefit [5]. This includes changes in carbohydrate composition, and the modifications of lipids, amino acids, pigments, nu-

traceuticals and even aroma compounds. By using these technologies it has also been possible to modify the levels of active pharmaceuticals in medicinal plants, to stimulate the production of novel chemicals, and to reduce the levels of undesired byproducts or metabolites that adversely affect the quality. Nevertheless, in order to accomplish this task efficiently it is important first to determine the active compounds to be modified, and to elucidate their biochemical pathways and the patterns of expression of the genes responsible for their synthesis. To confer plants with desired traits, novel pathways can be introduced into target plants and in parallel, endogenous genes can be “turned off” (silenced) using proper constructs. Thus, the possibility of manipulating biosynthetic pathways to accumulate valuable metabolites, either by enhancing their synthesis or by preventing their degradation, has been demonstrated. In addition, the organ specificity or temporal restrictions for the production of natural products can be overcome using genetic engineering [4].

The commercialization of many genetically engineered plants and plant products is currently being actively pursued by biotechnology and seed companies, and many genetically engineered plants are presently field-tested to determine their potential for commercialization (<http://www.nbiap.vt.edu/cfdocs/globalfieldtests.cfm>). Examples of such genetically engineered crops include novel varieties resistant to pests and pathogens, including nematodes, insects, viruses and fungi; yielding products with extended shelf-life; seed with improved amino acid or oil composition; increased carbohydrate content and improved flavors, and crops tolerant to environmentally friendly herbicides [5]. In fact, genetically engineered soybean, corn, and cotton are increasingly produced in the USA. According to the U.S. Department of Agriculture (USDA), the acreage of genetically modified organism (GMO) crops is increasing annually, such that in 2005 some 63% of US soybean acreage, 24% of the corn acreage, and 64% of the cotton acreage were GMOs (<http://usda.mannlib.cornell.edu/reports/nassr/field/pcp-bbp/pspl0301.txt>). In this chapter, we will discuss public concerns and objections to agricultural GMO products that are currently limiting their wider utilization in certain countries.

Medicinal plants comprise a group of crops presently gaining increasing popularity. To meet the demands of the growing markets for fresh and dried herbs and natural alternative medicines, better varieties of medicinal crops are constantly being produced. Medicinal plants are either utilized in their traditional way (e.g., raw, dried, extracts, tinctures), or as source for valuable medicinal compounds, nutraceuticals and health-benefiting compounds. The use of biotechnological tools in medicinal plants is very limited as compared to other crops. Traditional herbs markets normally do not accept GM plants, but in many medicinal plants it is still not clear which is the active compound, or if a mixture of components is needed for pharmacological action. This also causes a major limitation for the implementation of genetic engineering in traditionally used medicinal plants. However, this is not necessarily the case when the active compound is well defined and has a commercial demand, such as morphine in opium poppies. The implementation of genetic engineering to modify the level and composition of such natural products already used in the pharmaceuticals industry, carries a huge economical potential.



Compounds of commercial interest are often available in limited quantities, only from landraces, endangered, difficult to cultivate or exotic species, and could be overproduced in the original plant or genetically engineered into a domesticated more common crop to meet market demands.

Once the target compounds are identified, it is crucial to understand the biosynthetic pathways involved in their formation. Some natural products are biosynthesized by only one or a few enzymes from ubiquitous precursors, but most natural products require the involvement of many biosynthetic steps. Moreover, the biosynthesis of natural products is often restricted to specific organs in the plants, or occurs only during a certain developmental stage or as a response to a specific environmental stimulus [7]. Furthermore, plants often accumulate mixtures of many active natural products – a fact that makes more challenging the implementation of genetic engineering methodologies, usually targeted at one or a few genes. However, the many recent advances in our understanding of the metabolic pathways to the formation of distinct natural products, and the isolation of cDNAs coding for respective key enzymes has opened new frontiers in the genetic manipulation of medicinal plants. Genetic modification of plant secondary metabolite pathways can be performed not only by utilizing genes that code for key enzymes in the pathways, but also by using transcriptional regulators [8]. In essence, by using genetic engineering, it is possible to change essential oil compositions, pharmaceutical properties, and other characteristics by introducing genes from other organisms, changing the expression pattern of existing genes, and repressing the expression of endogenous genes, thus diverting the flow of metabolite to desired directions [4,5].

#### 16.1.1

##### **Biosynthesis: Active Principles in Medicinal Plants**

Although the pharmaceutical and industrial importance and value of many alkaloids, essential oils, and other natural products is clear to growers, processors and consumers, the biological role of most of these compounds in the plant that produces them remains obscure. Nonetheless, plants invest significant amounts of energy and resources in their production [9]. Moreover, most of them are formed by elaborate arrays of enzymes, concertedly controlled by the expression of their respective genes. Many of the natural products accumulated in plants serve as growth regulators or have clear ecological roles, such as protection against insect and mammalian predation [9–13], protection against fungal, bacterial diseases, or against adverse climatic conditions, such as damaging UV irradiation [14]. Additionally, several natural products serve as signals to attract pollinators, or mediate pathogenic, parasitic, or symbiotic interactions [10, 15]. It is often advantageous to understand the physiological role of a natural product before attempting to manipulate its levels, as the manipulation of a certain compound might affect other attributes, including agricultural performance, in the GM plant.

Although the medicinal properties of plants have been known since antiquity, this information is not always recognized by modern medicine, or has been lost in



the course of history. Modern medicinal plant research is aided by ethnobotany knowledge, and also involves the screening of plant material utilizing bioassays, cell cultures and model animals – a multidisciplinary approach termed “natural drug discovery”. Genetic enhancement of the active compound in a medicinal plant via DNA recombination requires the discovery of the active compound and the way in which it is biosynthesized. This usually involves a multidisciplinary approach that is facilitated by the coordinated action of several often seemingly controversial approaches and disciplines. The major approaches by which the active compound can be identified and modified include pharmacognosy, biochemistry, and molecular biology. The pharmacognosists develop and utilize bioassay-guided fractionation of extracts of medicinal plants for specific activities related to disease states. Once an active fraction is discovered, the biochemists identify the nature and the chemical structure of the active compounds, while the molecular biologists search for genes and plant organs involved in the biosynthesis of the active compound. The combined data from these studies are then used to develop the transgenesis approach by which the content of the active compound will be significantly increased.

Several medicinal plants have more than one medicinal use and active compound, and are often efficient in the treatment of seemingly unrelated clinical conditions. For example, St. John’s wort (*Hypericum perforatum*) was traditionally used to stop bleeding and heal wounds, but today it is mostly used to minimize the effects of minor to moderate mental depression. Neither the active compounds that heal wounds nor those acting against depression are yet fully characterized, and most probably they are not the same. Nonetheless, the quality of *H. perforatum* extracts is commonly measured by the content of the anthraquinone derivatives hypericin and hyperforin, that are unique to *Hypericum* spp. [15].

### 16.1.2

#### Identification of the Biosynthetic Pathways

As mentioned above, a prior understanding of the target biosynthetic pathway is advantageous for the discovery of the limiting biosynthetic factors and their genetic and environmental mode of regulation. Despite the vast number of chemical structures that natural products comprise, their large majority is biosynthesized by a surprisingly small number of metabolic pathways [7, 16]. Parts of these metabolic pathways are ubiquitous to all organisms, and developed by small but important modifications of ancestral genes and pathways [17, 18]. For example, many of the specialized plant compounds, including monoterpenes, sesquiterpenes, triterpenes and related derivatives such as the sterols, saponins and cucurbitacins found in many unique medicinal and aromatic plants, are all biosynthesized by the ubiquitous terpenoid pathway, by which the widespread carotenoids, chlorophylls, tocopherols and other ubiquitous metabolites are also, at least in part, biosynthesized. Similarly, diversion and modification of the ubiquitous pathway to lignin, gives rise, in specific plants and organs, to anthocyanin and other flavonoid pigments and physiologically active compounds such as the soybean phytoestrogens

and resveratrol (a stilbene derivative associated with lowering blood pressure) [7]. Volatile phenylpropene compounds such as cinnamaldehyde, *t*-anethole, and eugenol, reminiscent of cinnamon, anise, and cloves, are also derived from modifications of the general phenylpropanoid pathway [7]. In many cases, the same molecules occur in various botanically unrelated fruits; an example is the monoterpene alcohol geraniol, which displays a marked rose-like scent, is present in the scents of many flowers, and contributes to the flavor of many fruits and spices. Interestingly, the familiar purine alkaloid caffeine, present in coffee beans and leaves, is also present in tea, mate, guarana, and citrus flowers [19]. As the above plants belong to diverse and seemingly unrelated plant families, it is conceivable that the ability to biosynthesize caffeine evolved repeatedly and separately during evolution. Conversely, it is possible that all plants had the ability to biosynthesize caffeine, but this ability was lost in most (but not all) plants during evolution. At times, the biosynthetic pathways to the same compounds in different plants are not always identical. For example, in lemon basil (*Ocimum basilicum*), geraniol (a lemon-scented monoterpene alcohol) is derived from geranyl diphosphate [20, 21], whereas in tomato and watermelon fruits the very same compound, geraniol, seems to be derived by the breakdown of larger terpenoids such as lycopene [22, 23].

About 5000 different alkaloids are known, and most are derived from amino acids. Phenylalkylamines such as ephedrine, present in *Ephedra*, are derived from phenylalanine, while the indole alkaloids such as psilocin and psilocybin (present in hallucinogenic mushrooms), as well as the neuroactive serotonin and melatonin, are derived by decarboxylation of tryptophan. Tyrosine is a precursor of tyramine, a compound associated with migraines, while the betacyanin pigments are typical of beets, amaranthus and cacti, as well as the hallucinogenic phenylpropylamino alkaloid mescaline, produced by certain cacti, and the benzyloquinoline alkaloids morphine, thebaine and codeine present in opium poppies [19].

Despite the vast diversity in chemical structures, it seems that as a rule, the majority of the known natural products are biosynthesized by parallel, overlapping and somehow similar biosynthetic pathways. This is probably why metabolic engineering of secondary metabolism in medicinal plants carries such a wide potential for the improvement and modification of plant unique phytochemistries. Nevertheless, due to our lack of sufficient knowledge of the metabolic grids in the target plants, metabolic engineering of medicinal compounds can act as a two-edged sword, yielding unexpected and even counterproductive results.

## 16.2

### Sources of Key Genes that Affect the Biosynthesis of Plant Natural Products

Once the metabolic pathway to a compound of interest is known, it is possible to attempt its genetic manipulation, but first it is essential to isolate the key genes that determine the biosynthesis of the target compounds. The primary and most direct way to isolate key genes in the formation of a given natural product begins

by identifying a key enzymatic reaction involved in the formation of the metabolite of interest. This is normally accomplished by utilizing “pulse and chase” experiments as well as catalytic assays in proteinaceous cell-free extracts. The enzyme is then purified to homogeneity and a partial amino-acid sequence generated. Degenerate DNA probes and primers are then designed, synthesized and utilized to screen appropriate cDNA libraries, to isolate the desired full-length clones. This approach was initially the only alternative to isolate genes when no DNA sequence information was available, and might still be the only practical alternative to isolate genes for which no complementary sequence information is available. Certain proteins are not amenable to purification, and their purification to homogeneity might often be a frustrating task. Thus, despite the great analytical advances in protein-sequencing methodologies, obtaining sufficient homogenous protein for such analyses might be limiting for the wider use of this direct approach.

A different approach to isolate genes involved in the biosynthesis of key natural products depends on the contingent and tightly linkage of the gene of interest with previously characterized DNA markers [4]. The strength of this technology, termed “map-based positional cloning”, is its ability to hit into an almost unlimited resource of natural and induced genetic variation without prior assumptions or knowledge of specific genes. This approach is particularly promising to identify genes from species in which highly saturated genetic maps are available, such as maize and tomato [24]. However, the implementation of these methodologies into medicinal plants remains problematic. Although genetic molecular maps are available, the lack of enough molecular marker data and sufficiently saturated genetic maps presently hampers the wider use of map-based positional cloning to isolate genes affecting natural product formation [4, 25]

Possibly, the most common approach to isolate genes coding for key enzymes in secondary metabolism is based on DNA similarities displayed by genes that code for enzymes with related functions. It is a well-known phenomenon that discrete areas of similarity at the DNA level are often found in genes belonging to particular multigene families, or in genes with related biochemical or structural function. Such an approach has led to the identification of genes coding for novel *O*-methyltransferases, acyltransferases, sesquiterpene synthases, and other genes involved in secondary metabolism [18, 26, 27].

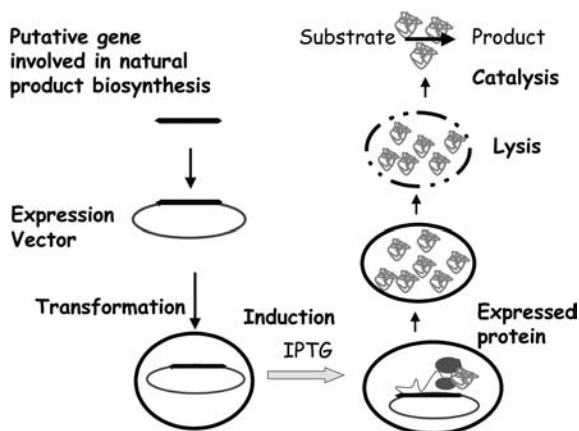
Genomic methodologies, aimed at analyzing whole genomes have been developed during the past decade. The “genomic” approaches attempt to examine the totality of the genetic information including all the genes as well as the nontranscribed regions of the DNA, in contrast to the more classical approaches that dissected individual traits. These novel methodologies include specially developed high-throughput technologies, through which a large number of sequences, genes and gene products can be examined and characterized [28, 29]. Sequence information is currently available for some complete genomes; these include information on more than 90 fully sequenced prokaryotic genomes, and eight fully sequenced eukaryotic genomes, including the human, mouse, *Arabidopsis thaliana* and rice, while many genome projects of other important plants such as maize, tomato, and *Medicago truncatula* (an annual relative of alfalfa but with a genome size of only

half) are in progress. From these studies we have learned that, in spite of the high phenotypic diversity among organisms, there are many similarities in genome organization. Therefore, the genomic information obtained for one organism is of relevance to another less-studied organism. To date, there has been no substantial effort to obtain the whole genome sequence of a medicinal crop, though tomato genomic data, for example, might be highly relevant to medicinal plants belonging to the Solanaceae and to other plant families.

In addition to full genomic information, an increasingly large amount of expressed sequence tag (EST) information is available. ESTs are generated by massive and random sequencing of cDNAs generated from the mRNA of the tissue of interest. ESTs are typically short (normally only partially represent the full-length clones) and are of relatively low sequencing quality. ESTs offer a quick method for cloning and examining a large number of genes known to be expressed in a particular cell population or tissue. Today, sequence information is available publicly for more than 7 700 000 ESTs. This information comprises many plant species, more than 1 180 000 ESTs from rice (*Oryza sativa*), 720 000 from maize (*Zea mays*), 620 000 from *Arabidopsis*, 350 000 from soybean (*Glycine max*), 250 000 from apple (*Malus domestica*), and almost 200 000 from tomato (*Lycopersicon esculentum*), to name a few. In the case of medicinal plants, EST information is still lacking, though more than 38 000 ESTs are available for ginger (*Zingiber officinale*), 30 000 for *Capsicum annuum*, 23 000 for basil (*Ocimum basilicum*), and 12 500 for turmeric (*Curcuma longa*). More than 6300 ESTs are known from ginseng (*Panax ginseng*), 6200 from ginkgo (*Ginkgo biloba*), and 5500 from *Stevia rebaudiana* ([http://www.ncbi.nlm.nih.gov/dbEST/dbEST\\_summary.html](http://www.ncbi.nlm.nih.gov/dbEST/dbEST_summary.html)). The amount of such information is rapidly growing, as many new ESTs are compiled and deposited in the public databases. Moreover, much information on many other plants is available in the private sector.

In addition to this largely increasing database size, systematic modifications of existing biochemical and molecular biology methodologies have been designed to allow for the processing of thousands of samples simultaneously. This has resulted in improved methodologies that allow the simultaneous analysis of microarrays, or cDNA chips that provide data on the transcription levels of thousands of genes (transcriptome) [29]. Developments in the automation of two-dimensional polyacrylamide gel electrophoresis, coupled to mass spectrometry (MS) adapted to proteins, has resulted in a technique often described as “proteomics”, by which it is possible to monitor abundance patterns and often identify thousands of proteins simultaneously [30]. Additionally, developments in MS has resulted in an approach often termed “metabolomics” or “metabolic profiling”, by which the levels of thousands of low molecular-weight metabolites including sugars, acids, and plant-constituents can be monitored simultaneously [29, 30]. These advances have effectively shortened the time and reduced the cost analyses of thousands of biological samples, and in turn have provided an unprecedented high volume of biological information. Many useful computer programs and algorithms to process the genomic data have been developed and are readily available, and are collectively known as “Bio-informatics”. By using bio-informatics, many putative biochemical functions

are assigned to thousands of individual sequences, based on similarity to known genes and their expression patterns. For most cases this is sufficient to predict the role of a new available gene with a great degree of accuracy. Nevertheless, the final confirmation of the biological function of a sequence is normally made by functional expression utilizing homologous or heterologous systems (Fig. 16.1). This process is not always simple or trivial, especially when annotating genes involved in secondary metabolism [5].



**Fig. 16.1** Functional expression of a gene involved in natural product biosynthesis. The gene is putatively identified by bioinformatic means, inserted into an expression vector. Bacteria are transformed with the above construct and induced to produce high levels of active protein. The putative substrate is

administered under conditions that favor catalysis, and conversion of the substrate to the expected products confirms the identity of the gene. IPTG, isopropyl- $\beta$ -D-thiogalactopyranoside. Note: A color version of this figure is available in the color plate section.

## 16.3

### Genomic Approaches Applied to Medicinal Plants Research

Many of the metabolic pathways to specific natural products occur only in specific plants and tissues. Thus, in order to take maximal advantage of the high-throughput technologies, a tissue where the genes of interest are expressed must be identified to serve as the source of genes. For example, mRNA obtained from isolated glandular trichomes from sweet basil, has been used to generate sequence information that has been key in identifying many genes involved in the biosynthesis of essential oil components of basil [20,21,26,31–33]. Similar projects aimed at elucidating genes involved in secondary metabolism in many plants are currently being pursued. These include studies in peppermint, rose petals, opium poppy (*Papaver somniferum*), *Stevia rebaudiana*, and tea tree (*Melaleuca alternifolia*), among others [34–39]. These studies have corroborated previous evidence on the involvement of specific genes and biosynthetic pathways in the formation of mono-, di-, and tetra-

terpenes, volatile phenolics alkaloids, and other secondary metabolites, and have also uncovered genes coding for novel methyltransferases, hydroxylases, acetyltransferases, sesquiterpene synthases and many other genes involved in the formation of natural products.

Other ways to verify the biological function of the sequence in question include overexpression or silencing of the gene, in the original plant, utilizing sense, anti-sense, co-suppression or RNAi constructs [40]. The purpose of these approaches is to observe any phenotypic change associated with the overexpression or silencing of a gene of interest. Phenotypic changes are interpreted, and the gene's function is deduced based on the biochemical pathways that are inferred to be altered in the transgenic plants. Transient expression analysis is a powerful tool to shorten the time for gene functional analysis. In transient expression the gene is expressed in the target tissue, but it is not stably incorporated in the plant genome and thus is not transferred to the progeny. An elegant approach for transient expression utilizes transgenic viruses for gene silencing. Virus-induced gene silencing (VIGS) involves cloning a short sequence of the plant gene of interest into a viral delivery vector. The vector is used to infect a young plant, and in a few weeks natural defense mechanisms of the plant directed at suppressing virus replication also result in specific degradation of mRNAs from the endogenous plant gene that is targeted for silencing [41]. As a result, a phenotype of a plant with a silenced gene is obtained. Agro-injection can also be used to monitor altered phenotype caused by the gene under study. This technique is based on the inoculation of a defined tissue, such as young fruits, with an *Agrobacterium* strain harboring the gene of interest with a suitable promoter. The gene is expressed during tissue development and the altered phenotype is monitored [42].

One of the most elegant examples on how systematical functional analyses can be used to identify key genes involved in natural product biosynthesis was reported for St John's wort (*Hypericum perforatum* L.), preparations of which are widely used as an antidepressant [43]. St. John's wort leaves and flowers, as well as dark-grown cell cultures, accumulate the naphthodianthrone compound, hypericin, which is intensely red and acts as a photosensitizer and inhibitor of monoamine oxidase. Although the biosynthesis of hypericin was not well studied, it was inferred that emodin, a colorless, naturally occurring anthraquinone derivative (1,3,8-trihydroxy-6-methylanthraquinone) was its precursor. An expression cDNA library was prepared from mRNA isolated from dark-grown *H. perforatum* cell cultures that produced hypericin. Upon the addition of emodin to the screening plates, intensely red-colored colonies were identified, indicating that the cells were expressing the biosynthetic enzyme and converting the putative precursor emodin to the colored hypericin. After further characterization of the product and sequence analyses of the clones, a new gene was discovered that seemingly utilizes a series of condensation, dehydration and two phenolic oxidative coupling reactions to generate hypericin [43]. Interestingly, the gene has 35% identity with norcoclaurine synthase, a gene isolated from meadow rue (*Thalictrum flavum* ssp. *glaucum*) cell cultures. (*S*)-Norcoclaurine synthase catalyzes the condensation of 3,4-dihydroxyphenylethylamine (dopamine) and 4-hydroxyphenylacetaldehyde as the

first committed step in the biosynthesis of benzyloquinoline alkaloids such as morphine, sanguinarine, and berberine, in plants [44]. This gene was isolated using amino acid sequence information of the purified *Thalictrum flavum* protein, and the cDNA's biochemical identity was confirmed by functional expression in *E. coli*.

## 16.4

### Generation of Transgenic Medicinal Plants

Metabolic engineering relies on the stable incorporation of a gene of interest into the genome, and its transfer to future generations. For that, it is also imperative to develop efficient transformation systems. Some plants (e.g., tobacco or tomato) are relatively amenable to transformation, while pepper, despite being related taxonomically to the former two, is extremely difficult to transform. It is thus crucial to develop efficient transformation systems specifically designed for each plant. A compilation of medicinal plants for which a stable transformation system has been recently reported is provided in Table 16.1. The most widely used method for plant transformation is based on the ability of the pathogenic soil bacteria *Agrobacterium* spp. to introduce into their plant hosts a fragment of a plasmid that they carry (T-DNA). By using recombinant DNA technology, the pathogenesis related genes can be replaced with agronomically important genes, rendering *Agrobacterium* an efficient transformation vector. Alternative methods for the generation of transgenic plants include the direct transformation of “naked” DNA into plant protoplasts (cells devoid of their cell-walls), by using electric shocks (electroporation) [45,46], or by use of the “particle gun” or “biolistic” transformation [47].

The gene(s) isolated should be configured so that, upon their insertion into the host plants, they will be expressed in the appropriate levels, the appropriate tissues and subcellular compartments, and without interfering with other metabolic processes taking place in the target organisms. The control of gene expression is primarily dictated by DNA sequences located adjacent to the genes of interest, termed promoters. RNA polymerases interact with the promoter sequences and other *cis*- or *trans*-acting factors to regulate gene expression. The promoters used for plant transformation can originate from several organisms, but in order to be useful the promoters must be recognized by the plant RNA-polymerase-acting factor system to be transcribed. Promoters from genes showing precise temporal and spatial regulation patterns in leaves, flower organs, roots, seeds, as well as responsive to external influences such as heat shock, wounding, and applied chemicals have been identified, and can be used to direct the expression of the gene of interest in the target plant. Alternatively, by using strong constitutive promoters such as the CaMV 35S promoter derived from the cauliflower mosaic virus, it is possible to bring about expression of the gene of interest constitutively throughout the genetically altered plant. In other words, by a careful choice of the promoter used coupled to the gene of interest, it is possible to generate transgenic plants in which expression of the transgenic trait is restricted to a certain organ, a defined developmental

**Table 16.1** Medicinal plants with stable transformation systems.

<b>Latin name</b>	<b>Common name</b>	<b>Transformation system</b>	<b>Ref.</b>
<i>Allium sativum</i> L.	Garlic	Microprojectile bombardment	54
<i>Artemisia annua</i> L.	Artemisia	<i>Agrobacterium tumefaciens</i>	55
<i>Bacopa monniera</i> (L.) Wettst.	Brahmi	<i>A. tumefaciens</i>	56
<i>Cannabis sativa</i> L.	Hemp	<i>A. tumefaciens</i>	57
<i>Digitalis minor</i>	Common foxglove	<i>A. tumefaciens</i>	58
<i>Drosera rotundifolia</i> L.	Round-leaved sundew	<i>A. tumefaciens</i>	59
<i>Echinacea purpurea</i>	Purple coneflower	<i>A. tumefaciens</i>	60
<i>Eleutherococcus sessiliflorus</i>	Siberian Ginseng	<i>A. tumefaciens</i>	61
<i>Eschscholzia californica</i> Cham.	California poppy	<i>A. tumefaciens</i>	62
<i>Hyoscyamus niger</i> L.	Black henbane	<i>A. tumefaciens</i>	63
<i>Lycium barbarum</i>	Chinese wolfberries	<i>A. tumefaciens</i>	64
<i>Panax quinquefolius</i> L.	American ginseng	<i>A. tumefaciens</i>	65
<i>Papaver somniferum</i> L.	Poppy	<i>A. tumefaciens</i>	66
<i>Passiflora edulis</i> f. <i>flavicarpa</i>	Passion fruit	Protoplast fusion	67
<i>Raphanus sativus</i> (L.) G. Beck	Radish	Floral dipping	68
<i>Rehmannia glutinosa</i> (Gaertn.) Steud.	Chinese foxglove	<i>A. tumefaciens</i>	69
<i>Ruta graveolens</i> L.	Garden rue	<i>A. tumefaciens</i>	70
<i>Scrophularia buergeriana</i> Miq.	Figwort	<i>A. tumefaciens</i>	71
<i>Thalictrum flavum</i> ssp. <i>glaucum</i>	Meadow rue	<i>A. tumefaciens</i>	72

stage, a response to the environment, or alternatively, the introduced gene is constitutively expressed throughout the plant.

Genetic engineering has afforded novel ways to attain insect, herbicide and stress resistance in many crops. Transgenic medicinal plants, harboring such genes are not commercially used. Nevertheless, transgenic belladonna with altered alkaloid content (see below) is currently being field-tested for insect resistance (<http://www.isb.vt.edu/cfdocs/fieldtests3.cfm>). More recently, we have witnessed successes in metabolic engineering of crops to attain novel and better quality characteristics, such as modified color, aroma, and nutritional content [5]. The potential for metabolic engineering to modify the composition of active components of medicinal plants is still in its early stages, and is ready to be explored [48–53].



## 16.5

### Metabolically Engineered Medicinal Plants

#### 16.5.1

#### Alkaloids

Many alkaloids are pharmacologically active and are often the active principles of medicinal plants. Although the biosynthetic pathways to alkaloids in plants are usually complex and involve many biosynthetic steps, they have been an important target for metabolic engineering experiments. Many of the key genes involved in the biosynthetic pathways for some alkaloids, such as scopolamine, nicotine, morphine and berberine, have been isolated and identified [7, 73]. The prospects and limitations of engineering plant alkaloid metabolism have generated a great deal of interest [48, 73–77]. Some examples describing metabolic engineering for the modification of the pharmaco-active principles of medicinal plants are described below.

##### 16.5.1.1 Amino Alkaloids

Aromatic L-amino decarboxylases catalyze the decarboxylation of aromatic amino acids, and serve as a key starting point for the biosynthesis of many plant amino alkaloids [49]. Decarboxylation of tyrosine gives rise to tyramine and dopamine; these latter compounds serve as precursors of many other alkaloids and cell-wall components. Tryptamine and serotonin are derived from the decarboxylation of tryptophan. Genetic manipulation of the levels of aromatic amino decarboxylases has led to increases in tryptamine, serotonin and tyramine levels, and has also resulted in decreased cell wall digestibility due to increased deposition of amino alkaloid components [49].

##### 16.5.1.2 Terpenoid Indole Alkaloids

Terpenoid indole alkaloids are accumulated by many medicinal plants, including *Rauwolfia serpentina*, *Catharanthus roseus*, and *Strichnos nux vomica*, and have many pharmacological uses. They include reserpine, which lowers blood pressure, ajmaline, which is used to treat heart arrhythmias, and strychnine, a potent poison [19]. The biosynthetic pathway to indole alkaloids is involved and includes more than 20 enzymatic steps. Nevertheless, the enzyme strictosidine synthase catalyzes a key step in the biosynthesis of terpenoid indole alkaloids: the condensation of tryptamine and secologanin to form strictosidine [78]. Strictosidine is a precursor to many important alkaloids such as strychnine, quinine, vincristine, vinblastine, ajmaline and ajmalicine [78]. Cell cultures of *Catharanthus roseus* have been transformed with the gene strictosidine synthase (*Str*). Ectopic expression of the *Str* transgene caused an accumulation of the glucoalkaloid strictosidine and some of its derivatives, including ajmalicine, catharanthine, serpentine, and tabersonine [48].

#### 16.5.1.3 Tropane Alkaloids: Hyoscyamine and Scopolamine

One of the first reports of successful metabolic engineering of a medicinal plant was reported in 1992 [77]. Belladonna (*Atropa belladonna*) accumulates the tropane alkaloid hyoscyamine, used against skeletal muscles spasms and as an antidote against organophosphate poisoning [19]. The epoxidated-derivative of hyoscyamine, namely scopolamine, possesses anticholinergic activity, and is primarily a depressant on the central nervous system; its is used prophylactically against motion sickness.

Scopolamine is biosynthesized from hyoscyamine by the action of hyoscyamine 6- $\beta$ -hydroxylase. This gene was transferred from *Hyoscyamus niger* to belladonna and constitutively expressed. The transgenic belladonna accumulated almost exclusively scopolamine *in lieu* of hyoscyamine in their aerial parts [77]. Interestingly, the transgenic belladonna carrying the hyoscyamine 6-hydroxylase gene with altered alkaloid content is now being field-tested for insect resistance (<http://www.nbiap.vt.edu/cfdocs/globalfieldtests.cfm>).

#### 16.5.1.4 Isoquinoline Alkaloids: Morphine, Codeine, and Thebaine

A genetically modified opium poppy that produces the pharmaceutical precursor, thebaine, instead of the narcotic alkaloids morphine and codeine, has recently been described [79]. Opium, the latex of the immature capsules of the opium poppy (*Papaver somniferum*), has been used as a pain reliever from antiquity. During the 19th century, morphine, codeine and thebaine were isolated from opium, and their structures determined. Thebaine is a convulsant drug with no analgesic effects and, as such, is not used clinically. However, it is important in the production of other semisynthetic opioids, including many of the modern pain-relievers. Since thebaine (in contrast to morphine) cannot be easily converted to heroin (an acetyl derivative of morphine), the genetically altered crops provides a good solution to hamper the utilization of opium poppy as a source for the illicit drug market.

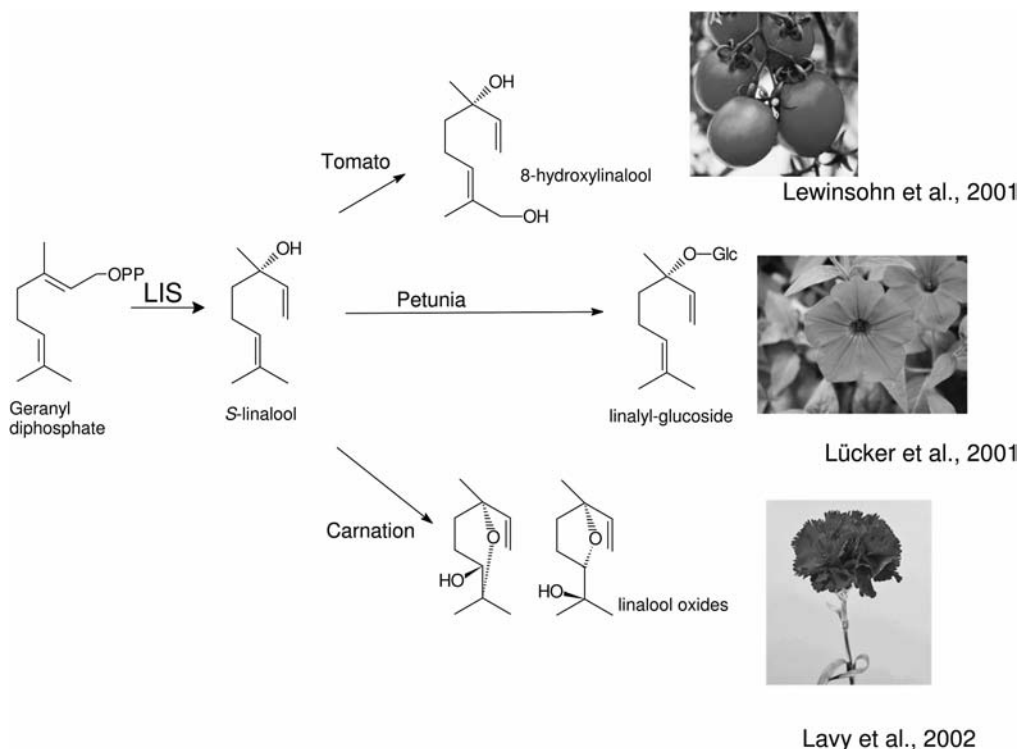
### 16.5.2

#### Metabolic Engineering of the Terpenoid Pathway

##### 16.5.2.1 Monoterpenes

Many monoterpenes are key constituents of essential oils and impart unique aromas to flowers and fruits. Some monoterpenes have therapeutic properties. Peppermint (*Mentha  $\times$  piperita*) essential oil consists mainly of menthol and menthone, while high levels of menthofuran are considered detrimental to its quality. The gene coding for the enzyme menthofuran synthase has been silenced in peppermint, generating plants harboring an essential oil with a much lower menthofuran levels, and therefore of a much higher quality than the essential oil from control nontransgenic plants [80]. Moreover, ectopic expression of the gene coding for deoxyxylulose phosphate reductoisomerase, a key enzyme in the plastid terpenoid pathway by which mint monoterpenes are biosynthesized, caused a 50% increase in accumulation of the total the essential oil levels in transgenic peppermint [80].

Other examples of the metabolic engineering of the monoterpene pathway have been demonstrated utilizing the *Clarkia breweri* floral gene linalool synthase (LIS) [81]. When LIS was overexpressed in tomato fruit, noticeable levels of linalool and 8-hydroxylinalool were noted [6]. When the same gene was expressed in *Petunia* flowers, the linalool formed in the transgenic plants was glycosylated [82]. Interestingly, when the *Clarkia* LIS gene was overexpressed in carnation flowers, a lower level of linalool was detected, together with linalool oxides [83]. The above examples illustrate that the introduction of one gene into different tissue and organism can give rise to many phenotypes. Thus, in metabolic engineering the same gene product can result in different phenotypes depending on the targeted tissue and organism (Fig. 16.2). Understanding the cause for these differences will facilitate future metabolic engineering experiments.



**Fig. 16.2** Overexpression of the *Clarkia breweri* S-linalool synthase (LIS) in different plants and tissues results in the formation of different end products. Note: A color version of this figure is available in the color plate section.

#### 16.5.2.2 Sesquiterpenes

Wormwood (*Artemisia annua* L., Asteraceae) is an annual herb that contains artemisinin, a sesquiterpene lactone. Artemisinin is available commercially as an anti-malarial drug that is efficacious against drug-resistant strains of *Plasmodium*, the malarial parasite. Artemisinin is formed by a series of biosynthetic steps initiated

by cyclization of farnesyl diphosphate. Overexpression in transgenic wormwood plants, of a cotton gene encoding farnesyl diphosphate synthase (the enzyme catalyzing farnesyl diphosphate synthesis) resulted in a two- to threefold increased production of artemisinin as compared to nontransformed controls, probably due to an increase in the levels of available farnesyl diphosphate [84].

### 16.5.3

#### **Cannabinoids**

Tetrahydrocannabinolic acid (THCA) synthase is the enzyme responsible for the production of tetrahydrocannabinol (THC), the psycho-active principle of marijuana. THCA synthase catalyzes the cyclization of the monoterpene moiety of cannabigerolic acid to form THCA. The gene that codes for this enzyme has recently been identified, isolated, and found to be expressed in the trichomes of the plant [85]. This gene is similar to the gene from *Eschscholzia californica* that codes for the FAD-dependent berberine bridge enzyme, involved in the formation of berberine, an antimicrobial alkaloid constituent of many traditionally used plants. The THCA synthase gene was overexpressed in tobacco plants that were able to synthesize THCA and when fed with cannabigerolic acid [86]. Since cannabigerolic acid is relatively easy to synthesize, and the THCA produced is secreted into the media in which the transgenic plants were grown, this approach renders a novel alternative for the production of THCA in a controlled way for medicinal purposes.

## 16.6

### **Conclusions**

The utilization of modern biotechnological tools, as well as high-throughput genomics analyses, including sequence data, transcriptomics, proteomics, and metabolomics, coupled to bioinformatic tools and functional expression, has allowed the identification of novel genes involved in the biosynthesis of key natural products. These genes can readily be used to modify the phytochemistries of medicinal plants using metabolic engineering. Moreover, the potential for metabolic engineering to improve the nutritional and health value of agricultural produce, and even to generate new medicinal plants based on common food crops using genes involved in secondary metabolism is very promising. Transgenesis technology has been used to produce a variety of crop plants. To date, the commercial successes of GM crops are limited to conferring resistance to insect pests and viruses, and producing tolerance to specific environmentally friendly herbicides. These traits are highly beneficial for farmers, but the benefit to the consumers is less evident, except for the rare cases where the use of GM crops has led to reduced prices. This is probably one of the major reasons for the public objections and concerns regarding GM products. Many of our antibiotics and other drugs we consume are produced by using modern biotechnology, including transgenic bacteria and cell cultures, without any significant public objection. GM medicinal plants are unlikely to

be used for traditional consumption. However, the successful production of GM medicinal plants, with increased concentrations of active compounds or with improved agronomic performance, are commercially appealing. It is believed that the production of such transgenic medicinal plants are a major challenge for current research and development in biotechnology.

Traditionally, throughout human history and in all cultures, plants have been used as a source of medicines. Scientific progress has allowed us to identify a minor fraction of the active compounds and their mode(s) of action, and this has greatly contributed to the development of modern medicines. It is still arguable, however, whether transgenic medicinal plants will be an economical reality in the near future. Nonetheless, there is no doubt that the biological information of how to synthesize the often extremely complex bio-active compounds is contained within the genome of medicinal plants. In the genomic era, medicinal plants are not only a source of chemicals, having acquired a new role, but also serve as a source for genes involved in formation of the active principles. It is our joint duty not only to extract information from these plants and to utilize this information wisely, but also to preserve them for future generations.

## References

- 1 Zamir, D. Improving plant breeding with exotic genetic libraries. *Nature Rev. Genet.* **2001**, *2*, 983–989.
- 2 Fernie, A.R., Tadmor, Y., Zamir, D. Natural genetic variation for improving crop quality. *Curr. Opin. Plant Biol.* **2006**, *9*, 196–202.
- 3 Agrawal, R.L. *Fundamentals of Plant Breeding and Hybrid Seed Production*. Science Publishers, Inc., Enfield, NH, USA, **1998**.
- 4 Lewinsohn, E., Tadmor, Y. Biotechnology in medicinal crops improvement. In: Yaniv, Z., Bachrach, U. (Eds.), *Handbook of Medicinal Plants*. The Haworth Press, Inc., Binghamton, New York, **2005**, Chapter 12, pp. 235–260.
- 5 Galili, G., Galili, S., Lewinsohn, E., Tadmor, Y. Utilization of genetic, molecular and genomic approaches to improve the value of plant food and feeds. *Crit. Rev. Plant Sci.* **2002**, *21*, 167–204.
- 6 Lewinsohn, E., Schalechet, F., Wilkinson, J., Matsui, K., Tadmor, Y., Nam, K.H., Amar, O., Lastochkin, E., Larkov, O., Ravid, U., Hiatt, W., Gepstein, S., Pichersky, E. Enhanced levels of the aroma and flavor compound S-linalool by metabolic engineering of the terpenoid pathway in tomato fruits. *Plant Physiol.* **2001**, *127*, 1256–1265.
- 7 Croteau, R., Kutchan, T.M., Lewis, N.G. Natural products (secondary metabolites). In: Buchanan, B., Gruissem, W., Jones R. (Eds.), *Biochemistry and Molecular Biology of Plants*. American Society of Plant Physiologists, Rockville, MD, **2000**, pp. 1250–1318.
- 8 Memelink, J., Kijne, J.W., Van der Heijden, R., Verpoorte, R. Genetic modification of plant secondary metabolite pathways using transcriptional regulators. *Adv. Biochem. Eng. Biotechnol.* **2001**, *72*, 103–125.
- 9 Gershenzon, J. The cost of plant chemical defense against herbivory: a biochemical perspective. In: Bernays, E.A. (Ed.), *Insect-Plant Interactions*. CRC Press, Boca Raton, **1994**, pp. 105–173.
- 10 Harborne, J.B. Recent advances in chemical ecology. *Nat. Prod. Rep.* **1989**, *6*, 85–109.
- 11 Harborne, J.B. *Recent advances in the ecological chemistry of plant terpenoids*. In: Harborne, J.B., Tomas-Barberan, F.A. (Eds.), *Ecological Chemistry and Biochemistry of Plant Terpenoids*. Clarendon Press, Oxford, **1991**, pp. 399–426.

- 12 Langenheim, J.H. Higher plant terpenoids: a phytocentric overview of their ecological rules. *J. Chem. Ecol.* **1994**, *20*, 1223–1280.
- 13 Lewinsohn, E., Gijzen, M., Croteau, R. Regulation of monoterpene biosynthesis in conifer defense. In: Nes, W.D., Parish, E.J., Trzaskos, J.M. (Eds.), *Regulation of Isopentenoid Metabolism*. ACS Symposium Series 497, Washington DC, **1992**, pp. 8–17.
- 14 Chapple, C.C.S., Vogt, T., Ellis, B.E., Somerville, C.R. An Arabidopsis mutant defective in the general phenylpropanoid pathway. *Plant Cell* **1992**, *4*, 1413–1424.
- 15 Pirker, R., Huck, C.W., Bonn, G.K. Simultaneous determination of hypericin and hyperforin in human plasma and serum using liquid-liquid extraction, high-performance liquid chromatography and liquid chromatography-tandem mass spectrometry. *J. Chromatogr. B Analyt. Technol. Biomed. Life Sci.* **2002**, *777*, 147–153.
- 16 Schwab, W. Metabolome diversity: Too many metabolites too few genes. *Phytochemistry* **2003**, *62*, 837–849.
- 17 Pichersky, E., Gang, D.R. Genetics and biochemistry of specialized metabolites in plants: an evolutionary perspective. *Trends Plant Sci.* **2000**, *5*, 439–445.
- 18 Gang, D.R. Evolution of flavors and scents. *Annu. Rev. Plant Biol.* **2005**, *56*, 301–325.
- 19 Samuelsson, G. *Drugs of Natural Origin. A Textbook of Pharmacognosy*. Swedish Pharmaceutical Press, Stockholm, **1991**.
- 20 Iijima, Y., Gang, D.R., Fridman, E., Lewinsohn, E., Pichersky, E. Characterization of geraniol synthase from the peltate glands of sweet basil. *Plant Physiol.* **2004**, *134*, 370–379.
- 21 Iijima, Y., Wang, G., Fridman, E., Pichersky, E. Analysis of the enzymatic formation of citral in the glands of sweet basil. *Arch. Biochem. Biophys.* **2006**, *448*, 141–149.
- 22 Lewinsohn, E., Sitrit, Y., Bar, E., Azulay, Y., Ibdah, M., Meir, A., Yosef, E., Zamir, D., Tadmor, Y. Not just color – Carotenoid degradation as a link between color and aroma in tomato and watermelon fruit. *Trends Food Sci. Technol.* **2005**, *16*, 407–415.
- 23 Lewinsohn, E., Sitrit, Y., Bar, E., Azulay, Y., Meir, A., Zamir, D., Tadmor, Y. Carotenoid pigmentation affects the volatile composition of tomato and watermelon fruits, as revealed by comparative genetic analyses. *J. Agric. Food Chem.* **2005**, *53*, 3142–3148.
- 24 Yano, M. Genetic and molecular dissection of naturally occurring variation. *Curr. Opin. Plant Biol.* **2001**, *4*, 130–135.
- 25 Straka, P., Nothangel, T.A. genetic map of *Papaver somniferum* L. based on molecular and morphological markers. *J. Herbs Spices Medic. Plants* **2002**, *9*, 235–241.
- 26 Iijima, Y., Davidovich-Rikanati, R., Fridman, E., Gang, D.R., Bar, E., Lewinsohn, E., Pichersky, E. The biochemical and molecular basis for the divergent patterns in the biosynthesis of terpenes and phenylpropenes in the peltate glands of three cultivars of basil. *Plant Physiol.* **2004**, *136*, 3724–3736.
- 27 Bohlmann, J., Meyer-Gauen, G., Croteau, R. Plant terpenoid synthases: molecular biology and phylogenetic analysis. *Proc. Natl. Acad. Sci. USA* **1998**, *95*, 4126–4133.
- 28 Richmond, T., Somerville, S. Chasing the dream: plant EST microarrays. *Curr. Opin. Plant Biol.* **2000**, *3*, 108–116.
- 29 Oliver, D.J., Nikolau, B., Wurtele, E.S. Functional genomics: high-throughput mRNA, protein and metabolite analyses. *Metabol. Eng.* **2002**, *4*, 98–106.
- 30 Griffin, T.J., Goodlett, D.R., Aebersold, R. Advances in proteome analysis by mass spectrometry. *Curr. Opin. Biotechnol.* **2001**, *12*, 607–612.
- 31 Gang, D., Lavid, N., Zubieta, C., Cheng, F., Beuerle, T., Lewinsohn, E., Noel, J.P., Pichersky, E. Characterization of phenylpropene O-methyltransferases from sweet basil: facile change of substrate specificity and convergent evolution within a plant O-methyltransferase family. *Plant Cell* **2002**, *14*, 505–519.
- 32 Gang, D.R., Beuerle, T., Ullmann, P., Werck-Reichhart, D., Pichersky, E. Differential production of *meta* hydroxylated phenylpropanoids in sweet basil peltate glandular trichomes and leaves is controlled by the activities of specific acyltransferases and hydroxylases. *Plant Physiol.* **2002**, *130*, 1536–1544.

- 33 Gang, D.R., Wang, J., Dudareva, N., Nam, K.H., Simon, J., Lewinsohn, E., Pichersky, E. An investigation of the storage and biosynthesis of phenylpropenes in sweet basil (*Ocimum basilicum* L.). *Plant Physiol.* **2001**, *125*, 539–555.
- 34 Lange, B.M., Wildung, M.R., Stauber, E.J., Sanchez, C., Pouchnik, D., Croteau, R. Probing essential oil biosynthesis and secretion by functional evaluation of expressed sequence tags from mint glandular trichomes. *Proc. Natl. Acad. Sci. USA* **2000**, *97*, 2934–2939.
- 35 Lavid, N., Wang, J., Shalit, M., Guterman, I., Bar, E., Beuerle, T., Menda, N., Shafir, S., Zamir, D., Adam, Z., Vainstein, A., Weiss, D., Pichersky, E., Lewinsohn, E. O-Methyltransferases involved in the biosynthesis of volatile phenolic derivatives in rose petals. *Plant Physiol.* **2002**, *129*, 1899–1907.
- 36 Guterman, I., Shalit, M., Menda, M., Piestun, D., Dafny-Yelin, M., Shalev, G., Bar, E., Davydov, O., Ovadis, M., Emanuel, M., Wang, J., Adam, Z., Pichersky, E., Lewinsohn, E., Zamir, D., Vainstein, A., Weiss, D. Rose scent: genomics approach to discovering novel floral fragrance-related genes. *Plant Cell* **2002**, *14*, 2325–2338.
- 37 Kutchan, T.M. Sequence based approaches to alkaloid biosynthesis gene identification. In: Romeo, J.T., Dixon, R.A. (Eds.), *Phytochemistry in the Genomics and Post Genomics Eras. Recent Advances in Phytochemistry*. Volume 36. Pergamon Press, Amsterdam, **2002**, pp. 163–178.
- 38 Brandle, J.E., Richman, A., Swanson, A.K., Chapman, B.P. Leaf ESTs from *Stevia rebaudiana*: a resource for gene discovery in diterpene synthesis. *Plant Mol. Biol.* **2002**, *50*, 613–622.
- 39 Shelton, D., Leach, D., Baverstock, P., Henry, R. Isolation of genes involved in secondary metabolism from *Melaleuca alternifolia* (Cheel) using expressed sequence tags (ESTs). *Plant Sci.* **2002**, *162*, 9–15.
- 40 Dudley, N.R., Labbe, J.C., Goldstein, B. Using RNA interference to identify genes required for RNA interference. *Proc. Natl. Acad. Sci. USA* **2002**, *99*, 4191–4196.
- 41 Robertson, D. VIGS vectors for gene silencing: many targets, many tools. *Annu. Rev. Plant Biol.* **2004**, *55*, 495–519.
- 42 Orzaez, D., Mirabel, S., Wieland, W.H., Granell, A. Agroinjection of tomato fruits. A tool for rapid functional analysis of transgenes directly in fruit. *Plant Physiol.* **2006**, *140*, 3–11.
- 43 Bais, H.P., Vepachedu, R., Lawrence, C.B., Stermitz, F.R., Vivanco, J.M. Molecular and biochemical characterization of an enzyme responsible for the formation of hypericin in St. John's wort (*Hypericum perforatum* L.). *J. Biol. Chem.* **2003**, *278*, 32413–32422.
- 44 Samanani, N., Liscombe, D.K., Facchini, P.J. Molecular cloning and characterization of norcoclaurine synthase, an enzyme catalyzing the first committed step in benzyloisoquinoline alkaloid biosynthesis. *Plant J.* **2004**, *40*, 302–313.
- 45 Fraley, R.T., Rogers, S.G., Hoersch, R.B. Genetic transformation in higher plants. *Crit. Rev. Plant Sci.* **1986**, *4*, 1–46.
- 46 Gheysen, G., Angenon, G., Van Montagu, M. Transgenic plants: *Agrobacterium tumefaciens*-mediated transformation and its use for crop improvement. In: Murray, J.A.H. (Ed.), *Transgenesis*. John Wiley & Sons, **1992**, pp. 187–232.
- 47 Sanford, J.C. The biolistic process. *Trends Biotechnol.* **1988**, *6*, 299–302.
- 48 Canel, C., Lopes-Cardoso, M.I., Whitmer, S., Van der Fits, L., Pasquali, G., Van der Heijden, R., Hoge, J.H., Verpoorte, R. Effects of over-expression of strictosidine synthase and tryptophan decarboxylase on alkaloid production by cell cultures of *Catharanthus roseus*. *Planta* **1998**, *205*, 414–419.
- 49 Facchini, P.J., Huber-Allanach, K.L., Tari, L.W. Plant aromatic L-amino acid decarboxylases: evolution, biochemistry, regulation, and metabolic engineering applications. *Phytochemistry* **2000**, *54*, 121–138.
- 50 Hughes, E.H., Hong, S.B., Gibson, S.I., Shanks, J.V., Ky Sana. Metabolic engineering of the indole pathway in *Catharanthus roseus* hairy roots and increased accumulation of tryptamine and serpentine. *Metabol. Eng.* **2004**, *6*, 268–276.



- 51 Hughes, E.H., Shanks, J.V. Metabolic engineering of plants for alkaloid production. *Metab. Eng.* **2002**, *4*, 41–48.
- 52 Hagel, J.M., Facchini, P.J. Elevated tyrosine decarboxylase and tyramine hydroxycinnamoyltransferase levels increase wound-induced tyramine-derived hydroxycinnamic acid amide accumulation in transgenic tobacco leaves. *Planta* **2005**, *221*, 904–914.
- 53 Park, S.U., Yu, M., Facchini, P.J. Modulation of berberine bridge enzyme levels in transgenic root cultures of California poppy alters the accumulation of benzophenanthridine alkaloids. *Plant Mol. Biol.* **2003**, *51*, 153–164.
- 54 Robledo-Paz, A., Cabrera-Ponce, J., Villalobos-Arambula, V., Herrera-Estrella, L., Jofre-Garfias, A. Genetic transformation of garlic (*Allium sativum* L.) by particle bombardment. *HortScience* **2004**, *39*, 1208–1211.
- 55 Han, J.L., Wang, H., Ye, H.C., Liu, Y., Li, Z.Q., Zhang, Y., Zhang, Y.S., Yan, F., Li, G.F. High efficiency of genetic transformation and regeneration of *Artemisia annua* L. via *Agrobacterium tumefaciens*-mediated procedure. *Plant Sci.* **2005**, *168*, 73–80.
- 56 Nisha, K.K., Seetha, K., Rajmohan, K., Purushothama, M.G. *Agrobacterium tumefaciens*-mediated transformation of Brahmi (*Bacopa monniera* (L.) Wettst.), a popular medicinal herb of India. *Curr. Sci.* **2003**, *85*, 85–89.
- 57 Feeney, M., Punja, Z.K. Tissue culture and *Agrobacterium*-mediated transformation of hemp (*Cannabis sativa* L.). *In Vitro Cell. Devel. Biol. Plant* **2003**, *39*, 578–585.
- 58 Sales, E., Nebauer, S.G., Arrillaga, I., Segura, J. Plant hormones and *Agrobacterium tumefaciens* strain 82.139 induce efficient plant regeneration in the cardenolide-producing plant *Digitalis minor*. *J. Plant Physiol.* **2002**, *159*, 9–16.
- 59 Hirsikorpi, M., Kamarainen, T., Teeri, T., Hohtol, A.A. *Agrobacterium*-mediated transformation of round leaved sundew (*Drosera rotundifolia* L.) *Plant Sci.* **2002**, *162*, 537–542.
- 60 Wang, H., To, K. *Agrobacterium*-mediated transformation in the high-value medicinal plant *Echinacea purpurea*. *Plant Sci.* **2004**, *166*, 1087–1096.
- 61 Choi, Y.E., Jeong, J.H., Baek, S.H., Seob, H.Y. *Agrobacterium tumefaciens*-mediated genetic transformation of *Eleutherococcus sessiliflorus* by phosphinothricin acetyl transferase gene. *In Vitro Cell. Develop. Biol. Plant* **2004**, *40*, 51–56.
- 62 Macleod, B.P., Facchini, P.J. Methods for regeneration and transformation in *Eschscholzia californica* – A model plant to investigate alkaloid biosynthesis. *Methods Mol. Biol.* **2006**, *318*, 357–368.
- 63 Tu, S., Sangwan, R.S., Raghavan, V., Verma, D.P.S., Sangwan-Norreel, B.S. Transformation of pollen embryo-derived explants by *Agrobacterium tumefaciens* in *Hyoscyamus niger*. *Plant Cell Tissue Organ Cult* **2005**, *81*, 139–148.
- 64 Hu, Z., Yang, J., Guo, G.Q., Zheng, G.C. High-efficiency transformation of *Lycium barbarum* mediated by *Agrobacterium tumefaciens* and transgenic plant regeneration via somatic embryogenesis. *Plant Cell Rep.* **2002**, *21*, 233–237.
- 65 Chen, W.P., Punja, Z.K. *Agrobacterium*-mediated transformation of American ginseng with a rice chitinase gene. *Plant Cell Rep.* **2002**, *20*, 1039–1045.
- 66 Chitty, J.A., Allen, R.S., Fist, A.J., Larkin, P.J. Genetic transformation in commercial Tasmanian cultivars of opium poppy, *Papaver somniferum*, and movement of transgenic pollen in the field. *Functional Plant Biol.* **2003**, *30*, 1045–1058.
- 67 Davey, M.R., Anthony, P., Power, J.B., Lowe, K.C. Isolation, culture, and plant regeneration from leaf protoplasts of *Passiflora*. *Methods Mol. Biol.* **2006**, *318*, 201–210.
- 68 Curtis, I.S. The noble radish: past, present and future. *Trends Plant Sci.* **2003**, *8*, 305–307.
- 69 Lim, J., Yun, S., Chung, I., Yu, C. Resveratrol synthase transgene expression and accumulation of resveratrol glycoside in *Rehmannia glutinosa*. *Mol. Breeding* **2005**, *16*, 219–233.
- 70 Lievre, K., Hehn, A., Tran, T., Gravot, A., Thomasset, B., Bourgaud, F., Gontier, E. Genetic transformation of the medicinal plant *Ruta graveolens* L. by an *Agrobacterium tumefaciens*-mediated method. *Plant Sci.* **2005**, *168*, 883–888.
- 71 Park, S.U., Chae, Y.A., Facchini, P.J. Genetic transformation of the figwort,



- Scrophularia buergeriana* Miq., an Oriental medicinal plant. *Plant Cell Rep.* **2003**, *21*, 1194–1198.
- 72 Samanani, N., Park, S.U., Facchini, P.J. *In vitro* regeneration and genetic transformation of the berberine-producing plant, *Thalictrum flavum* ssp. *glaucum*. *Physiol. Planta.* **2002**, *116*, 79–86.
- 73 Verpoorte, R., Contin, A., Memelink, J. Biotechnology for the production of plant secondary metabolites. *Phytochem. Rev.* **2002**, *1*, 13–25.
- 74 Kutchan, T.M. Alkaloid biosynthesis – the basis for metabolic engineering of medicinal plants. *Plant Cell* **1995**, *7*, 1059–1070.
- 75 Sato, F., Hashimoto, T., Hachiya, A., Tamura, K., Choi, K.B., Morishige, T., Fujimoto, H., Yamada, Y. Metabolic engineering of plant alkaloid biosynthesis. *Proc. Natl. Acad. Sci. USA* **2001**, *98*, 367–372.
- 76 Verpoorte, R., Memelink, J. Engineering secondary metabolite production in plants. *Curr. Opin. Biotechnol.* **2002**, *13*, 181–187.
- 77 Yun, D.J., Hashimoto, T., Yamada, Y. Metabolic engineering of medicinal plants: transgenic *Atropa belladonna* with an improved alkaloid composition. *Proc. Natl. Acad. Sci. USA* **1992**, *89*, 11799–11803.
- 78 Bruneton, J. *Pharmacognosy, Phytochemistry, Medicinal Plants*. Intercept Ltd, Andover, UK, **1995**.
- 79 Memelink, J. Putting the opium in poppy to sleep. *Nature Biotechnol.* **2004**, *22*, 1526–1527.
- 80 Mahmoud, S.S., Croteau, R.B. Metabolic engineering of essential oil yield and composition in mint by altering expression of deoxyxylulose phosphate reductoisomerase and menthofuran synthase. *Proc. Natl. Acad. Sci. USA* **2001**, *98*, 8915–8920.
- 81 Dudareva, N., Cseke, L., Blanc, V.M., Pichersky, E. Evolution of floral scent in *Clarkia*: Novel patterns of S-linalool synthase gene expression in the *C. breweri* flower. *Plant Cell* **1996**, *8*, 1137–1148.
- 82 Lucker, J., Bouwmeester, H.J., Schwab, W., Blaas, J., Van der Plas, L.H.W., Verhoeven, H.A. Expression of *Clarkia* S-linalool synthase in transgenic petunia plants results in the accumulation of S-linalyl- $\beta$ -glucopyranoside. *Plant J.* **2001**, *27*, 315–324.
- 83 Lavy, M., Zuker, A., Lewinsohn, E., Larkov, O., Ravid, U., Vainstein, A., Weiss, D. Linalool and linalool oxide production in transgenic carnation flowers expressing the *Clarkia breweri* linalool synthase gene. *Mol. Breeding* **2002**, *9*, 103–111.
- 84 Chen, D.H., Ye, H.C., Li, G.F. Expression of a chimeric farnesyl diphosphate synthase gene in *Artemisia annua* L. transgenic plants via *Agrobacterium tumefaciens*-mediated transformation. *Plant Sci.* **2000**, *155*, 179–185.
- 85 Sirikantaramas, S., Taura, F., Tanaka, Y., Ishikawa, Y., Morimoto, S., Shoyama, Y. Tetrahydrocannabinolic acid synthase, the enzyme controlling marijuana psychoactivity, is secreted into the storage cavity of the glandular trichomes. *Plant Cell Physiol.* **2005**, *46*, 1578–1582.
- 86 Sirikantaramas, S., Morimoto, S., Shoyama, Y., Ishikawa, Y., Wada, Y., Shoyama, Y., Taura, F. The gene controlling marijuana psychoactivity. Molecular cloning and heterologous expression of 1-tetrahydrocannabinolic acid synthase from *Cannabis sativa* L. *J. Biol. Chem.* **2004**, *279*, 39767–39774.

## Part 3

### Plants as Drug Factories



## 17

# Intellectual Property Protection of Plant Biotechnology

*Konrad Sechley and Clare Salisbury*

### 17.1

#### Introduction

Innovations directed to enhancing or augmenting plant production is a very active area of intellectual property protection. It is important that discoveries in this area be protected in order to secure economic returns for the intellectual and financial investment in research and development. Along with the rapid advances in this area of technology, the intellectual property protection of plant biotechnology and other biotechnology-related subject matter has undergone significant transformation. Several countries have needed to revise their legislation and modify their practice through case law as a result of the challenges posed by the rapid impact of this area of technology.

Plant-related subject matter can generally be protected using plant variety protection (plant breeders' right), utility patents and, in the USA, by a plant patent. Scientist need to be aware of the different requirements for securing a patent versus a plant breeders' right, as well as the scope of protection afforded by these different forms of protection. Further considerations arise as the type of protection available for plant-related inventions is not harmonized worldwide. For example, a plant cannot be protected by a utility patent in countries that do not allow patenting of higher life forms (HLFs), such as Canada. Furthermore, many countries in Europe exclude the patenting of plant varieties, whereas there is no such exclusion in the United States, and a plant variety may be co-protected by a patent or by a plant breeders' right. Although aspects of biotechnological innovation can also be protected by copyright, trademark, industrial design and trade secret, these forms of intellectual property protection are not discussed in this chapter. The protection of plant biotechnology has also been reviewed previously [1]. The present chapter provides an overview of the legislation and issues relating to protecting plant biotechnology, and current legal developments in this area.

## 17.1.1

**Utility Patents**

Plants and plant-related inventions may be protected using a regular (utility) patent. The scope of protection offered by a utility patent is broader than that available under plant variety protection; however, the cost of obtaining a patent is greater and the process more involved, than plant variety protection. Utility patents can apply to whole novel plants, and also to plant genes, methods for creating novel plants and novel applications for an existing plant. Many major jurisdictions permit the patenting of non-human HLFs including Europe, the US, Japan and Australia, with Canada being a notable exception.

A *patent* is an exclusive monopoly right that is granted to an inventor for a limited period of time, in return for a full and complete disclosure of the invention. The “bargain” theory lies at the heart of patent protection. The disclosure is the essence of the bargain between the inventor, who obtains a monopoly for the relevant period to exploit the invention, and the public, which obtains open access to all the information necessary to practice the invention. Patents are items of property, which may be assigned or licensed to another party.

A *patent owner* has the exclusive right during the life of the patent, to prevent others from working the invention without permission. Patent rights are therefore important tools for ensuring financial return to the effort made to bring the technology to a form that has industrial utility. However, having an exclusive right to the patented invention does not mean that the patent holder owns the technology. The patent holder obtains the right to exclude others from practicing the patented invention, but there is no “ownership” of the subject matter of invention itself. For example, having a patent to a transgenic plant does not mean that the patent holder owns the plant. Rather, the patent holder owns the right to exclude others from practicing the invention, or in this example, from growing the plant. As such, a patent does not result in the “ownership of life”.

The monopoly that is created by obtaining a patent is restricted to the country covered by the granted patent. In order to cover more than one jurisdiction, it is necessary to make separate applications to each country where a patent is required. Each application must be prosecuted through to grant in that particular jurisdiction before the patent owner can exclude others from working the invention. As a result of a difference in laws between countries relating to the type and scope of protection available to biotechnology-related inventions, it is common to obtain patents of different scope in different countries.

The grant of a patent does not give the owner the automatic right to commercialize the invention. The patent owner may not have “freedom to operate” in a particular jurisdiction due to other earlier patents in the field of the invention that are dominant and in force. Furthermore, regulations may be in place that prevent working of the invention until certain legal requirements are met. For example in Europe, marketing authorization from the European Commission must be obtained before a food product derived from a genetically modified organism can be brought to market [2].

## 17.1.2

**Trade-Related Aspects of Intellectual Property Rights (TRIPS)**

The standard for patent rights is outlined in the global intellectual property treaty agreement of Trade-Related Aspects of Intellectual Property Rights (TRIPS) [3]. Member countries of the World Trade Organisation (WTO) that have signed this agreement must ensure that the requirements stated in TRIPS are met in their own legislation. Article 27(1) of TRIPS states that “...patents shall be available for any inventions, whether products or processes, in all fields of technology, provided that they are new, involve an inventive step and are capable of industrial application.” [4]. However, member countries may exclude inventions on moral grounds, such as to protect human, animal or plant life or health, or to avoid serious prejudice to the environment. Other possible exclusions include plants and animals other than microorganisms; methods for the treatment of humans or animals; and essentially biological processes for the production of plants or animals other than non-biological and microbiological processes [5]. These exclusions are optional and vary from country to country. For example, the European Patent Convention (EPC) includes the exclusion from patentability of inventions that are considered contrary to “ordre public” or morality [6] as discussed below; whereas there is no such exclusion in other jurisdictions for example, USA, Canada, Australia and Japan. Additionally, as outlined below, HLFs, including plants and animals are patentable within the US, Europe, Australia and Japan, while Canada does not permit the patenting of HLFs.

Signatory countries to TRIPS must provide either patent protection for plants, or an alternate form of protection, for example plant variety protection, if the protection of a plant is not permitted [7]. An example of a global standard plant variety protection is set out within the Union Internationale pour la Protection des Obtentions Végétales (UPOV) Convention [8].

## 17.1.3

**Plant Variety Protection**

The UPOV Convention is a global agreement setting out a minimum standard for the protection of plant varieties, similar to that of TRIPS for patents. Member states that are signatories of UPOV must bring their legislation in compliance with the UPOV standard. Under UPOV, entities of one member state are permitted to apply for plant breeders’ rights in other signatory states. Over the past 25 or so years several versions of UPOV have emerged (UPOV 1978 and 1991). The two versions of UPOV are similar in that they provide protection to a plant variety, provided that variety is distinct from existing known varieties, it is uniform, stable, and novel. However, there are several significant changes in the 1991 Convention; for example, the definition of “propagating material” has been modified, and provisions relating to Farmers’ Rights governing the replanting of seed for personal use, have been specifically addressed in UPOV 1991.

Although plant variety protection meeting the standard set out under UPOV is accepted in over 50 countries, such protection has not been uniformly accepted,

and many countries with strong histories of farmers' privilege have yet to accede to the Convention [9]. There is also a continuing debate on the effect of plant variety protection and the use of Material Transfer Agreements (MTAs), on sharing and developing new plant germplasm [10]. However, MTAs may be used in the absence of plant variety or patent protection. Furthermore, providing plant variety protection does not imply that protected germplasm will not be made available for others to use.

UPOV 1978 provides an exclusive right to produce and offer for sale propagating materials of a plant variety, but the right does not extend to the harvested end product, for example a fruit. Furthermore, the right only pertains to a commercial end product, and not to non-commercial uses. As a result, replanting seed is implicitly allowed under UPOV 1978, leading to what has been known as "Farmers' Privilege". Also provided in the 1978 Convention was a breeders' exemption permitting the use of protected varieties as a germplasm source to develop new plant varieties.

The 1991 Convention introduced several significant amendments to UPOV. The duration of the breeder's right was extended to a minimum of 20 years for most plants, and to 25 years for vines and forest, fruit and ornamental trees. The number of plants genera and species that could be protected under UPOV was increased from a select list of specified plants in 1978, to all plants. Furthermore, the 1991 Convention provides the option to protect all aspects of the production and reproduction of a plant variety, including harvested material for example, grain, fruit and cut flowers. The scope of protection under UPOV 1991 includes production, conditioning, exporting, importing, and stockpiling the propagated material. The 1991 Convention permits a member State the right to include the protection of products of harvested material, for example flour, and juice. The protection of harvested material has the effect of removing Farmers' Rights from the Convention, as there is no longer a right to replant seed. However, the application of this provision is discretionary for each member State of UPOV [11], and a country can provide an exemption, or a partial exemption, in their laws to permit Farmers' Privilege. For example, Farmers' Privilege may be provided for all crop types, or this privilege may provide the farmer the right to save seed of only specified crop types.

Another important change pertains to providing protection to plant varieties that can be considered "essentially derived" from the protected variety. A plant that is "essentially derived" comprises the properties of a protected variety along with a minor change [12]. For example, introducing a gene using recombinant techniques into a protected plant variety may not be sufficient to exceed the "essentially derived" criteria unless the gene alters the variety in a significant manner [13].

The UPOV 1991 Convention also provides a grace period of up to one year for registering a plant variety that had otherwise been sold prior to applying for protection with a UPOV member country. Under the 1978 Convention, no such grace period was provided. Provisional protection of a variety must also be provided within member countries that are signatories to 1991 UPOV. Provisional protection ensures that a variety remains protected during the time while an application is pending provided that the variety is not sold prior to obtaining variety registration. Compulsory exemptions to variety protection are also provided in UPOV 1991. These

exemptions include use of a protected variety for private and non-commercial purposes, for experimental purposes, and for breeding other varieties.

#### 17.1.4

##### **Genetic Resources**

On June 29 2004, the “International Treaty on Plant Genetic Resources for Food and Agriculture” (also referred to as The International Seed Treaty) came into force [14]. To date, the Treaty has been ratified by 72 countries, including Canada, the United Kingdom, and the European Community. Notable exceptions of countries that have not yet ratified or accepted this Treaty include Australia, Brazil, Japan, and the US. This Treaty aims to ensure that the raw materials used to develop new crop varieties remain publicly available. In so doing, the Treaty promotes the conservation of plant genetic resources for food and agriculture. This Treaty is directed at ensuring farmers’ rights, and at developing a Multilateral System that comprises an aggregate of genetic material from the member countries so that members may, by paying a fee, have access to the genetic material. The preamble to the Treaty states that “...nothing in this Treaty shall be interpreted as implying in any way a change in the rights and obligations of the Contracting Parties under other international agreements.” However, there is a debate as to whether the treaty will remain subordinate to TRIPS and UPOV. The text of the Treaty has been interpreted to indicate that farmers’ rights are restricted by national intellectual property laws [15].

In an effort to ensure access to genetic resources and equal benefit sharing, a new disclosure requirement, to be made within patent law, is being considered by member states of the WTO. The Convention on Biological Diversity (CBD), which was adopted in 1992, and now comprises 168 signatory countries, included reference to the recognition of access and equitable benefit sharing of genetic resources, and recognized that a country has sovereignty over its own genetic resources. Therefore, a country may control access to a genetic resource under mutually agreed upon terms [16]. A “genetic resource” has been broadly defined within Article 2 of the CBD to include any material of plant, animal, microbial or other origin containing functional units of heredity, and having actual or potential value. This Convention provides the option of a member state to require disclosure of the source (i.e. the actual source, including the country, or gene-bank from which the material was obtained), source of origin (the source country), and legal provenance (the origin and the chain of custody of the sample) of a genetic resource within a patent application [17].

Current patent laws of the US, Canada, Europe, Japan, and Australia do not require that the source, source or origin, or legal provenance of a genetic material to be stated within a patent application. The disclosure requirement being discussed would require an applicant to disclose the source of any genetic resource used to make a claimed invention, along with evidence of prior informed consent that the genetic resources were obtained according to mutually agreed upon terms within their patent application. It is proposed that failure to satisfy this proposed disclo-



sure requirement would result in rejection of the application or invalidation of the resulting patent [18]. This proposal has received strong opposition [19].

## 17.2

### Protection of Plant Biotechnology in Europe

Plant varieties are protectable in Europe under the Community Plant Variety Right or through national Plant Breeders' Rights. Plants that are not a plant variety, and other plant-related inventions may be protected as a patent. A patent may be granted under the European Patent Convention (EPC), and this patent validated within the desired member countries. The enforceability of a granted European patent, is governed by the national laws of each individual contracting state where the European patent is validated. Alternatively, an application for patent may be filed and granted directly within a desired European country.

The Council of the European Union (EU) established the Community Plant Variety Right (CPVR) to provide a single plant breeders' right, which extends throughout the EU and is processed centrally by the Community Plant Variety Office in Angers, France [20]. The CPVR is based on the provisions of the 1991 UPOV Convention, protecting varieties generated by traditional breeding or through genetic engineering provided they comply with the internationally recognized requirements of distinctness, uniformity, stability, and novelty [21]. A CPVR application can be submitted and processed in the official language of any of the EU Member States [22]. Once a CPVR is granted, it is valid throughout the EU for a maximum duration of 25 years, or 30 years for vines, trees and potatoes, provided that annual renewal fees are paid [23]. Under the CPVR system, Member States may continue to grant national plant variety rights [24]; however, the applicant must choose between national and Community rights as cumulative protection for the same variety is prohibited [25].

#### 17.2.1

##### Patent Protection: European Patent Convention (EPC)

The EPC came into force in 1973 and now includes 31 contracting states and five extension states, thus covering most of Europe, with Norway being a notable exception. The EPC was created to provide a single European procedure before the European Patent Office (EPO) for the grant of patents, on the basis of a uniform body of substantive patent law in order to provide easier, cheaper and stronger protection for inventions in the contracting states.

When the EPC was drafted, the UPOV Convention, as adopted in 1961, imposed a ban on the dual protection of the same invention by both the plant breeder rights system and the patent system [26]. As such, Article 53(b) EPC was incorporated to exclude patents for plant and animal varieties and essentially biological processes for the production of plants and animals [27]. The ban on dual protection has since been removed in the revised 1991 UPOV Convention; however, the exclusion from

patentability of plant varieties remains in the EPC. This is in contrast to the situation in USA, where dual patent and plant breeders' rights protection for plant varieties is available.

The extent of the exclusion of plant varieties under Article 53(b) EPC was in question in a decision of the Technical Board of Appeal issued in 1983 [28]. The case related to a chemical treatment of propagating material (e.g., seeds) for plants in order to make the plants resistant to agricultural chemicals, such as herbicides. In allowing the patent, the Board of Appeal held that even though the claims included within their scope propagating material for all kinds of cultivated plants and known plant varieties that had received the defined chemical treatment, the subject-matter of the claims was not an individual variety, and there was therefore no contravention of Article 53(b) EPC.

A related case concerning animal varieties rather than plant varieties, was issued by the Technical Board of Appeal in 1990 on the Harvard mouse application [29]. The invention related to the genetic treatment of animals for the purpose of cancer research, and the application included claims to animals that had been so treated. The Examining Division of the EPO rejected the application, concluding that although the wording of Article 53(b) EPC excluded "animal varieties" from patentability, the intention of the legislator had been to exclude animals in general from patentability. The Board of Appeal disagreed and held that the term "animal varieties" in Article 53(b) EPC did not have the effect of excluding "animals as such" from patentability and the application was referred back to the Examining Division for further examination, with the result that the patent issued. The patent was then opposed and a final decision was not rendered until July 2004, where the patent was allowed with claims restricted to a rodent.

Confusion arose following a case concerning a patent granted to Plant Genetic Systems (PGS), which included claims to a genetically modified plant that was resistant to a herbicide. In keeping with the Harvard decision, which concluded that HLFs are patentable, the PGS patent was allowed. The issued patent was opposed, but found acceptable by the Opposition Division. However, the Opposition Division's decision was appealed and the decision reversed, with the Technical Board of Appeal holding that a product claim which embraced "plant varieties" was not patentable under Article 53(b) EPC [30]. In the description of the PGS patent, a number of working examples were given showing that plants so transformed display normal fertility, and that the characteristic of herbicide resistance is transmitted in a stable manner to second-generation seedlings. The Technical Board of Appeal concluded that "...the transformed plants or seeds of the working examples, irrespective of whether they would meet the conditions for the grant of a breeder's right, are plant varieties as they comply with the definition of the concept of 'plant varieties' being distinguishable, uniform and stable in their relevant characteristics." The term "plant variety" was therefore construed broadly by the Technical Board of Appeal to include plants that had been genetically modified, and the claims were disallowed.

The PGS decision appeared to be in conflict with previous case law relating to the Harvard decision, prompting the President of the EPO to refer a question to the

Enlarged Board of Appeal, the highest Court in the European patent system, for review. The question asked “Does a claim which relates to plants or animals but wherein specific plant or animal varieties are not individually claimed contravene the prohibition on patenting in Article 53(b) EPC if it embraces plant or animal varieties?” [31]. In its opinion dated November 1995, the Enlarged Board of Appeal concluded that there was no conflict between the PGS decision and the earlier decisions, because in the PGS decision, claims to the genetically modified plant were held to be contrary to Article 53(b) EPC – not because the claim embraces known plant varieties, but because the claimed genetic modification of a plant itself makes the modified or transformed plant a new “plant variety” within the meaning of the revised UPOV Convention, 1991 and Article 53(b) EPC. As it was concluded that no conflict arose, the question referred by the President was held to be inadmissible and no clarification was forthcoming. It was not until December 20, 1999 upon issue of a decision of the Enlarged Board of Appeal relating to a patent application belonging to Novartis AG [32], that the question was finally answered, providing much sought-after clarification as to the scope of patent protection available for plant biotechnology inventions in Europe.

The Novartis application related to the control of plant pathogens in agricultural crops and included claims to transgenic plants that are able to kill or inhibit the growth of pathogens. The claims were initially refused by the Examining Division of the EPO in keeping with the PGS decision. The Technical Board of Appeal however requested clarification from the Enlarged Board of Appeal asking a similar question to the one referred to the Enlarged Board of Appeal by the President of the EPO in the PGS case.

The Novartis case generated a great deal of public interest. Statements in favor of the patentability of transgenic plants were filed by professional groups, such as the Chartered Institute of Patent Attorneys, and Industry groups such as the European Crop Protection Association, as well by companies active in the field of plant breeding, including PGS and Monsanto. Conversely, individuals and groups committed to the protection of the environment or animals filed over 600 letters voicing their concerns about the patenting of HLFs.

In contrast to the finding of the Technical Board of Appeal in the PGS decision, the claims in Novartis were determined to cover plants which may or may not belong to a plant variety, and it was held that the claimed invention was neither limited, nor directed, to a plant variety or varieties [33]. The Enlarged Board of Appeal concluded that when the legislation was drafted, the purpose of Article 53(b) EPC was to prevent European patents being granted for subject matter for which the grant of patents was excluded under the ban on dual protection in the UPOV Convention 1961. Accordingly, inventions ineligible for protection under the plant breeders’ rights system were intended to be patentable under the EPC, provided they fulfilled the other requirements of patentability. The Board concluded that for a typical genetic engineering invention, the inventor bestows a desired property on plants by inserting a gene into the genome of those plants. It is the contribution of the inventor in the genetic field that makes it possible to insert the gene into the genome of any appropriate plant or plant variety. This contrasted to plant breeding,

where a suitable plant is selected for the purpose of arriving at a specific, marketable plant variety, and this may be rewarded by obtaining a plant breeders' right. The inventor in the genetic engineering field would not obtain appropriate protection if they were restricted to specific varieties, because the development of specific varieties would not be in their field of activity. The inventor would be limited to a few varieties, even though means for inserting the gene into all appropriate plants would be provided. In conclusion, it was held that "A claim wherein specific plant varieties are not individually claimed is not excluded from patentability under Article 53(b) EPC, even though it may embrace plant varieties" [34]. However a new plant variety bred as a result of genetically modifying a particular plant variety is still excluded from patent protection, even if the genetic modification is the result of a biotechnological process [35]. Following this landmark decision, the EPO began to process some 1200 applications for patents on genetically altered animals and plants that had been on hold since the PGS decision in 1995 [36].

### 17.2.2

#### **Biotechnology Directive**

In an effort to clarify the law regarding the patenting of biotechnology inventions, Directive 98/44/EC of the European Parliament and of the Council (Biotech Directive) [37] was adopted in July 1998 after a 10-year debate. The Biotech Directive contains a number of provisions, including the exclusion from patentability of plant and animal varieties and essentially biological processes for the production of plants and animals.

One of the aims of the Biotech Directive was to harmonize the differences that exist in the laws of the Member States of the EU regarding patent protection of biotechnology inventions. As such, each Member State was required to incorporate the provisions of the Biotech Directive in its national law by July 30, 2000. Implementation was met with fierce political opposition, mainly due to ethical concerns regarding the patenting of human genes, and most countries failed to fulfill the implementation requirements by the set deadline. In July 2003, the European Commission referred eight Member States to the European Court of Justice (ECJ), for failure to fully implement the Biotech Directive into their national law [38]. Many of these countries have now implemented the Biotech Directive into their national law to avoid the impending fine if the ECJ found them guilty. To date, however, four Member States have still not implemented the Directive [39] and the desired harmonization between the Member States remains elusive.

An amended version of the EPC, implementing the pre-grant provision of the Biotech Directive came into force on September 1, 1999 [40], just before issue of the Novartis decision by the Enlarged Board of Appeal, who interestingly chose not to rely on these provisions, and instead based their decision on first principles. However, in harmony with the Novartis decision, under introduced Rule 23c(b) EPC, inventions that are directed to plants or animals are patentable if the technical feasibility of the invention is not confined to a particular plant variety [41]. The definition of a "plant variety" in Rule 23b(4) EPC corresponds with that given in the

UPOV Convention. Furthermore a process for the production of plants or animals is patentable provided it does not consist entirely of natural phenomena such as crossing or selection in accordance with introduced Rule 23b(5) EPC.

With implementation of the Biotech Directive, the amended EPC also incorporated new rules clarifying what is and what is not patentable with respect to nucleic acid sequences. Rule 23e EPC states that a sequence or partial sequence of a gene, is patentable in Europe even if it previously occurred in Nature, provided that the sequence is isolated or otherwise produced by means of a technical process and the industrial application of the sequence is disclosed in the patent application as filed.

The Biotech Directive also deals with the scope of protection afforded by patents to biological material. Unlike other inventions, once a third party has legitimate possession of a patented biological material it is easy to produce more of such material by propagation or multiplication [42]. Under the Biotech Directive the scope of patent protection extends to the production of such reproduced material, including all material in which patented genetic information is incorporated, such as seeds [43]. This ensures that the patentee receives adequate remuneration for his or her invention, otherwise a third party would have no need to buy more of a biological material covered by a patent after the initial sale. One exception to this is a farmers' privilege defined in Article 11 of the Biotech Directive that authorizes a farmer who has bought patented plant propagating material, to use the product of his or her harvest for propagation or multiplication by him/her on his/her own farm. As this part of the Biotech Directive deals with post-grant issues, it has not been incorporated into the EPC, and implementation into national patent law of the EU Member States is required.

### 17.2.3

#### **Ethics of Patenting Plant Biotechnology**

Article 53(a) EPC excludes from patentability "...inventions the publication or exploitation of which would be contrary to 'ordre public' or morality, provided that the exploitation shall not be deemed to be so contrary merely because it is prohibited by law or regulation in some or all of the Contracting States." [44]. According to the Technical Board of Appeal, "...inventions the exploitation of which is likely to breach public peace or social order (for example, through acts of terrorism) or to seriously prejudice the environment are to be excluded from patentability as being contrary to 'ordre public'," and "...inventions the exploitation of which is not in conformity with the conventionally-accepted standards of conduct pertaining to this culture are to be excluded from patentability as being contrary to morality." [45]. Furthermore, "...approval or disapproval of the exploitation by national law(s) regulation(s) does not constitute per se a sufficient criterion for the purposes of examination under Article 53(a) EPC." [46]. There is no general exclusion of living animals on morality grounds, and the question of whether a claimed invention constitutes an exception to patentability within the meaning of Article 53(a) has to be answered in each particular case on its merits [47].

In assessing whether or not claims to a herbicide-resistant genetically modified plant in the PGS case should be excluded under Article 53(a) EPC, the Technical Board of Appeal found that none of the claims refer to subject-matter which relate to a misuse or destructive use of plant biotechnological techniques, because they concern activities which cannot be considered to be wrong as such in the light of conventionally accepted standards of conduct of European culture. The Board also found that it would be unjustified to deny a patent under Article 53(a) EPC merely on the basis of possible, not yet conclusively documented hazards to the environment. Rather, the assessment of the risks involved should be carried out by a competent regulatory body. If regulatory approval is given, based on the finding that no risks or minimal risks are involved, then patent protection should be available [48].

The issue of excluding patents on moral grounds is highly controversial, especially in the biotechnology field. The patent right is an exclusionary right, not a right to produce. Many patents are issued for products and processes that are regulated. For example, a new drug can be patented, but before it is released its safety and efficiency must be established through extensive clinical trials to obtain approval from the appropriate regulatory body [49]. Similar regulatory approvals apply to inventions relating to methods or products in the nuclear sector. On the one side it is argued that the patent system is not the proper forum for regulating or restricting innovation in areas deemed unethical or immoral, and that placing ethical oversight into the hands of individual patent examiners is likely to cause greater inconsistency in biotechnology patents, not only internationally, but also within jurisdictions. However, opponents of patents relating to living organisms argue that if these patents can be stopped then so would the research itself, because there would be no certain money to be made out of it [50]. From case law, it appears that the EPO is generally taking the view that patents covering genetically modified plants are not excluded from patentability on moral grounds; however, the particular facts of each case need to be examined to determine whether in light of those facts the case ought to stand [51].

## 17.3

### North America

There are several options for protecting plant-based inventions within the US. These include plant variety protection, a plant patent, and a utility patent. In Canada, only plant variety protection is available as a result of recent Supreme Court decision (see below) that concluded that HLFs are non-patentable subject matter.

#### 17.3.1

##### US Plant Patent

A plant patent is a unique form of protecting plant-related subject matter in the US. A US plant patent is available for a plant that reproduces through asexual reproduction, but does not include a tuber-propagated plant [52]. This is to be con-

trusted with plant variety protection that is directed to plants that reproduce sexually. Although not a common form of plant protection, a plant patent is used to protect ornamental and fruit-producing trees, roses, poinsettias, strawberries and other plants reproduced asexually. The duration of a plant patent is 20 years from the priority date or the date of filing. A plant patent is different from a regular utility patent in that it comprises one claim, and this claim is directed to the entire plant. The scope of protection of a plant patent is limited to the specific plant described in the specification. In this manner, the scope of protection of a plant patent is similar to that of plant variety protection.

The applicant of a plant patent is provided with a one-year grace period prior to filing for a plant patent. An application for a plant patent may be rejected if a plant breeders' right publication occurs one year before filing of a corresponding plant patent application when combined with a foreign offer for sale [53]. A UPOV-based disclosure itself may not be an enabling disclosure. For example, in *Re LeGrice* [54], publication of a picture of a rose was considered not to be an enabling public disclosure as no methods relating to the procedure for grafting the rose were indicated. This is to be contrasted with *Ex parte Thomson* [55], where it was found that cotton seed, publicly available for more than one year prior to application for a plant patent, placed one of skill in possession of the invention. The recent decision in *Re Elsner* further defines the prior art bar for a plant patent. It is stated in this decision "...that the foreign sales of the Pendec geranium and the JA Copper rose are not themselves...prior art against the applications; that is those foreign sales themselves do not constitute an on-sale bar." However, "...[w]hen a publication identifies the plant that is invented or discovered and a foreign sale occurs that puts one of ordinary skill in the art in possession of the plant itself...that combination of facts and events so directly conveys the essential knowledge of the invention that the sale combines with the publication to erect a statutory bar." [56].

### 17.3.2

#### Utility Patents

##### 17.3.2.1 USA

As a result of the 1980 landmark decision in *Chakrabarty* [57], patents to any non-human life forms, including single-cell, multi-cellular and HLFs made by the hand of man, are allowable in the US. Furthermore, the US Supreme court decision of *J.E.M. AG Supply* [58] confirmed that utility patent protection is valid for plants, even if the plant is protected using plant variety, or by plant patent, and that a utility patent offers a scope of protection that is broader than that available under plant variety protection. As noted above, a farmer saving and replanting seed, and a breeder producing a new variety, may do so without infringing a plant variety certificate. However, if the plant is protected by a utility patent, the patent owner or licensee of the patent has the right to exclude the making, using or selling of the patented plant or seed, and may require a user to re-purchase seed for each planting.

### 17.3.2.2 Canada

The issue of HLF protection in Canada was recently brought to the Supreme Court with a 5-4 split decision in *Harvard* [59]. Even though the Court of Appeal of Canada found the patenting of HLFs to be acceptable, concluding that an animal was a composition of matter, the Supreme Court ruled that in Canada an HLF is not patentable. The Supreme Court held that an HLF is not a “manufacture” or “a composition of matter” as required under Section 2 of the *Canadian Patent Act*, and as such cannot be patented. The majority opinion argued that the *Canadian Patent Act* does not clearly indicate that HLFs are patentable and that it is not designed to address higher life forms. HLFs are allowable in other countries, including the US, Japan, Australia and New Zealand, and reference to this fact was made in the dissenting opinion in *Harvard*. It is also noted in the dissenting opinion that the definition of invention in Canada reads almost word-for word as the definition of invention in the US as provided in 35 U.S.C. Section 101. Interestingly, the wording in 35 U.S.C. Section 101 was reviewed by the US Supreme Court in *Chakrabarty* and found to be consistent with the patentability of life forms. The *Harvard* decision placed Canada out of step with other Western jurisdictions with respect to the patenting of HLFs.

The majority in *Harvard* argued that even though a genetically altered egg was prepared by the hand of man, and inserted within the mouse, “...the process by which a fertilized egg becomes an adult mouse is a complex process, elements of which require no human intervention.” [60]. A similar argument permeated the Trial decision, and has surface in earlier jurisprudence relating to the patentability of HLFs in Canada, where it was stated that “[t]he courts have regarded creations following the laws of nature as being mere discoveries the existence of which man has simply uncovered without thereby being able to claim he has invented them.” [61]. The Court of Appeal in *Harvard* tempered the argument somewhat, suggesting that laws of nature and human ingenuity may be combined, “...the oncomouse must be considered to be the result of both ingenuity and the laws of nature – ingenuity in the initial genetic engineering involving the assembly of the oncogene, incorporating it into the plasmid and injecting the plasmid into the zygote; and the laws of nature, with the oncogene then affecting all the cells of the oncomouse in the course of gestation, the subsequent mating of an oncomouse and an uninjected mouse, and the reliance on Mendelian laws of inheritance to obtain offspring oncomice. However, the use of the laws of nature by inventors does not disqualify a product from being an invention, provided inventiveness or ingenuity is also involved.” [62]. However, this position was refuted by the Canadian Supreme Court in *Harvard*.

An argument that relies on the laws of Nature can also apply to invention directed to lower life forms or other areas of technology. For example, a cell is a synergistic combination of many complex processes, and the process of introducing a gene within the cell relies on laws of Nature in combination with an appropriate mixture of ingredients and conditions as set by a researcher. Once these conditions are set, the transformation process requires no human intervention and takes place ac-



ording to the laws of Nature. Taken a step further, any process that incorporates the laws of Nature – and therefore functions in the absence of human intervention – could be held non-patentable, including for example a chemical reaction. However, the oncomouse in *Harvard* would not exist in the absence of human intervention.

An argument is made in *Harvard* that the patenting of HLFs raises special issues that need to be considered, as HLFs are living and self-replicating [63]. However, this argument applies equally to all life forms, and not just HLFs, and fails to indicate why the court placed an arbitrary line between higher and lower life forms. The court also argued that “... micro-organisms are produced ‘*en masse* as chemical compounds are prepared, and are formed in such large numbers that any measurable quantity will possess uniform properties and characteristics’. The same cannot be said for plants and animals.” [64]. The suggestion that only cultured cells may be produced in a uniform manner is also open to criticism, as the production of plant-made pharmaceutical products requires a uniform, consistent product for regulatory approval similar to that produced using cell or bacterial systems [65].

It would appear that an underlying reason for the majority opinion in *Harvard* is due to the ethical and environmental concerns that would arise if HLFs were considered patentable, and this theme surfaces repeatedly throughout the decision [66]. However, whether or not a higher life can be patented does not limit the use or production of the life form in Canada or any other jurisdiction. If use of this technology is of concern, then other legislative mechanisms need to be applied or developed. The use of the Patent Act as a forum for instituting social policy is awkward at best.

It is also suggested in *Harvard* that another legislative scheme, for example one similar to the Plant Breeders’ Rights Act, may be used to protect HLFs [67]. This suggestion is of concern since the scope of protection offered through Plant Breeders’ Rights is much less than that offered by patent. This position is also in contrast to the position put forth in the US and discussed above in *J.E.M. AG Supply*, where alternative forms of protection may be simultaneously used to protect a HLF. The suggestion in *Harvard* that Plant Breeders’ Rights provides adequate protection to the Rights holder again highlights the reduced strength of protection of biotechnology-related subject matter available in Canada when compared to the US or Europe. However, a second recent decision by the Supreme Court in Canada, *Schmeiser* [68], suggests that patent protection of a plant in Canada may be obtained even in the absence of claims to the plant itself.

Schmeiser admitted to growing glyphosate-resistant canola on his land, yet he had never purchased any of the seed. Monsanto obtained a patent with claims directed to a chimeric plant gene encoding EPSP synthase, a glyphosate-resistant plant cell, and methods for producing a glyphosate-resistant plant [69]. However, there are no claims to a plant in the Monsanto patent. Rather than remove the seed from his property, Schmeiser saved and reused the seed without paying a required license fee to Monsanto. He noted that the seed was not used for its intended purpose as herbicide was not applied to the crop. However, he did save and replant the seed year to year.

In *Schmeiser* the court stated that they were not concerned with the discovery of volunteer or blow-by plants in fields, nor were they concerned with the social utility of the genetic modification of genes and cells; rather, the decision was concerned with whether the patent issued to Monsanto was valid, and if valid was it infringed.

The court concluded that growing canola containing a patented cell and gene without license or permission was an infringement of Monsanto's patent. This decision is important in view of the earlier Supreme Court Decision in *Harvard*, where the same court just 18 months previously had ruled that a genetically altered mouse was not patentable in Canada. It was found that Schmeiser did not make the invention; therefore, it was questioned whether collecting, saving, and replanting seed was a use of the patented gene and a cell. The majority opinion stated that when one "...manufactures, seeks to use, or uses a patented part that is contained within something that is not patented, provided the patented part is significant or important." Then that it is an infringement [70].

The patented genes and cells are an important part of the plant as they make up the plant. The court proposed the following analogy, that "...[t]he patented genes are present throughout the genetically modified plant and the patented cells compose its entire physical structure... In that sense, the cells are somewhat analogous to Lego blocks: if an infringing use were alleged in building a structure with patented Lego blocks, it would be no bar to a finding of infringement that only the blocks were patented and not the entire structure. If anything, the fact that the Lego structure could not exist independently of the patented blocks would strengthen the claim, underlining the significance of the patented invention to the whole product, object, or process." [71].

The conclusion reached in *Schmeiser* limits the effect of *Harvard*, as protection for biological subject matter that has been genetically altered is available in Canada. However, this decision is only a part fix, and as suggested by the Supreme Court in *Harvard*, patent protection of higher life forms needs to be reviewed and clarified by the Canadian Parliament.

## 17.4 Conclusion

Although the protection of plant-related subject matter is available in many jurisdictions, the scope of protection varies from country to country. Plant variety protection may be obtained in most countries for a specific variety of plant, provided that the plant exhibits traits that are distinct, uniform, and stable. Broader protection relating to a plant may be obtained in many countries through a utility patent. For example, patent protection may be obtained for methods of producing a transgenic plant comprising a novel genetic construct, or the novel genetic construct itself may be patentable. In most western jurisdictions a novel transgenic plant is also patentable. However, a novel transgenic plant is not patentable subject matter in Canada. Even so, a plant may be protectable in Canada by patent, provided that it

comprises a patented gene or cell. In Europe, a plant may be protected by either patent or by plant variety protection, but not both. However, both systems may be used in the US. Furthermore, the US also provides a unique method for protecting asexually reproducing plants through a plant patent.

## References

- 1 Sechley, K., Schroeder, H. Intellectual Property Protection of Plant Biotechnology Inventions, *Trends Biotechnol.* 2002, 20, 456–461; and Fleck, B., Baldock, C. Intellectual property protection for plant biotechnology inventions in Europe. *Nat. Rev. Gen.* 2003, 4, 834–838.
- 2 Regulation (EC) No 1829/2003 of the European Parliament and of the Council of 22 September 2003 on Genetically Modified Food and Feed. *Official Journal of the European Union* 2003, L268, 1–23.
- 3 Agreement on Trade Related Aspects of Intellectual Property Rights (TRIPS). *World Intellectual Property Office Publication No. 223(E)*, 1996.
- 4 Article 27(1) TRIPS.
- 5 Article 27(3) TRIPS.
- 6 Article 53(a). Convention on the Grant of European Patents (European Patent Convention; EPC). 11th edition. *European Patent Office Publication*, 2002.
- 7 Article 27(3)(b) TRIPS.
- 8 Union International pour la Protection des Obtentions Végétales (UPOV) International Convention for the Protection of New Varieties of Plants of December 2, 1961, as revised in Geneva on November 10, 1972, on October 23, 1978, and on March 19, 1991. UPOV Publication No. 221(E).
- 9 <http://allafrica.com/stories/200205090709.html>.
- 10 Price, S.C. Public and private plant breeding. *Nat. Biotech.* 1999, 17, 938.
- 11 Article 15: UPOV, 1991.
- 12 Article 14 UPOV, 1991.
- 13 Article 14 (5)(c) UPOV, 1991.
- 14 <http://www.fao.org/ag/cgrfa/news.htm>.
- 15 [www.ukabc.org/iju2.htm](http://www.ukabc.org/iju2.htm);  
[www.ukabc.org/itpgrfa29june2004.htm](http://www.ukabc.org/itpgrfa29june2004.htm).
- 16 Article 15, Convention on Biological Diversity (CBD), June 5, 1992; <http://www.biodiv.org/convention/articles.asp>.
- 17 Articles 15(3) and 16 (3), CBD, 1992.
- 18 WTO Document WTO/IP/C/W/257. See also Sheridan, C. *Nat. Biotech.* 2005, 23, 511.
- 19 Keating, D. Access to genetic resources and equitable benefit sharing through a new disclosure requirement in the patent system: an issue in search of a forum. *Journal of the Patent and Trademark Office Society* 2005, July, 525–547 (see <http://www.jptos.org/>)
- 20 Council Regulation (EC) No. 2100/94 of 27 July 1994 on Community Plant Variety Rights. *Official Journal of the European Union* 1994, L227, 1–30.
- 21 Article 6. Council Regulation (EC) No. 2100/94 of 27 July 1994 on Community Plant Variety Rights (CPVR). *Official Journal of the European Union* 1994, L227, 1–30.
- 22 Article 34. CPVR, 1994.
- 23 Notes for Applicants. Official Website of the Community Plant Varieties Office (Last update June 4, 2004) <http://www.cpvo.eu.int/documents/infod/infodden.pdf>.
- 24 Article 3. CPVR, 1994.
- 25 Article 92. CPVR, 1994.
- 26 Article 2.1. UPOV, 1961.  
<http://www.upov.int/en/publications/conventions/1961/act1961.htm>
- 27 Article 53(b) EPC, 2002.
- 28 European Patent Office. Decision of the Technical Board of Appeal T 0049/83. *Official Journal of the European Patent Office* 1984, 112.
- 29 European Patent Office Decision of the Technical Board of Appeal T 0019/90, Harvard mouse. *Official Journal of the European Patent Office* 1990, 476.
- 30 Paragraph 24. European Patent Office Decision of the Technical Board of Appeal T 0356/93, Plant Genetic Systems. *Official Journal of the European Patent Office* 1995, 545.

- 31 European Patent Office Decision of the Enlarged Board of Appeal G 3/95, Plant Genetic Systems. *Official Journal of the European Patent Office* **1996**, 169.
- 32 European Patent Office Decision of the Enlarged Board of Appeal G 1/98, Novartis. *Official Journal of the European Patent Office* **2000**, 3, 169.
- 33 Paragraph 3.1. European Patent Office Decision of the Enlarged Board of Appeal G 1/98, Novartis. *Official Journal of the European Patent Office* **2000**, 3, 169.
- 34 Headnote 1. European Patent Office Decision of the Enlarged Board of Appeal G 1/98, Novartis. *Official Journal of the European Patent Office* **2000**, 3, 169.
- 35 Paragraph 5.3. European Patent Office Decision of the Enlarged Board of Appeal G 1/98, Novartis. *Official Journal of the European Patent Office* **2000**, 3, 169.
- 36 Schiermeier, Q., Dickinson, D. Europe lifts patent embargo on transgenic plants and animals. *Nature* **2000**, 403, 3.
- 37 Directive 98/44/EC of the European Parliament and of the Council of 6 July 1998 on the Legal Protection of Biotechnological Inventions. *Official Journal of the European Patent Office* **1999**, 2, 101–119.
- 38 Press Release of the European Commission IP/03/991 July 10, **2003**.
- 39 Press Release of the European Commission IP/05/960 July 18, **2005**.
- 40 Notice dated 1 July 1999. *Concerning the Amendment of the Implementing Regulations to the European Patent Convention* **1999**, 8-9, 573–582.
- 41 Rule 23c(b) EPC, **2002**.
- 42 Wood, D. European patents for biotechnological inventions – past, present and future. *World Patent Information* **2001**, 23, 346.
- 43 Articles 8 and 9. Directive 98/44/EC of the European Parliament and of the Council of 6 July 1998 on the Legal Protection of Biotechnological Inventions. *Official Journal of the European Patent Office* **1999**, 2, 101-119.
- 44 Article 53(a). EPC, **2002**.
- 45 Paragraphs 5–6. European Patent Office Decision of the Technical Board of Appeal T 0356/93, Plant Genetic Systems. *Official Journal of the European Patent Office* **1995**, 545.
- 46 Paragraph 7. European Patent Office Decision of the Technical Board of Appeal T 0356/93, Plant Genetic Systems. *Official Journal of the European Patent Office* **1995**, 545.
- 47 Paragraphs 11 and 13. European Patent Office Decision of the Technical Board of Appeal T 0356/93, Plant Genetic Systems. *Official Journal of the European Patent Office* **1995**, 545.
- 48 Paragraphs 17.3 and 18.7. European Patent Office Decision of the Technical Board of Appeal T 0356/93, Plant Genetic Systems. *Official Journal of the European Patent Office* **1995**, 545.
- 49 Perry, M. Lifeform Patents: the high and the law. *J. Int. Biotech. Law* **2004**, 1, 20–27.
- 50 Wood, D. European patents for biotechnological inventions – past, present and future *World Patent Information* **2001**, 23, 340.
- 51 Paragraph 13. European Patent Office Decision of the Technical Board of Appeal T 0356/93, Plant Genetic Systems. *Official Journal of the European Patent Office* **1995**, 545.
- 52 35 U.S.C. Section 161 Plant Patents.
- 53 In re Wilhelm Elsner, No. 03-1569 and In re Keith W. Zary, No. 03-1585, CAFC August 16, **2004**.
- 54 In re LeGrice, (**1962**) 301 F.2d 929, USPQ133(2d):365-378.
- 55 Ex parte Thomson Norman J.P. Thomson, (**1992**) BPAI-USPTO Appeal No. 92-0384.
- 56 In re Wilhelm Elsner, No. 03-1569 and In re Keith W. Zary, No. 03-1585, (**2004**) CAFC.
- 57 *Diamond v. Chakrabarty*, (**1980**) USSC 447 U.S. 303, No. 79-136.
- 58 *J. E. M. AG Supply, Inc., dba Farm Advantage, Inc., et al. v. Pioneer Hi-Bred International, Inc.* (**2001**) USSC No. 99-1996.
- 59 *President and Fellows of Harvard College v. Commissioner of Patents* (**2002**) 7 C.P.R. (4th) 1, Reversing 79 C.P.R. (3d) 98; SCC 76. File No. 28155.
- 60 *President and Fellows of Harvard College v. Commissioner of Patents* (**2002**) 7 C.P.R. (4th) 1, Reversing 79 C.P.R. (3d) 98; SCC 76. File No. 28155, para. 162.
- 61 *Pioneer Hi-Bred v. Com of Patents* (1989), 25 C.P.R. (3d) 257 [62]

- Commissioner of Patents v. President and Fellows of Harvard College (2000), 7 CPR (4th) 1.
- 63 President and Fellows of Harvard College v. Commissioner of Patents (2002) 7 C.P.R. (4th) 1, Reversing 79 C.P.R. (3d) 98; SCC 76. File No. 28155, para. 167.
- 64 President and Fellows of Harvard College v. Commissioner of Patents (2002) 7 C.P.R. (4th) 1, Reversing 79 C.P.R. (3d) 98; SCC 76. File No. 28155, para. 202.
- 65 [www.fda.gov/cber/](http://www.fda.gov/cber/).
- 66 President and Fellows of Harvard College v. Commissioner of Patents (2002) 7 C.P.R. (4th) 1, Reversing 79 C.P.R. (3d) 98; SCC 76. File No. 28155, para. 155, 166.
- 67 President and Fellows of Harvard College v. Commissioner of Patents (2002) 7 C.P.R. (4th) 1, Reversing 79 C.P.R. (3d) 98; SCC 76. File No. 28155, para. 194.
- 68 Schmeiser et al. v. Monsanto Canada Inc., et al., (2004) 31 C.P.R. (4th) 161-209; SCC 34. File No. 29437.
- 69 Canadian Patent 1,313,830 Glyphosate-Resistant Plants to Monsanto Technology LLC, issued February 23, 1993.
- 70 Schmeiser et al. v. Monsanto Canada Inc., et al., (2004) 31 C.P.R. (4th) 177, para. 42.
- 71 Schmeiser et al. v. Monsanto Canada Inc., et al., (2004) 31 C.P.R. (4th) 177, para. 42.

## 18

# Breeding of Medicinal Plants

*Friedrich Pank*

### 18.1

#### Introduction

Although, compared to other groups of cultivated plants, medicinal and aromatic plants (MAPs) utilize only a very small cultivation area, they comprise a huge number of plant species with a diverse array of biological specificities and characteristics. Plant breeding offers the opportunity to adapt these most diverse species to the specific demands of their users, improving the prerequisites to high-quality, profitable and sustainable production. Exploitation of the genetic potential of MAPs is still in its initial stage, and classical breeding methods prevail due to the high natural variability available. Nevertheless, the use of biotechnological tools and research into genes that control secondary metabolite formation and their transmission are currently in progress.

Plant breeding itself is a highly complex field of science, and the objects and aims of MAP breeding vary very widely. In this chapter, we provide some highlights – supplemented with references – to elucidate the multifaceted subject of plant breeding for medicinal purposes.

The first question to ask is exactly what can plant breeding provide? The phenotypes of plants are determined not only by environmental but also by genetic factors, which are inherited from parents by their progenies. The breeder exploits the genetic variability of populations and tries to change their genetically controlled reaction norm.

As Figure 18.1 shows, breeding moves the average trait expression of a population towards the aspired direction and improves the homogeneity and the ecovallence, which leads to the reduction of modifications depending on environmental factors.

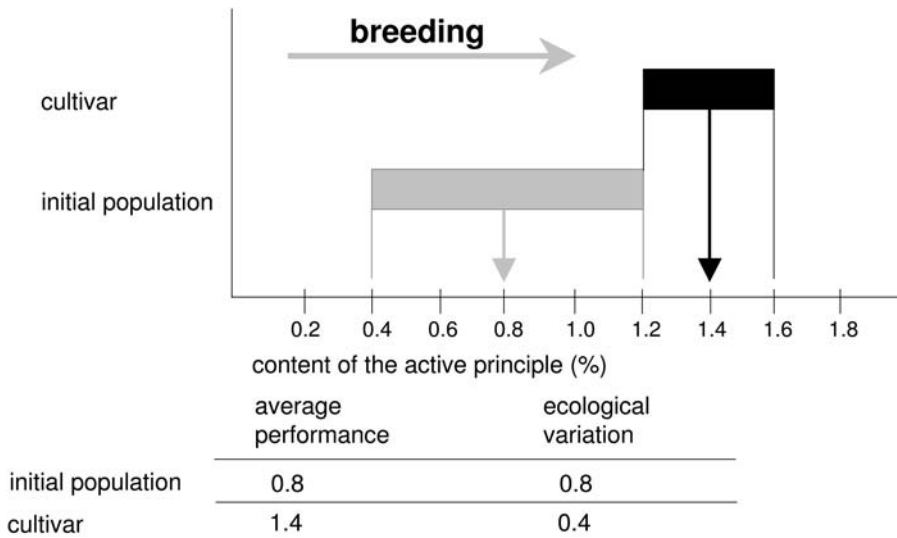


Fig. 18.1 The effects of plant breeding.

## 18.2

### Demands on MAP Cultivars

Breeding results in high-performance cultivars that are indispensable for the production of high-quality products in a sustainable and profitable way. Breeding aims differ depending on the position of the stakeholders in the production chain. The stakeholders are seed companies, farmers, trade and industry, consumers, and also the general public. Some typical breeding aims are:

- High and stable yields and an improved harvest index – an improvement of the proportion of the utilized plant parts (e.g., leaves) in the total plant mass.
- Homogeneity of the herbal crude drug.
- A high content of desired compounds and an absence of harmful substances, in compliance with the respective standards.
- Resistance to biotic stress (pests and diseases) and to abiotic stress (climatic adaptation to the cultivation region, such as frost and drought resistance).
- High functional value and safety.
- MAP cultivars must be fit for technological processes in agriculture: rapid youth development to suppress weeds, harvest machines require simultaneous maturity, upright growth, no tendency to lodging, limited range of the flower horizon (e.g., chamomile), no shattering tendency of the fruits for combining, closed capsules (e.g., evening primrose), thick roots with limited ramification (e.g., valerian roots).

For technological processes in industry (suitable for processing procedures), there is also a need to provide:

- low-input (low nutritional requirements), cost-saving and sustainable production; and
- an effective protection of plant breeders' rights (e.g., by hybrid varieties).

For example, bitter fennel (*Foeniculum vulgare* MILL. ssp. *vulgare* var. *vulgare*), which is endemic in the Mediterranean region, ripens very late in autumn in central Europe. Therefore, the farmers demand that the breeders adapt fennel to the colder climate by breeding early ripening cultivars. In this respect, the growth height should be limited to about 120 cm to provide better working conditions for the combine harvester, and a low shattering tendency of the fruits is required to avoid losses during the harvest period. Furthermore, new cultivars are needed with resistance to the blight disease which is caused by *Mycosphaerella anethi* [1].

The industry needs small-shaped fruits for the machines which fill the tea bags. According to the European Pharmacopoeia, the following constituents are required: essential oil content at least 4%, and concentrations in the essential oil of at least 60% anethole and 15% fenchone. There is also a demand to reduce the content of estragole, which has recently been classified as harmful by the Scientific Committee on Food of the Commission of the European Union. Thus, the estragole content of new cultivars should be as low as possible [2, 3].

### 18.3

#### Specifics of MAP Breeding

The breeders of MAP cultivars are confronted with a number of special features. For example, several disadvantages compared to the breeding of main agricultural crops are that:

- only a few results of breeding research are available (e.g., on the genetics of certain traits and on breeding methods);
- MAP comprise a particularly large number of species;
- often the breeding aims differ on one and the same species, depending on the field of use;
- the analyses of the important constituents are particularly costly;
- only limited capacities for breeding research and breeding are available for these minor crops; and
- refinancing of the breeders' expenses is insufficient due to the limited cultivation area and therewith to the small seed turnover.

However, there are also advantages: for example, the breeder can exploit high natural variability because the breeding of MAPs is only in its initial stage, so that excellent progress is achievable after only a few selection steps.

In view of these specifics, and to ensure an adequate cost-value ratio, breeders must plan very carefully which crops, breeding aims and breeding methods are to be chosen.



## 18.4

### Genetic Resources

Successful breeding implies the availability of genes coding for the desired characteristics of aspired new varieties. Breeders start a breeding program by screening the available germplasm collections for donor genotypes. Breeding progress is dependent on the availability of genotypes with genes of the aspired characteristics – the greater the diversity of natural populations, the greater is the probability to identify a suitable donor-accession.

Gene banks, botanical gardens and other institutions collect, maintain and characterize a wide diversity of different accessions of a great variety of species. The official plant variety offices test cultivars with regard to distinctness, uniformity, stability and value for cultivation and use, and the results of variety testing are condensed in variety lists. These are available on a national level for example in Germany as descriptive variety lists [4]. The European Union Community Plant Variety Office in Angers, France, provides information on variety characteristics on application. The International Plant Genetic Resources Institute (IPGRI) with its domicile in Maccaresse (Fiumicino), Italy and 22 offices worldwide advances the conservation and use of genetic diversity. A survey of databases of germplasm collections (mostly searchable on-line) is provided by the IPGRI web sites.

The breeder can use the gene bank passport data of individual accessions [5], or the publications of official plant variety offices for the selection of genotypes which are to be included in the projected screen.

## 18.5

### Breeding Methods

Genetic diversity of the initial population is the most important prerequisite of successful breeding. Initially, the breeder exploits the available natural diversity, but if this is exhausted then new diversity must be created. Once a population with an appropriate variability is available, the breeder begins to select genotypes with the aspired trait expression. Effective selection techniques contribute decisively to the efficacy of the breeding procedures.

Today, classical methods predominate among MAP breeding due to the special aforementioned biological and economical conditions. These methods are comparatively inexpensive in comparison to biotechnological approaches.

#### 18.5.1

##### Utilization of Available Natural Diversity

Due to the available high infraspecific genetic variability of most MAP species, the breeder achieves good breeding progress by simple selection of populations with an improved performance. The sources of natural variability include:

- accessions collected in the wild;
- accessions from germplasm collections (e.g., from gene banks and botanical gardens);
- old primitive cultivars and landraces; and
- contemporarily used cultivars.

The introduction of a high-performance population selected among a great collection of different accessions can already provide enormous progress in the adaptation of a MAP species to the demands, even without additional time-consuming and expensive breeding procedures.

As an example, the results of an evaluation of the essential oil content of several thyme accessions, in comparison to the currently cultivated standard variety “Deutscher Winter” represented by accession no. 1 are illustrated in Figure 18.2. The essential oil content of the best accession no. 18 exceeded the essential oil content of the standard cultivar by 62%. Cultivation of this high-performance population instead of the standard variety already provides the facility to produce thyme with a significantly improved essential oil content, without any further breeding efforts.

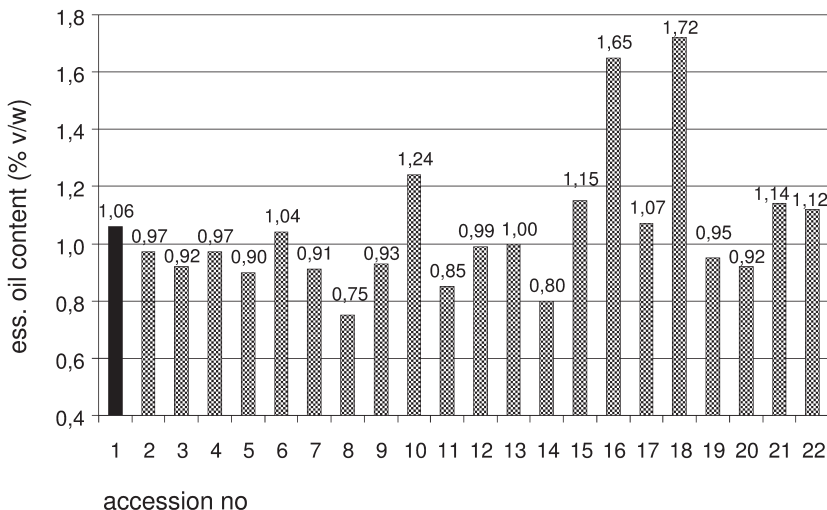


Fig. 18.2 Essential oil content of different thyme accessions.

### 18.5.2

#### Generation of New Variability

New variability must be created if the available genetic variability has been exhausted and the initial material does not provide the desired trait expression. New genes or gene complexes must be introduced into the population. Some common methods for which are described in the following sections.

### 18.5.2.1 Combination Breeding by Crossing

The aim of *crossing* is to combine the trait expressions of the parents (donors of certain characteristics) in common progenies. The pollen of the father parent is transferred to the stigma of an emasculated flower of the maternal parent, and the pollinated flower must be kept isolated (e.g., in a paper bag) during the period of stigma fertility. Elite plants with the aspired trait combination are selected in the following segregating generations and bred to constancy by repeated selection steps. This method is most often used in MAP breeding to create new variability [6].

*Recurrent back-crossing* is used to transfer one trait of variety A to another variety B. The genome of parent B is transferred to the hybrids by several cycles of fertilization of the hybrids by the pollen of parent B. Only such hybrids among the hybrid progenies are used for a new back-cross cycle which exhibit the trait to be transferred. The genome of variety A, except the genes coding for the new trait, will be replaced by the genome of variety B by repeated cycles of back-crossing

Bitter fennel genotypes (*Foeniculum vulgare* MILL. ssp. *vulgare* var. *vulgare*) guarantee the aspired chemical composition, but their growth is tall and they are late-maturing. In contrast, the sweet fennel genotype (*F. vulgare* MILL. ssp. *vulgare* var. *dulce*) has an unsatisfying essential oil content and composition, but it is very early-maturing and the growth height is low (Fig. 18.3). An attempt was made to combine the desired early maturity and the low growth height of sweet fennel with the chemical composition of bitter fennel by reciprocal crossing.

The boxplots in Figure 18.4 show the essential oil content of the different generations. The generations are: The parents bitter and sweet fennel; the selection population ( $F_2$ ); and the half-sib families of elite plants selected in the selection populations. The basic requirement of PhEur is marked by the broken line.

The essential oil content of the bitter fennel parents was in the range of 6 to 11%, and the oil content of the sweet fennel parent about 2%. The essential oil content of the hybrids was prevalently inherited with a tendency towards low values. The

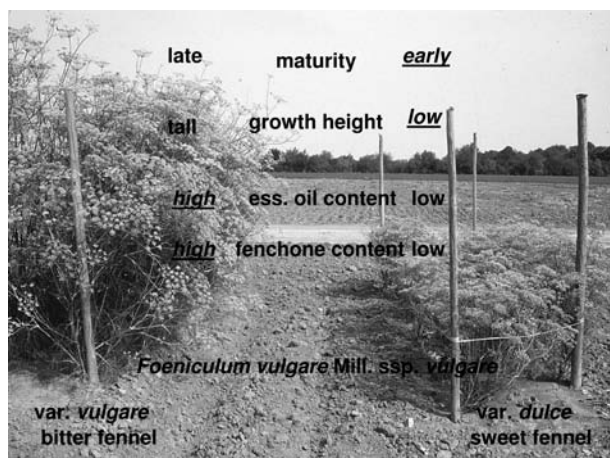


Fig. 18.3 Opposed characteristics of bitter and sweet fennel.

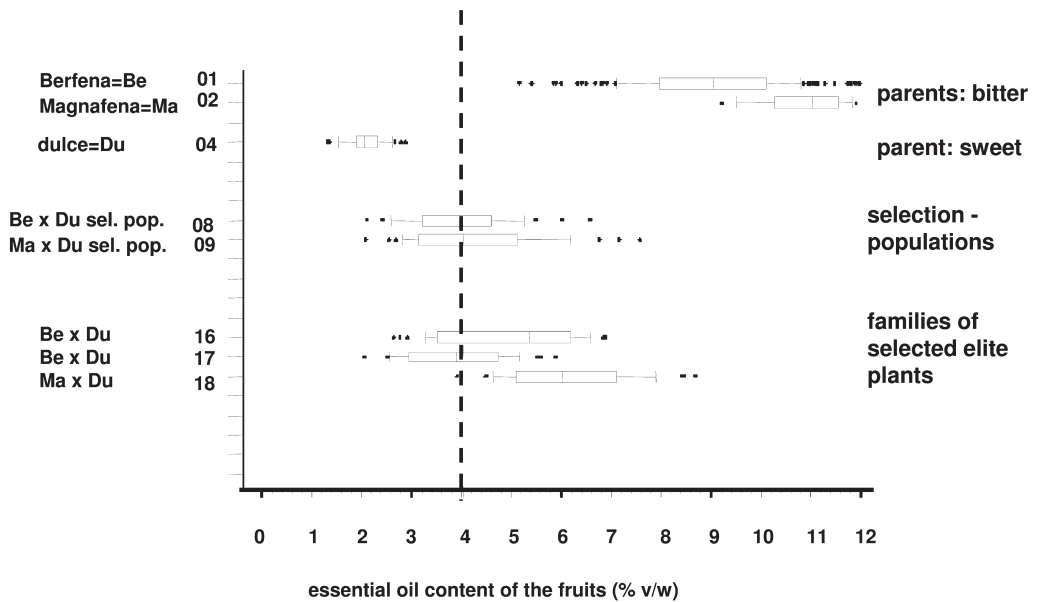


Fig. 18.4 Essential oil content of crossing progenies of sweet and bitter fennel.

oil content of the elite plant families could be improved by selection, two of three elite plant families met the PhEur basic requirement of 4%.

Possibilities of combination breeding are limited when there is a high genetic correlation between aspired and undesired trait expressions. The reasons may be pleiotropy (one and the same gene is responsible for both traits), or the small distance of two genes coding for one aspired and for one undesired trait on one chromosome. In this case, the probability of the allocation of both genes to different chromatids by the formation of chiasmata and crossing over during meiosis is very low.

### 18.5.2.2 Hybrid Breeding

Hybrid breeding is increasingly used for MAPs due to the following advantages:

- high performance by hybrid vigor;
- uniformity; and
- natural protection of plant breeders' rights because unlicensed seed propagation results in worthless segregating populations.

For hybrid breeding of outbreeding MAPs, lines with genic-cytoplasmatic pollen sterility should preferably be used to guarantee controlled pollination and to save the huge expenses of emasculation [6].

Additional expenses are necessary for the development and maintenance of at least three different lines by inbreeding, selection, and combining ability tests: the male sterile mother with her maintainer and a pollinator with high per se perfor-

mance and good combining ability (Fig. 18.5). Only when seeds or fruits are harvested should the pollinator have the ability to restore the fertility of the male sterile mother line, because otherwise no seed set will occur. If the pollinator is not a restorer, a certain amount of a restorer strain must be added to the seeds used for sowing. The  $F_1$  of the mother and the pollinator lines is used as cultivar. Due to the sophisticated seed production system, the seeds of hybrid cultivars are more expensive than those of population varieties.



Fig. 18.5 Male fertile and male sterile flowers of thyme.

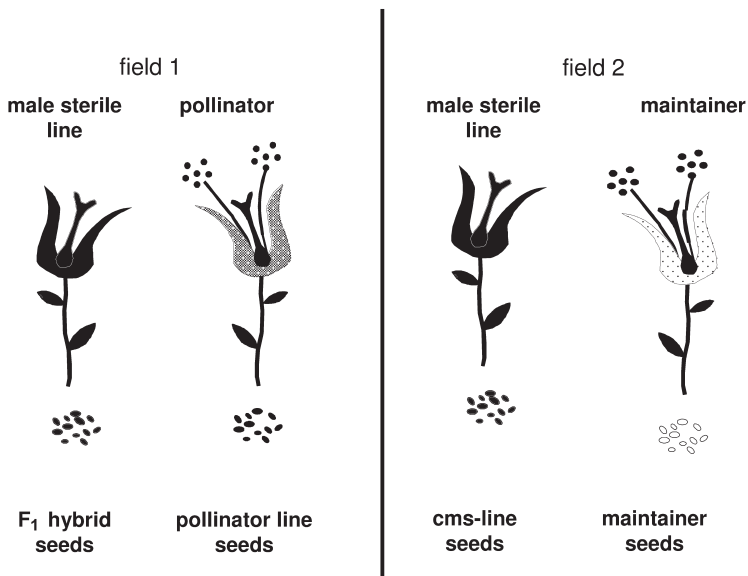


Fig. 18.6 Genetic components of a hybrid variety.

The scheme of Figure 18.6 illustrates the three lines, needed as components for a hybrid variety system for a herbal drug where the herb and not the seeds are the harvested product. In this case, the pollinator must not have restorer ability. Advances in the development of hybrid cultivar systems have been reviewed [7].

### 18.5.2.3 Synthetic Cultivars

Whereas hybrid cultivars exploit the good combining ability of only two distinct parent lines in the  $F_1$  generation, synthetic populations are based on several well-combining parental lines. The seeds are produced not only from the  $F_1$  as in hybrid cultivars but also from advanced generations [8]. In their potential performance – if not always in their uniformity – synthetic varieties can be equivalent to hybrid varieties.

Initially, high-performance and genetically diverse inbred lines or clones must be developed. The combining ability test of the inbred lines can be performed by a polycross: several plants of each inbred line are planted in the field in such a way that every plant of each inbred line has the same chance to pollinate the other plants. A polycross with annual caraway is illustrated in Figure 18.7.

Lines with the best general combining ability are selected; these constitute the components of the synthetic variety, and are maintained by the breeder. For seed production, the selected components with high combining ability are planted again for mutual pollination in a polycross; this generation is called  $Syn_0$ . The following panmictically propagated generations have the designations  $Syn_1$ ,  $Syn_2$ ,  $Syn_3$ , etc. The heterozygosity and performance potential achieved in  $Syn_1$  can largely survive in the following generations, though the yield can also decrease after  $Syn_2$  until an equilibrium is reached in the following generations. The synthetic variety can be maintained by starting a new polycross with the parental components as  $Syn_0$  or by maintenance selection in the population of an advanced generation ( $Syn_4$  ...).



Fig. 18.7 Polycross of annual caraway inbred lines.

#### 18.5.2.4 Induced Mutation

Spontaneous mutations of the genome occur to a certain degree in all plants. The frequency of such mutations is too low to generate the required level of new variability which is necessary for effective breeding. The spontaneous mutation rate can be improved by the use, for example, of radiation or mutagenic chemicals.

The change of the genome by a mutant results in a different reaction norm of the mutated plants compared to the non-mutated originals. Subsequent recombination of the mutants with existing genotypes results in additional new variability, with the occurrence of *genome mutations* (changes of the number of chromosomes; aneuploids, haploids, autopolyploids, allopolyploids), *chromosome mutation* (whole segments of chromosomes are changed), *gene mutations* (only individual genes are changed), *plastidome mutations*, and *plasmon mutations*. In general, the search for deviating phenotypes does not begin until the  $M_2$  generation.

For example, the polyploid peppermint (*Mentha × piperita*) variety “Multimentha” resulted from a genome mutation by mutation breeding. Peppermint is a tripelbastard from *M. spicata* × *M. aquatica*, while *M. aquatica* originates from *M. longifolia* × *M. rotundifolia*. The fertility of the infertile allopolyploid ( $2n = 64$ ) variety “Mitcham” could be restored by doubling the chromosome set ( $2n = 128$ ) by means of colchicine treatment. This made possible new recombination of genes via sexual reproduction. Almost 5000 progenies were screened for high yield, adequate chemical composition and resistance against *Puccinia menthae*, and this selection resulted in the high-performance cultivar “Multimentha”, which is infertile due to a chromosome set of  $2n = 96$ . Genetic stability is ensured because this variety can be propagated only vegetatively.

Further examples of species with varieties originating from mutation breeding include chamomile (“Zloty lan”, “Bodegold”), sweet marjoram (“Miraz”, “Tetra-ta”), mullein (“Polyverb”) [4], coriander [9], and lavender [10].

#### 18.5.2.5 Somaclonal Variation

Breeders can use also new genetic variability occurring in cell and tissue cultures *in vitro*. The *in-vitro* culture stress coupled with processes of de- and redifferentiation act as a mutagen. Selection can be performed on the cell level either *in vitro* or on the level of fully functional plants regenerated from tissues or cells. The results of somaclonal variation on MAPs have been reported by several groups [11–14].

#### 18.5.2.6 Somatic Hybridization (Protoplast Fusion)

Plants can be separated into single cells and, after dissolution of the cell wall by pectinase and cellulase, protoplast fusion is induced by polyethylene glycol in the presence of calcium, or via electrofusion. The fused protoplasts can be regenerated to functional plants. Somatic fusion allows the asexual addition of two heterozygous genomes without any meiotic recombination. In this way, the breeder can overcome sexual incompatibility when combining, for example, different species

or genera. Successful protoplast fusion has been reported of *Catharanthus roseus*/*Vinca minor*, *Rauwolfia serpentina*/*Vinca minor*, *Rauwolfia serpentina*/*Catharanthus roseus* [15], and *Datura innoxia*/*Physalis minima* [16].

#### 18.5.2.7 Molecular Gene Transfer

The transfer of genetic information by somatic hybridization builds the transition to molecular gene transfer. The creation of new variability in classical approaches is the result of an accidental recombination. Genomes – or at least parts of genomes – are combined, wherein a desired trait is always accompanied by several undesired characters, and consequently the predictability of the characteristics of the resulting new generations is limited. However, the predictability is improved when single genes can be identified and transferred from one genotype to another. The following prerequisites must be met:

- the gene must be available as a fragment of DNA;
- this DNA should be clonable;
- the gene must be manageable in a transfer system;
- the DNA must be integrated into the cellular genome;
- the transformed cell must be regenerable into a functional plant; and
- the plant must be able to express the transferred trait.

Methods for gene transfer include microinjection, insertion via microprojectiles, direct transfer, vector-mediated gene transfer, for example by the tumor inducing (ti)-plasmid of *Agrobacterium tumefaciens* [17].

Gene transfer is followed by classical breeding procedures for the exclusion of undesirable variations of the new transformed populations.

The development of gene farming technologies by using the biosynthesis of interesting compounds in plants is under investigation. Much ongoing research with MAPs is also concerned with clarification of the biosynthetic pathways of important secondary metabolites, the identification of related enzymes, the isolation of encoding genes, and the establishment of protocols for gene transfer. Successes have been reported on the production of secondary metabolites in genetically modified plants, including interferon in *Nicotiana tabacum* and vaccines in other species [18]. However, these investigations are very expensive and until now very few examples of the breeding of transgenic cultivars with economic importance have been successful [19].

To date, the use of genetically modified plants to produce secondary metabolites has not been implemented, mainly because achievable yields have not yet provided. An additional obstacle at present is the refusal of customers to purchase genetically modified herbs in the most important MAP market, in Europe. In contrast, the production of pharmaceuticals – mostly peptides or proteins – via genetically modified cells or microorganisms has been already been successfully introduced. Indeed, the European Pharmacopoeia considers this development by the monograph “Producta ab ADN recombinante”, PhEur [18].



## 18.5.3

**Selection**

If a population with an appropriate natural or artificially generated variability is available, the breeders begin the improvement of a population by selection. This process accumulates the genes into a population which controls the aspired trait expressions. The expression of most important traits is inherited from parents by their progenies. Selection in wild populations or landraces is the most common method of medicinal plant breeding, because most of the species are presently at the stage of wild plants with high genetic variability. The introduction of only a few selection steps can provide satisfactory results. Information on selection methods can be obtained from breeding manuals [20, 21].

**18.5.3.1 Positive and Negative Mass Selection**

The simplest selection method is positive mass selection, whereby individuals from a mixture of phenotypes corresponding to the breeding aim are selected and propagated together. The best plants of an improved generation are jointly cultivated and their seeds can be used as cultivar (Fig. 18.8).

The breeding of dominantly inherited traits to constancy is difficult in this way because the phenotype of homozygous and heterozygous plants is not distinguishable.

The converse principle is negative mass selection, whereby phenotypic undesired types are removed and the residual plants propagated. Negative mass selection is mainly used to maintain established varieties.

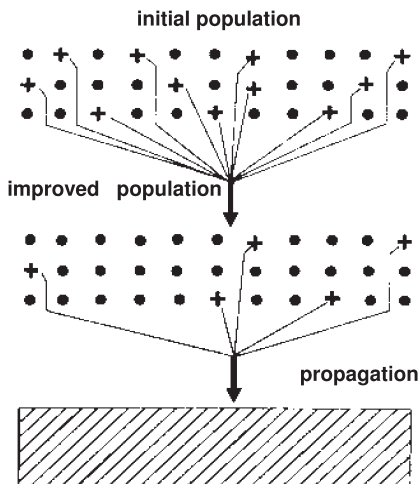
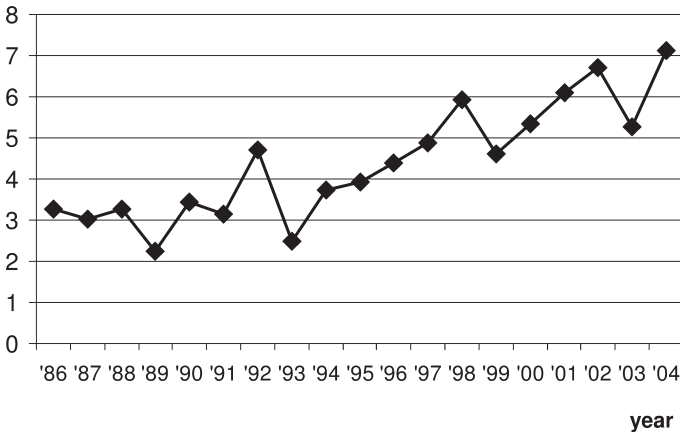


Fig. 18.8 Positive mass selection.

### 18.5.3.2 Recurrent Selection

Recurrent selection aims at increasing the frequency of favorable genes in the population through repeated cycles of (i) selection and (ii) joint cultivation and panmictic crossing of the best individuals. The selection response can be improved by selfing the selected elite plants, testing their progenies, and selecting only the elite plants of high-performance families for jointly cultivation and panmictic crossing. The doubling of essential oil content of annual caraway by long-term recurrent selection between 1986 and 2004 is shown graphically in Figure 18.9.



**Fig. 18.9** Improvement of the essential oil content of annual caraway (*Carum carvi* var. *annuum*) by long-term recurrent selection.

### 18.5.3.3 Individual Selection with Progeny Testing

The nature of this selection method is to evaluate the selected plants by their progenies rather than to evaluate them only by themselves. Whereas mass selection is a selection of phenotypes, individual selection with progeny testing evaluates the genotype. In self-fertilizing crops, the individual progenies of the selected elite plants are tested, and low-performance families excluded from further breeding. In cross-pollinated crops uncontrolled pollination takes place during testing of the elite plants' offspring. Therefore, overstored seeds of the mother plants must be used for further breeding procedures instead of selected plants of the elite plants progenies. The scheme of individual selection with progeny testing of outbreeders is illustrated in Figure 18.10.

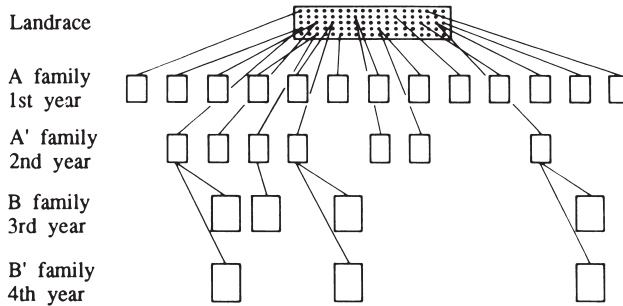


Fig. 18.10 Individual selection with progeny testing in outbreeders using overstored seeds [22].

#### 18.5.3.4 Breeding in Apomicts

Apomixis is asexual seed formation without fusion of two reduced gametes; it is practically vegetative propagation whereby all the progenies have the same genetic constitution as the mother plant. The use of apomixis has the following advantages:

- no procedures towards true breeding are necessary;
- less expense for progeny testing of crossings is needed;
- hybrid effects (heterosis) can be fixed and therefore;
- the seed production of hybrid varieties needs less expense.

The main disadvantage is that combination breeding by crossing is complicated because sexual lines must be developed previously.

The breeding scheme of apomictic species is shown in Figure 18.11. Sexual mother plants are pollinated by apomicts, whereupon the progenies segregate into sexuals and apomicts. Sexuals can be used for further back-crossings, while the progenies with a high apomixis level and with the desired trait combination can be used as cultivars because all progenies are true-breeding.

Investigations are currently under way to switch on and off the apomictic behavior of plants by gene transfer [23, 24]. Apomixis can also be found in some MAPs, for example in coriander (*Coriandrum sativum*) [25], basil (*Ocimum basilicum*) [26], and chive (*Allium schoenoprasum*) [27].

Recently, experience was gained with the apomictic St. John's wort (*Hypericum perforatum* L.) [28, 29]; this is allotetraploid, combining the chromosome sets of *H. maculatum* and *H. attenuatum*, and it is also partially allogamous. Pollen transfer is carried out by insects, or by the wind. Partial self-incompatibility was observed. St. John's wort is in general a pseudogamous facultative apomict, but in rare cases obligatory sexuals and pure apomicts also occur. The following shares of the different reproductive types were determined in a St. John's wort collection with more than 120 accessions: 94.7% facultative apomicts/sexuals, 2.2% obligatory apomicts, and 2.5% obligatory sexuals. The embryo sacs are in general unreduced, but the pollen is reduced. Fertilization of the polar nuclei by sperm cells is

necessary to initiate the apomictic seed formation, despite which the egg cell remains unfertilized. This behavior is termed “pseudogamous”.

The breeding scheme (Fig. 18.11) shows that sexual genotypes are required for combination breeding by crossing.

A rapid method to determine the type of reproduction is available for differentiation of the reproductive types of St. John’s wort plants [30]. Variation of the DNA-content of the cell nuclei (the so-called C-value) of the endosperm and embryo is used as the key to classify the reproductive types.

The DNA-content of the embryo and the endosperm depends on the ploidy level of the plant, on the incidence of meiotic reduction of the gametes, and on the occurrence of fertilization of the egg cell and the polar nuclei which develop the endosperm. Apomictic individuals have an unreduced embryo sac. The C-values of the embryo and polar nuclei are 2 and 4, respectively, but after fertilization of the two polar nuclei, the embryo has a C-value of 2 and the endosperm of 5.

The C-values of the isolated cell nuclei of St. John’s wort seeds can be measured using flow cytometry, with data expressed as histograms (Fig. 18.12). With DNA-content plotted on the abscissa and numbers of cell nuclei on the ordinate, a high peak represents the embryo, which contains many more cell nuclei than the endosperm.

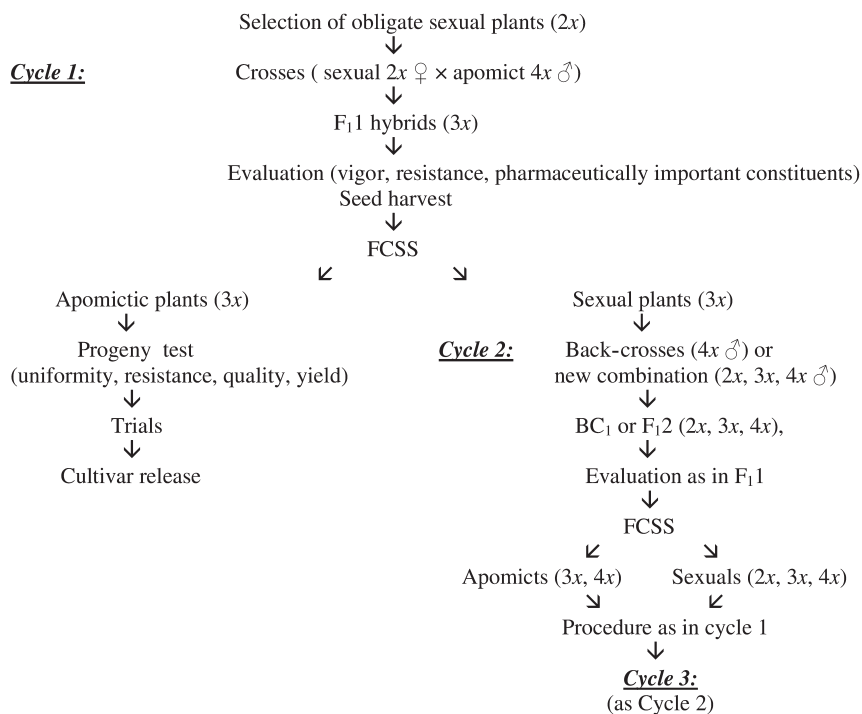
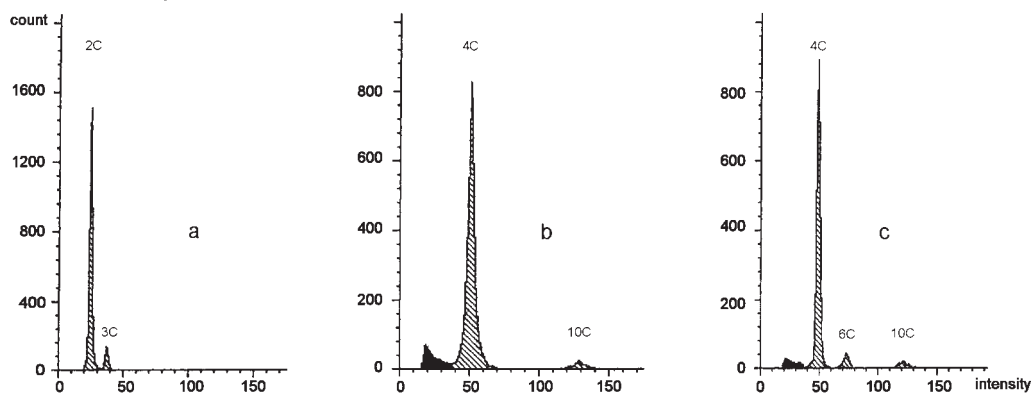


Fig. 18.11 A simplified breeding scheme with recurrent hybridization in *Hypericum perforatum* L. [28]. FCSS, flow cytometric seed screening.



**Fig. 18.12** Histograms from cell nuclei of bulked seed samples from diploid and tetraploid seed parents obtained with a Partec-Ploidy analyzer. (a) The 2C embryo + 3C endosperm peaks represent the sexual mode of reproduction. (b) The 4C embryo +

10C endosperm peaks represent the obligate apomictic mode of reproduction. (c) The 4C embryo + 6C and 10C endosperm peaks represent the facultatively apomictic sexual mode of reproduction [28].

#### 18.5.3.5 Clonal Breeding

Clonal breeding has a particularly high importance for MAPs because this method shortens the breeding procedure considerably. Clone varieties are vegetatively propagated due to sterility of the species (e.g., *Mentha × piperita* L.), or to ensure consistency of progenies of fertile allogamous species. This method shortens the breeding procedures because the time-consuming procedures for breeding on consistency can be omitted. High-performance individual plants are reproduced identically by different vegetative propagation methods, for example, by grafting (fruit trees), partition of balled plants, stolons, runners, rooting of cuttings, and cell and tissue culture. Due to the high costs of vegetative propagation (which is mostly carried out by micropropagation *in vitro*), clonal breeding is appropriate only for high-priced MAPs such as *Baptisia tinctoria* (L.) R. Br [31].

Clonal breeding incorporates the following steps:

- generation of variability by crossing;
- selection of elite plants among the crossing progenies;
- vegetative propagation of elite plants;
- comparison of the performance of the elite plants clones; and
- the best clones are used as vegetatively propagated new variety.

Daniel and Bomme [32] reported on the establishment of clones for a synthetic variety of *Arnica montana* by propagation of high-performance individual plants *in vitro* which were used as genetic components in a polycross experiment. Delpit et al. [33] produced high-performance clones of *Thymus vulgaris*.

Pattnaik and Debata [34] generated artificial seeds of *Cymbopogon martinii* from cell cultures, Lata et al. [35] of *Echinacea angustifolia*, and Mandal et al. [36] of basil

species. Protocols for micropropagation of many medicinal plant species have been published, including those for *Andrographis paniculata* [37], *Gentiana* sp. [38], *Hypericum perforatum* [39], *Ocimum basilicum* [40], *Origanum vulgare* [41], *Salvia* sp. [42,43], *Thymus piperella* [44], and *Valeriana officinalis* [45].

## 18.6

### Improvement of Selection Response by Specific Techniques

The aim of selection is to achieve a high selection response but with minimal expense of both time and money. Breeding a new cultivar with classical methods requires a period of 10–15 years from the first crossing up to cultivar registration. Thus, all possibilities should be investigated and used to shorten this period by improving the selection response. The formula  $R = i \times h^2 \times \sigma$  shows the factors affecting the selection response (R). The numbers of individual plants in the initial populations should be as high as possible in order to improve the selection intensity ( $i$ ). The heritability ( $h^2$ ) can be improved for example by an appropriate precision of the measurements of characteristics. High precision prevents the unintentional selection of low-performance individuals. Selection works only when the selection population has an appropriate variability ( $\sigma$ ).

Furthermore, the selection response depends on:

- The stage of plant development at trait evaluation and selection: before flowering, only valuable plants participate in pollination; after flowering, the participation of low-performance plants in pollination can be avoided only by overstoreing seeds.
- The degree of the modifying influence of the environment.
- Self-incompatibility under forced self-pollination.
- Inbreeding depression.
- The type of genetic control of the trait (e.g., recessive or dominant, monogenic or quantitative).
- The mating system (outbreeding or self-fertilizing crops) (see Table 18.1).
- The generative or vegetative propagation of the species.

#### 18.6.1

##### Accelerating the Succession of Generations

The succession of generations is limited by the natural rhythm of plant development and by climatic conditions. Selection cycles can be speeded up, and therewith the selection intensity can be improved by breaking through these barriers. For example, Pank and Schwarz [79] succeeded in cultivating an additional generation of annual caraway (*Carum carvi* var. *annuum* hort.) during winter in the greenhouse.

Some species require periods of low temperatures for transition to the generative phase. Vernalization simulates such growing periods by exposing the plants to low temperatures, and Novak et al. [80] managed the flower induction of sage (*Salvia officinalis*) and Mewes [81] of thyme (*Thymus vulgaris*) by vernalization.

Table 18.1 Mating systems of medicinal and aromatic plants.

Species	Allogamous	Facultative allogamous or autogamous	Autogamous	Gynodioecious	Apomictic
<i>Achillea millefolium</i>	Lofgren (2002) [46]	Knuth (1898) [47]		Knuth (1898) [47]	
<i>Allium cepa</i>	Knuth (1899) [48]	Becker (1944) [49]			Konvicka (1984) [50]
<i>Allium sativum</i>					Khokhlov (1976) [27]
<i>Allium schoenoprasum</i>	Heeger (1956) [51]	Heeger (1956) [51]			Khokhlov (1976) [27]
<i>Althaea officinalis</i>	Nettancourt (1977) [52] Brewbaker (1959) [53] Knuth (1898) [47]				
<i>Anethum graveolens</i>		Silova (1973) [54]			
<i>Angelica archangelica</i>	Heeger (1956) [51]				
<i>Anthriscus cerefolium</i>	Heeger (1956) [51]				
<i>Apium graveolens</i> var. <i>secalinum</i>		Becker (1944) [49]	Knuth (1898) [47]		
<i>Arnica montana</i>	Nettancourt (1977) [52] Brewbaker (1959) [53]		Knuth (1898) [47]		
<i>Artemisia dracunculus</i>	Nettancourt (1977) [52] Brewbaker (1959) [53] Heeger (1956) [51]				
<i>Calendula officinalis</i>	Nettancourt (1977) [52] Brewbaker (1959) [53] Heeger (1956) [51]	Heeger (1956) [51]		Kaul (1988) [55]	
<i>Carum carvi</i>		Zijlstra (1916) [56] Toxopeus (1998) [57]			
<i>Coriandrum sativum</i>		Romanenko (1992) [58]			Romanenko (1984) [25]
<i>Digitalis purpurea</i>	Knuth (1899) [48]	Knuth (1899) [48] Mihalea (1971) [59] Seidler-Lozykowska (1996) [60]			
<i>Echinacea purpurea</i>					

Table 18.1 Continued

Species	Allogamous	Facultative allogamous or autogamous	Autogamous	Gynodioecious	Apomictic
<i>Foeniculum vulgare</i>	Singh (2000) [61]	Silova (1973) [54] Knuth (1898) [47]			Matzk (2003) [62] Pank (2003) [28]
<i>Hypericum perforatum</i>					
<i>Hyssopus officinalis</i>	Nettancourt(1977) [52] Brewbaker(1959) [53] Knuth (1899) [48]			Kaul (1988) [55]	
<i>Inula helenium</i>	Nettancourt(1977) [52] Brewbaker (1959) [53] Knuth (1898) [47]				
<i>Lavandula angustifolia</i>	Kaul (1988) [55]	Knuth (1899) [48]		Kaul (1988) [55] Knuth (1899) [48] Kaul (1988) [55] (Stein 1966 [63] (Pank 2002) [64]	
<i>Origanum majorana</i>	Nettancourt (1977) [52] Brewbaker (1959) [53] Kaul (1988) [55]				
<i>Malva silvestris</i>	Nettancourt (1977) [52] Brewbaker (1959) [53] Knuth (1898) [47]				
<i>Matricaria recutita</i>	Wagner (2001) [65]				
<i>Melissa officinalis</i>	Nettancourt (1977) [52] Brewbaker (1959) [53] = sterile, Pank (1994) [67]	Knuth (1899) [48]	Rey (1995) [66]	Kaul (1988) [55]	
<i>Mentha × piperita</i>	Nettancourt(1977) [52] Brewbaker(1959) [53] Heeger (1956) [51]				
<i>Ocimum basilicum</i>	Knuth (1898) [47]	Knuth (1898) [47]			Kobakhidze (1981) [26]
<i>Oenothera biennis</i>					



Table 18.1 Continued

Species	Allogamous	Facultative allogamous or autogamous	Autogamous	Gynodioecious	Apomictic
<i>Origanum vulgare</i>	Nettancourt(1977) [52] Brewbaker(1959) [53] Kaul (1988) [55] Heeger (1956) [51]	Elena-Rosello et al. 1976) [68]		Kheyr-Pour (1981) [69]	Kaul (1988) [55]
<i>Petroselinum crispum</i>	Becker (1944) [49]				
<i>Pimpinella anisum</i>	Ricciardelli (1986) [70]				
<i>Plantago lanceolata</i>	Knuth (1899) [48]	Knuth (1899) [48]		Damme (1982) [71] Correns (1908) [72] Heeger (1956) [51]	
<i>Rosmarinus officinalis</i>	Nettancourt (1977) [52] Brewbaker (1959) [53] Nettancourt (1977) [52] Brewbaker(1959) [53] Kaul (1988)[55] Heeger (1956) [51]			Kaul (1988) [55]	
<i>Salvia officinalis</i>	Nettancourt(1977) [52] Brewbaker(1959) [53] Kaul (1988) [55] Vogel (1996) [74]	Aedtmer (1996) [73]		Kaul (1988) [55] Knuth (1899) [48]	
<i>Satureja hortensis</i>	Nettancourt(1977) [52] Brewbaker(1959) [53] Kaul (1988) [55] Vogel (1996) [74]				
<i>Silybum marianum</i>	Nettancourt (1977) [52] Brewbaker (1959) [53] Nettancourt (1977) [52] Brewbaker (1959) [53] Brewbaker (1959) [53]				
<i>Thymus vulgaris</i>	Nettancourt (1977) [52] Brewbaker (1959) [53]				
<i>Valeriana officinalis</i>	Kaul (1988) [55] Kempf (1986) [78] Heeger (1956) [51]	Roemer (1961) [77]		Belhassen et al. (1989) [75] Kaul (1988) [55] Mewes (2004) [76] Knuth (1899) [48] Kaul (1988) [55]	

Flower formation of some species depends on Nature and the duration of illumination; for example, Zoberi et al. [82] induced flower formation of *Achillea* sp. by using special illumination. Other species reveal typical photoperiodic reactions; among MAP long-day plants are ribwort (*Plantago lanceolata*), white mustard (*Sinapis alba*) and foxglove (*Digitalis purpurea*) [83], while short-day plants include mugwort (*Artemisia annua*) [84] and cannabis (*Cannabis sativa*) [83]. No photoperiodism is shown by dandelion (*Taraxacum officinale*), buckwheat (*Fagopyrum esculentum*), and parsnip (*Pastinaca sativa*) [83].

### 18.6.2

#### Early Selection

Selection intensity can be improved also by early selection, with low-performance individuals being eliminated at the start of the cultivation period. In this way, much future cultivation expense can be saved and a greater number of plants can be included in the selection procedures with the available capacity. Early selection is practicable on the level of young plants, calli, or cell suspensions.

The early selection of evening primrose (*Oenothera lamarckiana*) according to Ulrich and Pank [85], is shown in Figure 18.13. One cotyledon of a seedling is detached under a microscope and used as sample for the analysis of the gamma-linolenic acid (GLA). Elite plants with a particularly high GLA content can be regenerated from the rest of the seedling, and the plant can be used for further breeding procedures.

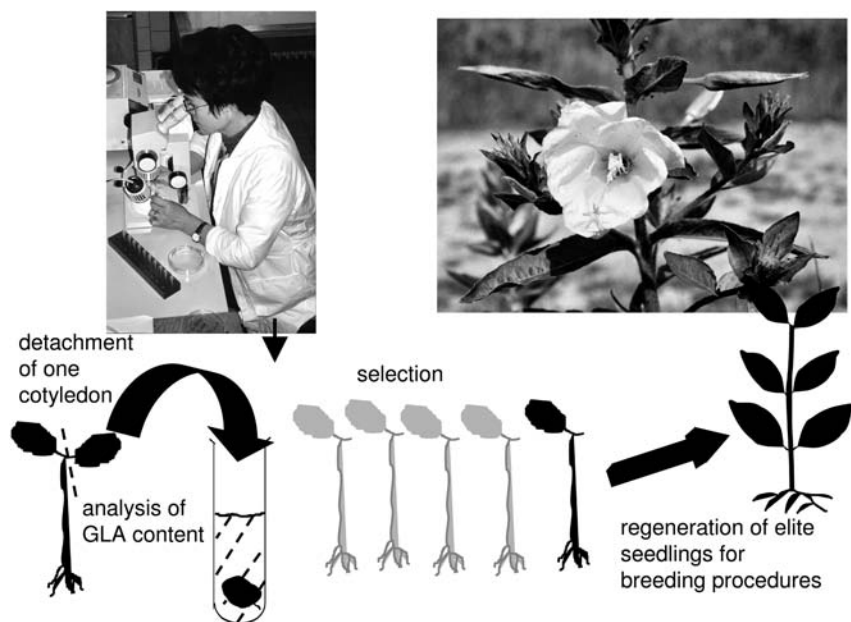


Fig. 18.13 Early selection in evening primrose. GLA, gamma-linolenic acid.

For resistance breeding, pathogens can be cultivated together with their hosts *in vitro* in callus- or cell-suspension cultures. The surviving plant regenerants show a high rate of pathogen resistance and can be used for further breeding procedures [86].

### 18.6.3

#### Doubled Haploids

New varieties must be homogeneous. Breeding for homozygosity is particularly time-consuming for traits with a dominant inheritance, because their genetic constitution cannot be phenotypically recognized. The use of haploids speeds up this process.

Anthers or microspores are used for the production of haploid plants. Homozygous plants can be established after spontaneous polyploidization during the *in-vitro* culture steps or after the colchicine-induced doubling of the chromosomes. Haploids are completely sterile, smaller than diploids, and slowly growing. During regeneration, their genome can be doubled by colchicine treatment (0.5%) supplied via the roots or by cotton wool plugs placed after axillary buds are excised. This doubling procedure results in completely homozygous fertile plants.

Schulte [87] succeeded in regenerating haploid plants from the anthers of *Hyperricum* ssp. Further examples of doubled haploids generation are presented for *Allium cepa* [88], *Datura innoxia* [89], *Digitalis lanata* [90], *Hyoscyamus niger* [91], and several other MAPs [92].

### 18.6.4

#### Determination of Characteristics

##### 18.6.4.1 Markers

The use of markers represents a valuable means of improving the selection efficiency, mainly because they allow greater numbers of plants to be evaluated. The principle of markers is as follows: traits, the expression of which can be measured directly only at high expense, can be evaluated more easily indirectly by means of a strongly correlated marker. These can be used for indirect selection by exploiting the association between the marker and the trait. Pleiotropy may be the reason of a close linkage between different traits where a single gene is responsible for a number of different phenotypic effects. Environmentally conditioned correlations (e.g., dependence of yield on duration of growth period) are useless for breeding purposes. Several different types of marker are available: Pank et al. [93] delineated morphological and physiological markers of *Origanum majorana* for yield estimation of individual plants, while Orth et al. [94] used chemical markers to differentiate *Achillea* species.

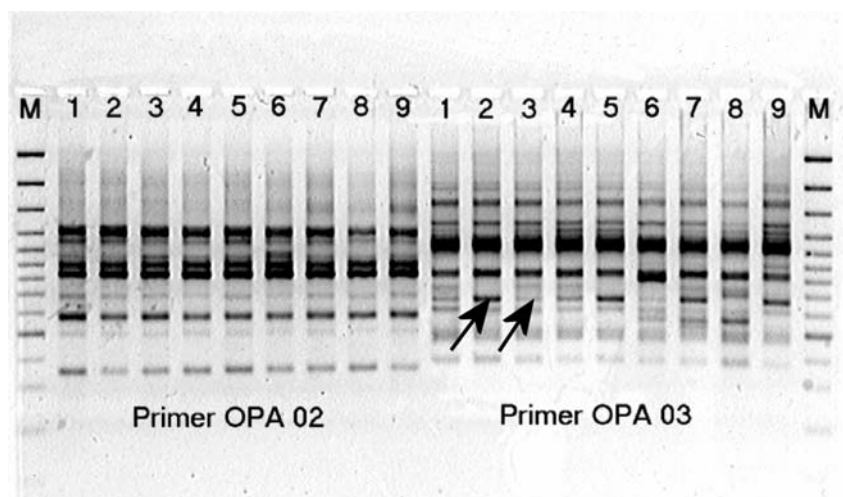
Wagner et al. [95] distinguished *Chamomilla recutita* genotypes by using molecular markers; these may be associated with certain characters and can therefore be used for indirect selection. Unlike other markers, molecular markers are independent of environmental and morphogenetic influences, and can be investigated

during the very early stages of the plant. The most commonly used molecular markers include:

- isoenzymes [96];
- RFLP (restriction fragment length polymorphism) markers [97];
- RAPD (random amplified polymorphic DNA) using the polymerase chain reaction (PCR-technique) [98]; and
- AFLP (amplified fragment length polymorphism) [99].

The banding profiles of electrophoregrams of the DNA-analyses are subsequently evaluated.

The electrophoregram of the RAPD analysis of DNA fragments of the sweet marjoram population MAJ11/92 [100] is shown in Figure 18.14. The individual plants can clearly be distinguished by the pattern of the banding profile of the DNA-fragments.



**Fig. 18.14** Electrophoregram of random amplified polymorphic DNA (RAPD) analysis of nine individual sweet marjoram plants [100]. The individual plants can clearly be distinguished by the pattern of the banding

profile of the DNA-fragments. Examples of different banding profiles originating from plant no. 2 and plant no. 3 (using the primer OPA 03) are marked by the two arrows. M, molecular weight markers.

#### 18.6.4.2 Rapid Analytical Methods

One of the most important breeding aims is to improve the content of the essential constituents, but the high expense involved for chemical analysis is often a limiting factor. Thus, the development of special analytical methods for MAP breeding is an indispensable prerequisite to provide a sufficient selection intensity by analyzing an appropriate number of individual plants. Analytical methods must meet the following demands:

- Time- and cost-saving to allow the evaluation of as many individual plants as possible.
- Non-destructive, in order to keep the investigated plant material alive for subsequent breeding procedures.
- Small sample quantities because single plants, or parts of them, are to be evaluated.
- Direct analysis without preceding sample preparation is preferred.
- The precision of the method must be reliable.

Much expense can be saved considering the fact that the accuracy must not comply with the high level of standard methods. For example, rapid and non-destructive near-infrared spectroscopy (NIRS) [101] and solid-phase microextraction (SPME) [102] have proved to be very effective in MAP breeding.

Other prospective methods to evaluate individual plants in selection procedures include computer-aided image analysis, direct and indirect quality assessment by color measurement, and tests with chemicals of high specific reactivity.

The aim of investigating plant samples is to determine genetic variation. In this respect, sampling must consider ontogenetic variation (dependence on the developmental stage of the plant, e.g., during fruit ripening), morphogenetic variation (dependence on the part of the plant, e.g., stems or leaves), and ecological variation (dependence on environmental conditions, e.g., soil, water and nutrient supply, light, temperature). In order to determine genetic variation, it is absolutely vital that all of the above-mentioned sources of variation at the time of sampling be kept constant.

### **NIRS**

NIRS has been proven effective in the evaluation of many important constituents in a wide variety of MAPs [103]. For NIRS, the samples are placed in a cuvette and exposed to a tungsten light source. After calibration, the content of a substance under test is calculated from the reflected infrared spectrum. NIRS meets the plant breeders' demands because it is non-destructive, highly productive, and reliable, though calibration by reference methods must be repeated at least annually.

An analysis of the fatty oil content of evening primrose seeds is shown in Figure 18.15, with data from the reference method and NIRS being strongly correlated. Moreover, the seeds are not damaged by the analysis and can be used for further breeding procedures.

### **SPME**

In SPME [105], the volatile compounds that evaporate from the plant material are adsorbed by a small fiber needle, which is then heated in the headspace of a gas chromatograph and the evaporated substances are analyzed. As in NIRS, only minimal amounts of material are needed for the analysis.

### **ELISA**

Langer et al. [106] succeeded in measuring pyrrolidine alkaloids in *Petasites* with a detection limit of 0.5 ppm by using an enzyme-linked immunosorbent assay

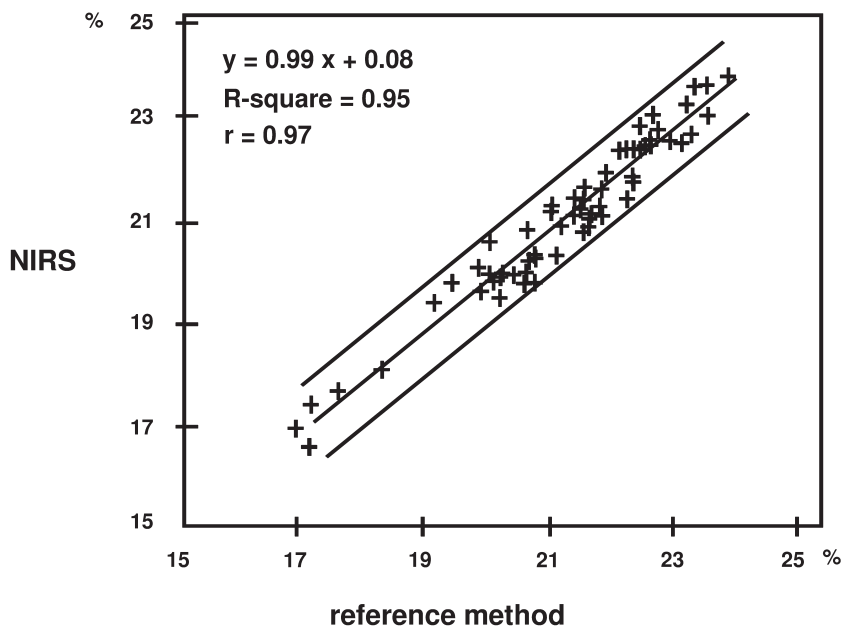


Fig. 18.15 Determination of fatty oil content of evening primrose seeds using NIRS [104].

(ELISA) which is generally used to evaluate the resistance of plants to diseases (see Section 18.6.4.4). This detection limit was adequate as it corresponded with the maximum acceptable threshold value.

#### 18.6.4.3 Spectrophotometric Color Measurement

Color is not only an important quality trait of herbal drugs but is also genetically controlled and can, therefore, be changed by breeding. Spectrophotometric measurements facilitate the objective assessment of color as an alternative to a more subjective visual evaluation. Measurements using the CIELAB system [107] proved to be excellent for this purpose: the spectral analysis fractionates the light into the following coordinates:  $a^*$  from green to red,  $b^*$  from blue to yellow, and  $L^*$  from black to white. Spectrophotometric measurements meet the plant breeder's demand for rapid and non-destructive methods. Pank et al. [108] investigated the feasibility of spectrophotometric color assessment of sweet marjoram using the CM-508 spectrophotometer (Minolta, Germany). The processing industry requires the marjoram drug to be of a light-green color; comparative monitoring of the leaves of 878 marjoram plants by spectrophotometric and visual assessment showed the former system capable of determining color differences that deviated from basic requirements.

#### 18.6.4.4 Breeding for Resistance to Pests and Diseases

MAPs are attacked by pests and diseases, and this results in yield losses and reductions in quality. Hence, the breeding of resistant varieties has become an important goal in attempting to avoid, as far as possible, the need for plant protection products and spray applications. These are not only costly but also potentially endanger both the consumers of the plants and the environment. A survey of some important MAP diseases and pests is provided in Table 18.2.

Effective methods to test resistance against pests and diseases are an indispensable prerequisite for effective resistance breeding. The first step of a resistance test is infection of the plants; the second step is to assess the susceptibility of the intensity of infestation.

*Artificial infection* can be carried out using different methods. An example is to alternate the field cultivation of a highly susceptible spreader with populations for which the susceptibility is to be tested. Alternatively, plants may be infected with suspensions of spores or conidia on the experimental field, in the greenhouse, or in the laboratory by carry-over of virus diseases by vector insects. Examples of infection methods have been described for *Colletotrichum* on St. John's wort by Scholze et al. [109], for *Cercospora* in fennel by Shul'ga and Zhurbenko [110], for *Helminthosporium* in poppy by Martynovskaya [111], and for parsley virus Y on dill by Kusterer et al. [112].

**Table 18.2** Examples of important pests and diseases of medicinal and aromatic plants.

<b>Damaging organism</b>	<b>Host plant</b>	<b>Group</b>
<i>Erwinia, Pseudomonas</i> sp.	Umbelliferous species	Bacteria
<i>Alternaria</i> sp.	Several species	Fungus
<i>Botrytis cinerea</i>	<i>Digitalis lanata</i>	Fungus
<i>Colletotrichum</i> cf. <i>gloeosporioides</i>	<i>Hypericum perforatum</i>	Fungus
<i>Erysiphe, Peronospora, Plasmopara</i> sp.	Several species	Fungus
<i>Helminthosporium papaveris</i>	<i>Papaver somniferum</i>	Fungus
<i>Mycocentrospora acerina</i>	<i>Carum carvi</i>	Fungus
<i>Mycosphaerella anethi</i>	<i>Foeniculum vulgare</i>	Fungus
<i>Phoma exigua</i>	<i>Valeriana officinalis</i>	Fungus
<i>Phomopsis diachenii</i>	<i>Carum carvi</i> var. <i>annuum</i>	Fungus
<i>Puccinia</i> sp.	Several species	Fungus
<i>Rhizoctonia, Fusarium, Pythium, Olpidium</i>	Several species during emergence	Fungus
<i>Septoria</i> sp.	Several species	Fungus
<i>Aphids</i>	Several species	Insect
<i>Depressaria nervosa</i>	<i>Carum carvi</i>	Insect
<i>Eupteryx atropunctata</i>	Several species	Insect
<i>Lygus</i> sp.	Umbelliferous species	Insect
<i>Olibrus aenes</i>	<i>Chamomilla recutita</i>	Insect
<i>Psila rosae</i>	Roots of umbelliferous species	Insect
<i>Acerina carvi</i>	<i>Carum carvi</i>	Mite
Viruses	Several species	Virus

In order to produce spore or conidia suspensions, the pathogenic fungus is isolated from infested plants and cultivated on a suitable nutritional medium (e.g., potato dextrose agar). The spores or conidia are scraped off, cleaned by filtration, and the aspired spore density of the suspension is adjusted using a hemocytometer under the microscope. For infection, the suspension is sprayed onto the plants. These procedures are described by Scholz et al. [109] for testing St. John's wort for resistance to the St. John's wort wilt (*Colletotrichum cf. gloeosporioides*).

The simplest method to evaluate the *level of infestation* of plants is a visual assignment of scores classified according to the infestation level. This method is not valid to detect hidden infestations of plants which do not result in visible lesions. These hidden infestations (e.g., by viruses) can be detected using ELISA. The viruses are detected serologically in the pressed juices of the plants under examination, and then injected into warm-blooded animals. The viral protein coat acts as an antigen and induces the formation of antiserum, which can later be separated from the blood. The antiserum produced by the animal will react *in vitro* specifically with the viral protein of the viruses in the plant juice. The serological reaction is refined by linking it to an enzymatic color reaction via the ELISA.

Bellardi et al. [113] tested the occurrence of alfalfa mosaic virus (AIMV) in several MAPs using an ELISA. The procedure is also applicable for testing infestations by fungi. Taubenrauch et al. [1] described an ELISA for testing the resistance of fennel to *Mycosphaerella anethi*.

Computer-aided image analysis greatly facilitates the objective assessment of trait expressions of plants. Examples include the estimation of essential oil content of sweet marjoram leaves by Novak [114], the 1000 seed weight determination of fennel [115], and genotype differentiation of sweet marjoram by leaf morphometry [64]. These methods are in particular valid for assessing the infestation of plants by pests and diseases that result in visually observable lesions of the plant tissues. A digital camera is used to photograph the infested plant material, and the image

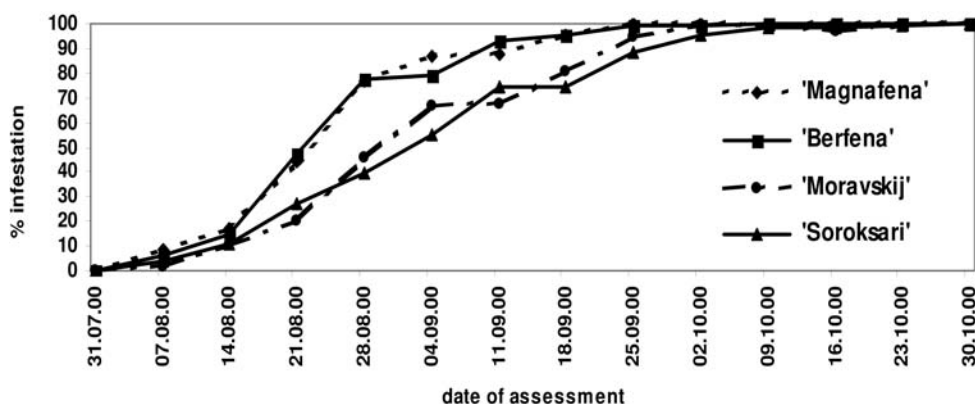


Fig. 18.16 Disease progress curve (% infested leaf area) of different fennel varieties infested by *Mycosphaerella anethi*. Measurements made by computer-aided image analysis [1].



analyzed using appropriate software. The software records the differing color profiles of infested and healthy regions, and the infestation level is calculated from proportions of the infested area and the total area. Taubenrauch et al. [1] used the image analysis software “Bafix” (GTA-Sensorik) to estimate infestation levels of fennel leaves by *Mycosphaerella anethi* during the vegetation period. The results of weekly measurements in three to five leaves of each variety are shown in Figure 18.16.

When individual resistant plants are selected, their progenies must be tested repeatedly to confirm the results of the first test with artificial infection and to breed them to constancy. Multiple back-crosses of disease-resistant lines with established varieties accelerate the new combination of valuable characteristics of a standard variety with disease resistance.

#### 18.6.4.5 Bioassay

The therapeutic value of genotypes cannot be evaluated by chemical analysis when the responsible active substances of herbal remedies are not known, or the correlation between the content of important constituents and the therapeutic effects is unsatisfactory. In this case, the selection of valuable individuals can be carried out using *in-vitro* bioassays which simulate the conditions *in vivo* [116]. Examples of bioassays for testing pharmacological effects of MAP have been described [117–119].

## 18.7

### Outlook

Today, breeding has become a key factor in the improvement of MAPs, mainly because the cultivars can be adapted to the particular demands of the stakeholders in the production chain, and can also contribute in such a way to high-quality, profitable, and sustainable production. Exploitation of the genetic potential of MAPs is only the beginning of the story, however. The breeding of MAPs must match the development of high-performance cultivars that have already been developed among the major agricultural and horticultural crops. In order to achieve this task effectively, complex approaches will be required in cooperation with experts from different scientific disciplines, including genetics, cytology, molecular genetics, agronomy, botany, and phytopathology.

Evidence of the increasing importance of MAP breeding is demonstrated by the growing number of registered cultivars in Germany during the past decade, from only 10 in 1990 to 66 in 2004 (Fig. 18.17).

Some focal points for future breeding and breeding research on MAPs include:

- preservation and utilization of the genetic resources;
- clarification of the heritability of desired traits;
- development of hybrid variety systems with natural plant breeders' rights protection;
- utilization of the advantages of biotechnological tools;

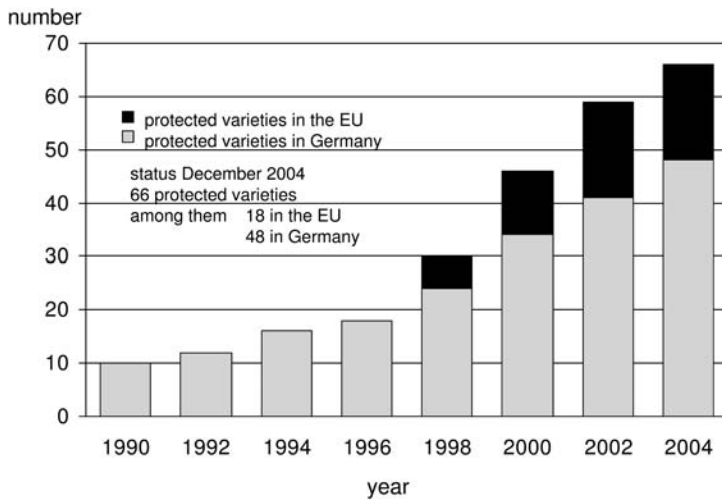


Fig. 18.17 Trends in medicinal and aromatic plant breeding; numbers of protected varieties.

- the generation of lines as donors for important traits and initial material for the breeding procedure; and
- the development of time- and cost-saving methods for quality trait determination.

## References

- 1 Taubenrauch, K., Gabler, J., Rabenstein, F., Pank, F., Hau, B. *Z. Arzneim-Gewürzpfl.* **2001**, 6, 120–124.
- 2 Opinion of the Scientific Committee on Food on estragole (1-Allyl-4-methoxybenzene), European Commission, Health & Consumer Protection Directorate-General, Directorate C – Scientific Opinions, Scientific Committee on Food, SCF/CS/FLAVOUR/6 ADD2 FINAL, 26 September **2001**.
- 3 Pank, F., Schneider, E., Krüger, H. *Z. Arzneim-Gewürzpfl.* **2003**, 8, 165–172.
- 4 Beschreibende Sortenliste Arzneim- und Gewürzpflanzen **2002**, Bundessortenamt, Deutscher Landwirtschaftsverlag GmbH, Hannover, **2002**.
- 5 IPGRI (2004) Descriptors lists. International Plant Genetic Resources Institute. <http://www.ipgri.cgiar.org/system/page.asp?theme=6>.
- 6 Pank, F. *Acta Hort.* **2002**, 576, 129–137.
- 7 Rey, C. *Revue suisse Vitic. Arboric. Hortic.* **1994**, 26(4), 249–250.
- 8 Lenzi, A., Lombardi, P., Nesi, B., Alabassini, A., Landi, R., Tesi, R. *Agricoltura Mediterranea* **2003**, 133(1), 36–42.
- 9 Punia, S.S., Ramkrishna, K. *Natl. J. Plant Improve.* **2002**, 4(2), 62–63.
- 10 Slavova, Y., Zayova, E., Krastev, S. *Bulg. J. Agric. Sci.* **2004**, 10(3), 329–332.
- 11 Ghiorghita, G.I., Toth, T.E., Onisei, T., et al. *Rev. Roumaine de Biochimie* **1987**, 24(4), 299–306.
- 12 Delhaize, E., Robinson, N.J., Jackson, P.J. *Plant Mol. Biol.* **1989**, 12(5), 487–497.
- 13 Saxena, P.K., King, J. *Plant Physiol.* **1988**, 6(3), 863–867.
- 14 Zongniao, S., Jhgxian, C., Fan, N. Selection of mutants through hot-pepper somaclonal variation. Abstracts VIIth international Congress on Plant Cell and Tissue culture (IAPTC), Amsterdam, June 24–29, **1990**, A4-106, 170.

- 15 Kostenyuk, I., Lubaretz, O., Borisyuk, N., Voronin, V., Cherep, N., Stockigt, J., Gleba, Y. Somatic hybridization in Apocynaceae family. Abstracts VIIth International Congress on Plant Tissue and Cell Culture (IAPTC), Amsterdam, June 24–29, 1990, A8-35, 213.
- 16 Gupta, P.P., Schieder, O., Gupta, M. *Mol. Gen. Genet.* **1984**, 197(1), 30–35.
- 17 Saito, K., Yamazaki, M., Murakoshi, I. *J. Nat. Prod.* **1992**, 55, 149–182.
- 18 Teuscher, E., Melzig, F., Lindequist, U. *Biogene Arzneimittel. Ein Lehrbuch der Pharmazeutischen Biologie*. Wissenschaftliche Verlagsgesellschaft mbH, Stuttgart, **2004**.
- 19 Chitty, J.A., Allen, R.S., Fist, A.J., Larkin, P.J. *Funct. Plant Biol.* **2003**, 30, 1045–1058.
- 20 Allard, R.W. *Principles of Plant Breeding*, 2nd edition. Wiley-VCH, **1999**, 254.
- 21 Wricke, G., Weber, E. *Quantitative genetics and selection in plant breeding*. De Gruyter, **1986**, p. 405.
- 22 Kuckuck, H., Kobabe, G., Wenzel, G. *Grundzüge der Pflanzenzüchtung*. Walter de Gruyter, Berlin, New York, **1985**.
- 23 Kaushal, P., Malaviya, D.R., Roy, A.K. *Curr. Sci. India* **2004**, 87(3), 292–296.
- 24 Spillane, C., Curtis, M.D., Grossniklaus, U. *Nat. Biotechnol.* **2004**, 22(6), 687–691.
- 25 Romanenko, L.G., Nevkrytaya, N.V. Apomixis in coriander. *Doklady Vsesoyuznoi Ordena Lenina i Ordena Trudovogo Krasnogo Znameni Akademii Sel'skokhozyaistvennykh Nauk Imeni V. I. Lenina* **1984**, 8, 16–17.
- 26 Kobakhidze, L.A. Apomictic development of the endosperm in *Ocimum basilicum* L. *Bull. Acad. Sci. Georgian SSR* **1981**, 104(2), 433–436.
- 27 Khokhlov, S.S. *Apomixis and breeding*. **1976**, p. 346.
- 28 Pank, F., Matzk, F., Kästner, U., Blüthner, W.D., Foltys de Garcia, E., Meister, A., Ryschka, U., Schumann, G. *Euphytica* **2003**, 134, 77–84.
- 29 Kästner, U., Pank, F. *Z. Arzneim-Gewürzpfl.* **2004**, 9, 31–34.
- 30 Matzk, F., Meister, A., Schubert, I. *Plant* **2000**, 21, 97–108.
- 31 Hutter, I., Grotcass, C., Harnischfeger, G., Lieberei, R., Feldmann, F. *Z. Arzneim-Gewürzpfl.* **2001**, 6, 35–41.
- 32 Daniel, G., Bomme, U. *Landwirtschaftliches Jahrbuch* **1991**, 68(2), 249–253.
- 33 Delpit, B., Lamy, J., Rolland, F., et al. *J. Essent. Oil Res.* **2000**, 12(3), 387–391.
- 34 Pattnaik, J., Debata, B.K. *Beiträge zur Züchtungsforschung – Bundesanstalt für Züchtungsforschung an Kulturpflanzen* **1996**, 2(1), 330–333.
- 35 Lata, H., Bedir, E., Moraes, R.M., et al. *Acta Hort.* **2004**, 629, 409–414.
- 36 Mandal, J., Pattnaik, S., Chand, P.K. *In Vitro Cell. Dev. Biol. – Plant* **2000**, 36(4), 287–292.
- 37 Prathanturarug, S., Schaffner, W., Berger Buter, K. *Beiträge zur Züchtungsforschung – Bundesanstalt für Züchtungsforschung an Kulturpflanzen* **1996**, 2(1), 304–306.
- 38 Mikula, A., Tykarska, T., Kuras, M., et al. *Beiträge zur Züchtungsforschung – Bundesanstalt für Züchtungsforschung an Kulturpflanzen* **1996**, 2(1), 290–295.
- 39 McCoy, J.A., Camper, N.D. *Hortscience* **2002**, 37, 978–980.
- 40 Sudhakaran, S., Sivasankari, V. *Plant Cell Biotechnol. Mol. Biol.* **2003**, 4(3/4), 185–188.
- 41 Hennig, F., Kadner, R., Junghanns, W., et al. *Z. Arzneim-Gewürzpfl.* **2000**, 5, 160–164.
- 42 Kintzios, S., Nikolaou, A., Skoula, M., et al. *Beiträge zur Züchtungsforschung – Bundesanstalt für Züchtungsforschung an Kulturpflanzen* **1996**, 2(1), 282–285.
- 43 Buchwald, W. *Beiträge zur Züchtungsforschung – Bundesanstalt für Züchtungsforschung an Kulturpflanzen* **1996**, 2(1), 327–329.
- 44 Saez, F. *Beiträge zur Züchtungsforschung – Bundesanstalt für Züchtungsforschung an Kulturpflanzen* **1996**, 2(1), 311–314.
- 45 Bohr, C., Zobel, I., Diekmann, W., et al. *Beiträge zur Züchtungsforschung – Bundesanstalt für Züchtungsforschung an Kulturpflanzen* **1996**, 2(1), 342–345.
- 46 Lofgren, A. *Ecoscience* **2002**, 9, 503–508.
- 47 Knuth, P. *Handbuch der Blütenbiologie*. Verlag von Wilhelm Engelmann, Leipzig, **1898**, 2. Band 1. Teil.
- 48 Knuth, P. *Handbuch der Blütenbiologie*. Verlag von Wilhelm Engelmann, Leipzig, **1899**, 2. Band 2. Teil.
- 49 Becker, T. Blütenbiologische Studien an Zwiebel, Möhren, Sellerie und Petersilie.

- In: Gärtner, R., Woermann, E., Roemer, T. (Eds.), *Kühn-Archiv*, Band 60, Paul Parey, Berlin, 1944, pp. 466–492.
- 50 Konvicka, O., Fischbeck, G. *Allium Newsl. 1984*, 1, 42–55.
- 51 Heeger, E.F. *Handbuch des Arznei- und Gewürzpflanzenanbaues, Drogen-gewinnung*. Deutscher Bauernverlag, Berlin, 1956.
- 52 de Nettancourt, D. *Selfincompatibility in angiosperms*. Springer-Verlag, Berlin u.a., 1977.
- 53 Brewbaker, J.L. *Ind. J. Genet. Plant Breeding 1959*, 19, 121–133.
- 54 Silova, S.N. *Ref. Z. Moskva, Rastenievodstvo 1973*, 14, 71.
- 55 Kaul, L.H. *Male sterility in higher plants*. Springer-Verlag, New York, Inc.; Secausus, New Jersey, USA; Berlin, West Germany, 1988.
- 56 Zijlstra, K. *Recueil des Travaux Botaniques Neelandais 1916*, 13, 199–399.
- 57 Toxopeus, H., Lubberts, J.H. In: Németh, E. (Ed.), *Caraway. The genus Carum*. Harwood Academic Publishers, 1998, pp. 105–128.
- 58 Romanenko, L.G., Nevkrytaya, N.V., Kuznetsova, E.Y. *Seleksiya i Semenovodstvo 1992*, 1, 25–28.
- 59 Mihalea, A. *Comunicari de Botanica 1971*, 12, 481–488.
- 60 Seidler-Lozykowska, K., Dabrowska, J. *Biologia kwitnienia i owocowania. Herba Polonica 1996*, 42(2), 83–87.
- 61 Singh, D., Rajput, S.S., Sastry, E.V.D. A new method of emasculation in fennel (*Foeniculum vulgare*). SO Spices and aromatic plants: challenges and opportunities in the new century. Contributory papers. Centennial conference on spices and aromatic plants, Calicut, Kerala, India, 20–23 September, 2000, pp. 82–83.
- 62 Matzk, F., Hammer, K., Schubert, I. *Sexual Plant Reprod. 2003*, 16(2), 51–58.
- 63 Stein, M. *Herba Hungarica 1966*, 5, 112–118.
- 64 Pank, F., Vender, C., van Niekerk, L., Junghanns, W., Langbehn, J., Blüthner, W.D., Novak, J., Franz, C. J. *Herbs, Spices Medicinal Plants 2002*, 9, 31–38.
- 65 Wagner, C., Marquard, R., Friedt, W., Ordon, F. *Z. Arznei-Gewürzpfl. 2001*, 6, 216–221.
- 66 Rey, C. *Revue suisse Agric 1995*, 27(4), 239–246.
- 67 Pank, F. *Nachrichten aus der Bundesanstalt für Züchtungsforschung an Kulturpflanzen 1994*, 2(2), 40–48.
- 68 Elena-Rosello, J.A. Cytotaxonomic and evolutionary studies in Thymus (Labiata); relationships of the members of section Thymus. *Anales – Instituto Botanico A J Cavarilles 1981*, 38(1), 51–59.
- 69 Kheyr-Pour, A. *J. Heredity 1981*, 72(1), 45–51.
- 70 Ricciardelli d'Albore, G.C. *Apidologie 1986*, 17(2), 107–124.
- 71 Damme, J.M.M., Delden, W. *Heredity 1982*, 49(3), 303–318.
- 72 Correns, C. *Berichte der Deutschen Botanischen Gesellschaft 1908*, 26A, 686–701.
- 73 Aedtner D. *Drogenreport 1996*, 9(15), 35–36.
- 74 Vogel, G. *Handbuch des speziellen Gemüsebaus*. Eugen Ulmer, Stuttgart, 1996.
- 75 Belhassen, E., Trabaud, L., Couvet, D., Gouyon, P.H. *Evolution 1989*, 43, 662–667.
- 76 Mewes, S., Pank, F. *Z. Arznei-Gewürzpfl. 2004*, 9, 167–173.
- 77 Roemer, T., Rudolf, W. *Handbuch der Pflanzenzüchtung, Paul Parey, 2. Auflage*, Band 5, Berlin und Hamburg, 1961.
- 78 Kempf, I. M. *Grundlagen zur Züchtung von Valeriana officinalis L., Baldrian*. Thesis, Justus Liebig-Universität Giessen 1986, p. 206.
- 79 Pank, F., Schwarz, S. *Z. Arznei-Gewürzpfl. 2005*, 10, 194–197.
- 80 Novak, J., Bitsch, C., Marn, M., Franz, C. *Z. Arznei-Gewürzpfl. 2005*, 10(2), 98–99.
- 81 Mewes, S., Pank, F. Influence of cold temperature and light on the flower induction of thyme (*Thymus vulgaris* L.). *Eur. J. Hort. Sci. 2006*, 71 (in press).
- 82 Zoberi, G., Carmi, S., Evenor, D., Shlomo, E., Reuveni, M. *J. Hort. Sci. Biotechnol. 2003*, 78, 100–103.
- 83 Strasburger, E. *Lehrbuch der Botanik*. Spektrum Akademischer Verlag, Heidelberg-Berlin, 2002.
- 84 Marchese, J.A., Casiraghi, V., Lira, R., et al. *Acta Hort. 2002*, 569, 275–280.

- 85 Ulrich, D., Pank, F. *Beiträge zur Züchtungsforschung – Bundesanstalt für Züchtungsforschung an Kulturpflanzen* 1996, 2(1), 411–413.
- 86 Svabova, L., Lebeda, A. J. *Phytopathol.* 2005, 153(1), 52–64.
- 87 Schulte, J. *In vitro androgenesis and interspecific crossing as fundamentals for breeding of Hypericum perforatum L.* Dissertation University Basel, Grauer Verlag, Stuttgart, 1998.
- 88 Alan, A.R., Brants, A., Cobb, E., Goldschmied, P.A., Mutschler, M.A., Earle, E.D. *Plant Sci.* 2004, 167, 1055–1066.
- 89 Herouart, D., Sangwan, R.S., Fliniaux, M.A., Sangwan-Norreel, B.S., *Planta Med.* 1988, 54(1), 14–17.
- 90 Badea, A., Iordan, M., Mihalea, A. *Revue Roumaine de Biologie, Biologie Vegetale* 1985, 30(1), 63–71.
- 91 Raghavan, V., Nagmani, R. *Can. J. Botany* 1989, 67(1), 247–257.
- 92 Forster, B.P., Hansen, M., Wedzony, M., Bohanec, B., Rasmussen, S., Custers, J., Tuvesson, S., Weyen, J. *Aspects Appl. Biol.* 2004, 72, 163–168.
- 93 Pank, F., Langbehn, J., Novak, J., Junghans, W., Franke, J., Bitsch, C., Scartezzini, F. *Z. Arzneim-Gewürzpfl.* 1999, 4, 141–150.
- 94 Orth, M., Juchelka, D., Mosandl, A., Czygan, F.C. *Pharmazie* 2000, 55, 456–459.
- 95 Wagner, C., Marquard, R., Friedt, W., Ordon, F. *Z. Arzneim-Gewürzpfl.* 2001, 6, 216–221.
- 96 Tanksley, S.D., Orton, T.J. *Isozymes in Plant Genetics and Breeding. Part B*, viii, 1983, p. 472.
- 97 Beckmann, J.S., Soller, M. *Euphytica* 1986, 35, 111–124.
- 98 Williams, J.G.K., Kubelik, A.R., Livak, K.J., Rafalski, J.A., Tingey, S.V. *Nucleic Acids Res.* 1990, 18, 6531–6535.
- 99 Vos, P., Hogers, R., Bleeker, M., Reijans, M., Vandelee, T., Hornes, M., Frijters, A., Pot, J., Peleman, J., Kuiper, M., Zabeau, M. *Nucleic Acids Res.* 1995, 23, 4407–441.
- 100 Klocke, E., Langbehn, J., Grewe, C., Pank, F. *J. Herbs, Spices Medicinal Plants* 2002, 9(2/3), 171–176.
- 101 Schulz, H., Krüger, H., Steuer, B., Pank, F. *Z. Arzneim-Gewürzpfl.* 1999, 4, 62–67.
- 102 Sartoratto, A., Augusto, F. *Chromatographia* 2003, 57(5-6), 351–356.
- 103 Schulz, H., Drews, H.-H., Quilitzsch, R., Krüger, H.J. *Near Infrared Spectrosc.* 1998, 6, A125–A130.
- 104 Ulrich, D., Trensche, A. *Beiträge zur Züchtungsforschung – Bundesanstalt für Züchtungsforschung an Kulturpflanzen* 1996, 2(1), 408–410.
- 105 Distler, D., Schulz, H. *Z. Arzneim-Gewürzpfl.* 2005, 10(1), 53–57.
- 106 Langer, T., Möstl, E., Chizzola, R., Gutleb, R. *Planta Med.* 1996, 62(3), 267–271.
- 107 Richter, M. *Einführung in die Farbmatrik*, 2nd edition. Verlag Walter de Gruyter, Berlin, New York, 1981.
- 108 Pank, F., Schnäkel, W., Schröder, A., Langbehn, J., Junghans, W. *Fleischwirtschaft* 2000, 80(2), 89–92.
- 109 Scholze, P., Pank, F., Foltys de Garcia, E., Blüthner, W.D., Dehe, M., Schneider, E. *Z. Arzneim-Gewürzpfl.* 2001, 6, 209–215.
- 110 Shul'ga, E.B., Zhurbenko, M.M. *Trudy Vsesoyuznogo Nauchno-Issledovatel'skogo Instituta Efiromaslichnykh Kul'tur* 1984, 16, 72–80.
- 111 Martynovskaya, N.M. Producing a *Helminthosporium* infection regime and evaluating opium poppy varieties under artificial infection. Tr. 7 Konf. mol. uchenykh VNII lekarstv. rast., Moskva, April 1985. Chapter 1. (Dep. 3339V), 1986, pp. 225–231.
- 112 Kusterer, A., Gabler, J., Ehrig, F., Rabenstein, F., Kühne, T. *Z. Arzneim-Gewürzpfl.* 2001, 6, 125–128.
- 113 Bellardi, M.G., Rubies-Autonell, C., Marotti, M. Virus infections on medicinal and aromatic plants in Emilia-Romagna. IV Report. (Infezioni da virus in piante officinali in Emilia-Romagna. IV Contributo.) Atti, Giornate fitopatologiche, Basella di Pine, Trento, Italy, 7–11 April 2002, Volume 2, pp. 593–598.
- 114 Novak, J. *Origanum majorana L. Ertragsparameter, Blattmorphologie und Verteilung der Drüsenschuppen sowie Evaluierung einer Methode zur schnellen Abschätzung des Gehaltes an ätherischem*

- Öl. Dissertation, Institut für Botanik der Universität für Bodenkultur, Wien, 1998.
- 115 Franke, J., Pank, F., Ahne, R. *Beiträge zur Züchtungsforschung – Bundesanstalt für Züchtungsforschung an Kulturpflanzen* 1996, 2, 426–428.
- 116 Büter, B., Messmer, M., Feil, B., Simmen, U., Jäggi, R., Berger Büter, K., Schaffner, W. *Z. Arzneim-Gewürzpfl.* 2003, 8, 184–187.
- 117 Singh, R.K., Mishra, S.N., Meenakshi Malik Bakshi, C.S., Chittalanga, R.K., Dwivedi, S.K., Rawat, A.K., Garg, S.K., Butchaiah, G. *Physiol. Mol. Biol. Plants* 2002, 8(1), 125–132.
- 118 Johnson, B.M., Bolton, J.L., van Breemen, R.B. *Chem. Res. Toxicol.* 2001, 14, 1546–1551.
- 119 Stasi, L.C. di, Gomes, J.C., Vilegas, W. *Chem. Pharm. Bull.* 1999, 47, 890–893.

## 19

Camptothecin Production in Cell Cultures of *Ophiorrhiza* Species

Takashi Asano, Hiroshi Sudo, Mami Yamazaki, and Kazuki Saito

## 19.1

## Introduction

Camptothecin [1] is well-known monoterpenoid indole alkaloid, originally identified in the extracts of *Camptotheca acuminata* during a screening for antitumor agents by the National Cancer Institute (NCI) in the United States [1]. The interest in camptothecin was stimulated by the characterization of its specific inhibitory activity to DNA topoisomerase I [2, 3]. Although camptothecin itself cannot be used clinically due to severe cytotoxicity, semi-synthetic water-soluble camptothecin derivatives, topotecan (2) and irinotecan (3), are currently used for the treatment against cancers of lung, cervix, ovaries [4], colon [5], and other organs [6] (Fig. 19.1). The worldwide market of clinically used camptothecin derivatives has currently reached US\$ one billion per year, which represents approximately one ton of camptothecin in terms of raw materials. It has already reported that camptothecin is produced in some species such as *Ervatamia heyneana* (Apocynaceae) [7], *Nothapodytes foetida* [8], *Merrilliodendron megacarpum* (Icacinaeae) [9] and *Ophiorrhiza mungos* (Rubiaceae) [10]. In the study of the genus *Ophiorrhiza* species, camptothecin was also accumulated in some *Ophiorrhiza* species distributed in Japan [11, 12].

The genus *Ophiorrhiza* widely distributes about 150 species around tropical and subtropical Asia [13], and many of these species produce indole alkaloids [14, 15].

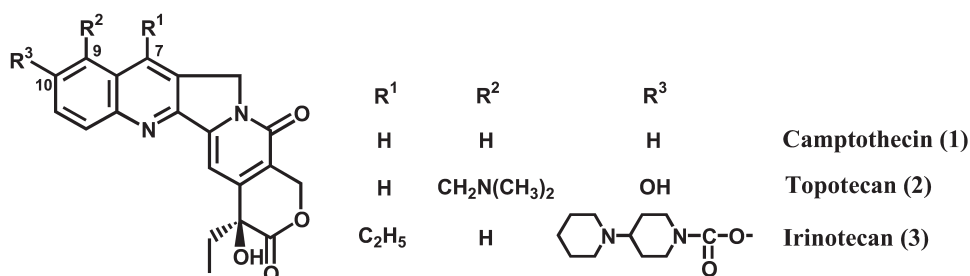
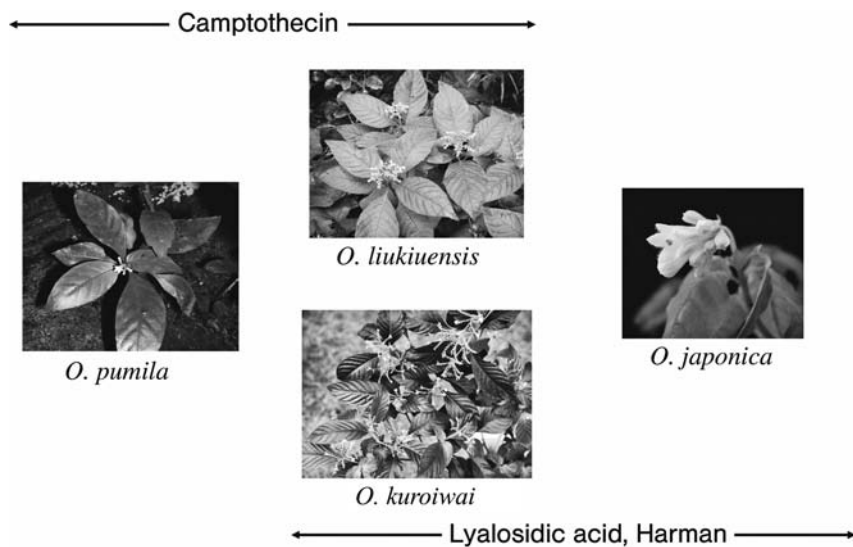


Fig. 19.1 Clinically used camptothecin derivatives, topotecan, and irinotecan.

With regard to the chemical constituents of *Ophiorrhiza* species distributed in Japan, *O. pumila* accumulated camptothecin and its related alkaloids [11, 16], while *O. japonica* accumulated  $\beta$ -carboline-type alkaloids, such as lyalosidic acid and harman [17, 18]. By comparison, *O. liukiensis* [19] and *O. kuroiwai* [20], which was shown to be an interspecies hybrid of *O. pumila* and *O. liukiensis* (H. Sudo et al., in preparation), accumulated both camptothecin-related alkaloids and  $\beta$ -carboline-type alkaloids (M. Kitajima et al., unpublished results) (Fig. 19.2). Therefore, these *Ophiorrhiza* species are important as the resources producing various alkaloids, including camptothecin.

In this chapter, we describe the production of camptothecin-related alkaloids by tissue cultures of these *Ophiorrhiza* species, and the elucidation of the mechanism of camptothecin biosynthesis using hairy root cultures.



**Fig. 19.2** The genus *Ophiorrhiza* species distributed in Japan.

Note: A color version of this figure is available in the color plate section.

## 19.2

### Tissue Cultures

#### 19.2.1

##### Establishment of Tissue Cultures

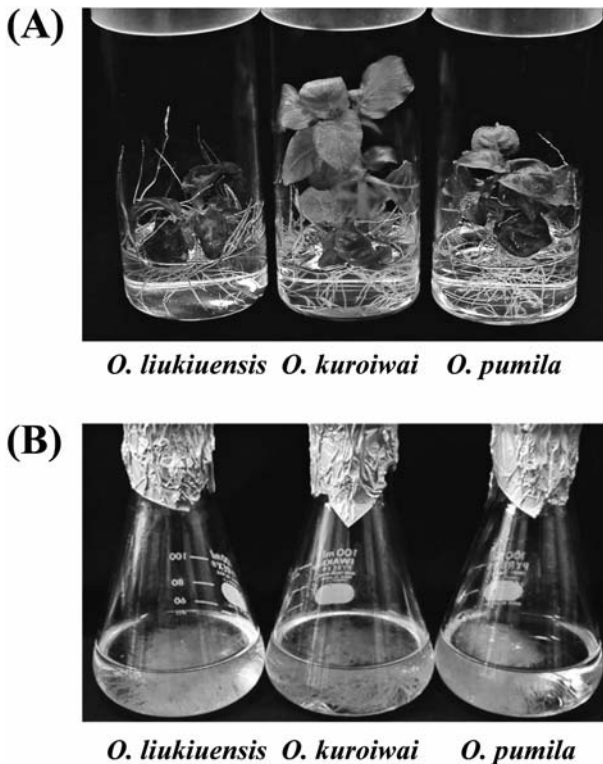
In tissue culture, the productivities and patterns of secondary metabolites depend on morphology and culture conditions. Aseptic plants and hairy roots of *Ophiorrhiza* species were established as one method of effectively producing camptothecin.



### 19.2.1.1 Aseptic Plants

Aseptic plants of three types of camptothecin-producing *Ophiorrhiza* species, *O. pumila*, *O. liukiensis* and *O. kuroiwai*, were established according to the following protocols. Established aseptic plants were maintained at 25 °C with a photoperiod of 18 h light (2000 lux)/6 h dark, and subcultured every three months by transferring the shoots on half-strength Murashige and Skoog [21] (MS) medium containing 1% sucrose and 0.2% gellan gum in a test tube [22] (Fig. 19.3A).

*O. pumila*: The plants of *O. pumila* were collected in Amamiyoshima Island, Kagoshima, Japan and grown in a greenhouse. Callus cultures originally derived from the leaf segment were maintained on MS medium containing 2% sucrose and 0.7% agar supplemented with 1 mg L<sup>-1</sup> indole 3-acetic acid in the light (750 lux) for four weeks and then transferred on MS medium containing 2% sucrose and 0.7% agar supplemented with 1 mg L<sup>-1</sup> kinetin to regenerate the plant. After the first four weeks, the color of the calli changed from light yellow to brown.



**Fig. 19.3** Established tissue cultures of *Ophiorrhiza liukiensis*, *O. kuroiwai*, and *O. pumila*. (A) Aseptic plants cultured for five weeks on half-strength MS medium containing 1% sucrose and 0.2% gellan gum

in test tubes. (B) Hairy roots cultured for four weeks in B5 liquid medium containing 2% sucrose. (Reproduced from [22], with permission.) Note: A color version of this figure is available in the color plate section.

After 10 weeks, the differentiation of callus into green leaf buds was observed, and excised regenerated plants were transferred on half-strength MS medium containing 1% sucrose and 0.2% gellan gum in a test tube [23].

*O. liukiuensis*: The seeds of *O. liukiuensis* were collected in Ishigaki Island, Okinawa, Japan. The seeds were sterilized and germinated on half-strength MS medium containing 1% sucrose and 0.2% gellan gum in a test tube [22].

*O. kuroiwai*: The plants of *O. kuroiwai* were collected in Iriomote Island, Okinawa, Japan and grown in a greenhouse. The young leaves were sterilized with 1% sodium hypochlorite solution and cultured on half-strength MS medium containing 1% sucrose, 0.2% gellan gum, 0.5  $\mu\text{M}$  1-naphthalene acetic acid and 5  $\mu\text{M}$  kinetin. After 40 days, regenerated shoots were excised and transferred on half-strength MS medium containing 1% sucrose and 0.2% gellan gum in a test tube [22].

#### 19.2.1.2 Hairy Roots

For induction of hairy roots, the aseptic plants of three types of *Ophiorrhiza* species, *O. pumila*, *O. liukiuensis* and *O. kuroiwai*, were infected with *Agrobacterium rhizogenes* 15834 by scratching the stems [24]. After several weeks, the hairy roots which emerged from stem fragments were excised and cultured on B5 [25] medium containing 2% sucrose and 0.2% gellan gum supplemented with 200 mg L<sup>-1</sup> cefotaxime (Claforan®) at 25 °C under dark conditions. After the several subcultures, over 40 lines for *O. pumila*, 11 lines for *O. liukiuensis* and seven lines for *O. kuroiwai* survived and grew rapidly. The established hairy root cultures were subcultured every three to four weeks in B5 liquid medium containing 2% sucrose at 25 °C on a rotary shaker (80 rpm) under dark conditions [22, 26] (Fig. 19.3B).

#### 19.2.2

##### Camptothecin Production and Metabolite Profiles

The camptothecin contents in shoots and roots of five-week-old aseptic plants of *O. liukiuensis*, *O. kuroiwai* and *O. pumila* were analyzed [22]. Although the camptothecin production per tissue weight was highest in roots of *O. pumila*, the production per tube was highest in *O. kuroiwai* because of a higher growth rate than the other two species. The concentrations and total amounts of camptothecin in *O. liukiuensis* were lower than those of *O. kuroiwai* and *O. pumila*.

Camptothecin was accumulated to higher levels in hairy root lines of *O. pumila* than in those of *O. liukiuensis* and *O. kuroiwai* (Table 19.1). The camptothecin accumulation and increased growth rate of *O. pumila* hairy root [24, 26] are the best results in reports of camptothecin production by *in-vitro* tissue cultures [27–33].

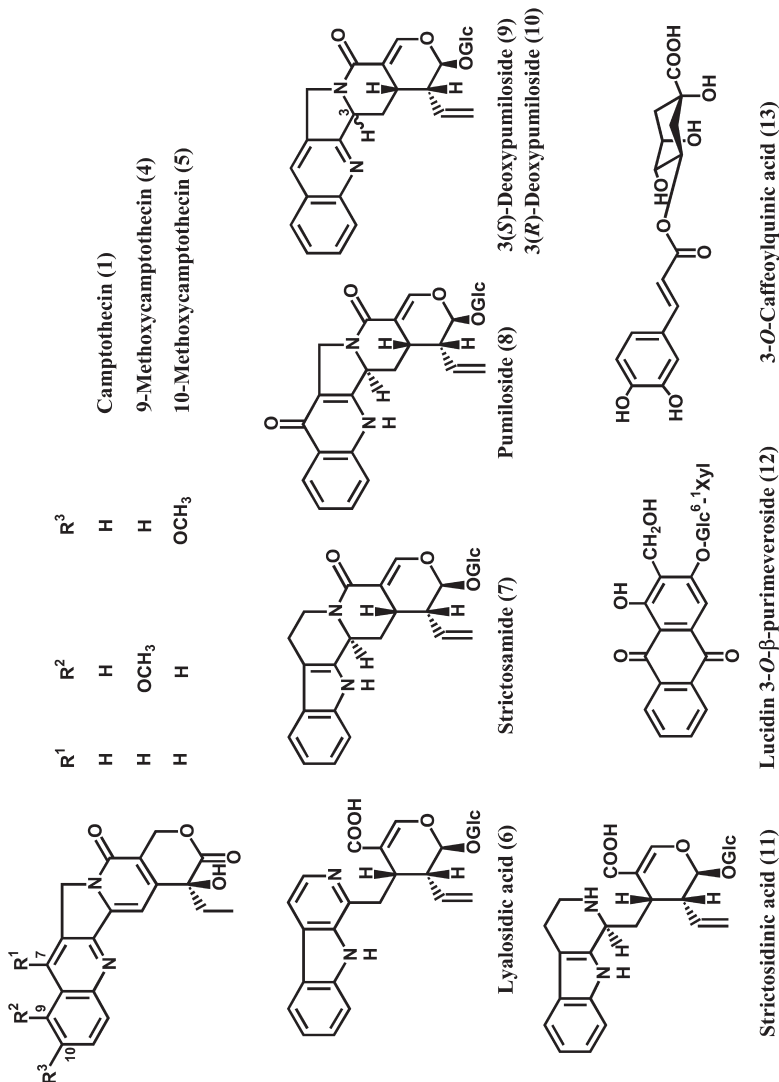
The patterns of secondary metabolites in the aseptic plants and hairy roots of *Ophiorrhiza* species were profiled by HPLC/DAD/ESI/MS [22] (Figs. 19.4 and 19.5). The metabolite patterns of *O. liukiuensis* and *O. kuroiwai* were very similar both in shoots and roots. For example, 10-methoxycamptothecin (5) was detected

**Table 19.1** Hairy roots induced from *Ophiorrhiza* species.

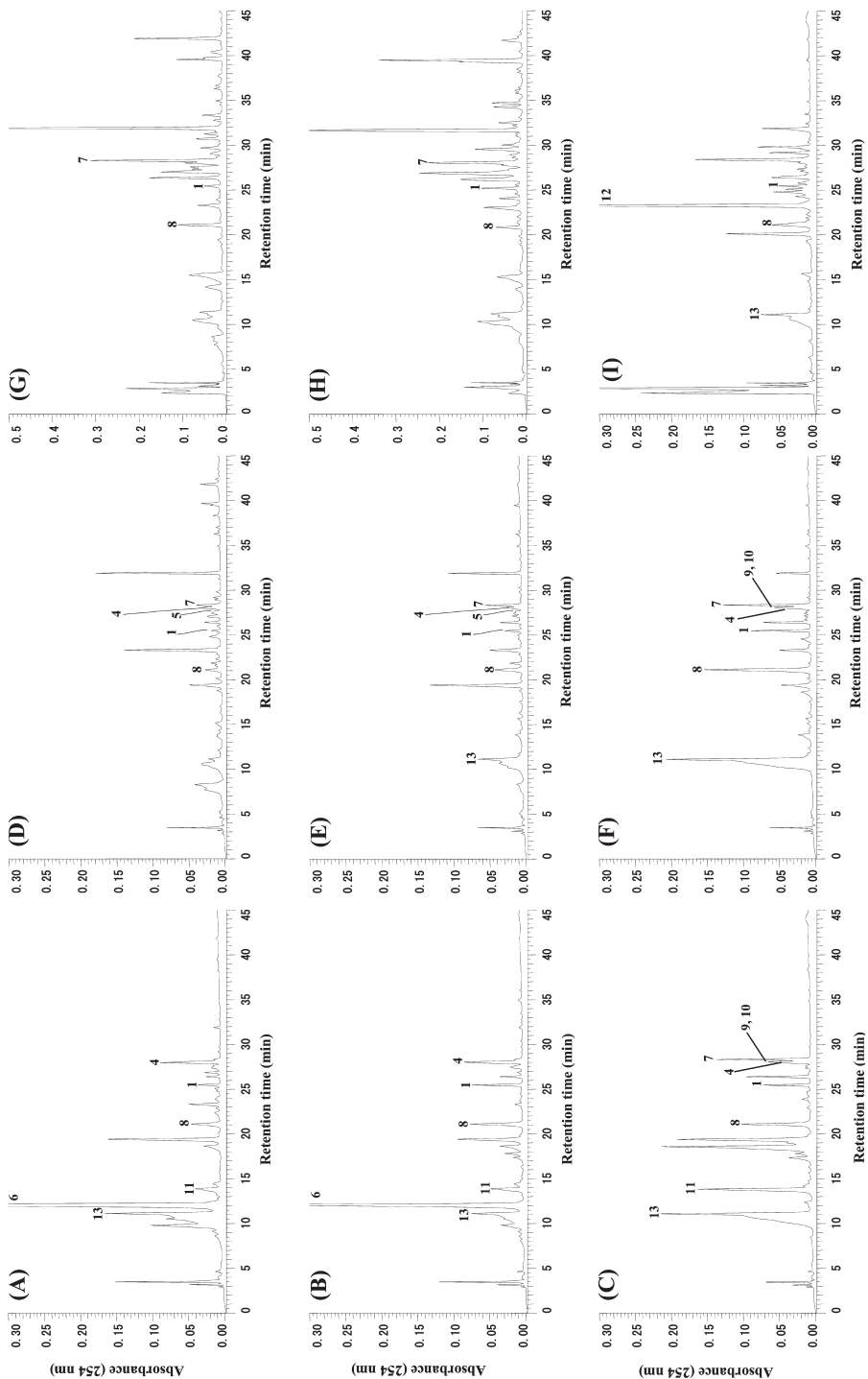
Plant species	No. of established lines	Camptothecin content <sup>a</sup> [ $\mu\text{g g}^{-1}$ dry weight]
<i>O. liukiensis</i>	11	83.0 $\pm$ 27.4
<i>O. kuroiwai</i>	7	219.3 $\pm$ 31.4
<i>O. pumila</i>	19 <sup>b</sup>	788.5 $\pm$ 49.7

<sup>a</sup> Hairy roots cultured in B5 liquid medium for three weeks. Values are mean  $\pm$  SD.

<sup>b</sup> 19 hairy root lines were randomly selected from over 40 lines.



**Fig. 19.4** Chemical structures of secondary metabolites detected in tissue cultures of *Ophiorrhiza* species.



**Fig. 19.5** HPLC chromatograms of extracts of plant cultures.

- (A) *O. liukuensis* sterile plant shoots.
- (B) *O. kuroiwai* sterile plant shoots.
- (C) *O. pumila* sterile plant shoots.
- (D) *O. liukuensis* sterile plant roots.
- (E) *O. kuroiwai* sterile plant roots.
- (F) *O. pumila* sterile plant roots.
- (G) *O. liukuensis* hairy roots.
- (H) *O. kuroiwai* hairy roots.
- (I) *O. pumila* hairy roots. The peak numbers

correspond to the compound numbers in Figure 19.4. HPLC conditions were as follows: column, Mightysil RP-18 (4.6×250 mm); gradient, linear gradient from solvent A to solvent B (0–35 min), isocratic at 100% of solvent B (35–40 min), solvent A (20% methanol, 0.2% acetic acid in H<sub>2</sub>O), solvent B (90% methanol, 0.025% acetic acid in H<sub>2</sub>O); flow rate, 0.8 mL min<sup>-1</sup>; column temperature, 37°C. (Reproduced from [22], with permission.)

in the roots of *O. liukuensis* and *O. kuroiwai*, but not in *O. pumila*. Lyalosidic acid (6) was accumulated in the shoots of *O. liukuensis* and *O. kuroiwai*, but not in *O. pumila*. 3(*S*)- and 3(*R*)-Deoxypumilosides (9, 10) were only detected in *O. pumila*. Camptothecin (1), 9-methoxycamptothecin (4), strictosamide (7), pumiloside (8), strictosidinic acid (11) and 3-*O*-caffeoylquinic acid (13) were detected in all three species. The metabolite patterns of the hairy roots (Fig. 19.5G–I) were not identical to those of aseptic plants. In addition to camptothecin-related alkaloids, several unidentified anthraquinones speculated from their UV spectra were present in hairy roots.

### 19.2.3

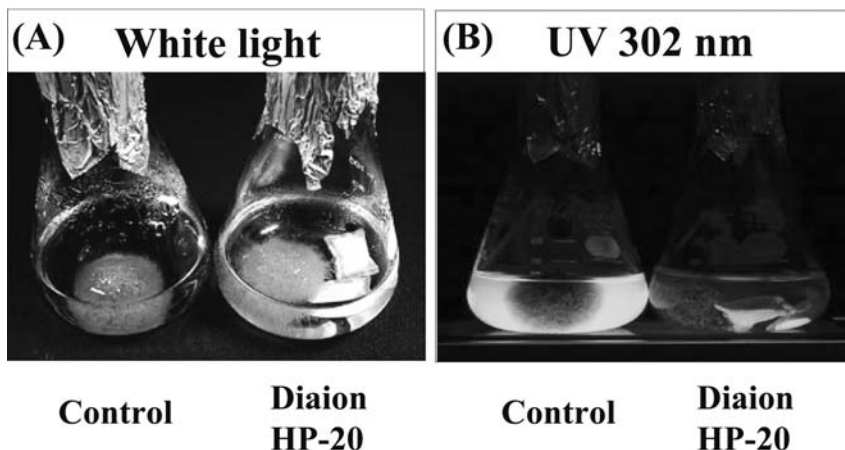
#### Excretion of Camptothecin into the Culture Medium

Excretion of Camptothecin from the hairy roots of *Ophiorrhiza* species into the culture medium was confirmed by HPLC analysis [22, 24]. Camptothecin accumulation in the medium of *O. pumila* hairy root cultures could also be increased by culturing with a polystyrene resin (Diaion HP-20), onto which camptothecin was adsorbed (Fig. 19.6). The amount of camptothecin excreted into the medium increased fivefold by culturing with Diaion HP-20, but total camptothecin production in hairy root cultures was little enhanced by the presence of the resin. Camptothecin adsorbed by Diaion HP-20 was easily recovered by eluting the resin with methanol to provide a fairly pure product [24].

### 19.2.4

#### Camptothecin Production in Bioreactors

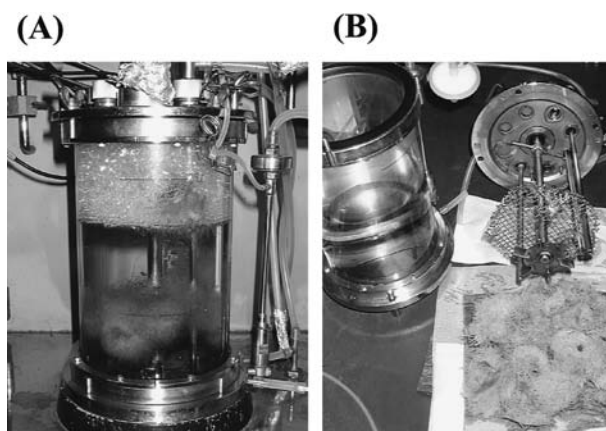
Camptothecin production by tissue culture has been attempted with dedifferentiated cell cultures, mainly from *C. acuminata* [28, 29] and *N. foetida* [30,31], but commercial-scale production was not successful. As mentioned earlier, *O. pumila* hairy roots produce a good yield of camptothecin, which is excreted into the culture medium. In an attempt to produce large quantities of camptothecin, the hairy root culture system was scaled-up by using a 3-L bioreactor [37].



**Fig. 19.6** Excretion of camptothecin into the culture medium. Hairy roots cultured for four weeks in an Erlenmeyer flask were visualized under (A) white light and (B) ultraviolet light at 302 nm. The strong fluorescence under

ultraviolet irradiation is due to camptothecin having been excreted into the medium. Note: A color version of this figure is available in the color plate section.

For inoculation into the bioreactor, the hairy roots were cut into segments of ca. 1 cm length. During the eight-week culture period, the root segments became trapped randomly on the stainless net placed at the bottom of bioreactor to prevent physiological stress (Fig. 19.7). Details of the final biomass and camptothecin yields over the culture period in the bioreactor are listed in Table 19.2. Total pro-



**Fig. 19.7** (A) Hairy root growth of *O. pumila* in the 3-L bioreactor after eight weeks' culture. (B) Harvested hairy roots of *O. pumila* after culture. Note: A color version of this figure is available in the color plate section.

**Table 19.2** Camptothecin (CPT) productivity data in the 3-L bioreactor after eight weeks' culture.<sup>a</sup>

Working volume (L)	2.5
Final fresh weight (g)	218 ± 31
Biomass yield (g L <sup>-1</sup> )	87.2 ± 12.4
Growth rate (fold week <sup>-1</sup> )	1.47 ± 0.03
Final CPT concentration in hairy root (% fresh weight)	0.0085 ± 0.0018
CPT yield (mg L <sup>-1</sup> )	8.7 ± 1.3
CPT productivity (mg L <sup>1</sup> week <sup>-1</sup> )	1.1 ± 0.2

<sup>a</sup> Culture conditions: 25 °C, 60 rpm, 0.25 L min<sup>-1</sup> under ambient light. Data are mean ± SD (n = 3).

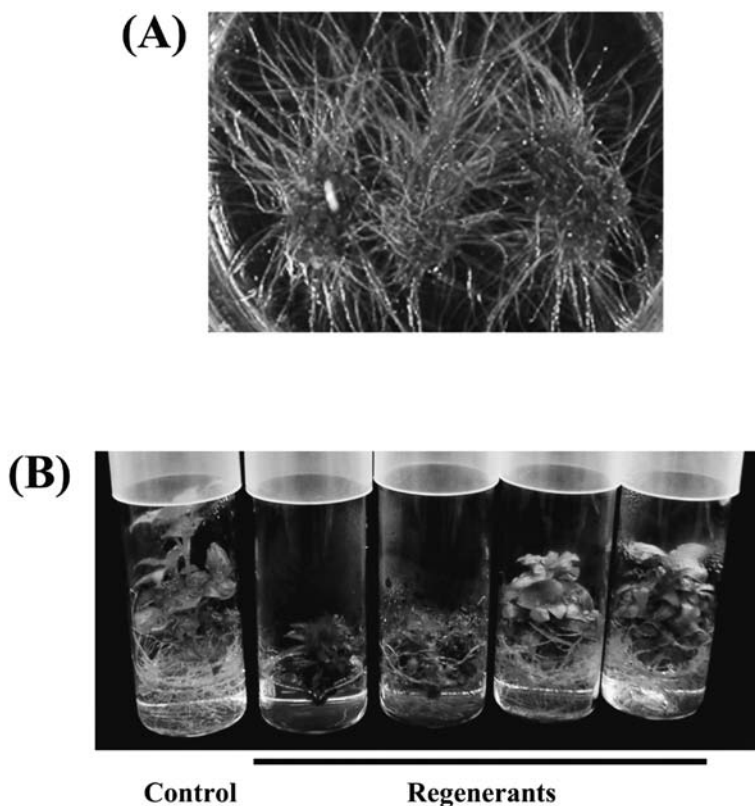
duction of camptothecin was 22 mg, with 3.6 mg (16.5%) being excreted into the liquid medium. Clearly, camptothecin productivity by hairy root cultures of *O. pumila* was maintained on scale-up to the bioreactor, and this represents a favorable method for large-scale production.

### 19.2.5

#### Regeneration of Transformed Plants from Hairy Roots

In order to establish an efficient transformation and regeneration system accumulating camptothecin, a method was developed to regenerate *O. pumila* plants from hairy roots [26].

*O. pumila* hairy roots aged approximately one month regenerated shoot buds in the dark. After being transferred onto half-strength MS medium under light (light:dark cycle 18:6 h) for two weeks, these buds grew to greenish shoots. The inoculum size of hairy roots and the light conditions affected the regeneration rate. For example, when a small quantity of young hairy roots was cultured under light conditions, they turned brown and moribund, without plant regeneration. In contrast, a 1-cm cluster of hairy roots, which had been subcultured in the dark for one month, was effectively regenerated into shoot buds under light conditions (Fig. 19.8A). Furthermore, the shoot buds formed especially on relatively old parts of the hairy roots. These findings indicate that two conditions – a sizeable mass of hairy roots and light exposure after culture in the dark – are important for initiating shoot regeneration from *O. pumila* hairy roots. The eventual rate of regeneration was >83% (33 of 40 randomly selected hairy root lines). The regenerated plants showed typical characteristic features of hairy root-derived plants, such as shortened internodes and malformed leaves (Fig. 19.8B). The regenerated plants were found to accumulate from 66 to 111% of camptothecin compared to that in wild-type *O. pumila*, and with a similar alkaloid pattern.



**Fig. 19.8** Camptothecin content of transgenic regenerated plants from hairy roots. (A) Regeneration of transgenic *O. pumila* plants from hairy roots. Regenerated shoots emerged from hairy roots after five weeks of culture under light conditions. (B) The shapes of regenerated plants cultured on half-strength MS medium containing 1% sucrose and 0.2% gellan gum in test tubes. Note: A color version of this figure is available in the color plate section.

### 19.3

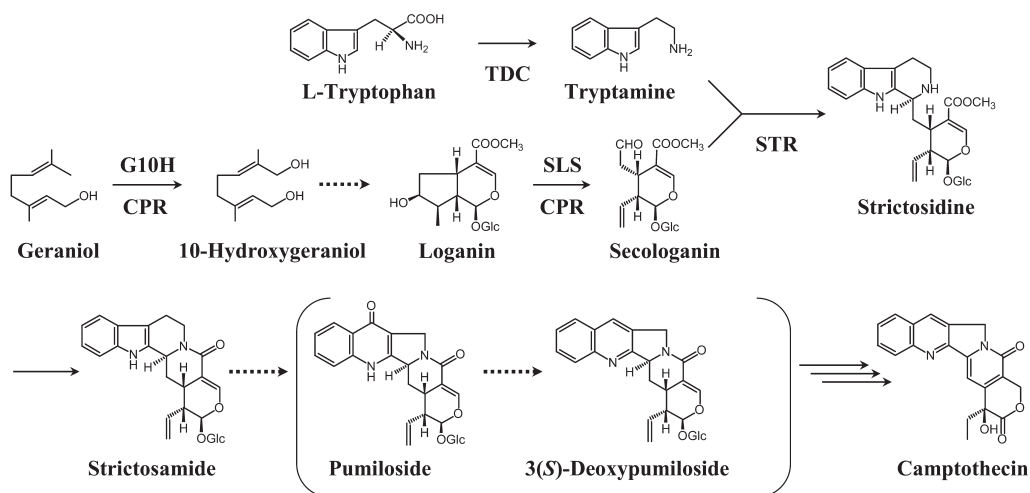
#### Camptothecin Biosynthesis Studies with *O. pumila* Hairy Root

##### 19.3.1

#### Camptothecin Biosynthetic Genes

Monoterpenoid indole alkaloids (TIAs), including camptothecin, are synthesized from strictosidine, a common intermediate formed by condensation of the indole tryptamine with the iridoid glucoside secologanin by the enzyme strictosidine synthase (STR) [34–37] (Fig. 19.9). Intramolecular cyclization of strictosidine leads to the formation of strictosamide, an intermediate peculiar to camptothecin biosyn-





**Fig. 19.9** Predicted biosynthetic pathway of camptothecin in *Ophiorrhiza pumila*. The enzymes are: TDC, tryptophan decarboxylase; G10H, geraniol 10-hydroxylase; CPR, NADPH:cytochrome P450 reductase; SLS, secologanin synthase; STR, strictosidine synthase. Plausible intermediates of camptothecin biosynthesis are in parentheses.

thesis [38]. The cDNA clones encoding STR were isolated from *Rauwolfia serpentina* [39] and *Catharanthus roseus* [40]. Tryptamine, used in strictosidine biosynthesis, is formed by decarboxylation of tryptophan by the enzyme tryptophan decarboxylase (TDC) [41]. The cDNA clone encoding TDC was isolated from *C. roseus* [42]. The enzyme NADPH:cytochrome P450 reductase (CPR) is essential for the activity of cytochrome P450 monooxygenases, such as geraniol 10-hydroxylase (G10H) and secologanin synthase (SLS), both of which are involved in camptothecin biosynthesis [43] (Fig. 19.9). In this study, the cDNA clones encoding STR, TDC and CPR from *O. pumila* hairy roots were isolated using homology-based approaches [44].

#### 19.3.1.1 Strictosidine Synthase (*OpSTR*)

The isolated full-length STR cDNA sequence (*OpSTR*) contained a 1056 bp open reading frame (ORF) encoding a protein of 351 amino acids with a molecular mass of 38.9 kDa. The deduced amino acid sequence of *OpSTR* exhibited 51% and 55% identities with STRs from *C. roseus* and *R. serpentina*, respectively. *OpSTR* is most likely located in the vacuole according to the prediction by PSORT program. Southern blot analysis suggested that a single-copy of STR-encoding gene is present in the genome of *O. pumila* hairy root. The highest *OpSTR* expression occurred in hairy roots, followed by the root and the stem, whereas *OpSTR* was not apparently expressed in leaves.

### 19.3.1.2 Tryptophan Decarboxylase (OpTDC)

The isolated TDC cDNA sequence (*OpTDC*) contained a 1521 bp ORF encoding a protein of 506 amino acids with a molecular mass of 56.6 kDa. The deduced OpTDC showed high identity to *C. acuminata* and *C. roseus* TDCs at the amino acid level (71% and 67%, respectively). Southern blot analysis suggested that the TDC-encoding gene is present as at least two copies. The expression patterns of *OpSTR* and *OpTDC* were similar.

### 19.3.1.3 NADPH:cytochrome P450 Reductase (OpCPR)

The full-length CPR cDNA sequence (*OpCPR*) contained a 2073 bp ORF encoding a protein of 690 amino acids with a molecular mass of 76.6 kDa. The deduced amino acid sequence of OpCPR showed high identity with *Arabidopsis thaliana*, *Petroselinum crispum*, *Pisum sativum*, and *Triticum aestivum* CPR (72%, 66%, 65%, and 67%, respectively). Southern blot analysis suggested that a single-copy of CPR-encoding gene is present in the genome of *O. pumila* hairy root. *OpCPR* was expressed in all tissues.

## 19.3.2

### *In-Silico* and *In-Vitro* Tracer Study from [1-<sup>13</sup>C]glucose

Involvement of the mevalonate (MVA) pathway [45] and the 2C-methyl-D-erythritol 4-phosphate (MEP) pathway [46–48] have long been recognized in the formation of isopentenyl diphosphate (IPP), the precursor of terpenoid biosynthesis. The incorporation of [1-<sup>13</sup>C]glucose into camptothecin with hairy roots of *O. pumila* was investigated by *in-silico* computation using the Atomic Reconstruction of Metabolism (ARM) [49] program and by *in-vivo* tracer experiments [50].

<sup>13</sup>C-NMR analysis clearly indicated that the secologanin moiety of camptothecin was synthesized via the MEP pathway in *O. pumila* hairy roots. Furthermore, in *O. pumila* hairy root culture, treatment with fosmidomycin, a specific inhibitor of the MEP pathway, resulted in a significant decrease in camptothecin production. These findings support the conclusion that the secologanin moiety of camptothecin is derived via the MEP pathway.

## 19.4

### Summary and Conclusions

Aseptic plants and hairy roots of *O. pumila*, *O. liukiuensis* and *O. kuroiwai* have been established for the feasible production of camptothecin, in addition to its plausible biosynthetic intermediate, pumiloside [11, 51]. Camptothecin production by *O. pumila* and *O. kuroiwai* was superior to that by *O. liukiuensis*, with 10-methoxycamptothecin being accumulated in tissue cultures of *O. liukiuensis* and *O. kuroiwai*, but not in those of *O. pumila*. It is likely that 10-methoxycamptothecin might serve as an efficient synthetic precursor of topotecan and irinotecan, and also in

the development of new anti-tumor compounds with C-10 substitution [52]. In general, the aseptic plants of *O. kuroiwai* showed the best growth rates, presumably due to a heterosis effect of a hybrid species that has been described as increased size and yield in crossbred as compared to corresponding inbred lines [53]. Thus, cell cultures of *Ophiorrhiza* sp. would serve as valuable resources for the further development of camptothecin-related pharmaceuticals.

The hairy roots of *O. pumila* excrete camptothecin into the medium in large quantities, with concentrations being raised by the addition of a polystyrene resin to which the compound was adsorbed. In fact, resin addition proved to be a valuable means of recovering camptothecin from the culture medium. Furthermore, large-scale culture of the hairy roots of *O. pumila* using a modified 3-L bioreactor was found to serve as a suitable method for commercial production of camptothecin.

The cDNA clones encoding STR and TDC and CPR were isolated and characterized from hairy roots of *O. pumila*. Northern blot analysis indicated that *OpSTR* and *OpTDC* were expressed at different levels in different tissues of the plant, with highest levels expressed in the root. It should be noted that the mRNA expression patterns of *OpSTR* and *OpTDC* regarding tissue specificity are quite similar, but the expression of *OpCPR* is different. These results suggest that the expression of committing genes for TIA biosynthesis such as *STR* and *TDC* is coordinately regulated in *O. pumila*. However, *CPR* is not controlled by this regulatory system operated for *STR* and *TDC* expression. In some cell cultures, biotic and abiotic elicitors and secondary signal compounds such as MeJA, SA and YE exhibit a remarkable effect on the production of secondary metabolites, including TIA [43, 54, 55]. The regulatory studies regarding regulatory factors in *O. pumila* such as those already conducted in *C. roseus* [56–58] should be useful in identifying these differences.

The biosynthetic pathway of camptothecin from [1-<sup>13</sup>C]glucose was investigated by *in-silico* computation using the ARM program and by *in-vivo* tracer experiments. By combining these results, it can be concluded that the secologanin moiety is derived via the MEP pathway, and that Trp part is formed via the general shikimate pathway.

In time, the transformation and regeneration systems of *Ophiorrhiza* species will not only contribute to further studies of the formation of camptothecin but also help to establish the use of genetically modified plants for its production.

## Acknowledgments

These studies were supported in part by the Grants-in-Aid for Scientific Research from the Ministry of Education, Culture, Sports, Science and Technology, Japan, by CREST of Japan Science and Technology Agency, and by Research for the Future Program (grant no. 00L01605; “Molecular Mechanisms on Regulation of Morphogenesis and Metabolism Leading to Increased Plant Productivity”).

## References

References marked \* are of interest; those marked \*\* are of considerable interest

- 1 Wall, M.E., Wani, M.C., Cook, C.E., Palmer, K.H., McPhail, A.T., Sim, G.A. Plant antitumor agents. I. The isolation and structure of camptothecin, a novel alkaloidal leukemia and tumor inhibitor from *Camptotheca acuminata*. *J. Am. Chem. Soc.* **1966**, *88*, 3888–3890.
- 2 Hsiang, Y.H., Hertzberg, R., Hecht, S., Liu, L.F. Camptothecin induces protein-linked DNA breaks via mammalian DNA topoisomerase I. *J. Biol. Chem.* **1985**, *260*, 14873–14878.
- 3 Redinbo, M.R., Stewart, L., Kuhn, P., Champoux, J.J., Hol, W.G.J. Crystal structures of human topoisomerase I in covalent and noncovalent complexes with DNA. *Science* **1998**, *279*, 1504–1513.
- 4 Takeuchi, S., Dobashi, K., Fujimoto, S., Tanaka, K., Suzuki, M., Terashima, Y., Hasumi, K., Akiya, K., Negishi, Y., Tamaya, T., Tanizawa, O., Sugawa, T., Umesaki, N., Sekiba, K., Aono, K., Nakano, H., Noda, K., Shiota, M., Yakushiji, M., Sugiyama, T., Hashimoto, M., Yajima, A., Takamizawa, H., Sonoda, T., Takeda, Y., Tomoda, Y., Ohta, M., Ozaki, M., Hirabayashi, K., Hiura, M., Hatae, M., Nishigaki, K., Taguchi, T. A late phase II study of CPT-11 on uterine cervical cancer and ovarian cancer. Research groups of CPT-11 in Gynecologic cancers. *Gan To Kagaku Ryoho* **1991**, *18*, 1681–1689.
- 5 Giovanella, B.C., Stehlin, J.S., Wall, M.E., Wani, M.C., Nicholas, A.W., Liu, L.F., Silber, R., Potmesil, M. DNA topoisomerase I-targeted chemotherapy of human colon cancer in xenografts. *Science* **1989**, *246*, 1046–1048.
- 6 Pizzolato, J.F., Saltz, L.B. The camptothecins. *Lancet* **2003**, *361*, 2235–2242.
- 7 Gunasekera, S.P., Badawi, M.M., Cordell, G.A., Fransworth, N.R., Chitnis, M. Plant anticancer agents X. Isolation of camptothecin and 9-methoxycamptothecin from *Ervatamia heyneana*. *J. Nat. Prod.* **1979**, *42*, 475–477.
- 8 Govindachari, T.R., Viswanathan, N. Alkaloids of *Mappia foetida*. *Phytochemistry* **1972**, *11*, 3529–3531.
- 9 Arisawa, M., Gunasekera, S.P., Cordell, G.A., Fransworth, N.R. Plant anticancer agents XXI. Constituents of *Merrilliodendron megacarpum*. *Planta Med.* **1981**, *43*, 404–407.
- 10 Tafur, S., Nelson, J.D., DeLong, D.C., Svoboda, G.H. Antiviral components of *Ophiorrhiza mungos*. Isolation of camptothecin and 10-methoxycamptothecin. *Lloydia* **1976**, *39*, 261–262.
- 11 Aimi, N., Nishimura, M., Miwa, A., Hoshino, H., Sakai, S., Haginiwa, J. Pumiloside and deoxypumiloside; plausible intermediates of camptothecin biosynthesis. *Tetrahedron Lett.* **1989**, *30*, 4991–4994.
- 12 Kitajima, M., Fujii, N., Yoshino, F., Sudo, H., Saito, K., Aimi, N., Takayama, H. Camptothecin and two new monoterpenic glucosides from *Ophiorrhiza liukiensis*. *Chem. Pharm. Bull.* **2005**, *53*, 1355–1358.
- 13 Darwin, S.P. The pacific species of *Ophiorrhiza* L. (Rubiaceae). *Lyonia* **1976**, *1*, 47–102.
- 14 Arbain, D., Putra, D.P., Sargent, M.V. The alkaloids of *Ophiorrhiza filistipula*. *Aust. J. Chem.* **1993**, *46*, 977–985.
- 15 Arbain, D., Dachriyanus, Firmansyah, Sargent, M.V., Skelton, B.W., White, A.H. Unusual indole alkaloids from *Ophiorrhiza blumeana* Korth. *J. Chem. Soc., Perkin Trans 1* **1998**, 2537–2540.
- 16 Aimi, N., Hoshino, H., Nishimura, M., Sakai, S., Haginiwa, J. Chaboside, first natural glycocamptothecin found from *Ophiorrhiza pumila*. *Tetrahedron Lett.* **1990**, *31*, 5169–5172.
- 17 Aimi, N., Tsuyuki, T., Murakami, H., Sakai, S., Haginiwa, J. Structures of ophiorines A and B; novel type glucindole alkaloids isolated from *Ophiorrhiza* spp. *Tetrahedron Lett.* **1985**, *26*, 5299–5302.
- 18 Aimi, N., Murakami, H., Tsuyuki, T., Nishiyama, T., Sakai, S., Haginiwa, J. Hydrolytic degradation of  $\beta$ -carboline-type

- monoterpenoid glucoindole alkaloids: a possible mechanism for harman formation in *Ophiorrhiza* and related Rubiaceous plants. *Chem. Pharm. Bull.* **1986**, *34*, 3064–3066.
- 19 Hayata, B. *Ophiorrhiza* LINN. In: *Icones of the plants of Formosa, and materials for a flora of the island, based on a study of the collections of the botanical survey of the government of Formosa*, fasc. 2. Bureau of Productive Industries, Taihoku, **1912**, pp. 85–92.
- 20 Makino, T. Observations on the flora of Japan. *The Botanical Magazine* **1906**, *20*, 1–156.
- 21 Murashige, T., Skoog, F. A revised medium for rapid growth and bioassays with tobacco tissue culture. *Physiol. Plant.* **1962**, *15*, 473–479.
- 22 \*Asano, T., Watase, I., Sudo, H., Kitajima, M., Takayama, H., Aimi, N., Yamazaki, M., Saito, K. Camptothecin production by *in vitro* cultures of *Ophiorrhiza liukuensis* and *O. kuroiwai*. *Plant Biotech.* **2004**, *21*, 275–281. [This paper reports the accumulation patterns of camptothecin-related alkaloids and the effects of elicitors on growth and camptothecin production in tissue cultures of *Ophiorrhiza* species.]
- 23 Kitajima, M., Nakamura, M., Takayama, H., Saito, K., Stöckigt, J., Aimi, N. Constituents of regenerated plants of *Ophiorrhiza pumila*; formation of a new glycocamptothecin and predominant formation of (3*R*)-deoxypumiloside over (3*S*)-congener. *Tetrahedron Lett.* **1997**, *38*, 8997–9000.
- 24 \*Saito, K., Sudo, H., Yamazaki, M., Koseki-Nakamura, M., Kitajima, M., Takayama, H., Aimi, N. Feasible production of camptothecin by hairy root culture of *Ophiorrhiza pumila*. *Plant Cell Rep.* **2001**, *20*, 267–271. [*Ophiorrhiza pumila* hairy roots produce high levels of camptothecin. Camptothecin content in the medium is increased by the presence of a polystyrene resin (Diaion HP-20) that absorbed camptothecin. This method is the most feasible and commercially applicable way to produce camptothecin by *in vitro* cell culture.]
- 25 Gamborg, O.L., Miller, R.A., Ojima, K. Nutrient requirements of suspension cultures of soybean root cells. *Exp. Cell Res.* **1968**, *50*, 151–158.
- 26 Watase, I., Sudo, H., Yamazaki, M., Saito, K. Regeneration of transformed *Ophiorrhiza pumila* plants producing camptothecin. *Plant Biotech.* **2004**, *21*, 337–342.
- 27 Sakato, K., Tanaka, H., Mukai, N., Misawa, M. Isolation and identification of camptothecin from cells of *Camptotheca acuminata* suspension cultures. *Agric. Biol. Chem.* **1974**, *38*, 217–218.
- 28 Van Hengel, A.J., Buitelaar, R.M., Wichers, H.J. VII *Camptotheca acuminata* Decne: *in vitro* cultures and the production of camptothecin. In: Bajaj, Y.P.S. et al. (Eds.), *Medicinal and aromatic plants VII. Biotechnology in agriculture and forestry*. Volume 28. Springer, Berlin Heidelberg, New York, **1994**, pp. 98–112.
- 29 Wiedenfeld, H., Furmanowa, M., Roeder, E., Guzewska, J., Gustowski, W. Camptothecin and 10-hydroxycamptothecin in callus and plantlets of *Camptotheca acuminata*. *Plant Cell Tissue Organ Cult.* **1997**, *49*, 213–218.
- 30 Roja, G., Heble, M.R. The quinoline alkaloids camptothecin and 9-methoxycamptothecin from tissue cultures and mature trees of *Nothapodytes foetida*. *Phytochemistry* **1994**, *36*, 65–66.
- 31 Ciddi, V., Shuler, M.L. Camptothecin from callus cultures of *Nothapodytes foetida*. *Biotechnol. Lett.* **2000**, *22*, 129–132.
- 32 Lorence, A., Medina-Bolivar, F., Nessler, C.L. Camptothecin and 10-hydroxycamptothecin from *Camptotheca acuminata* hairy roots. *Plant Cell Rep.* **2004**, *22*, 437–441.
- 33 Yamazaki, Y., Urano, A., Sudo, H., Kitajima, M., Takayama, H., Yamazaki, M., Aimi, N., Saito, K. Metabolite profiling of alkaloids and strictosidine synthase activity in camptothecin producing plants. *Phytochemistry* **2003**, *62*, 461–470.
- 34 Stöckigt, J., Zenk, M.H. Strictosidine (isovincoside): the key intermediate in the biosynthesis of monoterpenoid indole alkaloids. *J. Chem. Soc. Chem. Commun.* **1977**, 646–648.
- 35 Stöckigt, J., Ruppert, M. Strictosidine – The biosynthetic key to monoterpenoid indole alkaloids. In: Barton, S.D.,

- Nakanishi, K., Meth-Cohn, O. (Eds.), *Comprehensive Natural Products Chemistry*. Volume 4. Pergamon, Oxford, **1999**, pp. 109–138.
- 36 Kutchan, T.M. Alkaloid biosynthesis: the basis for metabolic engineering of medicinal plants. *Plant Cell* **1995**, *7*, 1059–1070.
- 37 \*\*Lorence, A., Nessler, C.L. Camptothecin, over four decades of surprising findings. *Phytochemistry* **2004**, *65*, 2735–2749. [An interesting review on the progress of camptothecin research. This review describes the distribution of camptothecin, the present understanding of its mechanism of action and the biosynthetic route leading to camptothecin formation.]
- 38 \*Hutchinson, C.R., Heckendorf, A.H., Straughn, J.L., Daddona, P.E., Cane, D.E. Biosynthesis of camptothecin. 3. Definition of strictosamide as the penultimate biosynthetic precursor assisted by  $^{13}\text{C}$  and  $^2\text{H}$  NMR spectroscopy. *J. Am. Chem. Soc.* **1979**, *101*, 3358–3369. [This paper is one of the most important reports in camptothecin biosynthesis researches by precursor feeding experiments.]
- 39 Kutchan, T.M., Hampp, N., Lottspeich, F., Beyreuther, K., Zenk, M.H. The cDNA clone for strictosidine synthase from *Rauwolfia serpentina*. DNA sequence determination and expression in *Escherichia coli*. *FEBS Lett.* **1988**, *237*, 40–44.
- 40 McKnight, T.D., Roessner, C.A., Devagupta, R., Scott, A.I., Nessler, C.L. Nucleotide sequence of a cDNA encoding the vacuolar protein strictosidine synthase from *Catharanthus roseus*. *Nucleic Acids Res.* **1990**, *18*, 4939.
- 41 Noé, W., Mollenschott, C., Berlin, J. Tryptophan decarboxylase from *Catharanthus roseus* cell suspension cultures: purification, molecular and kinetic data of the homogenous protein. *Plant Mol. Biol.* **1984**, *3*, 281–288.
- 42 De Luca, V., Marineau, C., Brisson, N. Molecular cloning and analysis of a cDNA encoding a plant tryptophan decarboxylase: comparison with animal DOPA decarboxylases. *Proc. Natl. Acad. Sci. USA* **1989**, *86*, 2582–2586.
- 43 Meijer, A.H., Lopes Cardoso, M.I.L., Voskuilen, J.T., De Waal, A., Verpoorte, R., Hoge, J.H.C. Isolation and characterization of a cDNA clone from *Catharanthus roseus* encoding NADPH:cytochrome P450 reductase, an enzyme essential for reactions catalysed by cytochrome P450 mono-oxygenases in plants. *Plant J.* **1993**, *4*, 47–60.
- 44 Yamazaki, Y., Sudo, H., Yamazaki, M., Aimi, N., Saito, K. Camptothecin biosynthetic genes in hairy roots of *Ophiorrhiza pumila*: cloning, characterization and differential expression in tissues and by stress compounds. *Plant Cell Physiol.* **2003**, *44*, 395–403.
- 45 Cane, D.E. Isoprenoid biosynthesis overview. In: Cane, D.E. (Ed.), *Comprehensive Natural Product Chemistry*. Volume 2. Elsevier Science Ltd, Amsterdam, **1999**, pp. 1–13.
- 46 Rohmer, M. A mevalonate-independent route to isopentenyl diphosphate. In: Cane, D.E. (Ed.), *Comprehensive Natural Product Chemistry*. Volume 2. Elsevier Science Ltd, Amsterdam, **1999**, pp. 45–67.
- 47 Rodríguez-Concepción, M., Boronat, A. Elucidation of the methylerythritol phosphate pathway for isoprenoid biosynthesis in bacteria and plastids. A metabolic milestone achieved through genomics. *Plant Physiol.* **2002**, *130*, 1079–1089.
- 48 Kuzuyama, T., Seto, H. Diversity of the biosynthesis of isoprene units. *Nat. Prod. Rep.* **2003**, *20*, 171–183.
- 49 Arita, M. *In silico* atomic tracing by substrate-product relationships in *Escherichia coli* intermediary metabolism. *Genome Res.* **2003**, *13*, 2455–2466.
- 50 \*Yamazaki, Y., Kitajima, M., Arita, M., Takayama, H., Sudo, H., Yamazaki, M., Aimi, N., Saito, K. Biosynthesis of camptothecin. In silico and in vivo tracer study from  $[1-^{13}\text{C}]$ glucose. *Plant Physiol.* **2004**, *134*, 161–170. [This paper describes the *in silico* and *in vivo* studies of the biosynthesis of camptothecin with the hairy roots of *O. pumila* using  $[1-^{13}\text{C}]$ glucose. The metabolic flux from  $[1-^{13}\text{C}]$ Glc to camptothecin via central sugar metabolism, amino acid biosynthesis, and the MEP pathway is also

- discussed. This study is one of the first successful examples of integration of computational metabolomics and experimental biochemistry.]
- 51 Carte, B.K., DeBrosse, C., Eggleston, D., Hemling, M., Mentzer, M., Poehland, B., Troupe, N., Westley, J.W., Hecht, S.M. Isolation and characterization of a presumed biosynthetic precursor of camptothecin from extracts of *Camptotheca acuminata*. *Tetrahedron* **1990**, *46*, 2747–2760.
  - 52 Vladu, B., Woynarowski, J.M., Manikumar, G., Wani, M.C., Wall, M.E., Von Hoff, D.D., Wadkins, R.M. 7- and 10-substituted camptothecins: dependence of topoisomerase I-DNA cleavable complex formation and stability on the 7- and 10-substituents. *Mol. Pharmacol.* **2000**, *57*, 243–251.
  - 53 Shull, G.H. What is heterosis? *Genetics* **1948**, *33*, 439–446.
  - 54 Menke, F.L.H., Parchmann, S., Mueller, M.J., Kijne, J.W., Memelink, J. Involvement of the octadecanoid pathway and protein phosphorylation in fungal elicitor-induced expression of terpenoid indole alkaloid biosynthetic genes in *Catharanthus roseus*. *Plant Physiol.* **1999**, *119*, 1289–1296.
  - 55 Collu, G., Unver, N., Peltenburg-Looman, A.M.G., Van Der Heijden, R., Verpoorte, R., Memelink, J. Geraniol 10-hydroxylase, a cytochrome P450 enzyme involved in terpenoid indole alkaloid biosynthesis. *FEBS Lett.* **2001**, *508*, 215–220.
  - 56 Menke, F.L.H., Champion, A., Kijne, J.W., Memelink, J. A novel jasmonate- and elicitor-responsive element in the periwinkle secondary metabolite biosynthetic gene *Str* interacts with a jasmonate- and elicitor-inducible AP2-domain transcription factor, ORCA2. *EMBO J.* **1999**, *18*, 4455–4463.
  - 57 Van Der Fits, L., Memelink, J. ORCA3, a jasmonate-responsive transcriptional regulator of plant primary and secondary metabolism. *Science* **2000**, *289*, 295–297.
  - 58 Van Der Fits, L., Memelink, J. The jasmonate-inducible AP2/ERF-domain transcription factor ORCA3 activates gene expression via interaction with a jasmonate-responsive promoter element. *Plant J.* **2001**, *25*, 43–53.

## 20

# Plant Biochemistry and Biotechnology of Flavor Compounds and Essential Oils

*Dinesh A. Nagegowda and Natalia Dudareva*

### 20.1

#### Introduction

Essential oils, also known as volatile or ethereal oils or essences, are the mixtures of highly fragrant compounds found in aromatic plants and flowers that are the raw materials of the flavors and fragrances. The essential oil-producing plants are distributed widely across the plant kingdom and cover a large number of families including Lamiaceae (mints, basil, lavender, etc.), Rosaceae (roses), and Poaceae (aroma grasses) (Table 20.1). This widespread distribution of essential oils across the plant taxonomic groups is paralleled by a variety of epidermal cellular structures producing and/or sequestering essential oils, and an array of quantitative and qualitative combinations of the chemical constituents of the volatile oils of these plants [1]. Essential oils are secondary metabolites, often produced in special glands or secretory tissues, and are generally found to be most abundant in one particular plant organ such as flowers, buds, seeds, leaves, twigs, bark, herbs, wood, fruits, roots/rhizomes, resin or exudates, depending on the species [2]. Essential oils can be extracted from plant organs by crushing or by distillation in a heated aqueous or alcoholic solvent, and their active components subsequently isolated and characterized using HPLC and gas-liquid chromatography.

Almost all essential oils are extremely complex in composition, having a large variety of highly functionalized chemical entities belonging to different chemical classes. Of the various secondary metabolites synthesized in plants, terpenoids derived from either the mevalonic acid (MVA) or metherythritol phosphate (MEP) pathways are predominant constituents of essential oils, though many of these oils are also composed of other chemicals such as phenylpropanoids, derived from the shikimate pathway. Essential oils have been used by mankind from time immemorial for various purposes such as perfumes, flavors, and medicine. In the modern era, they are routinely used in fragrances, cosmetics, soaps, foods, confectionary, preservatives, insect repellents, and pharmaceutical products. Many of the essential oils possess antimicrobial, anticancer and other medicinal properties. Of an estimated 3000 known essential oils, about 300 are commercially important, being



Table 20.1 Some of the important plant essential oils and their major constituents.

Species	Common name	Family	Major terpenes and/or phenylpropanoid	Major oil-producing organ(s)
<i>Mentha arvensis</i>	Corrmint	Lamiaceae	Menthol, Methyl acetate	Leaf
<i>Mentha piperata</i>	Peppermint		Menthone, Menthol, Isomenthone	Leaf
<i>Mentha spicata</i>	Spearmint		Carvone, Carveol	Leaf
<i>Sabia officinalis</i>	Sage		Camphor, Thujone	Leaf
<i>Ocimum basilicum</i>	Sweet basil		Chavicol, Linalool, Eugenol	Leaf
<i>Lavandula officinalis</i>	Lavender		Geraniol, Linalool	Flower
<i>Origanum majorana</i>	Sweet marjoram		Terpenen-4-ol, Pinene	Leaf and flower
<i>Origanum vulgare</i>	Oregano		Carvacro, Thymol, <i>g</i> -Terpinene, <i>p</i> -Cymene	Leaf
<i>Rosmarinus officinalis</i>	Rosemary		$\alpha$ -pinene, Bornyl acetate, Camphor, 1,8-cineole	Leaf
<i>Thymus vulgaris</i>	Thyme		Thymol, Carvacro, <i>g</i> -Terpinene, <i>p</i> -Cymene	Leaf
<i>Cymbopogon winterianus</i>	Citronella	Poaceae	Citronellal, Citronellol, Geraniol	Leaf
<i>Cymbopogon flexuosus</i>	Lemongrass		Citral, Geraniol	Leaf
<i>Cymbopogon martini</i>	Palmarosa		Geraniol, Geranyl acetate	Leaf
<i>Vetiveria zizoides</i>	Vetiver			Vetiverol Roots
<i>Eucalyptus</i> species	Eucalyptus	Myrtaceae	Eugenol, Methyl eugenol	Leaf
<i>Syzygium aromaticum</i>	Clove (bud)		Eugenol, Eugenyl acetate	Bud
<i>Melaleuca alternifolia</i>	Tea-tree		Terpenen-4-ol, Terpinolene	Leaf and twig
<i>Rosa damascena</i>	Rose	Rosaceae	Geraniol, Rose oxide	Flower
<i>Artemisia annua</i>	Qinghasu	Compositae	Artemisia ketone	Leaf
<i>Artemisia dracunculus</i>	French tarragon		Methyl chavicol	Leaf
<i>Pelargonium graveolens</i>	Geranium	Geraniaceae	Geraniol, L-citronellol	Flower and leaf
<i>Carum carvi</i>	Caraway	Umbellifereae	Limonene, Carvone	Seeds
<i>Matricaria chamomilla</i>	Chammomile	Asteraceae	Azulene	Flower
<i>Santalum album</i>	Sandalwood	Santalaceae	Santalol	Stem
<i>Coriandrum sativum</i>	Cilantro	Apiaceae	Linalool, E-2-decanal	Leaf
<i>Cinnamomum zeylandicum</i>	Cinnamon	Lauraceae	<i>trans</i> -cinnamaldehyde	Bark

used mainly for the flavors and fragrances market [3]. During the past few years their use as potent natural remedies has gained enormous popularity in industrialized countries, particularly in the multimillion-dollar aromatherapy business. In this chapter, we discuss the biochemistry of essential oils, the enzymes and genes involved in their biosynthesis, their practical applications, and attempts to improve essential oils via metabolic engineering.

## 20.2

### Biosynthesis of Flavors/Essential Oils

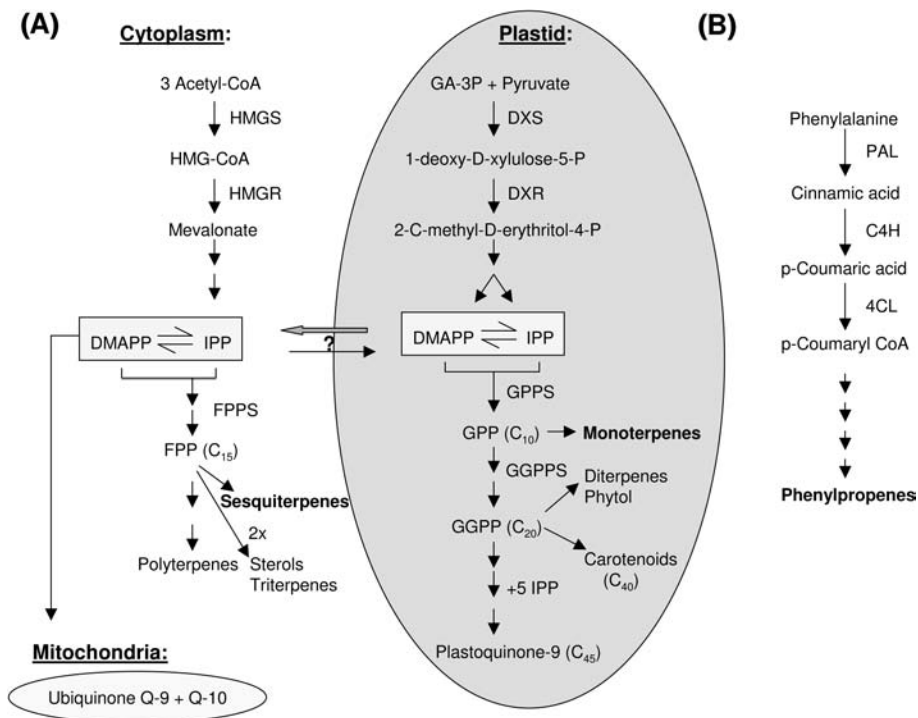
Two classes of compounds – terpenoids and phenylpropanoids derived from different metabolic pathways – comprise the bulk of plant essential oils. Although phenylpropanoids are found less frequently than terpenoids within essential oils, they also provide indispensable and significant aroma, flavor and therapeutic effects.

#### 20.2.1

##### Terpenoids

Terpenoids, also known as isoprenoids, are the most functionally and structurally diverse group of plant metabolites with over 30 000 compounds identified to date [4,5]. They play an essential role in respiration, signal transduction, cell division, membrane architecture, photosynthesis, and growth regulation. Furthermore, they also function in protecting plants against herbivores and pathogens, in attracting pollinators and seed-dispersing animals, and as allelochemicals that influence competition among plant species [6]. These extraordinarily diverse compounds originate through the condensation of the universal five-carbon precursors, isopentenyl diphosphate (IPP) and dimethylallyl diphosphate (DMAPP). In higher plants, two distinct biosynthetic pathways are responsible for the synthesis of IPP and DMAPP: the classical mevalonate pathway [7]; and the recently discovered methylerythritol phosphate (MEP) pathway [8,9] (Fig. 20.1a). The mevalonate pathway, which operates in the cytosol, begins with the stepwise fusion of three molecules of acetyl-CoA and proceeds through the intermediate mevalonate, providing IPP and DMAPP for sesquiterpene biosynthesis. The non-mevalonate MEP or Rohmer pathway localized in plastids [10, 11] provides IPP and DMAPP for hemiterpene, monoterpene, and diterpene biosynthesis. In this pathway, IPP is derived from pyruvate and glyceraldehyde-3-phosphate. Although this subcellular compartmentation allows both pathways to operate independently in plants, metabolic “cross-talk” between these two pathways was recently discovered [12], particularly in the direction from plastids to cytosol [13–15].

Upon synthesis of the basic isoprene units, the next step of terpene biosynthesis involves fusion of the basic C<sub>5</sub> building blocks by a head-to-tail condensation to generate three larger prenyl diphosphates: geranyl diphosphate (GPP, C<sub>10</sub>); farnesyl diphosphate (FPP; C<sub>15</sub>); and geranylgeranyl diphosphate (GGPP; C<sub>20</sub>) – the pre-



**Fig. 20.1** A simplified view of the biosynthetic pathways leading to the formation of terpenes and phenylpropenes. (A) Overview of the mevalonic acid (MVA) and methylerythritol phosphate (MEP) pathways for isoprenoid biosynthesis localized in cytosol and plastids, respectively. HMGS; HMG-CoA synthase; HMGR: HMG-CoA reductase; FPPS: FPP syn-

thase; DXS: 1-deoxy-d-xylulose 5-phosphate synthase; DXR: 1-deoxy-d-xylulose 5-phosphate reductoisomerase; GPPS: GPP synthase; GGPPS: GGPP synthase. (B) Overview of the phenylpropene biosynthetic pathway. PAL: Phenylalanine ammonia lyase; C4H: cinnamate 4-hydroxylase; 4CL: 4-coumarate:CoA ligase.

cursors of monoterpenes, sesquiterpenes, and diterpenes, respectively. The formation of these prenyl pyrophosphates is catalyzed by short-chain prenyltransferases [16,17]. FPP is synthesized in the cytosol by a sequential head-to-tail addition of two IPP molecules to one DMAPP molecule catalyzed by a homodimeric enzyme farnesyl pyrophosphate synthase (FPPS; EC 2.5.1.10) [18], while GGPP is synthesized in the plastids in a reaction catalyzed by GGPP synthase (GGPPS; EC 2.5.1.30), which condenses DMAPP with three IPP molecules [16,19]. GPP, the universal precursor for all monoterpenes, is also synthesized in the plastids by head-to-tail condensation of one molecule of IPP and DMAPP catalyzed by the enzyme geranyl pyrophosphate synthase (GPPS; EC 2.5.1.1) [19,20]. Recent isolation of GPP synthases from different plant species revealed the presence of two fundamentally different dimeric structures. The GPP synthases of *Arabidopsis* [21] and grand fir (*Abies grandis*) [22] are homodimers, whereas those reported from pepper-

mint leaves (*Mentha × piperita*) [23], snapdragon (*Antirrhinum majus*) and *Clarkia breweri* flowers [24] are heterodimeric enzymes with each subunit classified as a member of the prenyltransferase protein family. Each subunit alone in peppermint is catalytically inactive, and only their co-expression leads to production of the active heterodimeric enzyme [23]. In contrast, in snapdragon only the small subunit is inactive when expressed alone, while the large subunit is a functional GGPP synthase on its own [24].

In the next step, GPP, FPP, and GGPP are converted to monoterpenes, sesquiterpenes, and diterpenes, respectively, by a large family of enzymes known as terpene synthases/cyclases [25, 26]. One of the most outstanding properties of these enzymes is their proclivity for making multiple products from a single substrate. Many of the terpene volatiles are direct products of terpene synthases, while others are formed through transformation of the initial terpenoid products by oxidation, dehydrogenation, acylation, and other reaction types [27].

### 20.2.1.1 Monoterpenes

Monoterpenes are the most commonly occurring type of terpenes in plant essential oils. Their levels within the oil depend on plant species. Monoterpenes along with sesquiterpenes represent the major constituents of essential oils of many Lamiaceae species including *Mentha*, *Salva*, *Origanum*, and *Thyme* spp. [28]. Similarly, essential oils of many species of the genus *Ocimum* are based primarily on monoterpene derivatives such as camphor, limonene, thymol, citral, geraniol, and linalool (Fig. 20.2) [28–30]. To date, more than 1000 monoterpenes have been identified, most of which are volatile compounds responsible for the characteristic odors of extracted essential oils [31]. The biosynthesis of monoterpenes is catalyzed by monoterpene cyclases/synthases which convert GPP into various skeletal types (Fig. 20.2). During the past few years, a number of monoterpene synthases have been isolated and characterized from various plant species. This list includes genes

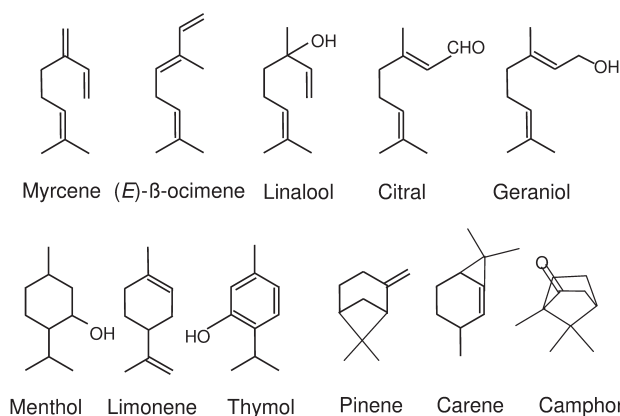


Fig. 20.2 Representative structures of monoterpenes found in plant essential oils.

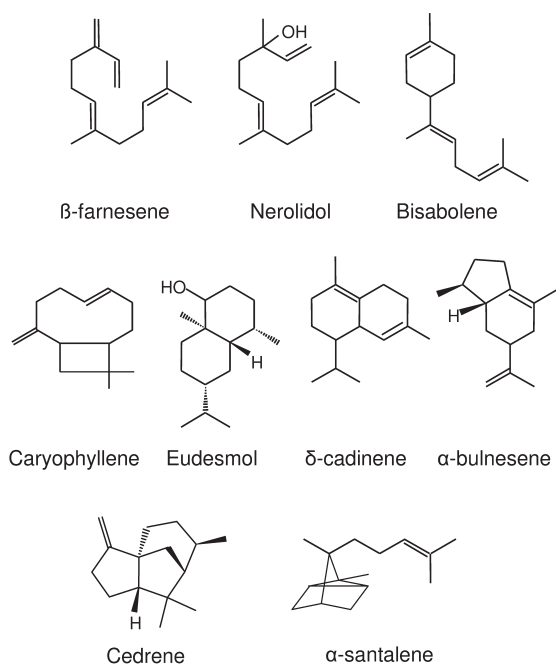
encoding enzymes responsible for the synthesis of (*S*)- and (*R*)-linalool [32–37], myrcene [36–39], (*E*)- $\beta$ -ocimene [38,40], (+)-3-carene [41,42], (–)- and (+)-limonene [36, 39, 43–45], (+)- and (–)- $\alpha$ -pinene [36, 46, 47], (–)- $\beta$ -pinene [36, 39, 45, 48], 1,8-cineole [49, 50],  $\gamma$ -terpinene [45], geraniol [51], camphor [52], and terpinolene [47]. Many of these compounds are synthesized by specialized monoterpene synthases that catalyze the formation of a single product; however, several multiproduct monoterpene synthases have also been recently isolated and characterized. *Arabidopsis* myrcene/ocimene synthase converts GPP into myrcene (56% of total hydrocarbon product), (*E*)- $\beta$ -ocimene (20%), and small amounts of cyclic monoterpenes (each <5%) [53], while a monoterpene synthase from *Perilla frutescens* produces myrcene (53.8%), sabinene (20.9%), linalool (19.8%) and limonene (5.5%) [54]. Two basil monoterpene synthases – terpinolene synthase and fenchol synthase – each catalyze the formation of four different products, including one unidentified in both cases. In addition to an unidentified monoterpene, terpinolene synthase produces terpinolene (a major product), limonene, and  $\beta$ -pinene, whereas fenchol synthase synthesizes fenchol, limonene, and  $\alpha$ -pinene [37].

Synthesized monoterpenes often undergo further enzymatic transformations including oxidations, reductions, and isomerizations which lead to the formation of a large number of monoterpene derivatives such as alcohols, ketones, aldehydes, and esters. Several terpene-modifying enzymes have been isolated including rose (*Rosa hybrida*) geraniol/citronellol acetyl transferase [55] and mint limonene hydroxylases [56]. Stereoselective reduction to (*S*)-citronellol, *E/Z*-isomerization to nerol, oxidation to neral/geranial and glycosylation of the corresponding monoterpene alcohols was demonstrated in grape mesocarp (*Vitis vinifera*) by *in-vivo*-feeding experiments [57].

#### 20.2.1.2 Sesquiterpenes

Sesquiterpenes are synthesized from FPP by sesquiterpene synthases, and are structurally more diverse than monoterpenes due to the increased possibilities of different cyclizations with five additional carbon atoms [31] (Fig. 20.3). They are less volatile when compared with monoterpenes and are commonly found in secretory cavities, glands, and ducts. Also, sesquiterpenes are common constituents of most of the essential oils including farnesene in chamomile and lavender,  $\beta$ -caryophyllene in basil and black pepper,  $\beta$ -eudesmol in chamomile, bisabolene in ginger, santalene in sandalwood, cedrene and cadinene in cedar wood, and  $\alpha$ -bulnesene in patchouli (Fig. 20.3).

To date, more than 7000 sesquiterpenes have been identified in plants, with several sesquiterpene synthases being cloned and biochemically characterized from various plant species [58]. These genes include caryophyllene synthase from *Arabidopsis thaliana* and annual wormwood (*Artemisia annua*) [33,59], germacrene A synthase from goldenrod (*Solidago canadensis*) and chicory (*Cichorium intybus*) [60, 61], germacrene D synthase from roses (*Rosa hybrida*), goldenrod (*Solidago canadensis*), basil (*Ocimum basilicum*), and grapevine (*Vitis vinifera*) [37, 62–64], terpene synthase 1 from maize (*Zea mays*), [65], (*E*)- $\beta$ -farnesene synthase from peppermint



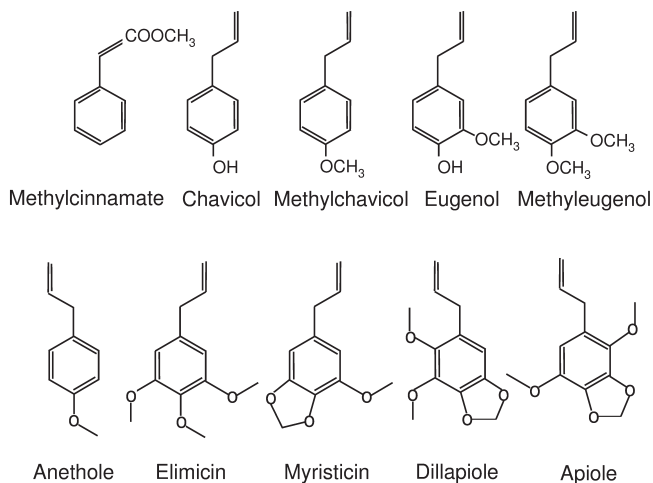
**Fig. 20.3** Representative structures of sesquiterpenes found in plant essential oils.

(*Mentha × piperita*), yuzu (*Citrus junos*), Douglas-fir (*Pseudotsuga menziesii*), and annual wormwood (*Artemisia annua*) [47, 66–68], nerolidol/linalool synthase from strawberry (*Fragaria × ananassa*) [69], valencene synthase from grapevine (*Vitis vinifera*) [64] and citrus [70],  $\gamma$ -cadinene synthase, selinene synthase,  $\alpha$ -zingiberene synthase from basil [37], *cis*-muuroladiene synthase from peppermint (*Mentha × piperita*) [71], (*E*)- $\gamma$ -bisabolene synthase from Douglas-fir (*Pseudotsuga menziesii*) [47], longifolene synthase, (*E,E*)- $\alpha$ -farnesene synthase, and (*E*)- $\alpha$ -bisabolene synthase from Norway spruce (*Picea abies*) [36], and two sesquiterpene synthases from *Arabidopsis* responsible for the synthesis of a complex mixture of sesquiterpenes with the main component (*E*)- $\beta$ -caryophyllene [72].

### 20.2.2

#### Phenylpropanoids

Phenylpropanoids, such as eugenol, methyl eugenol, myristicin, methyl cinnamate, elemicin, chavicol, methyl chavicol (estragole), dillapiole, anethole, and apiole, are common constituents of essential oils and contribute to their particular properties (Fig. 20.4). Eugenol, with a spicy odor reminiscent of cloves, is a major component of clove (*Myrtaceae*) essential oil and is also present in significant amounts in cinnamon leaves (*Cinnamomum zeylanicum*, *Lauraceae*) [73–75]. Estragole has an odor resembling that of fennel and anise, and is a key component of es-



**Fig. 20.4** Representative structures of phenylpropenes found in plant essential oils.

sential oils of aromatic plants belonging to different families including aniseed (*Pimpinella anisum* L., Apiaceae), star anise (*Illicium verum* Hook. f., Magnoliaceae), bitter fennel (*Foeniculum vulgare* var. *vulgare*, Apiaceae), and tarragon (*Artemisia dracuncululus* L., Asteraceae) [75–77].

Unlike terpenoids, for which extensive information is available about their biosynthesis, and a significant number of enzymes and corresponding genes have been isolated and characterized [49, 78, 79], little is known about the entire biochemical pathways leading to the formation of phenylpropenes and their derivatives. The phenylpropene compounds are derived from L-phenylalanine (Phe) which is converted to *trans*-cinnamic acid in a reaction catalyzed by L-phenylalanine ammonia-lyase (PAL; EC 4.3.1.5) (Fig. 20.1B). PAL not only catalyzes the non-oxidative deamination of Phe (the first committed step in the phenylpropanoid synthesis) but also regulates the overall flux into the pathway [80]. In the next steps, a variety of hydroxycinnamic acids are formed from *trans*-cinnamic acid via a series of hydroxylation and methylation reactions. Some of these hydroxycinnamic acids, coumarate and ferulate, are believed to be precursors for chavicol and eugenol, respectively. Feeding basil leaves with radioactively labeled precursors suggested that eugenol could be synthesized from the monolignol precursor coniferyl alcohol [81], or via an undefined mechanism involving methylation and decarboxylation of the hydroxycinnamic acids [82–84]. To date, the exact biochemical routes leading to chavicol and eugenol formation have not been elucidated and the critical intermediary steps in their biosynthesis represent an open question. However, genes encoding enzymes responsible for the last step in the formation of methylchavicol and methyleugenol have been recently isolated and characterized from sweet basil [85]. It has been shown that two separate – but very similar – enzymes, chavicol O-methyltransferase (CVOMT) and eugenol O-methyltransferase (EOMT), catalyze methylation of the 4'-hydroxyl group of chavicol and eugenol, respectively, us-

ing *S*-adenosylmethionine (SAM) as the methyl donor. Compared to terpenes, very few genes responsible for the biosynthesis of phenylpropene compounds of essential oils have been isolated. These include SAM:(iso) eugenol *O*-methyl transferase from *Clarkia breweri* [86] and the aforementioned eugenol methyltransferase and chavicol methyltransferase from sweet basil (*Ocimum basilicum*) [85].

### 20.3

#### Regulation of Essential Oil Accumulation

The accumulation of essential oils in plants is developmentally regulated and depends on plant species as well as on plant organ, tissue, and cells. In plants such as *Mentha* [87], *Ocimum sanctum*, *Majorana hortensis* [88], *Salvia officinalis* [89] and *Cymbopogon flexuosus* [90], where leaves are the major source of commercially valuable oil, its accumulation is associated with the early stages of leaf development. However, in some species the accumulation of oil can occur later in development, as was reported for palmarosa *Cymbopogon martini* leaves [91, 92]. In general, young leaves of *Eucalyptus citriodora* have a greater oil content than mature ones, but in some eucalyptus species, oil content has been shown to be independent of leaf maturity [93]. When the flowers are the sources of essential oils – for example in the case of geranium (*Pelargonium* spp.) and rose (*Rosa damascena*) – its accumulation is also developmentally regulated, but in contrast to leaves, the highest levels are usually attained at full bloom and decrease rapidly thereafter [93, 94]. It should be noted, that although the oil content of the geranium flowers is greater than that of the leaves, the flowers contribute little to the total oil yield [94].

The essential oil of peppermint (*Mentha × piperita*) represents an example where the biochemistry and regulation of its metabolism has been extensively investigated [87]. This perennial herb produces high levels of *p*-menthane monoterpenes in the peltate glandular trichomes found on the aerial parts of leaves, young stems, and parts of the inflorescence [95]. Most of the genes encoding enzymes responsible for the eight-step biosynthetic pathway to menthol, the principal and characteristic monoterpene constituent of mint oil, have been isolated and characterized [96]. During leaf development, the total content of monoterpenes increases with age [97, 98] and their composition changes drastically. A time-course evaluation of essential oil chemistry, *in-vitro* enzyme activities, and transcript and enzyme protein abundances revealed two distinct stages of monoterpene biosynthesis in peppermint [99, 100]. In the first stage, *de-novo* monoterpene biosynthesis peaks at about 12 days after leaf initiation, coinciding with leaf expansion and oil gland filling, and primarily represents the conversion of basic precursors to menthone. During this stage all of the pathway genes, with the exception of menthone reductase (MR), are coordinately transcribed at high levels [99, 101]. The second stage (oil maturation stage), approximately seven days later, is characterized by a reduction in early pathway transcripts and enzymes, and a gradual increase in MR activity resulting in the conversion of menthone to menthol. The coincidental temporal changes in enzyme activities, enzyme protein level, and steady-state transcript



abundances during these two stages indicated that developmental programs are regulated at the level of gene expression [99]. The second stage terminates at flower initiation and is generally accompanied by the production of measurable amounts of menthyl acetate which is an indicator of an “over-mature” oil [87].

Similar to peppermint, developmentally regulated accumulation of carvone and limonene, the major constituents of caraway (*Carum carvi*) essential oil, was found in fruits. Limonene accumulates predominantly in the early stages of development, whereas accumulation of carvone occurs in the later stages; this results in approximately equal amounts of both compounds at fruit maturity [102–104]. Interestingly, the annual and biennial forms of caraway show differences in essential oil formation. While both forms produce an essential oil consisting mainly of carvone and limonene, biennial varieties usually have a higher essential oil content with a higher carvone:limonene ratio than the fruits of annual plants [103]. In annual caraway, the accumulation of limonene and carvone begins earlier in development, peaks, and ceases earlier than in biennial varieties. However, the biennial form continues to accumulate limonene and carvone after the monoterpene content of annual caraway has already stabilized. The continued formation of monoterpenes during the later stages of development contributes to the higher carvone:limonene ratio in biennial caraway.

The formation of carvone from GPP in caraway fruits proceeds via three steps, which are sequentially catalyzed by limonene synthase, limonene-6-hydroxylase, and (+)-*trans*-carveol dehydrogenase. The activities of these three enzymes, which synthesize (+)-limonene, (+)-*trans*-carveol, and (+)-carvone, respectively, undergo dramatic changes during fruit development and correlate closely with monoterpene accumulation. Due to limited temporal occurrence of limonene-6-hydroxylase and its kinetic properties, it was concluded that the hydroxylation of limonene to *trans*-carveol is a critical, rate-limiting step in carvone biosynthesis [105].

Developmental accumulation of phenylpropanoid compounds of essential oil has been shown in sweet basil peltate glandular trichomes. Young leaves displayed high levels of chavicol and eugenol *O*-methyltransferase activity, which was low or negligible in older leaves, indicating that the *O*-methylation of chavicol and eugenol primarily occurs during early leaf development [85, 106]. The levels of chavicol and eugenol *O*-methyltransferase activities and mRNA transcripts followed the general pattern of glandular trichome development on basil leaves. As the glands reach maturity, the levels of enzyme activity and mRNA transcripts decrease [85].

## 20.4

### Practical Applications

Due to their pharmacological potential, plants and their extracts have been used as treatments for ailments from headaches to parasite infections for many centuries, despite their mode of action still remaining largely unknown. The medicinal properties of essential oils have received increasing attention over the past 20 to 30 years but to date, still less than 10% of approximately 250 000 of the world's flower-

ing plant species have been analyzed for their pharmacological properties. Nevertheless, almost 25% of active medical compounds currently prescribed in the USA and UK are isolated from higher plants [107]. Plant essential oils are of great value due to their anticancer, antiparasitic, and antimicrobial properties. Some aromatic compounds of essential oils are important ingredients of food (as flavorings), cosmetic (perfumes and aftershaves), and oral healthcare products.

A number of individual components of many essential oils, particularly monoterpenes such as limonene [108–112], perillyl alcohol [112–116], citral [117], carvone [118], carveol [119], menthol [120] and geraniol [121, 122], sesquiterpenes including  $\alpha$ -cadinol,  $\beta$ -elemene and  $\alpha$ -humulene [123], and phenylpropanoids such as eugenol [124], possess anticarcinogenic activities, as was demonstrated using animal cancer models. These compounds act at different cellular and molecular levels, exhibiting not only the ability to prevent the formation or progression of cancer, but also causing existing malignant tumors to regress. In addition to individual components, some essential oil extracts including those from caraway seeds [118], sweetgale [125], garden angelica, [126], tea tree [127], and lemon balm [128], have the ability to prevent cancers.

Plant essential oils and/or their active components can also be used as alternatives or adjuncts to antiparasitic therapies. They are useful in treating infectious diseases, particularly in cases where the oils have no direct undesirable effects on the host [107]. Two separate modes of action can be accounted for the efficacy of plant oils for treating parasitic infection: their immunomodulatory properties and their antiparasitic effects. Some essential oils such as clove [129], turmeric [130], basil [131], and garlic [132] have immunomodulatory effects leading to the modification of host–parasite immunobiology [107]. By inhibiting nitric oxide (NO) production in macrophages, essential oils from clove, turmeric, and garlic provide an environment conducive for intracellular parasite multiplication. This, in turn, up-regulates the secondary mechanisms from which the parasite cannot protect itself, leading to its death. On the other hand, sacaca (*Croton cajucara*) oil increases the macrophage NO formation, thus enhancing the intracellular parasite killing [133].

While some essential oils such as garlic and basil have both immunomodulatory and antiparasitic modes of action, the other plant essential oils possess only one of these activities. Many essential oils including those from lemon balm, thyme, tea tree [134], cinnamon [135–138], and lemon [136] have antiparasitic effects but cannot act on more than two parasites. Apart from these oils, oregano oil is effective against more than two parasites [139, 140]. The exception includes garlic essential oil, the only plant oil with a broad antimicrobial spectrum including antibacterial, antifungal, antiviral, and antiparasitic activities [141]. It influences the growth of at least 12 different human and nonhuman parasites, including *Trypanosoma*, *Plasmodium*, *Giardia*, and *Leishmania*. As chemotherapy-resistant parasites are currently emerging, the role of plant essential oils as novel antiparasitic agents is becoming more important.

A number of essential oils including thyme, rosemary, oregano, sage, clove, lemon grass and several of their individual components exhibit antibacterial activity against foodborne pathogens *in vitro* and, to a lesser extent, in foods [142]. Addi-

tionally, due to their antibacterial properties, essential oils and their components are exploited in a wide range of commercial products such as dental root canal sealers [143], antiseptics [144, 145] and feed supplements for lactating sows and weaned piglets [146, 147]. “DMC Base Natural” is a commercially available food preservative comprising 50% essential oils from rosemary, sage and citrus and 50% glycerol [148]. “Protecta One” and “Protecta Two” are blended herb extracts recognized as safe food additives in the US. Furthermore, essential oils are used as suppressants of potato sprouting [149].

Nowadays, essential oils are gaining popularity in aromatherapy, one of the branches of phytotherapy, which uses the whole plants or parts of plants for medicinal purposes. In aromatherapy pure essential oils from fragrant plants (such as lavender, jasmine, rose, sandalwood, rosemary, basil, thyme) are used to help relieve health problems and improve the quality of life in general [150]. During the treatment, essential oils are commonly used in oil burners, bath water, or massaged into the skin; thus, the aroma of the essential oil evaporates and stimulates the olfactory sense. Aromatherapy is thought to be therapeutically effective due to both the psychological effect of the odor and the physiological effects of the inhaled volatile compounds. The healing properties of aroma therapy are claimed to promote relaxation and sleep, relief of pain, and reduction of depressive symptoms [150], with the rationale that the essential oils have a calming and de-stressing effect. Although the pharmacokinetics and physiological effects of essential oils in aromatherapy are still unclear to date, they are used in maternal and child health, critical care environments, pain relief, cancer care, skin and hair conditions, neurological conditions, respiratory conditions, digestive disorders, and some medical conditions [151].

Plant essential oils and their individual components have also been recognized as important natural resource for insecticides [152, 153]. They are used as contact insecticides, antifeedants or repellents and miticides [154, 155]. Due to their lipophilic nature they penetrate the wax cuticle and interfere with basic metabolic, biochemical, physiological, and behavioral functions of insects [156]. An analysis of 37 individual constituents of different essential oils revealed that *cis*-carveol, geraniol, citronellal, and caryophyllene oxide exhibit relatively high repellent activities [157]. A contact toxicity test against American cockroach (*Periplaneta americana*) using filter paper impregnation of various individual components of essential oils, showed that methyl-eugenol, isosafrole, eugenol and safrole each have knockdown activity after 24 h of contact, whereas eugenol, methyleugenol, isosafrole, and safrole have killing effects after 96 h [158]. When essential oils extracted from 10 medicinal plants including basil, rosemary, anise, ginger, bark, and nut grass were evaluated for larvicidal, adulticidal, ovicidal, oviposition-deterrent and repellent activities towards three mosquito species, it was found that *Cinnamomum zeylanicum* (bark) essential oil showed the highest repellent and oviposition-deterrent activity [159]. As essential oils are generally safe to humans and other mammals [160], they have the potential to be developed as eco-friendly pesticides.

## 20.5 Metabolic Engineering

Although essential oils are found widely in plants, their extraction is often expensive due to low yield, and their supply will become limiting as demand increases and natural resources are depleted. Thus, the generation of transgenic plants with increased yields of essential oils or individual biologically active compounds via metabolic engineering has lately gained increasing interest. Recent discoveries of genes encoding enzymes that catalyze the synthesis of essential oil compounds, coupled to advances in our understanding of their regulation, provide avenues for the biotechnological improvement of plant essential oils. The strategies for increasing metabolic flux to the target compound include modification of endogenous pathways at single or multiple points, blocking of competitive pathway(s), or the introduction of a new step that redirects the flux towards a particular desirable molecule. It should be kept in mind that the goal of increasing essential oil yield via the introduction of novel genes or the enhancement of preexisting gene activities may not always be successful due to limitations in the level of precursor availability for up-regulated enzymes.

The feasibility of successful enhancement of essential oil yields, altering its composition and producing novel terpenoid compounds via metabolic engineering, has been well demonstrated in peppermint plants since the menthol pathway was recently established [96]. In transgenic peppermint the improved flux to GPP by up-regulation of the 1-deoxy-D-xylulose-5-phosphate reductoisomerase (DXR), which catalyzes the second and slow step of the MEP pathway, the conversion of 1-deoxy-D-xylulose-5-phosphate to methylerythritol phosphate, resulted in an almost 50% increase in the accumulation of essential oil [161]. The absence of changes in the complex peppermint oil composition also suggested that additional rate-determining step(s) reside somewhere downstream of DXR.

(+)-Menthofuran is an undesirable monoterpenoid component of peppermint essential oil that is derived from the  $\alpha,\beta$ -unsaturated ketone (+)-pulegone [162]. It contributes an off-flavor to the isolated essential oil, and also promotes off-color during storage [163, 164]. Stressful environmental conditions such as high temperature, drought and low light intensity can influence the plant menthofuran and pulegone contents, which can reach industrially unacceptable levels [97, 165]. While pulegone has the potential for further metabolism to menthone and menthol as long as pulegone reductase is present during the *de-novo* biosynthetic phase of oil production, menthofuran represents a dead-end metabolite with no alternative fate but accumulation. The reduction of menthofuran and pulegone in peppermint essential oil and the consequent improvement of the oil quality was recently achieved via a single alteration by eliminating one of the competitive branches in the metabolic network leading to menthofuran [166]. The co-suppression of menthofuran synthase blocked the branchway that channels pulegone away from the menthol pathway, thereby increasing the content of menthone and menthol in the essential oil. Parallel experiments with the overexpression of menthofuran synthase uncovered the unusual influence of menthofuran on the pulegone reductase

expression. High levels of menthofuran suppress pulegone reductase leading to the accumulation of high levels of pulegone, whereas low levels of menthofuran permit pulegone reductase expression and promote the conversion of pulegone to menthone and ultimately to menthol. While the physiological rationale for such complex regulation is presently unclear, it could have an important application in the control of natural products' biosynthetic pathways and production of high-quality commercial oils [166].

The biosynthesis of (-)-4S-limonene, the first committed intermediate of the menthol biosynthetic pathway, represents a possible rate-limiting step of monoterpene production in peppermint, and is catalyzed by limonene synthase [43, 167]. The levels of limonene in commercial peppermint oil are less than 1%, indicating that this olefin precursor is rapidly utilized in downstream biosynthetic steps and that consumption almost exceeds production. Constitutive expression of both limonene synthase and limonene-3-hydroxylase (which catalyzes the hydroxylation of limonene to (-)-trans-isopiperitenol), each driven by the *CaMV 35S* promoter, resulted in only moderate expression of introduced genes and no significant increase in corresponding enzyme activities in the glandular trichomes, the sites of essential oil biosynthesis in mint [168]. Obtained results revealed the insufficiency of the 35S viral promoter to significantly increase production of the target enzymes in the oil glands. However, effective co-suppression of the hydroxylase gene was achieved using the 35S promoter, and this resulted in significant limonene accumulation – up to 80% of the essential oil in transgenic plants, versus approximately 2% of the oil in wild plants. Interestingly, the essential oil yield was unaffected in these plants, indicating that pathway flux control resides upstream of this hydroxylation step and that accumulation of limonene has no feedback effect on limonene synthase, as well as no apparent effect on other monoterpene biosynthetic enzymes in peppermint [168].

In addition to improving the essential oil composition and yield, attempts have already been made to improve the aroma and flavor quality of fruits by metabolic engineering. The overexpression of tomato alcohol dehydrogenase (ADH) cDNA (*ADH 2*) under the fruit-specific tomato polygalacturonase promoter in transgenic tomato (*Lycopersicon esculentum*) plants influenced the balance between some of the aldehydes and the corresponding alcohols associated with flavor production, leading to a more intense “ripe fruit” flavor in ripening fruits [169]. Metabolic enhancement of aroma and flavor was also recently achieved by increasing the levels of monoterpenes in ripening tomato fruits [170]. Overexpression of the *Clarkia breweri* S-linalool synthase (*LIS*) gene, under the control of the tomato late-ripening-specific *E8* promoter in tomato plants, led to a more than 50-fold increase in linalool levels in tomato ripening fruits when compared with wild-type plants, without a concomitant decrease in the levels of other non-volatile terpenoids. In addition, some linalool was further oxidized to the volatile 8-hydroxylinalool, which was totally absent in the wild-type. Although the changed aroma of the intact fruits could easily be detected by the human nose, the actual effect on human preferences for transgenic fruits is still unknown as taste tests with humans have not yet been carried out [170].

## 20.6

## Conclusions

This chapter presents an overview of plant essential oils, their biosynthesis, and practical applications. To date, only 10% of known essential oils are used in the pharmaceutical, food, and cosmetic industries. New biological functions of essential oils and their mode of action remain to be determined. Rational improvement of the commercial production of essential oils via genetic modifications will require knowledge of essential oil-generating biochemical pathways and their regulation in oil-producing plants. The production of desirable essential oil composition will require single or multiple gene transfer. To this end, many obstacles must be overcome, including a limitation in substrate availability, any undesirable metabolism of the compound of interest, the formation of non-volatile byproducts, and/or the target compound sequestration which can significantly reduce or prevent volatile release. The biosynthesis and accumulation of volatile compounds in cell types in which they cannot be stored might potentially cause lethality. The redirection of metabolic flux toward a targeted compound may also have a deleterious effect on the plant as a result of depleting the general precursors required for normal plant development. Targeting the expression of the introduced gene to the specific cell and tissue types will require cell- and tissue-specific promoters which will help to avoid the deleterious effects of engineering on normal plant development and to achieve desirable emission. Additionally, transformation techniques will have to be developed for essential oil-producing plants.

## Acknowledgments

Studies conducted in the authors' laboratories are supported by the US National Science Foundation (grant numbers MCB-0212802 and MCB-0331333), the US Department of Agriculture (grant number 2005-35318-16207), the US Israel Binational Agriculture Research and Development funds (grant number US-3437-03), and the Fred Gloeckner Foundation, Inc.

## References

- 1 Sangwan, N.S., Farooqi, A.H.A., Shabih, F., Sangwan, R.S. Regulation of essential oil production in plants. *Plant Growth Regulation* **2001**, *34*, 3–21.
- 2 Lawrence, B.M. Aromatic plants for the flavor and fragrance industries. In: *Encyclopedia of Plant and Crop Science*, **2004**, pp. 58–64.
- 3 Van de Braak, S.A.A.J., Leijten, G.C.J.J. In: *Essential Oils and Oleoresins: A Survey in the Netherlands and other Major Markets in the European Union*. CBI, Centre for the Promotion of Imports from Developing Countries, Rotterdam, **1999**, p. 116.
- 4 Sacchettini, J.C., Poulter, C.D. Creating isoprenoid diversity. *Science* **1997**, *277*, 1788–1789.
- 5 Dewick, P.M. The biosynthesis of C5-C25 terpenoid compounds. *Nat. Prod. Rep.* **2002**, *19*, 181–222.

- 6 Croteau, R., Kutchan, T.M., Lewis, N.G. Natural products (secondary metabolites). In: Buchanan, B., Gruissem, W., Jones, R. (Eds.), *Biochemistry and Molecular Biology of Plants*. American Society of Plant Physiologists, **2000**, pp. 1250–1318.
- 7 Bach, T.J. Some new aspects of isoprenoid biosynthesis in plants: a review. *Lipids* **1995**, *30*, 191–202.
- 8 Rohmer, M., Knani, M., Simonin, P., Sutter, B., Sahm, H. Isoprenoid biosynthesis in bacteria: a novel pathway for the early steps leading to isopentenyl diphosphate. *Biochem. J.* **1993**, *295*, 517–524.
- 9 Lichtenthaler, H.K. The 1-deoxy-D-xylulose-5-phosphate pathway of isoprenoid biosynthesis in plants. *Annu. Rev. Plant Physiol. Plant Mol. Biol.* **1999**, *50*, 47–65.
- 10 Rohmer, M. The discovery of a mevalonate-independent pathway for isoprenoid biosynthesis in bacteria, algae and higher plants. *Nat. Prod. Rep.* **1999**, *16*, 565–574.
- 11 Kuzuyama, T., Seto, H. Diversity of the biosynthesis of the isoprene units. *Nat. Prod. Rep.* **2003**, *20*, 171–183.
- 12 Schuhr, C.A., Radykewicz, T., Sagner, S., Latzel, C., Zenk, M.H., Arigoni, D., Bacher, A., Rohdich, F., Eisenreich, W. Quantitative assessment of crosstalk between the two isoprenoid biosynthesis pathways in plants by NMR spectroscopy. *Phytochem. Rev.* **2003**, *2*, 3–16.
- 13 Hemmerlin, A., Hoeffler, J.F., Meyer, O., Tritsch, D., Kagan, I.A., Grosdemange-Billiard, C., Rohmer, M., Bach, T.J. Cross-talk between the cytosolic mevalonate and the plastidial methylerythritol phosphate pathways in tobacco bright yellow-2 cells. *J. Biol. Chem.* **2003**, *278*, 26666–26676.
- 14 Laule, O., Fürholz, A., Chang, H.-S., Zhu, T., Wang, X., Heifetz, P.B., Gruissem, W., Lange, M. Crosstalk between cytosolic and plastidial pathways of isoprenoid biosynthesis in *Arabidopsis thaliana*. *Proc. Natl. Acad. Sci. USA* **2003**, *100*, 6866–6871.
- 15 Dudareva, N., Andersson, S., Orlova, I., Gatto, N., Reichelt, M., Rhodes, D., Boland, W., Gershenzon, J. The non-mevalonate pathway supports both monoterpene and sesquiterpene formation in snapdragon flowers. *Proc. Natl. Acad. Sci. USA* **2005**, *102*, 933–938.
- 16 Koyama, T., Ogura, K. Isopentenyl diphosphate isomerase and prenyltransferases. In: Cane, D.E. (Ed.), *Comprehensive Natural Product Chemistry. Isoprenoids Including Carotenoids and Steroids*. Volume 2. Pergamon Press, Oxford, **1999**, pp. 69–96.
- 17 Liang, P.-H., Ko, T.-P., Wang, A.H.-J. Structure, mechanism and function of prenyltransferases. *Eur. J. Biochem.* **2002**, *269*, 3339–3354.
- 18 McGarvey, D.J., Croteau, R. Terpenoid metabolism. *Plant Cell* **1995**, *7*, 1015–1026.
- 19 Ogura, K., Koyama, T. Enzymatic aspects of isoprenoid chain elongation. *Chem. Rev.* **1995**, *98*, 1263–1276.
- 20 Poulter, C.D., Rilling, H.C. Prenyltransferases and isomerases. In: Porter, J.W., Spurgeon, S.L. (Eds.), *Biosynthesis of isoprenoid compounds*. Volume 1. John Wiley & Sons, New York, **1981**, pp. 413–441.
- 21 Bouvier, F., Suire, C., d'Harlingue, A., Backhaus, R.A., Camara, B. Molecular cloning of geranyl diphosphate synthase and compartmentation of monoterpene synthesis in plant cells. *Plant J.* **2000**, *24*, 241–252.
- 22 Burke, C.C., Croteau, R. Geranyl diphosphate synthase from *Abies grandis*: cDNA isolation, functional expression, and characterization. *Arch. Biochem. Biophys.* **2002**, *405*, 130–136.
- 23 Burke, C.C., Wildung, M.R., Croteau, R. Geranyl diphosphate synthase: cloning, expression, and characterization of this prenyltransferase as a heterodimer. *Proc. Natl. Acad. Sci. USA* **1999**, *96*, 13062–13067.
- 24 Tholl, D., Kish, C.M., Orlova, I., Sherman, D., Gershenzon, J., Pichersky, E., Dudareva, N. Formation of monoterpenes in *Antirrhinum majus* and *Clarkia breweri* flowers involves heterodimeric geranyl diphosphate synthases. *Plant Cell* **2004**, *16*, 977–992.
- 25 Cane, D.E. Sesquiterpene biosynthesis: cyclization mechanisms. In: Cane, D.E. (Ed.), *Comprehensive Natural Products Chemistry. Isoprenoids Including*



- Carotenoids and Steroids*. Volume 2. Pergamon Press, Oxford, 1999, pp. 55–200.
- 26 Wise, M.L., Croteau, R. Monoterpene biosynthesis. In: Cane, D.E. (Ed.), *Comprehensive Natural Products Chemistry. Isoprenoids Including Carotenoids and Steroids*. Volume 2. Pergamon Press, Oxford, 1999, pp. 97–153.
  - 27 Dudareva, N., Pichersky, E., Gershenzon, J. Biochemistry of plant volatiles. *Plant Physiol.* 2004, 135, 1893–1902.
  - 28 Lawrence, B.M. Labiatae oils – mother nature's chemical factory. In: Lawrence, B.M. (Ed.), *Essential Oils*. Allured Publishing, Carol Stream, IL, 1993, pp. 188–206.
  - 29 Charles, D.J., Simon, J.E. A new geraniol chemotype of *Ocimum gratissimum* L. *J. Essent. Oil Res.* 1992, 4, 231–234.
  - 30 Martins, A.P., Salgueiro, L.G., Vila, R., Tomi, F., Cañigueral, S., Casanova, J., Cunha, A.P., Adzet, T. Composition of the essential oils of *O. canum*, *O. gratissimum* and *O. minimum*. *Planta Med.* 1999, 65, 187–189.
  - 31 Gershenzon, J., Croteau, R. Terpenoid biosynthesis: the basic pathway and formation of monoterpenes, sesquiterpenes and diterpenes. In: Moore, T.S., Jr. (Ed.), *Lipid Metabolism in Plants*. CRC Press, Boca Raton, FL, 1993, pp. 339–388.
  - 32 Dudareva, N., Cseke, L., Blanc, V.M., Pichersky, E. Evolution of floral scent in *Clarkia*: novel patterns of S-linalool synthase gene expression in the *C. breweri* flower. *Plant Cell* 1996, 8, 1137–1148.
  - 33 Chen, F., Tholl, D., D'Auria, J.C., Farooq, A., Pichersky, E., Gershenzon, J. Biosynthesis and emission of terpenoid volatiles from *Arabidopsis* flowers. *Plant Cell* 2003, 15, 481–494.
  - 34 Crowell, A.L., Williams, D.C., Davis, E.M., Wildung, M.R., Croteau, R. Molecular cloning and characterization of a new linalool synthase. *Arch. Biochem. Biophys.* 2002, 405, 112–121.
  - 35 Jia, J.W., Crock, J., Lu, S., Croteau, R., Chen, X.Y. (3R)-Linalool synthase from *Artemisia annua* L.: cDNA isolation, characterization, and wound induction. *Arch. Biochem. Biophys.* 1999, 372, 143–149.
  - 36 Martin, D.M., Faldt, J., Bohlmann, J. Functional characterization of nine Norway Spruce TPS genes and evolution of gymnosperm terpene synthases of the TPS-d subfamily. *Plant Physiol.* 2004, 135, 1908–1927.
  - 37 Iijima, Y., Davidovich-Rikanati, R., Fridman, E., Gang, D.R., Bar, E., Lewinsohn, E., Pichersky, E. The biochemical and molecular basis for the divergent patterns in the biosynthesis of terpenes and phenylpropenes in the peltate glands of three cultivars of basil. *Plant Physiol.* 2004, 136, 3724–3736.
  - 38 Dudareva, N., Martin, D., Kish, C.M., Kolosova, N., Gorenstein, N., Faldt, J., Miller, B., Bohlmann, J. (*E*)- $\beta$ -Ocimene and myrcene synthase genes of floral scent biosynthesis in snapdragon: function and expression of three terpene synthase genes of a new TPS-subfamily. *Plant Cell* 2003, 15, 1227–1241.
  - 39 Bohlmann, J., Steele, C.L., Croteau, R. Monoterpene synthases from grand fir (*Abies grandis*). cDNA isolation, characterization, and functional expression of myrcene synthase, (–)-(4S)-limonene synthase, and (–)-(1S,5S)-pinene synthase. *J. Biol. Chem.* 1997, 272, 21784–21792.
  - 40 Faldt, J., Arimura, G., Gershenzon, J., Takabayashi, J., Bohlmann, J. Functional identification of AtTPS03 as (*E*)-beta-ocimene synthase: a monoterpene synthase catalyzing jasmonate- and wound-induced volatile formation in *Arabidopsis thaliana*. *Planta* 2003, 216, 745–751.
  - 41 Hoelscher, D.J., Williams, D.C., Wildung, M.R., Croteau, R. A cDNA clone for 3-carene synthase from *Salvia stenophylla*. *Phytochemistry* 2003, 62, 1081–1086.
  - 42 Faldt, J., Martin, D., Miller, B., Rawat, S., Bohlmann, J. Traumatic resin defense in Norway spruce (*Picea abies*): methyl jasmonate-induced terpene synthase gene expression, and cDNA cloning and functional characterization of (+)-3-carene synthase. *Plant Mol. Biol.* 2003, 51, 119–133.
  - 43 Colby, S.M., Alonso, W.R., Katahira, E.J., McGarvey, D.J., Croteau, R. 4S-limonene synthase from the oil glands of spear-



- mint (*Mentha spicata*). cDNA isolation, characterization, and bacterial expression of the catalytically active monoterpene cyclase. *J. Biol. Chem.* **1993**, *268*, 23016–23024.
- 44 Yuba, A., Yazaki, K., Tabata, M., Honda, G., Croteau, R. cDNA cloning, characterization, and functional expression of 4S-(–)-limonene synthase from *Perilla frutescens*. *Arch. Biochem. Biophys.* **1996**, *332*, 280–287.
- 45 Lucker, J., El Tamer, M.K., Schwab, W., Verstappen, F.W., van der Plas, L.H., Bouwmeester, H.J., Verhoeven, H.A. Monoterpene biosynthesis in lemon (*Citrus limon*). cDNA isolation and functional analysis of four monoterpene synthases. *Eur. J. Biochem.* **2002**, *269*, 3160–3171.
- 46 Phillips, M.A., Wildung, M.R., Williams, D.C., Hyatt, D.C., Croteau, R. cDNA isolation, functional expression, and characterization of (+)-alpha-pinene synthase and (–)-alpha-pinene synthase from loblolly pine (*Pinus taeda*): stereocontrol in pinene biosynthesis. *Arch. Biochem. Biophys.* **2003**, *411*, 267–276.
- 47 Huber, D.P., Philippe, R.N., Godard, K.A., Sturrock, R.N., Bohlmann, J. Characterization of four terpene synthase cDNAs from methyl jasmonate-induced Douglas-fir, *Pseudotsuga menziesii*. *Phytochemistry* **2005**, *66*, 1427–1439.
- 48 Lu, S., Xu, R., Jia, J.W., Pang, J., Matsuda, S.P., Chen, X.Y. Cloning and functional characterization of a beta-pinene synthase from *Artemisia annua* that shows a circadian pattern of expression. *Plant Physiol.* **2002**, *130*, 477–486.
- 49 Wise, M.L., Savage, T.J., Katahira, E., Croteau, R. Monoterpene synthases from common sage (*Salvia officinalis*). cDNA isolation, characterization, and functional expression of (+)-sabinene synthase, 1,8-cineole synthase, and (+)-bornyl diphosphate synthase. *J. Biol. Chem.* **1998**, *273*, 14891–14899.
- 50 Chen, F., Ro, D.K., Petri, J., Gershenzon, J., Bohlmann, J., Pichersky, E., Tholl, D. Characterization of a root-specific *Arabidopsis* terpene synthase responsible for the formation of the volatile monoterpene 1,8-cineole. *Plant Physiol.* **2004**, *135*, 1956–1966.
- 51 Iijima, Y., Gang, D.R., Fridman, E., Lewinsohn, E., Pichersky, E. Characterization of geraniol synthase from the peltate glands of sweet basil. *Plant Physiol.* **2004**, *134*, 370–379.
- 52 Yang, T., Li, J., Wang, H.X., Zeng, Y. A geraniol-synthase gene from *Cinnamomum tenuipilum*. *Phytochemistry* **2005**, *66*, 285–293.
- 53 Bohlmann, J., Martin, D., Oldham, N.J., Gershenzon, J. Terpenoid secondary metabolism in *Arabidopsis thaliana*: cDNA cloning, characterization, and functional expression of a myrcene/(E)-beta-ocimene synthase. *Arch. Biochem. Biophys.* **2000**, *375*, 261–269.
- 54 Hosoi, M., Ito, M., Yagura, T., Adams, R.P., Honda, G. cDNA isolation and functional expression of myrcene synthase from *Perilla frutescens*. *Biol. Pharm. Bull.* **2004**, *27*, 1979–1985.
- 55 Shalit, M., Guterman, I., Volpin, H., Bar, E., Tamari, T., Menda, N., Adam, Z., Zamir, D., Vainstein, A., Weiss, D., Pichersky, E., Lewinsohn, E. Volatile ester formation in roses. Identification of an acetyl-coenzyme A. Geraniol/Citronellol acetyltransferase in developing rose petals. *Plant Physiol.* **2003**, *131*, 1868–1876.
- 56 Lupien, S., Karp, F., Wildung, M., Croteau, R. Regiospecific cytochrome P450 limonene hydroxylases from mint (*Mentha*) species: cDNA isolation, characterization, and functional expression of (–)-4S-limonene-3-hydroxylase and (–)-4S-limonene-6-hydroxylase. *Arch. Biochem. Biophys.* **1999**, *368*, 181–192.
- 57 Luan, F., Mosandl, A., Munch, A., Wust, M. Metabolism of geraniol in grape berry mesocarp of *Vitis vinifera* L. cv. Scheurebe: demonstration of stereoselective reduction, E/Z-isomerization, oxidation and glycosylation. *Phytochemistry* **2005**, *66*, 295–303.
- 58 Connolly, J.D., Hill, R.A. *Dictionary of Terpenoids*. Chapman & Hall, London, **1992**.
- 59 Cai, Y., Jia, J.W., Crock, J., Lin, Z.X., Chen, X.Y., Croteau, R. A cDNA clone

- for beta-caryophyllene synthase from *Artemisia annua*. *Phytochemistry* **2002**, *61*, 523–529.
- 60 Prosser, I., Phillips, A.L., Gittings, S., Lewis, M.J., Hooper, A.M., Pickett, J.A., Beale, M.H. (+)-(10R)-Germacrene A synthase from goldenrod, *Solidago canadensis*; cDNA isolation, bacterial expression and functional analysis. *Phytochemistry* **2002**, *60*, 691–702.
- 61 Bouwmeester, H.J., Kodde, J., Verstappen, F.W., Altug, I.G., de Kraker, J.W., Wallaart, T.E. Isolation and characterization of two germacrene A synthase cDNA clones from chicory. *Plant Physiol.* **2002**, *129*, 134–144.
- 62 Guterman, I., Shalit, M., Menda, N., Piestun, D., Dafny-Yelin, M., Shalev, G., Bar, E., Davydov, O., Ovadis, M., Emanuel, M., Wang, J., Adam, Z., Pichersky, E., Lewinsohn, E., Zamir, D., Vainstein, A., Weiss, D. Rose scent: genomics approach to discovering novel floral fragrance-related genes. *Plant Cell* **2002**, *14*, 2325–2338.
- 63 Prosser, I., Altug, I.G., Phillips, A.L., Konig, W.A., Bouwmeester, H.J., Beale, M.H. Enantiospecific (+)- and (–)-germacrene D synthases, cloned from goldenrod, reveal a functionally active variant of the universal isoprenoid-biosynthesis aspartate-rich motif. *Arch. Biochem. Biophys.* **2004**, *432*, 136–144.
- 64 Luckner, J., Bowen, P., Bohlmann, J. *Vitis vinifera* terpenoid cyclases: functional identification of two sesquiterpene synthase cDNAs encoding (+)-valencene synthase and (–)-germacrene D synthase and expression of mono- and sesquiterpene synthases in grapevine flowers and berries. *Phytochemistry* **2004**, *65*, 2649–2659.
- 65 Schnee, C., Kollner, T.G., Gershenzon, J., Degenhardt, J. The maize gene terpene synthase 1 encodes a sesquiterpene synthase catalyzing the formation of (E)-beta-farnesene, (E)-nerolidol, and (E,E)-farnesol after herbivore damage. *Plant Physiol.* **2002**, *130*, 2049–2060.
- 66 Crock, J., Wildung, M., Croteau, R. Isolation and bacterial expression of a sesquiterpene synthase cDNA clone from peppermint (*Mentha x piperita*, L.) that produces the aphid alarm pheromone (E)-beta-farnesene. *Proc. Natl. Acad. Sci. USA* **1997**, *94*, 12833–12838.
- 67 Maruyama, T., Ito, M., Honda, G. Molecular cloning, functional expression and characterization of (E)-beta-farnesene synthase from *Citrus junos*. *Biol. Pharm. Bull.* **2001**, *24*, 1171–1175.
- 68 Picaud, S., Brodelius, M., Brodelius, P.E. Expression, purification and characterization of recombinant (E)-beta-farnesene synthase from *Artemisia annua*. *Phytochemistry* **2005**, *66*, 961–967.
- 69 Aharoni, A., Giri, A.P., Verstappen, F.W., Berthea, C.M., Sevenier, R., Sun, Z., Jongsma, M.A., Schwab, W., Bouwmeester, H.J. Gain and loss of fruit flavor compounds produced by wild and cultivated strawberry species. *Plant Cell* **2004**, *16*, 3110–3131.
- 70 Sharon-Asa, L., Shalit, M., Frydman, A., Bar, E., Holland, D., Or, E., Lavi, U., Lewinsohn, E., Eyal, Y. Citrus fruit flavor and aroma biosynthesis: isolation, functional characterization, and developmental regulation of *Cstps1*, a key gene in the production of the sesquiterpene aroma compound valencene. *Plant J.* **2003**, *36*, 664–674.
- 71 Prosser, I.M., Adams, R.J., Beale, M.H., Hawkins, N.D., Phillips, A.L., Pickett, J.A., Field, L.M. Cloning and functional characterisation of a cis-muroladiene synthase from black peppermint (*Mentha x piperita*) and direct evidence for a chemotype unable to synthesise farnesene. *Phytochemistry* **2006** (in press).
- 72 Tholl, D., Chen, F., Petri, J., Gershenzon, J., Pichersky, E. Two sesquiterpene synthases are responsible for the complex mixture of sesquiterpenes emitted from *Arabidopsis* flowers. *Plant J.* **2005**, *42*, 757–771.
- 73 Gildemeister, E., Hoffmann, F.R. *Ätherischen Öle*. Pharmaceutical Review Publication Co., Milwaukee, WI, **1913**.
- 74 Guenther, E. *The Essential Oils*. D. Van Nostrand Company, Princeton, NJ, **1949**.
- 75 Samuelsson, G. Drugs of natural origin. In: *A Textbook of Pharmacognosy*. Swedish Pharmaceutical Press, Stockholm, **1991**, p. 320.

- 76 Barazani, O., Fait, A., Cohen, Y., Diminshtein, S., Ravid, U., Putievsky, E., Lewinsohn, E., Friedman, J. Chemical variation among indigenous populations of *Foeniculum vulgare* var. *vulgare* in Israel. *Planta Med.* **1999**, *65*, 486–489.
- 77 Werker, E., Putievsky, E., Ravid, U., Dudai, N., Katzir, I. Glandular hairs, secretory cavities, and the essential oil in leaves of Tarragon (*Artemisia dracunculus* L.). *J. Herbs, Spices Medicinal Plants* **1994**, *2*, 19–32.
- 78 Chappell, J. The biochemistry and molecular biology of isoprenoid metabolism. *Plant Physiol.* **1995**, *107*, 1–6.
- 79 Bohlmann, J., Meyer-Gauen, G., Croteau, R. Plant terpenoid syntheses: molecular biology and phylogenetic analysis. *Proc. Natl. Acad. Sci. USA* **1998**, *95*, 4126–4133.
- 80 Ro, D.K., Douglas, C.J. Reconstitution of the entry point of plant phenylpropanoid metabolism in yeast (*Saccharomyces cerevisiae*): implications for control of metabolic flux into the phenylpropanoid pathway. *J. Biol. Chem.* **2004**, *279*, 2600–2607.
- 81 Klischies, M., Stockigt, J., Zenk, M.H. Biosynthesis of the allylphenols eugenol and methyleugenol in *Ocimum basilicum* L. *Chem. Commun.* **1975**, *21*, 879–880.
- 82 Manitto, P., Monti, D., Gramatica, P. Biosynthesis of phenylpropanoid compounds: I. biosynthesis of eugenol in *Ocimum basilicum* L. *J. Chem. Soc. Perkin Trans. I* **1974**, *14*, 1727–1731.
- 83 Manitto, P., Gramatica, P., Monti, D. Biosynthesis of phenylpropanoid compounds: II. Incorporation of specifically labeled cinnamic acids into eugenol (*Ocimum basilicum*). *J. Chem. Soc. Perkin Trans. I* **1975**, *16*, 1549–1551.
- 84 Senanayake, U.M., Wills, R.B.H., Lee, T.H. Biosynthesis of eugenol and cinnamic aldehyde in *Cinnamomum zeylanicum*. *Phytochemistry* **1977**, *16*, 2032–2033.
- 85 Gang, D.R., Lavid, N., Zubieta, C., Chen, F., Beuerle, T., Lewinsohn, E., Noel, J.P., Pichersky, E. Characterization of phenylpropene O-methyltransferases from sweet basil: facile change of substrate specificity and convergent evolution within a plant OMT family. *Plant Cell* **2002**, *14*, 505–519.
- 86 Wang, J., Dudareva, N., Bhakta, S., Raguso, R., Pichersky, E. Floral scent production in *Clarkia breweri* (Onagraceae): II. Localization and developmental modulation of the enzyme S-adenosyl-L-methionine:(iso) eugenol O-methyltransferase and phenylpropanoid emission. *Plant Physiol.* **1997**, *114*, 213–221.
- 87 Wildung, M.R., Croteau, R.B. Genetic engineering of peppermint for improved essential oil composition and yield. *Transgenic Res.* **2005**, *14*, 365–372.
- 88 Croteau, R. Site of monoterpene biosynthesis in *Majorama hortensis* leaves. *Plant Physiol.* **1977**, *59*, 519–520.
- 89 Croteau, R., Felton, M., Karp, F., Kijonwas, R. Relationship of camphor biosynthesis to leaf development in Sage (*Salvia officinalis*). *Plant Physiol.* **1981**, *67*, 820–824.
- 90 Singh, N., Luthra, R., Sangwan, R.S. Effect of leaf position and age on the essential oil quantity and quality in lemongrass. *Planta Med.* **1989**, *55*, 214–256.
- 91 Akhila, A., Tyagi, B.R., Naqvi, A. Variation of essential oil constituents in *C. martinii* Wats var. *motia* at different stages of plant growth. *Ind. Perfumer* **1987**, *28*, 126–128.
- 92 Sangwan, N.K., Dhindsa, K.S., Malik, O.P., Sharma, G.D., Paroda, R.S. Quantitative changes in levels of essential oil in *C. martinii* var. *motia* during different growth stages and on ageing the harvested crop in field and Laboratory. In: Proceedings of the National Seminar on Medicinal and Aromatic Plants, India, **1982**.
- 93 Weiss, E.A. In: *Essential Oil Crops*. CAB International, **1997**, pp. 24–58.
- 94 Francis, M.J.O. In: Goodwin, T.W. (Ed.), *Aspects of Terpenoid Chemistry and Biochemistry*. Academic Press, London, **1971**, p. 29.
- 95 Amelunxen, F. Elektronenmikroskopische Untersuchungen an den Drüenschuppen von *Mentha piperita* L. *Planta Med.* **1965**, *13*, 457–473.
- 96 Croteau, R.B., Davis, E.M., Ringer, K.L., Wildung, M.R. (–)-Menthol biosynthesis

- and molecular genetics. *Naturwissenschaften* **2005**, *92*, 562–577.
- 97** Burbott, A.J., Loomis, W.D. Effects of light and temperature on the monoterpene of peppermint. *Plant Physiol.* **1967**, *42*, 20–28.
- 98** Croteau, R., Martinkus, C. Metabolism of monoterpenes: demonstration of (+)-neomenthyl- $\beta$ -D-glucoside as a major metabolite of (–)-menthone in peppermint (*Mentha piperita*). *Plant Physiol.* **1979**, *64*, 169–175.
- 99** McConkey, M.E., Gershenzon, J., Croteau, R. Developmental regulation of monoterpene biosynthesis in the glandular trichomes of peppermint (*Mentha x piperita* L.). *Plant Physiol.* **2000**, *122*, 215–223.
- 100** Davis, E.M., Ringer, K.L., McConkey, M.E., Croteau, R. Monoterpene metabolism: cloning, expression and characterization of menthone reductases from peppermint (*Mentha x piperita*). *Plant Physiol.* **2005**, *137*, 873–881.
- 101** Gershenzon, J., McConkey, M.E., Croteau, R.B. Regulation of monoterpene accumulation in leaves of peppermint. *Plant Physiol.* **2000**, *122*, 205–214.
- 102** Von Schantz, M., Ek, B.S. Über die Bildung von ätherischem Öl in Kümmel. *Carum carvi* L. *Sci. Pharm.* **1971**, *39*, 81–101.
- 103** Bouwmeester, H.J., Kuijpers, A.-M. Relationship between assimilate supply and essential oil accumulation in annual and biennial caraway (*Carum carvi* L.). *J. Essent. Oil Res.* **1993**, *5*, 143–152.
- 104** Bouwmeester, H.J., Davies, J.A.R., Smid, H.G., Welten, R.S.A. Physiological limitations to carvone yield in caraway (*Carum carvi* L.). *Ind. Crops Prod.* **1995**, *4*, 39–51.
- 105** Bouwmeester, H.J., Gershenzon, J., Konings, M.C.J.M., Croteau, R. Biosynthesis of the monoterpenes limonene and carvone in the fruit of caraway. I. Demonstration of enzyme activities and their changes with development. *Plant Physiol.* **1998**, *117*, 901–912.
- 106** Lewinsohn, E., Ziv-Raz, I., Dudai, N., Tadmor, Y., Lastochkin, E., Larkov, O., Chaimovitsh, D., Ravid, U., Putievsky, E., Pichersky, E., Shoham, Y. Biosynthesis of estragole and methyl-eugenol in sweet basil (*Ocimum basilicum* L): Developmental and chemotypic association of allylphenol O-methyltransferase activities. *Plant Sci.* **2000**, *160*, 27–35.
- 107** Anthony, J.P., Fyfe, L., Smith, H. Plant active components – a resource for antiparasitic agents? *Trends Parasitol.* **2005**, *21*, 462–468.
- 108** Crowell, P.L., Gould, M.N. Chemoprevention and therapy of cancer by d-limonene. *Crit. Rev. Oncog.* **1994**, *5*, 1–22.
- 109** Elson, C.E., Yu, S.G. The chemoprevention of cancer by mevalonate-derived constituents of fruits and vegetables. *J. Nutr.* **1994**, *124*, 607–614.
- 110** Elson, C.E. Suppression of mevalonate pathway activities by dietary isoprenoids: protective roles in cancer and cardiovascular disease. *J. Nutr.* **1995**, *125*, 1666S–1672S.
- 111** Hursting, S.D., Perkins, S.N., Haines, D.C., Ward, J.M., Phang, J.M. Chemoprevention of spontaneous tumorigenesis in p53-knockout mice. *Cancer Res.* **1995**, *55*, 3949–3953.
- 112** Crowell, P.L. Monoterpenes in breast cancer chemoprevention. *Breast Cancer Res. Treat.* **1997**, *46*, 191–197.
- 113** Stark, M.J., Burke, Y.D., McKinzie, J.H., Ayoubi, A.S., Crowell, P.L. Chemotherapy of pancreatic cancer with the monoterpene perillyl alcohol. *Cancer Lett.* **1995**, *96*, 15–21.
- 114** Broitman, S.A., Wilkinson, J., IV, Cerda, S., Branch, S.K. Effects of monoterpenes and mevinolin on murine colon tumor CT-26 in vitro and its hepatic ‘metastases’ in vivo. *Adv. Exp. Med. Biol.* **1996**, *401*, 111–130.
- 115** Fulton, G.J., Barber, L., Svendsen, E., Hagen, P.O., Davies, M.G. Oral monoterpene therapy (perillyl alcohol) reduces vein graft intimal hyperplasia. *J. Surg. Res.* **1997**, *69*, 128–134.
- 116** Reddy, B.S., Wang, C.X., Samaha, H., Lubet, R., Steele, V.E., Kelloff, G.J., Rao, C.V. Chemoprevention of colon carcinogenesis by dietary perillyl alcohol. *Cancer Res.* **1997**, *57*, 420–425.

- 117 Dudai, N., Weinstein, Y., Krup, M., Rabinski, T., Ofir, R. Citral is a new inducer of caspase-3 in tumor cell lines. *Planta Med.* **2005**, *71*, 484–488.
- 118 Wattenberg, L.W., Sparnins, V.L., Barany, G. Inhibition of N-nitroso-diethylamine carcinogenesis in mice by naturally occurring organosulfur compounds and monoterpenes. *Cancer Res.* **1989**, *49*, 2689–2692.
- 119 Crowell, P.L., Kennan, W.S., Haag, J.D., Ahmad, S., Vedejs, E., Gould, M.N. Chemoprevention of mammary carcinogenesis by hydroxylated derivatives of d-limonene. *Carcinogenesis* **1992**, *13*, 1261–1264.
- 120 Russin, W.A., Hoesly, J.D., Elson, C.E., Tanner, M.A., Gould, M.N. Inhibition of rat mammary carcinogenesis by monoterpenoids. *Carcinogenesis* **1989**, *10*, 2161–2164.
- 121 Shoff, S.M., Grummer, M., Yatvin, M.B., Elson, C.E. Concentration-dependent increase of murine P388 and B16 population doubling time by the acyclic monoterpene geraniol. *Cancer Res.* **1991**, *51*, 37–42.
- 122 Yu, S.G., Hildebrandt, L.A., Elson, C.E. Geraniol, an inhibitor of mevalonate biosynthesis, suppresses the growth of hepatomas and melanomas transplanted to rats and mice. *J. Nutr.* **1995**, *125*, 2763–2767.
- 123 Sylvestre, M., Pichette, A., Longtin, A., Nagau, F., Legault, J. Essential oil analysis and anticancer activity of leaf essential oil of *Croton flavens* L. from Guadeloupe. *J. Ethnopharmacol.* **2006**, *103*, 99–102.
- 124 Yoo, C.B., Han, K.T., Cho, K.S., Ha, J., Park, H.J., Nam, J.H., Kil, U.H., Lee, K.T. Eugenol isolated from the essential oil of *Eugenia caryophyllata* induces a reactive oxygen species-mediated apoptosis in HL-60 human promyelocytic leukemia cells. *Cancer Lett.* **2005**, *225*, 41–52.
- 125 Sylvestre, M., Legault, J., Dufour, D., Pichette, A. Chemical composition and anticancer activity of leaf essential oil of *Myrica gale* L. *Phytomedicine* **2005**, *12*, 299–304.
- 126 Sigurdsson, S., Ogmundsdottir, H.M., Gudbjarnason, S. The cytotoxic effect of two chemotypes of essential oils from the fruits of *Angelica archangelica* L. *Anticancer Res.* **2005**, *25*, 1877–1880.
- 127 Calcabrini, A., Stringaro, A., Toccaceli, L., Meschini, S., Marra, M., Colone, M., Salvatore, G., Mondello, F., Arancia, G., Molinari, A. Terpinen-4-ol, the main component of *Melaleuca alternifolia* (tea tree) oil inhibits the in vitro growth of human melanoma cells. *J. Invest. Dermatol.* **2004**, *122*, 349–360.
- 128 de Sousa, A.C., Alviano, D.S., Blank, A.F., Alves, P.B., Alviano, C.S., Gattass, C.R. *Melissa officinalis* L. essential oil: antitumoral and antioxidant activities. *J. Pharm. Pharmacol.* **2004**, *56*, 677–681.
- 129 de Oliveira Mendes, S.T., Ribeiro Sobrinho, A.P., de Carvalho, A.T., de Souza Cortes, M.I., Vieira, L.Q. In vitro evaluation of the cytotoxicity of two root canal sealers on macrophage activity. *J. Endod.* **2003**, *29*, 95–99.
- 130 Chan, M.M., Ho, C.T., Huang, H.I. Effects of three dietary phytochemicals from tea, rosemary and turmeric on inflammation-induced nitrite production. *Cancer Lett.* **1995**, *96*, 23–29.
- 131 Courreges, M.C., Benencia, F. In vitro antiphagocytic effect of basil oil on mouse macrophages. *Fitoterapia* **2002**, *73*, 369–374.
- 132 Feng, Z.H., Zhang, G.M., Hao, T.L., Zhou, B., Zhang, H., Jiang, Z.Y. Effect of diallyl trisulfide on the activation of T cell and macrophage-mediated cytotoxicity. *J. Tongji Med. Univ.* **1994**, *14*, 142–147.
- 133 Rosa, M.S., Mendonça-Filho, R.R., Bizzo, H.R., Rodrigues, I.A., Soares, R.M.A., Souto-Padrón, T., Alviano, C.S., Lopes, A.H.C.S. Antileishmanial activity of a linalool-rich essential oil from *Croton cajucara*. *Antimicrob. Agents Chemother.* **2003**, *47*, 1895–1901.
- 134 Mikus, J., Harkenthal, M., Steverding, D., Reichling, J. In vitro effect of essential oils and isolated mono and sesquiterpenes on *Leishmania major* and *Trypanosoma brucei*. *Planta Med.* **2000**, *66*, 366–368.
- 135 Chang, S.T., Cheng, S.S. Antitermitic activity of leaf essential oils and components from *Cinnamomum osmophleum*. *J. Agric. Food. Chem.* **2002**, *50*, 1389–1392.

- 136 Zenner, L., Callait, M.P., Granier, C., Chauve, C. In vitro effect of essential oils from *Cinnamomum aromaticum*, *Citrus limon* and *Allium sativum* on two intestinal flagellates of poultry, *Tetratrichomonas gallinarum* and *Histomonas meleagridis*. *Parasite* **2003**, *10*, 153–157.
- 137 Asha, M.K., Prashanth, D., Murali, B., Padmaja, R., Amit, A. Anthelmintic activity of essential oil of *Ocimum sanctum* and eugenol. *Fitoterapia* **2001**, *72*, 669–670.
- 138 Pessoa, L.M., Morais, S.M., Bevilacqua, C.M., Luciano, J.H. Anthelmintic activity of essential oil of *Ocimum gratissimum* Linn. and eugenol against *Haemonchus contortus*. *Vet. Parasitol.* **2003**, *109*, 59–63.
- 139 Force, M., Sparks, W.S., Ronzio, R.A. Inhibition of enteric parasites by emulsified oil of oregano in vivo. *Phytother. Res.* **2000**, *14*, 213–214.
- 140 Giannenas, I., Florou-Paneri, P., Papazahariadou, M., Christaki, E., Botsoglou, N.A., Spais, A.B. Effect of dietary supplementation with oregano essential oil on performance of broilers after experimental infection with *Eimeria tenella*. *Arch. Tierernahr.* **2003**, *57*, 99–106.
- 141 Ankri, S., Mirelman, D. Antimicrobial properties of allicin from garlic. *Microbes Infect.* **1999**, *1*, 125–129.
- 142 Burt, S. Essential oils: their antibacterial properties and potential applications in foods – a review. *Int. J. Food Microbiol.* **2004**, *94*, 223–253.
- 143 Manabe, A., Nakayama, S., Sakamoto, K. Effects of essential oils on erythrocytes and hepatocytes from rats and dipalmitoyl phosphatidylcholine-liposomes. *Jpn. J. Pharmacol.* **1987**, *44*, 77–84.
- 144 Bauer, K., Garbe, D. In: *Common Fragrance and Flavor Materials. Preparation, Properties and Uses*. VCH Verlagsgesellschaft, Weinheim, **1985**, p. 213.
- 145 Cox, S.D., Mann, C.M., Markham, J.L., Bell, H.C., Gustafson, J.E., Warmington, J.R., Wyllie, S.G. The mode of antimicrobial action of essential oil of *Melaleuca alternifolia* (tea tree oil). *J. Appl. Microbiol.* **2000**, *88*, 170–175.
- 146 Van Krimpen, M.M., Binnendijk, G.P. Ropadiar® as alternative for antimicrobial growth promoter in diets of weanling pigs. Lelystad, Praktijkonderzoek Veehouderij, **2001**, p. 14.
- 147 Ilsley, S., Miller, H., Greathead, H., Kamel, C. Herbal sow diets boost pre-weaning growth. *Pig Progress* **2002**, *18*, 8–10.
- 148 Mendoza-Yepes, M.J., Sanchez-Hidalgo, L.E., Maertens, G., Marin-Iniesta, F. Inhibition of *Listeria monocytogenes* and other bacteria by a plant essential oil (DMC) in Spanish soft cheese. *J. Food Safety* **1997**, *17*, 47–55.
- 149 Hartmans, K.J., Diepenhorst, P., Bakker, W., Gorris, L.G.M. The use of carvone in agriculture: sprout suppression of potatoes and antifungal activity against potato tuber and other plant diseases. *Ind. Crops Products* **1995**, *4*, 3–13.
- 150 Thorgrismen, L., Spector, A., Wiles, A., Orrell, M. Aromatherapy for dementia. The Cochrane Database of Systematic Reviews Issue 3. Art. No.: CD003150. DOI: 10.1002/14651858.CD003150, **2003**.
- 151 Maddocks-Jennings, W., Wilkinson, J.M. Aromatherapy practice in nursing: literature review. *J. Adv. Nurs.* **2004**, *48*, 93–103.
- 152 Gbolade, A.A., Oyedele, A.O., Sosan, M.B., Adewayin, F.B., Soyela, O.L. Mosquito repellent activities of essential oils from two Nigerian *Ocimum* species. *J. Trop. Med. Plants* **2000**, *1*, 146–148.
- 153 Adebayo, T.A., Gbolade, A.A., Olaiya, J.I. Comparative study of toxicity of essential oils to larvae of three mosquito species. *Nigerian J. Nat. Prod. Med.* **1999**, *3*, 74–76.
- 154 Isman, M.B. Botanical insecticides, deterrents, and repellents in modern agriculture and an increasingly regulated world. *Annu. Rev. Entomol.* **2006**, *51*, 45–66.
- 155 Hummelbrunner, L.A., Isman, M.B. Acute, sublethal, antifeedant, and synergistic effects of monoterpenoid essential oil compounds on the tobacco cutworm, *Spodoptera litura* (Lep., Noctuidae). *J. Agric. Food Chem.* **2001**, *49*, 715–720.



- 156 Nishimura, H. Aroma constituents in plants and their repellent activities against mosquitoes. *Aroma Res.* **2001**, *2*, 257–267.
- 157 Omolo, M.O., Okinyo, D., Ndiege, I.O., Lwande, W., Hassanali, A. Repellency of essential oils of some Kenyan plants against *Anopheles gambiae*. *Phytochemistry* **2004**, *65*, 2797–2802.
- 158 Ngoh, S.P., Choo, L.E.W., Pang, F.Y., Huang, Y., Kini, M.R., Ho, S.H. Insecticidal and repellent properties of nine volatile constituents of essential oils against the American cockroach, *Periplaneta americana* L. *Pesticide Sci.* **2003**, *54*, 261–268.
- 159 Prajapati, V., Tripathi, A.K., Aggarwal, K.K., Khanuja, S.P. Insecticidal, repellent and oviposition-deterrent activity of selected essential oils against *Anopheles stephensi*, *Aedes aegypti* and *Culex quinquefasciatus*. *Bioresour. Technol.* **2005**, *96*, 1749–1757.
- 160 Tripathi, A.K., Prajapati, V., Verma, N., Bahl, J.R., Bansal, R.P., Khanuja, S.P.S. Bioactivities of the leaf essential oil of *Curcuma longa* (var. ch-66) on three species of stored-product beetles (Coleoptera). *J. Econ. Entomol.* **2002**, *95*, 183–189.
- 161 Mahmoud, S.S., Croteau, R.B. Metabolic engineering of essential oil yield and composition in mint by altering expression of deoxyxylulose phosphate reductoisomerase and menthofuran synthase. *Proc. Natl. Acad. Sci. USA* **2001**, *98*, 8915–8920.
- 162 Berteau, C.M., Schalk, M., Karp, F., Maffei, M., Croteau, R. Demonstration that menthofuran synthase of mint (*Mentha*) is a cytochrome P450 monooxygenase: cloning, functional expression, and characterization of the responsible gene. *Arch. Biochem. Biophys.* **2001**, *390*, 279–286.
- 163 Guenther, E. *The Essential Oils*. Robert E. Krieger, Huntington, **1974**.
- 164 Lawrence, B.M. *A study of the monoterpene interrelationships in the genus Mentha with special reference to the origin of pulegone and menthofuran*. PhD thesis, University of Groningen, Groningen, The Netherlands, **1978**.
- 165 Clark, R.J., Menary, R.C. Environmental effects on peppermint (*Mentha piperita* L.). I. Effect of daylength, photon flux density, night temperature and day temperature on the yield and composition of peppermint oil. *Aust. J. Plant Physiol.* **1980**, *7*, 685–692.
- 166 Mahmoud, S.S., Croteau, R.B. Menthofuran regulates essential oil biosynthesis in peppermint by controlling a downstream monoterpene reductase. *Proc. Natl. Acad. Sci. USA* **2003**, *100*, 14481–14486.
- 167 Alonso, W.R., Rajaonarivony, J.I.M., Gershenzon, J., Croteau, R. Purification of 4S-limonene synthase, a monoterpene cyclase from the glandular trichomes of peppermint (*Mentha x piperita*) and spearmint (*M. spicata*). *J. Biol. Chem.* **1992**, *267*, 7582–7587.
- 168 Mahmoud, S.S., Williams, M., Croteau, R. Cosuppression of limonene-3-hydroxylase in peppermint promotes accumulation of limonene in the essential oil. *Phytochemistry* **2004**, *65*, 547–554.
- 169 Speirs, J., Lee, E., Holt, K., Yong-Duk, K., Steele Scott, N., Loveys, B., Schuch, W. Genetic manipulation of alcohol dehydrogenase levels in ripening tomato fruit affects the balance of some flavor aldehydes and alcohols. *Plant Physiol.* **1998**, *117*, 1047–1058.
- 170 Lewinsohn, E., Schalechet, F., Wilkinson, J., Matsui, K., Tadmor, Y., Nam, K.H., Amar, O., Lastochkin, E., Larkov, O., Ravid, U., Hiatt, W., Gepstein, S., Pichersky, E. Enhanced levels of the aroma and flavor compound S-linalool by metabolic engineering of the terpenoid pathway in tomato fruits. *Plant Physiol.* **2001**, *127*, 1256–1265.

## 21

### ***Ginkgo biloba* and Production of Secondary Metabolites**

*Christine Sohier and Didier Courtois*

#### 21.1

##### **Introduction**

Biotechnology can be defined as “... *the application of science and technology to living organisms, as well as parts, products and models thereof, to alter living or non-living materials for the production of knowledge, goods and services*” (Organisation for Economic Co-operation and Development, OECD, updated 2005). Plant biotechnology covers more precisely the tools for identifying/preserving as well as propagating and modifying plant/plant tissue to improve their use (for a recent review, see [1]). In this respect, this chapter reviews the different tools applied to *Ginkgo biloba* L. (Fig. 21.1).



**Fig. 21.1** *Ginkgo biloba* leaves. Note: A color version of this figure is available in the color plate section.



## 21.1.1

**The *Ginkgo biloba* Tree**

To date, the dioecious tree is the only survivor on Earth of the family Ginkgoaceae (Ginkgophyta division), which appeared 170 million years ago during the Jurassic period. Mesozoic ginkgolean megafossils have been recorded [2], and studies have been conducted on the origin/filiations of different *Ginkgo* species [3]. For example, Zheng and Zhou [4] have recently described a new fossilized *Ginkgo* species, morphologically intermediate between the Jurassic *Ginkgo yimaensis* and *Ginkgo biloba*.

As it retains several plesiomorphic reproductive features (multiflagelleted sperm cells, fertilization occurring after a four month-long development period of the male gametophyte inside the pollen chamber of the ovule), *Ginkgo biloba* is not closely related to any other living plant [5] and is considered to be a “living fossil” [6]. *Ginkgo biloba* has received much attention during studies of the molecular evolution of different classes of genes involved in homeosis of the floral system [7]. In the *Ginkgo*, only a few relationships of orthology can be established with other Spermatophyta, showing that duplications probably occurred independently. Nevertheless, the reproductive system represents one of the particular interests for this tree from the scientific community for decades, initiating early *in-vitro* cultures, studying the development of male, female gametophytes and zygotic embryos, (for reviews see [8, 9]). *In-vitro* cultures [10] were initiated as early as 1934 [11], followed for example by those of Tulecke [12], Ball [13, 14], Bulard [15], Rohr [16], and more recently by Laurain and coworkers [17, 18], or Fontanel and coworkers [19].

## 21.1.2

**Terpenes and Flavonoids**

Numerous constituents belonging to four main chemical classes have been identified in *Ginkgo biloba*: ginkgolides, bilobalide and other terpenoids, flavonoids, poly-prenols (mainly in the leaves), and alkyl phenols. Several reviews have been dedicated to this topic [20–24]. Most of the compounds are common to the leaves of higher plants, with the exception of certain biflavones [25, 26] and the unique terpene trilactones [24, 27–29] (Fig. 21.2). Specific analytical tools have been developed for the analysis of leaf extracts [24, 29, 30–32], studying not only the terpene trilactones of *Ginkgo biloba* but also flavonoids [22].

Both, the mode of action and the adverse effects of these compounds have been described elsewhere, and will not be developed in depth here. Phenolic compounds such as ginkgolic acids, ginkgols and bilobols [33–35] lead to allergic reactions [36]. 4-*O*-methylpyridoxine [37], a food poison isolated from the seeds (which are roasted and eaten in some Asian countries), is a substituted analogue of vitamin B<sub>6</sub> and a potent neurotoxin [38,39].

The main interest in *Ginkgo biloba* centers on the standardized extracts of leaves. These contain ginkgolides and bilobalide, flavone glycosides, and proanthocyanidins, all of which are effective in the treatment of peripheral and cerebral arterial disturbances of the blood supply, especially in elderly people [40–45]. Several clinical studies conducted in Europe and the USA have demonstrated the efficacy and

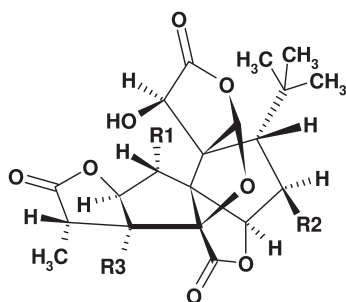


Fig. 21.2 The ginkgolides.

	R1	R2	R3
Ginkgolide A	H	H	OH
Ginkgolide B	OH	H	OH
Ginkgolide C	OH	OH	OH
Ginkgolide J	H	OH	OH

safety of a standardized extract (EGb 761<sup>®</sup>) in age-related mild cognitive impairment, as well as in patients with mild to moderate Alzheimer's disease, whereby symptom progression was delayed by up to six months [46]. Moreover, experimental data realized at the cellular level have shown the extract to inhibit the aggregation and neurotoxicity of beta-amyloid, which is generally considered responsible for Alzheimer's disease [47, 48]. Currently, two multicenter clinical studies are being undertaken in the USA and Europe to confirm the effects of EGb 761 in dementia.

Today, pharmaceutical products from *Ginkgo biloba* are extensively produced in Europe, with extracts from the leaves representing one of the five top-selling herbal supplements in Europe and the USA [49]. Consequently, industrially controlled production of the trees is now carried out, with plantations of the Beaufour-IPSEN and Schwabe groups in France and the USA covering more than 1500 hectares (Fig. 21.3). These plantations are obtained by sowing seed populations, and not



Fig. 21.3 A *Ginkgo biloba* plantation. Note: A color version of this figure is available in the color plate section.

from selected and propagated elite trees. Currently, about 25 million *Ginkgo* trees are pruned and mechanically harvested on an annual basis worldwide [50,51]. Moreover, by complying with conditions of Good Agricultural Practice, the reproducible and controlled production of standardized leaf extracts (EGb 761) is possible [40, 52, 53].

The intense pharmacological interest in the specific secondary metabolites of *Ginkgo biloba* (notably terpenes), the low terpene content (typically <0.1% of the dried leaves of an adult tree), and problems with their chemical synthesis due to the complex structure [29, 54–56], has led to intense studies of the sites of metabolite accumulation, the biosynthetic pathway(s) involved, and their localization in the plant tissue. Subsequently, this knowledge can be applied to the development of biotechnological tools for the selection, multiplication, modification and cultivation of plants not only for production in the field but also for improved *in-vitro* cell and tissue cultures. These points will be outlined and discussed in the following sections.

## 21.2

### Biosynthesis and Accumulation of Ginkgolides and Bilobalide

#### 21.2.1

##### Terpene Content and Localization of Biosynthesis

Following elucidation of the structure of ginkgolides [29, 54, 57–61], the presence of terpenes has been demonstrated in a variety of different plant parts. Highly heterogeneous, or even contradictory, data have been reported on qualitative and quantitative terpene content, with values ranging from nanograms to milligrams  $\text{g}^{-1}$  dry matter of plant material [62–67]. This range of concentrations is due not only to different plant materials being examined, but also to the different analytical techniques used. As indicated by several authors [24, 28, 30, 32], the *Ginkgo* terpene trilactones are much more difficult to analyze than flavonol glycosides, due mainly to their low concentrations and separation problems. Clearly, studies of these compounds require careful investigation of the correct analytical methods in order for qualitative and quantitative data to be validated.

Among different parameters, it was suggested that light might influence terpene accumulation. Flesh and coworkers [68] described seasonal variations in ginkgolide and bilobalide contents in plants cultivated in a greenhouse (natural light), that were not observed in plants grown in a climate chamber under conditions of controlled light and temperature. Inoue and coworkers [64] showed that terpene biosynthesis could occur in the darkness, with dark-grown plants showing etiolation but containing ginkgolides in similar quantities to those grown in the light with green leaves. Teng [21] and van Beek and coworkers [62] showed that maximal terpene levels occurred in the leaves at the end of summer/early autumn. Such investigations are valuable from both academic and industrial viewpoints, in order to harvest leaves at the correct time to produce standardized *Ginkgo biloba* leaf extracts.

Hue and Staba [63] suggested that ginkgolides were biosynthesized independently in the leaves and roots, but others [65] were unable to elucidate the precise biosynthetic pathway of terpenes in *Ginkgo biloba*. The latter group identified the presence of farnesyl pyrophosphate synthase and geranylgeranyl pyrophosphate synthase in roots, leaves and barks of young seedlings under controlled culture conditions, and found biosynthesis to occur mainly in actively growing tissues and aerial parts of the plant.

Other parameters thought to affect the diversities in ginkgolide and bilobalide contents of tree include gender, soil, stage of development, age, and natural variability due to the allogamous status of the plant species. Balz et al. [66] showed that the tree's age was a major determinant of terpene content, albeit in four different ways:

- Leaves from 30-year-old trees contained much smaller amounts of ginkgolides and bilobalide than 3-year-old cuttings of the corresponding trees (total terpene contents 0.04–0.54 mg g<sup>-1</sup> and 0.89–7.30 mg g<sup>-1</sup> dry weight (d.w.), respectively).
- The terpene content decreased with aging (Fig. 21.4), from an average 3.5 mg g<sup>-1</sup> d.w. in seedlings aged ≤2 years to <2 mg g<sup>-1</sup> dry weight after three years.
- If trees are pruned each year post harvest [51], after 10 years the average terpene content of leaves was much higher than for non-pruned trees (>5 mg g<sup>-1</sup> versus <2 mg g<sup>-1</sup> d.w.) (Fig. 21.5).
- Cuttings from old trees (aged >30 years), and also the progeny of pairs of old trees, led to young trees with a high terpene content (Fig. 21.6).

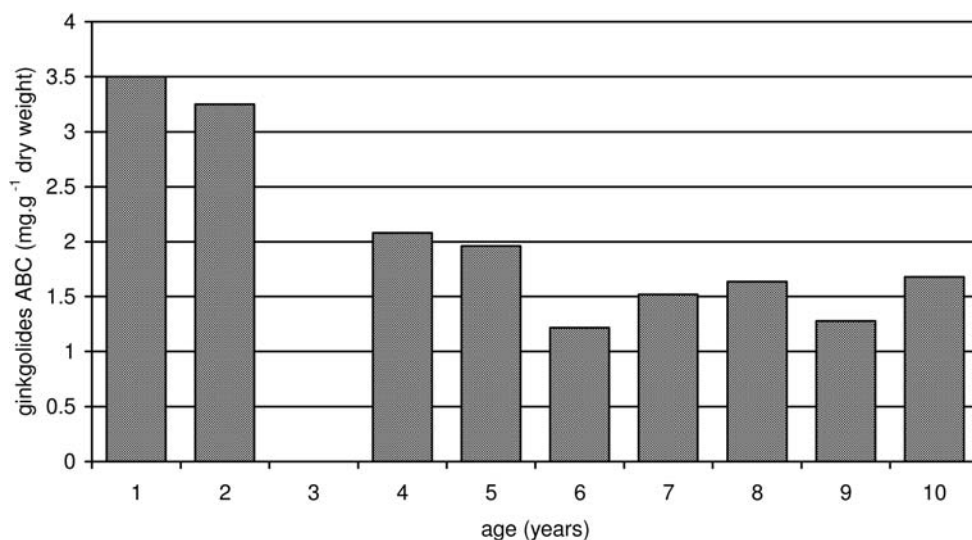


Fig. 21.4 Average concentration of ginkgolides A, B, C as a function of the age of 2000 commercially exploited trees.

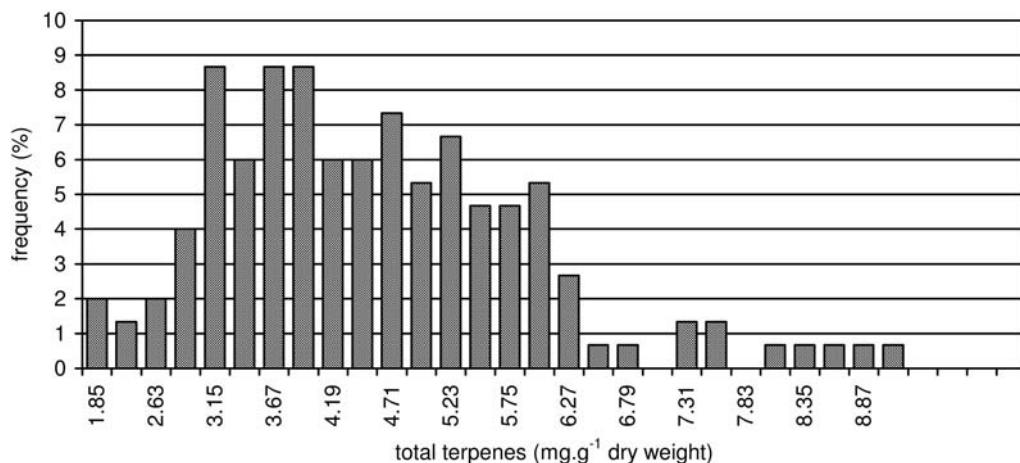


Fig. 21.5 Distribution of total terpenes among a population of 150 ten-year-old trees.

One hypothesis explaining these observations is that, during aging, the ratio between the volume of sites of accumulation (leaves and roots) and the volume of the compartment where biosynthesis occurs (suspected mainly roots, see below) changes. This might lead to a decrease in the terpene content of the leaves, simply because the root system of old trees is less important and/or less active than the aerial part [66]. The clear consequence is that young trees or pruned trees have leaves containing a higher terpene content than old adult trees.

Studies in which seedlings were labeled with  $^{14}\text{C}$  showed dehydroabietane to be a biosynthetic precursor of terpene trilactones [69, 70]. Using (U- $^{14}\text{C}$ )glucose, Cartayrade et al. [69] showed that at least one mechanism of biosynthesis occurred in the roots, with translocation of terpenes from the roots to the leaves, where they accumulated. Experiments with *in-vitro* initiation of roots from leaf fragments also supported these finding [66, 71]. Nevertheless, Carrier et al. [65] showed that cell-free extracts from leaves displayed terpenoid biosynthesis, and therefore that biosynthetic ability was not restricted to a specific tissue. These apparently contradictory results might, however, suggest the existence of two different pathways for isoprenoid biosynthesis.

### 21.2.2

#### Biosynthetic Pathway

Until recently, the terpenoid origin of ginkgolides was considered to involve two precursors – isopentenyl pyrophosphate (IPP) and dimethylallyl pyrophosphate (DMAPP) – via the so-called mevalonate pathway described by Nakanishi et al. [59]. In 1993, Rohmer et al. identified an alternative mevalonate-independent methylerythritol phosphate (MEP) pathway (also named deoxyxylulose phosphate pathway) for isoprenoid biosynthesis. This non-mevalonate pathway is present in many

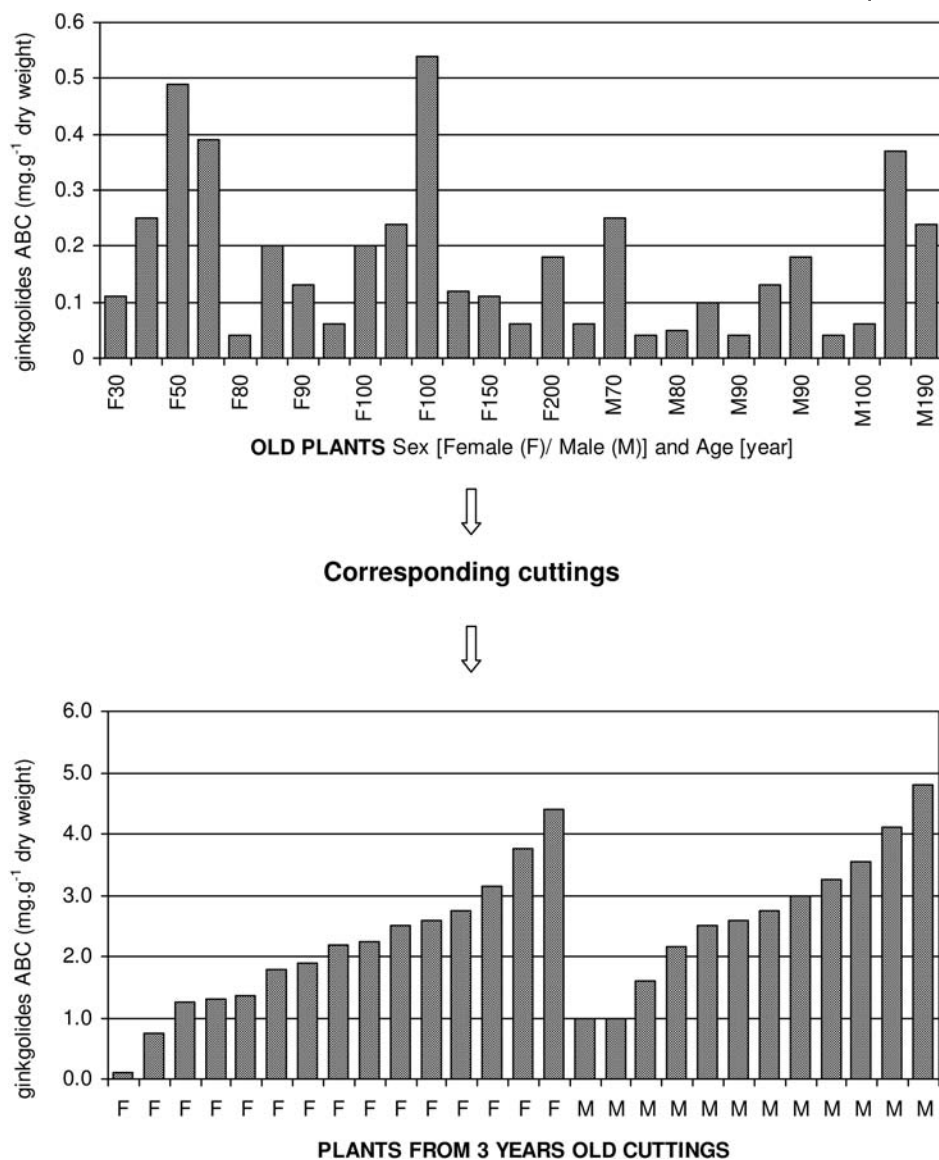


Fig. 21.6 Correlation between the age, gender and ginkgolide content of old trees: 15 female (F) and 12 male (M) trees (upper diagram) and those of young corresponding cuttings (lower diagram).

bacteria and in the chloroplasts of all phototrophic organisms [72, 73]. The condensation of pyruvate and glyceraldehyde 3-phosphate results in 2C-methyl-D-erythritol 2,4-cyclodiphosphate by the sequential action of enzyme activities. This precursor is transformed into DMAPP and IPP simultaneously. Independently, Arigoni

and Schwarz showed that ginkgolides were biosynthesized mainly through this new non-mevalonate pathway [74–77].

More recently, this knowledge of metabolic pathways has led to studies on the cloning of genes linked to the biosynthetic pathways, a useful tool for further improvement of the biosynthesis and accumulation of terpene trilactones. For example, a cDNA encoding *Ginkgo biloba* levopimaradiene synthase has been isolated [78]. More recently, a cDNA encoding farnesyl diphosphate synthase has been cloned [79]. Cloning of the full-length cDNA encoding geranylgeranyl diphosphate synthase has been described [80], as has that of 1-deoxy-D-xylulose 5-phosphate reductoisomerase [81], the second enzyme of the non-mevalonate pathway catalyzing a stage of the MEP pathway for ginkgolide biosynthesis.

The studies of Tang et al. [82], on the cloning of a chlorophyllase cDNA, showed that the enzyme is responsible for the homeostasis of chlorophylls, but not for the autumnal coloration. An interesting point would be to examine the relationship between the expression of this and related enzymes and the accumulation of terpenes.

### 21.3

#### Biosynthesis of Flavonoids

The flavonoids represent the most common group of polyphenolic plant secondary metabolites, as they play essential roles in plant growth, development, and defense. The flavonoids also constitute the other main chemical class of compounds of interest present in leaf extracts of *Ginkgo biloba*, contributing for example to free radical-scavenging activity. Investigations into the flavonoids have led to development of a variety of powerful analytical tools [22, 24, 44].

#### 21.3.1

##### Variations in Flavonoid Content

Seasonal variations of flavonoids have been studied during a complete annual vegetative cycle [22, 83] from the early bud stage (March) to the fallen leaves in November. No significant differences in the concentration were found in the evolution. As with terpenes, many studies of flavonoids have focused on these fluctuations with regard to the standardization of commercial extracts of the *Ginkgo* leaves.

#### 21.3.2

##### Flavonoid Metabolic Pathway

In contrast to terpene trilactones, the biosynthetic pathway of the flavonoids has largely been described (for a recent review, see [84]). Several studies have shown chalcone synthase (*chs*) to be a key enzyme in flavonoid biosynthesis. The *chs* genes are expressed in pigmented flowers constitutively, but are also induced by external stresses. These genes have been largely characterized in the plant king-



dom, and are structurally conserved. In fact, they represent an excellent model system for evolutionary studies, with the full-length cDNA of the *chs* gene from *Ginkgo biloba* and its closer relationship with Gymnosperms than with Angiosperms having been described only recently [85]. Cloning, analysis of genomic sequence and expression profiles in different tissues have been described [86], all of which are important for further bioengineering of the flavonoids biosynthetic pathway in *Ginkgo biloba* [84].

## 21.4

### Selection of Plants for Terpene Content and Propagation

Although the plant selection and propagation reported here is aimed at the terpene trilactones (which have been studied in greater depth than the flavonoids), this general strategy could clearly be applied to the selection and propagation of elite trees with regard to flavonoids content.

#### 21.4.1

##### Selection

Besides pure agronomic traits (yield, resistance to pests and diseases), breeders and industrial users are interested in a good reproducibility of the concentrations of active compounds and standardized extracts. This can be achieved at the extraction level [53]. Nevertheless, selection of the correct genotype at an early stage, followed by their clonal propagation, is particularly important in terms of cost saving during the process leading to the end product [87]. In this context, the discovery of some wild populations of *Ginkgo* trees has been of major interest, notably when examining their genetic variability compared to that of cultivated trees. Unfortunately, the selection of high terpene yield-producing trees has met with a variety of difficulties in the case of *Ginkgo biloba*.

Due to its reproductive system, and *Ginkgo* being a dioecious species, each seed of a progeny differs genetically from any other, and clearly no degree of autogamy is possible. Thus, selection is difficult through conventional breeding with backcrosses due to the long duration of tree development (at least 25 years for seed-to-seed cycle). This is in addition to the strategy of haplomeiosis (regeneration of whole plants from haploid gametic cells in order to save time for producing true F<sub>1</sub> hybrid seeds), except perhaps when randomly increasing the variability of the metabolite content [18, 19, 88].

Therefore, the strategy would be to develop studies using natural variability, selecting high-producing trees and propagating selected trees (by cuttings, *in vitro* microcuttings, somatic embryogenesis). Unfortunately, very few studies have used large collections of seedlings, plantlets or adult trees grown at the same location such that the natural diversity can be evaluated statistically and distinction made between genetic and physiological parameters in terms of secondary metabolite content. The ideal experimental design would then be to develop cuttings from dif-



ferent plants in a multilocation trial. Moreover, the development of new biotechnological tools such as metabolomic studies would allow a new approach to the study of variability of the selected trees [89].

Balz and coworkers [66] studied a population of 150 ten-year-old trees, cultivated at the same location. These contained relatively large quantities of total terpenes (1.85–8.87 mg g<sup>-1</sup> d.w. compared to <1 mg g<sup>-1</sup> in a typical old tree). The variation (based on the average  $\pm$  2SD) was only 5.7-fold, 2.19-fold, 1.92-fold, 0.5-fold, 8.28-fold, and 2.16-fold for ginkgolide A, B, C, J, bilobalide and total terpenes, respectively, with an identical variation between the different terpenes in each tree. This means that, ultimately, a very narrow diversity was observed, which was relatively unexpected considering that a wild dioecious species would most likely be highly heterozygous. Nevertheless, this small variation might correlate to the fact that *Ginkgo biloba* is no longer a wild species (except perhaps in some parts of China); rather, it is often regarded as a “surviving tree”, due mainly to its being considered sacred over thousands of years. However, this preservation has also reduced its genetic diversity.

#### 21.4.2

##### **Techniques of Micropropagation**

Today, the use of medicinal plants in general is increasing dramatically [87], and the development of efficient tools for clonal propagation may help to optimize and control more effectively the production of any given plant species. Micropropagation by cuttings and microcuttings – which normally is used to multiply selected plants – has been investigated with *Ginkgo biloba* [71, 90, 91]. However, despite success on a small scale, the propagation rate to date has remained low and not sufficiently economical for application at the field level [52, 71]. Camper et al. [90] have regenerated shoots from embryo and cotyledon explants, while Choi et al. [91] obtained shoots from immature zygotic embryos, without plantlet development. By using apical and nodal buds as a starting material, Tommasi and Scaramuzzi [92] obtained shoot formation (sometimes multiple). For rooting, it is necessary to enrich the medium with endosperm extract, but in all these cases it was possible to induce organogenesis on the different explants and, in some cases, to achieve complete plantlet development. However, these studies are still at an experimental stage, and further investigations are required for development on a large scale.

#### 21.4.3

##### **Somatic Embryogenesis**

An efficient technique for large-scale micropropagation would be the production of somatic embryogenesis, as described for several plant species, especially trees [93–95]. Concerning *Ginkgo biloba*, proembryos have been described, coming from microspores [17], haploid protoplasts [18], or immature zygotic embryos [96]. Fontanel and co-workers [19] succeeded in inducing embryogenesis from megagametophyte up to heart-shaped stage.

As far as we now, no plantlet has been regenerated nor transferred in field through this technique and consequently any attempt to propagate selected trees has failed.

## 20.5

### Tissue cultures

Plant tissue cultures have been shown to have potential as a supplement to agriculture for the production of specific compounds such as secondary metabolites [97, 98] or recombinant proteins [99]. In this respect, *Ginkgo biloba* has for many years been utilized for studies on biochemical pathways and plant morphogenesis. The *Ginkgo biloba* tree is particularly interesting in this respect as tissue cultures from its pollen were initiated as long ago as 1953 [10, 12]. Shortly thereafter, in 1959, Tulecke and Nickell [100] described one of the first examples of large-scale culture of plant cells.

#### 21.5.1

##### Terpene Biosynthesis and Accumulation

During the past 15 years, many investigations have been made into the production of terpenes by *in-vitro* plant cell cultures, the aim being to produce a higher terpene content, as well as a better control and reproducibility compared to the plant in the field. Cell strains with acceptable growth yield (e.g., ca. 350 g L<sup>-1</sup> fresh weight of nutritive liquid culture medium; 11 g L<sup>-1</sup> d.w. within three weeks of culture) can easily be obtained with culture media currently used in plant cell cultures, combined with different balances of growth hormones [18, 66, 101–105]. As with field plants, the terpene contents reported in different plant cell cultures have varied widely, from nanograms to milligrams per gram dry weight. Balz et al. [66] showed dramatic decreases in terpene content to occur from the third subculture (total terpenes 1650 ng g<sup>-1</sup> d.w.) of a newly created cell strain up to the seventh subculture (total terpenes 200 ng g<sup>-1</sup> d.w. after one year subcultivation). It is frequently observed that when new plant cell cultures are initiated for secondary metabolite production, they remain rather unstable during the first subcultures; hence, 80 different cell strains of four-year-old *Ginkgo biloba* callus cultures were analyzed. The total ginkgolide contents (A, B, C, and J) ranged from less than 30 ng to 1.8 µg g<sup>-1</sup> d.w., but no bilobalide was detected in any of these cell strains. In most reports, the ginkgolide content was close to these values, or slightly higher [63, 102, 104, 106–108]. Laurain et al. [103] reported total terpene contents (including bilobalide) of up to 0.87 mg g<sup>-1</sup> d.w. in young tissue cultures supposedly transformed by *Agrobacterium rhizogenes*. Agarwal et al. [110] selected cell strains producing bilobalide as the sole terpene trilactone at approximately 1 mg g<sup>-1</sup> d.w., arguing that the ginkgolides might have degraded into bilobalide. Dai and colleagues [111], by performing single-cell cloning, reported the presence of ginkgolide B at 1 mg g<sup>-1</sup> d.w., with good reproducibility during subcultures, while Zheng et al. [109] described a bio-

logical method (in addition to the HPLC method) for the detection of ginkgolide B in root callus cultures.

Park et al. [67] referred to cell cultures containing 600–786  $\mu\text{g g}^{-1}$  d.w. ginkgolide A, and 10–35  $\mu\text{g g}^{-1}$  d.w. ginkgolide B. Total yields of ginkgolides A, B and bilobalide with a content greater than 10  $\text{mg g}^{-1}$  d.w. were later reported by the same group [105], who were dedicated to optimizing production by cell cultures. Although this was the highest content reported to date, no data were provided on the reproducibility and stability of the selected cell strains.

Regardless of the terpene contents of plants, cells or tissue cultures, the analytical procedures used must be validated (especially when monitoring low concentrations). As has been noted previously [24, 28, 32], reports from both industry and academia are often lacking in adequate validation. For example, some authors used HPLC with UV detection at 220 nm for the quantitative analysis of ginkgolides and bilobalide. However, this method of detection is used increasingly less often as the compounds of interest have very low  $\epsilon$ -values at a non-selective wavelength of 219 nm [24]. Moreover, even with contents in the range of milligrams per gram d.w., results obtained to date have not encouraged the economic production of ginkgolides and bilobalide.

The low content of metabolites in undifferentiated cell cultures may reflect the need for differentiated structures for their biosynthesis and/or accumulation, as was discussed for the production of secondary metabolites by tissue cultures in general. Investigations of the secretory apparatus of *Ginkgo biloba* have also been made, but these were dedicated to secretory cavities containing phenol lipids, and not terpenes [112].

One often-cited means of improving secondary metabolite biosynthesis in plant cell cultures is to use biotic or abiotic compounds acting as elicitors, as well as feeding with precursors (for reviews, see [97, 98, 113]). Very few studies have been dedicated to this aspect for *Ginkgo biloba* cells. The addition of chito-oligosaccharides to a callus culture of *G. biloba* led to a 3.5-fold increase in ginkgolides A and B, and when geranylgeraniol was added the yield of ginkgolides A and B was increased 5.9-fold [108].

Further studies combining the use of these cell cultures with knowledge of the two biosynthetic pathways, emerging knowledge on the genes encoded for the key enzymes and, more globally, on the engineering of secondary metabolism might lead to improvements in the production of the *G. biloba* terpenes by plant cell culture. Nevertheless, plant cell cultures of *G. biloba* represent an attractive tool for physiological and biochemical studies involved in the large-scale industrial production of secondary metabolites.

### 21.5.2

#### Flavonoids Biosynthesis and Accumulation

Few attempts have been made to biosynthesize flavonoids, mainly because – in contrast to terpene trilactones – most are not exclusive to *Ginkgo biloba*. When proanthocyanidins were produced by tissue cultures of *Ginkgo biloba*, the content (flavan-3-ols and dimers) was found to be much higher in cell cultures than in corre-

sponding plant leaves [114]. Byun et al. [115] reported the production of flavonol glycosides (kaempferol, quercetin and isorhamnetin) by callus cultures, but in a lower yield than in plant leaves ( $100 \text{ mg g}^{-1}$ ). More recently, Kim et al. [116] studied the relationship between the production of flavonol glycosides and phenylalanine ammonia-lyase activity in cell suspensions and the synergistic effects of various external factors. Fluorescent light and UV radiation were found to increase enzyme activity and quercetin and kaempferol production. The addition of precursors, in combination with UV radiation, led to quercetin concentrations up to  $0.25 \text{ mg L}^{-1}$ , but the use of elicitors (e.g., fungus and heavy metals) led to a doubling of this concentration [117].

The collection of cell strains analyzed previously for terpene production by Balz et al. [66] was also examined for flavonoids biosynthesis (J.P. Balz et al., unpublished results). HPLC analysis resulted in the detection of mono- or polyhydroxylated flavones and flavonols, while the presence of aglycones (e.g., quercetin, kaempferol) following acid hydrolysis proved the existence of combined compounds in the cell strains. The contents ranged between 10 and  $700 \mu\text{g g}^{-1}$  d.w., depending upon the cell strain. These constituents were also detected in the culture medium.

#### 21.5.3

##### **4'-O-Methylpyridoxine (Ginkgotoxin) Biosynthesis and Accumulation**

Fiehe et al. [118] studied the biosynthesis of 4'-O-methylpyridoxine using cell cultures of *Ginkgo biloba*. The pyridoxine ring system of ginkgotoxin was shown to be synthesized *de novo* by the cultured cells, with ginkgotoxin most likely derived from 4'-O-methylation of pyridoxine. These authors concluded that *G. biloba* cell suspension culture might be a suitable system for studying vitamin B<sub>6</sub> and/or ginkgotoxin biosynthesis.

#### 21.5.4

##### **Biotransformation**

A number of biotransformation processes have been developed using *G. biloba*, the aim being to increase the production of any given compound, or the biosynthesis of new derivatives with biological activity. The selective  $9\alpha$ -oxidation by cell suspension cultures of *Ginkgo biloba* of taxuyunnanin C, a useful intermediate for the semi-synthesis of bioactive taxoids from *Taxus* sp., has been described [119]. Previously, this group reported the biotransformation of taxadiene derivatives by cell cultures of *Ginkgo biloba* [120, 121], as well the biotransformation of artemisinin [122] and santonin [123].

#### 21.5.5

##### **Cryopreservation of Plant Cell Materials**

Today, when working with plant cell cultures, the normal approach to preserving living material for the re-supply of active substances remains regular subculture,

but this has attendant increased risks of contamination, loss of biosynthetic capabilities, and/or mutagenesis. However, cryopreservation in liquid nitrogen [124] guarantees the safety and stability of the cell strain, and maintains the growth and biosynthetic capabilities. In the present authors' laboratory, success was achieved with different types of plant materials [125–127], and preliminary experiments were performed also with *Ginkgo* cells (C. Sohier and D. Courtois, unpublished results). *G. biloba* cell strains re-cultivated after preservation in liquid nitrogen exhibited the same growth rate as non-cryopreserved cells, indicating that cryopreservation had no adverse effect on cell viability.

## 21.6

### Genetic Transformation and Organ Cultures

Genetically modifying the plant or plant cells represents one means of improving the production of desired compounds in plant or tissue cultures [128, 129]. Several reports have been made describing the genetic transformation of *Ginkgo biloba* either by *Agrobacterium tumefaciens* [130] or *A. rhizogenes* [66, 103, 131–134]. Hairy roots were obtained using different bacterial strains such as 15834 and R1000 [131] or A4 [103, 133]. Thus, whilst the ability to genetically modify *Ginkgo biloba* has been demonstrated, there is at present no regeneration procedure available, neither has any transformed whole plant been developed. Nonetheless, the possibility that terpene trilactones might be synthesized in the roots has raised interest in the continuous cultivation of roots via the genetic engineering of hairy-root cultures using *A. rhizogenes*. As yet, however, no data have been reported on either large-scale hairy-root culture, nor reproducible data on their terpene trilactone or flavonoid contents.

## 21.7

### Conclusions

The *Ginkgo biloba* tree, after one thousand years of preservation by humans [5], continues to be used intensively for the pharmaceutical, cosmetic or dietary supplement industries on the basis of its content of a wide variety of secondary metabolites. In order to meet demands for standardized, controlled production of the required metabolites – particularly the unique terpene trilactones and extracts combining these lactones with flavone glycosides [52] – the main strategy is to harvest the trees' leaves, and at present this is the sole industrial source. Hence, many hundreds of hectares of *Ginkgo biloba* trees are cultivated in France, USA and China, and these are pruned annually following the harvest [50, 51].

At present, large-scale *in-vitro* cell cultures of *Ginkgo biloba* are unlikely to be an economically realistic technique of production, unless a major breakthrough is made in terms of productivity. Nevertheless, these cultures are vital for studies on

the biosynthetic pathways, biotransformation processes and possible use of hairy-root cultures.

The selection and propagation of elite trees is likely to be the best strategy to follow, taking into account recent knowledge on the biosynthetic pathways, somatic embryogenesis, and possible genetic transformation. It would also be interesting to investigate techniques that generate increased genetic diversity of the metabolite content (e.g., mutagenesis, induced *in-vitro* somaclonal variation, genetic engineering). Emerging knowledge on the genes encoding for key enzymes, on transcription factors which control plant secondary metabolism [135, 136], and on the consequent possibility of engineering of plant secondary metabolism [84, 128], might lead to improvements in the production of *Ginkgo biloba* terpenes either by cultivation of the plant in the field, or by using an *in-vitro* approach. Whichever route is taken, new developments are required in terms of the regeneration and propagation techniques associated with tissue cultures, such as micropropagation or somatic embryogenesis.

## References

- Christou, P., Klee, H. (Eds.), *Handbook of Plant Biotechnology* (2-Volume set). John Wiley & Sons, Chichester, 2004.
- Zhou, Z. Mesozoic ginkgoalean megafossils: A systematic review. In: Hori, T., Ridge, R.W., Tulecke, W., Del Tredici, P., Tremouillaux-Guiller, J., Tobe, H. (Eds.), *Ginkgo biloba – A Global Treasure From Biology to Medicine*. Springer, Tokyo, 1997, pp. 183–206.
- Zhou, Z., Zheng, S. The missing link in Ginkgo evolution. *Nature* 2003, 423 (6942), 821–822.
- Zheng, S. and Zhou, Z. A new mesozoic *Ginkgo* from western Liaoning, China and its evolutionary significance. *Rev. Palaeobot. Palynol.* 2004, 135 (1–2), 91–103.
- Del Tredici, P. The evolution, ecology and cultivation of *Ginkgo biloba*. In: van Beek, T.A. (Ed.), *Medicinal and Aromatic Plants – Industrial Profiles, Volume 12, Ginkgo biloba*. Harwood Academic Publishers, Amsterdam, 2000, pp. 7–24.
- Darwin, C. *The origin of species*. Royal Society, London, 1859.
- Jager, M., Hassanin A., Manuel M., Le Guyader, H., Deutsch, J. Mads-Box genes in *Ginkgo biloba* and the evolution of the AGAMOUS Family. *Mol. Biol. Evol.* 2003, 20 (5), 842–854.
- Friedman, W.E., Gifford, E.M. Development of the male gametophyte of *Ginkgo biloba*: A window into the reproductive biology of early seed plants. In: Hori, T., Ridge, R.W., Tulecke, W., Del Tredici, P., Tremouillaux-Guiller, J., Tobe, H. (Eds.), *Ginkgo biloba – A Global Treasure From Biology to Medicine*. Springer, Tokyo, 1997, pp. 29–50.
- Soma, S., Development of the female gametophyte and the embryogeny of *Ginkgo biloba*. In: Hori, T., Ridge, R.W., Tulecke, W., Del Tredici, P., Tremouillaux-Guiller, J., Tobe, H. (Eds.), *Ginkgo biloba – A Global Treasure From Biology to Medicine*. Springer, Tokyo, 1997, pp. 51–66.
- Tulecke, W. Tissue culture on *Ginkgo biloba*. In: Hori, T., Ridge, R.W., Tulecke, W., Del Tredici, P., Tremouillaux-Guiller, J., Tobe, H. (Eds.), *Ginkgo biloba – A Global Treasure From Biology to Medicine*. Springer, Tokyo, 1997, pp. 141–158.
- Li, T.T. The development of *Ginkgo biloba* *in vitro*. *Sci. Rep. Natl. Tsinghua Univ. Ser. B*, 1934, 2, 41–52.
- Tulecke, W. A tissue from the pollen of *Ginkgo biloba*. *Science* 1953, 117, 599–600.

- 13 Ball, E. Growth of the embryo of *Ginkgo biloba* under experimental conditions. I. Origin of the first root of the seedling *in vitro*. *Am. J. Bot.* **1956**, *43*, 488–495.
- 14 Ball, E. Growth of the embryo of *Ginkgo biloba* under experimental conditions. II. Effects of a longitudinal split in the tip of the hypocotyls. *Am. J. Bot.* **1956**, *43*, 802–810.
- 15 Bulard, C. Culture aseptique d'embryons de *Ginkgo biloba* L. Role des cotyledons dans l'absorption du sucre et la croissance de la tige. *C. R. Acad. Sci.* **1967**, *235*, 739–741.
- 16 Rohr, R. Maidenhair tree (*Ginkgo biloba* L.). In: Bajaj, Y.P.S. (Ed.), *Biotechnology in agriculture and forestry, Volume 5, Tree II*. Springer, Berlin, **1989**, pp. 574–590.
- 17 Laurain, D., Tremouillaux-Guiller, J., Chénieux, J.C. Embryogenesis from microspores of *Ginkgo biloba* L., a medicinal woody species. *Plant Cell Rep.* **1993**, *12*, 501–505.
- 18 Laurain, D., Chénieux, J.C., Tremouillaux-Guiller, J. Direct embryogenesis from female haploid protoplasts of *Ginkgo biloba* L., a medicinal woody species. *Plant Cell Rep.* **1993**, *12*, 656–660.
- 19 Fontanel, A., Serraf, I., Pétiard, V. Regeneration in *Ginkgo biloba* L.: Induction of embryogenesis from megagametophyte according to the development stage. *C. R. Acad. Sci. Paris* **1994**, *317*, 149–155.
- 20 Huh, H., Staba, E.J. The Botany and Chemistry of *Ginkgo biloba* L. *J. Herbs, Spices Med. Plants*, **1992**, *1* (1/2), 91–123.
- 21 Teng, B.P. Chemistry of ginkgolides. In: Braquet, P. (Ed.), *Ginkgolides – Chemistry, Biology, Pharmacology and Clinical Perspectives*. J.R. Prous Science Publishers, Barcelona, **1998**, pp. 37–42.
- 22 Sticher, O., Meier, B., Hasler, A. The analysis of *Ginkgo* flavonoids. In: van Beek, T.A. (Ed.), *Medicinal and Aromatic Plants – Industrial Profiles, Volume 12, Ginkgo biloba*. Harwood Academic Publishers, Amsterdam, **2000**, pp. 179–202.
- 23 Hasler, A. Chemical constituents of *Ginkgo biloba*. In: van Beek, T.A. (Ed.), *Medicinal and Aromatic Plants – Industrial Profiles, Volume 12, Ginkgo biloba*. Harwood Academic Publishers, Amsterdam, **2000**, pp. 109–142.
- 24 van Beek, T.A. Chemical analysis of *Ginkgo biloba* leaves and extracts. *J. Chromatogr. A* **2002**, *967*, 21–55.
- 25 Yoshitama, K. Flavonoids of *Ginkgo biloba*. In: Hori, T., Ridge, R.W., Tulecke, W., Del Tredici, P., Tremouillaux-Guiller, J., Tobe, H. (Eds.), *Ginkgo biloba – A Global Treasure From Biology to Medicine*. Springer, Tokyo, **1997**, pp. 287–300.
- 26 Hyun, S.K., Kang, S.S., Son, K.H., Chung, H.Y., Choi J.S. Biflavone glucosides from *Ginkgo biloba* yellow leaves. *Chem. Pharm. Bull. (Tokyo)* **2005**, *53*(9), 1200–1201.
- 27 Boralle, N., Braquet, P., Gottlieb, O.R. *Ginkgo biloba*: A review of its chemical composition. In: Braquet, P. (Ed.), *Ginkgolides–Chemistry, Biology, Pharmacology and Clinical Perspectives*. J.R. Prous Science Publishers, Barcelona, **1998**, pp. 9–25.
- 28 van Beek, T.A. Chemical analysis of *Ginkgo* terpene trilactones. In: van Beek, T.A. (Ed.), *Medicinal and Aromatic Plants – Industrial Profiles, Volume 12, Ginkgo biloba*. Harwood Academic Publishers, Amsterdam, **2000**, pp. 151–178.
- 29 Stromgaard, K., Nakanishi, K. Chemistry and biology of terpene trilactones from *Ginkgo biloba*. *Angew. Chem. Int. Ed.* **2004**, *43*, 1640–1658.
- 30 Jaracz, S., Malik, S., Nakanishi, K., Isolation of ginkgolides A, B, C, J, and bilobalide from *G. biloba* extracts. *Phytochemistry* **2004**, *65*, 2897–2902.
- 31 van Beek, T.A., Bombardelli, E., Morazzoni, P., Peterlongo, F. *Ginkgo biloba* L. *Fitoterapia* **1998**, *69* (3), 195–248.
- 32 van Beek, T.A. Ginkgolides and bilobalide: their physical, chromatographic and spectroscopic properties. *Bioorg Med Chem.* **2005**, *13*(17), 5001–5012.
- 33 Verotta, L., Morazzoni, P., Peterlongo, F. Occurrence and analysis of alkyl phenols in *Ginkgo biloba*. In: van Beek, T.A. (Ed.), *Medicinal and Aromatic Plants – Industrial Profiles, Volume 12, Ginkgo biloba*. Harwood Academic Publishers, Amsterdam, **2000**, pp. 203–214.



- 34 de Combarieux, E., Fuzzati, N., Mercalli, E., Zini, G. Isolation of ginkgolic acids from *Ginkgo biloba* leaves by centrifugal partition chromatography. In: 53rd Annual Congress of Society for Medicinal Plant Research (GA), Florence, 21–25 August, 2005, p. 518.
- 35 Choi, Y.H., Choi, H.K., Peltenburg-Looman, A.M.G., Lefeber, A.W., Veerporte, R. Quantitative analysis of ginkgolic acids from *Ginkgo* leaves and products using <sup>1</sup>H-NMR. *Phytochem. Anal.* 2004, 15 (4), 325–330.
- 36 Kochibe, N. Allergic substances of *Ginkgo biloba*. In: Hori, T., Ridge, R.W., Tulecke, W., Del Tredici, P., Tremouillaux-Guiller, J., Tobe, H. (Eds.), *Ginkgo biloba – A Global Treasure From Biology to Medicine*. Springer, Tokyo, 1997, pp. 301–308.
- 37 Wada, K., Ishigaki, S., Ueda, K., Sakata, M., Haga, M. An antivitamin B<sub>6</sub>, 4'-O-methylpyridoxine from the seed of *Ginkgo biloba* L. *Chem. Pharm. Bull.* 1985, 33, 3555–3557.
- 38 Wada, K. Food poisoning by *Ginkgo* seeds. In: van Beek, T.A. (Ed.), *Medicinal and Aromatic Plants – Industrial Profiles, Volume 12, Ginkgo biloba*. Harwood Academic Publishers, Amsterdam, 2000, pp. 453–466.
- 39 Wada, K., Haga, M. Food poisoning by *Ginkgo biloba* seeds. In: Hori, T., Ridge, R.W., Tulecke, W., Del Tredici, P., Tremouillaux-Guiller, J., Tobe, H. (Eds.), *Ginkgo biloba – A Global Treasure From Biology to Medicine*. Springer, Tokyo, 1997, pp. 309–322.
- 40 Clostre, F. Extrait de *Ginkgo biloba* (EGb 761): Etat des connaissances à l'aube de l'an 2000. *Ann. Pharm. Fr.* 1999, 57 (1), 1–88.
- 41 DeFeudis, F.V., Drieu, K. *In vitro* studies of the pharmacological and biochemical activities of *Ginkgo biloba* Extract (EGb 761) and its constituents. In: van Beek, T.A. (Ed.), *Medicinal and Aromatic Plants – Industrial Profiles, Volume 12, Ginkgo biloba*. Harwood Academic Publishers, Amsterdam, 2000, pp. 279–302.
- 42 Drieu, K., DeFeudis, F.V. *In vivo* studies of the pharmacological and biochemical activities of *Ginkgo biloba* Extract (EGb 761) and its constituents. In: van Beek, T.A. (Ed.), *Medicinal and Aromatic Plants – Industrial Profiles, Volume 12, Ginkgo biloba*. Harwood Academic Publishers, Amsterdam, 2000, pp. 303–330.
- 43 Birks, J., Evans, G.J. *Ginkgo Biloba* for cognitive impairment and dementia. *The Cochrane database of systematic reviews*, Issue 4. John Wiley & Sons, 2002.
- 44 Upton, R. Herbalist (Ed.), *Ginkgo leaf, Ginkgo leaf dry extract – Standards of analysis, quality control and therapeutics*. American Herbal Pharmacopoeia Monograph, Scotts Valley, 2003.
- 45 Lee, H., Birks, J. *Ginkgo biloba* for cognitive improvement in healthy individuals (Protocol). *The Cochrane database of systematic reviews*. Issue 1. John Wiley & Sons, 2004.
- 46 Le Bars, P.L. Magnitude of effect and special approach to *Ginkgo biloba* extract EGb 761<sup>®</sup> in cognitive disorders. *Pharmacopsychiatry* 2003, 36 (suppl 1), S44–S49.
- 47 Bastianetto, S., Ramassamy, C., Doré, S., Christen, Y., Poirier, J., Quirion, R. The *Ginkgo biloba* extract EGb 761<sup>®</sup> protects hippocampal neurons against cell death induced by  $\beta$ -amyloid. *Eur. J. Neurosci.* 2000, 12, 1882–1890.
- 48 Luo, Y., Smith, J.V., Paramasivam, V., Burdick, A., Curry, K.J., Buford, J.P., Khan, I., Netzer, W.J., Xu, H., Butko, P. Inhibition of amyloid- $\beta$  aggregation and caspase-3 activation by the *Ginkgo biloba* extract EGb 761<sup>®</sup>. *Proc. Natl. Acad. Sci. USA* 2002, 99 (19), 12197–12202.
- 49 Warrier, G., Corzine, A. The marketing and economic aspects of *Ginkgo biloba* products. In: van Beek, T.A. (Ed.), *Medicinal and Aromatic Plants – Industrial Profiles, Volume 12, Ginkgo biloba*. Harwood Academic Publishers, Amsterdam, 2000, pp. 517–522.
- 50 Balz, J.P. Agronomic aspects of *Ginkgo biloba* leaves production. In: *Proceedings of "97 International seminar on Ginkgo"*; State Sci. Tech. Comm. P.R. China, Beijing, 10–12 November 1997, pp. 101–117.
- 51 Schmid, W., Balz, J.P. Cultivation of *Ginkgo biloba* L. on three continents. *Acta Hort. (ISHS)* 2005, 676, 177–180.
- 52 Drieu, K., Jaggy, H. History, Development and Constituents of EGb



761. In: van Beek, T.A. (Ed.), *Medicinal and Aromatic Plants – Industrial Profiles, Volume 12, Ginkgo biloba*. Harwood Academic Publishers, Amsterdam, 2000, pp. 267–278.
- 53 O'Reilly, J. *Ginkgo biloba*-large scale extraction and processing. In: van Beek, T.A. (Ed.), *Medicinal and Aromatic Plants – Industrial Profiles, Volume 12, Ginkgo biloba*. Harwood Academic Publishers, Amsterdam, 2000, pp. 99–108.
- 54 Weinges, K., Hepp, M., Jaggy, H. Chemie der ginkgolides, II. Isolierung und strukturaufklärung eines neuen ginkgolides. *Justus Liebig's Annal Chemie* 1987, 521–526.
- 55 Corey, E.J., Su, W.G. Total synthesis of a C-15 ginkgolide, (+/–)-bilobalide. *J. Am. Chem. Soc.* 1987, 109, 7534–7536.
- 56 Crimmins, M.T., Pace, J.M., Nantermet, J.M., Agnes, S., Kim-Meade, A.S., James, B., Thomas, J.B., Watterson, S.H., Wagman, A.S. Total synthesis of (±)-ginkgolide B. *J. Am. Chem. Soc.* 2000, 122, 8453–8463
- 57 Nakanishi, K. The ginkgolides. *Pure Appl. Chem.* 1967, 14, 89–113.
- 58 Okabe, K., Yamada, K., Yamamura, S., Takada, S. Ginkgolides. *J. Chem. Soc. Commun.* 1967, 2201–2206.
- 59 Nakanishi, K., Habaguchi, K., Nakadaira, Y., Woods, M.C., Maruyama, M., Major, R.T., Alauddin, M., Patel, A.R., Weinges, K., Bähr, W. Structure of bilobalide, a rare *tert*-butyl containing sesquiterpenoid related to the C<sub>20</sub>-ginkgolides. *J. Am. Chem. Soc.* 1971, 93, 3544–3546.
- 60 Nakanishi, K. A personal account of the early ginkgolide structural studies. In: van Beek, T.A. (Ed.), *Medicinal and Aromatic Plants – Industrial Profiles, Volume 12, Ginkgo biloba*. Harwood Academic Publishers, Amsterdam, 2000, pp. 143–150.
- 61 Nakanishi, K. Terpene trilactones from *Ginkgo biloba*: from ancient times to the 21st century. *Bioorg Med Chem.* 2005, 13 (17), 4987–5000.
- 62 van Beek, T.A., Lelyveld, G.P. Concentration of ginkgolides and bilobalide in *Ginkgo biloba* leaves in relation to the time of year. *Planta Med.* 1992, 58, 413–416.
- 63 Hue, H., Staba, E.J. Ontogenic aspects of ginkgolide production in *Ginkgo biloba*. *Planta Med.* 1993, 59, 232–239.
- 64 Inoue, H., Kamoda, S., Terada, T. Ginkgolide production in relation to organogenesis in *Ginkgo biloba*. *J. Wood Sci.* 1998, 44, 375–378.
- 65 Carrier, D.J., van Beek, T.A., Verpoorte, R. Distribution of ginkgolides and terpenoid biosynthetic activity in *Ginkgo biloba*. *Phytochemistry* 1998, 48 (1), 89–92.
- 66 Balz, J.P., Courtois, D., Drieu, J., Drieu, K., Reynoird, J.P., Sohier, C., Teng, B.P., Touché, A., Pétiard, V. Production of ginkgolides and bilobalide by *Ginkgo biloba* plants and tissue cultures. *Planta Med.* 1999, 65 (7), 620–626.
- 67 Park, Y.G., Kim, S.J., Jung H.Y., Kang, Y.M., Kang, S.M., Prasad, D.T., Kim, S.W., Choi, M.S. Variation of ginkgolides and bilobalide contents in leaves and cell cultures of *Ginkgo biloba* L. *Biotechnol. Bioprocess Eng.* 2004, 9 (1), 35–40.
- 68 Flesh, V., Jacques, M., Cosson, L., Teng, B.P., Pétiard, V., Balz, J.P. Relative importance of growth and light level on terpene content of *G. biloba*. *Phytochemistry* 1992, 31, 1941–1945.
- 69 Cartayrade, A., Neau, E., Sohier, C., Balz, J.P., Carde, J.P., Walter, J. Ginkgolide and bilobalide biosynthesis in *Ginkgo biloba*. I: Sites of synthesis, translocation, and accumulation of ginkgolides and bilobalide. *Plant Physiol. Biochem.* 1997, 35, 859–868.
- 70 Neau, E., Cartayrade, A., Balz, J.P., Carde, J.P., Walter, J. Ginkgolide and bilobalide biosynthesis in *Ginkgo biloba*. II: Identification of a possible intermediate compound by using inhibitors of cytochrome P-450-dependent oxygenases. *Plant Physiol. Biochem.* 1997, 35, 869–879.
- 71 Sohier, C. Plant biotechnology: An avant-garde research for an ancestral tree, the *Ginkgo biloba*. *Ann. Pharm. Fr.* 2002, 60, 22–27.
- 72 Rohmer, M., Knani, M., Simonin, P., Sutter, B., Sahn, H. Isoprenoid biosynthesis in bacteria: A novel pathway for the early Steps leading to isopentenyl diphosphate. *Biochem J.* 1993, 295, 517–524.

- 73 Rohmer, M. Mevalonate-independent methylerythritol phosphate pathway for isoprenoid biosynthesis. Elucidation and distribution. *Pure Appl. Chem.* **2003**, *75* (2-3), 375–387.
- 74 Cartayrade, A., Schwarz, M.K., Jaun, B., Arigoni, D. Detection of two independent mechanistic pathways for the early Steps of isoprenoid biosynthesis in *Ginkgo biloba*. In: *Second Symposium of the European Network on Plant Terpenoids*, Strasbourg/Bischenberg, January 23–27, Abstract P1, **1994**.
- 75 Eisenreich, W., Schwarz, M., Cartayrade, A., Arigoni, D., Zenk, M.H. Bacher, A. The deoxyxylulose phosphate pathway of terpenoid biosynthesis in plants and microorganisms. *Chem. Biol.* **1998**, *5*, 221–233.
- 76 Eisenreich, W., Bacher, A., Arigoni, D., Rohdich, F. Biosynthesis of isoprenoids via the non-mevalonate pathway. *Cell. Mol. Life Sci.* **2004**, *61*, 1401–1426.
- 77 Arigoni, D., Schwarz, M.K. Ginkgolide biosynthesis. In: Cane, D.E. (Ed.), *Isoprenoids including carotenoids and steroids*. In: Barton, D., Nakanishi, K., Meth-Cohn, O. (Eds.), *Volume 2, Comprehensive Natural Products Chemistry*. Elsevier, Amsterdam, **1999**, pp. 367–400.
- 78 Schepmann, H.G., Pang, J., Seiichi, P., Matsuda, P.T. Cloning and characterization of *Ginkgo biloba* levopimaradiene synthase, which catalyses the first committed step in ginkgolides biosynthesis. *Arch. Biochem. Biophys.* **2001**, *392* (2), 263–269.
- 79 Wang, P., Liao, Z., Guo, L., Li, W., Chen, M., Pi, Y., Gong, Y., Sun, X., Tang, K. Cloning and functional analysis of a cDNA encoding *Ginkgo biloba* farnesyl diphosphate synthase. *Mol. Cell* **2004**, *18* (2), 150–156.
- 80 Liao, Z., Chen, M., Gong, Y., Guo, L., Tan, Q., Feng, X., Sun, X., Tang, K. A new geranyl geranyl diphosphate synthase gene from *Ginkgo biloba*, which intermediates the biosynthesis of the key precursor for ginkgolides. *DNA Sequence* **2004**, *15* (2), 153–158.
- 81 Gong, Y.F., Liao, Z.H., Chen, M., Zuo, K.J., Guo, L., Tan, Q.M., Huang Z.S, Kai, G.Y., Sun, X.F., Tan, F., Tang, K.X. Molecular cloning and characterization of a 1-deoxy-D-xylulose S-phosphate reductoisomerase gene from *Ginkgo biloba*. *DNA Sequence* **2005**, *16* (2), 111–120.
- 82 Tang, L., Okasawa, A., Itoh, Y., Fukusaki, E.I., Kobayashi, A. Expression of chlorophyllase is not induced during autumnal yellowing in *Ginkgo biloba*. *Z. Naturforsch.* **2004**, *59c*, 415–420.
- 83 Lobstein, L., Rietsch-Jako, I., Haag-Berrurter, M., Anton, R. Seasonal variation of the flavonoid content from *Ginkgo biloba* leaves. *Planta Med.* **1991**, *57*, 430–433.
- 84 Schijlen, E.G.W.M., Ric de Vos, C.H., van Tunen, A.J., Bovy, A.G. Modification of flavonoid biosynthesis in crop plants. *Phytochemistry* **2004**, *65*, 2631–2648.
- 85 Pang, Y., Shen, G., Liu, C., Liu, X, Tan, F., Sun, X., Tang, K. Molecular cloning and sequence analysis of a novel chalcone synthase cDNA from *Ginkgo biloba*. *DNA Sequence* **2004**, *15*, (4), 283–290.
- 86 Pang, Y., Shen, G., Wu, W., Liu, X, Lin, J., Tan, F., Sun, X., Tang, K. Characterization and expression of chalcone synthase gene from *Ginkgo biloba*. *Plant Sci.* **2005**, *168*, 1525–1531.
- 87 Canter, P.H., Thomas H., Ernst E. Bringing medicinal plants into cultivation: Opportunities and challenges for biotechnology. *Trends Biotechnol.* **2005**, *23* (4), 180–185.
- 88 Tremouillaux-Guiller J. Cyclic embryogenesis from male and female protoplasts. In: Hori, T., Ridge, R.W., Tulecke, W., Del Tredici, P., Tremouillaux-Guiller, J., Tobe, H. (Eds.), *Ginkgo biloba – A Global Treasure From Biology to Medicine*. Springer, Tokyo, **1997**, pp. 127–140.
- 89 Wang, M., Lamers, R.J.A.N., Korthout, H.A.A.J., van Nesselrooij, J.H.J., Witkamp, R.F., van der Heijden, R., Voshol, P.J., Havekes, L.M., Verpoorte, R., van der Greef, J. Metabolomics in the context of systems biology: Bridging traditional Chinese medicine and molecular pharmacology. *Phytotherapy Res.* **2005**, *19* (3), 173–182.
- 90 Camper, N.D., Coker, P.S., Wedge, D.E., Keese, R.J. *In vitro* culture of *Ginkgo*. *In Vitro Cell Dev. Biol. Plant* **1997**, *33*, 126–127.

- 91 Choi, P.S., Cho, D.Y., Soh, W.Y. Shoot organogenesis from immature zygotic embryo cultures of *Ginkgo biloba*. *Biol. Plant.* **2003**, 47 (2), 309–312.
- 92 Tommasi, F., Scaramuzzi, F. *In vitro* propagation of *Ginkgo biloba* by using various bud cultures. *Biol. Plant.* **2004**, 48 (2), 297–300.
- 93 Thompson, D., Harrington, F., Douglas, G., Hennerty, M. J., Nakhshab, N., Long, R. Vegetative propagation techniques for oak, ash, sycamore and spruce. COFORD, Dublin, **2001**.
- 94 Park, Y.S. Implementation of conifer somatic embryogenesis in clonal forestry: technical requirements and deployment considerations. *Ann. For. Sci.* **2002**, 59, 651–656.
- 95 Zamarripa, C.A., Petiard, V. Biotechnologies applied to coffee. In: Wintgens, J.N. (Ed.), *Coffee: Growing, Processing, Sustainable Production*. Wiley-VCH, Weinheim, **2004**, pp. 137–163.
- 96 Laurain, D., Chénieux, J.C., Tremouillaux-Guiller, J. Somatic embryogenesis from immature zygotic embryos of *Ginkgo biloba*. *Plant Cell Tiss. Org. Cult.* **1996**, 44, 19–24.
- 97 Mulabagal, V., Tsay, H.S. Plant cell cultures – an alternative and efficient source for the production of biologically important secondary metabolites. *Int. J. Appl. Sci. Eng.* **2004**, 2(1), 29–48.
- 98 Vanisree, M., Lee, C.Y., Lo, S.F., Nalawade, S.M., Lin, C.Y., Tsay, H.S. Studies on the production of some important secondary metabolites from medicinal plants by plant tissue cultures. *Bot. Bull. Acad. Sin.* **2004**, 45 (1), 1–22.
- 99 Hellwig, S., Drossard, J., Twyman, R.M., Fischer, R. Plant cell cultures for the production of recombinant proteins. *Nat. Biotechnol.* **2004**, 22 (11), 1415–1422.
- 100 Tulecke, W., Nickell L.G. Production of large amounts of plant tissue by submerged culture. *Science* **1959**, 134, 863–864.
- 101 Carrier, D.J., Cosentino, G., Neufeld, R., Rho, D., Weber, M., Archambault, J. Nutritional and hormonal requirements of *Ginkgo biloba* embryo-derived callus and suspension cell culture. *Plant Cell Rep.* **1990**, 8, 635–638.
- 102 Jeon, M.H., Sung, S.H, Huh, H., Kim, Y.C. Ginkgolide B production in cultured cells derived from *Ginkgo biloba* leaves. *Plant Cell Rep.* **1995**, 14, 501–504.
- 103 Laurain, D., Tremouillaux-Guiller, J., Chénieux, J.C., van Beek, T.A. Production of ginkgolide and bilobalide in transformed and gametophyte derived cell cultures of *Ginkgo biloba*. *Phytochemistry* **1997**, 46 (1), 127–134.
- 104 Carrier, D.J., Laurain, D. Plant cell biotechnology of *Ginkgo*. In: van Beek, T.A. (Ed.), *Medicinal and Aromatic Plants – Industrial Profiles, Volume 12, Ginkgo biloba*. Harwood Academic Publishers, Amsterdam, **2000**, pp. 81–97.
- 105 Park, Y.G., Kim, S.J., Kang, Y.M., Jung, H.Y., Prasad, D.T., Kim, S.W., Chung, Y.G. Choi, M.S. Production of ginkgolides and bilobalide from optimised *Ginkgo biloba* cell culture. *Biotechnol. Bioprocess Engin.* **2004**, 9 (1), 41–46.
- 106 Carrier, D.J., Chauret, N.G., Mancini, M., Coulombe, P., Neufeld, R., Weber, M., Archambault, J. Detection of ginkgolide A in *Ginkgo biloba* cell cultures. *Plant Cell Rep.* **1991**, 10, 256–259.
- 107 Carrier, D.J., Archambault, J., Heijden, R., Verpoorte, R. Formation of terpenoid product in *Ginkgo biloba* L. cultivated cells. *Plant Cell Rep.* **1996**, 15, 888–891.
- 108 Itoh, K., Ohta, T., Tachibana, S. Production of ginkgolides in seed-derived callus cultures of icho (*Ginkgo biloba* L.). *Mokuzai Gakkaishi* **2003**, 49 (1), 40–46.
- 109 Zheng, Y., Yu, R., Yao, X., Zhang, H., Shao, G. Studies on the callus cultures of *Ginkgo biloba* and the identification of ginkgolides. *J. Shenyang Pharm. Univ.* **1999**, 16 (1), 10–15.
- 110 Agarwal, S., Kumar, A., Banerjee, S., Gupta, M.M., Verma, R.K., Singh, D.V., Kumar, S. Production of bilobalide in cultures of clone GBC-1 of *Ginkgo biloba*. *J. Med. Arom. Plant Sci.* **2000**, 22 (4A), 194–196.
- 111 Dai, J.G., Zhu, W.H., Wu, Y.Q., Hu, Q., Zhang, D.Y. Studies on single cell cloning of *Ginkgo biloba* L. *Zhongguo Zhong Yao Za Zhi* **2000**, 25 (10), 593–597.

- 112 Cartayrade, A., Bourgeois, G., Balz, J.P., Carde, J.P. The secretory apparatus of *Ginkgo biloba*: Structure, differentiation and analysis of the secretory product. *Trees* **1990**, *4*, 171–178.
- 113 Zhao, J., Davis, L.C., Verpoorte, R. Elicitor signal transduction leading to production of plant secondary metabolites. *Biotechnol. Adv.* **2005**, *23* (4), 283–333.
- 114 Stafford, H.A., Kretlow, K.S., Lester H.H. Comparison of proanthocyanidins and related compounds in leaves and leaf-derived cell cultures of *Ginkgo biloba* L., *Pseudotsuga menziesii* Franco, and *Ribes sanguineum* Pursh. *Plant. Physiol.* **1986**, *82*, 1132–1138.
- 115 Byun, S.Y., Ryu, Y.W., Kim, D.I. Studies on production of flavonol glycosides in cell cultures of *Ginkgo biloba*. *Biochem. Eng.* **1992**, *2001*, 246–249.
- 116 Kim, M.S., Lee, W.K., Kim, H.Y., Kim, C., Ryu, Y.W. Effect of environmental factors on flavonol glycoside production and phenylalanine ammonia-lyase activity in cell suspension cultures of *Ginkgo biloba*. *J. Microbiol. Biotechnol.* **1998**, *8* (3), 237–244.
- 117 Kim, M.S., Kim, C., Jo, D.Y., Ryu, Y.W. Effect of fungal elicitor and heavy metals on the production of flavonol glycosides in cell cultures of *Ginkgo biloba*. *J. Microbiol. Biotechnol.* **1999**, *9* (5), 661–667.
- 118 Fiehe, K., Arenz, A., Drewke, C., Hemscheidt, T., Williamson, R.T., Leistner, E. Biosynthesis of 4'-O-methylpyridoxine (ginkgotoxin) from primary precursors. *J. Nat. Prod.* **2000**, *63* (2), 185–189.
- 119 Dai, J.G., Yang, L., Sakai, J.I., Ando, M. Combined biotransformations of 4(20),11-taxadienes. *Tetrahedron* **2005**, *61* (23), 5507–5517.
- 120 Dai, J.G., Ye, M., Guo H., Zhu, W., Zhang, D., Hu, Q., Zheng, J., Guo, D. Regio- and stereo-selective biotransformation of 2 $\alpha$ ,5 $\alpha$ ,10 $\beta$ ,14 $\beta$ -tetra-acetoxy-4(20), 11-taxadiene by *Ginkgo* cell suspension cultures. *Tetrahedron* **2002**, *58*, 5659–5668.
- 121 Dai, J.G., Zhang, D.Y., Ye, M., Zhu, W.H., Guo H., Liang, X.T. Biotransformation of 14-deacetoxy-13 oxosinenxan A by *Ginkgo* cell cultures. *Chin. Chem. Lett.* **2003**, *14* (8), 804–806.
- 122 Han, J., Dai, J.G., Cui, Y.J., Zhan, J.X., Guo, H.Z., Guo, D.A. Biotransformation of artemisinin by *Catharanthus roseus* and *Ginkgo biloba* cell suspension cultures. *Chin. Trad. Herb. Drugs* **2003**, *34*, 166–168.
- 123 Yang, L., Dai, J., Sakai, J., Ando, M. Biotransformation of alpha-santonin by cell suspension cultures of five plants. *Biotechnol. Lett.* **2005**, *27* (11), 793–797.
- 124 Engelmann, F. Plant cryopreservation: Progress and prospects. *In Vitro Cell Dev. Biol. Plant* **2004**, *40* (5), 427–433.
- 125 Courtois, D., Yvernel, D., Florin, B., Pétiard, V. Conversion of tryptamine to serotonin by cell suspension cultures of *Peganum harmala*. *Phytochemistry* **1988**, *27*, 3137–3142.
- 126 Florin, B., Tessereau, H., Lecouteux, C., Courtois, D., Petiard, V. Long-term preservation of somatic embryos. In: Redenbaugh, K. (Ed.), *Synseeds: Applications of synthetic seeds to crop improvement*. CRC Press, Boca Raton, California, **1992**, pp. 133–161.
- 127 Federici, E., Touche, A., Choquart, S., Avanti, O., Fay, L., Offord, E., Courtois, D. High isoflavone content and estrogenic activity of 25 year-old *Glycine max* tissue cultures. *Phytochemistry* **2003**, *64* (3), 717–724.
- 128 Peters, R.J., et al. Metabolic engineering of plant secondary metabolism. In: Christou, P., Klee, H. (Eds.), *Handbook of Plant Biotechnology, Volume 2*. John Wiley & Sons Ltd, Chichester, UK, **2004**, pp. 609–628.
- 129 Komari, T., Yuji, I., Yukh, Y. Plant transformation technology: *Agrobacterium*-mediated transformation. In: *Handbook of Plant Biotechnology, Volume 1*. John Wiley & Sons Ltd, Chichester, UK, **2004**, pp. 233–261.
- 130 Dupré, P., Lacoux, J., Neutelings, G., Mattar-Laurain, D., Fliniaux, M.A., David, A., Jacquin-Dubreuil, A. Genetic transformation of *Ginkgo biloba* by *Agrobacterium tumefaciens*. *Physiol. Plant.* **2000**, *108* (4), 413–419.
- 131 Liu, S.N., Sun T.N., Li G. B. Transformation of *Ginkgo* hairy root and establishment of its suspension culture clone.

- Wuhan Univ. J. Nat. Sci. **1997**, 2 (4), 493–494.
- 132** Li, G.B., Sun, T.E., Liu, S.N. Studies on biological characteristics of *Ginkgo* hairy-root culture. *Wuhan Univ. J. Nat. Sci.* **1999**, 4 (2), 227–232.
- 133** Ayadi, R., Tremouillaux-Guiller, J. Root formation from transgenic calli of *Ginkgo biloba*. *Tree Physiol.* **2003**, 23, 713–718.
- 134** Laurain-Mattar, D. *Ginkgo biloba*: A medicinal and ornamental tree of great interest. In: Ramawat, K.G. (Ed.), *Biotechnology of Medicinal Plants (Vitalizer and Therapeutic)*. Sciences Publishers, Enfield, UK, **2004**, pp. 143–177.
- 135** Vom Endt, D., Kijne, J.W., Memelink, J. Transcription factors controlling plant secondary metabolism: what regulates the regulators? *Phytochemistry* **2002**, 61, 107–114.
- 136** Davies, K.M., Schwinn, K.E. Transcriptional regulation of secondary metabolism. *Funct. Plant Biol.* **2003**, 30 (9), 913–925.

## 22

### Production of Paclitaxel in Plant Cell Cultures

*Homare Tabata*

#### Abstract

Paclitaxel (Taxol<sup>®</sup>), which is one of the most exciting antitumor compounds obtained from plant resources, demonstrates antitumor activity by unique mechanisms against cancer cells. This interesting compound is problematic from the point of its supply due to its very low content in yew tree, such that serious damage may be inflicted on the yew tree by sampling these plant parts. Plant cell culture technology is suited to the stable production of small quantities of constituent compounds such as paclitaxel. Cell suspension culture systems of *Taxus* species were established, and several stimulators identified for paclitaxel production, including jasmonic acid-related compounds. Methyl jasmonate (MeJA), the most powerful stimulator of taxane production, up-regulates the mRNA levels of paclitaxel biosynthetic enzymes such as geranylgeranylpyrophosphate synthase (GGPS) and taxadiene synthase (TDS). Recently, the genetic modification of plant cell and tissue was positioned as a key technology for the high production of active compounds. In the case of *Taxus* species, many genes encoding enzymes relating to the production of paclitaxel have been cloned. However, the technology for gene manipulation of *Taxus* species is yet to be established. It is possible that phyto-sulfokine- $\alpha$  (PSK- $\alpha$ ), an inhibitor of browning reactions, may be utilized for the gene manipulation.

#### 22.1

##### Introduction

Paclitaxel, which is known as the anticancer drug Taxol<sup>®</sup>, launched by Bristol-Myers Squibb, is the most effective compound derived from plant species for patients with various tumors, including breast cancer, ovarian cancer, AIDS-related Kaposi's sarcoma, and non-small-cell lung cancer [1]. Several unique functions of paclitaxel against cancer cells have been identified: (i) tubulin stabilization by promoting the assembly of and inhibiting the disassembly of microtubules [2, 3];

(ii) the effect on cell signaling by the gene expression and activation of MAPKs, Raf-1, tyrosine kinases, c-Jun NH<sub>2</sub>-terminal kinase, and nitric oxide synthase [4–10]; and (iii) the effect on triggering apoptosis through caspase-dependent and independent pathways [11–15] by regulating the expression of apoptosis-related proteins such as Bcl-2, Bad, and Bcl-xL [16–20].

After having identified these interesting mechanisms of action, the National Cancer Institute (NCI) began clinical trials of paclitaxel's safety and efficacy against various types of cancer in 1983. The Food and Drugs Administration (FDA) approved the use of paclitaxel for refractory ovarian cancer in 1992, and for breast cancer in 1994. Despite increasing demand for paclitaxel, the provision of adequate supplies of the drug continued to be a major problem. During the early 1990s, many yew trees were felled with the aim of obtaining paclitaxel for medicinal use, but this ceased in 1993 on the basis of environmental protection. In the quest for alternative sources of paclitaxel, several investigations conducted among different species of *Taxus* showed that the compound's distribution was not species-dependent [21]. In terms of its distribution within the plant, paclitaxel concentrations in the bark and roots were found to be higher than those in the wood, branches, and needles (i.e., less than 0.05%) [22]. However, it is impractical to collect the bark and roots on a commercial scale due as this inflicts serious damage on the yew trees when sampling these plant parts. In an attempt to secure supplies of paclitaxel, a semi-synthetic commercial production using 10-deacetylbaccatin III from the needles of *T. wallichiana* was developed. However, this method faced a similar problem, namely the supply of 10-deacetylbaccatin III from natural yew tree as the intermediate of paclitaxel. Although the chemical synthesis of paclitaxel has already been achieved [23, 24], the procedure is, for reasons of cost, not practical for the commercial supply of paclitaxel and related taxanes.

On a structural basis, paclitaxel has many chiral centers and a multi-ring structure in the taxane ring system. Although this makes the chemical process non-feasible, as it requires many reaction and purification steps, a method of producing paclitaxel by plant cell culture technology might be viable by utilizing a stereoselective taxane biosynthesis, with sucrose as a carbon resource. Commercial production using plant cell culture technology would also correlate well with recent trends towards “green chemistry”, and consequently many groups have investigated a paclitaxel production process using *Taxus* cell suspension cultures [25].

In this chapter, successful examples of paclitaxel production by *Taxus* cell suspension cultures are described, and the future technology for the useful compound production originating from plant resources is discussed.

## 22.2

### Plant Cell Culture Technology for Paclitaxel Production

During the past decade, many studies have been reported in which paclitaxel has been produced using cell suspension cultures of *Taxus* species, including as *T. brevifolia* [26–28], *T. baccata* [29], *T. cuspidata* [30–34], *T. chinensis* [35–38],

*T. canadensis* [33], *T. yunnanensis* [39], and *T. x. media* (a cross of *T. baccata* and *T. cuspidata*) [40–42]. Paclitaxel was detected in almost all *Taxus* species, with high concentrations (0.01–0.04%) being found especially in the bark. Paclitaxel has been reported at up to 0.033% in some samples of leaves and needles, but in general the content is much lower than that in the bark [43]. Problems arise, however, because the bark cannot be used for callus formation due to a lack of growing ability, and consequently the foliage (notably young foliage) was found to be the best plant part for callus formation of *Taxus* species. A suitable subculture for the growth of *Taxus* cells was mainly WP [44] or Gamborg's B5 [45] as a basal medium, supplemented with approximately  $10^{-5}$  M NAA or 2,4-D [42, 46, 47]. The growth of an established cell line was very slow, however, with cell numbers increasing only three- to fivefold during a 21-day culture period. Hence, it was considered important to identify stimulators of paclitaxel biosynthesis in order to develop an effective production process. The accumulation of paclitaxel and related taxanes in the yew tree is thought to be a biological response to biotic and abiotic stress such as natural hormones, nutrients, chemical and fungal elicitors, light, and wounding, as is often seen in secondary metabolite production. In the case of paclitaxel production using *Taxus* cell suspension cultures, a variety of chemical and non-chemical compounds such as fungal elicitor,  $\text{La}^{3+}$ , temperature shift, silver thiosulfate (STS) as anti-ethylene compound, and methyl jasmonate (MeJA) as a jasmonate-related compound, stimulate the production of paclitaxel and related taxanes [33, 36, 38, 39, 42, 47, 48]. Comparisons of paclitaxel productivity in reported cases showed MeJA to be an especially powerful stimulator of paclitaxel production, with a combination of MeJA treatment and high-density culture system producing 295 mg L<sup>-1</sup> paclitaxel in a large-scale culture of *T. x. media* [47].

## 22.3

### Paclitaxel Biosynthetic Pathway and Related Genes

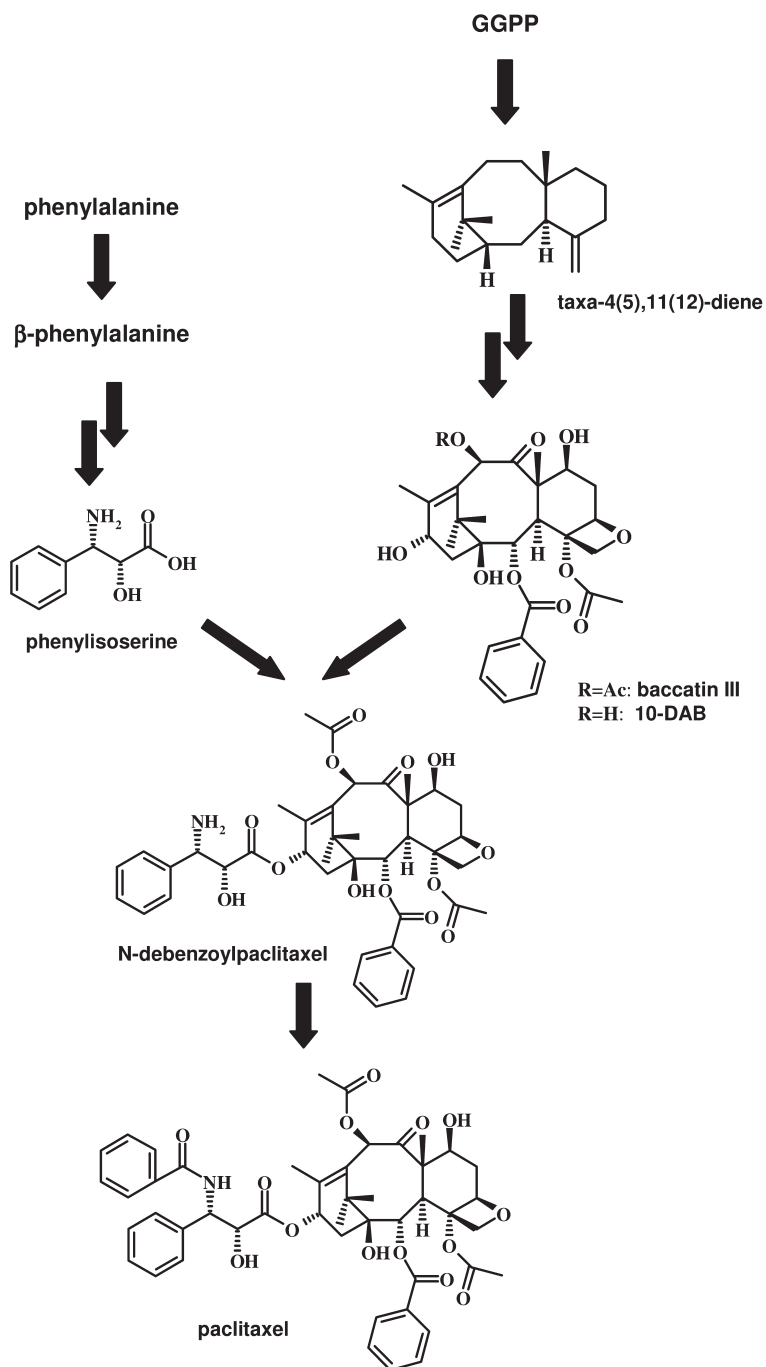
The paclitaxel biosynthetic pathway comprises four steps:

- supply of geranylgeranyl diphosphate (GGPP);
- taxane-ring formation with taxadiene synthase;
- formation of baccatin III as an important intermediate of paclitaxel biosynthesis; and
- esterification of the phenylisoserine side chain at the C-13 position of baccatin III (Fig. 22.1).

In recent years, many genes encoding the enzymes relating to the production of paclitaxel have been cloned (Table 22.1). It is important to understand the paclitaxel biosynthetic pathway and its enzymatic regulation in order to accomplish high productivity of paclitaxel by transgenic technology.

The first step in paclitaxel biosynthesis is the supply of GGPP, which is the universal intermediate of diterpenoid. Paclitaxel is derived from GGPP, which is formed by the addition of a further isopentenyl diphosphate (IPP) molecule to





**Fig. 22.1** Biosynthetic pathways of paclitaxel and the related taxanes. The universal intermediate of diterpenoids (i.e., geranylgeranylpyrophosphate; GGPP) is supplied via the non-mevalonate pathway.

**Table 22.1** Cloned genes encoding the taxane formation-relating enzymes.

<b>Step</b>	<b>Cloned genes encoding paclitaxel biosynthetic enzymes</b>	<b>Ref.</b>
Non-mevalonate pathway	1-Deoxy-D-xylulose-5-phosphate reductoisomerase	50
GGPP formation	Geranylgeranyl diphosphate synthase	52
Taxane-ring formation	Taxadiene synthase	54
Baccatin III formation	Taxoid 5 $\alpha$ -hydroxylase	60
	Taxoid 5-O-acetyltransferase	65
	Taxoid 10 $\beta$ -hydroxylase	61
	Taxoid 13 $\alpha$ -hydroxylase	63
	Taxoid 7 $\beta$ -hydroxylase	64
	Taxoid 2 $\alpha$ -hydroxylase	62
	Taxoid 2-O-benzoyltransferase	66
	Taxoid 10-O-acetyltransferase	66
C-13 side-chain formation	Taxoid 13-O-sidechain transferase	71
	Taxoid 3'-N-benzoyltransferase	72
	Taxoid 2'-hydroxylase	70
	Phenylalanine aminomutase	69
14 $\beta$ -hydroxytaxoid formation	Taxoid 14 $\beta$ -hydroxylase	68

farnesyl diphosphate. It has been reported that IPP and the other isoprene unit, dimethylallyl diphosphate (DAMPP), are supplied via a non-mevalonate pathway [49]. The gene encoding 1-deoxy-D-xylulose-5-phosphate reductoisomerase (DXR), which was considered as the key enzyme of the pathway, has already been cloned [50]. The results of random sequencing of cDNA library from MeJA-treated *T. cuspidata* cells showed that expressed sequence tags (ESTs) encoding GGPP synthase were quite abundant (14 out of the 8424 ESTs), but that there was only one for IPP isomerase [51]. With regard to the whole gene of GGPP synthase, full-length cDNAs have been cloned in *T. canadensis* and *T. baccata* [47,52]. In *Arabidopsis thaliana*, the five genes encoding GGPP synthase isozymes were respectively classified in the types of mitochondria, chloroplast, and endoplasmic reticulum (ER) [53]. In the case of *T. canadensis*, only one gene encoding the GGPS (i.e., TcGGPS) has been reported [52]. In *T. baccata* suspension cultured cells, two genes encoding the GGPSs (i.e., *TbGGPS1* and *TbGGPS2*) have been cloned (Fig. 22.2). Comparison of the deduced amino acid sequence of TcGGPS and *TbGGPS1* revealed that only two amino acid residues differed from each other at the positions not substantial for enzyme activity, and these have the chloroplast/plastid targeting signal peptide in their N-terminal regions. In contrast, comparison of the deduced amino acid sequence of *TbGGPS1* and *TbGGPS2* revealed that the amino acid sequences at the N-terminal region clearly differed one from each other, and the result of iPSORT searching on the N-terminal region of *TbGGPS2* indicated that the region might be a mitochondrial targeting signal.

The second step in paclitaxel biosynthesis is that of taxane-ring formation – for example, taxa-4(5),11(12)-diene derived from the substrate GGPP by the taxadiene

TbGGPS1	MAYTAMAAGT	QSLQLRIVAS	YQECNSMRSC	FKLTPFKSFH	GVNFNVPSLG	AANCEIMGHL	60
TcGGPS	.....	.....	.....	.....	.....	.....	
TbGGPS2	MR.	AFLKVGMDHK	VVFPNSHTNP	MSPSSGS.TR	SSIVHTSNPD	EK.TGSPCNS	
TbGGPS1	KLGSPLYKQC	SVSSRSTKM	AQLVDLAETE	KAEGKDIEFD	FNEYMKSKAV	SVDAALDKAI	120
TcGGPS	.....	.....K.....	.....	.....	.....	A.....	
TbGGPS2	SSLTASWLIR	KKLNCIIITAK	S...NEI.KN	D-.D.V.A..	.KK.VT..G	AINET...CV	
TbGGPS1	PLEYPEKIHE	SMRYSLLAGG	KRVRPALCIA	ACELVGGSQD	LAMPTACAME	MIHTMSLIHD	180
TcGGPS	.....	.....	.....	.....	.....	.....	
TbGGPS2	S.R...L..	A.....	.....I..L..	..D.....EE	S.I.S...V..	I.....	
TbGGPS1	DLPCMDNDDF	RRGKPTNHKV	FGEDTAVLAG	DALLSFAFEH	IAVATSKTVP	SDRTLRLVISE	240
TcGGPS	.....	.....	.....	.....	.....	.....	
TbGGPS2	.....M.....	.....V.....	.....A.....	.....S..-..G.E	AG.V.....	.....	
TbGGPS1	LGKTIGSQGL	VGGQVVDITS	EGDANVDLKT	LEWIHIHKTA	VLLECSVVSG	GILGGATEDE	300
TcGGPS	.....	.....	.....	.....	.....	.....	
TbGGPS2	..A.....	A.....	G.ISD.G.NL	..Y.V...A...G...I..	A.....G.S.E.	.....	
TbGGPS1	IARIRRYARC	VGLLFQVVDD	ILDVTKSSEE	LGKTAGKDILL	TDKATYPKLM	GLEKAKEFAA	360
TcGGPS	.....	.....	.....	.....	.....	.....	
TbGGPS2	.G.L.TF...	I.....L.....	.....Q.....	.....V.A..V.....L	.....SR...E	.....	
TbGGPS1	ELATRAKEEL	SSFQDKAAP	LLGLADYIAF	RQN			393
TcGGPS	.....	.....	.....	.....	.....	.....	
TbGGPS2	..NRQ..DQ.	V...TN..T.	.IC.....H	.H.			

**Fig. 22.2** Amino acid sequence comparison of TbGGPS1 and related GGPSs. The deduced amino acid sequence of protein TbGGPS1, TbGGPS2 and TcGGPS were aligned. The underlined regions designated I and II are regions that contain the aspartate-rich DDxxD motif that have been shown to be important in catalysis.

synthase (TDS) [54]. The DNA sequence of TDS has an open reading frame (ORF) of 2586 nucleotides, and the deduced polypeptide consists of 862 amino acid residues with a long plastidial targeting signal sequence at the N-terminus. Sequence comparison with other diterpene cyclases showed a significant homology. In general, all terpene cyclases contain the aspartate-rich DDxxD motif (in some cases, the aspartate residues replace the glutamate residues), coordinating with divalent metal ions for substrate binding [55, 56]. The DDxxD motif is important for the catalytic activity of terpene cyclases, since mutagenic analysis of any of the three aspartates of the DDxxD motif in limonene synthase to either Ala or Glu reduced the catalytic activity by 1000-fold. In the case of TDS, the DDMAD motif and DSYDD motif are conserved in its polypeptide structure [54].

It has been reported that the several types of cyclic-diterpenoids (not only the taxane-type but also the abietane-type) were isolated from the bark of *T. yunnanensis* and from the callus of *T. baccata* and *T. cuspidata* [57–59]. However, according to the results of chemical analysis in the main constituents produced by MeJA-treated *T. baccata* cell suspension cultures, the ten main products were identified as the taxane-type diterpenoid, and no abietane-type diterpenoid was detected. This is probably because the taxane-type diterpenoid is the predominant product as compared to the abietane-type diterpenoid in *Taxus* cells. The gene expression of TDS was up-regulated by addition of MeJA in *Taxus* cell culture systems, and so was the GGPP synthase gene. These results showed that MeJA up-regulates the multi-steps of the taxane biosynthetic pathway including the key regulatory step, namely the cyclization of diterpenoid, by TDS.

The third step of biosynthesis is formation of the most important intermediate (e.g., baccatin III) from taxa-4(5),11(12)-diene. As the result of the multi-step reactions by the site-specific hydroxylases [60–64] and the CoA-dependent acyltransferases [65–67], baccatin III was formed from taxa-4(5),11(12)-diene as the substrate. Baccatin III contains oxygen functions at the seven different positions of the taxane-ring. These reactions were catalyzed by cytochrome P450 hydroxylases of CYP725 family, which are not observed in *A. thaliana* or *Oryza sativa*. In *T. chinensis* cell cultures, the production of C-14 hydroxy-taxane (i.e., taxuyunnanine C), which is mapped on the side-route of baccatin III formation, was observed, and the gene encoding taxoid 14 $\beta$ -hydroxylase has been cloned [68]. These results demonstrated that there are many substrate-specific, uncharacterized P450 oxygenase genes existing in many plants. During the past decade, although a method to prepare the candidate genes of P450 oxygenases has been developed, it is still difficult to characterize the function of the translational product.

The final step of paclitaxel biosynthesis is derivatization of the side chain at the C-13 position of baccatin III. Paclitaxel has a structure of baccatin III with phenylisoserine attached to its C-13 position; this derivatization is conducted by various enzymes, including phenylalanine aminomutase [69] and C-13 side-chain 2'-hydroxylase [70]. The phenylisoserine side chain was attached to baccatin III by C-13 phenylpropanoid side chain-CoA acyltransferase [71], followed by N-benzoylation to complete paclitaxel formation [72].

There are two regulatory steps in the paclitaxel biosynthetic pathway in *Taxus* cell suspension cultures; namely, the taxane ring-formation step and the C-13 side chain-binding step [47].

## 22.4

### Genetic Modification of Taxus Cells

The genetic modification of plant cells and tissues is seen as one of the key technologies for the effective production of medicinally active compounds with high productivity. Many reports have been made on the use of transformed plant cell and tissue cultures for the production of compounds such as forskolin, tanshinone, rosmarinic acid, podophyllotoxin, isoquinoline alkaloids, and ginsenosides [73–78]. A yet, however, no method of genetic modification on *Taxus* cells has been established, most likely due to the cell's high sensitivity to various types of stress that leads to cell growth inhibition.

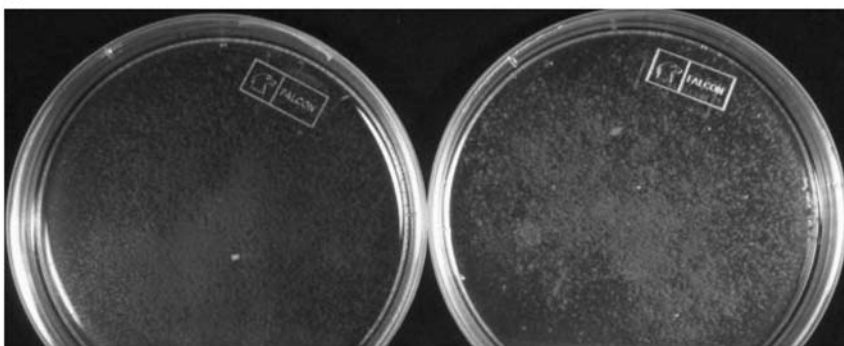
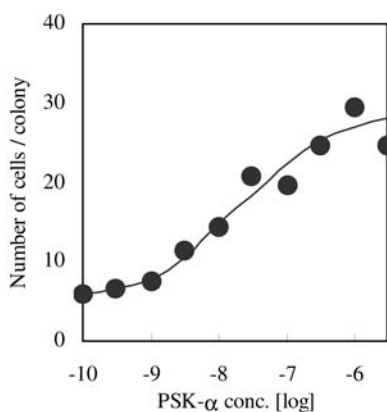
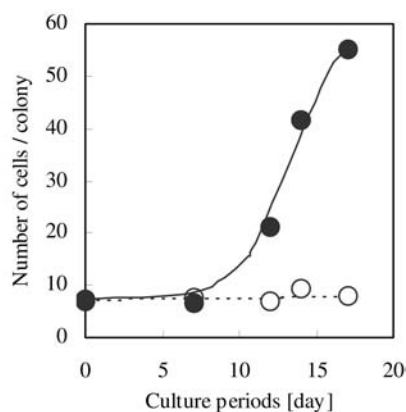
Two general methods are available for plant transformation:

- the *Rhizobacterium* (otherwise termed *Agrobacterium*) infection method; and
- the particle bombardment method.

The success of the *Rhizobacterium* infection method depends on identifying the correlation between the host plant and the *Rhizobacterium* strain. It has been reported that the infection of different *Rhizobacterium* strains induced different types of hairy-root formation in *Panax ginseng*. In this method, the roots or the cells must be washed in the medium containing anti-*Rhizobacterium* compounds (e.g., cefotaxime) following the infection, and this can cause stress to the cell. An incorporation T-DNA in *Taxus* cells using this method has been reported [79], but it has become clear that some strains of *Taxus* cell suspension culture are sensitive to unidentified stresses, which lead to cell growth inhibition as a result of the browning component production.

The particle bombardment method is a mechanical process, in contrast to the *Rhizobacterium* infection method. For successful transformation using this method, the cells must be resistant to a physical stress (i.e., wounding by the particle) and the size of the colonies of the host cells must be optimized for bombardment.

The common key success factor of these two methods is optimization of the culture conditions for basal cell growth during selection of the transformed cells. In the case of model plants (e.g., *A. thaliana*) there is no problem regarding cell growth inhibition. However, in the case of woody plants (e.g., *Taxus* sp.) it is difficult to optimize the condition so that only transformed cells can grow because of the cell-growth inhibition. Many research groups have encountered this problem during callus formation. One method often used to overcome this problem is that of a nurse culture in order to facilitate cell growth. In a recent study, the two active compounds in the nurse culture were identified as sulfated peptides, namely phytosulfokine- $\alpha$  (PSK- $\alpha$ ) and phytosulfokine- $\beta$  (PSK- $\beta$ ) [80]. The amino acid sequence of PSK- $\alpha$  is H-Tyr(SO<sub>3</sub>H)-Ile-Tyr(SO<sub>3</sub>H)-Thr-Gln-OH, and its active core is the N-terminal tripeptide H-Tyr(SO<sub>3</sub>H)-Ile-Tyr(SO<sub>3</sub>H)-OH, which is equivalent to PSK- $\beta$  [81]. PSK- $\alpha$  was found universally in monocotyledons and dicotyledons, and reported to strongly promote the proliferation of plant cells in culture [82, 83]. In addition to its activity on cell proliferation, PSK- $\alpha$  also shows an inhibitory activity on the browning reactions (Fig. 22.3) [84]. For this reason, the colonies of transformed

**a****b****c**

**Fig. 22.3** An inhibitory activity on the browning reactions of *Taxus* cells by phyto-sulfokine- $\alpha$  (PSK- $\alpha$ ). (a) Effect of dimethylsulfoxide (DMSO) (left) and  $10^{-6}$  M PSK- $\alpha$  (right) on the browning reaction.

(b) Effects of PSK- $\alpha$  on cell growth of *T. baccata* cultured cells. (c) Time course analysis of *T. baccata* cell suspension cultures treated with DMSO (○) and  $10^{-6}$  M PSK- $\alpha$  (●).

*Taxus* cells may be obtained by the addition of compounds such as PSK- $\alpha$ , which promote cell proliferation and possess inhibitory activity towards the browning reactions.

## 22.5

### Future Technology for the Production of Useful Compounds

During the past 30 years plant cell culture technology, in order to produce useful compounds, has undergone intense investigation. Despite the secondary metabolites being the main targets, few successful cases have been reported, due largely to problems of cost-effectiveness. The best-known, and most successful, example

is that of paclitaxel (*Taxol*®) by Bristol-Myers Squibb (BMS), who now produce *Taxol* solely via plant cell cultures. In 2004, The US Environmental Protection Agency awarded Bristol-Myers Squibb a Presidential Green Chemistry Challenge Award in recognition of its development and use of a more environmentally friendly means of manufacturing *Taxol*.

In future, plant cell culture technology will surely focus towards green chemistry. In recent years, guidelines for Good Agricultural Practice (GAP) have been provided with the aim of reducing risks and assuring food safety. At the same time, governmental regulations on pathogenic organisms, non-essential heavy metals and pesticide or herbicide contaminants in supplemental foods and medicines have become more strict, such that plant cell culture technology now offers an alternative to existing manufacturing processes. Especially, in the case of extracts or active ingredients, plant cell culture technology provides many advantages over plant extraction, not only by reducing risks of contamination but also ensuring high productivity of the active ingredient.

One other group of compounds produced by plant cell culture technology is that of “foreign” proteins, such as interleukins, immunoglobulins and hGM-CSF [85, 86], all of which are now produced by genetically modified plant cells. The main advantage of this approach is that glycoproteins produced in recombinant plant cells show much greater similarity to their counterparts in terms of N-glycan structure than do the same proteins produced in yeast, bacteria, or fungi [87]. Although, today no recombinant proteins have (yet) been produced commercially using plant cell culture technology, recent technological advances in this area will undoubtedly lead to this target being realized in the near future.

### Acknowledgments

The author thanks the Botanical Garden of the Faculty of Agriculture, Hokkaido University, for providing cuttings of *T. baccata* LINN plants, the National Cancer Institute (USA) for providing paclitaxel and baccatin III standards, and D.G.I. Kingston of Virginia Polytechnic Institute and State University for providing a standard sample of baccatin III and NMR spectra.

### References

- 1 Rowinsky, E.K., Cazenave, L.A., Donehower, R.C. Taxol: a novel investigational antimicrotubule agent. *J. Natl. Cancer Inst.* **1990**, *82*, 1247–1259.
- 2 Schiff, P.B., Fant, J., Horwitz, S.B. Promotion of microtubule assembly in vitro by taxol. *Nature* **1979**, *277*, 665–667.
- 3 Cragg, G.M., Schepartz, S.A., Suffness, M., Grever, M.R. The taxol supply crisis. New NCI policies for handling the large-scale production of novel natural product anticancer and anti-HIV agents. *J. Nat. Prod.* **1993**, *56*, 1657–1668.
- 4 Stone, A.A., Chambers, T.C. Microtubule inhibitors elicit differential effects on MAP kinase (JNK, ERK, and p38) signaling pathways in human KB-3 carcinoma cells. *Exp. Cell Res.* **2000**, *254*, 110–119.
- 5 Stadheim, T.A., Xiao, H., Eastman, A. Inhibition of extracellular signal-regulated



- kinase (ERK) mediates cell cycle phase independent apoptosis in vinblastine-treated ML-1 cells. *Cancer Res.* **2001**, *61*, 1533–1540.
- 6 Boldt, S., Weidle, U.H., Kolch, W. The role of MAPK pathways in the action of chemotherapeutic drugs. *Carcinogenesis* **2002**, *23*, 1831–1838.
  - 7 Okano, J., Rustgi, A.K. Paclitaxel induces prolonged activation of the Ras/MEK/ERK pathway independently of activating the programmed cell death machinery. *J. Biol. Chem.* **2001**, *276*, 19555–19564.
  - 8 Wolfson, M., Yang, C.P., Horwitz, S.B. Taxol induces tyrosine phosphorylation of Shc and its association with Grb2 in murine RAW 264.7 cells. *Int. J. Cancer* **1997**, *70*, 248–252.
  - 9 Boudny, V., Nakano, S. Src tyrosine kinase augments taxotere-induced apoptosis through enhanced expression and phosphorylation of Bcl-2. *Br. J. Cancer* **2002**, *86*, 463–469.
  - 10 Kim, Y.M., Paik, S.G. Induction of expression of inducible nitric oxide synthase by Taxol in murine macrophage cells. *Biochem. Biophys. Res. Commun.* **2005**, *326*, 410–416.
  - 11 Wieder, T., Essmann, F., Prokop, A., Schmelz, K., Schulze-Osthoff, K., Beyaert, R., Dorken, B., Daniel, P.T. Activation of caspase-8 in drug-induced apoptosis of B-lymphoid cells is independent of CD95/Fas receptor-ligand interaction and occurs downstream of caspase-3. *Blood* **2001**, *97*, 1378–1387.
  - 12 Ofir, R., Seidman, R., Rabinski, T., Krup, M., Yavelsky, V., Weinstein, Y., Wolfson, M. Taxol-induced apoptosis in human SKOV3 ovarian and MCF7 breast carcinoma cells is caspase-3 and caspase-9 independent. *Cell Death Differ.* **2002**, *9*, 636–642.
  - 13 Huisman, C., Ferreira, C.G., Broker, L.E., Rodriguez, J.A., Smit, E.F., Postmus, P.E., Kruyt, F.A., Giaccone, G. Paclitaxel triggers cell death primarily via caspase-independent routes in the non-small cell lung cancer cell line NCI-H460. *Clin. Cancer Res.* **2002**, *8*, 596–606.
  - 14 Huang, Y., Sheikh, M.S., Fornace, A.J., Jr., Holbrook, N.J. Serine protease inhibitor TPCK prevents Taxol-induced cell death and blocks c-Raf-1 and Bcl-2 phosphorylation in human breast carcinoma cells. *Oncogene* **1999**, *18*, 3431–3439.
  - 15 Park, S.J., Wu, C.H., Gordon, J.D., Zhong, X., Emami, A., Safa, A.R. Taxol induces caspase-10-dependent apoptosis. *J. Biol. Chem.* **2004**, *279*, 51057–51067.
  - 16 Rodi, D.J., Janes, R.W., Sanganee, H.J., Holton, R.A., Wallace, B.A., Makowski, L. Screening of a library of phage-displayed peptides identifies human bcl-2 as a taxol-binding protein. *J. Mol. Biol.* **1999**, *285*, 197–203.
  - 17 Von Haefen, C., Wieder, T., Essmann, F., Schulze-Osthoff, K., Dorken, B., Daniel, P.T. Paclitaxel-induced apoptosis in BJAB cells proceeds via a death receptor-independent, caspases-3/-8 driven mitochondrial amplification loop. *Oncogene* **2003**, *22*, 2236–2247.
  - 18 Fan, W. Possible mechanisms of paclitaxel-induced apoptosis. *Biochem. Pharmacol.* **1999**, *57*, 1215–1221.
  - 19 Tudor, G., Aguilera, A., Halverson, D.O., Laing, N.D., Sausville, E.A. Susceptibility to drug-induced apoptosis correlates with differential modulation of Bad, Bcl-2 and Bcl-xL protein levels. *Cell Death Differ.* **2000**, *7*, 574–586.
  - 20 Ding, A., Porteu, F., Sanchez, E., Nathan, C.F. Shared actions of endotoxin and taxol on TNF receptors and TNF release. *Science* **1990**, *248*, 370–372.
  - 21 Croom, E.M., Jr. Taxus for taxol and taxoids. In: Suffness, M. (Ed.), *TAXOL science and applications*. CRC Press, New York, **1995**, pp. 37–70.
  - 22 Kikuchi, Y., Yatagai, M. The commercial cultivation of *Taxus* species and production of taxoids. In: Itokawa, H., Lee, K.-H. (Eds.), *Taxus: The genus Taxus*. Taylor & Francis, London, **2003**, pp. 151–178.
  - 23 Holton, R.A., Somoza, C., Kim, H.-B., Liang, F., Biediger, R.J., Boatman, P.D. First total synthesis of taxol. *J. Am. Chem. Soc.* **1994**, *116*, 1597–1599.
  - 24 Nicolaou, K.C., Yang, Z., Liu, J.J., Ueno, H., Nantermet, P.G., Guy, R.K. Total synthesis of taxol. *Nature* **1994**, *367*, 630–634.
  - 25 Gibson, D.M., Ketchum, R.E.B., Hirasuna, T.J., Shuler, M.L. Potential of plant cell culture for taxane production. In: Suffness, M. (Ed.), *TAXOL science and applications*. CRC Press, New York, **1995**, pp. 71–95.



- 26 Christen, A.A., Gibson, D.M., Bland, J. Production of taxol or taxol-like compounds in cell culture. US Patent 5,019,504, 1991.
- 27 Gibson, D.M., Ketchum, R.E.B., Vance, N.C., Christen, A.A. Initiation and growth of cell lines of *Taxus brevifolia* (Pacific yew). *Plant Cell Rep.* **1993**, *12*, 479–482.
- 28 Kim, J.H., Yun, J.H., Hwang, Y.S., Byun, S.Y., Kim, D.I. Production of taxol and related taxanes in *Taxus brevifolia* cell cultures: Effect of sugar. *Biotechnol. Lett.* **1995**, *17*, 101–106.
- 29 Srinivasan, V., Pestchanker, L., Moser, S., Hirasuna, T.J., Taticek, R.A., Shuler, M.L. Taxol production in bioreactors: Kinetics of biomass accumulation, nutrient uptake, and taxol production by cell suspensions of *Taxus baccata*. *Biotechnol. Bioeng.* **1995**, *47*, 666–676.
- 30 Mirjalili, N., Linden, J.C. Gas phase composition effects on suspension cultures of *Taxus cuspidata*. *Biotechnol. Bioeng.* **1995**, *48*, 123–132.
- 31 Mirjalili, N., Linden, J.C. Methyl jasmonate induced production of taxol in suspension cultures of *Taxus cuspidata*: ethylene interaction and induction models. *Biotechnol. Prog.* **1996**, *12*, 110–118.
- 32 Fett-Neto, A.G., Pennington, J.J., DiCosmo, F. Effect of white light on taxol and baccatin III accumulation in cell cultures of *Taxus cuspidata* Sieb and Zucc. *J. Plant Physiol.* **1995**, *146*, 584–590.
- 33 Ketchum, R.E.B., Gibson, D.M., Croteau, R.B., Shuler, M.L. The kinetics of taxoid accumulation in cell suspension cultures of *Taxus* following elicitation with methyl jasmonate. *Biotechnol. Bioeng.* **1999**, *62*, 97–105.
- 34 Fett-Neto, A.G., Melanson, S.J., Nicholson, S.A., Pennington, J.J., DiCosmo, F. Improved taxol yield by aromatic carboxylic acid and amino acid feeding to cell cultures of *Taxus cuspidata*. *Biotechnol. Bioeng.* **1994**, *44*, 967–971.
- 35 Bringi, V., Kadkade, P. Enhanced production of taxol and taxanes by cell cultures of *Taxus* species. WO patent 93/17121, 1993.
- 36 Choi, H., Kim, S., Son, J., Hong, S., Lee, H., Lee, H. Enhancement of paclitaxel production by temperature shift in suspension culture of *Taxus chinensis*. *Enzyme Microb. Technol.* **2000**, *27*, 593–598.
- 37 Wang, H.Q., Yu, J.T., Zhong, J.J. Significant improvement of taxane production in suspension cultures of *Taxus chinensis* by sucrose feeding strategy. *Proc. Biochem.* **1999**, *35*, 479–483.
- 38 Wang, C., Wu, J., Mei, X. Enhancement of Taxol production and excretion in *Taxus chinensis* cell culture by fungal elicitation and medium renewal. *Appl. Microbiol. Biotechnol.* **2001**, *55*, 404–410.
- 39 Wu, J., Wang, C., Mei, X. Stimulation of taxol production and excretion in *Taxus* spp. cell cultures by rare earth chemical lanthanum. *J. Biotechnol.* **2001**, *85*, 67–73.
- 40 Wickremesinhe, E.R.M., Arteca, R.N. *Taxus* callus cultures: Initiation, growth optimization, characterization and taxol production. *Plant Cell Tiss. Organ Cult.* **1993**, *35*, 181–193.
- 41 Wickremesinhe, E.R.M., Arteca, R.N. *Taxus* cell suspension cultures: optimizing growth and production of taxol. *J. Plant Physiol.* **1994**, *144*, 183–188.
- 42 Yukimune, Y., Tabata, H., Higashi, Y., Hara, Y. Methyl jasmonate-induced overproduction of paclitaxel and baccatin III in *Taxus* cell suspension cultures. *Nat. Biotechnol.* **1996**, *14*, 1129–1132.
- 43 Dewick, P.M. The mevalonate and deoxyxylulose phosphate pathways: terpenoids and steroids. In: *Medicinal Natural Products: A Biosynthetic Approach*, 2nd edition. John Wiley & Sons Ltd, Chichester, UK, **2002**, pp. 167–289.
- 44 Lloyd, G., McCown, B. Commercially feasible micropropagation of mountain laurel, *Kalmia latifolia*, by the use of shoot-tip culture. *Int. Plant Prop. Soc. Proc.* **1981**, *30*, 421–427.
- 45 Gamborg, O.L., Miller, R.A., Ojima, K., Nutrient requirements of suspension cultures of soybean root cells. *Exp. Cell Res.* **1968**, *50*, 151–158.
- 46 Hezari, M., Ketchum, R.E., Gibson, D.M., Croteau, R. Taxol production and taxadiene synthase activity in *Taxus canadensis* cell suspension cultures. *Arch. Biochem. Biophys.* **1997**, *337*, 185–190.
- 47 Tabata, H. Paclitaxel production by plant-cell-culture technology. *Adv. Biochem. Eng./Biotechnol.* **2004**, *87*, 1–23.
- 48 Tabata, H., Higashi, Y. Taxol production by plant cell culture technology. *Catalysis Catalysis* **2001**, *43*, 207–211 (in Japanese).

- 49 Eisenreich, W., Menhard, B., Hylands, P.J., Zenk, M.H., Bacher, A. Studies on the biosynthesis of taxol: the taxane carbon skeleton is not of mevalonoid origin. *Proc. Natl. Acad. Sci. USA* **1996**, *93*, 6431–6436.
- 50 Zheng, Q.P., Yu, L.J., Liu, Z., Li, M.Y., Xiang, F., Yang, Q. Cloning and analysis of cDNA encoding key enzyme gene (dxr) of the non-MVA pathway in *Taxus chinensis* cells. *Sheng Wu Gong Cheng Xue Bao* **2004**, *20*, 548–553 (in Chinese).
- 51 Jennewein, S., Wildung, M.R., Chau, M., Walker, K., Croteau, R. Random sequencing of an induced *Taxus* cell cDNA library for identification of clones involved in Taxol biosynthesis. *Proc. Natl. Acad. Sci. USA* **2004**, *101*, 9149–9154.
- 52 Hefner, J., Ketchum, R.E., Croteau, R. Cloning and functional expression of a cDNA encoding geranylgeranyl diphosphate synthase from *Taxus canadensis* and assessment of the role of this prenyltransferase in cells induced for taxol production. *Arch. Biochem. Biophys.* **1998**, *360*, 62–74.
- 53 Okada, K., Saito, T., Nakagawa, T., Kawamukai, M., Kamiya, Y. Five geranylgeranyl diphosphate synthases expressed in different organs are localized into three subcellular compartments in *Arabidopsis*. *Plant Physiol.* **2000**, *122*, 1045–1056.
- 54 Wildung, M.R., Croteau, R. A cDNA clone for taxadiene synthase, the diterpene cyclase that catalyzes the committed step of taxol biosynthesis. *J. Biol. Chem.* **1996**, *271*, 9201–9204.
- 55 Lesburg, C.A., Zhai, G., Cane, D.E., Christianson, D.W. Crystal structure of pentalenene synthase: mechanistic insights on terpenoid cyclization reactions in biology. *Science* **1997**, *277*, 1820–1824.
- 56 Tarshis, L.C., Yan, M., Poulter, C.D., Sacchettini, J.C. Crystal structure of recombinant farnesyl diphosphate synthase at 2.6-Å resolution. *Biochemistry* **1994**, *33*, 10871–10877.
- 57 Li, S.H., Zhan, H.J., Yao, P., Niu, X.M., Xiang, W., Sun, H.D. Non-taxane compounds from the bark of *Taxus yunnanensis*. *J. Asian Nat. Prod. Res.* **2002**, *4*, 147–154.
- 58 Monacelli, B., Pasqua, G., Botta, B., Vinciguerra, V., Gacs-Baitz, E., Monache, G.D. Abietane diterpenoids from callus cultures of *Taxus baccata*. *Planta Med.* **2002**, *68*, 764–766.
- 59 Bai, J., Kitabatake, M., Toyozumi, K., Fu, L., Zhang, S., Dai, J., Sakai, J., Hirose, K., Yamori, T., Tomida, A., Tsuruo, T., Ando, M. Production of biologically active taxoids by a callus culture of *Taxus cuspidata*. *J. Nat. Prod.* **2004**, *67*, 58–63.
- 60 Jennewein, S., Long, R.M., Williams, R.M., Croteau, R. Cytochrome p450 taxadiene 5 $\alpha$ -hydroxylase, a mechanistically unusual monooxygenase catalyzing the first oxygenation step of taxol biosynthesis. *Chem. Biol.* **2004**, *11*, 379–387.
- 61 Schoendorf, A., Rithner, C.D., Williams, R.M., Croteau, R.B. Molecular cloning of a cytochrome P450 taxane 10 $\beta$ -hydroxylase cDNA from *Taxus* and functional expression in yeast. *Proc. Natl. Acad. Sci. USA* **2001**, *98*, 1501–1506.
- 62 Chau, M., Croteau, R. Molecular cloning and characterization of a cytochrome P450 taxoid 2 $\alpha$ -hydroxylase involved in Taxol biosynthesis. *Arch. Biochem. Biophys.* **2004**, *427*, 48–57.
- 63 Jennewein, S., Rithner, C.D., Williams, R.M., Croteau, R.B. Taxol biosynthesis: taxane 13 $\alpha$ -hydroxylase is a cytochrome P450-dependent monooxygenase. *Proc. Natl. Acad. Sci. USA* **2001**, *98*, 13595–13600.
- 64 Chau, M., Jennewein, S., Walker, K., Croteau, R. Taxol biosynthesis: Molecular cloning and characterization of a cytochrome P450 taxoid 7 $\beta$ -hydroxylase. *Chem. Biol.* **2004**, *11*, 663–672.
- 65 Walker, K., Schoendorf, A., Croteau, R. Molecular cloning of a taxa-4(20),11(12)-dien-5 $\alpha$ -ol-O-acetyl transferase cDNA from *Taxus* and functional expression in *Escherichia coli*. *Arch. Biochem. Biophys.* **2000**, *374*, 371–380.
- 66 Walker, K., Croteau, R. Molecular cloning of a 10-deacetylbaccatin III-10-O-acetyl transferase cDNA from *Taxus* and functional expression in *Escherichia coli*. *Proc. Natl. Acad. Sci. USA* **2000**, *97*, 583–587.
- 67 Walker, K., Croteau, R. Taxol biosynthesis: molecular cloning of a benzoyl-CoA:taxane 2 $\alpha$ -O-benzoyltransferase cDNA from *Taxus* and functional expression in *Escherichia coli*. *Proc. Natl. Acad. Sci. USA* **2000**, *97*, 13591–13596.

- 68 Jennewein, S., Rithner, C.D., Williams, R.M., Croteau, R. Taxoid metabolism: Taxoid 14 $\beta$ -hydroxylase is a cytochrome P450-dependent monooxygenase. *Arch. Biochem. Biophys.* **2003**, 413, 262–270.
- 69 Walker, K.D., Klettke, K., Akiyama, T., Croteau, R. Cloning, heterologous expression, and characterization of a phenylalanine aminomutase involved in Taxol biosynthesis. *J. Biol. Chem.* **2004**, 279, 53947–53954.
- 70 Long, R.M., Croteau, R. Preliminary assessment of the C13-side chain 2'-hydroxylase involved in Taxol biosynthesis. *Biochem. Biophys. Res. Commun.* **2005**, 338, 410–417.
- 71 Walker, K., Fujisaki, S., Long, R., Croteau, R. Molecular cloning and heterologous expression of the C-13 phenylpropanoid side chain-CoA acyltransferase that functions in Taxol biosynthesis. *Proc. Natl. Acad. Sci. USA* **2002**, 99, 12715–12720.
- 72 Walker, K., Long, R., Croteau, R. The final acylation step in taxol biosynthesis: cloning of the taxoid C13-side-chain N-benzoyltransferase from *Taxus*. *Proc. Natl. Acad. Sci. USA* **2002**, 99, 9166–9171.
- 73 Mukherjee, S., Ghosh, B., Jha, S. Establishment of forskolin yielding transformed cell suspension cultures of *Coleus forskohlii* as controlled by different factors. *J. Biotechnol.* **2000**, 76, 73–81.
- 74 Chen, H., Yuan, J.P., Chen, F., Zhang, Y.L., Song, J.Y. Tanshinone production in Ti-transformed *Salvia miltiorrhiza* cell suspension cultures. *J. Biotechnol.* **1997**, 58, 147–156.
- 75 Bauer, N., Leljak-Levanic, D., Jelaska, S. Rosmarinic acid synthesis in transformed callus culture of *Coleus blumei* benth. *Z. Naturforsch. C* **2004**, 59, 554–560.
- 76 Giri, A., Giri, C.C., Dhingra, V., Narasu, M.L. Enhanced podophyllotoxin production from *Agrobacterium rhizogenes* transformed cultures of *Podophyllum hexandrum*. *Nat. Prod. Lett.* **2001**, 15, 229–235.
- 77 Yoshimatsu, K., Shimomura, K. Isoquinoline alkaloid production by transformed cultures of *Papaver somniferum*. *Kokuritsu Iyakuhin Shokuhin Eisei Kenkyusho Hokoku* **2001**, 119, 52–56.
- 78 Shu, W., Yoshimatsu, K., Yamaguchi, H., Shimomura, K. High production of ginsenosides by transformed root cultures of *Panax ginseng*: effect of basal medium and *Agrobacterium rhizogenes* strains. *Kokuritsu Iyakuhin Shokuhin Eisei Kenkyusho Hokoku* **1999**, 117, 148–154.
- 79 Han, K.H., Fleming, P., Walker, K., Loper, M., Chilton, W.S., Mocek, U., Gordon, M.P., Floss, H.G. Genetic transformation of mature *Taxus*: an approach to genetically control the in vitro production of the anticancer drug, taxol. *Plant Sci.* **1994**, 95, 187–196.
- 80 Matsubayashi, Y., Sakagami, Y. Phytosulfokine, sulfated peptides that induce the proliferation of single mesophyll cells of *Asparagus officinalis* L. *Proc. Natl. Acad. Sci. USA* **1996**, 93, 7623–7627.
- 81 Matsubayashi, Y., Hanai, H., Hara, O., Sakagami, Y. Active fragments and analogs of the plant growth factor, phytosulfokine: structure-activity relationships. *Biochem. Biophys. Res. Commun.* **1996**, 225, 209–214.
- 82 Yang, H., Matsubayashi, Y., Nakamura, K., Sakagami, Y. *Oryza sativa* PSK gene encodes a precursor of phytosulfokine- $\alpha$ , a sulfated peptide growth factor found in plants. *Proc. Natl. Acad. Sci. USA* **1999**, 96, 13560–13565.
- 83 Matsubayashi, Y., Takagi, L., Sakagami, Y. Phytosulfokine- $\alpha$ , a sulfated pentapeptide, stimulates the proliferation of rice cells by means of specific high- and low-affinity binding sites. *Proc. Natl. Acad. Sci. USA* **1997**, 94, 13357–13362.
- 84 Tabata, H., Hara, Y. Prevention of browning of plant cultured cell. JP patent 11/196863, **1999**.
- 85 Kwon, T.H., Seo, J.E., Kim, J., Lee, J.H., Jang, Y.S., Yang, M.S. Expression and secretion of the heterodimeric protein interleukin-12 in plant cell suspension culture. *Biotechnol. Bioeng.* **2003**, 81, 870–875.
- 86 Fischer, R., Liao, Y.C., Drossard, J. Affinity-purification of a TMV-specific recombinant full-size antibody from a transgenic tobacco suspension culture. *J. Immunol. Methods* **1999**, 226, 1–10.
- 87 Gomord, V., Faye, L. Posttranslational modification of therapeutic proteins in plants. *Curr. Opin. Plant Biol.* **2004**, 7, 171–181.

## 23

**Biological Production of Artemisinin for Malaria Therapy**

*Yan Zhao and Chunzhao Liu*

## 23.1

**Introduction**

Malaria, one of the most common diseases in tropical countries, afflicts over 500 million people worldwide each year, and is responsible for more than one million deaths. The widespread resistance of *Plasmodium falciparum* to quinoline-based drugs has made the disease difficult to manage, the key problem being an ability to acquire an effective treatment. Today, however, artemisinin – which is derived from a Chinese medicinal plant, *Artemisia annua* L. – has become increasingly popular as an effective and safe alternative therapy against malaria [1]. Molecular structural studies have revealed artemisinin to be a sesquiterpene lactone that was notably unusual in that it contains an endoperoxide moiety (Fig. 23.1). Artemisinin and its derivatives are effective against multidrug-resistant *P. falciparum* strains, mainly in south-east Asia and more recently in Africa, with no reported cases of resistance to date [2].

Artemisinin acts rapidly at the asexual reproductive stages of *P. falciparum*, when the parasite is in its most malignant form. Because of an emerging resistance of *P. falciparum* to conventional antimalarial drugs (e.g., quinine, chloroquine), sub-Saharan Africa stands at the edge of a shift in the treatment of malaria, with artemisinin-based combination therapy (ACT) being increasingly advocated as the way forward. Currently, three ACTs are considered as realistic for widespread use, namely (i) artesunate plus amodiaquine; (ii) artemether-lumefantrine (AL); and (iii) artesunate plus sulfadoxinepyrimethamine [3].

Currently, a clear understanding of artemisinin's mechanism of action is an ongoing subject. The specific reaction of artemisinin with translationally controlled tumor protein (TCTP), inhibition of the sarco-/endoplasmic reticulum  $\text{Ca}^{2+}$ -ATPase (SERCA) orthologue (PfATP6) of *P. falciparum*, and inhibition of *P. falciparum* cysteine proteases each having been proposed as contributing towards the drug's antimalarial activity [4, 5]. Artemisinin has been shown selectively to kill cancer cells. Indeed, in a recent study a combination of dihydroartemisinin (DHA, an artemisinin analogue) and butyric acid at low doses proved highly effective at

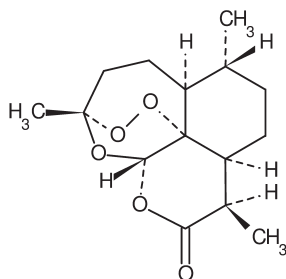


Fig. 23.1 The chemical structure of artemisinin.

killing cancer cells, thereby offering less-toxic, inexpensive and effective cancer chemotherapy [6].

*Artemisia annua*, which belongs to the Asteraceae family, is an annual herb that grows naturally as a part of steppe vegetation in northern regions of China at 1000–1500 m above sea level [7]. The plant is single-stemmed, has alternate branches, and reaches more than 2 m in height. The isolation and characterization of artemisinin from *A. annua* is considered to be one of the most novel discoveries in recent medicinal plant research [8] such that, today, artemisinin and its derivatives are considered by the World Health Organization (WHO) to be part of the ideal strategy for malaria in Africa. Because artemisinin production via organic synthesis is very complicated, with low yields and high cost [9], many research groups have focused their attention on enhancing the production of artemisinin in cell/tissue culture or whole plants of *A. annua*. In addition, recent efforts to produce artemisinin have included the use of recombinant bacteria and fermentation.

## 23.2

### The Biosynthesis of Artemisinin

Artemisinin is an endoperoxide sesquiterpene lactone which belongs to the isoprenoid group of compounds. The isoprenoid pathway is one of the most important biosynthetic pathways in plants, and although the complete biosynthetic pathway of artemisinin has not been established, some biosynthetic steps have been elucidated, both *in vitro* and *in vivo*. In 1987, Akhila et al. [10] proposed a complete biosynthetic pathway for artemisinin, starting from mevalonic acid and isopentenyl pyrophosphate (IPP). The following biosynthetic pathway was suggested: farnesylpyrophosphate (FPP) → germacrane skeleton → dihydrocostunolide → cadinanolide → arteannuin B → artemisinin. Since, in *A. annua*, the content of artemisinic acid is eight- to tenfold that of artemisinin, it has been suggested that artemisinic acid might be a possible biosynthetic precursor for both arteannuin B and artemisinin. Sangwan et al. [11] reported the transformation of artemisinic acid to arteannuin B and artemisinin both *in vivo* and in a cell-free system, while others converted artemisinic acid to artemisinin B by single oxygen generated through sensitized photo-oxygenation [12]. Wallaart et al. [13, 14] isolated dihydroartemisinic acid and dihydroartemisinic acid hydroperoxide in *A. annua*, with yields of 66%

and 29%, respectively. Dihydroartemisinic acid could be chemically converted to artemisinin under conditions that also may be present in the living plant. The presence of dihydroartemisinic acid hydroperoxide and dihydroartemisinic acid in the plant and the conditions under which dihydroartemisinic acid can be converted into dihydroartemisinic acid hydroperoxide (which can very easily be oxidized to artemisinin) provide evidence for a nonenzymatic, photochemical conversion of dihydroartemisinic acid into artemisinin.

Recently, a reasonably clear picture of artemisinin biosynthesis has emerged, as shown schematically in Figure 23.2. The identity of amorpha-4,11-diene as a biosynthetic intermediate was established, based on the presence of traces of amorpha-4,11-diene in *A. annua* extracts, and the cloning and expression of cDNA representing amorpha-4,11-diene synthase. Berteau et al. [15] identified intermediates and enzymes involved in the biosynthesis of artemisinin in *A. annua*; these authors hypothesized that the early steps in artemisinin biosynthesis involved amorpha-4, 11-diene hydroxylation to artemisinic alcohol, followed by oxidation to artemisinic aldehyde, reduction of the C11–C13 double bond to dihydroartemisinic aldehyde, and oxidation to dihydroartemisinic acid. A cDNA clone encoding a cytochrome P450, a multifunctional sesquiterpene oxidase, designated CYP71AV1, was characterized to catalyze the oxidation of the biosynthetic intermediates amorpha-4, 11-diene, artemisinic alcohol and artemisinic aldehyde in 2006 [16].

## 23.3

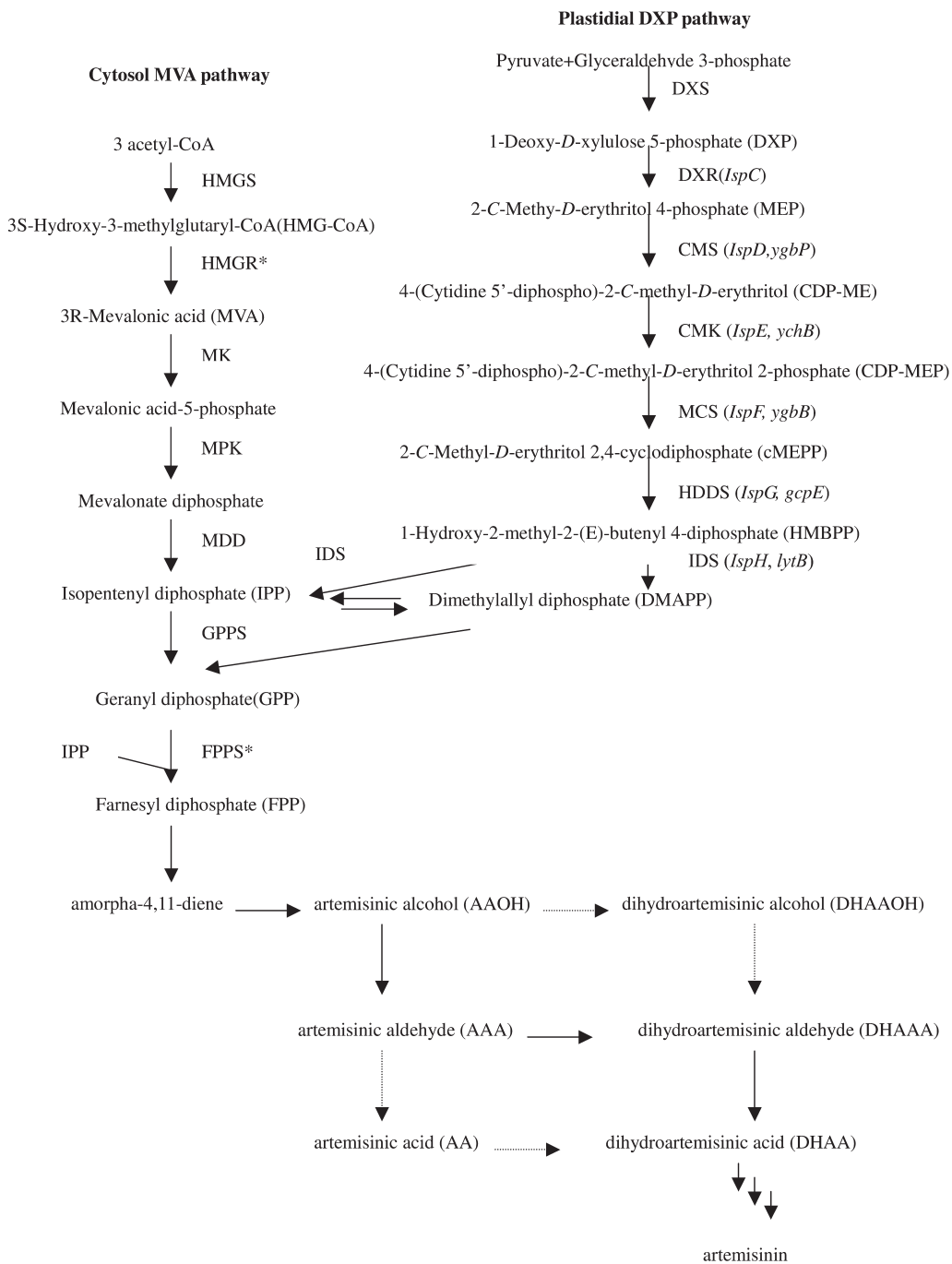
### The Biological Production of Artemisinin

#### 23.3.1

##### Artemisinin Production by Plants

The commercial sources of most artemisinin are from the field-grown leaves and flowering tops of *A. annua*. The production of artemisinin is subject to seasonal and somatic variation, in addition to infestations by bacteria, fungi and insects that can each affect the functional medicinal content of the plant [17, 18]. The total organic synthesis is very complicated, has low yields, and is therefore economically unattractive [19, 20]. In view of these problems, artemisinin production using *in-vitro* plant tissue culture has been considered an interesting alternative, and the biosynthesis of artemisinin *in-vitro* was subsequently detected in callus, suspension cells, shoot, and hairy root cultures [21–27].

A certain degree of differentiation is necessary for the biosynthesis of artemisinin in *A. annua*. No artemisinin was detected in cell suspension cultures of *A. annua*, whereas trace amounts were found in the multiple shoot cultures [28]. Woerdenbag et al. [29] reported a high percentage of artemisinin content in *A. annua* shoots cultured on 1/2 MS medium supplemented with 0.05 mg L<sup>-1</sup> naphthalene acetic acid (NAA), 0.2 mg L<sup>-1</sup> benzyl adenine (BA) and 2% sucrose. The flowering of *A. annua* was observed *in vitro* by supplementing with gibberellic acid (GA<sub>3</sub>), whereby the artemisinin content reached 0.1% in *A. annua* plantlets, with the



**Fig. 23.2** The proposed pathway of artemisinin biosynthesis. CMK: 4-(cytidine 5'-diphospho)-2-C-methyl-D-erythritol kinase; CMS: 2-C-methyl-D-erythritol 4-phosphate cytidyl transferase; DXR: 1-deoxy-D-xylulose 5-phosphate reductoisomerase; DXS: 1-deoxy-D-xylulose 5-phosphate synthase; FDS: farnesyl diphosphate synthetase; GPPS: geranyl diphosphate synthase; HMGR: 3-hydroxy-3-meth-

ylglutaryl coenzyme A (HMG-CoA) reductase; HMGS: HMG-CoA synthase; IDS: isopentenyl diphosphate synthase; MCS: 2-C-methyl-D-erythritol 2,4-cyclodiphosphate synthase; MDD: mevalonate diphosphate decarboxylase; MK: mevalonate kinase; MPK: mevalonate-5-phosphate kinase; SES: sesquiterpene synthase.



highest content being observed in plantlets while in full bloom [30]. In general, artemisinin was not detected in the root parts of the *A. annua* plant, though removal of the roots from *A. annua* plants was shown to reduce the artemisinin content [31, 32].

Attempts were also made to improve artemisinin production by optimizing the chemical and physical environmental factors. The ratio of  $\text{NO}_3/\text{NH}_4$  and total initial nitrogen concentration influenced the artemisinin yield of hairy roots [33]. Typically, with a  $\text{NO}_3/\text{NH}_4$  ratio of 5:1 (w/w), the optimum concentration of total nitrogen for artemisinin production was 20 mM. At this concentration, artemisinin production was 57% higher than in the standard MS medium. The growth of hairy roots in the medium containing sucrose ( $3.99 \text{ g L}^{-1}$  dry weight) was equivalent to that in a medium containing fructose ( $3.75 \text{ g L}^{-1}$  dry weight), and significantly better than in a glucose-containing medium ( $2.16 \text{ g L}^{-1}$  dry weight). Moreover, the hairy roots grown in glucose showed a dramatic stimulation in artemisinin content which was threefold and twofold higher than in media containing sucrose or fructose, respectively [34]. A combination of BA and kinetin (KT) increased the yields of artemisinin in shoots *in vitro* by 3.6- and 2.6-fold, respectively [35].  $\text{GA}_3$ , a plant hormone that can induce blooming, has been reported to improve growth and artemisinin biosynthesis in shoot cultures, root cultures and plantlets of *A. annua* [36–39]. Liu et al. monitored the effects of light irradiation on growth and artemisinin production of hairy root cultures of *A. annua* L. [40]. These authors found that an illumination of 3000 Lux for 16 h (using cool-white fluorescent lamps) led to the hairy root cultures producing  $13.8 \text{ g L}^{-1}$  dry weight, and a concentration of  $244.5 \text{ mg L}^{-1}$  artemisinin. Likewise, the group of Wang et al. [41] also showed that light conditions could influence the biomass and artemisinin content of hairy root cultures, with the highest biomass ( $5.73 \text{ g L}^{-1}$  dry weight) and artemisinin content ( $31 \text{ mg g}^{-1}$ ) being obtained under red light (wavelength 660 nm); these values were, respectively, 17% and 67% higher than those obtained under white light. Temperature effect on growth and artemisinin biosynthesis in cultured *A. annua* L. hairy roots was investigated over a range of 15 to  $35^\circ\text{C}$  by Guo et al. [42]; maximum growth was found to occur at  $25^\circ\text{C}$ , though the highest artemisinin content was observed at  $30^\circ\text{C}$ .



Although the relatively low yield (0.01–0.6%) of artemisinin in *A. annua* greatly limits the commercialization of the drug, alternative approaches such as chemosynthesis, conventional breeding of high artemisinin-yielding plants and selection techniques have not been successful. During recent years, much progress has been made in the molecular regulation of artemisinin biosynthesis [43], notably in the production of transgenic plants of *A. annua*, thereby ensuring a consistently high production of artemisinin by overexpression of enzymes in the terpene biosynthetic pathway, or by inhibiting an enzyme of another pathway competing for artemisinin precursors. The genes of the key enzymes involved in the biosynthesis of artemisinin, such as farnesyldiphosphate synthase (FDS), amorpha-4,11-diene synthase (AMDS), and those of the enzymes relevant to the biosynthesis of artemisinin (including squalene synthase; SQS) have been cloned from *A. annua* [44–47]. The enzyme involved in the biochemical transformation of arteannuin B to artemisinin was purified by Dhingra and Narasu [48]. By using genetic engineering, it is possible to overexpress the key enzymes involved in the biosynthesis of artemisinin, and in this way its production could be significantly enhanced in a transgenic, high-yield *A. annua*. The development of a new strain of *A. annua* which had been genetically engineered for increased production of artemisinin, yet could be grown as a cropping plant in areas where the drug was required, would be of great value.

In 1994, hairy root was induced from *A. annua* with *Agrobacterium rhizogenes* [49,50]; furthermore, the factors influencing *A. rhizogenes* were optimized in the transformation system, and a clone with high artemisinin content of 1.195 mg g<sup>-1</sup> dry weight was obtained [51, 52]. In 1996, Vergauwe et al. [53] developed an *Agrobacterium tumefaciens*-mediated transformation system for *A. annua* L. plants with high transformation rates. The artemisinin content in the leaves of the regenerated plant was 0.17% dry weight, slightly higher than that present in the leaves of normally cultured plants (0.11% dry weight). In 1998, the same group investigated the factors influencing *A. tumefaciens*-mediated transformation of *A. annua*, including the age of the explant, the *A. tumefaciens* strain, and the plant genotype [54]. In 2005, Han et al. [55] established a system of higher efficiency of genetic transformation and regeneration of *A. annua* via *A. tumefaciens*. The factors investigated included the composition of the infecting bacterium suspension, methods of co-cultivation, and the co-cultivation period. By optimizing the transformation system, the transgenic frequency of fascicled shoots reached 4 to 10%. In 1999, Chen et al. [56] reported the transference of a green fluorescent protein (GFP) reporter gene into *A. annua* with *A. tumefaciens* and the regeneration of transgenic plants. These authors found that artemisinin production by shoot cultures induced from flower organ explants was twofold that from the leaves [57].

Artemisinic acid, which has a cadinene structure, is a precursor of artemisinin. In 1998, Chen et al. [58] transformed a cotton cadinene synthase cDNA into the leaf explants of *A. annua* using *A. rhizogenes*, and showed artemisinin accumulation to be enhanced in the transgenic plantlets. In the isoprenoid biosynthesis pathway, farnesyl diphosphate synthase (FDS) catalyzes the condensation of IPP with dimethylallyl diphosphate (DMAPP) [59]. Recently, cDNAs encoding FDS have been

isolated from a number of plant species, including *Arabidopsis thaliana* [60] and *Lupinus albus* [61]. Because 15-carbon FPP can be catalyzed by sesquiterpene cyclases to form cyclic sesquiterpenoids, the overexpression of FDS by the introduction of a foreign gene into *A. annua* provides the possibility of enhancing the accumulation of artemisinin. A cDNA encoding cotton FDS placed under a CaMV 35S promoter was transferred into *A. annua* via *A. tumefaciens* strain LBA 4404 or *A. rhizogenes* strain ATCC 15834 by Chen et al. [62]. In the transgenic plants, the concentration of artemisinin was approximately 8–10 mg g<sup>-1</sup> dry weight, which was about two- to threefold higher than that in the control.

### 23.3.2

#### Artemisinin Production by Microorganisms

Because plant tissue extractions typically yield low terpenoid concentrations, many research groups have sought alternative methods to produce terpenoid compounds in a microbial host. Several have described engineering of the 1-deoxy-D-xylulose 5-phosphate (DXP) pathway to increase the supply of isoprenoid precursors needed for high-level production of carotenoids in *Escherichia coli* [63–65]. Balancing the pool of glyceraldehyde-3-phosphate and pyruvate, or increasing the expression of 1-deoxy-D-xylulose 5-phosphate synthase (DXS; encoded by the gene *dxs*) and IPP isomerase (encoded by *idi*), resulted in an increased carotenoid build-up in the cell. Martin et al. [66] engineered the expression of a synthetic amorpha-4,11-diene synthase gene and the mevalonate isoprenoid pathway from *Saccharomyces cerevisiae* in *E. coli*. Concentrations of amorphadiene, the sesquiterpene olefin precursor of artemisinin, reached 24 µg caryophyllene equivalent mL<sup>-1</sup>. Although the total biosynthesis of artemisinin was not achieved, the engineered biochemical pathway could be extended to produce artemisinic acid which could then be converted easily to artemisinin by chemical synthesis. The simultaneous expression of a synthetic amorphadiene synthase gene in the engineered strain resulted in high-level production of amorphadiene and alleviated growth inhibition. Because IPP and DMAPP are the universal precursors to all isoprenoids, the strains reported could serve as platform hosts for the production of any terpenoid compound for which the biosynthetic genes are available.

In order to develop more potent antimalarial agents with improved stability, tremendous efforts have been made towards structure modification of artemisinin and analogue synthesis. Due to the difficulties of structural modification by conventional chemical methods, microbial transformation may serve as a valuable tool and, to date, a number of oxidating products of artemisinin at different positions of artemisinin structure have been reported. These transformations include conversion to 3 $\alpha$ -hydroxy-deoxyartemisinin and deoxyartemisinin; conversion to 9 $\beta$ -hydroxy-artemisinin and 3 $\alpha$ -hydroxy-artemisinin; and conversion to 10-hydroxy-artemisinin and 9 $\beta$ -hydroxy-11 $\alpha$ -artemisinin. In addition, microbial transformations on artemisinin analogues, such as artemether, arteether, artemisitene, and 12-deoxyartemisinin, have been reported to produce oxidative products by different microorganisms [67].

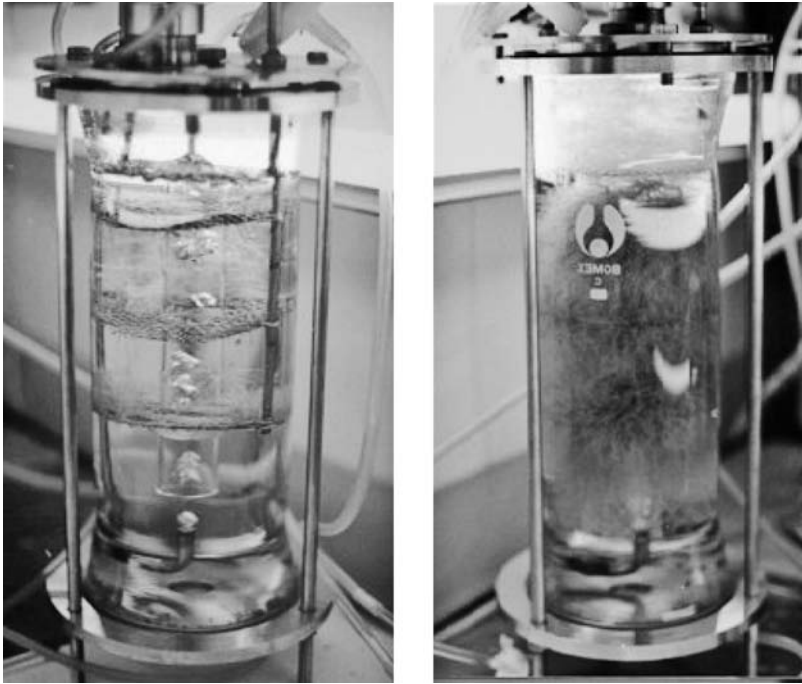
## 23.3.3

**Artemisinin Production in Bioreactors**

Bioreactor technology is regarded as a key factor for the realization of commercial production of phytochemicals from *in-vitro* plant tissue cultures [68]. It is necessary to select a bioreactor configuration that will provide adequate biological requirements and engineering needs for large-scale plant cell culture. Recent studies on the production of artemisinin by hairy roots and shoots of *A. annua* L. in bioreactor systems will be outlined in this section.

Hairy root cultures provide a very promising alternative to the biotechnological exploitation of plant cell cultures. Their characteristic capacity for secondary metabolite production, inherent genetic stability reflected in stable productivity, and the possibility of genetic manipulation to increase biosynthetic capacity have initiated considerable interest, both as a fundamental research tool and as a source of valuable products. Owing to the unique configuration of hairy roots with their branching nature, one of the most important limitations for the commercial exploitation of hairy roots is the development of technologies for large-scale culture. In this respect, some specific engineering aspects of bioreactor design should be considered, including a support matrix to support the roots, protection from shear stress, homogeneous growth distribution, and oxygen transfer enhancement in the root matrix.

In 1998, our research group developed several different types of bioreactor to produce artemisinin from *A. annua* L. hairy roots, and compared root growth and artemisinin accumulation in the bubble column, modified bubble column, and modified inner-loop airlift bioreactor with three stainless steel meshes with 2-mm pore size fixed along the height of the column [69]. Experimental results showed that the hairy root cultures in the modified inner-loop airlift bioreactor grew more homogeneously between the two meshes than those in other bioreactors. The growth rate of the hairy roots and productivity of artemisinin were higher than those in flasks. For hairy root culture of *A. annua* L., the modified airlift bioreactor can improve the transfer of nutrient medium and supply of oxygen, and increase the homogeneity of hairy root growth [70]. In the bioreactor, hairy root cultures were progressively attached to each mesh and grew homogeneously in all directions, such that the bioreactor was full after 20 days (Fig. 23.3). The optimum operational conditions are important for hairy root cultures of *A. annua* L. in bioreactors, as they influence the growth rate, the maximum biomass, and artemisinin production. In the airlift bioreactor, the volumetric gas flow rate is a particularly important parameter affecting oxygen transfer rates, degree of turbulence, and broth recirculation rates. The biomass formation and artemisinin accumulation of *A. annua* L. hairy root was increased in line with increases in air flow rate. A maximum artemisinin production of 557 mg L<sup>-1</sup> in *A. annua* L. hairy root cultures was achieved after 20 days at an optimum air flow rate of 3.0 dm<sup>3</sup> min<sup>-1</sup> under light irradiation (16 h day<sup>-1</sup>) and temperature 28 °C. The increase in air flow rate in the bioreactor improves transfer of the nutrient medium and supply of oxygen within the dense hairy root cultures, and thereby enhances the growth and artemisinin production of *A. annua* L. hairy root cultures. Kim et al. [71] also reported a higher



**Fig. 23.3** A modified airlift bioreactor for artemisinin production from *A. annua* L. hairy root culture. Note: A color version of this figure is available in the color plate section.

artemisinin content of *A. annua* L. hairy roots in mist reactors than in bubble column reactors, due to increased oxygen availability.

Recently, Weathers' research group developed a nutrient mist bioreactor using ultrasonic transducers that produced almost three times as much artemisinin as hairy roots grown in bubble column bioreactors [72,73]. In order to improve the artemisinin content, the mist cycle, carrier gas, and nutrient compositions were optimized. In 2003, Souret et al. [74] investigated the expression levels of four key terpenoid biosynthetic genes – HMGR, DXS, DXR, and FDS (see Fig. 23.2) – in a mist reactor, though a combination of multiple factors was also involved. In fact, a combination of multiple factors, including environment, development, and metabolic situations, was found to affect gene expression. This emphasized the need to use genomic and proteomic tools to provide a more rapid and global survey of genes relevant to the scale-up of *in-vitro* cultures to reactors.

#### 23.3.3.1 Production of Artemisinin from *A. annua* L. Shoots in a Nutrient Mist Bioreactor

Some experimental bioreactors for shoot cultures have been developed with the aim of reducing production costs while maximizing plant growth. However, the

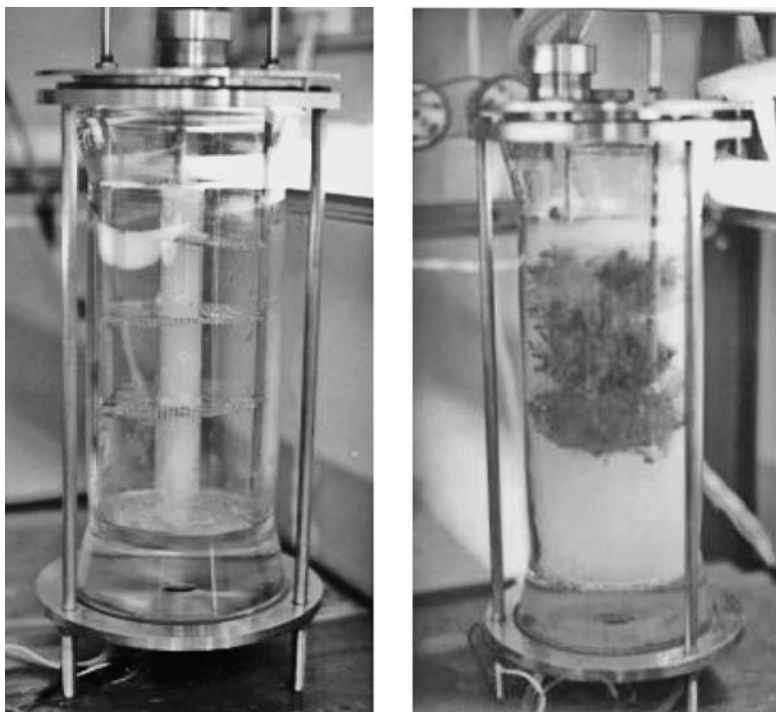
use of bioreactors for large-scale cultivation has been limited due to high costs and abnormal shoot morphogenesis associated with liquid culture. Most shoot cultures are sensitive to shearing stress, and tend towards vitrification when in liquid culture over a prolonged period [75, 76]. Since its first development, the ultrasonic nutrient mist culture system has been the subject of numerous studies. Compared to a culture in a solid medium, the mist system has several potential advantages, most notably improved diffusion of gas and nutrients, as well as superior absorption of nutrients by the plant tissues.

A nutrient mist bioreactor was developed for shoot cultures of *A. annua* L., which incorporated a fine distribution of mist, an increased utilization rate of bioreactor space, and an ability to separate the mist generation and aeration process [77]. In the bioreactor, the mist flux mainly arises along the concentric draught-tube, but then overflows the top and holes of the draught-tube and passes down along the annulus. After 2 min, the nutrient mist was seen to fill the bioreactor, but when the mistifier was switched off the mist became thinner and disappeared within 5 min. Increased intensity and improved homogeneity of the nutrient mist were obtained without the air supply during misting periods. During the intervals without mist, the air supply could satisfy the requirements of the shoot culture, while the loss of nutrient mist caused by the air entrainment was avoided by separating the mist generation and aeration processes.

The growth of shoots was improved significantly in the bioreactor when the liquid nutrient was converted to the mist form and subsequently delivered efficiently to each part of the shoot culture. Serious vitrification of the shoot cultures was avoided because they were exposed directly to gas phase in the nutrient mist bioreactor. In the mist bioreactor, the misting cycle (the time of misting ON, followed by time of misting OFF) is a key parameter affecting nutrient supply, environmental humidity and oxygen transfer rate. A misting cycle of 3:90 (min:min) proved to be more effective than other cycles for obtaining maximum growth and artemisinin production of shoot cultures of *A. annua* L.. Simply increasing the mist duty cycle actually reduced the reactor performance. Artemisinin production reached 48.2 mg L<sup>-1</sup> after 25 days in the mist bioreactor which provided an excellent gas phase environment, lesser physical stress, and sufficient nutrient supply for both shoot growth and artemisinin biosynthesis (Fig. 23.4).

The importance of the mist reactor may lie not in absolute biomass production, but rather in providing a reactor environment that stimulates specific secondary metabolite production. Artemisinin is a sesquiterpene lactone endoperoxide found mainly in the aerial parts of *A. annua* plants, and contains the therapeutically active endoperoxide bridge. The biosynthesis of artemisinin requires a considerable involvement of oxygen, and its greater production by *A. annua* L. shoot cultures in the nutrient mist bioreactor may, in part, be due to improved oxygen availability. These results not only provide a potential alternative for artemisinin production by shoot cultures of *A. annua* L. in bioreactor systems, but also permit the rapid mass propagation of individual plant selections in an effective reactor system.

The relatively low yield (0.01–0.8%) of artemisinin in *A. annua* represents a serious limitation to the commercialization of the drug, and consequently an en-



**Fig. 23.4** A nutrient mist bioreactor for artemisinin production from *A. annua* L. shoot cultures. Note: A color version of this figure is available in the color plate section.

hanced production of artemisinin, either in cell/tissue/organ culture or in the whole plant, would be highly desirable. Hence, the large-scale cultivation of *A. annua* L. tissues in a bioreactor system, in combination with genetic engineering tools to overexpress artemisinin biosynthesis, should open up a bright future for artemisinin production.

#### **23.4 Outlook**

During the past 25 years or so, a number of significant advances have been made in the control of malaria, with the discovery of artemisinin and its analogues as potent anti-malarial agents being of major importance [78]. Hence, numerous investigations are currently being aimed at elucidating the drug's mechanism of action, at determining its efficient clinical use, and at discovering new drugs with even better pharmacological properties [79]. Many advances have also recently been made in identifying molecular markers for predicting *in-vitro* and *in-vivo* resistance to malaria in south-east Asia [80]. Artemisinin-based combination therapies are

much more expensive than the older drugs, due mainly to the relatively low yields of the drug from *A. annua*. Hence, much effort has been made to enhance the production of artemisinin, both *in vivo* and *in vitro*, by the use of biotechnology. Although viable methods of increasing artemisinin contents (e.g., *A. annua* organ culture, hormone medium and metabolic manipulation) have been investigated – and indeed have shown potential for future development – none of the improvements delivered by these methods has yet proved sufficient to meet demands. In order to increase the yield of artemisinin by biotechnological means, it is necessary first to study the relevant enzymatic pathway, and enzymes and precursors involved in artemisinin biosynthesis must be isolated and characterized. In recent years, many research groups have focused their efforts on the molecular regulation of artemisinin biosynthesis, and on the genes coding for the key enzymes involved in the process. The high efficiency of genetic transformation and regeneration procedures allows the manipulation of artemisinin biosynthesis by genetic methods. Although greatly improved yields have been obtained by combining the expression of a synthetic sesquiterpene synthase with a recombinant mevalonate pathway, it is likely that a maximum yield was still not attained. Furthermore, *in-vitro* evolution and combinatorial biosynthesis of sesquiterpene biochemical pathways in microbes may lead to artemisinin derivatives, or perhaps new sesquiterpenes. Bioreactor technology is essential for the large-scale production of artemisinin; however, whilst many different types of bioreactor have been investigated, the relevant data relating to oxygen and nutrient transfer, hydrodynamic behavior and mixing characteristics in plant organs and tissue culture are limited. With the development of molecular techniques, however, a bioreactor which employs microbial fermentation will doubtlessly emerge in the near future. In this regard, studies of genetic engineering to increase artemisinin content, and of novel bioreactors to produce artemisinin on a large scale, are urgently needed.

## References

- 1 Luo, X.D., Shen, C.C. *Med. Res. Rev.* **1987**, *7*, 29–52.
- 2 Krishna, S., Uhlemann, A.C., Haynes, R.K. *Drug Resist. Update* **2004**, *7*, 233–244.
- 3 Mårtensson, A., Strömberg, J., Sisowath, C., Msellem, M.I., Gil, J.P., Montgomery, S.M., Olliaro, P., Ali, A.S., Björkman, A. *Clin. Infect. Dis.* **2005**, *41*, 1079–1086.
- 4 Kannan, R., Kumar, K., Sahal, D., Kukreti, S., Chauhan, V.S. *Biochem. J.* **2005**, *385*, 409–418.
- 5 Eckstein-Ludwig, U., Webb, R.J., van Goethem, I.D.A., East, J.M., Lee, A.G., Kimura, M., O'Neill, P.M., Bray, P.G., Ward, S.A., Krishna, S. *Nature* **2003**, *424*, 957–961.
- 6 Singh, N.P., Lai, H.C. *Anticancer Res.* **2005**, *25*, 4325–4331.
- 7 Wang, C.W. *Harvard University, Cambridge, MA* **1961**, *5*, 171–187.
- 8 Charles, D.J., Simon, J.E., Wood, K.V., Heinsten, P. *J. Nat. Prod.* **1990**, *53*, 157–160.
- 9 Liu, Y., Wang, H., Ye, H.C., Li, G.F. *J. Integrat. Plant Biol.* **2005**, *47*, 769–782.
- 10 Akhila, A., Thakur, R.S., Popli, S.P. *Phytochemistry* **1987**, *16*, 1927–1930.
- 11 Sangwan, R.S., Agarwal, K., Luthra, R., Thakur, R.S., Singh, S.N. *Phytochemistry* **1993**, *34*, 1301–1302.
- 12 El-Feraly, F.S., Al-Meshal, I.A., Alyahya, M.A., Hifnawy, M.S. *Phytochemistry* **1986**, *25*, 2777–2778.



- 13 Wallaart, T.E., Pras, N., Quax, W.J. *J. Nat. Prod.* **1999**, *62*, 1160–1162.
- 14 Wallaart, T.E., van Uden, W., Lubberink, H.G.M., Woerdenbag, H.J., Pras, N., Quax, W.J. *J. Nat. Prod.* **1999**, *62*, 40–42.
- 15 Berteza, C.M., Freije, J.R., van der Woude, H., Verstappen, F.W.A., Perk, L., Marquez, V., DeKraker, J.W., Posthumus, M.A., Jansen, B.J.M., de Groot, A., Franssen, M.C.R., Bouwmeester, H.J. *Planta Med.* **2005**, *71*, 40–47.
- 16 Teoh, K.H., Polichuk, D.R., Reed, D.W., Nowak, G., Covello, P.S. *FEBS Lett.* **2006**, *580*, 1411–1416.
- 17 Klayman, D.L. *Science* **1985**, *228*, 1049–1055.
- 18 Luo, X.D., Shen, C.C. *Med. Res. Rev.* **1987**, *7*, 29–52.
- 19 Avery, M.A., Chong, W.K.M., Jennings-White, C. *J. Am. Chem. Soc.* **1992**, *114*, 974–979.
- 20 Xu, X.X., Zhu, J., Huang, D.Z., Zhou, W.S. *Tetrahedron* **1986**, *42*, 819–828.
- 21 He, X.C., Zeng, M.Y., Li, G.F., Liang, Z. *Acta Botanica Sinica* **1983**, *25*, 87–90.
- 22 Tawfiq, N.K., Anderson, L.A., Roberts, M.F., Phillipson, J.D., Bray, D.H., Warhurst, D.C. *Plant Cell Rep.* **1989**, *8*, 425–428.
- 23 Weathers, P.J., Cheethan, R.D., Follansbee, E., Theohairides, K. *Biotechnol. Lett.* **1994**, *16*, 1281–1286.
- 24 Paniego, N.B., Giuletta, A.M. *Enzyme Microbiol. Technol.* **1996**, *18*, 526–530.
- 25 Liu, C.Z., Wang, Y.C., Ouyang, F., Ye, H.C., Li, G.F. *Biotechnol. Lett.* **1997**, *19*, 927–930.
- 26 Nair, M.S.R., Acton, N., Klayman, D.L. *J. Nat. Prod.* **1986**, *49*, 504–507.
- 27 Teo, C.K.H., Yap, A.W., Chan, K.L., Gan, E.K., Tanaka, M. *Asia-Pacific J. Mol. Biol. Biotechnol.* **1995**, *3*, 317–321.
- 28 Paniego, N.B., Giuletta, A.M. *Plant Cell Tissue Organ Cult.* **1994**, *36*, 163–168.
- 29 Woerdenbag, H.J., Luers, J.F.J., Van Uden, W., Pras, N., Malingre, T.H., Alfermann, A.W. *Plant Cell Tissue Organ Cult.* **1993**, *32*, 247–257.
- 30 Gulati, A., Bharel, S., Jain, S.K., Abdin, M.Z., Srivastava, P.S. *J. Plant Biochem. Biot.* **1996**, *5*, 31–35.
- 31 Ferreira, J.F., Janick, J. *Phytochemistry* **1996**, *41*, 97–104.
- 32 Martinez, B.C., Staba, E.J. *Adv. Cell Cult.* **1988**, *6*, 69–87.
- 33 Wang, J.W., Tan, R.X. *Biotechnol. Lett.* **2002**, *24*, 1153–1156.
- 34 Weathers, P.J., DeJesus-Gonzalez, L., Kim, Y.J. *Plant Cell Rep.* **2004**, *23*, 414–418.
- 35 Whipkey, A., Simon, J.E., Charles, D.J., Janick, J. *Phytother. Res.* **1992**, *1*, 15–25.
- 36 Fulzele, D.P., Heble, M.R., Rao, P.S. *J. Biotechnol.* **1995**, *40*, 139–143.
- 37 Charles, D.J., Simon, J.E., Wood, K.V., Heinsten, P. *J. Nat. Prod.* **1990**, *53*, 157–160.
- 38 Smith, T.C., Weathers, P.J., Cheetan, R.D. *In Vitro Cell Dev. Biol. Plant* **1997**, *33*, 75–79.
- 39 Weathers, P.J., Bunk, G., McCoy, M.C. *In Vitro Cell Dev. Biol. Plant* **2005**, *41*, 47–53.
- 40 Liu, C.Z., Guo, C., Wang, Y.C., Ouyang, F. *Process Biochem.* **2002**, *38*, 581–585.
- 41 Wang, Y.C., Zhang, H.X., Zhao, B., Yuan, X.F. *Biotechnol. Lett.* **2001**, *23*, 1971–1973.
- 42 Guo, C., Liu, C.Z., Ye, H.C., Li, G.F. *Acta Bot. Boreal -Occident. Sinica* **2004**, *24*, 1828–1831.
- 43 Bouwmeester, H.J., Wallaart, T.E., Janssen, M.H.A., Loo, B., Jansen, B.J.M., Schmidt, M.A.P.C.O., Kraker, J.W.D., König, W.A., Franssen, M.C.R. *Phytochemistry* **1999**, *52*, 843–854.
- 44 Matsushita, Y., Kang, W.Y., Charlwood, B.V. *Gene* **1996**, *172*, 207–209.
- 45 Mercke, P., Bengtsson, M., Bouwmeester, H.J., Posthumus, M.A., Brodelius, P.E. *Arch. Biochem. Biophys.* **2000**, *381*, 173–180.
- 46 Wallaart, T.E., Bouwmeester, H.J., Hille, J., Poppinga, L., Maijers, N.C.A. *Planta* **2001**, *212*, 460–465.
- 47 Liu, Y., Ye, H.C., Wang, H., Li, G.F. *Acta Botanica Sinica* **2003**, *45*, 608–613.
- 48 Dhingra, V., Narasu, L.M. *Biochem. Biophys. Res. Commun.* **2001**, *281*, 558–561.
- 49 Weathers, P.J., Cheethan, R.D., Follansbee, E., Theohairides, K. *Biotechnol. Lett.* **1994**, *16*, 1281–1286.
- 50 Qin, M.B., Li, G.Z., Yun, Y., Ye, H.C., Li, G.F. *Acta Botanica Sinica* **1994**, *36* (suppl.), 165–170.
- 51 Liu, B.Y., Ye, H.C., Li, G.F. *Chin. J. Biotechnol.* **1998**, *14*, 401–404.



- 52 Xie, D.Y., Zou, Z.R., Ye, H.C., Li, G.F., Guo, Z.C. *Israel J. Plant Sci.* **2001**, *49*, 129–134.
- 53 Vergauwe, A., Cammaert, R., Vandenberghe, D., Genetello, C., Van Montagu, M., Van den Eeckhout, E. *Plant Cell Rep.* **1996**, *15*, 929–937.
- 54 Vergauwe, A., Geldre, E.V., Inzé, D., Montagu, M.V., Eeckhout, E.V. *Plant Cell Rep.* **1998**, *18*, 105–110.
- 55 Han, J.L., Wang, H., Ye, H.C., Liu, Y., Li, Z.Q., Zhang, Y., Zhang, Y.S., Yan, F., Li, G.F. *Plant Sci.* **2005**, *168*, 73–80.
- 56 Chen, D.H., Ye, H.C., Li, G.F. *Acta Botanica Sinica* **1999**, *41*, 490–493.
- 57 Geng, S., Ye, H.C., Li, G.F. *Chin. Appl. Environ. Biol.* **2001**, *7*, 201–206.
- 58 Chen, D.H., Meng, Y., Ye, H.C., Li, G.F., Chen, X.Y. *Acta Botanica Sinica* **1998**, *40*, 711–714.
- 59 Cane, D.E. *Chem. Rev.* **1990**, *90*, 1089–1103.
- 60 Delourme, D., Lacroute, F., Karst, F. *Plant Mol. Biol.* **1994**, *26*, 1867–1873.
- 61 Attucci, S., Aitken, S.M., Ibrahim, R.K., Gulick, P.J.A. *Plant Physiol.* **1995**, *108*, 835–836.
- 62 Chen, D.H., Ye, H.C., Li, G.F. *Plant Sci.* **2000**, *155*, 179–185.
- 63 Farmer, W.R., Liao, J.C. *Biotechnol. Prog.* **2001**, *17*, 57–61.
- 64 Kajiwara, S., Fraser, P.D., Kondo, K., Misawa, N. *Biochem. J.* **1997**, *324*, 421–426.
- 65 Kim, S.W., Keasling, J.D. *Biotechnol. Bioeng.* **2001**, *72*, 408–415.
- 66 Martin, V.J.J., Pitera, D.J., Withers, S.T., Newman, J.D., Keasling, J.D. *Nature Biotechnol.* **2003**, *21*, 796–802.
- 67 Liu, J.H., Chen, Y.G., Yu, B.Y., Chen, Y.J. *Bioorg. Med. Chem. Lett.* **2006**, *16*, 1909–1912.
- 68 Liu, C.Z., Wang, Y.C., Ouyang, F., Ye, H.C., Li, G.F., Guo, Z.C. *Eng. Chem. Metal.* **1999**, *20*, 329–36.
- 69 Liu, C.Z., Wang, Y.C., Guo, C., Ouyang, F., Ye, H.C., Li, G.F. *Bioprocess Eng.* **1998**, *19*, 389–392.
- 70 Liu, C.Z., Wang, Y.C., Ouyang, F., Ye, H.C., Li, G.F. *Biotechnol. Lett.* **1998**, *20*, 265–268.
- 71 Kim, Y., Wyslouzil, B.E., Weathers, P.J. *Plant Cell Rep.* **2001**, *20*, 451–455.
- 72 Kim, Y., Wyslouzil, B.E., Weathers, P.J. *In Vitro Cell Dev. Biol. Plant.* **2002**, *38*, 1–10.
- 73 Wyslouzil, B.E., Waterbury, R.G., Weathers, P.J. *Biotechnol. Bioeng.* **2000**, *70*, 143–150.
- 74 Souret, F.F., Kim, Y., Wyslouzil, B.E., Wobbe, K.K., Weathers, P.J. *Biotechnol. Bioeng.* **2003**, *83*, 653–667.
- 75 Liu, C.Z., Guo, C., Wang, Y.C., Ouyang, F. *Process Biochem.* **2003**, *39*, 45–49.
- 76 Escalona, M., Lorenzo, J.C., Gonzalez-Daquinta, M., Gonzalez, J.L., Desjardins, Y., Borroto, C.G. *Plant Cell Rep.* **1999**, *18*, 743–748.
- 77 Liu, C.Z., Wang, Y.C., Guo, C., Ouyang, F., Ye, H.C., Li, G.F. *Plant Sci.* **1998**, *135*, 211–217.
- 78 Wright, W.C.T. *J. Ethnopharmacol.* **2005**, *100*, 67–71.
- 79 Bogue, J.P., Bonnet, D.D. *Drug Future* **2005**, *30*, 509–518.
- 80 Uhlemann, A.C., Krishna, S. *Curr. Top. Microbiol. Immunol.* **2005**, *295*, 39–53.

## Subject Index

Page numbers in italics refer to locations in figures.

### a

- A. annua*
- *Agrobacterium rhizogenes* 534
- hairy roots 533
- A. belladonna*
- *h6h* gene 255
- *pmt* gene 252
- A. rhizogenes* strains
- Bo542 130
- C58 130
- LBA 9402 130
- TR105 130
- A. rhizogenes* transformation 255
- A. thaliana* 223
- AAE *see* acetylajmalan esterase
- abietadiene 210
- abiotic stress 5, 418
- Aborigines 62
- absolute configuration 34
- Acer negundo* 119
- Acerina carvi* 442
- acetylajmalan esterase (AAE) 293
- acetylcholine esterase 110
- N*-acetylneuraminic acid (NANA) 323
- 17-O-acetyl-norajmaline 291
- Achillea millefolium* 73, 75
- Acnistus arborescens* 119
- aconitine 100, 114
- Acronychia baueri* 119
- acronycine 119
- ACT *see* artemisinin-based combination therapy
- actin filaments
- amphotericin B 104
- phalloidin 104
- actinomycetales 62
- actinomycin D 105
- acyltransferases 293
- ADH *see* alcohol dehydrogenase
- Adonis* 111
- affinity chromatography 337
- AFLP *see* amplified fragment length polymorphism
- AFLP analysis
- *Echinacea* 78
- *Panax quinquefolius* 78
- Agrobacterium*, *rol* gene 242
- Agrobacterium rhizogenes* 130, 194
- *D. stramonium* roots 240
- Gamborgs G5 240
- geotropism 240
- hairy roots 240
- hyoscyamine 240
- scopolamine 240
- Agrobacterium tumefaciens* 329, 427
- crown galls 169
- T-DNA 169
- Ti plasmid 169
- agroinfiltration 329
- pharmaceutical production 327
- AIDS 50
- airlift bioreactor 537
- *A. annua* 536
- homogeneous growth distribution 536
- oxygen transfer 536
- root matrix 536
- shear stress 536
- air-lift fermentor 175
- airlift reactors 175, 246
- ajmalicine 387
- ajmaline 114, 293, 387
- alcohol dehydrogenase (ADH) 482
- alfalfa 166, 207, 381
- pharmaceutical production 327
- alfalfa leaves 329
- alfalfa mosaic virus 443

- algae 99
- alkaloid precursors
  - cadaverine 246–247
  - diaminoethane 246–247
  - diaminomethane 246–247
  - diaminopropane 246–247
  - putrescine 246–247
- alkaloid production
  - acceleration 245–246
  - airlift bioreactor 245
  - contents in cell culture systems 244
  - culture system 244–249
  - *Duboisia myoporides* 244
  - hyoscyamine 244
  - *Hyoscyamus* root 244
  - large scale culture 245–246
  - light 245–246
  - optimization strategies 244–249
  - scopolamine 244
  - suspension cultures 244
- alkaloids 67, 99–100, 219, 237, 290–296
  - ATP-binding cassette 258
  - engineered medicinal plants 387
  - shoot cultures 173
- alkamides 99
- Allamanda carthatica* 119
- allarnandin 119
- allergen Art v 1 354
- allergic reactions 494
- allicin 105, 108
- alliin 103
- Allium cepa*, haploid plants 438
- Allium sativum* 75, 83
- Allium schoenoprasum* 430
- allylthiocyanate 108
- alpha-pinene 106
- Alternaria* 442
- amatoxines 100
- Amberlite XAD 272
- Amberlite XAD-2 245
- ambrosin 119
- ambuic acid 60
- American cockroach 480
- amines 99
- amino acids 100
- amino alkaloids, engineered medicinal plants 387
- AMIX-TOOLS 23
- amjaline 291
- amorpha-4,11-diene 298, 299, 531
- AMOVA 84
- amphibia 101
- amplified fragment length polymorphism (AFLP) 74, 439
- anabaseine 100
- anabasine 256
- anacardiaceaeous plant 61
- analysis tools
  - BLAST@PlantGDB 205
  - GeneSeqer@PlantGDB 205
  - PatternSearch@PlantGDB 205
- anatabine 237
- anataline 237
- anatoxin-a 99
- anemia 276
- anemones 100
- anethole 476
- Angelica dahurica* 269
  - production of imperatorin 270
- animal cells 104
- anion-exchange HPLC 363
- [8]-annulene 64
- S-anosyl-L-methionine:caffeic acid methyl transferase 140
- ansa macrolide 119
- anther culture 165
- anthocyanins 270, 280–281, 281, 304
- anthranilate-N-hydroxy-cinnamoyl/benzoyl-293
- anthraquinones 99, 105, 270, 457
- antibiotics 57–61, 99
  - endophytic bacterial products 61
- antibodies
  - anti-carbohydrate 357
  - Fcy receptors 361
  - FcyRIII 361
- antibody format
  - B-cell lymphoma 320
  - carcinoembryonic antigen 320
  - colon cancer antigen 320
  - creatine kinase 320
  - dAb 320
  - ferritin 320
  - hepatitis B virus surface antigen 320
  - herpes simplex virus 2 320
  - HIV antibodies 320
  - human choriogonadotropin 320
  - IgG 320
  - interleukin-4 321
  - interleukin-6 321
  - murine 38C13 320
  - rhesus D antigen 320
  - scFv 320
  - scFv-fusion 320
  - streptococcal surface antigen (i/ii) 321
  - substance p 321
- antibody purification 337
- anticancer agents 65–67

- anti-CCD antiserum 359  
 antioxidants 67  
*Antozoa* 100  
*Aphids* 442  
 apigenin 305  
 apiole 476  
*Apium graveolens* 166  
 aplysiatoxin 99  
*Apocynaceae* 111  
*Apocynum* 111  
 apomicts 430  
 apomixis  
   – advantages 430  
   – disadvantages 430  
 apoptosis  
   – alkaloids 113  
   – allucin 113  
   – cardiac glycosides 113  
   – flavonoids 113  
   – saponins 113  
 aposematism 102  
*Arabidopsis*  
   – EST databases 207  
   – fucosyltransferase 360  
*Arabidopsis lyrara* 205  
*Arabidopsis* metabolome 12  
*Arabidopsis thaliana* 81, 381  
   – cytochrome 288  
   – genome sequence 204  
   – NADPH:cytochrome P450 Reductase (OpCPR) 462  
*Arabidopsis* 2010 program 205  
 arabinogalactan-polysaccharides 352  
 arabinogalactans 354  
*Arachis hypogaea* 207  
*Araneae* 100  
 arbitrary primers 77  
 arbutin 103  
 archaebacteria 53  
*Arctostaphylos uva-ursa* 4  
 argiopin 105  
 argiotoxin 105  
 aristolochic acids 105, 112  
*Arnica montana* 432  
 aroma grasses 469  
 aromatherapy 480  
 aromatic plant breeding, trends 445  
 arteannuin B 530  
 artemesinin, shoot cultures 173  
 artemether-lumefantrine 529  
*Artemisia annua* 5, 61, 75, 84, 195, 301, 389, 529  
   – photoperiodic reactions 437  
*Artemisia mongolica* 61  
*Artemisia vulgaris* 354  
 artemisinic acid 534  
 artemisinic alcohol 298  
 artemisinic aldehyde 298  
 artemisinin 5–6, 114, 195, 298, 301–302, 389, 529–542, 530  
   – biosynthesis 530–531, 533  
   – hairy root cultures 536  
   – production by microorganisms 535  
   – production in bioreactors 536  
 artemisinin biosynthesis 298  
   – amorpha-4,11-diene 301  
   – amorpha-4,11-diene synthase 301  
 artemisinin production 537  
 artemisinin-based combination therapy (ACT) 529  
 artesunate plus amodiaquine 529  
 artificial infection  
   – *Cercospora* 442  
   – *Colletotrichum* 442  
   – *Helminthosporium* 442  
   – St. John's wort 442  
 artificial seeds 166  
   – basil species 432  
   – *Cymbopogon martinii* 432  
   – *Echinacea angustifolia* 432  
*Asclepiadaceae* 111  
 aseptic plants 453–454  
 asmonates, elicitors 179  
*Aspergillus* 50  
   – toxins 100  
*Aspergillus niger* 136, 191  
 aspirin 114  
*Asterioidea* 100  
 asthma 280  
 atractyloside 111  
*Atropa belladonna* 5, 181, 223, 388  
 atropine, shoot cultures 173  
 Australian Aborigines 62  
 autotoxicity 197  
*Azadirachta indica* 85
- b**  
*B. subtilis* 63  
 B5 medium 126  
 baby hamster kidney (BHK) 323  
 BAC 207  
 baccatin III 5, 135–136, 142, 298, 518, 521  
 baccharin 119  
*Baccharis megapotamica* 119  
*Bacillus subtilis* 60  
 bacteria 99  
 bacterial artificial chromosome 207  
 bacterial cells 104

- bacterial products, endophytic 61
- baculovirus-insect cell expression system 143
- Bafix 443
- Baileya multiradiata* 119
- Bai-Zhi 270
- bananas, production of vaccines 329
- barberine 221
- bargain theory 400
- barley* 328
- Basidiomycetes 100
- basil 469
- batch culture 127
- benzoisoquinoline alkaloids
  - berberine 293–296
  - codeine 293–296
  - dopamine 295
  - morphine 293–296
  - (*S*)-noroclaurine 295
  - papaverine 295
  - sanguinarine 293–296
  - (+)-tubocurarine 295
- N*-benzolphenylisoserine 133
- N*-benzoylglycine 133
- benzophenanthridine alkaloids 193
- benzyladenine 165
- 6-benzylaminopurine 126
- berberine 105, 114, 196, 269, 294
- berberine transport 258
- berfena 444
- Bersama abyssinica* 119
- BHK *see* baby hamster kidney
- bilobalide 494
  - biosynthesis 496–500
- bilobalide contents
  - natural variability 497
  - terpene content 497
- bioactive natural products 49–70, 57–68
- bioanalytics 7
- bioassay-guided fractionation 379
- in-vitro* bioassays 29
- biocontrol agents 62
- bioconversions 138
- biodiversity, endophytes 55
- bioengineering 188
- bio-informatics 382
- biolistic transformation 385
- biolistics, gene transfer 169
- biological containment 335
- biological gold 115
- biomedicine 97
- biomembranes 106–107
  - polymixins 104
  - saponins 104
  - terpenoids 104
- bioprocessing 6
- bioprospecting 97–115
- bioprospection 50
- bioreactor design 117
- bioreactors 6, 175
  - mass cultivation 174
  - scale-up 174
  - somatic embryoids 166
- biosafety 330, 333
  - herbivory 334
  - parasitism 334
  - spread of foreign DNA 334
  - transgene escape 334
  - unintended exposure 334
- biosynthesis 378–379
  - benzoisoquinoline alkaloids 295
  - camptothecin 144
  - complex-type N-glycans 349
  - key genes 380–383
  - monoterpenes 473
  - monoterpenoid indole alkaloids 290
  - paclitaxel 142, 143
- biosynthetic pathway 138, 472
  - camptothecin 461
  - identification 379–380
  - paclitaxel 518
- biotechnology 157
- biotechnology directive 407–408
- biotransformation 108, 178–179
- bipyridine 256
- (*E*)- $\gamma$ -bisabolene synthase 475
- $\gamma$ -bisabolene 210
- bisbolene 298
- bitter tonics 275
- bitter-fennel, essential oil content 423
- Black Sigatoka disease 62
- BLAST 205
- Bletilla* 73
- Bodegold 426
- bony fish 100
- Botrytis cinerea* 58, 134, 191, 442
- bourvardin 119
- Bouvardia temifolia* 119
- Brassica rapa* 18
- Brassicaceae* 111
- Brazilian rubber tree 214
- breeder 417
- breeding
  - advantages 419
  - aims 419
  - disadvantages 419
  - for resistance 442
- breeding by crossing 422
- breeding efforts 421

- breeding methods 419, 420–433
  - breeding by crossing 422
  - hybrid breeding 423
  - induced mutation 426
  - molecular gene transfer 427
  - natural diversity 420
  - new variability 421
  - somaclonal variation 426
  - somatic hybridization 426
  - synthetic cultivars 425
- breeding program 420
- brevetoxin B 99
- Bristol-Myers Squibb 515
- Britannica Concise Encyclopedia 376
- broceanlin 119
- Brucea antidysenterica* 119
- Brugmansia candida*
  - AgNO<sub>3</sub> 250
  - elicitates 250
  - Salicylic acid 250
- bubble-column reactor (BCR) 137, 537
- Bufadienolides 111
- bufotonin 100
- bush medicine 62
- c**
- C. acuminata*
  - didehydrostrictosidine 133
  - hydroxystrictosidine 133
  - loganin 133
  - secologanin 133
  - strictosidine 133
  - tryptamine 133
- C. ipeccacuanha* 119
- C. quercina* 58
- C. spaectabilis* 119
- C. speciosum* 119
- C. tiglium* 119
- γ-cadinene synthase 475
- Caesalpinia gilliesii* 119
- caffeic acid 132, 139
- caffeic acid 3-*O*-methyltransferase (COMT) 140
- caffeine 105, 114, 380
- caffeoyl CoA 3-*O*-methyltransferase (CCoAOMT) 140
- 3-*O*-caffeoylquinic acid 455, 457
- calcium alginate 132
- Callitris drummondii*, cell suspension cultures 126
- callus 160
  - *Callitris drummondii* 127
  - explant 127
  - *Juniperus chinensis* 127
  - *Linum album* 127
  - meristematic plant cells 164
  - plant regeneration 164
  - *Podophyllum hexandrum* 127
  - *Podophyllum peltatum* 127
  - totipotent plant cells 164
- callus culture 162
- calnexin 347
- calreticulin 347
- calycosin 216
- Calystegia sepium*, calystegines 251
- calystegine A<sub>3</sub> 248
- camalexin 223
- camphor 473
- Camptotheca acuminata* 5, 119, 121, 124, 269, 451
  - callus 129
- camptothecin 131, 144, 269, 451–466, 461
  - biosynthesis 143
  - biosynthetic genes 460
  - NADPH:cytochrome P450 reductase (CPR) 461
  - secologanin synthase (SLS) 461
  - strictosidine synthase (STR) 460
  - tryptophan decarboxylase (TDC) 461
- camptothecin (CPT) productivity 459
- camptothecin production
  - metabolite profiles 454–459
  - 10-methoxycamptothecin 454–459
- camptothecine 98, 105, 114, 117, 119
- CaMV 35S promoter 330
- Canadian Parliament 413
- canavaine 111
- Cancer Chemotherapy National Service Centre (CCNSC) 118
- cancers 451
- Candida* 50
- Candida albicans* 58, 61–62
- Candida tropicalis* 60
- (*S*)-canhadine 221
- cannabinoids 390
- Cannabis sativa* 84
  - photoperiodic reactions 437
- canola
  - chimeric plant 412
  - glyphosate-resistant 412
- cantharidin 100
- capillary electrophoresis (CE) 11, 14
- CAPS (cleaved amplified polymorphic sequences) 79
- capsaicin 190
- Capsella rubella* 205
- Capsicum annum* 190
- capsidiol 238

- carbohydrates 99
- cardenolides 111
  - shoot cultures 173
- cardiac arrhythmia 272
- cardiac glycosides 100, 105
- carene 473
- CaroRx 336
- $\beta$ -carotene pathways 302
- carotenoid biosynthesis
  - geranylgeranyl diphosphate synthase (CrtE) 302
  - phytoene synthase 302
- carotenoid pigments 209
- carotenoids 302–304
- carrot, production of vaccines 329
- Carum carvi* 478
- (+)-*trans*-carveol dehydrogenase 478
- caryophyllene sesquiterpenes 59
- Castanospermum australe* 178
- catechins 105
- catechol-*O*-methyltransferase 110
- Catharanthus* 259
- Catharanthus roseus* 75, 119, 145, 178, 190, 196, 223, 269, 292, 387, 427
- Catharanthus* AP2-domain proteins 257
- catenamine 145, 291
- cauliflower mosaic virus 330
- CBD *see* Convention on Biological Diversity
- Celastraceae 111
- celery flavor 166
- cell cultures 269
  - growth 175
  - metabolite production 175
  - productivity 178
- cell death 113
- cell wall
  - cephalosporin 104
  - penicillin 104
  - vancomycin 104
- cell-cell adhesion 132
- cell-free systems 138
- cell-lift bioreactor 137
- cellulase 426
- Cephalis acuminata* 119
- Cephalopoda 100
- Cephalotaxus harringtonia* 119
- Ceratocystis ulmi* 62
- cesalin 119
- cetyltrimethylammonium bromide (CTAB) 75
- cgl mutant 359
- chalcone 216, 305
- chamomile
  - Bodegold 426
  - Zloty lan 426
- chaperones 331, 347, 348
- chavicol 216, 476, 478
- chavicol *O*-methyltransferase (CVOMT) 219
- Cheiranthus* 111
- chemical defense 103
- chemostat 176
- Chilopoda 100
- chinese hamster ovary (CHO) 323
- Chinese medicinal plants 81
- chlorophyll 209
- chlorophyllase cDNA 500
- chloroplast 79, 331
  - transformation 331
- CHO *see* chinese hamster ovary
- cholera 331
- Chondrichthyes 100
- chorismate synthase (CS) 140
- chorismic acid 139
- chromosome mutation 426
- ciddi 191
- ciguatoxin 99, 105
- cinnamic acid 132, 139
- trans*-cinnamic acid 305
- Cinnamomum zeylanicum* 63, 480
- cinnamoyl-CoA reductase, *Lolium perenne* 138
- cinnamoyl-CoA reductase (CCR) 140
- cinnamyl alcohol dehydrogenase (CAD) 139–140
- cis*-isopulegone 213
- citral 473
- Clarkia breweri* 389, 477
- clonal breeding
  - *Baptisia tinctoria* 432
  - *Mentha x piperita* 432
  - micropropagation 432
  - vegetative propagation 432
- Cnidaria 100
- coagulation factor VIII 355
- cobalt chloride 135
- cocculidins 119
- Cocculus* sp. 119
- coclaurine 294
- (*S*)-coclaurine 221
- codeine 294
  - engineered medicinal plants 388
- codeinone 294
- colchicines 105, 114, 119
- Colchicum autumnale* 119
- Coleus bluemii* 269
- Colletotrichum* 61, 442
- Colletotrichum gloeosporioides* 61
- columbamine 221

- combinatorial biochemistry 257
- combinatorial biosynthesis 5–6
- combinatorial synthesis 52
- Community Plant Variety Office 404
- compartmentation 258–259
- condensed tannins 305
- cone shells 100
- confectionary 469
- coniferin 132
- coniferyl alcohol 132, 139, 216
- coniferyl aldehyde 216
- conotoxins 100, 105
- constipation 279
- constitutive promoters 385
- contact toxicity 480
- continuous culture 127
- Convallaria* 111
- Convallariaceae* 111
- Convention on Biological Diversity (CBD) 403
- Convolvulaceae* 253
  - calystegines 251
- syn-Copalyl diphosphate* 210
- Coptis japonica* 178, 190, 196, 269
  - S-adenosyl-L-methionine:columbamine O-methyltransferase (CoOMT) 220
  - berberine 223
  - cDNA 220
  - cell culture 220
  - 3'-hydroxy-N-methylcoclaurine 4'-O-methyltransferase (4'OMT) 220
  - O-methyltransferase-like cDNA 220
  - O-methyltransferases 220
  - norcoclaurine 6-O-methyltransferase (6OMT) 220
  - scoulerine 9-O-methyltransferase (SOMT) 220
- corals 100
- core- $\alpha$ -1,3-fucosyltransferase 350
- Coriandrum sativum* 430
- coronamycin 63–64
- corydaline 269
  - analysis 272–273
  - production 272–273
- Corydalis* 272
- Corydalis yanhusuo* 269, 272–273, 273
- Corylus avellana* 66
- cosmetics 469
- cotton, production of vaccines 329
- coumaric acid 132, 139
- p*-coumaric acid 305
- coumarins 99
- p*-coumaroyl-CoA 305
- Council of the European Union 404
- CR377 60
- Crassulaceae* 111
- Crococimia crocosmiiflora* 119
- crossing progenies 423
- cross-pollinating 328
- Crotalaria assamica* 119
- crotepoxide 119–120
- Croton cajucara* 479
- Croton macrostachys* 119
- crown galls, *Agrobacterium tumefaciens* 169
- cryopreservation 169, 505
  - two-stage freezing 170
  - vitrification 170
- cryptocandin A 58
- cryptocin 59
- Cryptococcus* 50
- Cryptococcus neoformans* 62
- Cryptosporiosis* 58, 59
- cryptotanshinone 270, 271
  - callus cultures 278–279
- cucurbitacin E 119
- cultivars, breeding aim 418
- culture
  - pectinase 126
  - polyvinylpyrrolidone (PVP) 126
- in-vitro* cultures
  - cell suspension cultures 170
  - permanent 170
  - root cultures 171
- Curcuma* 73
- Curcuma longa* 75
- C-values 431
- cyanobacteria 99
- cyanogenic glycosides 99–100, 110
- cycasin 103, 112, 112
- cyclases 145
- Cyclea peltata* 119
- $\beta$ -cyclodextrin 132, 136
- $\gamma$ -cyclodextrin 136
- cycloheximide 105
- CYP82E4 223
- cytochalasins 67
- cytochrome
  - CYP81E7 216
  - CYP81E9 216
- cytochrome P450 141
- cytochrome P450 taxadiene 5- $\alpha$ -hydroxylase 143
- cytochrome P450 taxane 10- $\beta$ -hydroxylase 143
- cytochrome P450 taxane 13- $\alpha$ -hydroxylase 143
- cytochrome P450-dependent monooxygenase 140



**d**

- D. metel* 82
- D. stramonium*
  - callus cultures 252
  - hyoscyamine 239
  - root cultures 252
  - scopolamine 239
  - seedlings 239
  - TRI 254
  - TRII 254
- daidzein 216, 305
- Dan-shen 278
- Daphne mezereum* 119
- DAT *see* deacetylvindoline 4-*O*-acetyltransferase
- Datura ferox* 239
- Datura innoxia* 82, 427
  - anther culture 165
  - calcium alginate immobilization 239
  - haploid plants 165, 438
- Datura metel* 239
- De Materia Medica* 29
- 10-deacetyl baccatin III 136
- 10-deacetyl-2-debenzoylbaccatin III 298
- 10-deacetyl baccatin III 298, 516
- deacetylvindoline 291
- deacetylvindoline 4-*O*-acetyltransferase (DAT) 293
- deacetylvindoline acetyltransferase (BAHD) 293
- dehydroabietane 498
- Dendrobium* 82
- Dendrobium tosaense* 269
  - micropropagated plants 273–274
  - Shih-hu 273–274
- 3-deoxy-D-arabino-heptulosonate 7-phosphate synthase (DAHPS) 140
- 1-deoxy-D-xylulose-5-phosphate reductoisomerase (DXR) 519
- deoxypodophyllotoxin 6-hydroxylase 140
- deoxypodophyllotoxin 7-hydroxylase 140
- 3(*S*)-deoxypumiloside 455, 461
- 3(*R*)-deoxypumiloside 455
- Depressaria nervosa* 442
- dereplication 29
- desacetoxyvindoline 291
- desease progress curve 444
- desoxy camptothecin 144
- Deuteromycetes* 57, 100
- Deutscher Winter 421
- dexamethasone 274
- Diaion HP-20 457
- 4-dichlorophenoxyacetic acid 165
- dictamine 108, 112
- 11(12)-diene 141, 142
- digestion 273
- Digitalis* 111
- Digitalis lanata* 166
  - cell cultures 179
  - haploid plants 438
- Digitalis purpurea*, photoperiodic reactions 437
- 2,3-dihydro-3-hydroxytabersonine-*N*-methyltransferase (NMT) 292
- dihydroartemisinic acid hydroperoxide 530
- dihydroartemisinic aldehyde 298
- dihydroartemisinin 529
- dihydroartemisininic acid 298
- dihydrokaempferol 305
- dihydromyrecetin 305
- 3,6-dihydronicotone 222
- dihydroquercetin 305
- 1,2-dihydro-vomilenine 291
- dihydrovomilenine reductase (DHVR) 293
- dillapiole 476
- dimethyl- $\beta$ -cyclodextrin 136
- dinoflagellates 99
- dinophyceae 99
- dinophysistoxin-1 99
- Dioscorea deltoidea* 178
- Dioscorea doryophora* 269
  - cell suspension cultures 274–275
- diosgenin 269
  - production 274–275
- 1,1-diphenyl-2-picrylhydrazyl radical (DPPH) 274
- direct transfer 427
- diterpenes 99–100, 110, 297–299
- DMC Base Natural 480
- DNA 427
  - alkaloids 104
  - camptothecin 104
  - cycasin 104
  - epoxides 104
  - furocoumarins 104
  - gyrase 104
  - PAs 104
  - quinolones 104
  - repair 104, 112
  - replication 104, 112
  - rifamycin 104
  - topoisomerase 112
  - transcription 104, 112
- DNA fingerprinting 74
- DNA markers 74
- DNA microarray 82
- DNA motifs 77
- DNA profiling 7

- multilocus 76–78
  - DNA sequencing 74, 75–76
  - DNA topoisomerase 105, 124
  - donor genotypes 420
  - donor-accession 420
  - dopamine 221, 294
  - doubled haploids 438
  - downstream processing 328, 337
  - DPPH *see* 1,1-diphenyl-2-picrylhydrazyl radical
  - Drosophila* protein 223
  - drug development 98
  - drug discovery 118
  - DSMZ (German Collection of Microorganisms and Cell Cultures) 164
  - Duboisia*, hybrid 242
  - Duboisia myoporoides*
    - mikropropagation 242
    - *in-vitro* multiplication 242
    - tropane alkaloids 242
  - Dutch Elm disease 62
  - DVHR *see* dihydrovomilenine reductase
  - DXP pathway 296
    - *dxr* (1-deoxy-d-xylulose-5-phosphate reductoisomerase) 303
    - *dxs* (1-deoxy-d-xylulose-5-phosphate synthase) 303
    - *E. coli* 297, 303
    - *ispA* (FDP synthase) 303
    - *idi* (IPP isomerase) 303
  - DXR *see* 1-deoxy-d-xylulose-5-phosphate reductoisomerase
  - dysmenorrhea 272
- e**
- E. citridora*, cell cultures 136
  - E. coli*
    - amorph-4,11-diene synthase 301
    - codeinone reductase 295
    - cytochrome C4H 307
    - DMADP pool 297
    - engineered flavonoid pathway 307
    - IDP 297
    - mevalonate pathway 301
    - (*S*)-noroclaurine synthase 295
    - phosphoenolpyruvate carboxykinase (*pck*) 303
    - phosphoenolpyruvate synthase (*pps*) 303
    - polyneuridine aldehyde esterase (PNAE) 293
    - pyruvate kinase (*pyk*) 303
    - salutaridinol 7-*O*-acetyltransferase 295
    - strictosidine glucosidase 293
    - strictosidine synthase 293
    - vindoline pathway 293
  - E. mollis* 119
  - E. sanguinea* 86
  - E. simulata* 86
  - E. pupurea* 86
  - E8 promoter 482
  - early selection 437
    - evening primrose 437
  - Ebers Papyrus 29
  - Echinacea* 86
  - echinocandins 58
  - Echinoidea* 100
  - echinomycins 63
  - EGb 761<sup>®</sup>, standardized extract 495
  - electrofusion 426
    - essential oil 168
    - protoplast fusion 168
  - electroporation 180, 385
    - gene transfer 169
  - elephantopin 119
  - Elephantopus elatus* 119
  - Eleutherococcus senticosus* 75
  - elicitation 133, 179, 247–250
    - cadmium 249
    - copper 249
  - elicitors 133, 191
    - asmonates 179
    - *Bacillus cereus* 250
    - codeine biosynthesis 179
    - fungal 134
    - imperatorin 272
    - *Lithospermum erythrorhizon* 179
    - *Pseudomonia aeruginosa* 250
    - *Staphylococcus aureus* 250
    - *Taxus* 179
  - elimicin 476
  - ELISA 440
    - alfalfa mosaic virus 443
  - elite cell lines 178
  - elite plant clones 432
  - ellipticine 120
  - embryo culture 162
  - embryo rescue 160
  - embryo sack 165
  - embryogenic callus 174
  - embryogenic suspension, *Podophyllum peltatum* 127
  - embryonic kidney (HEK)-293 323
  - emetine 105, 119
  - emodin 271
  - endocytosis 357
  - endophytes 49–70
    - biodiversity 55
    - natural products 56

- endophytic bacterial products, antibiotics 61
- endophytic cultures
  - isolation 57
  - preservation 57
  - storage 57
- endophytic fungal products 57–61
  - anticancer agents 65–67
  - antioxidants 67
  - immunosuppressive compounds 68
- endophytic microbes 52
- endophytic streptomycetes 62
- endoplasmatic reticulum (ER) 331, 347
- endoprotease digestion 326
- endorphins 110
- endotoxins 324
- engineered medicinal plants 387–390
  - alkaloids 387
  - amino alkaloids 387
  - codeine 388
  - hyoscyamine 388
  - isoquinoline alkaloids 388
  - morphine 388
  - scopolamine 388
  - terpenoid indole alkaloids 387
  - thebaine 388
  - tropane alkaloids 388
- ent*-Copolydiphosphate 210
- entrez gene 204
- entrez genomes 204
- enzyme-linked immunosorbent assay (ELISA) 440
- enzymes 104
- EPC *see* European Patent Convention
- ephedrine 114
- epipodophyllotoxin 136
- 16-*epi*-vellosimine 291, 293
- epoxides 112
- ergot alkaloids 100
- erlodictyol 305
- Ervatamia heyneana* 451
- Erwinia* 442
- Erysimum* 111
- Erysiphe*. 442
- erythropoietin 350
- Erythroxylaceae* 251
- Escherichia coli* 64
- Eschscholzia californica* 193, 390
- essential oils 73, 422, 469–492
  - *Cymbopogon flexuosus* 470
  - *Cymbopogon martini* 470
  - *Cymbopogon winterianus* 470
  - *Eucalyptus species* 470
  - *Lavandula officinalis* 470
  - major constituents 470
  - *Mentha arvensis* 470
  - *Mentha piperata* 470
  - *Mentha spicata* 470
  - *Ocimum basilicum* 470
  - *Origanum majorana* 470
  - *Origanum vulgare* 470
  - regulation 477–478
  - *Rosmarinus officinalis* 470
  - *Salvia officinalis* 470
  - *Thymus vulgaris* 470
  - *Vetiveria zinzoides* 470
- EST *see* expressed sequence tag
- EST sequence database
  - *Arabidopsis* 211
  - maize 211
  - rice 211
  - *terpene synthase 1* 211
- ethnobotany 379
- etoposide 124
- Eucalyptus citriodora* 477
- Eucalyptus globulus* 218
- Eucalyptus perriniana* 136
- eugenol 216, 219, 476
- eugenol O-methyltransferase 478
- eugenol O-methyltransferase (EOMT) 219
- Euonymus* 111
- eupahyssopin 119
- Eupatorium hyssopifolium* 119
- Euphorbia escula* 119
- Eupteryx atropunctata* 442
- European Commission 400
- European Patent Convention (EPC) 401, 404–407
  - article 53(a) 409
- European Pharmacopoeia 419
- European Union (EU), Council 404
- European Union Community Plant Variety Office 420
- evening primrose 418
  - early selection 437
- evolution 98
- evolutionary molecular modeling 113
- excretion 258–259
- exoglycosidases 363
- expressed sequence tag (EST) 203, 207, 382
  - *Capsicum annuum* 382
  - *Curcuma longa* 382
  - *Ginkgo biloba* 382
  - *Glycine max* 382
  - *Lycopersicon esculentum* 382
  - *Malus x domestica* 382
  - *Ocimum basilicum* 382
  - *Oryza sativa* 382
  - sequencing 208

- *Stevia rebaudiana* 382
- *Zea mays* 382
- *Zingiber officinale* 382
- expression vector 383
- extrachromosomal DNAs 68

**f**

- F. zanthoxyloides* 119
- Fagara macrophylla* 119
- fagaronine 119
- $\alpha$ -farnesene 210
- (*E*)- $\beta$ -farnesene synthase 474
- (*E,E*)- $\alpha$ -farnesene synthase 475
- fatty acids 99
- fed-batch
  - biomass 127
  - *Podophyllum hexandrum* 127
- fed-batch operation 176
- ferrulic acid 132
- field cultivation 334
- flaonoids 99
- flavan-3,4-diols/leucoanthocyanidins 305
- flavanol 305
- flavones 305
- flavonoid biosynthesis 257
  - oxygenation reactions 307
  - P450-catalyzed hydroxylation 307
- flavonoid biosynthetic pathways
  - chalcone synthase 306
  - cinnamate-4-hydroxylase (C4H) 306
  - coumaroyl-CoA-ligase 306
  - 2-hydroxyisoflavone synthase 306
  - (2-*S*)-Naringenin 306
  - phenylammonia lyase 306
  - polyketide synthase (PKS) 306
  - stilbene synthase (STS) 306
- flavonoide
  - anti-inflammatory 306
  - cytotoxic antitumor activities 306
  - defense 306
  - enzyme inhibition 306
  - estrogenic activities 306
  - germination of pollen 306
  - regulation of plant growth 306
  - scavenging 306
  - signal molecules 306
  - UV-B protection 306
- flavonoids 73, 103, 105, 219, 304–308
- flavonols 304, 305
- flavor compounds 469–492
- flavors 469
- flow cytometric seed screening 431
- flow cytometry 431, 432
- flow-cell 34

- flower formation 437
- flowers of thyme 424
- Foeniculum vulgare*
  - essential oil 422
  - genotypes 422
  - selection population 422
- Foeniculum vulgare* MILL. 419
- European Pharmacopoeia 419
- Follow Me Vine 63
- food poison 494
- foodborne pathogens 479
- foods 469
- Forsythia intermedia* 133
  - secoisolariciresinol dehydrogenase 141
- fragrances 469
- frameshift mutations 113
- Fritillaria* 81
- frogs 101
- functional gene expression 383
- fungal products, endophytic 57–61
- fungi 53, 100
- Fungi Imperfecti* 57
- furanocoumarins 105, 113
- furocoumarins 105
- Fusarium* 56, 60, 442
  - toxins 100
- Fusarium oxysporum*
  - phenylpropanoid pathway 135
  - tomato cell culture 242
- Fusarium subglutinans* 68
- fusion protein 326

**g**

- GABA 110
- $\beta$ (1,3)-Gal-transferase 350
- $\beta$ (1,4)-galactosyltransferase 332, 360
- galanthamine 114
- Gamborg's G5 126, 247
- gametoclonal variation 166
- GAP *see* Good Agricultural Practice
- gardneral 291
- gas chromatograph 440
- gas chromatography (GC) 11
- gas-liquid chromatography 469
- GC-mass spectrometry (MC) 11
- gein 103
- gel electrophoresis 10
- gene 427
- gene banks 420
- gene knock-out, *Physcomitrella patens* 360
- gene silencing 329, 384
  - agrobacterium 384
  - virus-induced 384
- gene transfer

- *Agrobacterium*-mediated 169
- biolistics 169
- electroporation 169
- generative propagation 433
- genetechnology 157
- genetic diversity 84–87
- genetic engineering 376
- genetic molecular maps 381
- genetic resources 403
- genetic variability 417, 421
- genistein 105, 216, 305
- genome mutations 426
- genomic approaches
  - *Melaleuca alternifolia* 383
  - *Papaver somniferum* 383
  - *Stevia rebaudiana* 383
- genotype 25
- genotyping 75
- Gentiana* 270
- Gentiana davidii* 275
- Gentianaceae* 275
- gentipicroside 269, 271, 275
- geraniol 291, 461, 473
- geraniol 10 hydroxylase 145
- geranium 477
- geranylgeranyl diphosphate 141
- geranylgeranyl pyrophosphate 142
- germ plasm storage 169
- germacrene 298
- germacrene A synthase 474
- germacrene D synthase 474
- German Collection of Microorganisms and Cell Cultures (DSMZ) 164
- in-vitro* germination 160
- germplasm collections 420
- Giardia* 479
- gibberellic acid 126
- gila monster 101
- ginkgo, haploid technology 165
- Ginkgo biloba* 4–5, 494
  - *Agrobacterium tumefaciens* 506
  - artemisinin 505
  - cell cultures 504
  - elicitors 504
  - flavonol glycosides 497
  - genetic transformation 506
  - leaf extracts 497
  - micropropagation 502
  - natural variability 501
  - organ cultures 506
  - plantations 495
  - santonin 505
  - somatic embryogenesis 502–503
  - standardized extracts 494
  - taxadiene 505
  - *Taxus* 505
  - terpene 497
  - terpene biosynthesis 503
- Ginkgo yimaensis* 494
- Ginkgoaceae* 494
- ginkgolide contents
  - age 497
  - gender 497
  - natural variability 497
  - soil 497
  - stage of development 497
- ginkgolides 494, 495
  - accumulation 496–500
- ginkgophyta 494
- ginseng 189
- ginsenosides 190, 214, 269
  - elicitors 191
  - production 191
- glandular structures 101
- glandular trichomes 478
  - EST libraries 212
  - *Mentha x piperita* 212
  - *Ocimum basilicum* 212
  - tomatoes 212
- glass 180
- glaucarbinone 120
- Gliocladium* 64
- Gliocladium deliquescens* 134, 191
- glucose-6-phosphate dehydrogenase 134
- glucosidase 292
- $\beta$ -glucosidase 110
- $\beta$ -D-glucoside 132
- glucosinolates 99
- glutamate 110
- glycan 332, 333
- glycine 110
- Glycine max* 191, 207
- glycoalkaloids
  - Murashige Skoog 243
  - potato tubers 243
  - solamine 242
  - solasodine 243
  - tomatine 242
- glycoengineering 361
  - humanization 345
  - N-glycosylation 345
  - O-glycosylation 345
- glycoprotein maturation 348
- glycoproteins 321, 330
- glyco-remodeling 361
- glycosylation 345, 348
- O-glycosylation 352
- GMP 327

- Gnidia lamprantha* 119  
 gocculine 119  
 Golden Rice 302  
 Golgi apparatus, indolizidine alkaloids 104  
 gonyautoxin 99–100, 105  
 Good Agricultural Practice (GAP) 524  
   – EGb 761 496  
*Gossypium* sp. 119  
 gossypol 119–120  
*Grevillea pteridifolia* 63  
 guidin 119  
*Guignardia* 61  
 guignardic acid 61  
*Gynura* 73
- h**
- H. attenuatum* 430  
*H. maculatum* 430  
*H. microcephalam* 119  
*H. muticus*  
   – *N*-methylpatrescine 250  
   – particle bombardment 255  
   – *pmt* gene 255  
   – transformation 255  
*h6h* 256  
 hairy root cultures 536, 537, 539  
   – medicinal plants 172  
   – secondary metabolites 172  
 hairy roots 240–243  
*Hallophyllum patavinum* 136  
 haploid plants  
   – anthers 438  
   – microspores 438  
 haploid technology  
   – homozygous breeding 165  
   – sporophytes 165  
 harmaline 112  
*Harpagohytum procumbens*, iridoid glycosides 39  
 harpagoside 270, 271  
   – production 279–280  
 harringtonine 119  
 HCN 105  
 heavy metal ions 110  
 helenaline 108  
*Helenium autumnale* 119  
 helevalin 119  
*Heliotropium indicum* 119  
*Helleborus* 111  
 hellebrigenin acetate 119  
*Helminthosporium papaveris* 442  
 hemomucin 223  
 herbal medicines 187  
 herbivores 97  
 herbivory 334  
 heritability 433  
*Hevea brasiliensis*  
   – AFLP 214  
   – ESTs 214  
   – latex transcriptome 214  
 Hi-Bred EST sequence libraries 211  
 high performance liquid chromatography (HPLC) 11  
   – 2D WETCOSY 34  
   – -CD 30  
   – -DAD 30  
   – -ELS 30  
   – *Hypericum perforatum* 34  
   – loop-collection 36  
   – -MS 30  
   – -PDA 13, 30  
   – *Swertia calycina* 34  
 high-performance cultivars 444  
 high-performance population 421  
 high-producing cell lines 178  
 high-throughput screening (HTS) 98  
 high-throughput technologies 381  
 high-yielding cell lines 187  
*Hippophae* 86  
 histamine 100  
 histones 107  
*Holacantha emoryi* 119  
 holacanthone 119  
*Holothuroidea* 100  
 homogeneous growth distribution 536  
 homologene 204  
 hormone autonomy  
   – auxin autotrophic 162  
   – cytokinin 162  
   – hormone autotrophic 162  
 hormone receptors 105  
*Ho-shou-wu* 276  
 housekeeping genes 76  
 HPAEC 363  
 HPLC 469  
 HPLC chromatograms 457  
 HPLC-MS 11, 13  
   – *Ginkgo biloba* 14  
 HPLC-NMR  
   – direct methods 32–36  
   – indirect methods 36–41  
   – miniaturization 41  
 HPLC-photodiode array (PDA) 11  
 HPLC-SPE-NMR 37–41  
 human glycome 357  
 human retinal line PER-C6 323  
 humanization 332  
 humulane 59

- humulene 298
  - Hyacintheaceae* 111
  - hyaluronidase 100
  - hybrid breeding 423
    - natural protection 423
    - uniformity 423
  - hybrid vigor 423
  - hydrogen peroxide 161
  - 10-hydroxy-camptothecin 129
  - 4-hydroxycinnamate:CoA ligase 140
  - 2- $\alpha$ -hydroxydimeninol 59
  - 10-hydroxygeraniol 461
  - 3-hydroxy-4-hydroxy methyl proline 58
  - hydroxyjesterone 60
  - 3-hydroxy-16-methoxy-2,3-dihydrotabersonine 291
  - (S)-3'-hydroxy-N-methylcoclaurine 221
  - 3'-hydroxy-N-methylcoclaurine 294
  - 2-hydroxynitrile 110
  - 4-hydroxyphenylacetaldehyde 294
  - 4-hydroxyphenylpyruvate 294
  - hydroxypropyl- $\beta$ -cyclodextrin 136
  - 16-hydroxytabersonine 291
  - 16-hydroxytabersonine-O-methyltransferase (T16-OMT) 292
  - Hymenoclea salsola* 119
  - hyoscyamine 109, 111, 196, 237
    - accumulation 241
    - engineered medicinal plants 388
  - (S)-hyoscyamine 237, 248
  - hyoscyamine-6 $\beta$ -hydroxylase 196, 254–255, 255
  - Hyoscyamus albus*
    - callus cultures 252
    - root cultures 252
  - Hyoscyamus muticans* 196
  - Hyoscyamus niger* 239, 388
    - haploid plants 438
  - hypercholesterolemia 276
  - hypericine 109
  - Hypericum*, haploid plants 438
  - Hypericum perforatum* 4, 85, 192, 430
  - hypochlorite 161
  - hyp-O-glycans 352
- i*
- ibuprofen 192
  - IgGs 356
  - illumination, plastids 245
  - immobilization
    - adsorption 180
    - alginate 193
    - covalent attachment 180
    - entrapment 180
    - growing cells 193
    - of cells 132
    - polyurethane foam cubes 193
    - product release 180
  - immune system 321
  - immunoglobulins 322
  - immunosuppressive compounds 68
  - imperatorin 270–271
  - inbreeding depression 433
  - indicine-N-oxide 119
  - indole acetic acid (IAA) 126
  - indole alkaloids 111, 451
  - indole-3-acetic acid 159
  - indole-3-butyric acid 165
  - induced mutation 426
  - inflammation 279
  - ingenal dibenzoate 119
  - insect repellents 469
  - insecta 100
  - insecticides 480
  - insects 100
  - in-silico* EST data mining 289
  - intellectual property 390
  - interactions 107
  - intercalation 105
    - alkaloids 113
    - apiaceae 113
    - berberine 113
    - $\beta$ -carboline 113
    - emetine 113
    - furanocoumarins 113
    - furoquinoline alkaloids 113
    - quinine 113
    - sanguinarine 113
  - intergenic spacers 79
  - internal transcribed spacer (ITS) 76
  - International Plant Genetic Resources Institute (IPGRI) 420
  - intraspecific breeding lines 73
  - intrinsic production capacity 330
  - ion channels, alkaloids 104
  - ion pumps 105
  - IPGRI *see* International Plant Genetic Resources Institute
  - 4-ipomeanal 119
  - Ipomoea batatas* 119
  - iridoid glycosides 279
  - iridoids 99–100, 105
  - irinotecan 451
  - irridodial 144
  - isoamyl acetate 64
  - isoenzymes 439
  - isoflavanone 305
  - isoflavone 305

- isoflavonoids 105, 219, 304, 305  
 2-isopentenyladenine 165  
 isopestacin 67, 68  
 isopiperitenol dehydrogenase 212  
*trans*-isopiperitenol 213  
 isopiperitenone 213  
 isoprenoids 296  
 isoquinoline alkaloids 105  
 – engineered medicinal plants 388  
 isothiocyanate sesquiterpene lactones 105  
 isotope labeling 288
- j**  
*Jacaranda caucana* 119  
 jacaranone 119  
 jasmonates 191  
 jasmonic acid 102, 249  
*Jatropha gossypifolia* 119  
 jatrophone 119  
 jelly fish 100  
 jesterone 60  
*Juniperus chinensis* 119, 126
- k**  
 kaempferol 109  
 kakadumycins 63  
*Kalanchoe* 111  
*Kanahia laniflora*, cardiac glycosides 39  
 kava 189  
 kavapyrones 189  
 KB carcinoma 118  
*Kennedia nigricans* 55, 62  
 ketolactam 144  
 khellin 114  
 Kutkin, shoot cultures 173
- l**  
 laccase 138, 140  
 lanosterol 298  
 lapachol 120  
 lariciresinol 138, 139  
 laryngitis 279  
 lavender 469  
 LC-NMR 7  
 LC-SPE-NMR 18  
 L-Dopa 294  
 LeA structure 350  
 lead molecule 118  
 lead structures 98  
 leaves, *Ginkgo biloba* 493  
 lectins 99, 102, 362  
 legislation  
 – Canada 399  
 – copyright 399  
 – Europe 399  
 – trademark 399  
 – United States 399  
*Leishmania* 479  
*Lemma minor* 330  
 lemon basil 380  
 lettuce, pharmaceutical production 327  
 level of infestation 443  
 levopimaradiene synthase 500  
 liatrin 119–120  
*Liatris chapmanii* 119  
 lichen 99  
 light conditions 165  
 lignans 99, 105  
 – production 127  
 lignin biosynthesis 141  
*Lilium album*  
 – lariciresinol 126  
 – 5-methypodophyllotoxin 126  
 – pinoresinol 126  
 – podophyllotoxin 126  
 limonene 210, 213, 473  
 limonene synthase, constitutive expression  
 482  
 limonene-3-hydroxylase, constitutive  
 expression 482  
 linalool 210, 473  
 – synthase 389  
 – synthase gene 376  
 LineUP 13  
*Linum album* 119, 126  
*Linum flavum* 119  
 – hairy root cultures 130  
 – 5-methypodophyllotoxin 126  
 – root cultures 126  
*Linum nodiflorum*  
 – deoxypodophyllotoxin 5-hydroxylase  
 (dop5h) 141  
 – 5-methoxypodophyllotoxin (5-MPT) 141  
 liquiritigenin 216, 305  
*Lithospermum erythrorhizon* 178, 269  
*R-littorine* 248  
 living fossil 494  
 loganic acid methyl transferase 145  
 loganin 144, 291, 461  
*Lolium perenne* 62  
 – A 1207-bp cDNA 138  
 – cDNA library 138  
 – cinnamoyl-CoA reductase 138  
 longifolene 298  
 longifolene synthase 475  
*Lotus corniculatus* 204  
*Lotus japonicus* 207



- low-shear centrifugal impeller bioreactor (CIB) 137
- L-tryptophan 461
- lucidin 3-O- $\beta$ -purimeveroside 455
- lung cancer 281
- lupanine 111
- luteolin 305
- lyalosidic acid 452, 455
- lycopene cyclase 304
- Lycopersicon esculentum* 204, 482
- Lygus* 442
- lymphoma cell line 38C13 336
- lyngbiatoxin 99
- lysosomes 104
- m**
- M. ovatus* 120
- M. roseus* 64
- M. serrata* 120
- M. spicata* x *M. aquatica* 426
- M. truncatula* 219, 223
- macronutrients 173
- Madagascar periwinkle 292
- magnafena 444
- magniffection 329
- Maguireothamnus speciosus* 66
- maintainer 424
- maize 328
- majoram
- Miraz 426
  - Polyverb 426
  - Tetrata 426
- MAKINO 273–274
- Malaleuca alternifolia* 85
- malaria 529
- MALDI-TOF 351, 363
- male sterile line 424
- 3 malonyl CoAs 305
- mannitol 167
- mannosidase II 351, 361
- map-based positional cloning 381
- Mapiia foetida* 119
- Marah omganus* 119
- Marchantia polymorpha* 178
- markers
- *Achillea* 438
  - *Chamomilla recutita* 438
  - environmental 438
  - morphogenetic influences 438
  - *Origanum majorana* 438
- mass selection 428, 428
- mass spectrometry (MS) 10, 14–15
- metaresinol 133, 138, 139
- Material Transfer Agreements (MTAs) 402
- mating systems 433
- *Achillea millefolium* 434
  - *Allium cepa* 434
  - *Allium sativum* 434
  - *Allium schoenoprasum* 434
  - *Althaea officinalis* 434
  - *Anethum graveolens* 434
  - *Angelica archangelica* 434
  - *Anthriscus cerefolium* 434
  - *Apium graveolens* 434
  - *Arnica montana* 434
  - *Artemisia dracunculus* 434
  - *Calendula officinalis* 434
  - *Carum carvi* 434
  - *Coriandrum sativum* 434
  - *Digitalis purpurea* 434
  - *Echinacea purpurea* 434
  - *Foeniculum vulgare* 435
  - *Hypericum perforatum* 435
  - *Hyssopus officinalis* 435
  - *Inula helenium* 435
  - *Lavandula angustifolia* 435
  - *Malva silvestris* 435
  - *Matricaria recutita* 435
  - *Melissa officinalis* 435
  - *Mentha* x *piperita* 435
  - *Ocimum basilicum* 435
  - *Oenothera biennis* 435
  - *Origanum majorana* 435
  - *Origanum vulgare* 436
  - *Petroselinum crispum* 436
  - *Pimpinella anisum* 436
  - *Plantago lanceolata* 436
  - *Rosmarinus officinalis* 436
  - *Salvia officinalis* 436
  - *Satureja hortensis* 436
  - *Silybum marianum* 436
  - *Thymus vulgaris* 436
  - *Valeriana officinalis* 436
- Matlab 23
- maytansine 119–120
- Maytenus buchananii* 119
- mechanically agitated reactor 175
- medicagenic acid 119
- Medicago sativa* 207, 212
- Medicago truncatula* 204, 207, 357, 381
- medicinal plant breeding, trends 445
- medicinal plants 157, 187, 267
- breeding 417–445
- medicines, plant-based 113
- medium conductivity 170
- MeGA promoter system 331
- megegametophyte 165
- meiosis 165

- melanoma 124  
 membrane proteins 107  
*Mentha* 168  
*Mentha arvensis* 75  
*Mentha x piperita* 5, 388  
 menthofuran 213  
 (+)-menthofuran 481  
 (R)-(+)-menthofuran 212  
 menthofuran synthase 388  
 menthol 114, 213, 473  
 menthone 213  
 MEP *see* methyerythritol phosphate  
 meristem culture 164  
 – organ formation 165  
 – vegetation tips 165  
*Merrilliodendron megacarpum* 451  
 messenger RNA 112  
 metabolic engineering 117, 481–482  
 metabolic profiling 382  
 metabolites 18  
 – in plants 102  
 metabolomics 7, 9–26, 382  
 – Arabidopsis metabolome 12  
 – data handling 21–25  
 – metabolic fingerprinting 9  
 – metabolic profiling 9  
 – methods 12  
 MetAlign 13  
 metenolone 274  
 9-methoxycamptothecin 457  
 10-methoxycamptothecin, camptothecin  
   production 454–459  
 9-methoxyellipticine 120  
 5-methoxy podophyllotoxin 119  
 16-methoxytabersonine 291  
 11-methoxyvinorine 291  
 methyl bromide 64  
 methyl jasmonate 517  
*N*-methyl putrescine 248  
 methylalbonoursin 62  
 4-methylaminobutanol 222  
 methylchavicol 216, 476  
 methylcinnamate 476  
 (*S*)-*N*-methylcoclaurine 221  
 methylerythritol phosphate (MEP) pathways  
   472  
 methyleugenol 216, 476  
 methyljasmonate 249  
 3-methyl-2-oxobutanoic acid 61  
*N*-methylputrescine 222  
 4-*O*-methylpyridoxine 494  
*N*-methyl- $\Delta^1$ -pyrrolinium cation 222  
 metildigoxin 179  
 mevalonate pathway (MVA) 296  
 mevalonate-independent pathway 141  
 mevalonic acid (MVA) pathways 472  
 mezerein 119  
 Microarray Gene Expressing Data (MGED)  
   25  
 microbes, world's rainforests 50  
 microbial taxonomy 52  
 microgametophyte 165  
 microheterogeneity 356  
 microleolin 119  
 microorganisms 412  
 – clustered genes 287  
 – plant-associated 49–70  
 microprojectiles 427  
 micropropagation 160, 165, 280  
 – *Andrographis paniculata* 433  
 – *Gentiana* 433  
 – *Hypericum perforatum* 433  
 – *Ocimum basilicum* 433  
 – *Origanum vulgare* 433  
 – *Salvia* 433  
 – *Thymus piperella* 433  
 – *Valeriana officinalis* 433  
 microsatellite-complimentary primers  
   77–78  
 microsatellite markers 74  
 microspores 166  
 microtubules 515  
 – colchicine 104  
 – podophyllotoxin 104  
 – taxol 104  
 – vinblastine 104  
 MICs *see* minimum inhibitory  
   concentrations (MICs)  
 milk 323  
 minimum inhibitory concentrations  
   (MICs) 59  
 mints 469  
*Mirabilis* 73  
*Mirabilis jalapa* 81  
 Miraz 426  
 mist bioreactor 539  
 mitochondrial DNA 79  
 mitochondrion 104  
 mixed lymphocyte reaction 68  
 molds 100  
 molecular biotechnology 97  
 molecular gene transfer 427  
 molephantinin 119  
 Mollusca 100  
 mollusks 101  
 monoamine oxidase 110

- monocrotaline 119
  - monoterpene cyclases/synthases 473
  - monoterpenes 99, 388, 473–474, 473
  - monoterpenoid indole alkaloids 143
    - ajmalicine 290–293
    - cancer chemotherapy 290–293
    - vinblastine 290–293
    - vincristine 290–293
    - yohimbine 290–293
  - Monstera* 63
  - Montezuma speciasissima* 120
  - morality 408
  - moravskij 444
  - Moringa oleifera* 85
  - morphine 114
    - engineered medicinal plants 388
    - morphine biosynthesis 294
    - acetyl-CoA-dependent acetyltransferase 295
    - 6-O-methyltransferase 295
    - NADPH-dependent oxidoreductases 295
    - P450 monooxygenase 295
    - salutaridinol 7-O-acetyltransferase 295
  - morphogenesis 174
  - Mosher method 34
  - MSTFA 12
  - MTA *see* Material Transfer Agreements
  - MU-2 138
  - mugwort 354
  - Multimentha 426
  - multivariate analysis 25
  - munumbicins 55, 62
  - Murashige and Skoog 270
  - murine myeloma cells 323
  - muscarine 100
  - Muscodor* 64
  - Muscodor albus* 63
  - mustard oil 108
  - mutation rate 426
  - cis*-muuroladiene synthase 475
  - MVA *see* mevalonate pathway, *see* mevalonic acid
  - Mycelia Sterilia* 57
  - Mycobacterium* 50
  - Mycocentrospora acerina* 442
  - mycofumigation 64
  - mycoplasmas 53
  - Mycosphaerella anethi* 419, 442–443
  - Mycosphaerella fijiensis* 62
  - mycotoxins 100
  - myosmine 256
  - myrcene 210, 473
  - myrsticin 476
- n**
- N. foetida* 457
  - NADPH:cytochrome P450 reductase (OpCPR) 145
    - *Arabidopsis thaliana* 462
    - *Petroselinum crispum* 462
    - *Pisum sativum* 462
    - *Triticum aestivum* 462
  - NANA *see* N-acetylneuraminic acid
  - $\alpha$ -naphthalene acetic acid 165
  - naringenin 216, 305
  - nasunin 271
  - National Cancer Institute (NCI) 118
  - National Center for Biotechnology Information 204
  - natural drug discovery 379
  - natural product biosynthesis 287–317
  - natural products
    - bioactive 49–70, 57–68
    - ecological roles 378
    - endophytes 56
    - growth regulators 378
    - interactions 378
    - pollinators 378
    - prediction 378
    - protection 378
    - UV irradiation 378
  - NCBI 204
  - N-debenzoylpaclitaxel 518
  - neomenthol 213
  - neriostoxin 100, 105
  - Nerium* 111
  - Nermertini 100
  - nerolidol/linalool synthase 475
  - neurasthenia 276
  - neurotoxins 100
  - new medicines 50
  - new variability, breeding methods 421
  - N-glycans 346
    - humanization 356
  - N-glycosylation 351
  - Nicotiana* 168
  - Nicotiana*
    - ABC 258
    - ATP-binding cassette 258
    - *h6h* gene 258
  - Nicotiana benthamiana* 293, 359
    - $\beta$ -1,2-xylosyltransferase 360
  - Nicotiana glauca* 255
    - *pmt* gene 252
  - Nicotiana tabacum*
    - S-adenosylmethionine synthase 247–250
    - CYP82E4 223
    - cytochrome P450 CYP82E4 223

- interferon 427
  - *N*'-nitrososornicotine 223
  - nicotine 223
  - ornithine decarboxylase 247–250
  - nicotine 105, 109, 222, 237, 248
  - *pmt* antisensing 256
  - *pmt* inverted-repeats 256
  - production 256
  - nicotinic acid 248
  - nicotine *N*-demethylase 223
  - nilidine 119
  - NIRS *see* non-destructive near-infrared spectroscopy
  - nitidine 120
  - N*-methylcocloraurine 294
  - N*-methyltransferase 295
  - NMR tensor methods, solid-state 59
  - NMT *see* 2,3-dihydro-3-hydroxytabersonine-*N*-methyltransferase
  - non-destructive near-infrared spectroscopy (NIRS) 440
  - non-Hodgkin's lymphoma, scFv 336
  - nonmuscodor species 64
  - nonprotein amino acids (NPAA) 101, 105
  - norcocloraurine 294
  - (*S*)-norcocloraurine 221
  - norethisterone 274
  - nicotinic acid 222, 256
  - Nothapodytes foetida* 129, 451
  - NSO 323
  - nuclear genomes 79
  - nuclear magnetic resonance (NMR) 16–18, 30
    - 2D-NMR 18
    - coldprobes 16
    - continuous-flow 32–33
    - COSY 18
    - cryogenically cooled probes 41
    - cryoprobes 16
    - HMBC 18
    - HMQC 18
    - indirect methods 36–41
    - *Nicotiana tabacum* 17
    - NOESY 32
    - sensitivity 16
    - stopped-flow 33–35
    - WET pulse 32
  - nucleases 75
  - nutrient mist bioreactor 538
- o**
- O. kuroiwai* 453, 454, 457
  - O. liukuensis* 454, 457
  - O. maculata* 120
  - O. moorei* 120
  - O. pumila* 145, 453, 457
    - Amamioshima 453
    - callus cultures 453
    - hairy roots 459
  - Ochrosia elliptica* 120
  - ocimene 106
  - (*E*)- $\beta$ -ocimene synthase 213
  - (*E*)- $\beta$ -ocimene 473
  - Ocimum basilicum* 380, 430, 477
  - octopus 100
  - Oenothera lamarckiana* 437
  - oilseeds, production of vaccines 329
  - Olibrus aenes* 442
  - oligosaccharides 352
  - olive oil
    - flavonoids 39
    - lignans 39
    - phenols 39
  - Olipidium* 442
  - oocydin A 54
  - OpCR *see* NADPH:cytochrome P450 Reductase
  - Ophiorrhiza*
    - *Agrobacterium rhizogenes* 15834 454
    - aseptically plants 453
    - hairy roots 454
    - tissue cultures 452
  - Ophiorrhiza liukuensis* 453
  - Ophiorrhiza mungos* 451
  - Ophiorrhiza pumila*
    - camptothecin 130
    - (3*R*)-deoxypumilosides 130
    - hairy roots 130
    - (3*S*)-pumiloside 130
    - strictosamide 130
  - Ophiorrhiza* s. p. 451–466
  - Ophiorrhiza* species 452
  - opium 388
  - opium poppy 75
  - OpSTR *see* strictosidine synthase
  - OpTDC *see* Tryptophan Decarboxylase
  - Orchidaceae, Dendrobium* 273
  - orchids 161
  - organellar genomes 79
  - organogenesis 160, 164
  - osmotics 169
  - Osteichthyes 100
  - ouabain 111
  - ownership of life 400
  - oxygen transfer 536

**p**

- P. falciparum* 529  
*P. hexandrum*, callus 126  
*P. microspora* 59, 67  
*P. peltatum* 120  
*P. somniferum*  
 – S-adenosyl-L-methioninine(R,S)-3'-hydroxy-N-methylcoclaurine 4-OMT (4'OMT) 220  
 – O-methyltransferase 220  
*P*<sub>388</sub> lymphocytic leukemia 118  
 PaCE 208  
 paclitaxel 5, 98, 105, 110, 117, 120, 124, 190, 269–270, 298, 299, 515–528, 518  
 – biosynthesis 141, 142  
 – plant cell culture 516–517  
 – *see also* taxol  
 paclitaxel biosynthetic enzymes  
 – baccatin III formation 519  
 – C-13 side-chain formation 519  
 – 1-deoxy-D-xylulose-5-phosphate reductoisomerase 519  
 – geranylgeranyl diphosphate synthase 519  
 – GGDP formation 519  
 – 14 $\beta$ -hydroxytaxoid formation 519  
 – non-mevalonate pathway 519  
 – phenylalanine aminomutase 519  
 – taxadiene synthase 519  
 – taxane-ring formation 519  
 – taxoid 10 $\beta$ -hydroxylase 519  
 – taxoid 10-O-acetyltransferase 519  
 – taxoid 13 $\alpha$ -hydroxylase 519  
 – taxoid 13-O-sidechain transferase 519  
 – taxoid 14 $\beta$ -hydroxylase 519  
 – taxoid 2 $\alpha$ -hydroxylase 519  
 – taxoid 2-O-benzoyltransferase 519  
 – taxoid 2'-hydroxylase 519  
 – taxoid 3'-N-benzoyltransferase 519  
 – taxoid 5 $\alpha$ -hydroxylase 519  
 – taxoid 5-O-acetyltransferase 519  
 – taxoid 7 $\beta$ -hydroxylase 519  
 paclitaxel biosynthetic pathway  
 – baccatin III 517–522  
 – esterification 517–522  
 – taxadiene synthase 517–522  
 paclobutrazol 273  
 pahutoxin 100  
 PAL 139  
 palmatine 221  
 palytoxin 105  
*Panax ginseng* 189, 214, 269  
 – ESTs 214  
 – oxidosqualine cyclase 214  
*Panax ginseng* C. A. Mey 73  
*Panax notoginseng* 192  
*Panax* species 81  
*Papaver somniferum* 5, 75, 178, 190, 257, 295, 388  
 papaverine 114  
 paralytic shellfish 99  
 parasitism 334  
*Parquetina nigrescens* 120  
 Partec-Ploidy analyzer 432  
 particle bombardment 255  
 particle gun 385  
 patent  
 – terpenoid indole alkaloids 292  
 – transgenic yeast 292  
 patentability 405  
 pathogen defense 133  
 pathway discovery 288, 289  
 pathway engineering 5–6  
 pathway mapping 117  
 pectinase 426  
 PEG *see* polyethylene glycol  
*Pelargonium* 477  
 $\beta$ -peltatin-A methylether 7-hydroxylase 140  
*Penicillium*, toxins 100  
*Penicillium minioluteum* 134  
*Penicillium* sp. 136  
*Penstemon deustus* 120  
 penstimide 120  
 pentagalloylglucose 109  
 pepper 190  
 peppermint 388  
 – transgenic 388  
 peptides 99–100  
 perfusion operation 176  
*Periconia* 66  
*Perilla frutescens* 190  
*Periplaneta americana* 480  
*Periploca* 111  
 permeation, dimethylsulfoxide 180  
 peroxidation 134  
 pestacin 67  
 pestalotiopsins A and B 59  
*Pestalotiopsis* 56, 65  
*Pestalotiopsis guepini* 66  
*Pestalotiopsis jesteri* 60  
*Pestalotiopsis microspora* 60, 66–67, 68  
 pests 418  
*Petroselinum crispum*, NADPH:cytochrome P450 Reductase (OpCPR) 462  
*Pezicula cinnamomea* 58  
 phallotoxins 100  
 pharmacogenesis 379  
 pharmacophor 113  
 phenolics 18

- phenotype 9
- phenotype diversity 382, 428
- phenylalanine 305
- phenylalanine aminomutase 300
- phenylalanine ammonia lyase (PAL) 140
- L-phenylalanine ammonia-lyase 476
- phenylisoserine 142, 518
- 2-oxo-3-phenylpropanoic acid 61
- phenylpropanoids 99, 215, 475–477
- phenylpropenes, formation 472
- PhEur, Producta ab ADN recombinante 427
- phloem 101
- phloretin glycosides 36
- phloroglucinols 99
- Phoma exigua* 442
- phomopsichalasin 60
- Phomopsis* 60
- Phomopsis diachenii* 442
- phorbol derivatives 119
- phorbol esters 105
- phospholipase 100
- photoperiodic reactions 437
- Phyllanthus acuminatus* 120
- Phyllanthus urinaria* 39
- phyllanthoside 120
- phyllocladene 106
- Physalis minima* 427
- physcion 271
- Phycomitrella patens* 205, 330, 333, 350–351, 356–357
- gene knock-out 360
- physical stress 193
- physostigmine 111, 114
- phytoalexins 238
- phytoestrogens 379
- phytohormones 169
- Phytolacca* 73
- Phytolacca acinosa* 81
- Phytolacca dodecandra* 85
- Phytophthora* 54, 66
- Phytophthora megasperma* 133
- Phytophthora megasperma* f. sp. *glycinea* 242
- Phytoseiulus persimilis* 214
- phytotherapy 4
- Picea glauca*
- laccases 218
- transcriptomics 218
- Pichia pastoris* 138
- Pierredendron kerstingii* 120
- pilocarpine 114
- pinene 473
- $\alpha$ -pinene 210
- $\beta$ -pinene 210
- pinoresinol 133, 138, 139
- pinoresinol synthase 140
- pinoresinol-lariciresinol reductase 140
- Pinus taeda*, ESTs 217
- Piper futokadzura* 120
- Piper methysticum* 4
- Pisum sativum*, NADPH:cytochrome P450 Reductase (OpCPR) 462
- Plackett-Burman design 131
- plant biotechnology
- economic returns 399
- financial investment 399
- intellectual property 399–414
- plant breeding 417, 418
- haploid technology 165
- plant cell cultures, Bristol-Myers Squibb (BMS) 524
- plant cultivars 83
- plant DNA, isolation 74–81
- plant glycoengineering 356
- plant model organisms
- *A. thaliana* 289
- *Medicago trunculata* 289
- *Oryza sativa* 289
- *Zea mays* 289
- plant regeneration 160, 272
- plant selection, rationale 53–55
- plant systematics 86–87
- plant tissues
- genetic instability 177
- micropropagation 177
- mutagenic treatment 177
- preservation 177
- somaclonal variation 177
- plant varieties 405
- definition 407
- protection 402
- plant variety 404
- Plantago lanceolata*, photoperiodic reactions 437
- plant-associated pseudomonad 62
- plant-based inventions
- North America 409
- Supreme Court 409
- US plant patent 409
- plant-derived antibodies
- Avicidin 336
- Clinical Trials 336
- EpCAM 336
- IgG 336
- PlantGDB 205
- plants
- climatic growth factors 187
- DNA fingerprints 376
- genotype identification 376

- herbivory 187
- molecular markers 376
- patents 399
- pathogen attack 187
- pedigree analysis 376
- phenotypic selection 376
- product accumulation 171
- secondary metabolites 171
- soil conditions 187
- Plasmodium* 389, 479
- Plasmodium falciparum* 63
- plasmon mutations 426
- plastidome mutations 426
- ploidy level 431
- plumbagin 108
- PMT protein 253
- pneumocandins 58
- Poaceae* 206
- podolide 120
- podophyllotoxin 6, 98, 105, 111, 114, 117, 119–120, 121, 124, 139, 269
  - biosynthesis 138
  - *Forsythia intermedia* 138
  - *Linum album* 138
  - *Linum flavum* 138
  - *Podophyllum peltatum* 138
- Podophyllum hexandrum* 120
  - cell cultures 131
  - cell suspension 126
  - continuous cultivation 137
  - fed-batch 137
  - submerged batch 137
- Podophyllum peltatum* 269
  - callus 129
  - cell cultures 131
  - embryogenic roots 129
  - tissue cultures 126
- Podophyllum* 4
- Podtjatpus gracilori* 120
- polketides 99
- pollen 165
- pollen transfer 430
- pollination 424
- polyacetylenes 99
- polyethylene glycol (PEG) 218, 426
  - PEG-induced fusion 168
- Polygonum multiflorum* 270, 276, 277
- polymorphisms 79
- polypeptide 322
- polyphenols 105–106
- polyploidy 360
- polysterene 180
- polyverb 426
- Populus trichocarpa* 204
- Porifera* 100
- posttranslational modification 332
- potatoes 328
- pratensin 216
- precursors
  - labeled metabolites 138
  - radiolabeled 138
  - stable-isotope labeled 138
- predators 102
- prednisolone 274
- preservatives 469
- presynapse 110
- primary alcohol dehydrogenase 145
- primrose seeds, NIRS 441
- principal component analysis (PCA) 22
- proanthocyanidins 304, 305
- procanidin B4 109
- prodrugs 102–103
- product isolation 57
- Producta ab ADN recombinante 427
- production by microorganisms
  - artemisinin 535–539
  - *Escherichia coli* 535
  - *Saccharomyces cerevisiae* 535
- progeny testing 429, 430
- proglycan nomenclature 347
- in-vitro* propagation 81, 164
- protease inhibitors 102
- Protecta One 480
- Protecta Two 480
- protein A affinity chromatography 337
- protein G affinity chromatography 337
- protein kinase C 110
- proteins 107
  - aldehydes 104
  - enzymes 104
  - epoxides 104
  - isothiocyanates 104
  - polyphenols 104
  - SH reagent 104
  - structural 104
  - terpenoids 104
  - transporter 104
- proteomics 9, 117, 382
- protoanemonine 105
- protocorm formation 161
- protoplast technology 167
- protoplasts
  - enzymatic digestion 167
  - feeder cells 168
  - patch-clamp 167
  - protocols 167

- Prunus africana* 86  
 pseudobaptigenin 216  
 pseudoguaianolide 119  
*Pseudomonas* 61  
*Pseudomonas viridiflava* 61  
 pseudomycins 62  
 pseudotropine 248  
*Psila rosae* 442  
 psilobyn 100  
 psilocine 100  
 psoralen 112  
 ptaquiloside 112  
*Puccinia* 442  
*Puccinia menthae* 426  
 puffer fish 101  
 pulegone 213  
 pulegone reductase 212, 481  
 pumiloside 455, 457, 461  
 putrescine 222  
 Putrescine *N*-methyltransferase 252–253  
*Putterlickia verrucosa* 120  
*Pyricularia oryzae* 59  
 pyrrolizidine alkaloids 100, 105, 112  
 pythiaceous fungi 63  
*Pythium* 54, 66, 442
- q**
- quercetin 36  
 quinidine 114  
 quinine 105, 112, 387  
 quinoid diterpenes 278  
 quinoline alkaloids 143  
 quinolizidine alkaloids 100  
 quinones 105
- r**
- rainforests, biodiversity 55  
 random amplified polymorphic (RAPD) DNA  
 439, 439  
*Ranunculaceae* 111  
 ranunculin 103  
 RAPD *see* random amplified polymorphic  
 DNA, 77  
 rationale, plant selection 53–55  
*Rauwolfia*, CYP450s 293  
*Rauwolfia serpentina* 292, 387, 427  
 receptors 104  
 recombinant antibodies 329  
 recombinant DNA technology 288  
 recombinant proteins 345  
 recurrent hybridization 431  
 recurrent selection 429, 429  
 regulation
- APHIS 338  
 – Directive 2001/20/EC 338  
 – GMP-compliance 338  
 – manufacture of medicinal products 338  
 – Plant-Based Production 338  
 regulatory proteins 107  
 – aldehydes 104  
 – epoxides 104  
 – isothiocyanates 104  
 – polyphenols 104  
 – quinones 104  
 – SH reagent 104  
 repeated fed-batch operation 176  
*Reptilia* 101  
 reserpine 114  
 resins 209  
 restriction fragment length polymorphism  
 (RFLP) 74  
 restriction fragment length polymorphism  
 (RFLP) markers 439  
 resveratrol 308, 380  
 (R)-reticuline 294  
 (S)-reticuline 221, 294  
 RFLP *see* restriction fragment length  
 polymorphism  
 rheumatism 272  
*Rhinocladiaella* 67  
 RhinoRX  
 – herpes simplex virus 2 (HSV-2) 337  
 – respiratory infections 337  
*Rhizoctonia* 442  
*Rhizoma corydalis* 272  
*Rhyncholacis penicillata* 54  
 ribosomes  
 – chloramphenicol 104  
 – cycloheximide 104  
 – emetine 104  
 – erythromycin 104  
 – protein biosynthesis 104  
 – streptomycin 104  
 – tetracycline 104  
 rice 328, 381  
 – genome 204  
 rickettsia 53  
 rishitin 238  
 root culture, *Agrobacterium rhizogenes* 171  
 root matrix 536  
*Rosa damascena* 477  
 rosmarinic acid 109, 269  
 rotating drum reactor 175  
*Rubia peregrina* 196  
 ryegrass 138



- s**  
*S. cerevisiae*  
 – 10 $\beta$  301  
 – acetyl-transferases 301  
 – amorph-4,11-diene synthase 301  
 – 5-O-benzoyl transferase 301  
 – 13 $\alpha$ -hydroxylase 301  
 – mevalonate pathway 301  
 – taxa-4(20), 11(12)-dien-5A-acetoxy-10 $\beta$ -ol  
 301  
 – taxadiene 5 $\alpha$  301  
 – taxadiene synthase 301  
 – WAT11 300  
*S. frugiperda* Sf9  
 – codeinone reductase 295  
 – salutaridinol 7-O-acetyltransferase 295  
*Saccharomyces cerevisiae* 138  
 – strictosidine glucosidase 293  
 – strictosidine synthase 293  
 – vindoline pathway 293  
 safrole 108, 112  
 salamanders 101  
 salicin 103  
 salicylic acid 111  
*Salmonella gallinarum* 60  
 salutaridine 294  
 salutaridinol 294  
*Salvia callus* 279  
*Salvia miltiorrhiza* 193, 270  
 – callus cultures 278–279  
 salicylic acid 102  
 SAM: $\beta$ -peltatin 6-O-methyltransferase 140  
 SAMPL (selective amplification of  
 polymorphic microsatellite loci) 80  
 sanguinarine 112  
 saponins 99, 105–106, 214  
 sarsaparilloside 106  
 saxitoxin 99–100, 105  
 SCAR markers 88  
 scFv, non-Hodgkin's lymphoma 336  
 Schmeiser 413  
*Sclerotinia sclerotiorum* 58  
 scolopender 100  
 scopolamine 114, 181, 196, 237, 246, 256  
 – accumulation 241  
 – engineered medicinal plants 388  
 (S)-scopolamine 237, 248  
 scopoletin 39  
*Scorpiones* 100  
 scorpions 100  
 scoulerine 294, 295  
 (S)-scoulerine 221  
*Scrophularia yoshimurae* 270  
 – production 279–280  
 – *in-vitro* propagation 279  
*Scrophulariaceae* 111  
 sea cucumber 100  
 sea urchin 100  
 secoisolariciresinol dehydrogenase 140  
 – *Forsythia intermedia* 141  
 secoisolariciresinol 139  
 secologanin 144, 291, 292, 461  
 secologanin synthase 145  
 secondary metabolites 52, 98, 105, 187, 267  
 secondary pathways 6  
 secretory cells 212  
 secretory component 322  
 secretory pathway 331  
 seed germination 161  
*Seimatoantlerium nepalense* 66  
*Seimatoantlerium tepuiense* 66  
*Selaginella moellendorffii* 205  
*Selaginella pallescens* 60  
 selection intensity 433, 437  
 selection response 433  
 self-fertilization 335  
 self-fertilizing crops 429  
 self-pollination 433  
 selinene synthase 475  
*Septoria* 442  
*Serratia marcescens* 54  
 sesquiterpenes 99–100, 297–299, 389, 474  
 – caryophyllene 59  
 sesquithujene 210  
 sexual hybridization 375  
 sexual hybrids 160  
 SH groups 108  
 shear stress 536  
 Shen-Nung-Ben-Cao-Jing 273  
 shikimic acid 139  
 shoot cultures 173, 539  
 – medicinal plants 173  
 – secondary metabolites 173  
 sialylation 348  
 sialyltransferase 332  
 Siberian ginseng 75  
 signal compounds 102–103  
 signal peptide, KDEL signal 331  
 silver nitrate 135  
*Simarouba glauca* 120  
 SIMCA-P 23  
*Sinapis alba*, photoperiodic reactions 437  
 sinapoyl-glucosyltransferase 217  
 sinapyl alcohol 216  
 sinapyl aldehyde 216  
 single nucleotide polymorphisms (SNPs) 80  
 single-solvent extraction 21  
*Smirnovia iranica*, isoflavonoids 39

- snakes 101  
snakevine 55  
snapdragon 213  
soaps 469  
solamine, glycoalkaloids 242  
*Solanaceae* 237, 238  
– overexpression 255–259  
– transformation 255–259  
solanidine 238  
*Solanum* 168  
– glycoalkaloids 243  
*Solanum aviculare* 190  
*Solanum melongena* 270  
– anthocyanins 280–281  
– callus cultures 280–281  
– somaclonal variation 280  
solid tumors 281  
solid-phase extraction 36  
solid-phase microextraction (SPME) 440  
solid-state NMR tensor methods 59  
somaclonal variation 81, 426  
somaclones 177  
somatic embryogenesis 166, 174, 272  
somatic embryos, secondary plant  
metabolites 166  
somatic hybridization 167, 426  
– electrofusion 168  
sorbitol 167  
*Sorghum bicolor* 205  
soroksari 444  
SP2/0 323  
spectrophotometric color assessment 441  
spermidine synthase 253  
spiders 100  
spinach, pharmaceutical production 327  
SPME *see* solid-phase microextraction  
*Spondias mombin* 61  
sponges 100  
*Sporormia minima* 66  
SPSS 23  
St. John's wort, flow cytometry 431  
stable transformation systems  
– *Allium sativum* 386  
– *Artemisia annua* 386  
– *Bacopa monniera* 386  
– *Cannabis sativa* 386  
– *Digitalis minor* 386  
– *Drosera rotundifolia* 386  
– *Echinacea purpurea* 386  
– *Eleutherococcus sessiliflorus* 386  
– *Eschscholzia californica* 386  
– *Hyoscyamus niger* 386  
– *Lycium barbarum* 386  
– *Panax quinquefolius* 386  
– *Papaver somniferum* 386  
– *Passiflora edulis* f. *flavicarpa* 386  
– *Raphanus sativus* 386  
– *Rehmannia glutinosa* 386  
– *Ruta graveolens* 386  
– *Scrophularia buergeriana* Miq. 386  
– *Thalictrum flavum* ssp. *glaucum* 386  
standardized extract, EGb 761® 495  
*Staphylococcus* 50  
*Staphylococcus aureus* 60, 304  
starfish 100  
*Steganotaenia araliaceae* 120  
*Stereospermum suaveolens* 120  
sterilization 176  
steroids 99  
Steviosides, shoot cultures 173  
stilbenes 304  
stingray 100  
stirred-tank bioreactor 175  
stirred-tank reactors 137  
*Streptococcus* 50  
*Streptococcus mutans* 336  
*Streptomyces* 62  
*Streptomyces* NRRL 30562 55, 62  
*Streptomyces* sp. 136  
*Streptomyces*  
– ammonia lyase enzymes 307  
– engineered flavonoid pathway 307  
– naringenin 307  
– pinocembrin 307  
*Strichnos nux vomica* 387  
strictosamide 145, 455, 457, 461  
strictosidine 144, 291, 461  
strictosidine synthase 292  
strictosidine synthase (OpSTR) 461  
strictosidine synthase (STR) 143, 145, 387  
strictosidinic acid 455, 457  
strophantidin 120  
*Strophantus* 111  
*Strophantus* sp. 120  
strychnine 387  
*Strychnos* 20  
subglutinols 68  
sugar beet, production of vaccines 329  
sugarcane, production of vaccines 329  
sulfadoxinepyrimethamine 529  
suspension  
– *Callitris drummondii* 127  
– culture time 127  
– *Linum album* 127  
– *Linum flavum* 127  
– *Linum nodiflorum* 127  
– *Podophyllum hexandrum* 127  
suspension cell cultures 330

- sweet marjoram 439  
 sweet potato, production of vaccines 329  
 sweroside, 2D WETCOSY 34  
*Swertia calycina* 35  
 swertiamarin 33, 270, 271, 275–276  
 synaptic vesicles 110  
 synthetic cultivars 425  
 syphilis 281
- t**
- T. andreanae* 56  
*T. baccata* 516  
*T. brevifolia* 120, 125, 516  
*T. canadensis*, elicitation with methyl 128  
*T. cerbiflora* 120  
*T. chinensis* 516  
 – jasmonate 128  
 – reactor 128  
 – silver nitrate elicitation 128  
 – sucrose feeding 128  
*T. cuspidata* 132, 516  
 – reactor 128  
 – Taxuyunnanine C 134  
*T. media*  
 – elicitation with methyl 128  
 – reactor 128  
*T. minus* 120  
*T. wallachiana*  
 – baccatin 133  
 – 10-deacetyl baccatin 133  
 – paclitaxel 133  
*T. wallichiana* 516  
*T. wilfordii* 68  
 T16-OMT *see* 16-hydroxytabersonine-O-methyltransferase  
 tabersonine 291  
 Taiwan 267  
 – biodiversity 269  
 – botanical garden 269  
 tannins 99, 105  
 tanshinones 278  
 taxa-4(5) 141, 142  
 taxa-4(5),11(12)-diene 300, 518, 521  
 taxa-4(20),11(12)-dien-5 $\alpha$ -o-acetyl transferase 143  
 taxa-4-(20),11-diene-5 $\alpha$ ,13 $\alpha$ -diol 298  
 taxa-4-(20),11-diene-5 $\alpha$ -ol 298  
 taxa-4-(20),11-diene-5 $\alpha$ -yl acetate 298  
 taxa-4,11-diene 298  
 taxadien-5 $\alpha$ -ol-O-acetyltransferase 141  
 taxadiene 299, 518  
 taxadiene synthase 143  
 taxanes 141  
 taxodione 120  
*Taxodium distichum* 120  
 taxol 65, 66, 110, 131, 214, 271, 281, 299–301, 515  
 – bioreactor 137  
 – radiolabeled 133  
 – *see also* paclitaxel  
 taxol biosynthesis 298  
 – benzoylation 142  
 – epoxidation 142  
*Taxomyces andreanae* 55, 65  
*Taxus* 4, 269  
 – agrobacterium 130  
 – cytochrome P450 taxoid hydroxylases 214  
*Taxus baccata* 110, 120, 124  
 – airlift bioreactor 137  
 – suspension cultures 137  
*Taxus brevifolia* 55, 59, 65, 87, 110, 124, 281  
*Taxus canadensis* 178, 300  
 taxus cells 523  
 – genetic modification 522  
*Taxus cuspidata* 190  
*Taxus mairei* 66, 270  
*Taxus wallichiana* 66, 75  
 taxuyunnanine C 134, 505  
 TbGGPS1 519, 520  
 TbGGPS2 519, 520  
 TcGGPS 520  
*Tectus* species 100  
 telomeric repeats 68  
 teniposode 124  
 (S)-terahydrocolumbamine 221  
*Terminalia morobensis* 67  
 terpene content  
 – age 497  
 – bilobalide 497  
 – gender 497  
 – natural variability 497  
 – soil 497  
 – stage of development 497  
 terpene synthase 209  
 – (E)- $\beta$ -farnesene 211  
 – (E, E)-farnesol 211  
 – (E)-nerolidol 211  
 – *tps4* 211  
 – *tps5* 211  
 terpene synthase 1 474  
 terpene synthase OsCPS<sub>ent</sub>  
 – gibberellin biosynthesis 211  
 – isoforms 211  
 terpenes, formation 472  
 terpenoid indole alkaloids, engineered medicinal plants 387  
 terpenoid pathway 388–390  
 – cannabinoids 390

- monoterpenes 388
- sesquiterpenes 389
- terpenoid synthase, *A. thaliana* 299
- terpenoids 6, 100, 209, 471–475
- tetanus toxin 331
- tetradhydroberberine 294
- tetradhydrocolumbamine 294
- 3',4',3,4-tetradhydrolycopene 304
- tetrahydrocannabinol 85
- tetrahydrocannabinolic acid (THCA) 390
- tetrahydropalmatine 269
  - analysis 272–273
  - production 272–273
- tetrandrine 119
- Tetranuchus urticae* 214
- Tetraphylla vomitoria* 292
- Tetrata* 426
- tetraterpens 99
- thalicarpine 120
- Thalictrum dasycarpum* 120
- Thalictrum regosum* 191
- THCA *see* tetrahydrocannabinolic acid
- The International Seed Treaty 403
- thebaine 294
  - engineered medicinal plants 388
- theophylline 114
- therapeutic antibodies 319–338
- Thevetia* 111
- thidiazuron 165
- thin-layer chromatography (TLC) 11
  - HPTLC 14
- thyme, flowers 424
- thyme accessions 421
- thymocyte proliferation (TP) assay 68
- thymol 114, 473
- Thymus vulgaris* 432
- Thymus vulgaris* L. 83
- tissue cultures 268
  - *O. kuroiawai* 453
  - *O. pumila* 453
  - *Ophiorrhiza liukuensis* 453
- toads 101
- tobacco 257
  - pharmaceutical production 327
  - *pmt* gene 252
- tobacco *pmt* 252
- tobacco BBE 223
- tobacco mosaic virus (TMV) 23
  - *Nicotiana tabacum* 24
- tomatidine 238
- tomatine, glycoalkaloids 242
- $\alpha$ -tomatine 238
- tomato* 328
- tonsillitis 279
- topoisomerase I 124
- topotecan 451
- Torreya taxifolia* 59, 67
- torreyanic acid 67
- totipotency 167
- $\alpha$ -toxin 100
- $\beta$ -toxin 100
- $\gamma$ -toxin 100
- tracer study, [ $1\text{-}^{13}\text{C}$ ]glucose 462
- Trade-Related aspects of Intellectual Property Rights (TRIPS) 401, 403
- traditional Chinese medicine 273
- traditional healthcare industry 267
- Trametes sanguinea*, kc1 cDNA 138
- transcriptome
  - cDNA chips 382
  - microarrays 382
- transcriptomics 25
- transformation 383
- transgenic medicinal plants 375–391
  - generation 385–386
  - transformation systems 385
- transgenic *O. pumila* plants from hairy roots 460
- transgenic peppermint 481
- transgenic plants 157
  - biosafety 325
  - human food chain 325
  - pharmaceutical factories 325
  - pollution 325
- transgenic tobacco plants 326
- transient expression analysis 384
- transient GlcNAc 351
- transporters, alkaloids 104
- transposons 80
- Treaty on Plant Genetic Resources for Food and Agriculture 403
- trichome 212
- Trichophyton* 58
- Trichothecium* 66
- tripdiolode 120
- TRIPS *see* trade-related aspects of intellectual property rights
- Tripterygium wilfordii* 58, 67, 120
- triterpenes 99
- triticale cultivars 162
- Triticum aestivum* 205
  - NADPH:cytochrome P450 Reductase (OpCPR) 462
- trolox 68
- tropane alkaloids, engineered medicinal plants 388
- tropinone 248
- tropinone reductases 253–254, 256

- *H. niger* 253
  - purification 253
  - Trypanosoma* 479
  - tryptamine 291, 461
  - tryptophan decarboxylase (OpTDC), southern blot analysis 462
  - tryptophane decarboxylase (TDC) 145
  - Tubercularia* 66
  - Turbo* species 100
  - turpentine 209
  - two-stage freezing, cryopreservation 170
  - tylocrebine 120
  - Tylophora asthmatica* 120
  - tylophorine 120
  - tyrosine 294
  - tyrosine kinase 110
- u**
- ubiquitin-1 330
  - ulcers 272
  - ultra-high pressure 180
  - ultra-high-throughput screening (UHTS) 98
  - ultrasonication 180
  - unigene 204
  - Union International pour la Protection des Obtentions Végétales (UPOV) Convention 401, 403
  - unscrambler 23
  - UPOV *see* Union International pour la Protection des Obtentions Végétales
  - Urginea* 111
  - utility patents 400, 410–413
    - Canada 411
    - Canadian Patent Act 411
    - Chakrabarty 410
    - Court of Appeal of Canada 411
    - Harvard 411
    - US Supreme court 410
    - USA 410
  - UV-protectants 103
- v**
- V. hymenolepis* 120
  - V. officinalis* 85
  - vaccines 329
  - vacuole 101
  - valencene synthase 475
  - valerian roots 418
  - Valeriana wallrothii* 85
  - vanadate 193
  - variability 85
  - variety Mitcham 426
  - vector-mediated gene transfer 427
  - Vedas 29
  - vegetative propagation 433
  - vermolepin 120
  - vernalization 433
  - Vernonai guineensis* 120
  - Vernonia fastigiata* 33
  - Verticillium dahliae* 134, 191
  - VH *see* vomilenine hydroxylase
  - Vibrio cholera* 64
  - vinblastine 6, 98, 105, 111, 119, 291, 292, 387
    - shoot cultures 173
  - Vinca minor* 427
  - Vinca*-alkaloids 6
  - vincristine 6, 387
  - vindoline 291, 292
    - shoot cultures 173
  - vinorine 291, 293
  - virotaxin 100
  - virus elimination 160
  - viruses 442
  - virus-infected plants* 329
  - vitamin A 302
  - vitamins 159
  - vitrification, two-stage freezing 170
  - volatile antibiotics 63–64
  - vomilenine 291
  - vomilenine hydroxylase (VH) 293
- w**
- waxes 99
  - whole-genome sequences 204
  - Wilson-type bioreactors 137
  - withaferin 120
  - withaferin A 119
  - Withania somnifera* 120
  - Withanolides, shoot cultures 173
  - Wollemia nobilis* 66
  - World Trade Organisation (WTO) 401
  - World Wide Web 204
  - world's rainforests, microbes 50
  - wormwood 389
  - wound callus 162
  - WTO *see* World Trade Organisation
- x**
- XAD-4 135
  - xenobiotics 178
  - Xylaria* 56
  - xylariaceae fungus 63
  - xylem 101
  - xylosyltransferase 359
  - $\beta$ 1,2-xylosyltransferase 350
  - Xysmalobium* 111

**Y**

yan-hu-suo 272  
Ye-Jiao 276  
yew trees 516  
yohimbine 114

**Z**

zaluzonic 120  
*Zanthoxylum* sp. 120  
*Zaulzainia* sp. 120  
*Zingiber officinale* 75  
 $\alpha$ -zingiberene synthase 475  
Zloty lan 426

## Book Description

**Modern Biopharmaceuticals: Design, Development and Optimization.** Dedicated to Francis Crick (1916–2004), edited by Jörg Knäblein. Wiley-VCH Verlag GmbH & Co. KGaA: Weinheim, Germany, 2005. ISBN 3-527-31184-X.

In 1982, the first biopharmaceutical product, “humulin,” recombinant human insulin, produced in *Escherichia coli* was approved for use in the United States, marking the beginning of the biopharmaceutical industry. Since then the biopharmaceutical market has burgeoned at an accelerating rate. *Modern Biopharmaceuticals* is a four-volume work intended to introduce readers to a comprehensive set of recently developed technologies, which shows the paradigm shifts in the health care system and reflects these changes in industrial research.

*Modern Biopharmaceuticals* is a truly international venture. The 186 contributors are scientists and business leaders from academic, industrial, and governmental laboratories working in 17 countries. Knäblein’s work may be unprecedented in having such an impressive group of individuals contribute to one biotechnology book: e.g. Nobel laureates Robert Huber (1988), Thomas R. Cech (1989), and Manfred Eigen (1967) are represented. Extraordinary contributors like the world’s top scientists from internationally prestigious academic institutions such as the California Institute of Technology, Cambridge University, Charité Campus Benjamin Franklin, the Eidgenössische Technische Hochschule (ETH), Fraunhofer Institute for Molecular Biology and Applied Ecology, Harvard University, Imperial College London, Johns Hopkins, Karolinska Institutet, Kyoto University, Max-Planck-Institut für Biochemie, Massachusetts Institute of Technology, National Cancer Institute, National Institutes of Health, Oxford University, Princeton University, Scripps Institute, Seoul National University, Stanford University, the Technion, the Weizmann Institute of Science, and Yale University, as well as business leaders from biotechnology companies, and the U.S Food and Drug Administration (FDA) are included.

*Modern Biopharmaceuticals* is an impressive accumulation of outstanding results presented by brilliant, privileged and creative thinkers who shape the biotechnology of our future. It reads like “The Guinness Book of Biotechnology” in which the who is who of biotechnology experts divulge their first hand experience. Because of this fantastic line up of world class experts from major biotech companies and fa-

mous research institutes *Modern Biopharmaceuticals*, has earned impressive critiques from several Nobel Prize laureates already – e.g. from James D. Watson:

“*The making of pharmaceutical and diagnostic agents in cells has moved from edge to the center of their respective commercial development. With ‘Modern Biopharmaceuticals’, Jörg presents an outstanding collection of articles from groundbreaking scientists, comprehensively describing the many novel ways cells so are being deployed toward human good.*”

Due to its success, *Modern Biopharmaceuticals* is expected to see further, even more comprehensive editions. Additional topics, content, and current trends can already now be reviewed at the biotechnology hub <http://www.get-gps.net> and discussed with the Global Pharma Specialists from Knäblein’s world-wide network.

Jörg Knäblein, Head of Microbiological Chemistry at Schering AG, Berlin, Germany and Scientific Advisor, Executive Board Member, and President of the European Association of Pharmaceutical Biotechnology, studied biotechnology/chemical engineering at the Gesellschaft für Biotechnologische Forschung (GBF). After some industrial experience as biotechnologist in Alzheimer’s research at Hoechst UK (London), he decided to also study biochemistry. He did his diploma in Biochemistry at the Max-Planck-Institute für Biochemie at Martinsried/Munich, and afterwards worked as Biochemist at Hoechst in Somerville, New Jersey, USA. After coming back to Munich, he received his PhD degree from Max-Planck-Institute für Biochemie, where he worked in the group of 1988 Nobel chemistry laureate Robert Huber, who wrote one of the two forewords for *Modern Biopharmaceuticals*. Together with Professor Huber, Jörg founded his own biotechnology company and worked for a consulting firm focusing on the Life Science business of global players, while also co-founding the PharmaManagement Network. As a recipient of numerous awards and honors, he has chaired and organized several international pharmaceutical conferences and is a member of the editorial board of the *European Journal of Pharmaceutics and Biopharmaceuticals*. He advises international clients, institutions, and governments, lectures extensively around the world, and has authored many journal articles, several books, and holds a number of patents.